

CIVIC

HONDA
The Power of Dreams

**2018 COUPE
OWNER'S MANUAL**

WARNING

California Proposition 65 Warning

Operating, servicing and maintaining a passenger vehicle or off-road vehicle can expose you to chemicals including engine exhaust, carbon monoxide, phthalates, and lead, which are known to the State of California to cause cancer and birth defects or other reproductive harm. To minimize exposure, avoid breathing exhaust, do not idle the engine except as necessary, service your vehicle in a well-ventilated area and wear gloves or wash your hands frequently when servicing your vehicle. For more information go to www.P65Warnings.ca.gov/passenger-vehicle.

Event Data Recorders

This vehicle is equipped with an event data recorder (EDR).

The main purpose of an EDR is to record, in certain crash or near crash-like situations, such as an air bag deployment or hitting a road obstacle, data that will assist in understanding how a vehicle's systems performed. **The EDR is designed to record data related to vehicle dynamics and safety systems for a short period of time, typically 30 seconds or less. The EDR in this vehicle is designed to record such data as:**

- **How various systems in your vehicle were operating;**
- **Whether or not the driver and passenger safety belts were buckled/fastened;**

- **How far (if at all) the driver was depressing the accelerator and/or brake pedal; and,**
- **How fast the vehicle was traveling.**

These data can help provide a better understanding of the circumstances in which crashes and injuries occur. NOTE: EDR data are recorded by your vehicle only if a non-trivial crash situation occurs; no data are recorded by the EDR under normal driving conditions and no personal data (e.g., name, gender, age, and crash location) are recorded. However, other parties, such as law enforcement, could combine the EDR data with the type of personally identifying data routinely acquired during a crash investigation.

To read data recorded by an EDR, special equipment is required, and access to the vehicle or the EDR is needed. In addition to the vehicle manufacturer, other parties, such as law enforcement, that have the special equipment, can read the information if they have access to the vehicle or the EDR.

The data belongs to the vehicle owner and may not be accessed by anyone else except as legally required or with the permission of the vehicle owner.

Service Diagnostic Recorders

This vehicle is equipped with service-related devices that record information about powertrain performance. The data can be used to verify emissions law requirements and/or help technicians diagnose and solve service problems. It may also be combined with data from other sources for research purposes, but it remains confidential. Some diagnostic and maintenance information is uploaded to Honda upon vehicle start up.

California Perchlorate Contamination Prevention Act

The airbags, seat belt tensioners, and CR type batteries in this vehicle may contain perchlorate materials - special handling may apply. See www.dtsc.ca.gov/hazardouswaste/perchlorate/

As you read this manual, you will find information that is preceded by a **NOTICE** symbol. This information is intended to help you avoid damage to your vehicle, other property, or the environment.

Software End User License Agreement

Your vehicle comes equipped with software, which is governed by the End User License Agreement in Owner's Manual, and which contains a binding arbitration clause. Please refer to the End User License Agreement for the terms and conditions governing your use of the installed software, as well as the applications, services, functions, and content provided through the software. Your use of the installed software will serve as your consent to the terms and conditions of the End User License Agreement.

You may opt out within 30 days of your initial use of the Software by sending a signed, written notice to HONDA at American Honda Motor Co., Inc. Honda Automobile Customer Services Mail Stop 100-5E-8A, 1919 Torrance Blvd. Torrance, CA 90501-2746.

Privacy Notice

This vehicle may share location and usage information. To manage this setting, visit www.hondalink.com/vehicle-data-choices.

A Few Words About Safety

Your safety, and the safety of others, is very important. And operating this vehicle safely is an important responsibility.

To help you make informed decisions about safety, we have provided operating procedures and other information on labels and in this manual. This information alerts you to potential hazards that could hurt you or others.

Of course, it is not practical or possible to warn you about all the hazards associated with operating or maintaining your vehicle. You must use your own good judgment.

You will find this important safety information in a variety of forms, including:

- **Safety Labels** - on the vehicle.
- **Safety Messages** - preceded by a safety alert symbol  and one of three signal words: **DANGER**, **WARNING**, or **CAUTION**. These signal words mean:

DANGER

You **WILL** be **KILLED** or **SERIOUSLY HURT** if you don't follow instructions.

WARNING

You **CAN** be **KILLED** or **SERIOUSLY HURT** if you don't follow instructions.

CAUTION

You **CAN** be **HURT** if you don't follow instructions.

- **Safety Headings** - such as Important Safety Precautions.
- **Safety Section** - such as Safe Driving.
- **Instructions** - how to use this vehicle correctly and safely.

This entire book is filled with important safety information - please read it carefully.

This owner's manual should be considered a permanent part of the vehicle and should remain with the vehicle when it is sold.

This owner's manual covers all models of your vehicle. You may find descriptions of equipment and features that are not on your particular model.

Images throughout this owner's manual (including the front cover) represent features and equipment that are available on some, but not all, models. Your particular model may not have some of these features.

This owner's manual is for vehicles sold in the United States and Canada.

The information and specifications included in this publication were in effect at the time of approval for printing. Honda Motor Co., Ltd. reserves the right, however, to discontinue or change specifications or design at any time without notice and without incurring any obligation.

➤ Safe Driving P. 33

For Safe Driving P. 34 Seat Belts P. 38 Airbags P. 46

➤ Instrument Panel P. 75

Indicators P. 76 Gauges and Displays P. 109

➤ Controls P. 125

Clock P. 126 Locking and Unlocking the Doors P. 128
Opening and Closing the Moonroof* P. 154
Adjusting the Seats P. 171

➤ Features P. 199

Audio System P. 200 Audio System Basic Operation P. 207, 225
Customized Features P. 316 *Bluetooth*® HandsFreeLink® P. 349, 372

➤ Driving P. 405

Before Driving P. 406 Towing a Trailer P. 411
Multi-View Rear Camera P. 491 Refueling P. 493

➤ Maintenance P. 499

Before Performing Maintenance P. 500 Maintenance Minder™ P. 503
Checking and Maintaining Wiper Blades P. 536
Climate Control System Maintenance P. 553

➤ Handling the Unexpected P. 561

Tools P. 562 If a Tire Goes Flat P. 563
Overheating P. 589 Indicator, Coming On/Blinking P. 591
When You Cannot Open the Trunk P. 603 Refueling P. 604

➤ Information P. 605

Specifications P. 606 Identification Numbers P. 610
Emissions Testing P. 613 Warranty Coverages P. 615

Contents

Child Safety P. 60

Exhaust Gas Hazard P. 73

Safety Labels P. 74

Opening and Closing the Trunk P. 145

Security System P. 148

Opening and Closing the Windows P. 151

Operating the Switches Around the Steering Wheel P. 155

Adjusting the Mirrors P. 169

Interior Lights/Interior Convenience Items P. 180

Climate Control System P. 191

Audio Error Messages P. 295

General Information on the Audio System P. 298

When Driving P. 412

Braking P. 474

Parking Your Vehicle P. 490

Fuel Economy and CO₂ Emissions P. 496

Turbo Engine Vehicle* P. 497

Maintenance Under the Hood P. 512

Replacing Light Bulbs P. 527

Remote Transmitter Care P. 551

Checking and Maintaining Tires P. 539

Battery P. 549

Cleaning P. 554

Accessories and Modifications P. 559

Engine Does Not Start P. 582

Jump Starting P. 585

Shift Lever Does Not Move P. 588

Fuses P. 597

Emergency Towing P. 601

When You Cannot Unlock the Fuel Fill Door P. 602

Devices that Emit Radio Waves P. 611

Reporting Safety Defects P. 612

Authorized Manuals P. 617

Customer Service Information P. 618

Quick Reference Guide P. 4

Safe Driving P. 33

Instrument Panel P. 75

Controls P. 125

Features P. 199

Driving P. 405

Maintenance P. 499

Handling the Unexpected P. 561

Information P. 605

Index P. 619

Visual Index

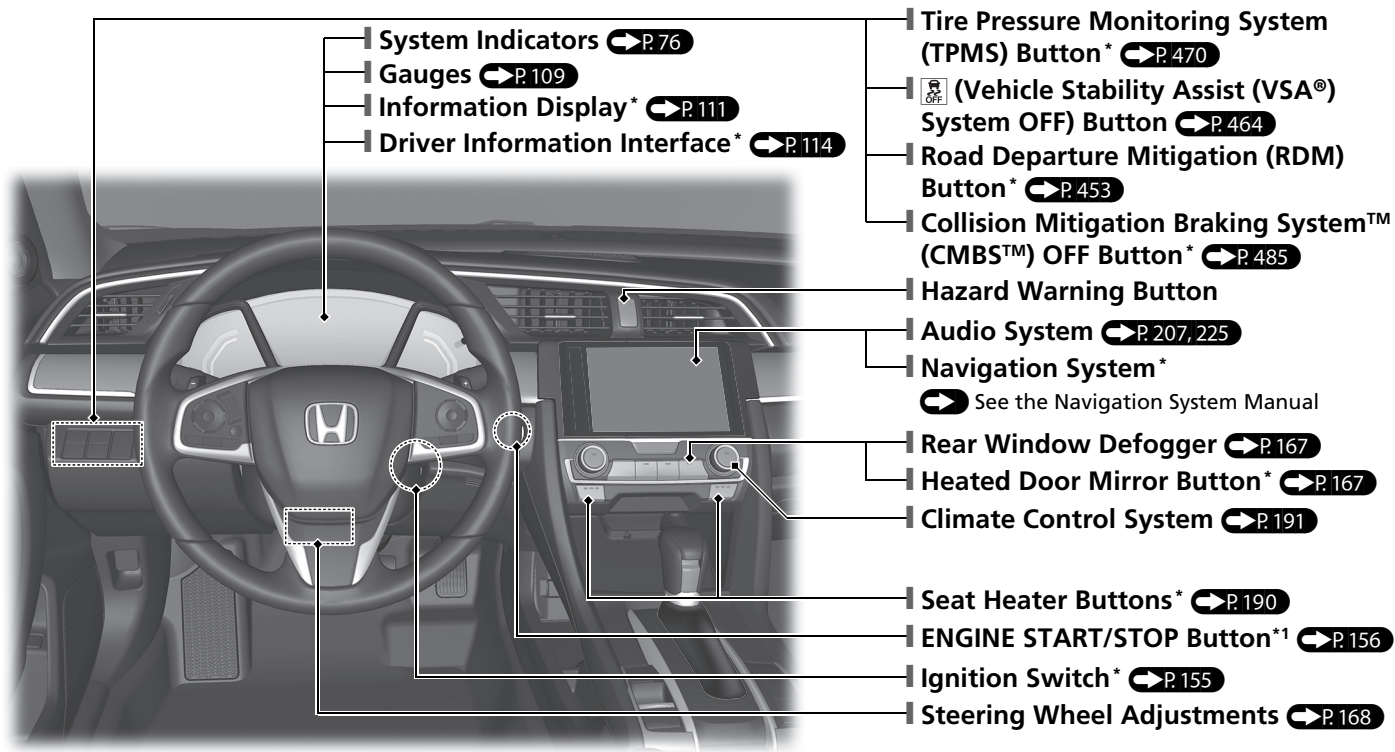

*1: Models with the smart entry system have an **ENGINE START/STOP** button instead of an ignition switch.

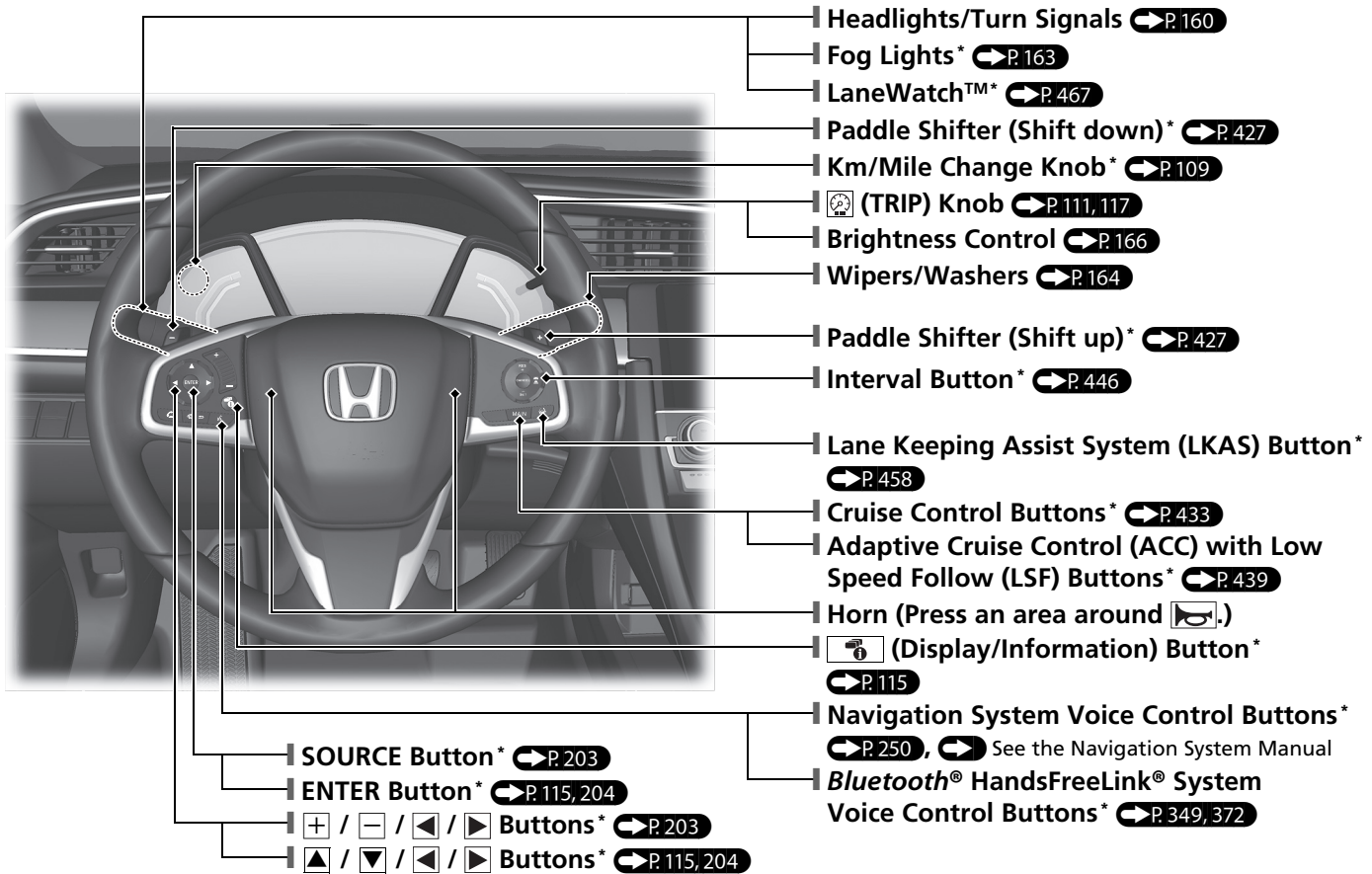

Visual Index

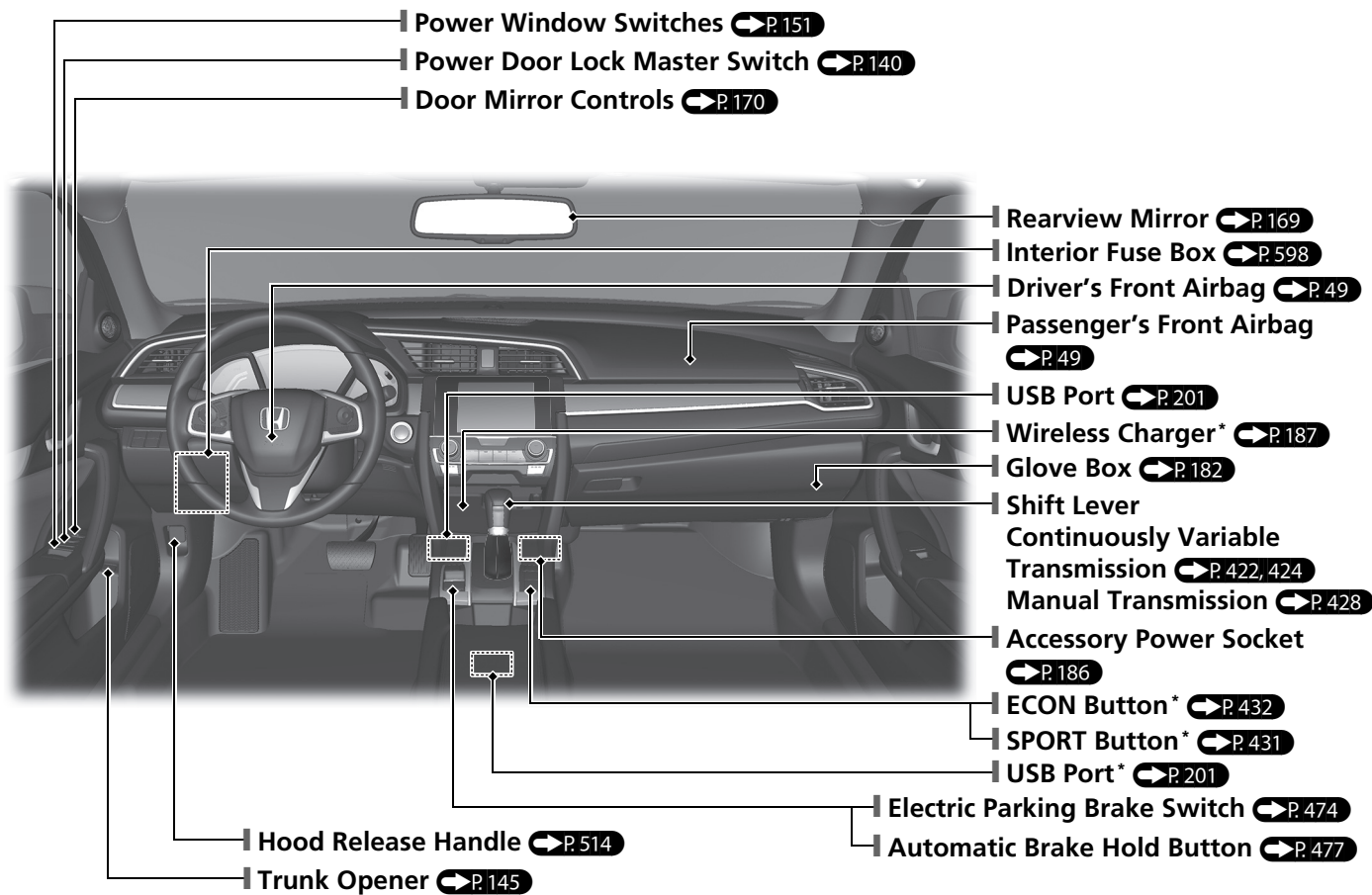

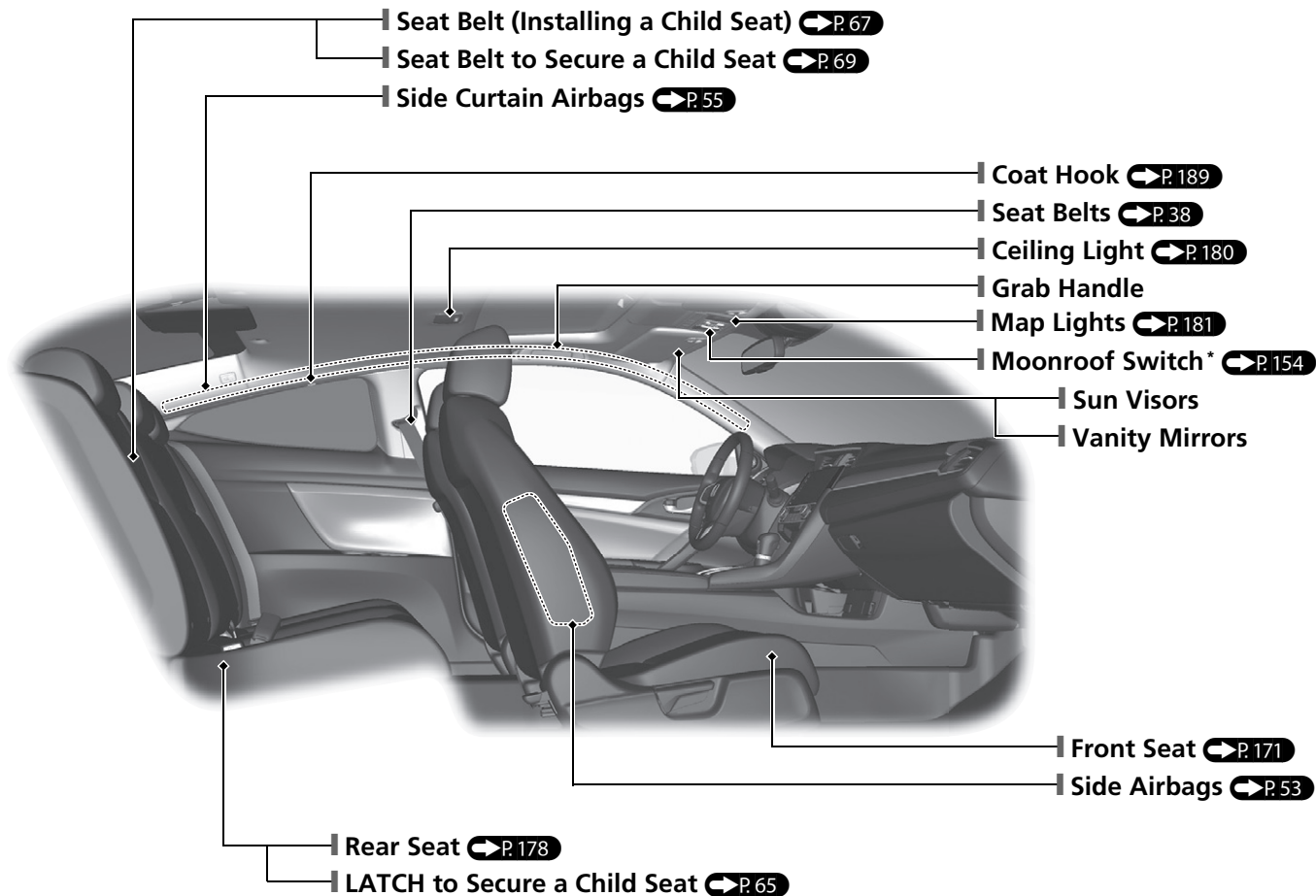

* Not available on all models

Visual Index

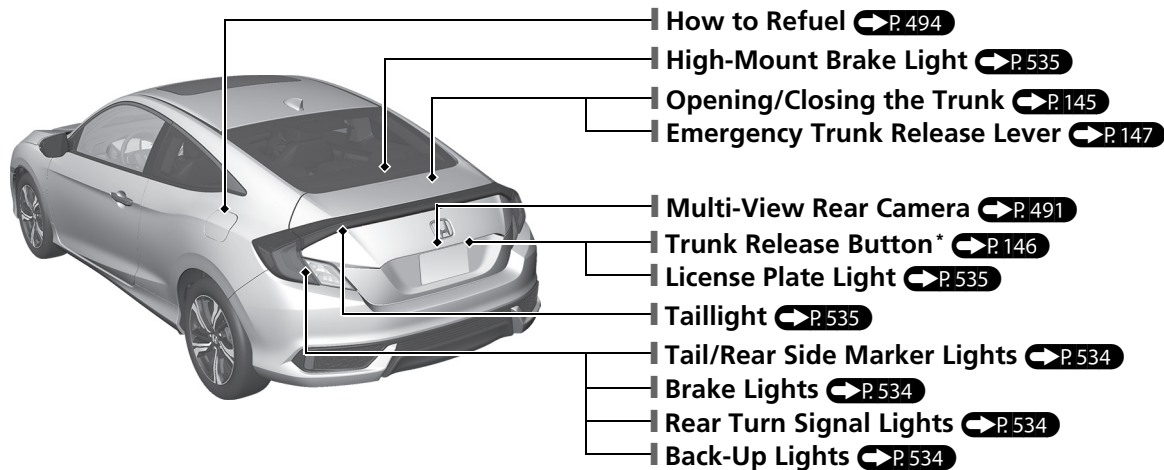
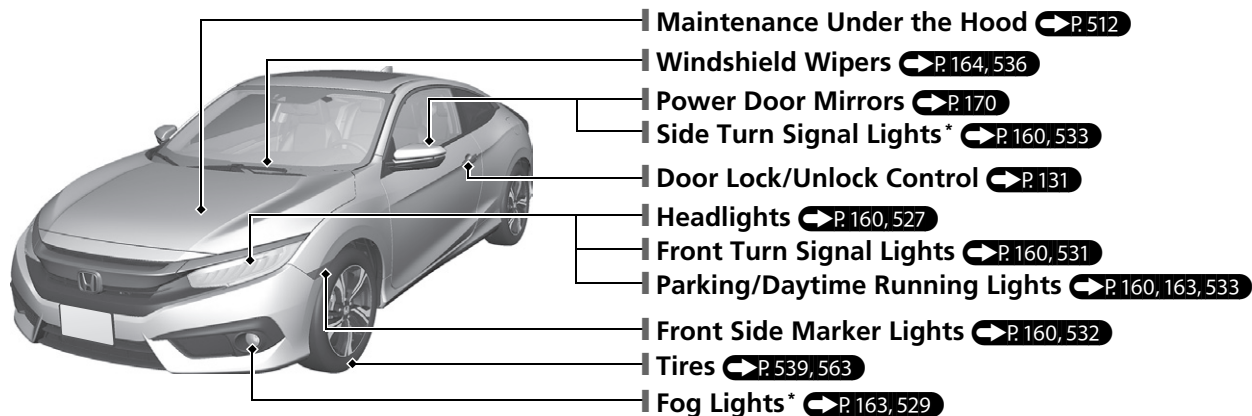

Eco Assist® System* P. 432

Ambient Meter

- The color of the ambient meter changes to green to indicate that the vehicle is being driven in a fuel efficient manner.

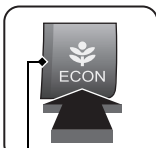
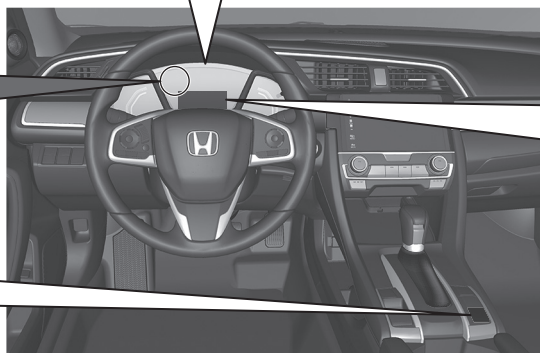

ECON Button P. 432

Helps maximize fuel economy.

ECON Mode Indicator P. 87

Comes on when the ECON button is pressed.

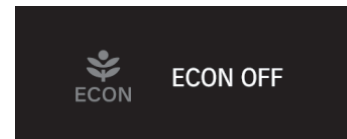
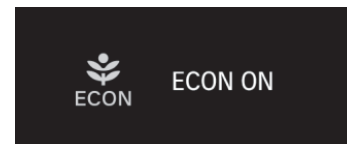

Models with driver information interface

The message is displayed for a few seconds when the ECON button is pressed.

Safe Driving P. 33

Airbags P. 46

- Your vehicle is fitted with airbags to help to protect you and your passengers during a moderate-to-severe collision.

Child Safety P. 60

- All children 12 and younger should be seated in the rear seat.
- Smaller children should be properly restrained in a forward-facing child seat.
- Infants must be properly restrained in a rear-facing child seat.

Exhaust Gas Hazard P. 73

- Your vehicle emits dangerous exhaust gases that contain carbon monoxide. Do not run the engine in confined spaces where carbon monoxide gas can accumulate.

Seat Belts P. 38

- Fasten your seat belt and sit upright well back in the seat.
- Check that your passengers are wearing their seat belts correctly.

Before Driving Checklist P. 37

- Before driving, check that the front seats, head restraints, steering wheel, and mirrors have been properly adjusted.



Fasten your lap belt as low as possible.













Instrument Panel P. 75

Gauges  P. 109 / Information Display*  P. 111 /

Driver Information Interface*  P. 114 / System Indicators  P. 76



Models with information display

System Indicators

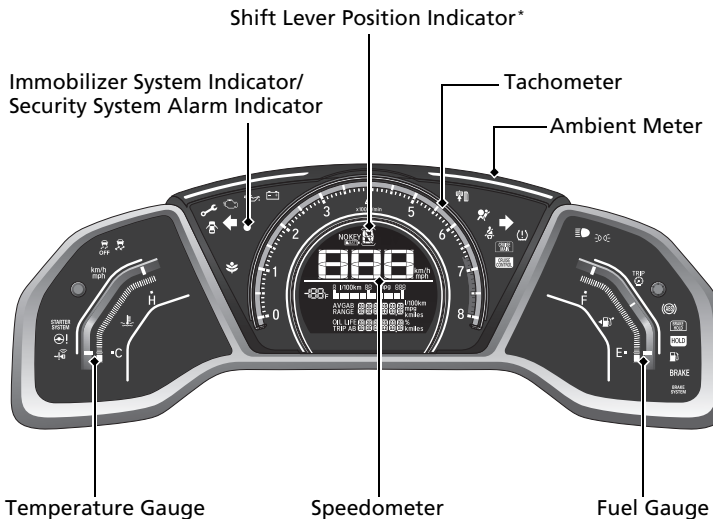

-  Malfunction Indicator Lamp
-  Low Oil Pressure Indicator
-  Charging System Indicator
-  Anti-lock Brake System (ABS) Indicator
-  Vehicle Stability Assist (VSA®) System Indicator
-  VSA® OFF Indicator
-  Door and Trunk Open Indicator
-  Automatic Brake Hold System Indicator
-  Automatic Brake Hold Indicator
-  BRAKE Parking Brake and Brake System Indicator (Red)
-  BRAKE SYSTEM Parking Brake and Brake System Indicator (Amber)
-  Smart Entry System Indicator*















System Indicators

-  STARTER SYSTEM Starter System Indicator*
-  ECON Mode Indicator
-  Low Tire Pressure/ TPMS Indicator

Lights Indicators













-  Lights On Indicator
-  High Beam Indicator

System Indicators

-  Turn Signal and Hazard Warning Indicators
-  Electric Power Steering (EPS) System Indicator
-  Low Fuel Indicator
-  Seat Belt Reminder Indicator
-  Supplemental Restraint System Indicator
-  CRUISE MAIN Indicator
-  CRUISE CONTROL Indicator
-  Continuously variable transmission models
-  Brake Depressing Indicator
-  Manual transmission models
-  Brake Depressing Indicator
-  Maintenance Minder Indicator



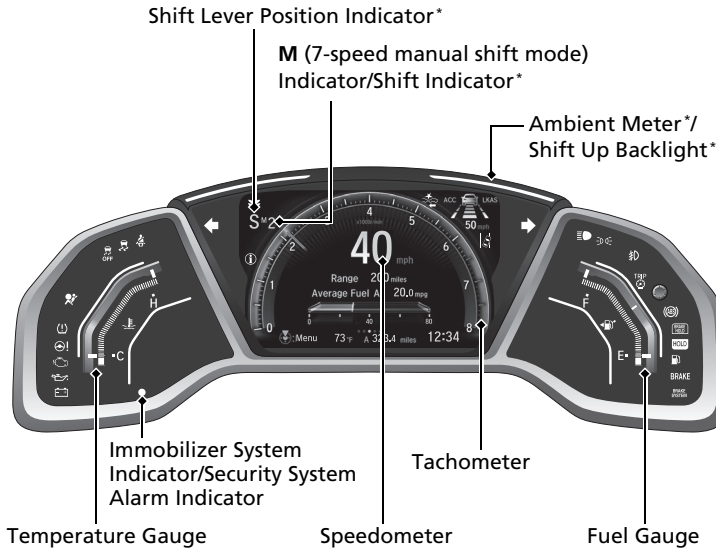

* Not available on all models

System Indicators



-  Malfunction Indicator Lamp
-  Low Oil Pressure Indicator
-  Charging System Indicator
-  Anti-lock Brake System (ABS) Indicator
-  Vehicle Stability Assist (VSA®) System Indicator
-  VSA® OFF Indicator
-  Automatic Brake Hold System Indicator
-  U.S. Automatic Brake Hold Indicator
-  Canada
-  **BRAKE**
U.S. Parking Brake and Brake System Indicator (Red)
-  **BRAKE SYSTEM**
U.S. Parking Brake and Brake System Indicator (Amber)
-  **BRAKE SYSTEM**
U.S. Parking Brake and Brake System Indicator (Amber)
-  **BRAKE SYSTEM**
U.S. Parking Brake and Brake System Indicator (Amber)















System Indicators

-  System Message Indicator
-  Low Tire Pressure/TPMS Indicator*
-  **CRUISE MAIN** Indicator*
-  **CRUISE CONTROL** Indicator*

Lights Indicators

-  Lights On Indicator
-  High Beam Indicator
-  Fog Light Indicator*

System Indicators





-  Turn Signal and Hazard Warning Indicators
-  Electric Power Steering (EPS) System Indicator
-  Low Fuel Indicator
-  Seat Belt Reminder Indicator
-  Supplemental Restraint System Indicator
-  **ACC**
Adaptive Cruise Control (ACC) with Low Speed Follow (LSF) Indicator (Amber/Green)*
-  Road Departure Mitigation (RDM) Indicator*
-  Collision Mitigation Braking System™ (CMBS™) Indicator*
-  Lane Keeping Assist System (LKAS) Indicator (Amber/Green)*
-  **LKAS**
Lane Keeping Assist System (LKAS) Indicator (Amber/Green)*
-  **ECON** Mode Indicator*
-  **SPORT** Mode Indicator*

Controls P. 125

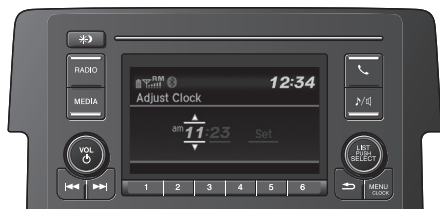
Clock P. 126

Models with color audio system





- 1 Press and hold the **MENU/CLOCK** button.
- 2 Rotate  to change hour, then press .
- 3 Rotate  to change minute, then press .
- 4 Select **SET**, then press .

These indications are used to show how to operate the **LIST/SELECT** (List/Selector) knob.

- Rotate  to select.
- Press  to enter.

Models with Display Audio



- 1 Select the  (HOME) icon, then select **Settings**.
- 2 Select **Clock**, then **Clock Adjustment**.
- 3 Touch the respective  /  icon to adjust the hours or minutes up or down.
- 4 Select **OK**.

Models with navigation system

The audio system receives signals from GPS satellites, updating the clock automatically.

ENGINE START/STOP Button* P. 156

- Press the button to change the vehicle's power mode.



Turn Signals P. 160

Turn Signal Control Lever

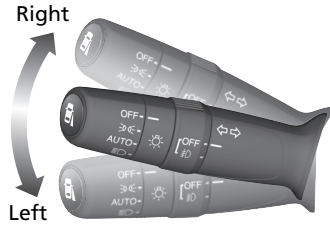

Lights P. 160

Light Control Switches

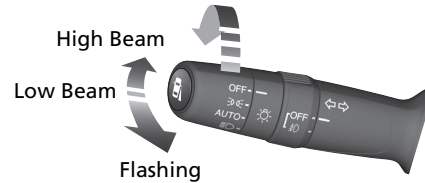



Wipers and Washers P. 164

Wiper/Washer Control Lever

Adjustment Ring*

: Low sensitivity*¹

: Lower speed, fewer sweeps*²

: High sensitivity*¹

: Higher speed, more sweeps*²

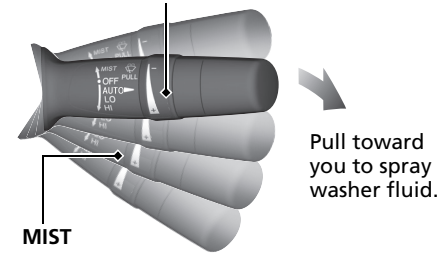

MIST
OFF

AUTO*¹: Wiper speed varies automatically

INT*²: Low speed with intermittent

LO: Low speed wipe

HI: High speed wipe

*¹: Models with automatic intermittent wipers

*²: Models without automatic intermittent wipers

Models with automatic intermittent wipers

AUTO should always be turned **OFF** before the following situation in order to prevent severe damage to the wiper system:

- Cleaning the windshield
- Driving through a car wash
- No rain present

Steering Wheel P. 168

- To adjust, pull the adjustment lever up, adjust to the desired position, then push down the lever back in place.

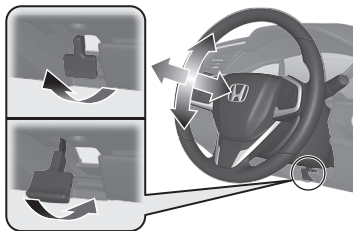

Unlocking the Doors from the Inside P. 139

- Pull either door inner handle to unlock and open it at the same time.

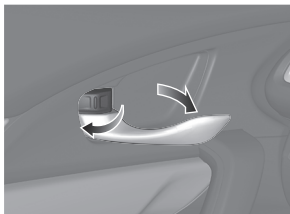

Trunk P. 145



Trunk Opener

- To unlock and open the trunk:
- Press the trunk opener on the driver's door.
- Press the trunk release button on the remote transmitter or the smart entry remote.
- Press the trunk release button* on the trunk lid.

Power Door Mirrors

 P. 170

- With the ignition switch in ON ^{*1}, move the selector switch to L or R.
- Push the appropriate edge of the adjustment switch to adjust the mirror.

Selector Switch

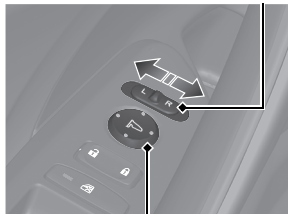

Adjustment Switch

Power Windows P. 151

- With the ignition switch in ON ^{*1}, open and close the power windows.
- If the power window lock button is in the off position, the passenger's window can be opened and closed with its own switch.
- If the power window lock button is in the on position (indicator is on), the passenger's window switch is disabled.

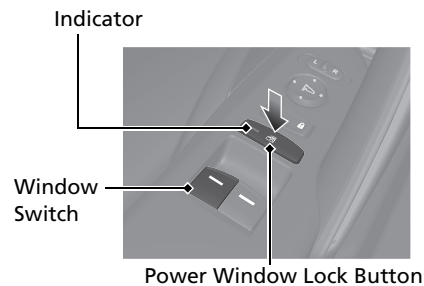



Indicator

Window Switch

Power Window Lock Button





*1: Models with the smart entry system have an **ENGINE START/STOP** button instead of an ignition switch.

Climate Control System P.191

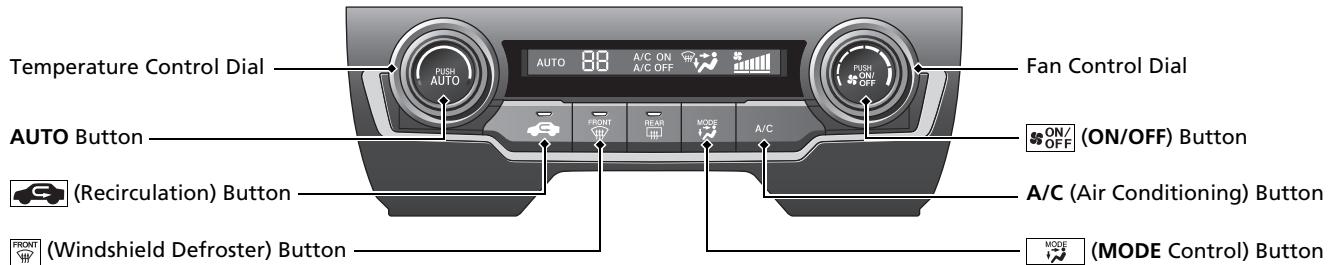
- Press the **AUTO** button to activate the climate control system.
- Press the  button to turn the system on or off.
- Press the  button to defrost the windshield.

Models with color audio system



-  Air flows from floor and windshield defroster vents.
-  Air flows from floor vents.
-  Air flows from floor and dashboard vents.
-  Air flows from dashboard vents.

Models with Display Audio
 Models without SYNC button

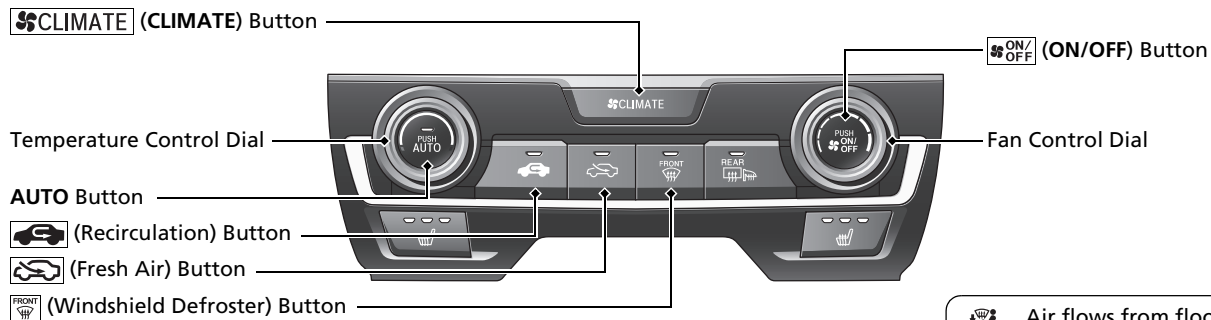
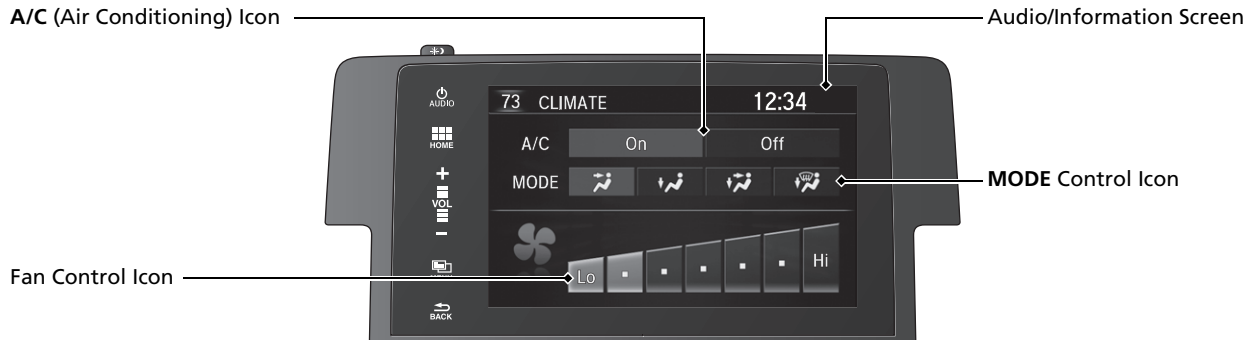

- Air flows from floor and windshield defroster vents.
- Air flows from floor vents.
- Air flows from floor and dashboard vents.
- Air flows from dashboard vents.

Models with Display Audio

Models with SYNC button

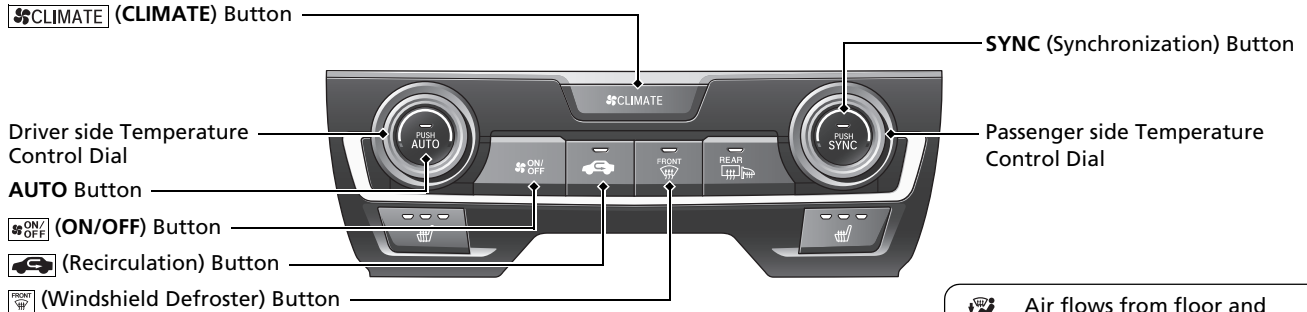
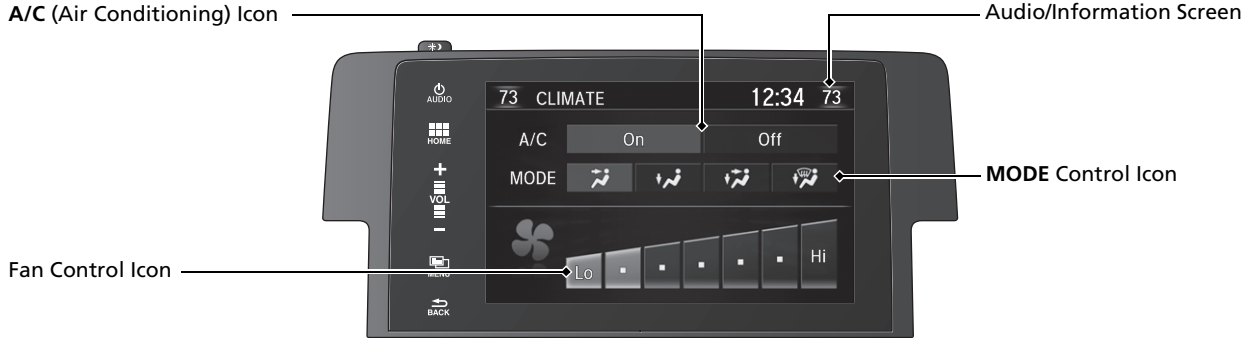

- Air flows from floor and windshield defroster vents.
- Air flows from floor vents.
- Air flows from floor and dashboard vents.
- Air flows from dashboard vents.

Features ➔ P. 199

Audio Remote Controls

➔ P. 203

Models with color audio system

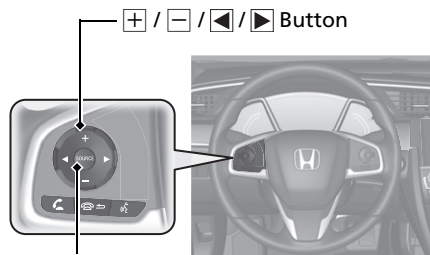

SOURCE Button

- **+ / -** Button
Press to adjust the volume up/down.
- **SOURCE** Button
Press to change the audio mode: FM/AM/USB/iPod/*Bluetooth*® Audio.
- **< / >** Button
Radio: Press to change the preset station.
Press and hold to select the next or previous strong station.
USB device:
Press to skip to the beginning of the next song or return to the beginning of the current song.
Press and hold to change a folder.

Models with Display Audio

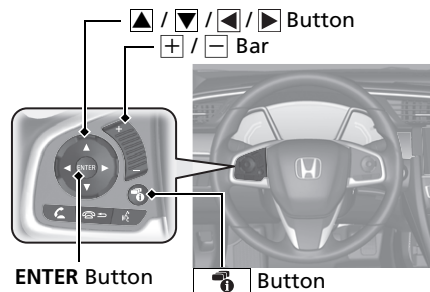







- **+ / -** Bar
Press to adjust the volume up/down.
- **< / >** Button
Press **<** or **>** to cycle through the audio mode as follows:
FM→AM→SiriusXM®*→USB→iPod→*Bluetooth*® Audio→Pandora®*→Apps*→Audio Apps*

- **ENTER** Button
- When listening to the radio and SiriusXM®*



- 1 Press **ENTER** to switch the display to a preset list you stored in the preset buttons.
 - 2 Press **<** or **>** to select a preset, then press **ENTER**.
- When listening to a USB flash drive

- 1 Press **ENTER** to display the folder list.
- 2 Press **<** or **>** to select a folder.
- 3 Press **ENTER** to display a list of tracks in that folder.
- 4 Press **<** or **>** to select a track, then press **ENTER**.



- When listening to an iPod

- 1 Press **ENTER** to display the iPod music list.
- 2 Press  or  to select a category.
- 3 Press **ENTER** to display a list of items in the category.
- 4 Press  or  to select an item, then press **ENTER**.
 - ▶ Press **ENTER** and press  or  repeatedly until a desired item you want to listen to is displayed.

- When listening to Internet Radio*

- 1 Press **ENTER** to display the station list.
- 2 Press  or  to select an item, then press **ENTER**.

- When listening to *Bluetooth*® Audio

- 1 Press **ENTER** to display the track list.
- 2 Press  or  to select a track, then press **ENTER**.

-  /  Button

Radio: Press to change the preset station.
Press and hold to select the next or previous strong station.

USB device:

Press to skip to the beginning of the next song or return to the beginning of the current song.
Press and hold to change a folder.

-  Button

Press to change contents.

 **Driver Information Interface***

 P. 114

Audio system P. 200

Models with color audio system  P. 207

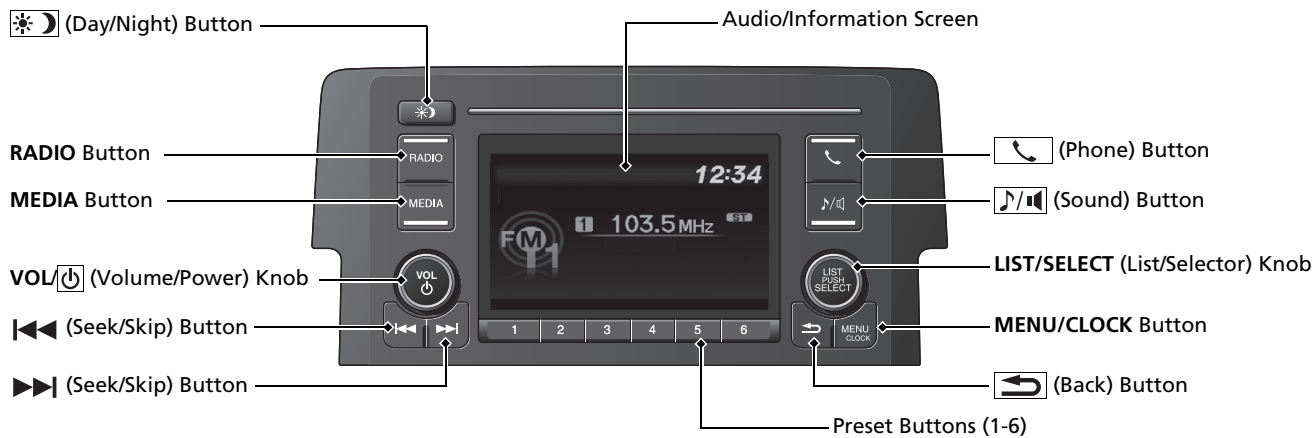

For navigation system operation See the Navigation System Manual

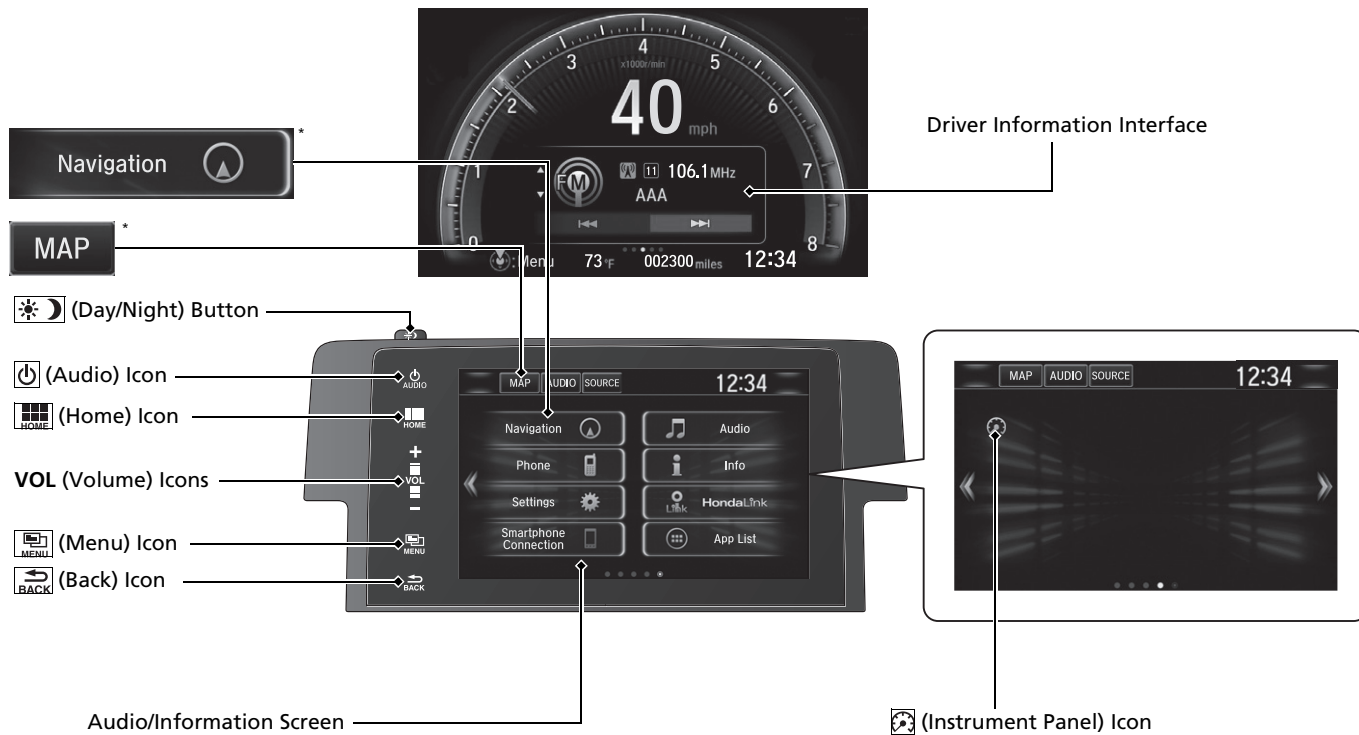

Driving ➔ P. 405

Manual Transmission* ➔ P. 428

Continuously Variable Transmission* ➔ P. 422, 424

- Shift to **P** and depress the brake pedal when starting the engine.
- **Shifting**

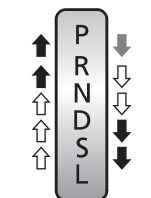

Models without paddle shifter

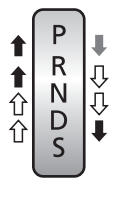

Models with paddle shifter

Depress the brake pedal and press the release button to move out of **P**.

Press the release button to move the shift lever.

Move the shift lever without pressing the release button.

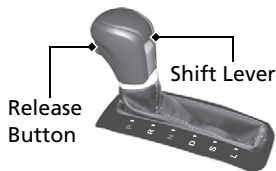

P **Park**
Turn off or start the engine.
Transmission is locked.

R **Reverse**
Used when reversing.

N **Neutral**
Transmission is not locked.

D **Drive**

- Normal driving.
- On models with paddle shifter, 7-speed mode can be used temporarily.

S **Drive (S)**

- Better acceleration.
- Increased engine braking.
- Going up or down hills.
- On models with paddle shifter, 7-speed manual shift mode can be used.

L **Low***

- Further increased engine braking.
- Going up or down hills.

7-Speed Manual Shift Mode* ➔ P. 426

- Allows you to manually shift the transmission up or down without removing your hands from the steering wheel.

M Indicator



Shift Indicator

Shift Down **-** Shift Up **+**
Paddle Shifter Paddle Shifter

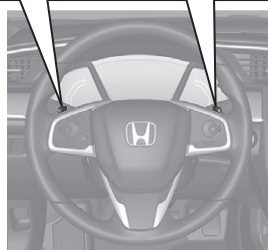
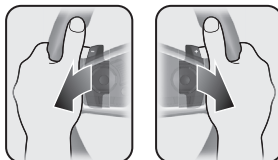

When the shift lever is in **S**

- Pulling a paddle shifter changes the mode from Continuously Variable Transmission to 7-speed manual shift mode.
- The **M** indicator and the selected speed number are displayed in the shift indicator.

When the shift lever is in **D**

- Pulling a paddle shifter temporarily changes the mode from continuously variable transmission to 7-speed manual shift mode. The selected speed number is displayed in the shift indicator.

VSA® On and Off P. 464

- The vehicle stability assist (VSA®) system helps stabilize the vehicle during cornering, and helps maintain traction while accelerating on loose or slippery road surfaces.
- VSA® comes on automatically every time you start the engine.
- To partially disable or fully restore VSA® function, press and hold the button until you hear a beep.

Cruise Control* P. 433

- Cruise control allows you to maintain a set speed without keeping your foot on the accelerator pedal.
- To use cruise control, press the **CRUISE** button, then press the **-/SET** button once you have achieved the desired speed (above 25 mph or 40 km/h).

CMBS™ On and Off*

P. 485

- When a possible collision is likely unavoidable, the CMBS™ can help you to reduce the vehicle speed and the severity of the collision.
- To turn the CMBS™ on or off, press and hold the button until you hear a beep.

U.S. models

Tire Pressure Monitoring System (TPMS) P. 469

- Detects a change in tire conditions and overall dimensions due to decrease in tire pressures.
- The TPMS is turned on automatically every time you start the engine.
- A calibration procedure must be performed when certain conditions arise.

Refueling P. 493

Fuel recommendation: **Models without SPORT mode**
Unleaded gasoline, pump octane number 87 or higher

Models with SPORT mode
Unleaded premium gasoline, pump octane number 91 or higher

Fuel tank capacity: 12.39 US gal (46.9 L)

- 1 Unlock the driver's door.
 **Locking/Unlocking the Doors from the Inside**

 P. 138

- 2 Press on the edge of the fuel fill door to make it pop up slightly.



- 3 After refueling, wait for about five seconds before removing the filler nozzle.

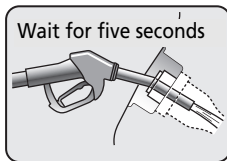

Honda Sensing™*

Honda Sensing™ is a driver support system which employs the use of two distinctly different kinds of sensors, a radar sensor located in the lower bumper and a front sensor camera mounted to the interior side of the windshield, behind the rearview mirror.

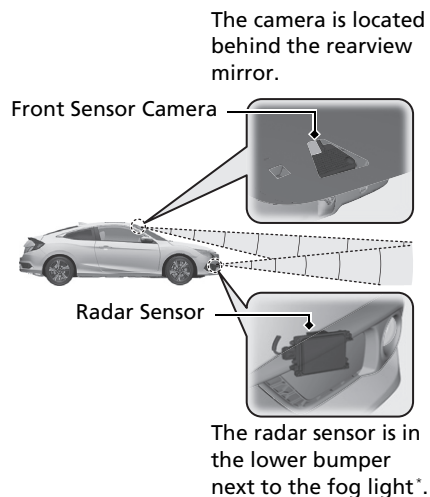

Adaptive Cruise Control (ACC) with Low Speed Follow (LSF) P. 438

Helps maintain a constant vehicle speed and a set following interval behind a vehicle detected ahead of yours and, if the detected vehicle comes to a stop, can decelerate and stop your vehicle, without you having to keep your foot on the brake or the accelerator.

Road Departure Mitigation (RDM) System P. 452

Alerts and helps to assist you when the system detects a possibility of your vehicle unintentionally crossing over detected lane markings and/or leaving the roadway altogether.

Lane Keeping Assist System (LKAS) P. 456

Provides steering input to help keep the vehicle in the middle of a detected lane and provides tactile and visual alerts if the vehicle is detected drifting out of its lane.

Collision Mitigation Braking System™ (CMBS™) P. 482

Can assist you when there is a possibility of your vehicle colliding with a vehicle or a pedestrian detected in front of yours. The CMBS™ is designed to alert you when a potential collision is determined, as well as to reduce your vehicle speed to help minimize collision severity when a collision is deemed unavoidable.

Maintenance P. 499

Under the Hood P. 512

- Check engine oil, engine coolant, and windshield washer fluid. Add when necessary.
- Check brake/clutch* fluid.
- Check the battery condition monthly.

1 Pull the hood release handle under the corner of the dashboard.



2 Locate the hood latch lever, pull it up, and then raise the hood. Once you have raised the hood slightly, you can release the lever.

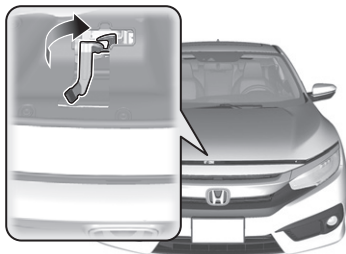

3 When finished, close the hood and make sure it is firmly locked in place.

Wiper Blades P. 536

- Replace blades if they leave streaks across the windshield.



Tires P. 539

- Inspect tires and wheels regularly.
- Check tire pressures regularly.
- Install snow tires for winter driving.

Lights P. 527

- Inspect all lights regularly.

Handling the Unexpected P. 561

Flat Tire P. 563, 570

- Park in a safe location and replace the flat tire with the compact spare tire* in the trunk, or repair the flat tire using the tire repair kit*.



Engine Won't Start P. 582

- If the battery is dead, jump start using a booster battery.

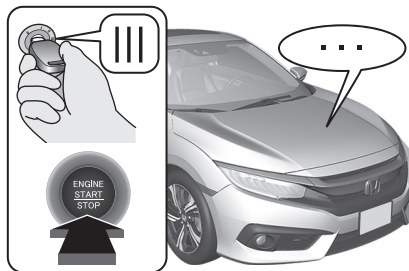

Overheating P. 589

- Park in a safe location. If you do not see steam under the hood, open the hood, and let the engine cool down.



Indicators Come On

 P. 591

- Identify the indicator and consult the owner's manual.



Blown Fuse P. 597

- Check for a blown fuse if an electrical device does not operate.

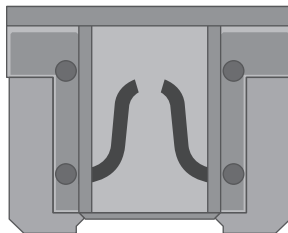

Emergency Towing

 P. 601

- Call a professional towing service if you need to tow your vehicle.



What to Do If

Q

Models without smart entry system

The ignition switch does not turn from 0 to I.

Why?

Models with smart entry system

The power mode does not change from VEHICLE OFF (LOCK) to ACCESSORY.

Why?

A

The steering wheel may be locked.

Models without smart entry system

- Try to turn the steering wheel left and right while turning the ignition key.

Models with smart entry system**

- Move the steering wheel left and right after pressing the ENGINE START/STOP button.



Q

Models without smart entry system

The ignition switch does not turn from I to 0 and I cannot remove the key.

Why?

Models with smart entry system

The power mode does not change from ACCESSORY to VEHICLE OFF (LOCK).

Why?

A

The shift lever should be moved to P.



*1:Except U.S. models with continuously variable transmission

Q Why does the brake pedal pulsate slightly when applying the brakes?

A This can occur when the ABS activates and does not indicate a problem. Apply firm, steady pressure on the brake pedal. Never pump the brake pedal.

➤ Anti-lock Brake System (ABS) ➔ P. 480

Q Why do the doors lock after I unlocked the doors using a remote transmitter?

A If you do not open the doors within 30 seconds, the doors are relocked automatically for security.

Q Why does the beeper sound when I open the driver's door?

A The beeper sounds when:

- The key is left in the ignition switch*.
- The power mode* is in ACCESSORY.
- The exterior lights are left on.

Q **Models with smart entry system and Display Audio**
Why does a buzzer sound when I walk away from the vehicle after I close the door?

A The buzzer sounds if you move outside the walk away auto door lock operating range before the door completely closes.

➤ To lock (Walk Away Auto Door Lock) ➔ P. 132

Q Why does the beeper sound when I start driving?

A The beeper sounds when the driver and/or front passenger are not wearing their seat belts.

Q Why do I hear a screeching sound when I apply the brake pedal?

A The brake pads may need to be replaced. Have your vehicle inspected by a dealer.

Q **U.S. models**
I'm seeing an amber indicator of a tire with an exclamation point. What is that?

A The Tire Pressure Monitoring System (TPMS) needs attention. If you recently inflated or changed a tire, you have to recalibrate the system.
➤ Tire Pressure Monitoring System (TPMS) ➔ P. 469

Q Pressing the electric parking brake switch does not release the parking brake. Why?

A Press the electric parking brake switch with the brake pedal depressed.

Q Depressing the accelerator pedal does not release the parking brake automatically. Why?

A

- Fasten the driver's seat belt.
- Check if the transmission is in **P** or **N**. If so, select any other position.



Models with SPORT mode

Unleaded gasoline with a Pump Octane Number (PON) of 91 or higher is recommended.

Is it possible to use unleaded gasoline with a Pump Octane Number (PON) of 87 or lower on this vehicle?



Unleaded gasoline with a pump octane number of 91 or higher is recommended.

Use of lower octane gasoline can cause occasional metallic knocking noise in the engine and will result in decreased engine performance.

Use of gasoline with a pump octane less than 87 can lead to engine damage.

Safe Driving

You can find many safety recommendations throughout this chapter, and throughout this manual.

For Safe Driving

Important Safety Precautions	34
Your Vehicle's Safety Features.....	36
Safety Checklist	37

Seat Belts

About Your Seat Belts.....	38
Fastening a Seat Belt.....	42
Seat Belt Inspection.....	45

Airbags

Airbag System Components.....	46
Types of Airbags	49
Front Airbags (SRS)	49

Side Airbags	53
Side Curtain Airbags	55
Airbag System Indicators.....	57
Airbag Care	59

Child Safety

Protecting Child Passengers	60
Safety of Infants and Small Children.....	62
Safety of Larger Children	71

Exhaust Gas Hazard

Carbon Monoxide Gas.....	73
--------------------------	----

Safety Labels

Label Locations	74
-----------------------	----

The following pages explain your vehicle's safety features and how to use them properly. The safety precautions below are ones that we consider to be among the most important.

Important Safety Precautions

■ Always wear your seat belt

A seat belt is your best protection in all types of collisions. Airbags are designed to supplement seat belts, not replace them. So even though your vehicle is equipped with airbags, make sure you and your passengers always wear your seat belts, and wear them properly.

■ Restrain all children

Children ages 12 and under should ride properly restrained in a back seat, not the front seat. Infants and small children should be restrained in a child seat. Larger children should use a booster seat and a lap/shoulder seat belt until they can use the belt properly without a booster seat.

■ Be aware of airbag hazards

While airbags can save lives, they can cause serious or fatal injuries to occupants who sit too close to them, or are not properly restrained. Infants, young children, and short adults are at the greatest risk. Be sure to follow all instructions and warnings in this manual.

■ Don't drink and drive

Alcohol and driving don't mix. Even one drink can reduce your ability to respond to changing conditions, and your reaction time gets worse with every additional drink. So don't drink and drive, and don't let your friends drink and drive, either.

▣ Important Safety Precautions

Some states, provinces and territories prohibit the use of cell phones other than hands-free devices by the driver while driving.

■ Pay appropriate attention to the task of driving safely

Engaging in cell phone conversation or other activities that keep you from paying close attention to the road, other vehicles, and pedestrians could lead to a crash. Remember, situations can change quickly, and only you can decide when it is safe to divert some attention away from driving.

■ Control your speed

Excessive speed is a major factor in crash injuries and deaths. Generally, the higher the speed, the greater the risk, but serious injuries can also occur at lower speeds. Never drive faster than is safe for current conditions, regardless of the maximum speed posted.

■ Keep your vehicle in safe condition

Having a tire blowout or a mechanical failure can be extremely hazardous. To reduce the possibility of such problems, check your tire pressures and condition frequently, and perform all regularly scheduled maintenance.

■ Do not leave children unattended in the vehicle

Children left unattended in the vehicle may be injured if they activate one or more of the vehicle controls. They may also cause the vehicle to move, resulting in a crash in which the children and/or another person(s) can be injured or killed. Also, depending on the ambient temperature, the temperature of the interior may reach extreme levels, which can result in injury or death. Even if the climate control system is on, never leave children in the vehicle unattended as the climate control system can shut off at any time.

Your Vehicle's Safety Features

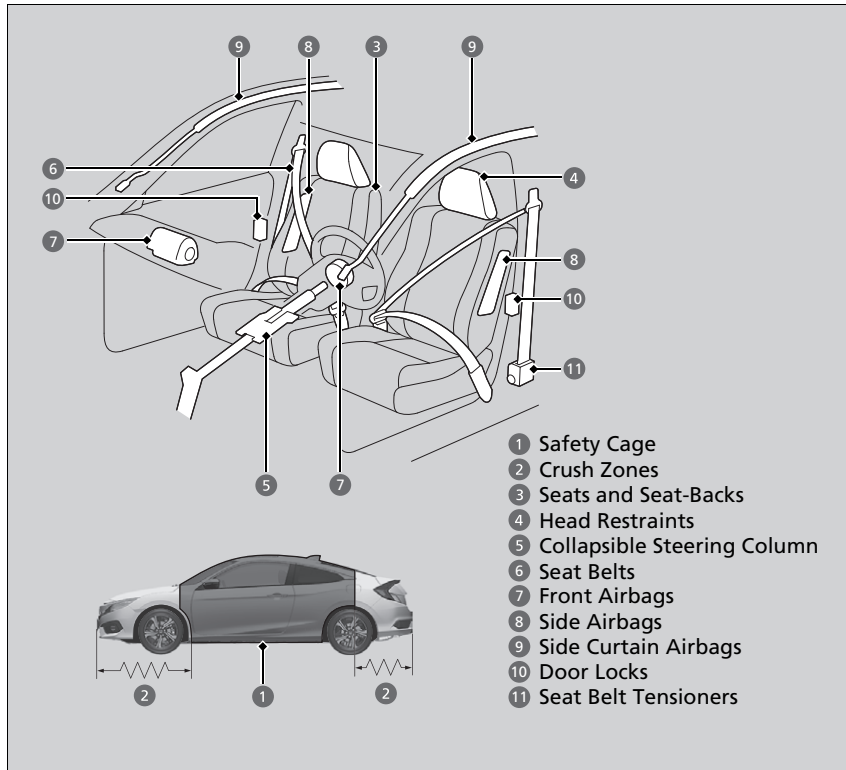

The following checklist will help you take an active role in protecting yourself and your passengers.

► Your Vehicle's Safety Features

Your vehicle is equipped with many features that work together to help protect you and your passengers during a crash.

Some features do not require any action on your part. These include a strong steel framework that forms a safety cage around the passenger compartment, front and rear crush zones, a collapsible steering column, and tensioners that tighten the front seat belts in a sufficient crash.

However, you and your passengers cannot take full advantage of these features unless you remain seated in the correct position and always wear your seat belts. In fact, some safety features can contribute to injuries if they are not used properly.

Safety Checklist

For the safety of you and your passengers, make a habit of checking these items each time before you drive.

- After everyone has entered the vehicle, be sure both doors are closed and locked. Locking the doors helps prevent an occupant from being ejected and an outsider from unexpectedly opening a door.
 - **Locking/Unlocking the Doors from the Inside** P. 138
- Adjust your seat to a position suitable for driving. Be sure the front seats are adjusted as far to the rear as possible while allowing the driver to control the vehicle. Sitting too close to a front airbag can result in serious or fatal injury in a crash.
 - **Adjusting the Seats** P. 171

Models without SPORT mode

- Adjust head restraints to the proper position. Head restraints are most effective when the center of the head restraint aligns with the center of your head. Taller persons should adjust their head restraint to the highest position.
 - **Adjusting the Front Head Restraints** P. 174
- Always wear your seat belt, and make sure you wear it properly. Confirm that any passengers are properly belted as well.
 - **Fastening a Seat Belt** P. 42
- Protect children by using seat belts or child seats according to a child's age, height and weight.
 - **Child Safety** P. 60

* Not available on all models

▶▶ Safety Checklist

Models with information display

If the door and trunk open indicator is on, a door and/or the trunk is not completely closed. Close both doors and the trunk tightly until the indicator goes off.

➤ **Door and Trunk Open Indicator*** P. 83

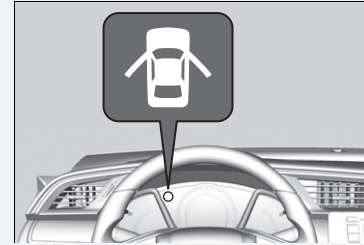

Models with driver information interface

If the door and trunk open message appears on the driver information interface, a door and/or the trunk is not completely closed. Close both doors and the trunk tightly until the message disappears.

➤ **Driver Information Interface Warning and Information Messages*** P. 97

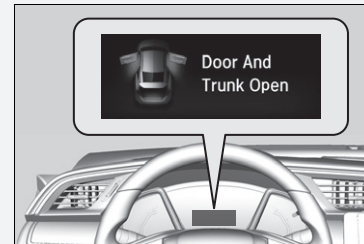

About Your Seat Belts

Seat belts are the single most effective safety device because they keep you connected to the vehicle so that you can take advantage of many built-in safety features. They also help keep you from being thrown against the inside of the vehicle, against other passengers, or out of the vehicle. When worn properly, seat belts also keep your body properly positioned in a crash so that you can take full advantage of the additional protection provided by the airbags.

In addition, seat belts help protect you in almost every type of crash, including:

- frontal impacts
- side impacts
- rear impacts
- rollovers

■ Lap/shoulder seat belts

All five seating positions are equipped with lap/shoulder seat belts with emergency locking retractors. In normal driving the retractor lets you move freely while keeping some tension on the belt. During a collision or sudden stop the retractor locks to restrain your body.

The front passenger's and rear seat belts also have a lockable retractor for use with child seats.

➤ **Installing a Child Seat with a Lap/Shoulder Seat Belt** P. 67

➤ About Your Seat Belts

WARNING

Not wearing a seat belt properly increases the chance of serious injury or death in a crash, even though your vehicle has airbags.

Be sure you and your passengers always wear seat belts and wear them properly.

Seat belts cannot completely protect you in every crash. But in most cases, seat belts can reduce your risk of serious injury.

Most states and all Canadian provinces and territories require you to wear seat belts.

If you extend the seat belt too quickly, it will lock in place. If this happens, slightly retract the seat belt, then extend it slowly.

■ Proper use of seat belts

Follow these guidelines for proper use:

- All occupants should sit upright, well back in the seat, and remain in that position for the duration of the trip. Slouching and leaning reduce the effectiveness of the belt and can increase the chance of serious injury in a crash.
- Never place the shoulder part of a lap/shoulder seat belt under your arm or behind your back. This could cause very serious injuries in a crash.
- Two people should never use the same seat belt. If they do, they could be very seriously injured in a crash.
- Do not put any accessories on the seat belts. Devices intended to improve comfort or reposition the shoulder part of a seat belt can reduce the protective capability and increase the chance of serious injury in a crash.

⌘ About Your Seat Belts

If a rear seat passenger moves around and extends the seat belt, the lockable retractor may activate. If this happens, release the retractor by unfastening the seat belt and allow the belt to retract completely. Then refasten the belt.

Seat Belt Reminder



The seat belt system includes an indicator on the instrument panel to remind the driver or a front passenger to fasten their seat belts.

If the ignition switch is turned to ON *1 and a seat belt is not fastened, a beeper will sound and the indicator will blink. After a few seconds, the beeper will stop and the indicator will come on and remain illuminated until the seat belt is fastened.

The beeper will periodically sound and the indicator will blink while the vehicle is moving until the seat belt is fastened.

Seat Belt Reminder

The indicator will also come on if a front passenger does not fasten their seat belt within six seconds after the ignition switch is turned to ON *1. When no one is sitting in the front passenger's seat, the indicator will not come on and the beeper will not sound. The indicator also may not come on and the beeper may not sound when the occupant is not heavy enough to trigger the weight sensor. Such occupants (e.g., infants and smaller children) should be moved to the rear seat as a deploying front airbag likely will injure or kill them.

 **Protecting Child Passengers** P. 60

*1: Models with the smart entry system have an **ENGINE START/STOP** button instead of an ignition switch.

Automatic Seat Belt Tensioners

The front seats are equipped with automatic seat belt tensioners to enhance safety.

The tensioners automatically tighten the front seat belts during a moderate-to-severe frontal collision, sometimes even if the collision is not severe enough to inflate the front airbags.

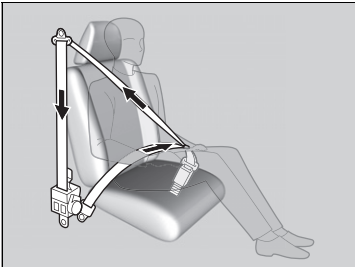

Automatic Seat Belt Tensioners

The seat belt tensioners can only operate once. If a tensioner is activated, the SRS indicator will come on. Have a dealer replace the tensioner and thoroughly inspect the seat belt system as it may not offer protection in a subsequent crash.

During a moderate-to-severe side impact, the tensioner on that side of the vehicle also activates.

Fastening a Seat Belt

After adjusting a front seat to the proper position, and while sitting upright and well back in the seat:

➤ **Adjusting the Seats** P. 171

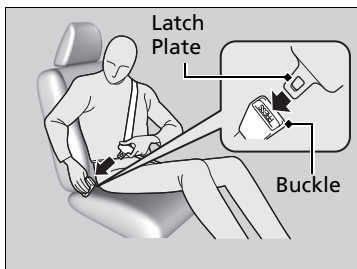
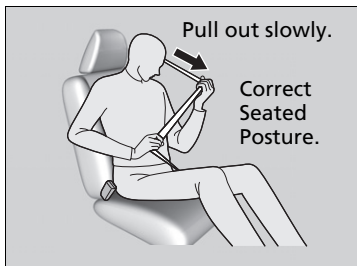

1. Pull the seat belt out slowly.

2. Insert the latch plate into the buckle, then tug on the belt to make sure the buckle is secure.

▶ Make sure that the belt is not twisted or caught on anything.

Fastening a Seat Belt

No one should sit in a seat with an inoperative seat belt or one that does not appear to be working correctly. Using a seat belt that is not working properly may not protect the occupant in a crash. Have a dealer check the belt as soon as possible.

Never insert any foreign objects into the buckle or retractor mechanism.

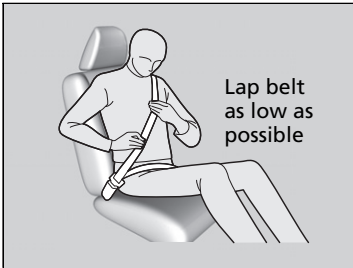

3. Position the lap part of the belt as low as possible across your hips, then pull up on the shoulder part of the belt so the lap part fits snugly. This lets your strong pelvic bones take the force of a crash and reduces the chance of internal injuries.
4. If necessary, pull up on the belt again to remove any slack, then check that the belt rests across the center of your chest and over your shoulder. This spreads the forces of a crash over the strongest bones in your upper body.

Fastening a Seat Belt

⚠ WARNING

Improperly positioning the seat belts can cause serious injury or death in a crash.

Make sure all seat belts are properly positioned before driving.

To release the belt, push the red **PRESS** button and then guide the belt by hand until it has retracted completely.

When exiting the vehicle, be sure the belt is properly stowed so that it will not get caught in the closing door.

■ Advice for Pregnant Women

If you are pregnant, the best way to protect yourself and your unborn child when driving or riding in a vehicle is to always wear a seat belt and keep the lap part of the belt as low as possible across the hips.



▣ Advice for Pregnant Women

Each time you have a checkup, ask your doctor if it is okay for you to drive.

To reduce the risk of injuries to both you and your unborn child that can be caused by an inflating front airbag:

- When driving, sit upright and adjust the seat as far back as possible while allowing full control of the vehicle.
- When sitting in the front passenger's seat, adjust the seat as far back as possible.

Seat Belt Inspection

Regularly check the condition of your seat belts as follows:

- Pull each belt out fully, and look for frays, cuts, burns, and wear.
- Check that the latch plates and buckles work smoothly and the belts retract easily.
 - ▶ If a belt does not retract easily, cleaning the belt may correct the problem. Only use a mild soap and warm water. Do not use bleach or cleaning solvents. Make sure the belt is completely dry before allowing it to retract.

Any belt that is not in good condition or working properly will not provide proper protection and should be replaced as soon as possible.

A belt that has been worn during a crash may not provide the same level of protection in a subsequent crash. Have your seat belts inspected by a dealer after any collision.

▶▶ Seat Belt Inspection

WARNING

Not checking or maintaining seat belts can result in serious injury or death if the seat belts do not work properly when needed.

Check your seat belts regularly and have any problem corrected as soon as possible.

Airbag System Components

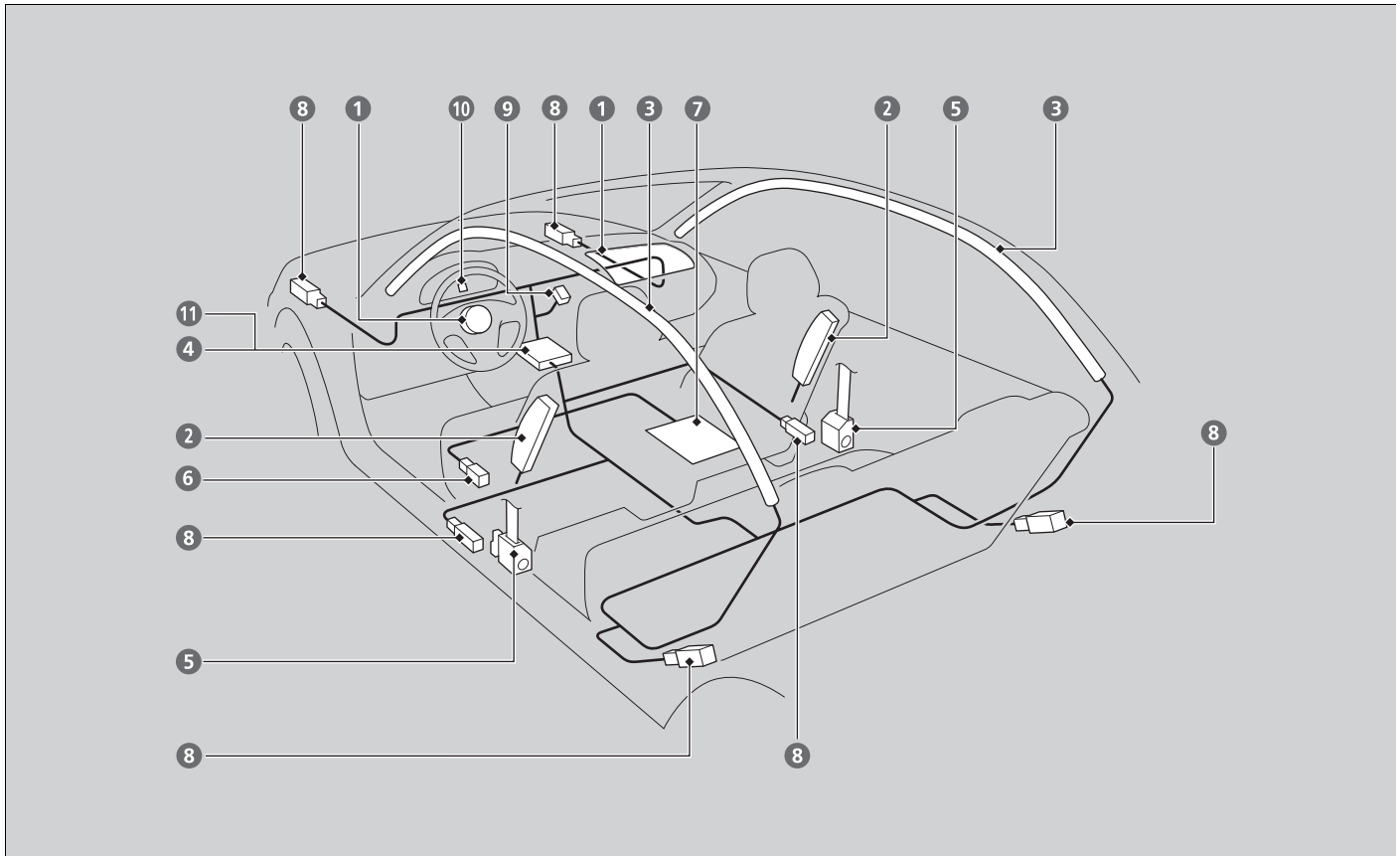

The front, front side, and side curtain airbags are deployed according to the direction and severity of impact. Both side curtain airbags are deployed in a rollover. The airbag system includes:

- 1 Two SRS (Supplemental Restraint System) front airbags. The driver's airbag is stored in the center of the steering wheel; the front passenger's airbag is stored in the dashboard. Both are marked **SRS AIRBAG**.
- 2 Two side airbags, one for the driver and one for a front passenger. The airbags are stored in the outer edges of the seat-backs. Both are marked **SIDE AIRBAG**.
- 3 Two side curtain airbags, one for each side of the vehicle. The airbags are stored in the ceiling, above the side windows. The front and rear pillars are marked **SIDE CURTAIN AIRBAG**.
- 4 An electronic control unit that, when the vehicle is on, continually monitors information about the various impact sensors, seat and buckle sensors, rollover sensor, airbag activators, seat belt tensioners, and other vehicle information. During a crash event the unit can record such information.
- 5 Automatic front seat belt tensioners. In addition, the driver's and front passenger's seat belt buckles incorporate sensors that detect whether or not the belts are fastened.
- 6 A driver's seat position sensor. This sensor determines the optimal force at which the airbag will deploy in a crash.
- 7 Weight sensors in the front passenger's seat. The front passenger's airbag will be turned off if the weight on the seat is approximately 65 lbs (29 kg) or less (the weight of an infant or small child).
- 8 Impact sensors that can detect a moderate-to-severe front impact or side impact.
- 9 An indicator on the dashboard that alerts you that the front passenger's front airbag has been turned off.
- 10 An indicator on the instrument panel that alerts you to a possible problem with your airbag system or seat belt tensioners.
- 11 A rollover sensor that can detect if your vehicle is about to roll over and signal the control unit to deploy both side curtain airbags.

■ Important Facts About Your Airbags

Airbags can pose serious hazards. To do their job, airbags must inflate with tremendous force. So, while airbags help save lives, they can cause burns, bruises, and other minor injuries, sometimes even fatal ones if occupants are not wearing their seat belts properly and sitting correctly.

What you should do: Always wear your seat belt properly, and sit upright and as far back from the steering wheel as possible while allowing full control of the vehicle. A front passenger should move their seat as far back from the dashboard as possible.

Remember, however, that no safety system can prevent all injuries or deaths that can occur in a severe crash, even when seat belts are properly worn and the airbags deploy.

Do not place hard or sharp objects between yourself and a front airbag.

Carrying hard or sharp objects on your lap, or driving with a pipe or other sharp object in your mouth, can result in injuries if your front airbag inflates.

Do not attach or place objects on the front airbag covers. Objects on the covers marked **SRS AIRBAG** could interfere with the proper operation of the airbags or be propelled inside the vehicle and hurt someone if the airbags inflate.

▣ Important Facts About Your Airbags

Do not attempt to deactivate your airbags. Together, airbags and seat belts provide the best protection.

When driving, keep hands and arms out of the deployment path of the front airbag by holding each side of the steering wheel. Do not cross an arm over the airbag cover.

Types of Airbags

Your vehicle is equipped with three types of airbags:

- **Front airbags:** Airbags in front of the driver's and front passenger's seats.
- **Side airbags:** Airbags in the driver's and front passenger's seat-backs.
- **Side curtain airbags:** Airbags above the side windows.

Each is discussed in the following pages.

Front Airbags (SRS)

The front SRS airbags inflate in a moderate-to-severe frontal collision to help protect the head and chest of the driver and/or front passenger.

SRS (Supplemental Restraint System) indicates that the airbags are designed to supplement seat belts, not replace them. Seat belts are the occupant's primary restraint system.

Housing Locations

The front airbags are housed in the center of the steering wheel for the driver, and in the dashboard for the front passenger. Both airbags are marked **SRS AIRBAG**.

*1: Models with the smart entry system have an **ENGINE START/STOP** button instead of an ignition switch.

Types of Airbags

The airbags can inflate whenever the ignition switch is in ON *1.

After an airbag inflates in a crash, you may see a small amount of smoke. This is from the combustion process of the inflator material and is not harmful. People with respiratory problems may experience some temporary discomfort. If this occurs, get out of the vehicle as soon as it is safe to do so.

Front Airbags (SRS)

During a frontal crash severe enough to cause one or both front airbags to deploy, the airbags can inflate at different rates, depending on the severity of the crash, whether or not the seat belts are latched, and/or other factors. Frontal airbags are designed to supplement the seat belts to help to reduce the likelihood of head and chest injuries in frontal crashes.

■ Operation

Front airbags are designed to inflate during moderate-to-severe frontal collisions. When the vehicle decelerates suddenly, the sensors send information to the control unit which signals one or both front airbags to inflate.

A frontal collision can be either head-on or angled between two vehicles, or when a vehicle crashes into a stationary object, such as a concrete wall.

■ How the Front Airbags Work

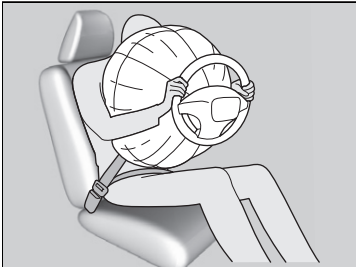

While your seat belt restrains your torso, the front airbag provides supplemental protection for your head and chest.

The front airbags deflate immediately so that they won't interfere with the driver's visibility or the ability to steer or operate other controls.

The total time for inflation and deflation is so fast that most occupants are not aware that the airbags deployed until they see them lying in front of them.

⌘ How the Front Airbags Work

Although the driver's and front passenger's airbags normally inflate within a split second of each other, it is possible for only one airbag to deploy. This can happen if the severity of a collision is at the margin, or threshold, that determines whether or not the airbags will deploy. In such cases, the seat belt will provide sufficient protection, and the supplemental protection offered by the airbag would be minimal.

■ When front airbags should not deploy

Minor frontal crashes: Front airbags were designed to supplement seat belts and help to save lives, not to prevent minor scrapes, or even broken bones that might occur during a less than moderate-to-severe frontal crash.

Side impacts: Front airbags can provide protection when a sudden deceleration causes a driver or front passenger to move towards the front of the vehicle. Side airbags and side curtain airbags have been specifically designed to help to reduce the severity of injuries that can occur during a moderate-to-severe side impact which can cause the driver or passenger to move towards the side of the vehicle.

Rear impacts: Head restraints and seat belts are your best protection during a rear impact. Front airbags cannot provide any significant protection and are not designed to deploy in such collisions.

Rollovers: In a rollover, your best form of protection is a seat belt or, if your vehicle is equipped with a rollover sensor, both a seat belt and a side curtain airbag. Front airbags, however, are not designed to deploy in a rollover as they would provide little if any protection.

■ When front airbags deploy with little or no visible damage

Because the airbag system senses sudden deceleration, a strong impact to the vehicle framework or suspension might cause one or more of the airbags to deploy. Examples include running into a curb, the edge of a hole, or other low fixed object that causes a sudden deceleration in the vehicle chassis. Since the impact is underneath the vehicle, damage may not be readily apparent.

■ When front airbags may not deploy, even though exterior damage appears severe

Since crushable body parts absorb crash energy during an impact, the amount of visible damage does not always indicate proper airbag operation. In fact, some collisions can result in severe damage but no airbag deployment because the airbags would not have been needed or would not have provided protection even if they had deployed.

■ Advanced Airbags

The airbags have advanced features to help reduce the likelihood of airbag related injuries to smaller occupants.

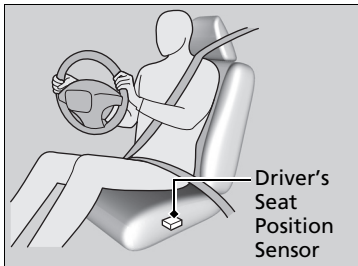

The driver's advanced airbag system includes a seat position sensor.

Based on information from this sensor and the severity of the impact, the advanced airbag system determines the optimal deployment of the driver's airbag.

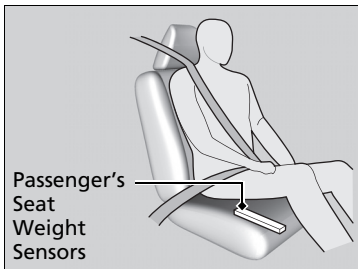

The front passenger's advanced airbag system has weight sensors.

We advise against allowing a child age 12 or under to ride in the front passenger's seat. However, ***if you do allow a child age 12 or under to ride in the front passenger's seat***, note that the system will automatically turn off the front passenger's airbag if the sensors detect that the child is approximately 65 lbs (29 kg) or less.

▣ Advanced Airbags

If there is a problem with the driver's seat position sensor, the SRS indicator will come on, and in the event of a crash, the airbag will deploy (regardless of the driver's seating position) with a force corresponding to the severity of the impact.

For the advanced airbags to work properly:

- Do not spill any liquid on or under the seats.
- Do not put any object under the passenger's seat.
- Make sure any objects are positioned properly on the floor. Improperly positioned objects can interfere with the advanced airbag sensors.
- All occupants should sit upright and wear their seat belts properly.
- Do not cover the passenger's side dashboard with a cloth, towel, cover, etc.

▣ **Passenger Front Airbag Off Indicator**
P. 58

Make sure the floor mat behind the front passenger's seat is hooked to the floor mat anchor. An improperly placed mat can interfere with the advanced airbag sensors.

▣ **Floor Mats** P. 555

Side Airbags

The side airbags help protect the torso and pelvis of the driver or a front passenger during a moderate-to-severe side impact.

Housing Locations

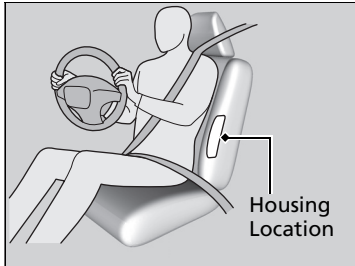

The side airbags are housed in the outside edge of the driver's and passenger's seat-backs.

Both are marked **SIDE AIRBAG**.

Operation

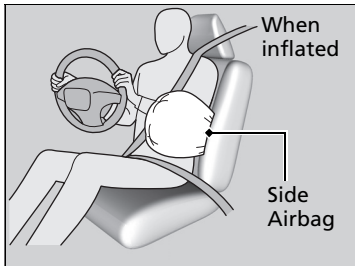

When the sensors detect a moderate-to-severe side impact, the control unit signals the side airbag on the impact side to immediately inflate.

Side Airbags

Make sure you and your front seat passenger always sit upright. Leaning into the path of a side airbag can prevent the airbag from deploying properly and increases your risk of serious injury.

Do not attach accessories on or near the side airbags. They can interfere with the proper operation of the airbags, or hurt someone if an airbag inflates.

Do not cover or replace the front seat-back covers without consulting a dealer. Improperly replacing or covering front seat-back covers can prevent your side airbags from properly deploying during a side impact.

■ **When a side airbag deploys with little or no visible damage**

Because the airbag system senses sudden acceleration, a strong impact to the side of the vehicle's framework can cause a side airbag to deploy. In such cases, there may be little or no damage, but the side impact sensors detected a severe enough impact to deploy the airbag.

■ **When a side airbag may not deploy, even though visible damage appears severe**

It is possible for a side airbag to not deploy during an impact that results in apparently severe damage. This can occur when the point of impact was toward the far front or rear of the vehicle, or when the vehicle's crushable body parts absorbed most of the crash energy. In either case, the side airbag would not have been needed nor provided protection even if it had deployed.

Side Curtain Airbags

The side curtain airbags help protect the heads of the driver and passengers in the outer seating positions during a moderate-to-severe side impact. The side curtain airbags equipped in this vehicle are also designed to help reduce the likelihood of partial and complete ejection of vehicle occupants through side windows in crashes, particularly rollover crashes.

Housing Locations

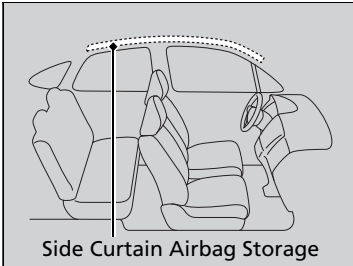

The side curtain airbags are located in the ceiling above the side windows on both sides of the vehicle.

Operation

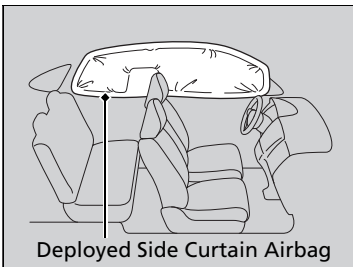

The side curtain airbag is designed to deploy in a rollover or a moderate-to-severe side impact.

Side Curtain Airbags

If the SRS control unit senses that your vehicle is about to rollover, it immediately deploys both side curtain airbags and activates both front seat belt tensioners.

If the impact is on the passenger's side, the passenger's side curtain airbag deploys even if there are no occupants on that side of the vehicle.

To get the best protection from the side curtain airbags, occupants should wear their seat belts properly and sit upright and well back in their seats.

Do not attach any objects to the side windows or roof pillars as they can interfere with the proper operation of the side curtain airbags.

■ **When side curtain airbags deploy in a frontal collision**

One or both side curtain airbags may also inflate in a moderate-to-severe angled frontal collision.

Airbag System Indicators

If a problem occurs in the airbag system, the SRS indicator will come on and a message appears on the driver information interface*.

Supplemental Restraint System (SRS) Indicator

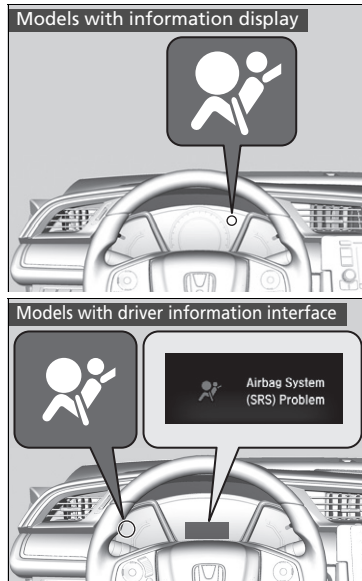

■ When the ignition switch is turned on *1

The indicator comes on for a few seconds, then goes off. This tells you the system is working properly.

If the indicator comes on at any other time, or does not come on at all, have the system checked by a dealer as soon as possible. If you don't, your airbags and seat belt tensioners may not work properly when they are needed.

*1: Models with the smart entry system have an **ENGINE START/STOP** button instead of an ignition switch.

* Not available on all models

Supplemental Restraint System (SRS) Indicator

WARNING

Ignoring the SRS indicator can result in serious injury or death if the airbag systems or tensioners do not work properly.

Have your vehicle checked by a dealer as soon as possible if the SRS indicator alerts you to a possible problem.

Continued

■ Passenger Front Airbag Off Indicator

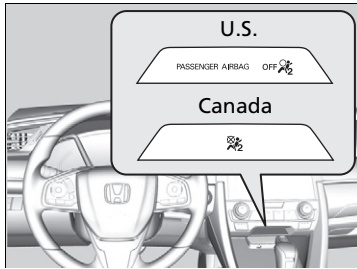

■ When the passenger front airbag off indicator comes on

The indicator comes on to alert you that the passenger's front airbag has been turned off. This occurs when the weight sensors detect about 65 lbs (29 kg) or less, the weight of an infant or small child, on the seat.

Children age 12 or under should always ride properly restrained in a back seat.

➤ **Child Safety** P. 60

If the front passenger seat is empty, the passenger's front airbag will not deploy and the indicator will come on.

☒ Passenger Front Airbag Off Indicator

To ensure the passenger is detected properly, confirm that:

- There is no child seat or other object pressing against the rear of the seat-back.
- There is no rear passenger pushing or pulling on the back of the front passenger's seat.
- The front seat or seat-back is not forced back against an object on the seat or floor behind it.
- There is no object placed under or beside the front passenger's seat.
- The occupant is sitting in an upright position and the seat back is not excessively reclined.
- The occupant is not leaning against the door or center console.
- The occupant's feet are placed on the floor in front of them.
- There are no objects hanging from the front passenger's seat.
- Only small, lightweight objects are in the seat-back pocket.

The passenger front airbag off indicator may come on and go off repeatedly if the total weight on the seat is near the airbag cutoff threshold.

Have your vehicle checked by a dealer as soon as possible if:

- All of the above conditions are met, and the indicator comes on with an adult seated in the front passenger seat.
- The seat is empty and the indicator is off.

Do not allow an adult passenger to ride in the front seat when the indicator is on.

Airbag Care

You do not need to, and should not, perform any maintenance on or replace any airbag system components yourself. However, you should have your vehicle inspected by a dealer in the following situations:

■ When the airbags have deployed

If an airbag has inflated, the control unit and other related parts must be replaced. Similarly, once an automatic seat belt tensioner has been activated, it must be replaced.

■ When the vehicle has been in a moderate-to-severe collision

Even if the airbags did not inflate, have your dealer inspect the following: the driver's seat position sensor, weight sensors in the passenger's seat, front seat belt tensioners, and each seat belt that was worn during the crash.

■ Do not remove or modify a front seat without consulting a dealer

This would likely disable or affect the proper operation of the driver's seat position sensor or the weight sensors in the passenger's seat. If it is necessary to remove or modify a front seat to accommodate a person with disabilities, contact a Honda dealer, or for U.S. vehicles, American Honda Automobile Customer Service at 1-800-999-1009 and for Canadian vehicles, Honda Canada Customer Relations at 1-888-9-HONDA-9.

✘ Airbag Care

We recommend against the use of salvaged airbag system components, including the airbag, tensioners, sensors, and control unit.

Protecting Child Passengers

Each year, many children are injured or killed in vehicle crashes because they are either unrestrained or not properly restrained. In fact, vehicle crashes are the number one cause of death of children ages 12 and under.

To reduce the number of child deaths and injuries, every state, Canadian province and territory requires that infants and children be properly restrained when they ride in a vehicle.

Children should sit properly restrained in a rear seat. This is because:

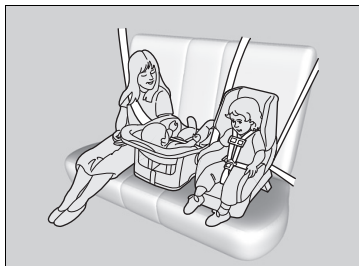

- An inflating front or side airbag can injure or kill a child sitting in the front seat.
- A child in the front seat is more likely to interfere with the driver's ability to safely control the vehicle.
- Statistics show that children of all sizes and ages are safer when they are properly restrained in a rear seat.

Protecting Child Passengers

WARNING

Children who are unrestrained or improperly restrained can be seriously injured or killed in a crash.

Any child too small for a seat belt should be properly restrained in a child seat. A larger child should be properly restrained with a seat belt, using a booster seat if necessary.

The National Highway Traffic Safety Administration and Transport Canada recommend that all children ages 12 and under be properly restrained in a rear seat. Some states or provinces/territories have laws restricting where children may ride.

- Any child who is too small to wear a seat belt correctly must be restrained in an approved child seat that is properly secured to the vehicle using either the seat belt or the lower anchors of the LATCH system.
- Never hold a child on your lap because it is impossible to protect them in the event of a collision.
- Never put a seat belt over yourself and a child. During a crash, the belt would likely press deep into the child and cause serious or fatal injuries.
- Never let two children use the same seat belt. Both children could be very seriously injured in a crash.
- Do not allow children to operate the doors, windows or seat adjustments.
- Do not leave children in the vehicle unattended, especially in hot weather when the inside of the vehicle can get hot enough to kill them. They could also activate vehicle controls causing it to move unexpectedly.

▶▶ Protecting Child Passengers

⚠ WARNING

Allowing a child to play with a seat belt or wrap one around their neck can result in serious injury or death.

Instruct children not to play with any seat belt and make sure any unused seat belt a child can reach is buckled, fully retracted, and locked.

To deactivate a lockable retractor, release the buckle and allow the seat belt to wind up all the way.

To remind you of the passenger's front airbag hazards and child safety, your vehicle has warning labels on the dashboard (U.S. models) and on the front visors. Please read and follow the instructions on these labels.

▶▶ **Safety Labels** P. 74

Safety of Infants and Small Children

■ Protecting Infants

An infant must be properly restrained in a rear-facing, reclining child seat until the infant reaches the seat manufacturer's weight or height limit for the seat, and the infant is at least one year old.

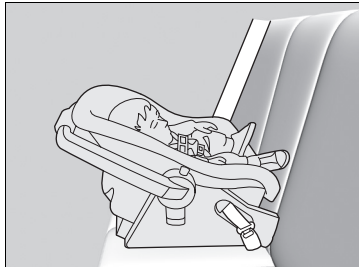

■ Positioning a rear-facing child seat

Child seats must be placed and secured in a rear seating position.

When properly installed, a rear-facing child seat may prevent the driver or a front passenger from moving their seat all the way back, or from locking their seat-back in the desired position. Make sure that there is no contact between the child seat and the seat in front of it.

It can also interfere with proper operation of the passenger's advanced front airbag system.

➤ **Airbags** P. 46

If this occurs, we recommend that you install the child seat directly behind the front passenger's seat, move the seat as far forward as needed, and leave it unoccupied. Or, you may wish to get a smaller rear-facing child seat.

▶▶ Protecting Infants

⚠ WARNING

Placing a rear-facing child seat in the front seat can result in serious injury or death during a crash.

Always place a rear-facing child seat in the rear seat, not the front.

Many experts recommend use of a rear-facing seat for a child up to two years old if the child's height and weight are appropriate for a rear-facing seat.

Rear-facing child seats should never be installed in a forward facing position.

Always refer to the child seat manufacturer's instructions before installation.

Do not allow a front seat to rest against a child seat installed in a rear seating position:
The weight sensor in the front seat may not correctly detect the actual weight of the occupant.

Protecting Smaller Children

If a child is at least one year old and within the weight range indicated by the child seat manufacturer, the child should be properly restrained in a firmly secured forward-facing child seat.

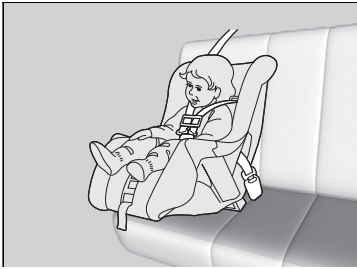

Forward-facing child seat placement

We strongly recommend placing a forward-facing child seat in a rear seating position.

Placing a forward-facing child seat in the front seat can be hazardous, even with advanced front airbags that automatically turn the passenger's front airbag off. A rear seat is the safest place for a child.

Protecting Smaller Children

⚠ WARNING

Placing a forward-facing child seat in the front seat can result in serious injury or death if the front airbag inflates.

If you must place a forward-facing child seat in front, move the vehicle seat as far back as possible, and properly restrain the child.

Educate yourself about the laws and regulations regarding child seat use where you are driving, and follow the child seat manufacturer's instructions.

■ Selecting a Child Seat

Most child seats are LATCH-compatible (Lower Anchors and Tethers for Children). Some have a rigid-type connector while others have a flexible-type connector. Both are equally easy to use. Some existing and previously owned child seats can only be installed using the seat belt. Whichever type you choose, follow the child seat manufacturer's use and care instructions as well as the instructions in this manual. Proper installation is key to maximizing your child's safety.

In seating positions and vehicles not equipped with LATCH, a LATCH-compatible child seat can be installed using the seat belt and a top tether for added security. This is because all child seats are required to be designed so that they can be secured with a lap belt or the lap part of a lap/shoulder belt. In addition, the child seat manufacturer may advise that a seat belt be used to attach a LATCH-compatible seat once a child reaches a specified weight. Please read the child seat owner's manual for proper installation instructions.

■ Important consideration when selecting a child seat

Make sure the child seat meets the following three requirements:

- The child seat is the correct type and size for the child.
- The child seat is the correct type for the seating position.
- The child seat is compliant with Federal Motor Vehicle Safety Standard 213 or Canadian Motor Vehicle Safety Standard 213.

► Selecting a Child Seat

Installation of a LATCH-compatible child seat is simple.

LATCH-compatible child seats have been developed to simplify the installation process and reduce the likelihood of injuries caused by incorrect installation.

■ Installing a LATCH-Compatible Child Seat

A LATCH-compatible child seat can be installed in either of the two outer rear seats. A child seat is attached to the lower anchors with either the rigid or flexible type of connectors.

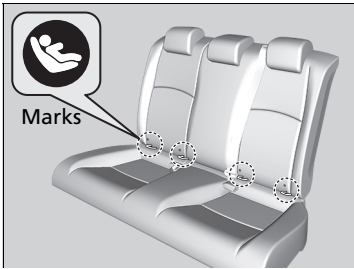

1. Locate the lower anchors under the marks.

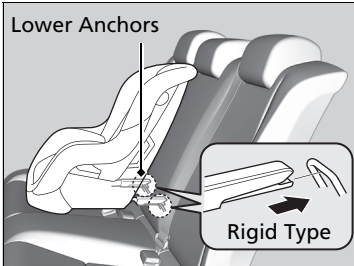

2. Place the child seat on the vehicle seat, then attach the child seat to the lower anchors according to the instructions that came with the child seat.

▶ When installing the child seat, make sure that the lower anchors are not obstructed by the seat belt or any other object.

▶▶ Installing a LATCH-Compatible Child Seat

⚠ WARNING

Never attach two child seats to the same anchor. In a collision, one anchor may not be strong enough to hold two child seat attachments and may break, causing serious injury or death.

For your child's safety, when using a child seat installed using the LATCH system, make sure that the child seat is properly secured to the vehicle. A child seat that is not properly secured will not adequately protect a child in a crash and may cause injury to the child or other vehicle occupants.

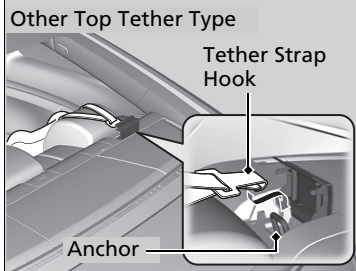
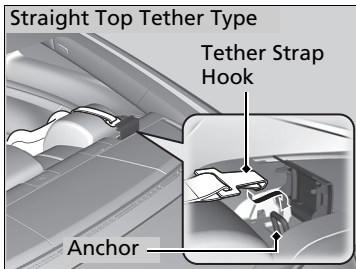
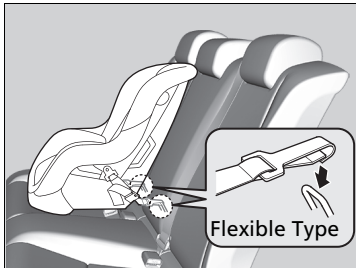

3. Open the tether anchor cover behind the head restraint.
4. Route the tether strap over the top of the head restraint and secure the tether strap hook to the anchor. Make sure the strap is not twisted.
5. Tighten the tether strap as instructed by the child seat manufacturer.
6. Make sure the child seat is firmly secured by rocking it forward and back and side to side; little movement should be felt.
7. Make sure any unused seat belt that a child can reach is buckled, the lockable retractor is activated, and the belt is fully retracted and locked.

► **Protecting Child Passengers** P. 60

► Installing a LATCH-Compatible Child Seat

⚠ WARNING

Do not use the lower inner anchors of the outer rear seats to secure a LATCH-compatible child seat to the rear center seat, unless the manufacturer's instructions for that system permit the use of inner anchors with the stated spacing.

Installing a LATCH-compatible child seat in the rear center seat

Each outer rear seat is equipped with a pair of lower anchors which are used to secure a LATCH-compatible child seat. The rear center seat, however, is not equipped with anchors of any kind. The inner and outer anchors are spaced apart at a standard distance of 11 inches (280 mm). The distance between the two inner anchors is 15.0 inches (380 mm).

LATCH-compatible restraint systems that are fitted with rigid-type attachments cannot be installed in the rear center seat. However, a system fitted with flexible-type attachments can be installed in the center seat, provided that the manufacturer's instructions for that system permit the use of the inner anchors with the stated spacing.

Before seating a child, make sure that the system is properly attached to both the lower anchors and tether anchors.

■ Installing a Child Seat with a Lap/Shoulder Seat Belt

A child seat can be installed with a lap/shoulder belt in any rear seat or, if absolutely necessary, the front passenger seat.

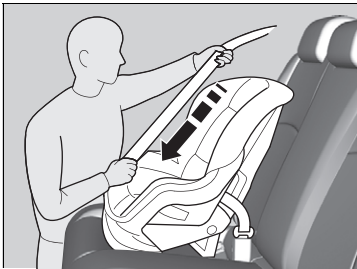

1. Place the child seat on the vehicle seat.
2. Route the seat belt through the child seat according to the seat manufacturer's instructions, and insert the latch plate into the buckle.
 - ▶ Insert the latch plate fully until it clicks.
3. Slowly pull the shoulder part of the belt all the way out until it stops. This activates the lockable retractor.
4. Let the seat belt completely wind up into the retractor, then try to pull it out to make sure the retractor is locked.
 - ▶ If you are able to pull the shoulder belt out, the lockable retractor is not activated. Pull the seat belt all the way out, and repeat steps 3 – 4.

☒ Installing a Child Seat with a Lap/Shoulder Seat Belt

A child seat that is not properly secured will not adequately protect a child in a crash and may cause injury to the child or other vehicle occupants.



5. Grab the shoulder part of the seat belt near the buckle, and pull up to remove any slack from the lap part of the belt.
 - ▶ When doing this, place your weight on the child seat and push it into the vehicle seat.

6. Make sure the child seat is firmly secured by rocking it forward and back and side to side; less than one inch of movement should occur near the seat belt.
7. Make sure any unused seat belt that a child can reach is buckled, the lockable retractor is activated, and the belt is fully retracted and locked.

✦ Installing a Child Seat with a Lap/Shoulder Seat Belt

To deactivate a lockable retractor, release the buckle and allow the seat belt to wind up all the way.

■ Adding Security with a Tether

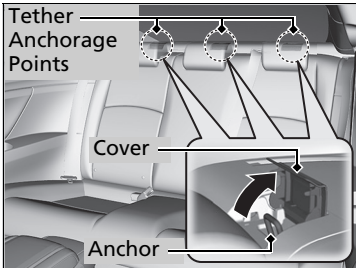

A tether anchorage point is provided behind each rear seating position. If you have a child restraint system that comes with a tether but can be installed with a seat belt, the tether may be used for additional security.

1. Locate the appropriate tether anchorage point and lift the cover.
2. Route the tether strap over the head restraint. Make sure the strap is not twisted.

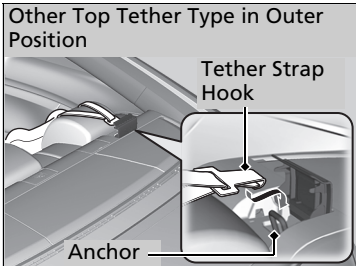
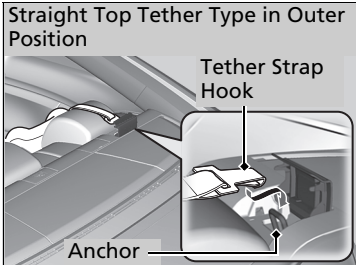

▣ Adding Security with a Tether

Always use a tether for forward facing child seats when using the seat belt or lower anchors.

Straight Top Tether Type in Center Position

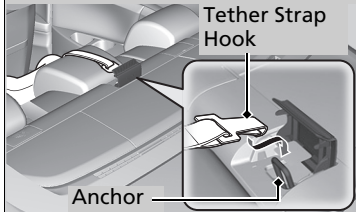

Other Top Tether Type in Center Position

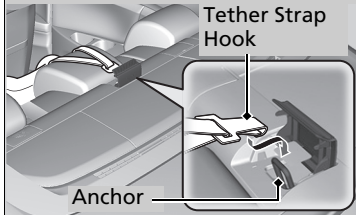

3. Secure the tether strap hook to the anchor.
4. Tighten the tether strap as instructed by the child seat manufacturer.

Safety of Larger Children

■ Protecting Larger Children

The following pages give instructions on how to check proper seat belt fit, what kind of booster seat to use if one is needed, and important precautions for a child who must sit in front.

■ Checking Seat Belt Fit

When a child is too big for a child seat, secure the child in a rear seat using the lap/shoulder seat belt. Have the child sit upright and all the way back, then answer the following questions.

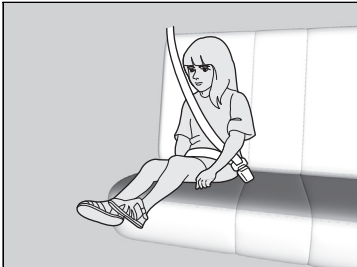

■ Checklist

- Do the child's knees bend comfortably over the edge of the seat?
- Does the shoulder belt cross between the child's neck and arm?
- Is the lap part of the seat belt as low as possible, touching the child's thighs?
- Will the child be able to stay seated like this for the whole trip?

If you answer yes to all these questions, the child is ready to wear the lap/shoulder seat belt correctly. If you answer no to any question, the child needs to ride on a booster seat until the seat belt fits properly without a booster seat.

▶▶ Safety of Larger Children

⚠ WARNING

Allowing a child age 12 or under to sit in front can result in injury or death if the passenger's front airbag inflates.

If a larger child must ride in front, move the vehicle seat as far to the rear as possible, have the child sit up properly and wear the seat belt properly, using a booster seat if needed.

Booster Seats



If a lap/shoulder seat belt cannot be used properly, position the child in a booster seat in the rear seat. For the child's safety, check that the child meets the booster seat manufacturer's recommendations.

Protecting Larger Children-Final Checks

Your vehicle has a rear seat where children can be properly restrained. If you ever have to carry a group of children, and a child must ride in front:

- Make sure you read and fully understand the instructions and safety information in this manual.
- Move the front passenger seat as far back as possible.
- Have the child sit upright and well back in the seat.
- Check that the seat belt is properly positioned so that the child is secure in the seat.

Monitoring child passengers

We strongly recommend that you keep an eye on child passengers. Even older, more mature children sometimes need to be reminded to fasten their seat belts and sit up properly.

Booster Seats

When installing a booster seat, make sure to read the instructions that came with it, and install the seat accordingly.

There are high- and low-type booster seats. Choose a booster seat that allows the child to wear the seat belt correctly.

Some U.S. states, and Canadian provinces and territories require children to use a booster seat until they reach a given age or weight (e.g. six years or 60 lbs). Be sure to check current laws in the state or province, or territory where you intend to drive.

Carbon Monoxide Gas

The engine exhaust from this vehicle contains carbon monoxide, a colorless, odorless, and highly toxic gas. As long as you properly maintain your vehicle, carbon monoxide gas will not get into the interior.

■ Have the exhaust system inspected for leaks whenever

- The exhaust system is making an unusual noise.
- The exhaust system may have been damaged.
- The vehicle is raised for an oil change.

When you operate a vehicle with the trunk open, airflow can pull exhaust gas into the interior and create a hazardous condition. If you must drive with the trunk open, open both windows and set the climate control system as shown below.

1. Select the fresh air mode.
2. Select the  mode.
3. Set the fan speed to high.
4. Set the temperature control to a comfortable setting.

Adjust the climate control system in the same manner if you sit in your parked vehicle with the engine running.

☒ Carbon Monoxide Gas

⚠ WARNING

Carbon monoxide gas is toxic.

Breathing it can cause unconsciousness and even kill you.

Avoid any enclosed areas or activities that expose you to carbon monoxide.

An enclosed area such as a garage can quickly fill up with carbon monoxide gas. Do not run the engine with the garage door closed. Even when the garage door is open, drive out of the garage immediately after starting the engine.

Label Locations

These labels are in the locations shown. They warn you of potential hazards that can cause serious injury or death. Read these labels carefully.

If a label comes off or becomes hard to read (except for the U.S. dashboard label which may be removed by the owner), contact a dealer for a replacement.

Sun Visor

U.S. models

⚠ WARNING

EVEN WITH ADVANCED AIR BAGS

- Children can be killed or seriously injured by the air bag.
- The back seat is the safest place for children.
- Never put a rear-facing child seat in the front.
- Always use seat belts and child restraints.
- See owner's manual for more information about air bags.

Canadian models

⚠ WARNING	⚠ ATTENTION
<p>To avoid serious injury</p> <ul style="list-style-type: none"> ■ For maximum safety protection in all types of crashes, you must always wear your safety belt. ■ Do not install rearward-facing child seats in any front passenger seat position. ■ Do not sit or lean unnecessarily close to the air bag. ■ Do not place any objects over the air bag or between the air bag and yourself. ■ See the owner's manual for further information and explanations. 	<p>Pour éviter des blessures graves</p> <ul style="list-style-type: none"> ■ Pour profiter d'une protection maximale lors d'une collision bouclez toujours votre ceinture de sécurité. ■ N'installez jamais un siège pour enfants faisant face à l'arrière sur le siège du passager avant. ■ Ne vous appuyez pas et ne vous assoyez pas près du coussin gonflable. ■ Ne déposez aucun objet sur le coussin gonflable et vous. ■ Lisez le guide utilisateur pour de plus amples renseignements.

Dashboard

U.S. models only

This Vehicle is Equipped with Advanced Air Bags

Even with Advanced Air Bags

Children can be killed or seriously injured by the air bags. The back seat is the safest place for children. Never put a rear-facing child seat in the front. Always use seat belts and child restraints. See owner's manual for more information about air bags.

To be removed by owner only.

DANGER WARNING

危険 危険

NEVER OPEN WHEN HOT. Hot coolant will scald you. N'ouvrez pas quand chaud. Ne s'ouvrez pas quand chaud. N'ouvrez pas quand chaud. 高温冷却液。絶対に開かない。

108kPa

Air Conditioner System

U.S. models

⚠ WARNING

Flammable Refrigerant
CAUTION SYSTEM CONTAINS REFRIGERANT R-1234yf UNDER HIGH PRESSURE. TO BE SERVICED ONLY BY QUALIFIED PERSONNEL. Follow Instructions in the service manual.

AIR CONDITIONER SYSTEM
REFRIGERANT: R-1234yf (SAE J639/J2842 J2845)
REC. CHARGE: MAX 0.425kg MIN 0.375kg
OIL TYPE: RL85HM OIL(POE)

TBA Honda Motor Co., Ltd.

Canadian models

⚠

🔥

👤

R-1234yf





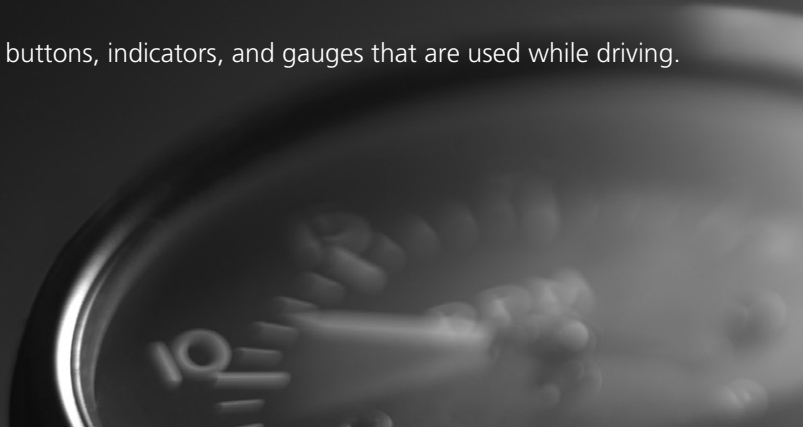

Instrument Panel

This chapter describes the buttons, indicators, and gauges that are used while driving.



Indicators	76
Information Display Warning and Information Messages*	95
Driver Information Interface Warning and Information Messages*	97
Gauges and Displays	
Gauges	109
Information Display*	111
Driver Information Interface*	114

* Not available on all models

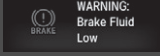
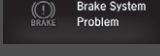
Indicator	Name	On/Blinking	Explanation	Message *
  (Red)	Parking Brake and Brake System Indicator (Red)	<ul style="list-style-type: none"> Comes on for a few seconds when you turn the ignition switch to ON ^{*1}, then goes off if the parking brake has been released. Comes on when the parking brake is applied, and goes off when it is released. Comes on when the brake fluid level is low. Comes on if there is a problem with the brake system. The beeper sounds and the indicator comes on if you drive with the parking brake not fully released. Comes on for about 15 seconds when you pull the electric parking brake switch while the ignition switch is in LOCK ^{*1}. Stays on for about 15 seconds when you turn the ignition switch to LOCK ^{*1} while the electric parking brake is set. 	<ul style="list-style-type: none"> Comes on while driving - Make sure the parking brake is released. Check the brake fluid level. <ul style="list-style-type: none"> ➤ What to do when the indicator comes on P. 593 Comes on along with the ABS indicator - Have your vehicle checked by a dealer. <ul style="list-style-type: none"> ➤ If the Brake System Indicator (Red) Comes On or Blinks P. 593 Blinks and the parking brake and brake system indicator (amber) comes on at the same time - There is a problem with the electric parking brake system. The parking brake may not be set. <p>Avoid using the parking brake and have your vehicle checked by a dealer immediately.</p> <ul style="list-style-type: none"> ➤ If the Brake System Indicator (Red) Comes On or Blinks at the Same Time When the Brake System Indicator (Amber) Comes On P. 594 	  









*1: Models with the smart entry system have an **ENGINE START/STOP** button instead of an ignition switch.

Indicator	Name	On/Blinking	Explanation	Message*
 	Parking Brake and Brake System Indicator (Amber)	<ul style="list-style-type: none"> • Comes on for a few seconds when you turn the ignition switch to ON II^{*1}, then goes off. • Comes on if there is a problem with a system related to braking other than the conventional brake system. • Comes on if there is a problem with the electric parking brake system or the automatic brake hold system. 	<ul style="list-style-type: none"> • Stays on constantly - Have your vehicle checked by a dealer. • Comes on while driving - Avoid using the parking brake and have your vehicle checked by a dealer immediately. 	



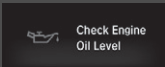

Instrument Panel

*1: Models with the smart entry system have an **ENGINE START/STOP** button instead of an ignition switch.

* Not available on all models

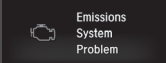
Indicator	Name	On/Blinking	Explanation	Message *
	Automatic Brake Hold System Indicator	<ul style="list-style-type: none"> Comes on for a few seconds when you turn the ignition switch to ON ^{*1}, then goes off. Comes on when the automatic brake hold system is on. 	<p>➤ Automatic Brake Hold P. 477</p>	
 	Automatic Brake Hold Indicator	<ul style="list-style-type: none"> Comes on for a few seconds when you turn the ignition switch to ON ^{*1}, then goes off. Comes on when the automatic brake hold is activated. 	<p>➤ Automatic Brake Hold P. 477</p>	—
	Low Oil Pressure Indicator	<ul style="list-style-type: none"> Comes on when you turn the ignition switch to ON ^{*1}, and goes off when the engine starts. Comes on when the engine oil pressure is low. 	<ul style="list-style-type: none"> Comes on while driving - Immediately stop in a safe place. ➤ If the Low Oil Pressure Indicator Comes On P. 591 	











*1: Models with the smart entry system have an **ENGINE START/STOP** button instead of an ignition switch.

Indicator	Name	On/Blinking	Explanation	Message*
	Malfunction Indicator Lamp	<ul style="list-style-type: none"> • Comes on when you turn the ignition switch to ON [II]*1, and goes off when the engine starts, or after several seconds if the engine did not start. If “readiness codes” have not been set, it blinks five times before it goes off. • Comes on if there is a problem with the emissions control system. • Blinks when a misfire in the engine’s cylinders is detected. 	<ul style="list-style-type: none"> • Readiness codes are part of the on board diagnostics for the emissions control systems. <ul style="list-style-type: none"> ➤ Testing of Readiness Codes P. 613 • Comes on while driving - Have your vehicle checked by a dealer. • Blinks while driving - Stop in a safe place where there are no flammable objects. Stop the engine for 10 minutes or more, and wait for it to cool down. Then, take your vehicle to a dealer. <ul style="list-style-type: none"> ➤ If the Malfunction Indicator Lamp Comes On or Blinks P. 592 	
	Charging System Indicator	<ul style="list-style-type: none"> • Comes on when you turn the ignition switch to ON [II]*1, and goes off when the engine starts. • Comes on when the battery is not charging. 	<ul style="list-style-type: none"> • Comes on while driving - Turn off the climate control system and rear defogger in order to reduce electricity consumption. <ul style="list-style-type: none"> ➤ If the Charging System Indicator Comes On P. 591 	
	Shift Lever Position Indicator*	<ul style="list-style-type: none"> • Indicates the current shift lever position. 	<ul style="list-style-type: none"> ➤ Shifting P. 422, 424 	



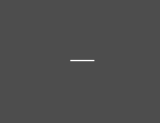



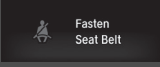
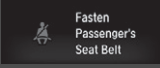



Instrument Panel

*1: Models with the smart entry system have an **ENGINE START/STOP** button instead of an ignition switch.









* Not available on all models

Indicator	Name	On/Blinking	Explanation	Message*
 	Transmission System Indicator*	<ul style="list-style-type: none"> Comes on for a few seconds when you turn the ignition switch to ON *¹, then goes off. Blinks if the transmission system has a problem. 	<ul style="list-style-type: none"> Blinks while driving - Avoid sudden starts and acceleration and have your vehicle checked by a dealer immediately. 	
	M (7-speed manual shift mode) Indicator/Shift Indicator*	<ul style="list-style-type: none"> Comes on when 7-speed manual shift mode is applied. 	<p> 7-Speed Manual Shift Mode P. 426</p>	
	Seat Belt Reminder Indicator	<ul style="list-style-type: none"> Comes on and the beeper sounds if you are not wearing a seat belt when you turn the ignition switch to ON *¹. If the front passenger is not wearing a seat belt, the indicator comes on a few seconds later. Blinks while driving if either you or the front passenger has not fastened a seat belt. The beeper sounds and the indicator blinks at regular intervals. 	<ul style="list-style-type: none"> The beeper stops and the indicator goes off when you and the front passenger fasten their seat belts. Stays on after you or the front passenger has fastened the seat belt - A detection error may have occurred in the sensor. Have your vehicle checked by a dealer. <p> Seat Belt Reminder P. 40</p>	 



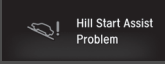
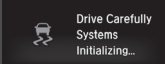

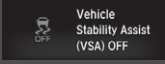
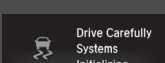

*1:Models with the smart entry system have an **ENGINE START/STOP** button instead of an ignition switch.

Indicator	Name	On/Blinking	Explanation	Message*
	Low Fuel Indicator	<ul style="list-style-type: none"> Comes on when the fuel reserve is running low (approximately 1.8 U.S. gal/7.0 Liter left). Blinks if there is a problem with the fuel gauge. 	<ul style="list-style-type: none"> Comes on - Refuel your vehicle as soon as possible. Blinks - Have your vehicle checked by a dealer. 	<div style="background-color: #333; color: white; padding: 5px; margin-bottom: 5px;">  Fuel Low </div> <div style="background-color: #333; color: white; padding: 5px;">  Fuel Gauge System Problem </div>
	Anti-lock Brake System (ABS) Indicator	<ul style="list-style-type: none"> Comes on for a few seconds when you turn the ignition switch to ON ^{*1}, then goes off. If it comes on at any other time, there is a problem with the ABS. 	<ul style="list-style-type: none"> Stays on constantly - Have your vehicle checked by a dealer. With this indicator on, your vehicle still has normal braking ability but no anti-lock function.  Anti-lock Brake System (ABS) P. 480 	<div style="background-color: #333; color: white; padding: 5px;">  Anti-Lock Brake System Problem </div>
	Supplemental Restraint System Indicator	<ul style="list-style-type: none"> Comes on for a few seconds when you turn the ignition switch to ON ^{*1}, then goes off. Comes on if a problem with any of the following is detected: <ul style="list-style-type: none"> - Supplemental restraint system - Side airbag system - Side curtain airbag system - Seat belt tensioner 	<ul style="list-style-type: none"> Stays on constantly or does not come on at all - Have your vehicle checked by a dealer. 	<div style="background-color: #333; color: white; padding: 5px;">  Airbag System (SRS) Problem </div>



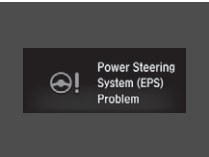

*1: Models with the smart entry system have an **ENGINE START/STOP** button instead of an ignition switch.

Indicator	Name	On/Blinking	Explanation	Message *
	Vehicle Stability Assist (VSA®) System Indicator	<ul style="list-style-type: none"> Comes on for a few seconds when you turn the ignition switch to ON *1, then goes off. Blinks when VSA® is active. Comes on if there is a problem with the VSA® system or hill start assist system. 	<ul style="list-style-type: none"> Stays on constantly - Have your vehicle checked by a dealer. <ul style="list-style-type: none">  Vehicle Stability Assist (VSA®), aka Electronic Stability Control (ESC), System P. 463 	 
		<ul style="list-style-type: none"> Comes on if the VSA® system is deactivated temporarily after the battery has been disconnected, then re-connected. 	<ul style="list-style-type: none"> Drive a short distance at more than 12 mph (20 km/h). The indicator should go off. If it does not, have your vehicle checked by a dealer. 	
	Vehicle Stability Assist (VSA®) OFF Indicator	<ul style="list-style-type: none"> Comes on for a few seconds when you turn the ignition switch to ON *1, then goes off. Comes on when you partially disable VSA®. 	<ul style="list-style-type: none">  VSA® On and Off P. 464 	
		<ul style="list-style-type: none"> Comes on if the VSA® system is deactivated temporarily after the battery has been disconnected, then re-connected. 	<ul style="list-style-type: none"> Drive a short distance at more than 12 mph (20 km/h). The indicator should go off. If it does not, have your vehicle checked by a dealer. 	







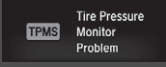
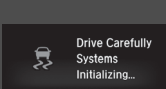

*1: Models with the smart entry system have an **ENGINE START/STOP** button instead of an ignition switch.

Indicator	Name	On/Blinking	Explanation	Message*
	Door and Trunk Open Indicator*	<ul style="list-style-type: none"> • Comes on for a few seconds if you turn the ignition switch to ON ^{*1}, then goes off. • Comes on if either door or the trunk is not completely closed. • The beeper sounds and the indicator comes on if either door or the trunk is opened while driving. 	<ul style="list-style-type: none"> • Goes off when both doors and the trunk are closed. 	
	Electric Power Steering (EPS) System Indicator	<ul style="list-style-type: none"> • Comes on when you turn the ignition switch to ON ^{*1}, and goes off when the engine starts. • Comes on if there is a problem with the EPS system. 	<ul style="list-style-type: none"> • Stays on constantly or does not come on at all - Have your vehicle checked by a dealer. <ul style="list-style-type: none"> ➤ If the Electric Power Steering (EPS) System Indicator Comes On P. 595 	
	SPORT Mode Indicator*	<ul style="list-style-type: none"> • Comes on when you press the SPORT button. • The shift up backlight remains lit up in red as long as SPORT mode is on. 	<ul style="list-style-type: none"> ➤ SPORT Mode* P. 431 	

*1: Models with the smart entry system have an **ENGINE START/STOP** button instead of an ignition switch.

Indicator	Name	On/Blinking	Explanation	Message*
	Low Tire Pressure/TPMS Indicator	<ul style="list-style-type: none"> • Comes on for a few seconds when you turn the ignition switch to ON *1. • May come on briefly if the ignition switch is turned to ON *1 and the vehicle is not moved within 45 seconds, to indicate the calibration process is not yet complete. • Comes on and stays on when: <ul style="list-style-type: none"> - One or more tires' pressures are determined to be significantly low. - The system has not been calibrated. 	<ul style="list-style-type: none"> • Comes on while driving - Stop in a safe place, check tire pressures, and inflate the tire(s) if necessary. • Stays on after the tires are inflated to the recommended pressures - The system needs to be calibrated. <ul style="list-style-type: none"> ➤ TPMS Calibration P. 469 	
		<ul style="list-style-type: none"> • Blinks for about one minute, and then stays on if there is a problem with the TPMS, or when a compact spare tire* is temporarily installed. 	<ul style="list-style-type: none"> • Blinks and remains on - Have your vehicle checked by a dealer. If the vehicle is fitted with a compact spare, get your regular tire repaired or replaced and put back on your vehicle as soon as you can. 	
		<ul style="list-style-type: none"> • Comes on if the TPMS is deactivated temporarily after the battery has been disconnected, then re-connected. 	<ul style="list-style-type: none"> • Drive a short distance at more than 12 mph (20 km/h). The indicator should go off. If it does not, have your vehicle checked by a dealer. 	

*1: Models with the smart entry system have an **ENGINE START/STOP** button instead of an ignition switch.

Indicator	Name	On/Blinking	Explanation	Message*
	System Message Indicator*	<ul style="list-style-type: none"> Comes on for a few seconds when you turn the ignition switch to ON II*¹, then goes off. Comes on along with a beep when a problem is detected. A system message on the driver information interface appears at the same time. 	<ul style="list-style-type: none"> While the indicator is on, press the  (display/information) button to see the message again. Refer to the Indicators information in this chapter when a system message appears on the driver information interface. Take the appropriate action for the message. The driver information interface does not return to the normal screen unless the warning is canceled, or the  button is pressed. 	—
	Turn Signal and Hazard Warning Indicators	<ul style="list-style-type: none"> Blink when you operate the turn signal lever. Blink along with all turn signals when you press the hazard warning button. 	<ul style="list-style-type: none"> Does not blink or blinks rapidly - A turn signal light bulb has blown. Change the bulb immediately.  Replacing Light Bulbs P. 531, 534 	—
	High Beam Indicator	<ul style="list-style-type: none"> Comes on when the high beam headlights are on. 	—	—
	Lights On Indicator	<ul style="list-style-type: none"> Comes on whenever the light switch is on, or in AUTO when the exterior lights are on. 	<ul style="list-style-type: none"> If you remove the key from the ignition switch*¹ while the exterior lights are on, a chime sounds when the driver's door is opened. 	—
	Fog Light Indicator*	<ul style="list-style-type: none"> Comes on when the fog lights are on. 	—	—

*1:Models with the smart entry system have an **ENGINE START/STOP** button instead of an ignition switch.

* Not available on all models

Continued

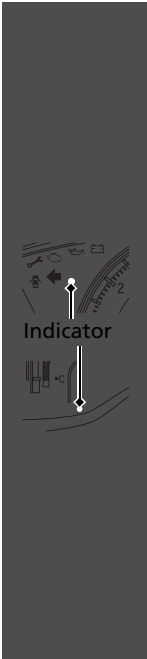
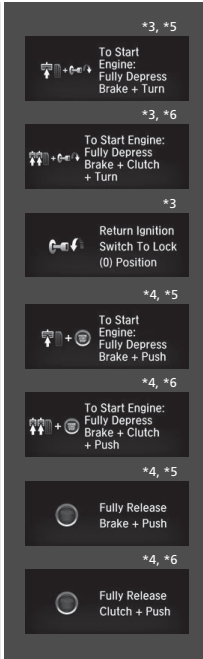
Indicator	Name	On/Blinking	Explanation	Message *
	<p>Immobilizer System Indicator</p>	<ul style="list-style-type: none"> Blinks if the immobilizer system cannot recognize the key information. 	<ul style="list-style-type: none"> Blinks - You cannot start the engine. Turn the ignition switch to LOCK 0^{*1}, pull the key out^{*2}, and then insert the key and turn it to ON II^{*1} again. 	

*1: Models with the smart entry system have an **ENGINE START/STOP** button instead of an ignition switch.





*2: Canadian models only: Apply and hold the brake pedal before turning the ignition on.

*3: Canadian models without smart entry system



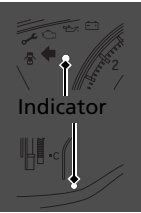
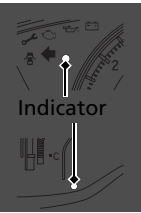

*4: Canadian models with smart entry system

*5: Continuously variable transmission models



*6: Manual transmission models

Indicator	Name	On/Blinking	Explanation	Message*
	Immobilizer System Indicator	<ul style="list-style-type: none"> Blinks if the immobilizer system cannot recognize the key information. 	<ul style="list-style-type: none"> Repeatedly blinks - The system may be malfunctioning. Have your vehicle checked by a dealer. Do not attempt to alter this system or add other devices to it. Electrical problems can occur. 	—
	Security System Alarm Indicator	<ul style="list-style-type: none"> Blinks when the security system alarm has been set. 	<p>➤ Security System Alarm P. 148</p>	—
	ECON Mode Indicator*	<ul style="list-style-type: none"> Comes on when you press the ECON button. 	<p>➤ ECON Button* P. 432</p>	
	CRUISE MAIN Indicator*	<ul style="list-style-type: none"> Comes on when you press the CRUISE button. 	<p>➤ Cruise Control* P. 433</p>	—
	CRUISE CONTROL Indicator*	<ul style="list-style-type: none"> Comes on if you have set a speed for cruise control. 	<p>➤ Cruise Control* P. 433</p>	—







* Not available on all models

Indicator	Name	On/Blinking	Explanation	Message*
	Maintenance Minder Indicator*	<ul style="list-style-type: none"> Comes on for a few seconds when you turn the ignition switch to ON ^{*1}, then goes off. Comes on when the scheduled maintenance is due soon. 	 Maintenance Minder™ P. 503	—
	Smart Entry System Indicator*	<ul style="list-style-type: none"> Comes on for a few seconds when you set the power mode to ON, then goes off. Comes on as soon as a problem is detected in the smart entry system or push button starting system. 	<ul style="list-style-type: none"> Stays on constantly or does not come on at all - Have your vehicle checked by a dealer. 	—
	Starter System Indicator*	<ul style="list-style-type: none"> Comes on for a few seconds when you set the power mode to ON, then goes off. Comes on if the starter system has a problem. 	<ul style="list-style-type: none"> As a temporary measure, press and hold the ENGINE START/STOP button for up to 15 seconds while pressing the brake pedal and manually start the engine. Have your vehicle checked by a dealer. 	—







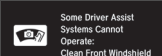

*1: Models with the smart entry system have an **ENGINE START/STOP** button instead of an ignition switch.

Indicator	Name	On/Blinking	Explanation	Message*
<div data-bbox="113 344 217 426" style="border: 1px solid black; padding: 2px; margin-bottom: 10px;">Continuously variable transmission models</div>  <div data-bbox="113 535 217 602" style="border: 1px solid black; padding: 2px; margin-bottom: 10px;">Manual transmission models</div> 	Brake Depressing Indicator*	<ul style="list-style-type: none"> Comes on for a few seconds when you turn the ignition switch to ON *1, then goes off. <div data-bbox="440 316 730 337" style="background-color: #444; color: white; padding: 2px;">Electric Parking Brake System</div> <ul style="list-style-type: none"> Blinks when the electric parking brake switch is pressed without depressing the brake pedal while the electric parking brake is in operation. 	<ul style="list-style-type: none"> Blinks while driving - Press the electric parking brake switch with the brake pedal depressed. <ul style="list-style-type: none"> ➤ Parking Brake P. 474 	—
		<div data-bbox="440 512 730 533" style="background-color: #444; color: white; padding: 2px;">Automatic Brake Hold System</div> <ul style="list-style-type: none"> Blinks when the automatic brake hold button is pressed without depressing the brake pedal while the automatic brake hold is in operation. Blinks if the automatic brake hold is automatically canceled while it is in operation. The beeper sounds. 	<ul style="list-style-type: none"> Blinks while driving - Press the automatic brake hold button with the brake pedal depressed. <ul style="list-style-type: none"> ➤ Automatic Brake Hold P. 477 Immediately depress the brake pedal. 	

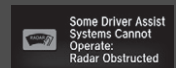
*1: Models with the smart entry system have an **ENGINE START/STOP** button instead of an ignition switch.







Indicator	Name	On/Blinking	Explanation	Message*
	Road Departure Mitigation (RDM) Indicator*	<ul style="list-style-type: none"> • Comes on for a few seconds when you turn the ignition switch to ON *¹, then goes off. • Comes on if there is a problem with the RDM system. 	<ul style="list-style-type: none"> • Stays on constantly - Have your vehicle checked by a dealer. 	
		<ul style="list-style-type: none"> • Comes on when the RDM system shuts itself off. 	<ul style="list-style-type: none"> • Stays on - The temperature inside the camera is too high. Use the climate control system to cool down the camera. The system activates when the temperature inside the camera cools down.  Front Sensor Camera* P. 436 	
			<ul style="list-style-type: none"> • Stays on - The area around the camera is blocked by dirt, mud, etc. Stop your vehicle in a safe place, and wipe it off with a soft cloth. • Have your vehicle checked by a dealer if the indicator and message come back on after you cleaned the area around the camera.  Front Sensor Camera* P. 436 	

*1: Models with the smart entry system have an **ENGINE START/STOP** button instead of an ignition switch.



Indicator	Name	On/Blinking	Explanation	Message*
ACC	Adaptive Cruise Control (ACC) with Low Speed Follow (LSF) Indicator (Amber)*	<ul style="list-style-type: none"> Comes on for a few seconds when you turn the ignition switch to ON *1, then goes off. Comes on if there is a problem with ACC with LSF. 	<ul style="list-style-type: none"> Comes on while driving - Have your vehicle checked by a dealer. 	
		<ul style="list-style-type: none"> Comes on if anything covers the radar sensor cover and prevents the sensor from detecting a vehicle in front. May come on when driving in bad weather (rain, snow, fog, etc.) ACC with LSF has been automatically canceled. 	<ul style="list-style-type: none"> When the radar sensor gets dirty, stop your vehicle in a safe place, and wipe off dirt using a soft cloth. Have your vehicle checked by a dealer if the indicator does not go off even after you clean the sensor cover. 	
ACC	Adaptive Cruise Control (ACC) with Low Speed Follow (LSF) Indicator (Green)*	<ul style="list-style-type: none"> Comes on when you press the MAIN button. 	<ul style="list-style-type: none">  Adaptive Cruise Control (ACC) with Low Speed Follow (LSF)* P. 438 	
		<ul style="list-style-type: none"> Comes on when ACC with LSF is in operation, but the temperature inside the front sensor camera is too high. ACC with LSF cancels automatically. The beeper sounds simultaneously. 	<ul style="list-style-type: none"> Use the climate control system to cool down the camera. Goes off - The camera has been cooled down. Pressing the MAIN button can resume the system. <ul style="list-style-type: none">  Front Sensor Camera* P. 436  Adaptive Cruise Control (ACC) with Low Speed Follow (LSF)* P. 438 	

*1: Models with the smart entry system have an **ENGINE START/STOP** button instead of an ignition switch.

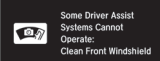
* Not available on all models

Indicator	Name	On/Blinking	Explanation	Message*
LKAS	Lane Keeping Assist System (LKAS) Indicator (Amber)*	<ul style="list-style-type: none"> Comes on for a few seconds when you turn the ignition switch to ON *¹, then goes off. Comes on if there is a problem with the LKAS. 	<ul style="list-style-type: none"> Stays on constantly - Have your vehicle checked by a dealer. 	
LKAS	Lane Keeping Assist System (LKAS) Indicator (Green)*	<ul style="list-style-type: none"> Comes on when you press the MAIN button. 	<ul style="list-style-type: none">  Lane Keeping Assist System (LKAS)* P. 456 	
		<ul style="list-style-type: none"> Comes on when the LKAS is in operation, or the LKAS button is pressed, but the temperature inside the front sensor camera is too high. The LKAS cancels automatically. The beeper sounds simultaneously. 	<ul style="list-style-type: none"> Use the climate control system to cool down the camera. Goes off - The camera has cooled down and the system is working normally.  Front Sensor Camera* P. 436 	
		<ul style="list-style-type: none"> Comes on when the area around the camera is blocked by dirt, mud, etc. Stop your vehicle in a safe place, and wipe it off with a soft cloth. May come on when driving in bad weather (rain, snow, fog, etc.) 	<ul style="list-style-type: none"> Have your vehicle checked by a dealer if the indicator and message come back on after you cleaned the area around the camera. 	







*1: Models with the smart entry system have an **ENGINE START/STOP** button instead of an ignition switch.

Indicator	Name	On/Blinking	Explanation	Message*
	Collision Mitigation Braking System™ (CMBS™) Indicator*	<ul style="list-style-type: none"> • Comes on for a few seconds when you turn the ignition switch to ON *¹, then goes off. • Comes on when you deactivate the CMBS™. A driver information interface message appears for five seconds. • Comes on if there is a problem with the CMBS™. • Comes on if the CMBS™ is deactivated temporarily after the battery has been disconnected, then re-connected. 	<ul style="list-style-type: none"> • Stays on constantly without the CMBS™ off - Have your vehicle checked by a dealer. <ul style="list-style-type: none"> ➤ Collision Mitigation Braking System™ (CMBS™)* P. 482 • Drive a short distance at more than 12 mph (20 km/h). The indicator should go off. If it does not, have your vehicle checked by a dealer. 	

Instrument Panel

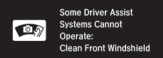
*1: Models with the smart entry system have an **ENGINE START/STOP** button instead of an ignition switch.

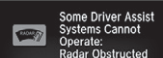
* Not available on all models

Indicator	Name	On/Blinking	Explanation	Message *
	Collision Mitigation Braking System™ (CMBS™) Indicator*	<ul style="list-style-type: none"> Comes on when the CMBS™ shuts itself off. 	<ul style="list-style-type: none"> Stays on - The area around the camera is blocked by dirt, mud, etc. Stop your vehicle in a safe place, and wipe it off with a soft cloth.  Front Sensor Camera* P. 436 	
			<ul style="list-style-type: none"> When the radar sensor gets dirty, stop your vehicle in a safe place, and wipe off dirt using a soft cloth. Have your vehicle checked by a dealer if the indicator does not go off even after you clean the sensor cover.  Collision Mitigation Braking System™ (CMBS™)* P. 482 	
			<ul style="list-style-type: none"> Stays on - The temperature inside the camera is too high. Use the climate control system to cool down the camera. The system activates when the temperature inside the camera cools down.  Front Sensor Camera* P. 436 	





Information Display Warning and Information Messages*

The following messages appear only on the information display.

Message	Condition	Explanation
	<ul style="list-style-type: none"> • Appears when there is a problem with the sensor on the battery. 	<ul style="list-style-type: none"> • Stays on constantly - Have your vehicle checked by a dealer.





* Not available on all models

Models with smart entry system



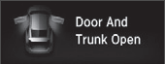

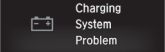



Message	Condition	Explanation
	<ul style="list-style-type: none"> Appears if you push the ENGINE START/STOP button to turn the engine off without the shift lever in P. 	<ul style="list-style-type: none"> Move the shift lever to P. The power mode changes to VEHICLE OFF.
	<ul style="list-style-type: none"> Appears when the power mode is in ACCESSORY. 	—
	<ul style="list-style-type: none"> Appears when you close the door with the power mode in ON without the smart entry remote inside the vehicle. 	<ul style="list-style-type: none"> Disappears when you bring the smart entry remote back inside the vehicle and close the door.
	<ul style="list-style-type: none"> Appears when the smart entry remote battery becomes weak. 	<ul style="list-style-type: none"> Replace the battery as soon as possible. <ul style="list-style-type: none"> ► Replacing the Button Battery P. 551

Driver Information Interface Warning and Information Messages*





The following messages appear only on the driver information interface. Press the  (display/information) button to see the message again with the system message indicator on.

Message	Condition	Explanation
 <p>Door And Trunk Open</p>	<ul style="list-style-type: none"> • Appears if either door or the trunk is not completely closed. • Appears if either door or the trunk is opened while driving. The beeper sounds. 	<ul style="list-style-type: none"> • Goes off when both doors and the trunk are closed.
<p>Canadian models</p>  <p>Washer Fluid Low</p>	<ul style="list-style-type: none"> • Appears when the washer fluid gets low. 	<ul style="list-style-type: none"> • Refill the washer fluid. <ul style="list-style-type: none"> ▶ Refilling Window Washer Fluid P. 526
 <p>Maintenance Due Soon A 1 2 3 4 5</p>	<ul style="list-style-type: none"> • Appears when the scheduled maintenance is due soon. • Consequently, Maintenance Due Now and Maintenance Past Due follow. 	<ul style="list-style-type: none"> ▶ Maintenance Minder Messages on the Driver Information Interface P. 508
 <p>Charging System Problem</p>	<ul style="list-style-type: none"> • Appears when there is a problem with the sensor on the battery. • Appears along with the battery charging system indicator when the battery is not charging. 	<ul style="list-style-type: none"> • Have your vehicle checked by a dealer. <ul style="list-style-type: none"> ▶ Checking the Battery P. 549 • Turn off the climate control system and rear defogger to reduce electricity consumption. <ul style="list-style-type: none"> ▶ If the Charging System Indicator Comes On P. 591
 <p>Stop Driving When Safe Engine Temperature Too Hot</p>	<ul style="list-style-type: none"> • Appears when the engine coolant temperature gets abnormally high. 	<ul style="list-style-type: none"> ▶ Overheating P. 589

* Not available on all models

Message	Condition	Explanation
 Fasten Seat Belt	<ul style="list-style-type: none"> Appears when you turn the ignition switch to ON *1 without fastening the driver's seat belt. 	<ul style="list-style-type: none"> Fasten the seat belt properly before you start to drive.
Continuously variable transmission models  Brake Hold Disabled Apply Brake Pedal Manual transmission models  Brake Hold Disabled Apply Brake Pedal	<ul style="list-style-type: none"> Appears if the automatic brake hold is automatically canceled while it is in operation. 	<ul style="list-style-type: none"> Immediately depress the brake pedal.
 BRAKE HOLD System OFF	<ul style="list-style-type: none"> Appears when the automatic brake hold system is turned off. 	<ul style="list-style-type: none">  Automatic Brake Hold P. 477
 To Enable Brake Hold: Seat Belt + Push	<ul style="list-style-type: none"> Appears when the automatic brake hold button is pressed without wearing the driver's seat belt. 	<ul style="list-style-type: none"> Fasten the driver's seat belt.  Automatic Brake Hold P. 477





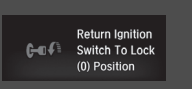
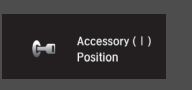
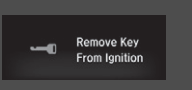

*1:Models with the smart entry system have an **ENGINE START/STOP** button instead of an ignition switch.

Message	Condition	Explanation
<div style="border: 1px solid black; padding: 5px; margin-bottom: 5px;"> Continuously variable transmission models  To Disable Brake Hold: Brake + Push </div> <div style="border: 1px solid black; padding: 5px;"> Manual transmission models  To Disable Brake Hold: Brake + Push </div>	<ul style="list-style-type: none"> • Appears when the automatic brake hold button is pressed without depressing the brake pedal while the automatic brake hold is in operation. 	<ul style="list-style-type: none"> • Press the automatic brake hold button with the brake pedal depressed. ➤ Automatic Brake Hold P. 477
<div style="border: 1px solid black; padding: 5px; text-align: center;">  Parking Brake Engaged </div>	<ul style="list-style-type: none"> • Appears when the parking brake is applied automatically while it is in operation. 	<ul style="list-style-type: none"> ➤ Automatic Brake Hold P. 477 ➤ Parking Brake P. 474
<div style="border: 1px solid black; padding: 5px; margin-bottom: 5px;"> Continuously variable transmission models  To Release Parking Brake: Brake + Push </div> <div style="border: 1px solid black; padding: 5px;"> Manual transmission models  To Release Parking Brake: Brake + Push </div>	<ul style="list-style-type: none"> • Appears when the electric parking brake switch is pressed without depressing the brake pedal while the electric parking brake is in operation. 	<ul style="list-style-type: none"> • Press the electric parking brake switch with the brake pedal depressed. ➤ Parking Brake P. 474





Models without smart entry system

Message	Condition	Explanation
 <p>Return Ignition Switch To Lock (0) Position</p>	<ul style="list-style-type: none"> Appears when you open the driver's door while the ignition key is in ACCESSORY I. 	<ul style="list-style-type: none"> Turn the ignition switch to LOCK 0, then remove the key.
 <p>Accessory (I) Position</p>	<ul style="list-style-type: none"> Appears when the ignition key is turned to ACCESSORY I from ON II. (The driver's door is closed.) 	—
 <p>Remove Key From Ignition</p>	<ul style="list-style-type: none"> Appears when you open the driver's door while the ignition key is in LOCK 0. 	<ul style="list-style-type: none"> Remove the key from the ignition switch.

Models with smart entry system

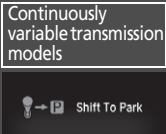
Message	Condition	Explanation
<p>Continuously variable transmission models</p>  +  To Start Engine: Brake + Push <p>Manual transmission models</p>  +  To Start Engine: Clutch + Push	<ul style="list-style-type: none"> • Appears after you set the power mode to ACCESSORY or ON. 	<p> Starting the Engine P. 415</p>
<p>Except U.S. models with continuously variable transmission</p>  +  To Unlock Wheel: Push + Rotate	<ul style="list-style-type: none"> • Appears when the steering wheel is locked. 	<ul style="list-style-type: none"> • Move the steering wheel left and right while pressing the ENGINE START/STOP button.

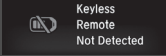
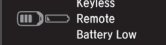
Models with smart entry system

Message	Condition	Explanation
 <p>Continuously variable transmission models</p> <p>Shift To Park</p>	<ul style="list-style-type: none"> Appears if you push the ENGINE START/STOP button to turn the engine off without the shift lever in P. 	<p>U.S. models</p> <ul style="list-style-type: none"> Move the shift lever to P. The power mode changes to VEHICLE OFF. <p>Canadian models</p> <ul style="list-style-type: none"> Move the shift lever to P, then press the ENGINE START/STOP button twice.
 <p>Accessory Mode</p>	<ul style="list-style-type: none"> Appears when the power mode is in ACCESSORY. 	—
 <p>To Switch Vehicle OFF: Push Twice</p>	<ul style="list-style-type: none"> Appears after the driver's door is opened when the power mode is in ACCESSORY. 	<ul style="list-style-type: none"> Press the ENGINE START/STOP button twice with your foot off the brake pedal (continuously variable transmission) or the clutch pedal (manual transmission) to change the power mode to VEHICLE OFF (LOCK).
 <p>Keyless Remote Not Detected</p>	<ul style="list-style-type: none"> Appears when you close the door with the power mode in ON without the smart entry remote inside the vehicle. 	<ul style="list-style-type: none"> Disappears when you bring the smart entry remote back inside the vehicle and close the door. <ul style="list-style-type: none"> ➤ Smart Entry Remote Reminder P. 158
 <p>Keyless Remote Battery Low</p>	<ul style="list-style-type: none"> Appears when the smart entry remote battery becomes weak. 	<ul style="list-style-type: none"> Replace the battery as soon as possible. <ul style="list-style-type: none"> ➤ Replacing the Button Battery P. 551
 <p>To Start, Hold Remote Near Start Button</p>	<ul style="list-style-type: none"> Appears if the smart entry remote battery is too weak to start the engine or the key is not within operating range to start the engine. A beeper sounds six times. 	<ul style="list-style-type: none"> Bring the smart entry remote in front of the ENGINE START/STOP button to be touched with. <ul style="list-style-type: none"> ➤ If the Smart Entry Remote Battery is Weak P. 583

Models with smart entry system

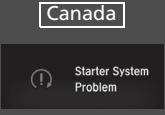
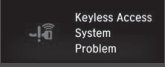
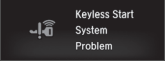
Message	Condition	Explanation
 <p>U.S. Starter System Problem</p>	<ul style="list-style-type: none"> Appears when the starter system has a problem. 	<ul style="list-style-type: none"> As a temporary measure, press and hold the ENGINE START/STOP button for up to 15 seconds while pressing the brake pedal and clutch pedal (manual transmission only), and manually start the engine. Have your vehicle checked by a dealer.
 <p>Canada Starter System Problem</p>		
 <p>Keyless Access System Problem</p>	<ul style="list-style-type: none"> Appears as soon as a problem is detected in the smart entry system or push button starting system. 	<ul style="list-style-type: none"> Appears constantly - Have your vehicle checked by a dealer.
 <p>Keyless Start System Problem</p>		

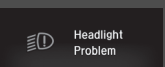

Models with LED headlights

Message	Condition	Explanation
 <p>Headlight Problem</p>	<ul style="list-style-type: none"> Appears if there is a problem with the headlights. 	<ul style="list-style-type: none"> Appears while driving - The headlights may not be on. When conditions allow you to drive safely, have your vehicle checked by a dealer as soon as possible.

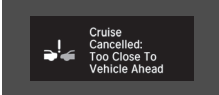
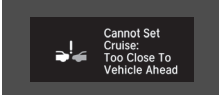
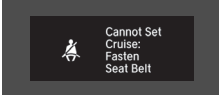
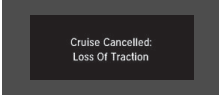
Models with ACC with LSF

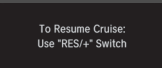
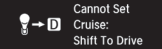
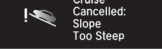
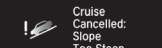
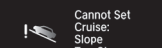
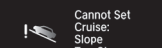

Message	Condition	Explanation
	<ul style="list-style-type: none"> Appears when ACC with LSF has been automatically canceled. 	<ul style="list-style-type: none"> You can resume the set speed after the condition that caused ACC with LSF to cancel improves. Press the RES/+ button. <ul style="list-style-type: none"> ► Adaptive Cruise Control (ACC) with Low Speed Follow (LSF)* P. 438
	<ul style="list-style-type: none"> Appears when the distance between your vehicle and the vehicle ahead of you is too close while ACC with LSF is in operation. 	<ul style="list-style-type: none"> ACC with LSF has been automatically canceled. <ul style="list-style-type: none"> ► Adaptive Cruise Control (ACC) with Low Speed Follow (LSF)* P. 438
	<ul style="list-style-type: none"> Appears when pressing the -/SET button while the distance between your vehicle and the vehicle ahead of you is too close. 	<ul style="list-style-type: none"> ACC with LSF cannot be set. <ul style="list-style-type: none"> ► Adaptive Cruise Control (ACC) with Low Speed Follow (LSF)* P. 438
	<ul style="list-style-type: none"> Appears when pressing the -/SET button while the driver's seat belt is unfastened. 	<ul style="list-style-type: none"> ACC with LSF cannot be set. <ul style="list-style-type: none"> ► Adaptive Cruise Control (ACC) with Low Speed Follow (LSF)* P. 438
	<ul style="list-style-type: none"> Appears if the VSA® or traction control function operates while ACC with LSF is in operation. 	<ul style="list-style-type: none"> ACC with LSF has been automatically canceled. <ul style="list-style-type: none"> ► Adaptive Cruise Control (ACC) with Low Speed Follow (LSF)* P. 438

Models with ACC with LSF

Message	Condition	Explanation		
	<ul style="list-style-type: none"> Appears when the vehicle in front of you starts moving while your vehicle is stopped automatically by ACC with LSF. 	<ul style="list-style-type: none"> Either press the RES/+ button or -/SET button, or depress the accelerator pedal. <ul style="list-style-type: none"> ► Adaptive Cruise Control (ACC) with Low Speed Follow (LSF)* P. 438 		
	<ul style="list-style-type: none"> Appears when pressing the -/SET button while the shift lever is in any position other than D or S. 	<ul style="list-style-type: none"> ACC with LSF cannot be set. <ul style="list-style-type: none"> ► Adaptive Cruise Control (ACC) with Low Speed Follow (LSF)* P. 438 		
	<ul style="list-style-type: none"> Appears when the vehicle is stopped on a very steep slope while ACC with LSF is in operation. 	<ul style="list-style-type: none"> ACC with LSF has been automatically canceled. <ul style="list-style-type: none"> ► Adaptive Cruise Control (ACC) with Low Speed Follow (LSF)* P. 438 		
				<ul style="list-style-type: none"> Appears when pressing the -/SET button while the vehicle is stopped on a very steep slope.
	<ul style="list-style-type: none"> Appears when pressing the -/SET button while the vehicle is stopped on a very steep slope. 	<ul style="list-style-type: none"> ACC with LSF cannot be set. <ul style="list-style-type: none"> ► Adaptive Cruise Control (ACC) with Low Speed Follow (LSF)* P. 438 		
				

* Not available on all models

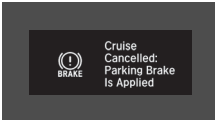
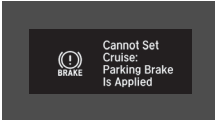
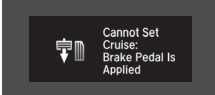
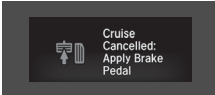
Models with ACC with LSF

Message	Condition	Explanation
	<ul style="list-style-type: none"> Appears when the parking brake is applied automatically while ACC with LSF is in operation. 	<ul style="list-style-type: none"> ACC with LSF has been automatically canceled. <ul style="list-style-type: none"> ➤ Adaptive Cruise Control (ACC) with Low Speed Follow (LSF)* P. 438 ➤ Parking Brake P. 474
	<ul style="list-style-type: none"> Appears when pressing the –/SET button while the parking brake is applied. 	<ul style="list-style-type: none"> ACC with LSF cannot be set. <ul style="list-style-type: none"> ➤ Adaptive Cruise Control (ACC) with Low Speed Follow (LSF)* P. 438 ➤ Parking Brake P. 474
	<ul style="list-style-type: none"> Appears when pressing the –/SET button while the vehicle is moving and the brake pedal is depressed. 	<ul style="list-style-type: none"> ACC with LSF cannot be set. <ul style="list-style-type: none"> ➤ Adaptive Cruise Control (ACC) with Low Speed Follow (LSF)* P. 438
	<ul style="list-style-type: none"> Appears if ACC with LSF is canceled while your vehicle is automatically stopped by ACC with LSF. 	<ul style="list-style-type: none"> Immediately depress the brake pedal.
	<ul style="list-style-type: none"> Flashes when the system senses a likely collision with a vehicle in front of you. 	<ul style="list-style-type: none"> Take the appropriate means to prevent a collision (apply the brakes, change lanes, etc.) <ul style="list-style-type: none"> ➤ Collision Mitigation Braking System™ (CMBS™)* P. 482 ➤ Adaptive Cruise Control (ACC) with Low Speed Follow (LSF)* P. 438

Models with LKAS

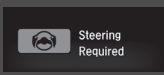
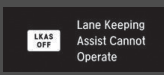

Message	Condition	Explanation
	<p>Lane Keeping Assist System (LKAS)</p> <ul style="list-style-type: none"> • Appears when the vehicle is driving out of a detected line. The steering wheel vibrates rapidly. <p>Road Departure Mitigation (RDM) System</p> <ul style="list-style-type: none"> • Appears when the vehicle is driving out of a detected lane. <p>When you selected Warning Only</p> <ul style="list-style-type: none"> - The steering wheel vibrates rapidly when the vehicle is drifting out of a detected lane. <p>When you selected Normal or Wide</p> <ul style="list-style-type: none"> - The steering wheel vibrates rapidly when the vehicle is drifting out of a detected line. The system also steers the vehicle to help you remain within your driving lane. 	<ul style="list-style-type: none"> • Keep the vehicle within the lane you are driving. <ul style="list-style-type: none"> ► Lane Keeping Assist System (LKAS)* P. 456 • Keep the vehicle within the lane you are driving. <ul style="list-style-type: none"> ► Road Departure Mitigation (RDM) System* P. 452 • You can change the setting for the road departure mitigation system. Normal, Wide, and Warning Only can be selected. <ul style="list-style-type: none"> ► Customized Features P. 316
	<ul style="list-style-type: none"> • Blinks when you fail to steer the vehicle. The beeper sounds simultaneously. 	<ul style="list-style-type: none"> • Operate the steering wheel to resume the LKAS.
	<ul style="list-style-type: none"> • Appears when the LKAS is in operation, or the LKAS button is pressed, but there is a problem with a system related to the LKAS. The LKAS cancels automatically. The beeper sounds simultaneously if selected by customization. 	<ul style="list-style-type: none"> • If any other system indicators come on, such as the VSA®, ABS and brake system, take appropriate action. <ul style="list-style-type: none"> ► Indicators P. 76

* Not available on all models

Models with remote engine starter

Message	Condition	Explanation
 <p>To Start Driving: Brake + Push</p>	<ul style="list-style-type: none"> Appears when you unlock and open the driver's door while the engine is running by remote engine start. 	<p>➤ Remote Engine Start with Vehicle Feedback* P. 417</p>

Models with SPORT mode

Message	Condition	Explanation
 <p>Suspension System (ADS) Problem</p>	<ul style="list-style-type: none"> Appears if there is a problem with the adaptive damper system. 	<ul style="list-style-type: none"> Have your vehicle checked by a dealer. With this message appeared, your vehicle has normal damping ability without the adaptive damper feature.
 <p>Drive Mode Change Unavailable</p>	<ul style="list-style-type: none"> Appears if the drive mode cannot be changed due to certain situations, such as a system error or adverse driving conditions. 	<p>➤ SPORT Mode* P. 431</p>

Gauges

Gauges include the speedometer, tachometer, fuel gauge, and related indicators. They are displayed when the ignition switch is in ON *1.

Speedometer

Displays your driving speed in mph or km/h.

Tachometer

Shows the number of engine revolutions per minute.

*1: Models with the smart entry system have an **ENGINE START/STOP** button instead of an ignition switch.



☒ Gauges

Models with information display

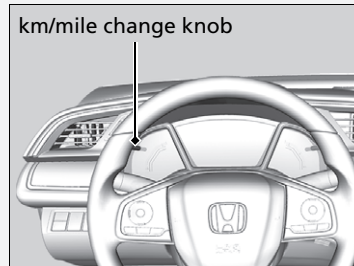
Press and hold the km/mile change knob until you hear a beep. The speedometer reading and the displayed measurements switch between mph and km/h.



Models with driver information interface

Press the  (display/information) button repeatedly until the  icon is shown on the driver information interface. Press **ENTER**, then press and hold it again. The speedometer reading and the displayed measurements will switch between mph and km/h.

☒ Tachometer

Models with driver information interface

You can turn on or off the tachometer display.

➤ **Customized Features** P. 316

■ Fuel Gauge

Displays the amount of fuel left in the fuel tank.

■ Temperature Gauge

Displays the temperature of the engine coolant.

■ Shift Up Backlight*

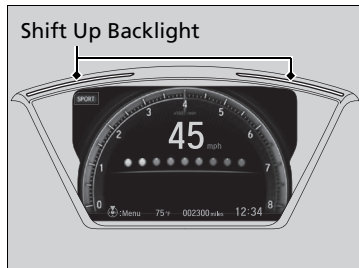

Blinks when the tachometer reading approaches the red zone.

» Fuel Gauge

NOTICE

You should refuel when the reading approaches **E**. Running out of fuel can cause the engine to misfire, damaging the catalytic converter.

The actual amount of remaining fuel may differ from the fuel gauge reading.

» Temperature Gauge

NOTICE

Driving with the temperature gauge pointer in the upper zone can cause serious engine damage. Pull safely to the side of the road and allow engine temperature to return to normal.

➔ **Overheating** P. 589

» Shift Up Backlight*

You can use the customized features to turn the shift up backlight blink feature on and off.

➔ **Customized Features** P. 316

Information Display*

The information display shows the odometer, trip meter, engine oil life and maintenance service item codes, and other gauges.

Switching the Display

Press the  (TRIP) knob to change the display.

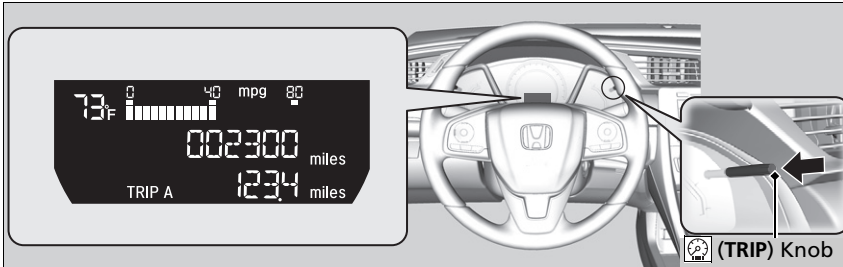

Odometer

Shows the total number of miles or kilometers that your vehicle has accumulated.

Trip Meter

Shows the total number of miles or kilometers driven since the last reset. Meters A and B can be used to measure two separate trips.

Resetting a trip meter

To reset a trip meter, display it, then press and hold the  knob. The trip meter is reset to 0.0.

* Not available on all models

Continued

Switching the Display

Each time you press the  knob, the information display changes as follows:

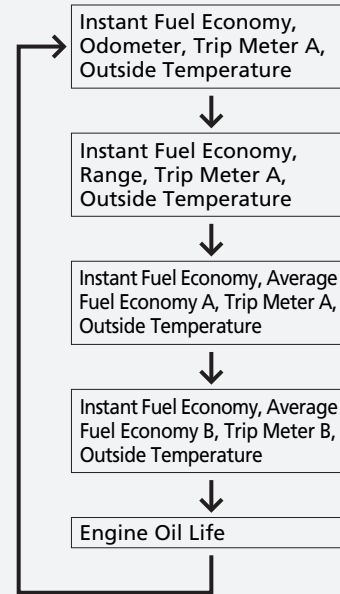

Trip Meter

Switch between trip meter A and trip meter B by pressing the  knob.

■ Average Fuel Economy

Shows the estimated average fuel economy of each trip meter in mpg or l/100 km. The display is updated at set intervals. When a trip meter is reset, the average fuel economy is also reset.

■ Instant Fuel Economy Gauge

Shows the instant fuel economy as a bar graph in mpg or l/100km.

■ Engine Oil Life

Shows the remaining oil life and Maintenance Minder™.

➤ **Maintenance Minder™** P. 503

■ Range

Shows the estimated distance you can travel on the remaining fuel. This estimated distance is based on the vehicle's current fuel economy.

⌘ Average Fuel Economy

Press and hold the km/mile change knob to switch the measurement.

⌘ Instant Fuel Economy Gauge

Press and hold the km/mile change knob to switch the measurement.

⌘ Range



Press and hold the km/mile change knob to switch the measurement.

■ Outside Temperature

Shows the outside temperature in Fahrenheit.

■ Adjusting the outside temperature indicator

Adjust the temperature reading by up to $\pm 5^{\circ}\text{F}$ if the temperature reading seems incorrect.

1. Turn the ignition switch to ON *1.
2. Press and hold the  (TRIP) knob for 10 seconds or more while the outside temperature is shown on the information display.
 - ▶ The information display goes into temperature adjustment mode. The display starts showing from -5°F to $+5^{\circ}\text{F}$.
3. Release the  knob when the right adjustment amount is shown.
 - ▶ The adjustment is complete.

⊗ Outside Temperature

The temperature sensor is in the front bumper. Road heat and exhaust from another vehicle can affect the temperature reading when your vehicle speed is less than 19 mph (30 km/h).

It may take several minutes for the display to be updated after the temperature reading has stabilized.

*1: Models with the smart entry system have an **ENGINE START/STOP** button instead of an ignition switch.



Driver Information Interface *

The driver information interface displays the odometer, trip meter, outside temperature, and other gauges.

It also displays important messages such as warnings and other helpful information.

Switching the Display

Main displays

Press the  (display/information) button and press  or  to change the display. Press **ENTER** to see detailed information.

Switching the Display

You can edit, add, and delete the meter contents using the audio/information screen.

 **Customizing the Meter** P. 231

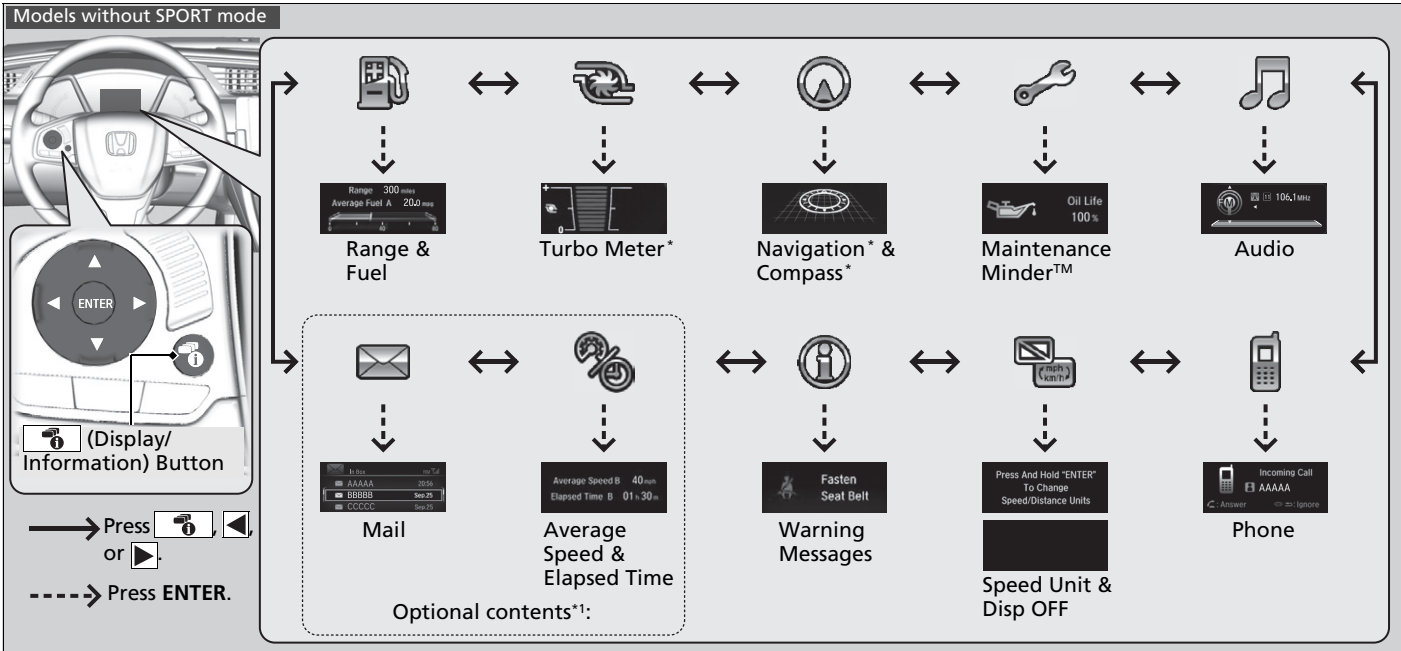

Instrument Panel

*1: You can add the contents using the audio/information screen.

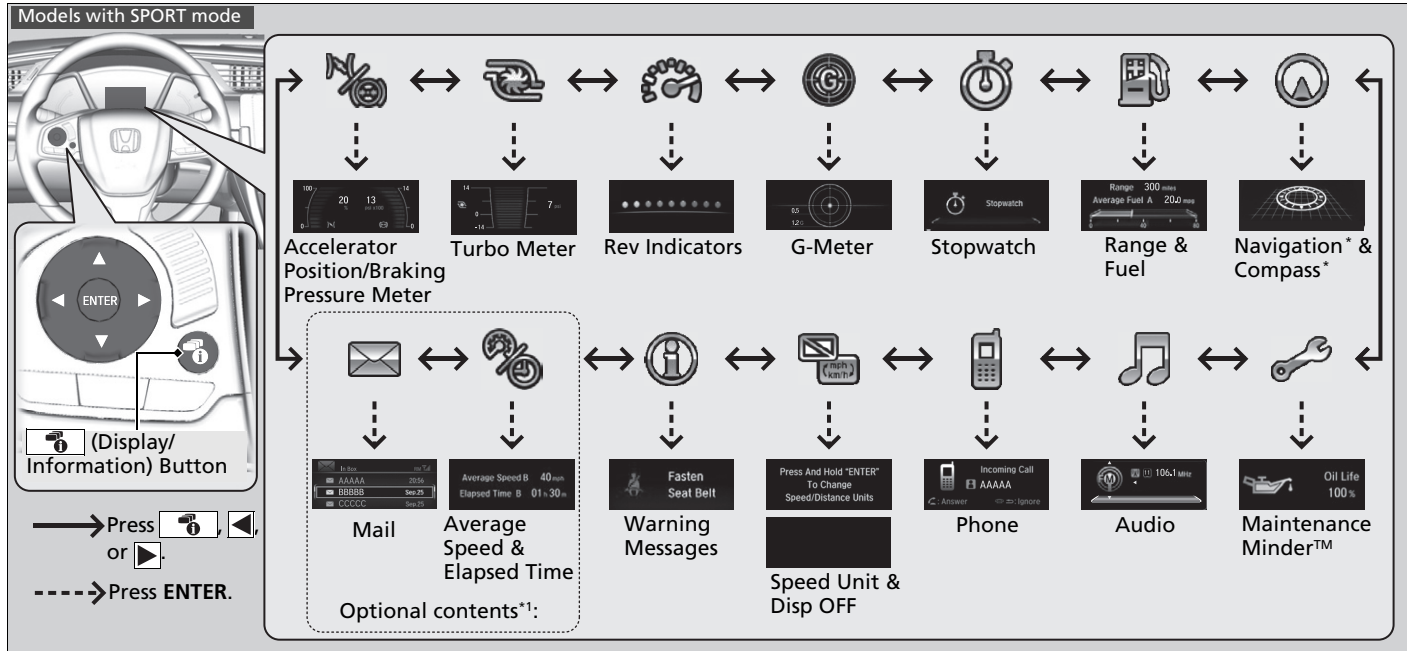

*1: You can add the contents using the audio/information screen.

■ Trip computer

Press the  (TRIP) knob to change the display.

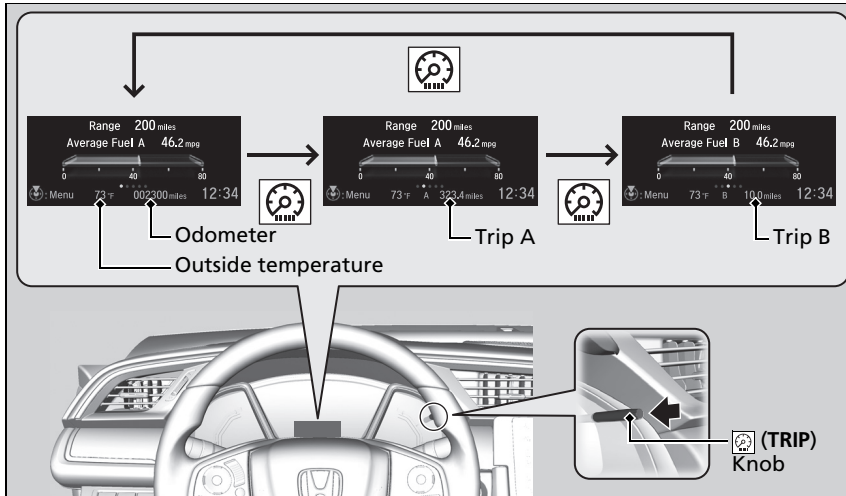

■ Odometer

Shows the total number of miles or kilometers that your vehicle has accumulated.

■ Trip Meter

Shows the total number of miles or kilometers driven since the last reset. Meters A and B can be used to measure two separate trips.

■ Resetting a trip meter

To reset a trip meter, display it, then press and hold the  knob. The trip meter is reset to **0.0**.

▶ Trip Meter

Switch between trip meter A and trip meter B by pressing the  knob.

■ Average Fuel Economy

Shows the estimated average fuel economy of each trip meter in mpg or l/100 km. The display is updated at set intervals. When a trip meter is reset, the average fuel economy is also reset.

■ Range

Shows the estimated distance you can travel on the remaining fuel. This estimated distance is based on the vehicle's current fuel economy.

■ Elapsed Time

Shows the time elapsed since Trip A or Trip B was reset.

■ Average Speed

Shows the average speed in mph or km/h since Trip A or Trip B was reset.

■ Engine Oil Life

Shows the remaining oil life and Maintenance Minder™.

▶ **Maintenance Minder™** P. 503

▶▶ Average Fuel Economy

You can change when the average fuel economy is reset.

▶ **Customized Features** P. 316

▶▶ Elapsed Time

You can change when the elapsed time is reset.

▶ **Customized Features** P. 316

▶▶ Average Speed

You can change when the average speed is reset.

▶ **Customized Features** P. 316

■ Outside Temperature

Shows the outside temperature in Fahrenheit (U.S.) or Celsius (Canada).

■ Adjusting the outside temperature display

Adjust the temperature reading by up to $\pm 5^{\circ}\text{F}$ or $\pm 3^{\circ}\text{C}$ if the temperature reading seems incorrect.

Use the audio/information screen to correct the temperature.

➤ **Customized Features** P. 316

■ Instant Fuel Economy

Shows the instant fuel economy as a bar graph in mpg or l/100 km.

■ Turbo Meter*

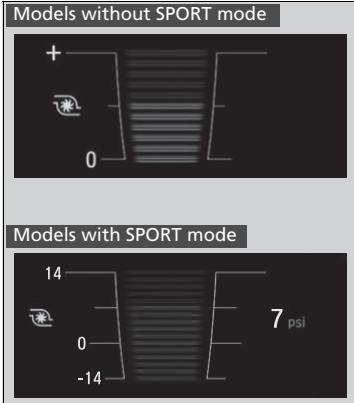

When the turbo charger is producing boost, this meter shows the boost pressure.

⊞ Outside Temperature

The temperature sensor is in the front bumper. Road heat and exhaust from another vehicle can affect the temperature reading when your vehicle speed is less than 19 mph (30 km/h).

It may take several minutes for the display to be updated after the temperature reading has stabilized.

* Not available on all models

■ Turn-by-Turn Directions*

The navigation system shows you turn-by-turn directions to your destination.

➤ **Refer to the Navigation System Manual**

■ Audio

Shows the current audio information.

➤ **Audio System Basic Operation** P. 225

■ Mail

Shows the current mail information.

➤ **Bluetooth® HandsFreeLink®** P. 372

■ Phone

Shows the current phone information.

➤ **Bluetooth® HandsFreeLink®** P. 372

▶▶ Turn-by-Turn Directions*

You can select whether to have the turn-by-turn display come on or not during the route guidance.

➤ **Customized Features** P. 316

G-Meter*

Displays the strength (G) and direction of the load that is applied to the vehicle during driving.

Braking Pressure Meter*

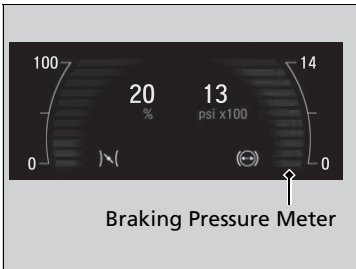

Displays the brake pressure in psi when the brake is applied.

Accelerator Position Meter*

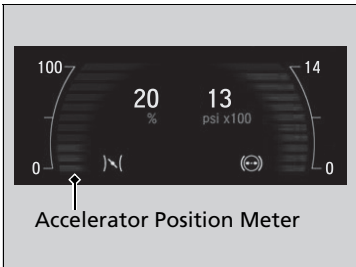

Displays the accelerator position in degrees of %.

* Not available on all models

■ Rev Indicators *

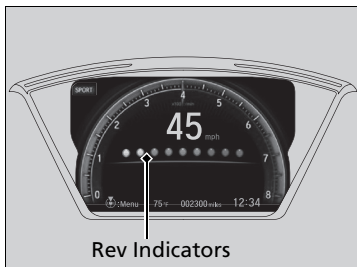

Light up from left to right according to engine speed.

■ Stopwatch*

Measures the lap time, and displays the previously measured times, split time and the fastest lap time.

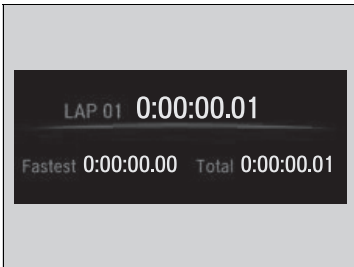
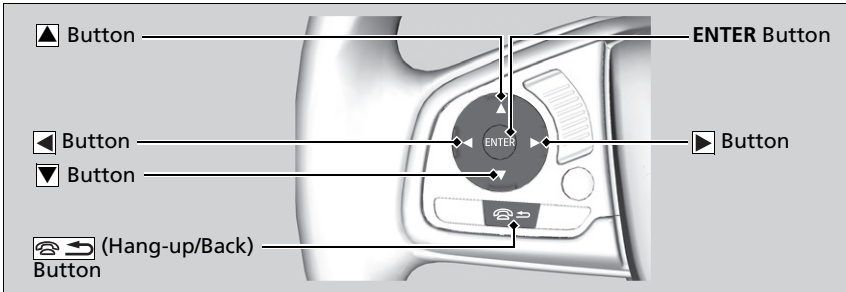

■ Measuring LAP Time

1. Press the **ENTER** button to display the lap time measurement screen.
2. Press the **ENTER** button to start measurement.
3. Press the **ENTER** button again to stop measurement.
 - To measure the time per lap, press the ▲/▼ button at the completion of each lap.
 - To return to the **Stopwatch** screen, press the ☎️ ↶ (Hang-up/back) button.

☒ Stopwatch*

Be sure to use this measurement function only where and when it is safe to do so.

Lap time is displayed from 0:00:00.00 to 9:59:59.99.

* Not available on all models

Continued



■ Checking/Clearing history

- To check history, press the button (when lap time is not running) to change the display, then press the / button to scroll through lap times.
 - ▶ A maximum of 20 lap times can be stored at a time.
- To clear the history, press and hold the / button when lap time is not running.
- To return to the lap time measurement screen, press the button.
- To return to the **Stopwatch** screen, press the (Hang-up/back) button.

Controls

This chapter explains how to operate the various controls necessary for driving.



Clock	126
Locking and Unlocking the Doors	
Key Types and Functions	128
Low Smart Entry Remote Signal Strength* ..	130
Locking/Unlocking the Doors from the	
Outside	131
Inside	138
Auto Door Locking/Unlocking	141
Opening and Closing the Trunk	145
Security System	
Immobilizer System	148
Security System Alarm	148
Opening and Closing the Windows	151
Opening and Closing the Moonroof*	154

Operating the Switches Around the Steering Wheel	
Ignition Switch*	155
ENGINE START/STOP Button*	156
Ignition Switch and Power Mode	
Comparison	159
Turn Signals	160
Light Switches	160
Fog Lights*	163
Daytime Running Lights	163
Wipers and Washers	164
Brightness Control	166
Rear Defogger/Heated Door Mirror*	
Button	167
Adjusting the Steering Wheel	168

Adjusting the Mirrors	
Interior Rearview Mirror	169
Power Door Mirrors	170
Adjusting the Seats	171
Interior Lights/Interior Convenience Items	180
Climate Control System	
Using Automatic Climate Control	191
Automatic Climate Control Sensors	198

* Not available on all models

Adjusting the Clock

Models without navigation system





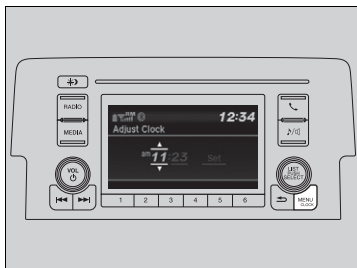

You can adjust the time in the clock display with the ignition switch in ON *1.

Adjusting the Time



Models with color audio system

■ Using the MENU/CLOCK button

1. Press and hold the **MENU/CLOCK** button.
 - ▶ **Adjust Clock** is selected.
2. Rotate  to change hour, then press .
3. Rotate  to change minute, then press .
4. To enter the selection, rotate  and select **Set**, then press .

▶▶ Adjusting the Clock

Models with navigation system

The clock is automatically updated through the audio system, so the time does not need to be adjusted.

Models with Display Audio

You cannot adjust the time while the vehicle is moving.

You can customize the clock display to show the 12 hour clock or 24 hour clock.

▶ **Customized Features** P. 316

▶▶ Using the MENU/CLOCK button

Models with color audio system

These indications are used to show how to operate the **LIST/SELECT** (List/Selector) knob.

Rotate  to select.

Press  to enter.

*1: Models with the smart entry system have an **ENGINE START/STOP** button instead of an ignition switch.

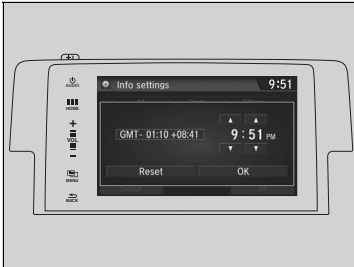

Models with Display Audio

■ Using the Settings menu on the audio/information screen

1. Select **Settings**.
2. Select **Clock**.
3. Select **Clock Adjustment**.
4. Select ▲ or ▼ to change hour.
5. Select ▲ or ▼ to change minute, then select **OK**.

☞ Using the Settings menu on the audio/information screen

You can turn the clock display on and off.

☞ **Customized Features** P. 316

The clock is automatically updated when your smartphone is connected to the audio system.

You can also adjust the clock by touching the clock displayed on the upper right corner of the display.

1. Touch the clock on the display for a few seconds.
2. Select **Clock Adjustment**.
3. Select ▲ or ▼ to change hour.
4. Select ▲ or ▼ to change minute, then select **OK**.

Key Types and Functions

This vehicle comes with the following keys:

Keys

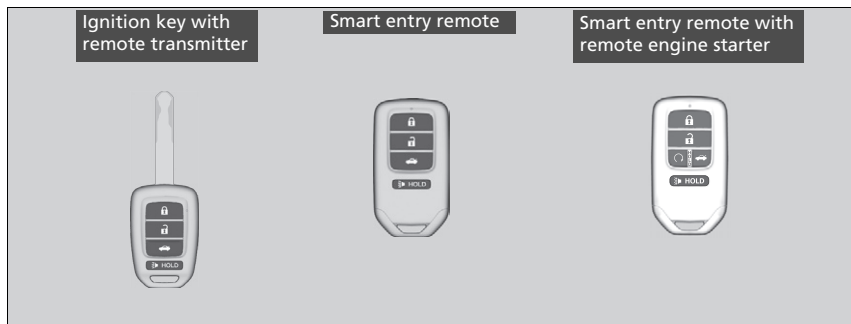

Use the key to start and stop the engine, to lock and unlock the doors and to open the trunk. You can also use the remote transmitter or smart entry system* to lock and unlock the doors and to open the trunk.

Smart entry remote*

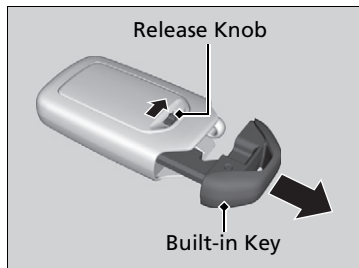

The built-in key can be used to lock/unlock the doors when the smart entry remote battery becomes weak and the power door lock/unlock operation is disabled.

To remove the built-in key, pull it out while sliding the release knob. To reinstall the built-in key, push the built-in key into the smart entry remote until it clicks.

Key Types and Functions

All the keys have an immobilizer system. The immobilizer system helps to protect against vehicle theft.

Immobilizer System P. 148

Follow the advice below to prevent damage to the keys:

- Do not leave the keys in direct sunlight, or in locations with high temperature or high humidity.
- Do not drop the keys or set heavy objects on them.
- Keep the keys away from liquids, dust or sand.
- Do not take the keys apart except for replacing the battery.

If the circuits in the keys are damaged, the engine may not start, and the remote transmitter may not work.

If the keys do not work properly, have them inspected by a dealer.

Models with remote engine starter

You can remotely start the engine using the remote engine start.

Remote Engine Start with Vehicle Feedback* P. 417

■ Key Number Tag

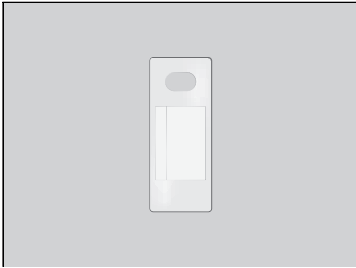

Contains a number that you will need if you purchase a replacement key.

▣ Key Number Tag

Keep the key number tag separate from the key in a safe place outside of your vehicle.
If you wish to purchase an additional key, contact a dealer.

If you lose your key and you cannot start the engine, contact a dealer.

Low Smart Entry Remote Signal Strength *

The vehicle transmits radio waves to locate the smart entry remote when locking/unlocking the doors and fuel fill door, opening the trunk, or starting the engine.

In the following cases, locking/unlocking the doors, opening the trunk, or starting the engine may be inhibited or operation may be unstable:

- Strong radio waves are being transmitted by nearby equipment.
- You are carrying the smart entry remote together with telecommunications equipment, laptop computers, cell phones, or wireless devices.
- A metallic object is touching or covering the smart entry remote.

Low Smart Entry Remote Signal Strength *

Communication between the smart entry remote and the vehicle consumes the smart entry remote's battery.

Battery life is about two years, but this varies depending on regularity of use.

The battery is consumed whenever the smart entry remote is receiving strong radio waves. Avoid placing it near electrical appliances such as televisions and personal computers.

Locking/Unlocking the Doors from the Outside

■ Using the Smart Entry with Push Button Start System *

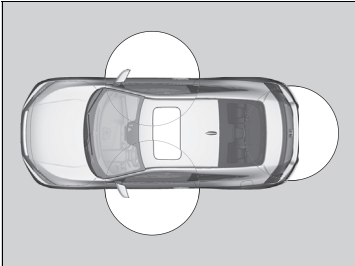

When you carry the smart entry remote, you can lock/unlock the doors, fuel fill door, and open the trunk.

You can lock/unlock the doors and fuel fill door within a radius of about 32 inches (80 cm) of the outside door handle. You can open the trunk within about 32 inches (80 cm) radius from the trunk release button.

■ Locking the doors and trunk

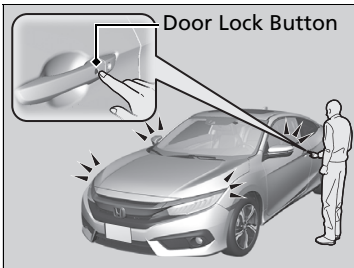

Press the door lock button on either door.

- ▶ Some exterior lights flash; the beeper sounds; both doors and the trunk lock; and the security system sets.

☒ Locking/Unlocking the Doors from the Outside

If the interior light switch is in the door activated position, the interior lights come on when you unlock the doors. No doors opened: The lights fade out after 30 seconds. Doors relocked: The lights go off immediately.

☒ **Interior Lights** P. 180

☒ Using the Smart Entry with Push Button Start System *

- Do not leave the smart entry remote in the vehicle when you get out. Carry it with you.
- Even if you are not carrying the smart entry remote, you can lock/unlock the doors while someone else with the remote is within range.
- The door may be unlocked if the door handle is covered with water in heavy rain or in a car wash if the smart entry remote is within range.
- If you grip either door handle wearing gloves, the door sensor may be slow to respond or may not respond by unlocking the doors.
- After locking the door, you have up to 2 seconds during which you can pull the door handle to confirm whether the door is locked. If you need to unlock the door immediately after locking it, wait at least 2 seconds before gripping the handle, otherwise the door will not unlock.
- The door might not open if you pull it immediately after gripping the door handle. Grip the handle again and confirm that the door is unlocked before pulling the handle.
- Even within the 32 inches (80 cm) radius, you may not be able to lock/unlock the doors with the smart entry remote if it is above or below the outside handle.
- The smart entry remote may not operate if it is too close to the door and door glass.

Models with Display Audio

The light flash, beep, and door unlock mode settings can be customized.

☒ **Customized Features** P. 316

* Not available on all models

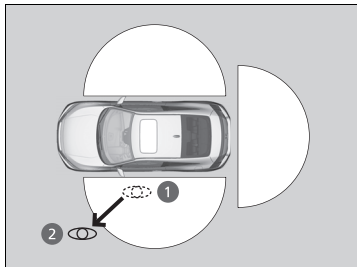
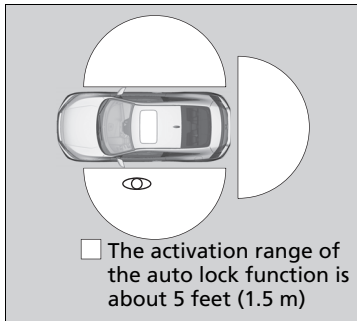

■ Locking the doors and trunk (Walk away auto lock)*

When you walk away from the vehicle while carrying the smart entry remote, the doors will automatically lock.

The auto lock function activates when both doors are closed, and the smart entry remote is within about 5 feet (1.5 m) radius of the outside door handle.

Exit vehicle while carrying smart entry remote and close door(s).

1. While within about 5 feet (1.5 m) radius of the vehicle.
 - ▶ The beeper sounds; the auto lock function will be activated.
2. Carry the smart entry remote beyond about 5 feet (1.5 m) from the vehicle and remain outside this range for 2 or more seconds.
 - ▶ Some exterior lights flash; the beeper sounds; both doors will then lock.

▣ Locking the doors and trunk (Walk away auto lock)*

The auto lock function is set to OFF as the factory default setting. The auto lock function can be set to ON using the audio/information screen.

If you set the auto lock function to ON using the audio/information screen, only the remote transmitter that was used to unlock the driver's door prior to the setting change can activate auto lock.

▶ **Customized Features** P. 316

After the auto lock function has been activated, when you stay within the locking/unlocking operation range, the indicator on the smart entry remote will continue to flash until the doors are locked.

When you stay beside the vehicle within the operation range, the doors will automatically lock approximately 30 seconds after the auto lock function activating beeper sounds.

When you open a door after the auto lock function activating beeper sounds, the auto lock function will be delayed until both doors are closed.

When both doors have been closed and the smart entry remote is inside the vehicle, or if the smart entry remote is not detected within about 5 feet (1.5 m) of the vehicle, auto lock function will not be activated.

To temporarily deactivate the function:

1. Set the power mode to OFF.
2. Open the driver's door.
3. Using the master door lock switch, operate the lock as follows:
Lock → Unlock → Lock → Unlock.
▶ The beeper sounds and the function is deactivated.

To restore the function:

- Set the power mode to ON.
- Lock the vehicle without using the auto lock function.
- Walk away at least more than about 5 feet (1.5 m) away from the vehicle while carrying the smart entry remote.
- Open either door.

⌘ Locking the doors and trunk (Walk away auto lock)*

The auto lock function does not operate when any of the following conditions are met.

- The smart entry remote is inside the vehicle.
- A door or the hood is not closed.
- The power mode is set to any mode other than OFF.
- The smart entry remote is not located within a radius of about 5 feet (1.5 m) from the vehicle when you get out of the vehicle and close the doors.

Auto lock function operation stop beeper

After the auto lock function has been activated, the auto lock operation stop beeper sounds for approximately two seconds in the following cases.

- The smart entry remote is put inside the vehicle through a window.
 - You are located too close to the vehicle.
 - The smart entry remote is put inside the trunk.
- If the warning beeper sounds, check that you are carrying the smart entry remote. Then, open/close a door and confirm the auto lock activation beeper sounds once.

■ Unlocking the doors and trunk

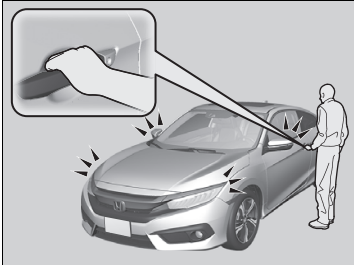

Grab the driver's door handle:

- ▶ The driver's door and fuel fill door unlocks.
- ▶ Some exterior lights flash twice and the beeper sounds twice.

Grab the front passenger's door handle:

- ▶ Both doors unlock.
- ▶ Some exterior lights flash twice and the beeper sounds twice.

Press the trunk release button:

- ▶ The trunk unlocks and opens.
- ▶ Some exterior lights flash and the beeper sounds.

➤ **Using the Trunk Release Button** * P. 146

▶▶ Using the Smart Entry with Push Button Start System *

If you do not open a door within 30 seconds of unlocking the vehicle with the smart entry system, the doors will automatically relock.

You can lock or unlock doors using the smart entry system only when the power mode is in VEHICLE OFF.

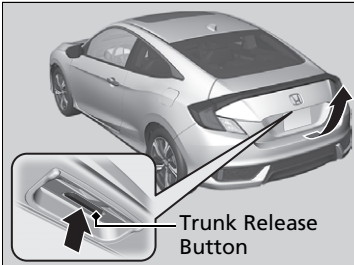

Trunk Release Button

■ Using the Remote Transmitter

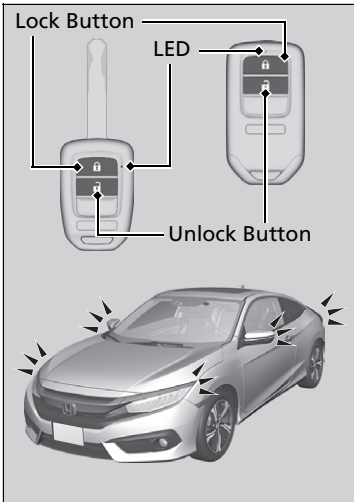

■ Locking the doors

Press the lock button.

Once:

- ▶ Some exterior lights flash, both doors and fuel fill door lock, and the security system sets.

Twice (within five seconds after the first push):

- ▶ The beeper sounds and verifies the security system is set.

⌘ Using the Remote Transmitter

If you do not open a door within 30 seconds of unlocking the vehicle with the remote transmitter, the doors will automatically relock.

Models with Display Audio

You can change the relock timer setting.

➤ **Customized Features** P. 316

The remote transmitter uses low-power signals, so the operating range may vary depending on the surroundings.

Models without smart entry system

The remote transmitter will not work when the key is in the ignition switch.

Models with smart entry system

You can lock or unlock doors using the remote transmitter only when the power mode is in VEHICLE OFF.

All models

The remote will not lock the vehicle when a door is open.

■ Unlocking the doors

Press the unlock button.

Once:

- ▶ Some exterior lights flash twice, and the driver's door and fuel fill door unlock.

Twice:

- ▶ The passenger's door unlocks.

■ Locking/Unlocking the Doors Using a Key

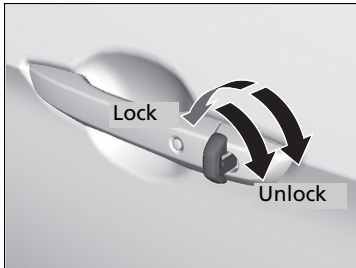

If the lock or unlock button of the remote does not work, use the key instead. Fully insert the key and turn it.

▶▶ Using the Remote Transmitter

If the distance at which the remote transmitter works varies, the battery is probably low. If the LED does not come on when you press a button, the battery is dead.

➔ **Replacing the Button Battery** P. 551

Models with Display Audio

You can customize the door unlock mode setting.

➔ **Customized Features** P. 316

▶▶ Locking/Unlocking the Doors Using a Key

When you lock the driver's door with a key, the passenger's door locks at the same time. When unlocking, the driver's door unlocks first. Turn the key a second time within a few seconds to unlock the passenger's door.

Models with Display Audio

You can customize the door unlock mode setting.

➔ **Customized Features** P. 316

■ Locking a Door Without Using a Key

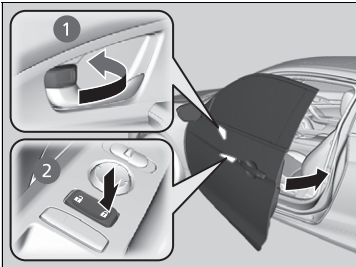

If you do not have the key on you, or if for some reason you cannot lock a door using the key, you can lock the door without it.

■ Locking the driver's door

Push the lock tab forward ① or push the master door lock switch in the lock direction ②, and close the door.

■ Locking the passenger's door

Push the lock tab forward and close the door.

■ Lockout prevention system

Models without smart entry system

The doors cannot be locked when the key is in the ignition switch.

Models with smart entry system

The doors cannot be locked when the smart entry remote is inside the vehicle.

▶ Locking a Door Without Using a Key

When you lock the driver's door, the passenger's door locks at the same time.

Before locking a door, make sure that the key is not inside the vehicle.

Locking/Unlocking the Doors from the Inside

■ Using the Lock Tab

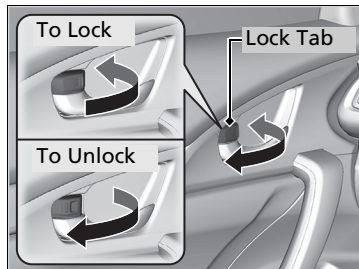

■ **Locking a door**
Push the lock tab forward.

■ **Unlocking a door**
Pull the lock tab rearward.

☞ Using the Lock Tab

When you lock the door using the lock tab on the driver's door, the passenger's door locks at the same time.

When you unlock the door using the lock tab on the driver's door, only the driver's door will unlock.

■ Unlocking Using the Inner Handle

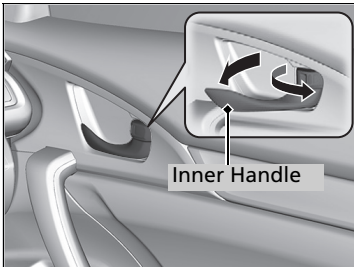

Pull the inner handle.

- ▶ The door unlocks and opens in one motion.

Unlocking and opening the driver's door from the inner handle unlocks both doors.

To avoid both doors to be unlocked, use the lock tab on the driver's door to unlock, then lock again before opening the door.

- ▶ This setting works for one time only.

Models with Display Audio

If you do not want both doors to be unlocked all the time, customize the **Auto Door Unlock** setting to **Off** using the audio/information screen.

➤ **Customized Features** P. 316

Models without Display Audio

If you do not want both doors to be unlocked all the time, customize the auto door unlocking setting to off using the master door lock switch.

➤ **Customizing Flow for Auto Door Unlocking Options** P. 144

☒ Unlocking Using the Inner Handle

The inner handles are designed to allow front seat occupants to open the door in one motion. However, this feature requires that front seat occupants never pull an inner handle while the vehicle is in motion.

■ Using the Master Door Lock Switch

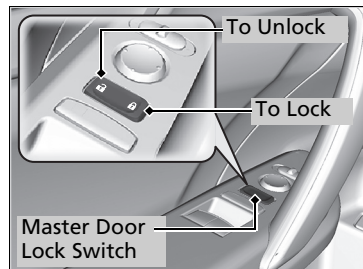

Press the master door lock switch in as shown to lock or unlock both doors.

▣ Using the Master Door Lock Switch

When you lock/unlock either doors using the master lock switch, both doors lock/unlock at the same time.

Auto Door Locking/Unlocking

Your vehicle locks and unlocks both doors automatically when a certain condition is met.

■ Auto Door Locking

■ Drive lock mode

Both doors lock when the vehicle's speed reaches about 10 mph (15 km/h).

■ Auto Door Unlocking

■ Driver's door open mode

Both doors unlock when the driver's door is opened.

» Auto Door Locking/Unlocking

Models without Display Audio

You can turn off or change to another auto door locking/unlocking setting using the master door lock switch.

➤ Customizing the Auto Door Locking/Unlocking Setting P. 142

Models with Display Audio

You can turn off or change to another auto door locking/unlocking setting using the audio/information screen.

➤ Customized Features P. 316

Customizing the Auto Door Locking/Unlocking Setting

You can customize the auto door locking/unlocking setting to your liking using the master door lock switch.

List of the Auto Door Locking/Unlocking Customizable Options

■ Auto door locking

Mode	Description
Drive Lock Mode^{*1}	Both doors lock when the vehicle's speed reaches about 10 mph (15 km/h).
Off	The auto door locking is deactivated all the time.

■ Auto door unlocking

Mode	Description
Driver's Door Open Mode^{*1}	Both doors unlock when the driver's door is opened.
<div style="border: 1px solid black; padding: 2px; display: inline-block;">Models with continuously variable transmission</div> Park Unlock Mode	Both doors unlock when the transmission is put into P with the brake pedal depressed.
Off	The auto door unlocking is deactivated all the time.

*1: Default setting

Customizing Flow for Auto Door Locking Options

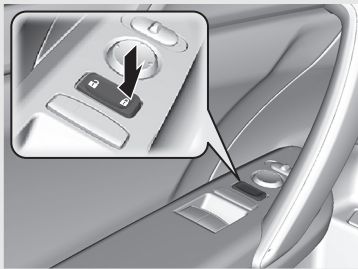
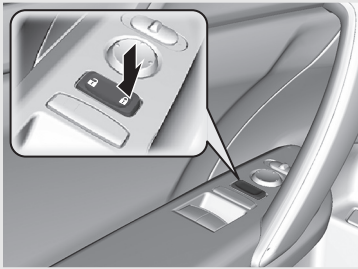
Steps	Drive Lock Mode*2	Off
1	Apply the parking brake. Models with continuously variable transmission Move the shift lever out of P .	Apply the parking brake. Models with continuously variable transmission Move the shift lever to P .
2	Close the driver's door.	Open the driver's door.
3	Turn the ignition switch to ON II *1.	Turn the ignition switch to ON II *1.
4	Press and hold the right side of the master door lock switch on the driver's door for more than five seconds. Release the switch after you hear a click twice. 	Press and hold the right side of the master door lock switch on the driver's door for more than five seconds. Release the switch after you hear one click. 
5	Turn the ignition switch to ACCESSORY I *1 within 20 seconds. ▶ Customization is completed.	

*1: Models with the smart entry system have an **ENGINE START/STOP** button instead of an ignition switch.

*2: Default setting

■ Customizing Flow for Auto Door Unlocking Options

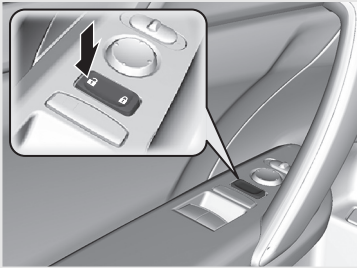
Steps	Driver's Door Open Mode*2	Models with continuously variable transmission Park Unlock Mode	Off
1	Apply the parking brake. Models with continuously variable transmission Move the shift lever out of P .	Apply the parking brake. Move the shift lever to P .	Apply the parking brake. Models with continuously variable transmission Move the shift lever to P .
2	Close the driver's door.		Open the driver's door.
3	Turn the ignition switch to ON II *1.		Turn the ignition switch to ON II *1.
4	Press and hold the left side of the master door lock switch on the driver's door for more than five seconds. Release the switch after you hear a click twice.		
			
5	Turn the ignition switch to ACCESSORY I *1 within 20 seconds. ▶ Customization is completed.		

*1: Models with the smart entry system have an **ENGINE START/STOP** button instead of an ignition switch.

*2: Default setting

Precautions for Opening/Closing the Trunk

■ Opening the trunk

Open the trunk all the way.

- ▶ If it is not fully opened, the trunk lid may begin to close under its own weight.

■ Closing the trunk

Keep the trunk lid closed while driving to:

- ▶ Avoid possible damage.
- ▶ Prevent exhaust gas from leaking into the vehicle.

🚫 **Exhaust Gas Hazard** P. 73

Using the Trunk Opener

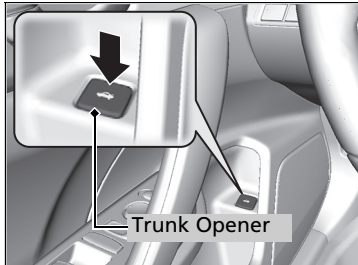

Pressing the trunk opener on the driver's door unlocks and opens the trunk.

🚫 **When You Cannot Open the Trunk** P. 603

Using the Trunk Release Button*

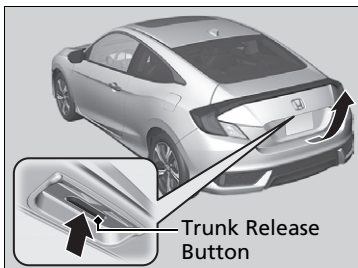

Push up the release button on the trunk lid after the doors are unlocked.

➤ **When You Cannot Open the Trunk** P. 603

Even if the trunk is locked, you can open the trunk if you carry the smart entry remote.

▶ Some exterior lights flash and the beeper sounds.

⌘ Using the Trunk Release Button*

- A person who is not carrying the smart entry remote can unlock the trunk if a person who is carrying it is within range.
- The smart entry remote may not operate if it is too close to the trunk.
- If you forget the remote inside, the beeper will sound and the trunk will not close.
- If the beeper sounds after you close the trunk, move the smart entry remote away from the trunk and close again.

Using the Remote Transmitter

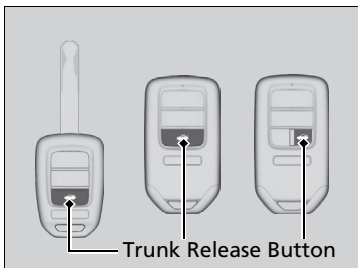

Press the trunk release button for approximately one second to unlock and open the trunk.

Emergency Trunk Opener

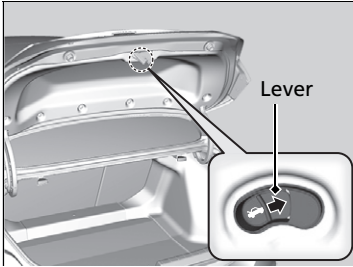

The trunk release lever allows you to open the trunk from inside for your safety.

Slide the release lever in the direction of the arrow.

☒ Emergency Trunk Opener

Parents should decide if their children should be shown how to use this feature.

Immobilizer System

The immobilizer system prevents a key that has not been pre-registered from starting the engine. Each key contains electronic transmitters that use electronic signals to verify the key.

Pay attention to the following when inserting the key into the ignition switch or pressing the **ENGINE START/STOP** button:

- Do not allow objects that emit strong radio waves near the ignition switch or the **ENGINE START/STOP** button.
- Make sure the key is not covered by or touching a metal object.
- Do not bring a key from another vehicle's immobilizer system near the ignition switch or the **ENGINE START/STOP** button.
- Do not put the key near magnetic items. Electronic devices, such as televisions and audio systems emit strong magnetic fields. Note that even a key chain can become magnetic.

Security System Alarm

The security system alarm activates when the trunk, hood or doors are forcibly opened. The alarm does not activate if the trunk or doors are opened with the key, remote transmitter or smart entry system*.

However, the alarm activates if a door is opened with the key and then the transmission is taken out of **[P]** (continuously variable transmission models) or the hood is opened before the ignition switch is turned to ON **[II]***1.

■ When the security system alarm activates

The horn sounds intermittently, and some exterior lights flash.

■ To deactivate the security system alarm

Unlock the vehicle using the remote transmitter, or smart entry system*, or the ignition switch is turned to ON **[II]***1. The system, along with the horn and flashing lights, is deactivated.

*1: Models with the smart entry system have an **ENGINE START/STOP** button instead of an ignition switch.

* Not available on all models

Immobilizer System

NOTICE

Leaving the key in the vehicle can result in theft or accidental movement of the vehicle.

Always take the key with you whenever you leave the vehicle unattended.

Do not alter the system or add other devices to it. Doing so may damage the system and make your vehicle inoperable.

Canadian models only: Apply and hold the brake pedal before turning the vehicle on the first time after the battery has been disconnected.

Security System Alarm

The security alarm continues for a maximum of two minutes until the security system deactivates.

■ Setting the security system alarm

The security system alarm automatically sets when the following conditions have been met:

- The ignition switch is in LOCK **[0]***1, and the key has been removed from the ignition switch.
- The hood and trunk are closed.
- Both doors are locked with the key, the remote transmitter, or smart entry system*.

■ When the security system alarm sets

The security system alarm indicator in the instrument panel blinks. When the blinking interval changes after about 15 seconds, the security system alarm is set.

■ To cancel the security system alarm

The security system is canceled when the vehicle is unlocked using the remote transmitter, smart entry system*, or the ignition switch is turned to ON **[II]***1. The security system indicator goes off at the same time.

*1: Models with the smart entry system have an **ENGINE START/STOP** button instead of an ignition switch.

* Not available on all models

» Security System Alarm

Do not set the security system alarm when someone is in the vehicle or a window is open. The system can accidentally activate when:

- Unlocking the door with the lock tab.
- Opening the trunk with the trunk opener on the driver's door or the emergency trunk opener.
- Opening the hood with the hood release.

Continuously variable transmission models

- Taking the transmission out of **[P]**.

If the battery goes dead after you have set the security system alarm, the security alarm may activate once the battery is recharged or replaced.

If this occurs, deactivate the security system alarm by unlocking a door using the remote transmitter or smart entry system*.

Do not alter the system or add other devices to it. Doing so may damage the system and make your vehicle inoperable.

■ Panic Mode

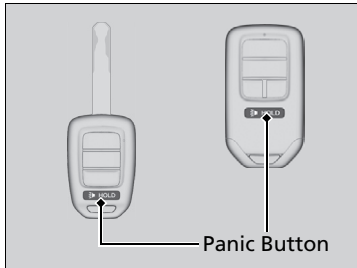

■ The panic button on the remote transmitter

If you press the panic button for approximately one second, the following will occur for about 30 seconds:

- The horn sounds.
- Some exterior lights flash.

■ Canceling panic mode

Press any button on the remote transmitter, or turn the ignition switch to ON *1.

*1: Models with the smart entry system have an **ENGINE START/STOP** button instead of an ignition switch.

Opening/Closing the Power Windows

The power windows can be opened and closed when the ignition switch is in ON **II***1, using the switches on the doors. The driver's side switches can be used to open and close both windows.

The power window lock button on the driver's side must be switched off (indicator off) to open and close the passenger's window from the passenger's side.

When the power window lock button is pressed, the indicator comes on and you can only operate the driver's window. Turn the power window lock button on if a child is in the vehicle.

Opening/Closing Windows with Auto-Open/Close Function

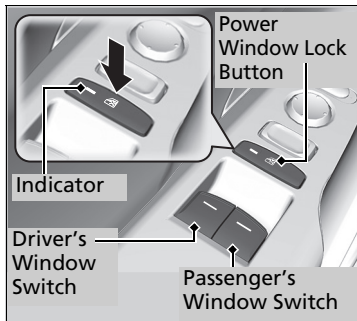

Automatic operation

To open: Push the switch down firmly.

To close: Pull the switch up firmly.

The window opens or closes completely. To stop the window at any time, push or pull the switch briefly.

Manual operation

To open: Push the switch down lightly, and hold it until the desired position is reached.

To close: Pull the switch up lightly, and hold it until the desired position is reached.

*1: Models with the smart entry system have an **ENGINE START/STOP** button instead of an ignition switch.

Opening/Closing the Power Windows

WARNING

Closing a power window on someone's hands or fingers can cause serious injury.

Make sure your passengers are away from the windows before closing them.

The power windows can be operated for up to 10 minutes after you turn the ignition switch to LOCK **0***1.

Opening either door cancels this function.

Auto Reverse

If a power window senses resistance when closing automatically, it will stop closing and reverse direction.

The driver's window auto reverse function is disabled when you continuously pull up the switch.

The auto reverse function stops sensing when the window is almost closed to ensure that it fully closes.

■ Opening Windows and Moonroof* with the Remote

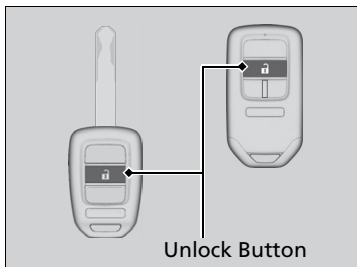

To open: Press the unlock button, and then within 10 seconds, press it again and hold it. If the windows and moonroof* stop midway, repeat the procedure.

■ Opening/Closing the Windows and Moonroof* with the Key

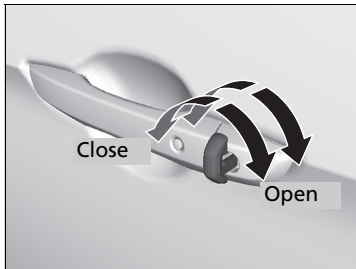

To open: Unlock the driver's door with the key. Within 10 seconds of returning the key to the central position, turn the key in the unlock direction and hold it there.

To close: Lock the driver's door with the key. Within 10 seconds of returning the key to the central position, turn the key in the lock direction and hold it there.

Release the key to stop the windows and moonroof* at the desired position. If you want further adjustment, repeat the same operation.

* Not available on all models

■ Opening/Closing the Moonroof

You can only operate the moonroof when the power mode is in ON. Use the switch in the front of the ceiling to open and close the moonroof.

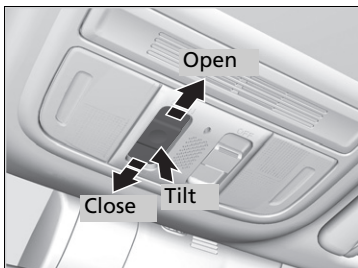

■ Automatic operation

To open: Pull the switch back firmly.

To close: Push the switch forward firmly.

The moonroof will automatically open or close all the way. To stop the moonroof midway, touch the switch briefly.

■ Manual operation

To open: Pull the switch back lightly, and hold it until the desired position is reached.

To close: Push the switch forward lightly, and hold it until the desired position is reached.

■ Tilting the moonroof up

To tilt: Push on the center of the moonroof switch.

To close: Push the switch forward firmly, then release.

☞ Opening/Closing the Moonroof

⚠ WARNING

Opening or closing the moonroof on someone's hands or fingers can cause serious injury.

Make sure all hands and fingers are clear of the moonroof before opening or closing it.

NOTICE

Opening the moonroof in below freezing temperature or when it is covered with snow or ice can damage the moonroof panel or motor.

The power moonroof can be operated for up to 10 minutes after you set the power mode to VEHICLE OFF (LOCK).
Opening either door cancels this function.

When resistance is detected, the auto reverse function causes the moonroof to change directions, then stop. Auto reverse stops sensing when the moonroof is almost closed to ensure that it fully closes.

You can use the remote transmitter or the key to operate the moonroof.

☞ **Opening Windows and Moonroof* with the Remote** P. 152

☞ **Opening/Closing the Windows and Moonroof* with the Key** P. 153

Ignition Switch *

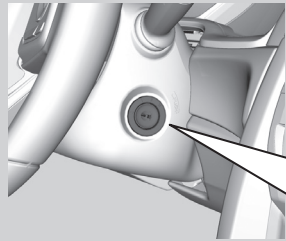

- 0** LOCK: Insert and remove the key in this position.
- I** ACCESSORY: Operate the audio system and other accessories in this position.
- II** ON: This is the position when driving.
- III** START: This position is for starting the engine. The switch returns to ON **II** when you let go of the key.

Ignition Switch *

Manual transmission models

⚠ WARNING

Removing the key from the ignition switch while driving locks the steering. This can cause you to lose control of the vehicle.

Remove the key from the ignition switch only when parked.

Continuously variable transmission models

You cannot take the key out unless the shift lever is in **P**.

All models

If you open the driver's door when the key is in LOCK **0** or ACCESSORY **I**, a warning buzzer will sound to remind you to take the key out.

Models with driver information interface

When this happens, the following messages appear on the driver information interface:

- In LOCK **0**: **Remove Key From Ignition.**
- In ACCESSORY **I**: **Return Ignition Switch To Lock (0) Position.** The buzzer will stop when you take the key out.

All models

If the key won't turn from LOCK **0** to ACCESSORY **I**, turn the key while moving the steering wheel left and right. The steering wheel will unlock, allowing the key to turn.

* Not available on all models

ENGINE START/STOP Button*

■ Changing the Power Mode

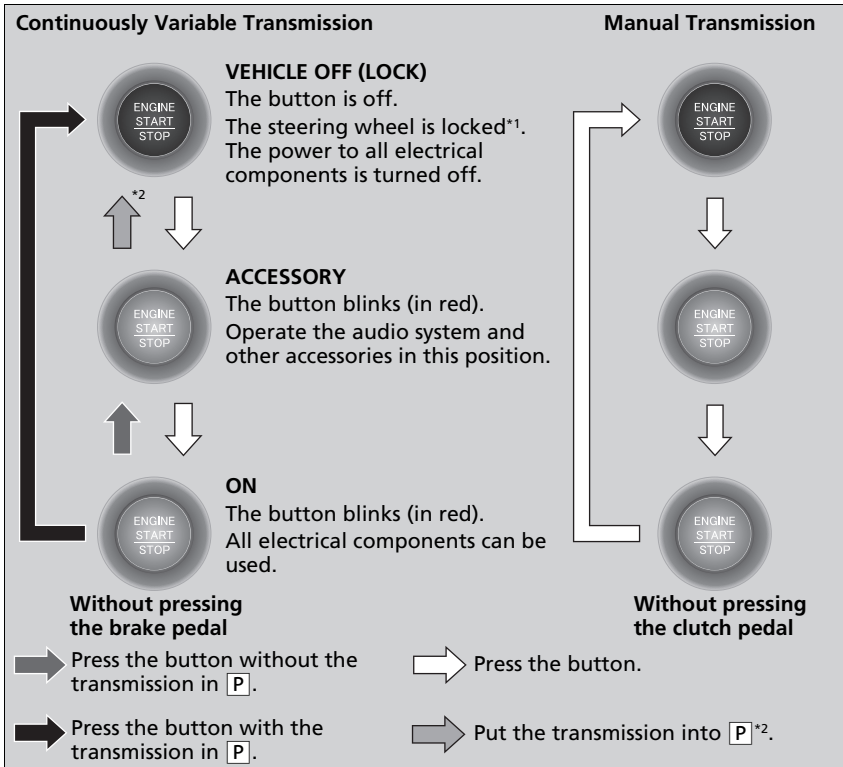

*1: Except U.S. models with continuously variable transmission

*2: U.S. models

* Not available on all models

▶▶ ENGINE START/STOP Button*

ENGINE START/STOP Button Operating Range

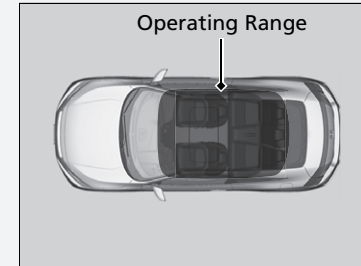

You can start the engine when the smart entry remote is inside the vehicle.

The engine may also run if the smart entry remote is close to the door or window, even if it is outside the vehicle.

ON mode:

The **ENGINE START/STOP** button is red when the engine is running.

If the battery of the smart entry remote is getting low, the engine may not start when you press the **ENGINE START/STOP** button. If the engine does not start, refer to the following link.

🔗 If the Smart Entry Remote Battery is Weak
P. 583

Do not leave the power mode in ACCESSORY or ON when you get out.

Automatic Power Off

If you leave the vehicle for 30 to 60 minutes with the transmission in **P***¹ and the power mode in ACCESSORY, the vehicle automatically goes into the mode similar to VEHICLE OFF (LOCK) to avoid draining the battery.

When in this mode:

Except U.S. continuously variable transmission models

The steering wheel does not lock.

All models

You cannot lock or unlock doors with the remote transmitter or the smart entry system.

Press the **ENGINE START/STOP** button twice to switch the mode to VEHICLE OFF (LOCK).

*1: Continuously variable transmission models

Changing the Power Mode

Except U.S. continuously variable transmission models

If the power mode does not change from VEHICLE OFF to ACCESSORY, press the **ENGINE START/STOP** button while moving the steering wheel left and right. The steering wheel will unlock, allowing the mode to change.

Power Mode Reminder

If you open the driver's door when the power mode is in ACCESSORY, a warning beep sounds.

Smart Entry Remote Reminder

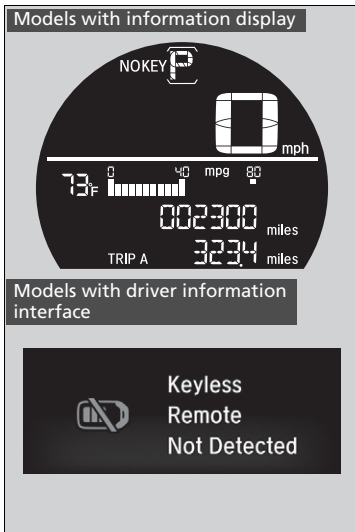

Warning buzzers may sound from inside and/or outside the vehicle to remind you that the smart entry remote is out of the vehicle. If the buzzer continues even after the remote is put back inside, place it to be within its operational range.

■ When the power mode is in ON

If the smart entry remote is taken out of the vehicle, and the driver's door is closed, warning buzzers sound from both inside and outside the vehicle. A warning message on the information display or driver information interface notifies the driver inside that the remote is out.

■ When the power mode is in ACCESSORY

If the smart entry remote is taken out of the vehicle, and both doors are closed, a warning buzzer sounds from outside the vehicle.

Smart Entry Remote Reminder

When the smart entry remote is within the system's operational range, and the driver's door is closed, the warning function cancels.

If the smart entry remote is taken out of the vehicle after the engine has been started, you can no longer change the **ENGINE START/STOP** button mode or restart the engine. Always make sure if the remote is in your vehicle when you operate the **ENGINE START/STOP** button.

Removing the smart entry remote from the vehicle through a window does not activate the warning buzzer.

Do not put the smart entry remote on the dashboard or in the glove box. It may cause the warning buzzer to activate. Under some other conditions that can prevent the vehicle from locating the remote, the warning buzzer may also activate even if the remote is within the system's operational range.

Ignition Switch and Power Mode Comparison

Ignition Switch Position	LOCK (0) (with/without the key)	ACCESSORY (I)	ON (II)	START (III)
Without Smart Entry System	<ul style="list-style-type: none"> Engine is turned off and power is shut down. The steering wheel is locked. No electrical components can be used. 	<ul style="list-style-type: none"> Engine is turned off. Some electrical components such as the audio system and the accessory power socket can be operated. 	<ul style="list-style-type: none"> Normal key position while driving. All electrical components can be used. 	<ul style="list-style-type: none"> Use this position to start the engine. The ignition switch returns to the ON (II) position when you release the key.
Power Mode	VEHICLE OFF (LOCK)	ACCESSORY	ON	START
With Smart Entry System and ENGINE START/STOP Button	Button-Off <ul style="list-style-type: none"> Engine is turned off and power is shut down. The steering wheel is locked*1. No electrical components can be used. 	Button-Blinking <ul style="list-style-type: none"> Engine is turned off. Some electrical components such as the audio system and the accessory power socket can be operated. 	Button-Blinking (engine is turned off) On (engine is running) <ul style="list-style-type: none"> All electrical components can be used. 	Button-On <ul style="list-style-type: none"> The mode automatically returns to ON after the engine starts.

*1:Except U.S. continuously variable transmission models

Turn Signals

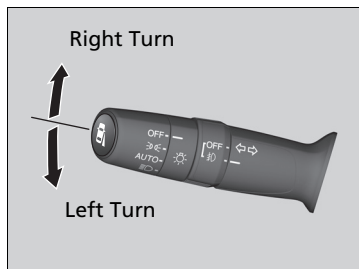

The turn signals can be used when the ignition switch is in ON ^{*1}.

■ One-touch turn signal

When you lightly push up or down and release the turn signal lever, the exterior turn signals and turn signal indicator blink three times.

This feature can be used when signaling for a lane change.

Light Switches

■ Manual Operation

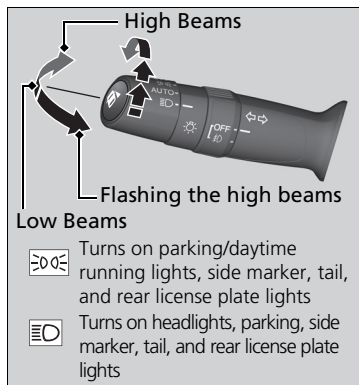

Rotating the light switch turns the lights on and off, regardless of the power mode setting or position of the ignition switch.

■ High beams

Push the lever forward until you hear a click.

■ Low beams

When in high beams, pull the lever back to return to low beams.

■ Flashing the high beams

Pull the lever back, and release it.

*1: Models with the smart entry system have an **ENGINE START/STOP** button instead of an ignition switch.

▶ Light Switches

Models with smart entry system

If you leave the power mode in VEHICLE OFF (LOCK) while the lights are on, a chime sounds when the driver's door is opened.

Models without smart entry system

If you remove the key from the ignition switch while the lights are on, a chime sounds when the driver's door is opened.

When the lights are on, the lights on indicator in the instrument panel will be on.

Lights On Indicator P. 85

Do not leave the lights on when the engine is off because it will cause the battery to discharge.

If you sense that the level of the headlights is abnormal, have the vehicle inspected by a dealer.

Automatic Operation (automatic lighting control)

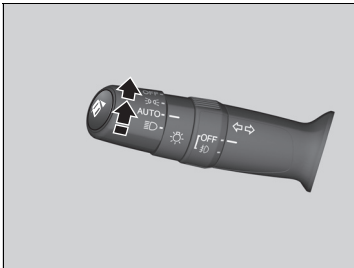

Automatic lighting control can be used when the ignition switch is in ON *1.

When you turn the light switch to **AUTO**, the headlights and other exterior lights will switch on and off automatically depending on the ambient brightness.

Models with Display Audio

▶ You can change the auto light sensitivity setting.

➤ **Customized Features** P. 316

Automatic Operation (automatic lighting control)

We recommend that you turn on the lights manually when driving at night, in a dense fog, or in dark areas such as long tunnels or parking facilities.

The light sensor is in the location shown below. Do not cover this light sensor with anything; otherwise, the automatic lighting system may not work properly.

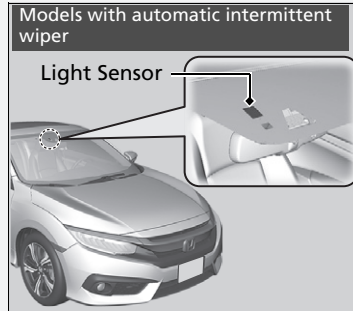
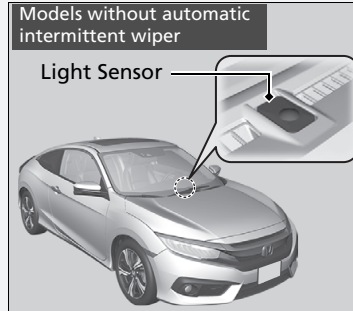

*1: Models with the smart entry system have an **ENGINE START/STOP** button instead of an ignition switch.

▶▶ Headlight Integration with Wipers*

The headlights automatically come on when the wipers are used several times within a certain number of intervals with the headlight switch in **AUTO**.
The headlights automatically go off a few minutes later if the wipers are stopped.

▶▶ Automatic Lighting Off Feature

The headlights, all other exterior lights, and the instrument panel lights turn off 15 seconds after you remove the key or set the power mode to VEHICLE OFF (LOCK), take the remote with you, and close the driver's door.

Models with Display Audio

- ▶ You can change the headlight auto off timer setting.
 ▶ **Customized Features** P. 316

If you turn the ignition switch to LOCK [0]*¹ with the headlight switch on, but do not open the door, the lights turn off after 10 minutes (3 minutes, if the switch is in the **AUTO** position).

The lights turn on again when you unlock or open the driver's door. If you unlock the door, but do not open it within 15 seconds, the lights go off. If you open the driver's door, you will hear a lights on reminder chime.

*1: Models with the smart entry system have an **ENGINE START/STOP** button instead of an ignition switch.

* Not available on all models

▶▶ Automatic Operation (automatic lighting control)

Adjust the auto light sensitivity as follows:

Setting	The exterior lights come on when the ambient light is at
Max	 Bright
High	
Mid	
Low	
Min	

▶ **Customized Features** P. 316

▶▶ Headlight Integration with Wipers*

This feature activates while the headlights are off in **AUTO**.
The instrument panel brightness does not change when the headlights come on.

At dark ambient light levels, the automatic lighting control feature turns on the headlights, regardless of the number of wiper sweeps.

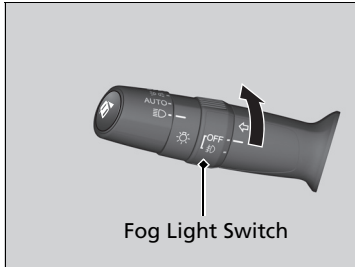

Fog Lights*



When the low beam headlights are on, turn the fog light switch on to use the fog lights.

Daytime Running Lights

The parking/daytime running lights come on when the following conditions have been met:

- The ignition switch is in ON *1.
- The headlight switch is off, or in .
- The parking brake is released.

The lights remain on even if you set the parking brake. Turning off the ignition switch or setting the power mode to VEHICLE OFF will turn off the daytime running lights.

The daytime running lights are off once the headlight switch is turned on, or when the headlight switch is in **AUTO** and it is getting darker outside.

*1: Models with the smart entry system have an **ENGINE START/STOP** button instead of an ignition switch.

* Not available on all models

☒ Fog Lights*

When the fog lights are on, the indicator in the instrument panel will be on.

They go off when the headlights turn off, or when the daytime running lights are on.

☒ **Fog Light Indicator*** P. 85

Wipers and Washers

Windshield Wiper/Washer

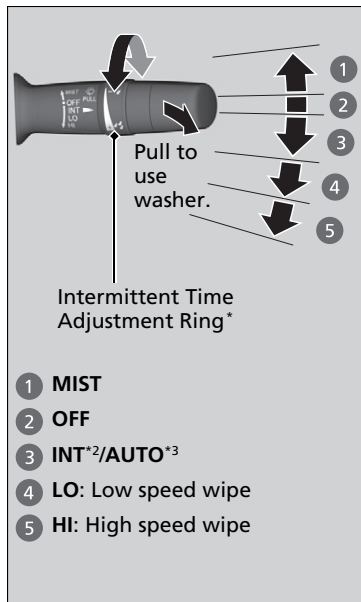

The windshield wipers and washers can be used when the ignition switch is in ON *1.

■ MIST

The wipers run at high speed until you release the lever.

■ Wiper switch (OFF, INT*2/AUTO*3, LO, HI)

Move the lever up or down to change the wiper settings.

■ Adjusting wiper operation*

Turn the adjustment ring to adjust the wiper operation.



Lower speed, fewer sweeps

Higher speed, more sweeps

■ Washer

Sprays while you pull the lever toward you. When you release the lever for more than one second, the spray stops, the wipers sweep two or three more times to clear the windshield, then stop.

*1: Models with the smart entry system have an **ENGINE START/STOP** button instead of an ignition switch.

*2: Models with manual intermittent operation

*3: Models with automatic intermittent operation

Wipers and Washers

NOTICE

Do not use the wipers when the windshield is dry. The windshield will get scratched, or the rubber blades will get damaged.

NOTICE

In cold weather, the blades may freeze to the windshield. Operating the wipers in this condition may damage the wipers. Use the defroster to warm the windshield, then turn the wipers on.

Models with intermittent time adjustment ring

If the vehicle speeds up while the wipers are operating intermittently, the length of the wipe interval shortens.



When the vehicle speeds up, the wiper operation's shortest delay setting  and the **LO** setting become the same.

All models

Turn the washers off if no washer fluid comes out. The pump may get damaged.

The wiper motor may stop motor operation temporarily to prevent an overload. Wiper operation will return to normal within a few minutes, once the circuit has returned to normal.

If the wiper stops operating due to any obstacle such as the build-up of snow, park the vehicle in a safe place.

Rotate the wiper switch to **OFF**, and turn the ignition switch to ACCESSORY  or LOCK *1, then remove the obstacle.

■ Automatic Intermittent Wipers*

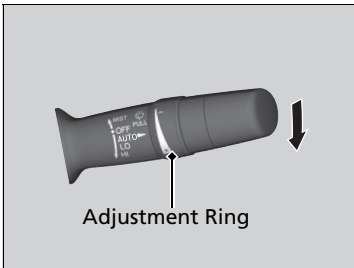

When you push the lever down to **AUTO**, the windshield wipers sweep once, and go into the automatic mode.

The wipers operate intermittently, at low speed, or at high speed and stops in accordance with the amount of rainfall the rainfall sensor detects.

■ AUTO sensitivity adjustment

When the wiper function is set to **AUTO**, you can adjust the sensitivity of the rainfall sensor (using the adjustment ring) so that wipers will operate in accordance with your preference.

Sensor sensitivity

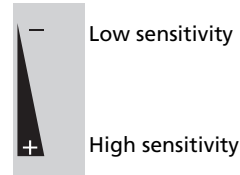

☒ Automatic Intermittent Wipers*

The rainfall sensor is in the location shown below.

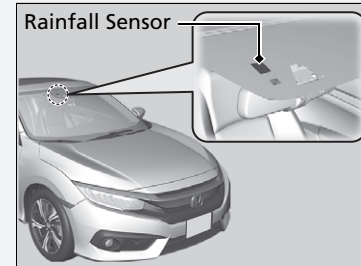



AUTO should always be turned OFF before the following situation in order to prevent severe damage to the wiper system:

- Cleaning the windshield
- Driving through a car wash
- No rain present

* Not available on all models

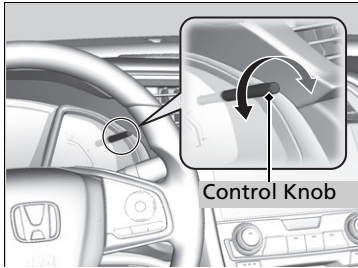
Brightness Control



When the parking lights are turned on and the ignition switch is in ON *1, you can use the brightness control knob to adjust instrument panel brightness.

Brighten: Turn the knob to the right.

Dim: Turn the knob to the left.

You will hear a beep when the brightness reaches minimum or maximum. Several seconds after adjusting the brightness, you will be returned to the previous screen.

■ Brightness level indicator

The brightness level is shown on the display while you are adjusting it.

On information display



On driver information interface

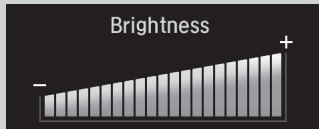

▶▶ Brightness Control

Instrument panel brightness varies, depending on whether the exterior lights are on or off. The instrument panel dims to reduce glare when they are on.

To cancel the reduced instrument panel brightness when the lights are on, turn the knob to the right until the brightness display reaches max, at which point a beeper will sound.

*1: Models with the smart entry system have an **ENGINE START/STOP** button instead of an ignition switch.

Rear Defogger/Heated Door Mirror* Button

Press the rear defogger and heated door mirror button to defog the rear window and mirrors when the ignition switch is in ON *1.

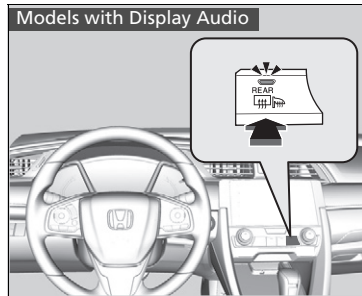
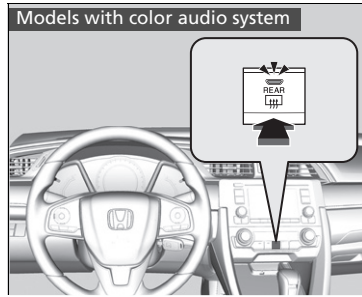

The rear defogger and heated door mirrors automatically switch off after 10-30 minutes depending on the outside temperature. However, if the outside temperature is 32°F (0°C) or below, they do not automatically switch off.

⊠ Rear Defogger/Heated Door Mirror* Button

NOTICE

When cleaning the inside of the rear window, be careful not to damage the heating wires. It is critical to wipe the window from side to side along the defogger heating wires.

This system consumes a lot of power, so turn it off when the window has been defogged. Also, do not use the system for a long period when the engine is idling. This may weaken the battery, making it difficult to start the engine.

*1: Models with the smart entry system have an **ENGINE START/STOP** button instead of an ignition switch.

* Not available on all models

Adjusting the Steering Wheel

The steering wheel height and distance from your body can be adjusted so that you can comfortably grip the steering wheel in an appropriate driving posture.

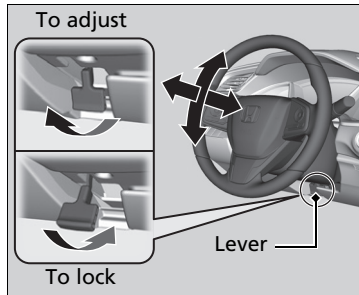

1. Pull the steering wheel adjustment lever up.
 - ▶ The steering wheel adjustment lever is under the steering column.
2. Move the steering wheel up or down, and in or out.
 - ▶ Make sure you can see the instrument panel gauges and indicators.
3. Push the steering wheel adjustment lever down to lock the steering wheel in position.
 - ▶ After adjusting the position, make sure you have securely locked the steering wheel in place by trying to move it up, down, in, and out.

Adjusting the Steering Wheel

WARNING

Adjusting the steering wheel position while driving may cause you to lose control of the vehicle and be seriously injured in a crash.

Adjust the steering wheel only when the vehicle is stopped.

Adjusting the Mirrors

Interior Rearview Mirror

Adjust the angle of the rearview mirror when you are sitting in the correct driving position.

Rearview Mirror with Day and Night Positions*

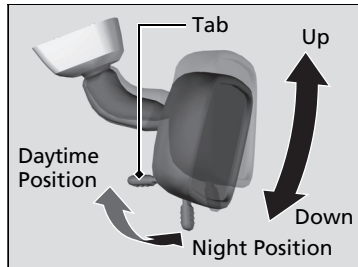

Flip the tab to switch the position. The night position will help to reduce the glare from headlights behind you when driving after dark.

Automatic Dimming Rearview Mirror*

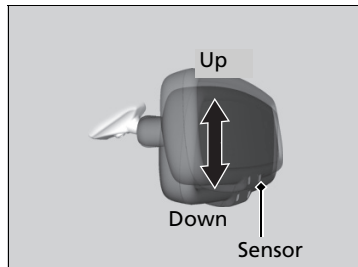

When driving after dark, the automatic dimming rearview mirror reduces the glare from headlights behind you, based in inputs from the mirror sensor. This feature is always active.

Adjusting the Mirrors

Keep the inside and outside mirrors clean and adjusted for best visibility.

Adjust the mirrors before you start driving.

➤ **Front Seats** P. 171

Automatic Dimming Rearview Mirror*

The auto dimming function cancels when the transmission is in **R**.

* Not available on all models

Power Door Mirrors

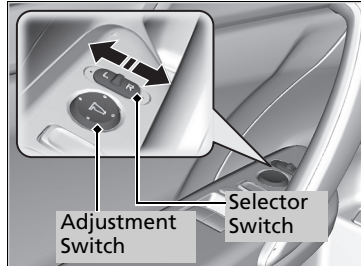

You can adjust the door mirrors when the ignition switch is in ON *1.

■ Mirror position adjustment

L/R selector switch: Select the left or right mirror. After adjusting the mirror, return the switch to the center position.

Mirror position adjustment switch: Press the switch left, right, up, or down to move the mirror.

*1: Models with the smart entry system have an **ENGINE START/STOP** button instead of an ignition switch.

Front Seats

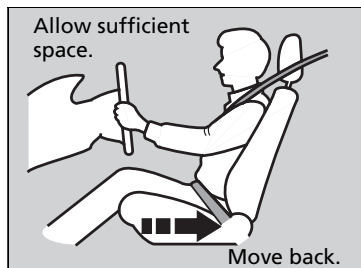

Adjust the driver's seat as far back as possible while allowing you to maintain full control of the vehicle. You should be able to sit upright, well back in the seat and be able to adequately press the pedals without leaning forward, and grip the steering wheel comfortably. The passenger's seat should be adjusted in a similar manner, so that it is as far back from the front airbag in the dashboard as possible.

Adjusting the Seats

⚠ WARNING

Sitting too close to a front airbag can result in serious injury or death if the front airbags inflate.

Always sit as far back from the front airbags as possible while maintaining control of the vehicle.

The National Highway Traffic Safety Administration and Transport Canada recommend that drivers allow at least 10 inches (25 cm) between the center of the steering wheel and the chest.

Always make seat adjustments before driving.

■ Adjusting the Seat Positions

■ Adjusting the front manual seats

Height Adjustment

(Driver side only)

Pull up or push down the lever to raise or lower the seat.

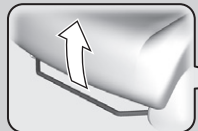

Horizontal Position Adjustment

Pull up on the bar to move the seat, then release the bar.



Driver's seat is shown.



Seat-back Angle Adjustment

Pull up the lever to change the angle.

► Adjusting the front manual seats

Once a seat is adjusted correctly, rock it back and forth to make sure it is locked in position.

■ Adjusting the Seat-Backs

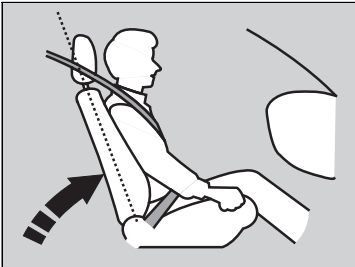

Adjust the driver's seat-back to a comfortable, upright position, leaving ample space between your chest and the airbag cover in the center of the steering wheel.

The front seat passenger should also adjust their seat-back to a comfortable, upright position.

Reclining a seat-back so that the shoulder part of the belt no longer rests against the occupant's chest reduces the protective capability of the belt. It also increases the chance of sliding under the belt in a crash and being seriously injured. The farther a seat-back is reclined, the greater the risk of injury.

▣ Adjusting the Seat-Backs

⚠ WARNING

Reclining the seat-back too far can result in serious injury or death in a crash.

Adjust the seat-back to an upright position, and sit well back in the seat.

Do not put a cushion, or other object, between the seat-back and your back.

Doing so may interfere with proper seat belt or airbag operation.

If you cannot get far enough away from the steering wheel and still reach the controls, we recommend that you investigate whether some type of adaptive equipment may help.

Head Restraints

Your vehicle is equipped with head restraints in all seating positions.

Models without SPORT mode

Adjusting the Front Head Restraints

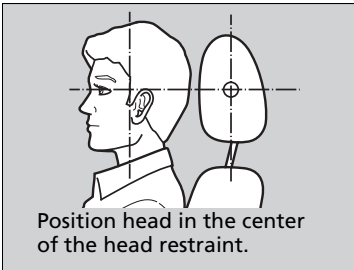

Front head restraints are most effective for protection against whiplash and other rear-impact crash injuries when the center of the back of the occupant's head rests against the center of the restraint. The tops of the occupant's ears should be level with the center height of the restraint.

To raise the head restraint:

Pull it upward.

To lower the head restraint:

Push it down while pressing the release button.

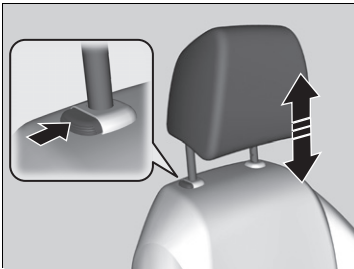

Adjusting the Front Head Restraints

WARNING

Improperly positioning head restraints reduces their effectiveness and increases the likelihood of serious injury in a crash.

Make sure head restraints are in place and positioned properly before driving.

In order for the head restraint system to work properly:

- Do not hang any items on the head restraints, or from the restraint legs.
- Do not place any object between an occupant and the seat-back.
- Install each restraint in its proper location.

Models without SPORT mode

Removing and Reinstalling the Front Head Restraints

Front head restraints can be removed for cleaning or repair.

To remove a head restraint:

Pull the restraint up as far as it will go. Then push the release button, and pull the restraint up and out.

To reinstall a head restraint:

Insert the legs back in place, then adjust the head restraint to an appropriate height while pressing the release button. Pull up on the restraint to make sure it is locked in position.

▶▶ Removing and Reinstalling the Front Head Restraints

WARNING

Failure to reinstall, or correctly reinstall, the head restraints can result in severe injury during a crash.

Always replace the head restraints before driving.

Maintain a Proper Sitting Position

After all occupants have adjusted their seats and head restraints*1, and put on their seat belts, it is very important that they continue to sit upright, well back in their seats, with their feet on the floor, until the vehicle is safely parked and the engine is off.

Sitting improperly can increase the chance of injury during a crash. For example, if an occupant slouches, lies down, turns sideways, sits forward, leans forward or sideways, or puts one or both feet up, the chance of injury during a crash is greatly increased.

In addition, an occupant who is out of position in the front seat can be seriously or fatally injured in a crash by striking interior parts of the vehicle or being struck by an inflating front airbag.

ⓘ Maintain a Proper Sitting Position

WARNING

Sitting improperly or out of position can result in serious injury or death in a crash.

Always sit upright, well back in the seat, with your feet on the floor.

*1: Models without SPORT mode

Rear Seat Access



Driver side

Pulling up on the seat-back angle adjustment lever tilts the seat-back forward.

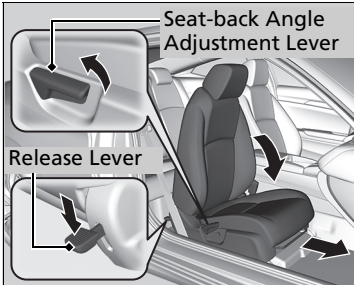

Passenger side

Pulling up on the seat-back angle adjustment lever, or pushing down the front passenger seat-back release lever tilts the seat-back forward, then move the seat forward.

⌘ Maintain a Proper Sitting Position

When you enter the rear seat, be careful not to trip over the front seat belt. If necessary, move the seat forward after tilting the seat-back forward.

Rear Seats

Folding Down the Rear Seats

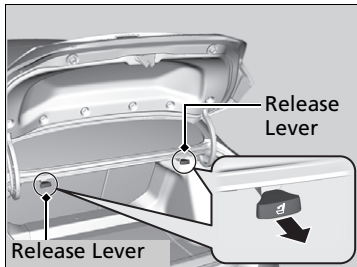

1. Pull the release lever in the trunk to release the lock.

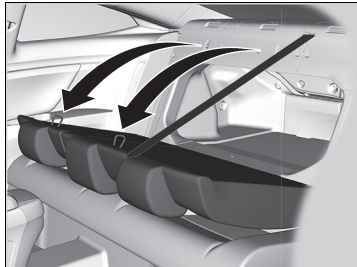

2. Fold the seat-back down.

Folding Down the Rear Seats

The rear seat-backs can be folded down to accommodate bulkier items in the trunk.

Never drive with the seat-back folded down and the trunk lid open.

❗ **Exhaust Gas Hazard** P. 73

To lock a seat-back upright, push it backwards until it locks.

When returning the seat-back to its original position, push it firmly back. Also, make sure all rear shoulder belts are positioned in front of the seat-back.

Make sure that the folded seat-back does not press against the front passenger seat, as this can cause the weight sensors in the front passenger seat to work improperly.

❗ **Passenger Front Airbag Off Indicator** P. 58

Make sure all items in the trunk or items extending through the opening into the rear seats are properly secured. Loose items can fly forward if you have to brake hard.

The front seat(s) must be far enough forward so they do not interfere with the rear seats as they fold down.

Armrest

■ Using the Front Seat Armrest

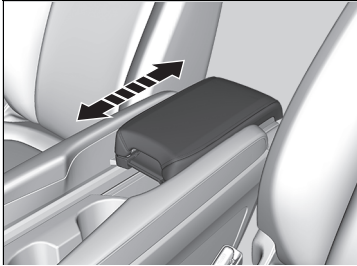

The console lid can be used as an armrest.

To adjust:

Slide the armrest to desired position.

Interior Lights

Interior Light Switches

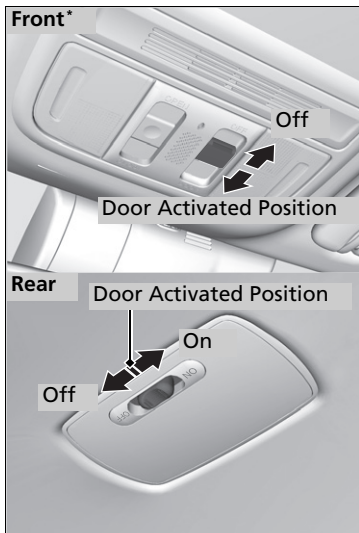

■ ON

The interior lights come on regardless of whether the doors are open or closed.

■ Door activated

The interior lights come on in the following situations:

- When either of the doors are opened.
- You unlock the driver's door.

■ Models without smart entry system

- You remove the key from the ignition switch.

■ Models with smart entry system

- When the power mode is set to VEHICLE OFF (LOCK).

■ OFF

The interior lights remain off regardless of whether the doors are open or closed.

» Interior Light Switches

In the door activated position, the interior lights fade out and go off about 30 seconds after the doors are closed. The lights go off after 30 seconds in the following situations:

- When you unlock the driver's door but do not open it.

■ Models without smart entry system

- When you remove the key from the ignition switch but do not open a door.

■ Models with smart entry system

- When you set the power mode to VEHICLE OFF (LOCK) but do not open a door.

■ Models with Display Audio

You can change the interior lights dimming time.

➔ Customized Features P. 316

The interior lights go off immediately in the following situations:

- When you lock the driver's door.
- When you turn the ignition switch to ON **II***1.

■ Models without smart entry system

- When you close the driver's door with the key in the ignition switch.

■ Models with smart entry system

- When you close the driver's door in ACCESSORY mode.

If you leave either door open in VEHICLE OFF (LOCK) mode, or without the key in the ignition switch, the interior lights go off after about 15 minutes.

*1: Models with the smart entry system have an **ENGINE START/STOP** button instead of an ignition switch.

Map Lights

Models without moonroof

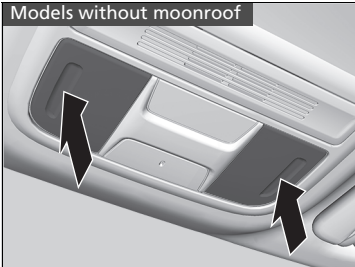

Models with moonroof

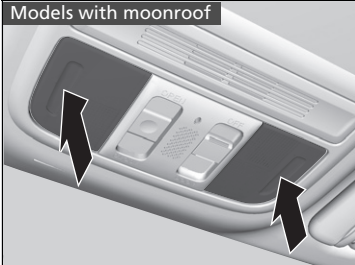

The map lights can be turned on and off by pressing the lenses.

Map Lights

Models with moonroof

When the front interior light switch is in the door activated position and either of the door is open, the map light will not go off when you press the lens.

Interior Convenience Items

■ Glove Box

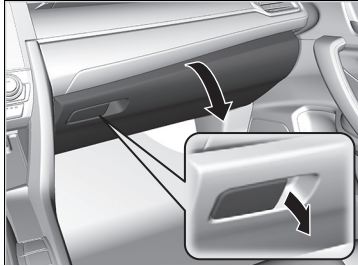

Pull the handle to open the glove box.

☞ Glove Box

⚠ WARNING

An open glove box can cause serious injury to your passenger in a crash, even if the passenger is wearing the seat belt.

Always keep the glove box closed while driving.

■ Console Compartment

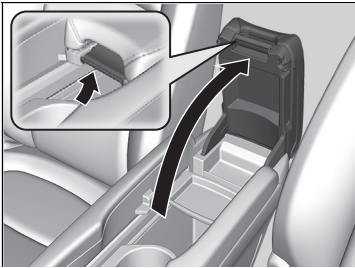

Your vehicle has a multi-function center console. It includes a storage compartment, an armrest, and a sliding tray*. Slide the armrest to the rearmost position. Pull the handle to open the console compartment.

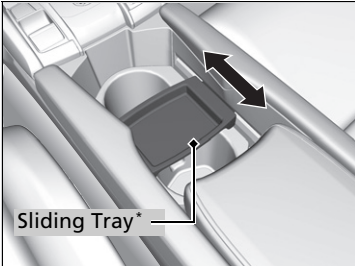

You can put small items in the sliding tray* located in the console compartment lid. Slide the sliding tray forward or rearward.

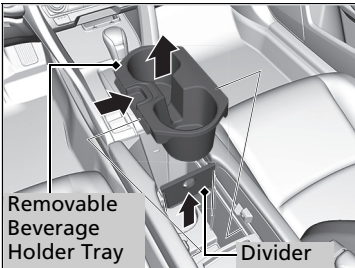

You can create more storage space by removing the removable beverage holder tray and a divider.

* Not available on all models

■ Beverage Holders

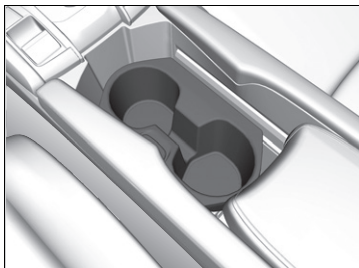

■ Front seat beverage holders

Are located in the console between the front seats.

- Move the armrest rearward to use the beverage holders.

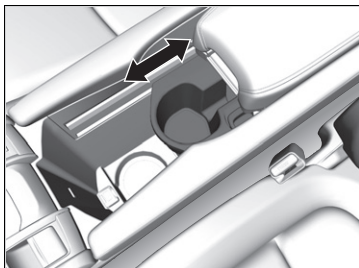

To place a short beverage container:

Move the removable beverage holder tray forward.

To place a tall beverage container: Move the removable beverage holder tray rearward.

► Beverage Holders

NOTICE

Spilled liquids damage the upholstery, carpeting, and electrical components in the interior.

Be careful when you are using the beverage holders. Hot liquid can scald you.

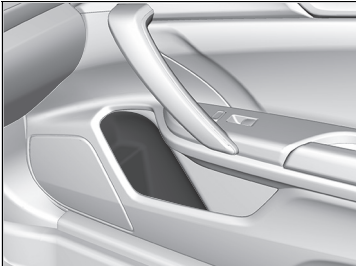

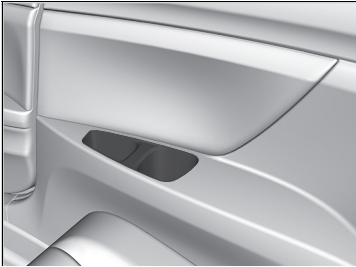

■ Door beverage holders



■ Rear seat beverage holders

■ Accessory Power Socket

The accessory power socket can be used when the ignition switch is in ACCESSORY  or ON *1.

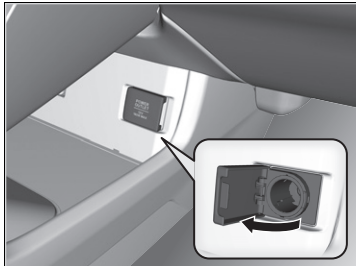

Open the cover to use it.

▶▶ Accessory Power Socket

NOTICE

Do not insert an automotive type cigarette lighter element: The power socket can overheat.

The accessory power socket is designed to supply power for 12 volt DC accessories that are rated 180 watts (15 amps) or less.

To prevent battery drain, use the power socket only when the engine is running.

*1: Models with the smart entry system have an **ENGINE START/STOP** button instead of an ignition switch.

Canadian models

Wireless Charger*

To use the wireless charger, the power mode must be in ACCESSORY or ON. Charge a compatible device on the area indicated by the  mark as follows:

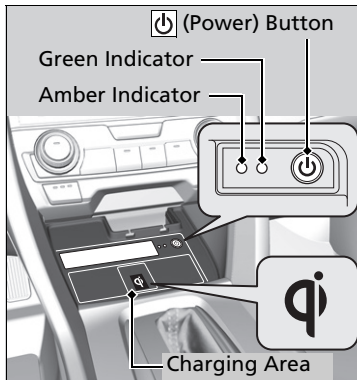

1. To turn the system on and off, press and hold the  (power) button.
 - When the system is activated, the green indicator light comes on.
2. Place the device you want to charge on the charging area.
 - The system will automatically start charging the device, and the amber indicator light will come on.
 - Make sure that the device is compatible with the system and placed with the chargeable side in the center of the charging area.
3. When charging is completed, the green indicator light will come on.
 - Depending on the device, the amber indicator light will stay on.

Wireless Charger*

CAUTION

Metal objects between the charge pad and the device to be charged will get hot and can burn you.

- Always remove foreign objects from the charge pad before charging the device.
- Be sure the surface is clear of dust and other debris before charging.
- Do not spill liquids (i. e. water, drinks, etc.) on the charger and the device.
- Do not use oil, grease, alcohol, benzine or thinner for cleaning the charge pad.
- Do not cover the system with towels, clothing, or other objects while charging etc.
- Avoid spraying aerosols which may come in contact with the charge pad surface.

This system consumes a lot of power. Do not use the system for a long time when the engine is not running. This may weaken the battery, making it difficult to start the engine.

When using the wireless charger, check the user's manual that came with the compatible device you want to charge.

* Not available on all models

■ When charging does not start

Perform one of the solutions in the following table.

Indicator		Cause	Solution
Green & Amber	Blinking simultaneously	There is an obstacle(s) between the charging area and the device.	Remove the obstacle(s).
		The device is not within the charging area.	Move the device to the center of the charging area where  is located.
Amber	Blinking	The wireless charger is faulty.	Contact a dealer for repairs.

Wireless Charger*

NOTICE

Do not place any magnetic recording media or precision machines within the charging area while charging. The data on your cards such as credit cards can be lost because of the magnetic effect. Also precision machines such as watches can go wrong.

“Qi” and  marks are the registered trademarks owned by Wireless Power Consortium (WPC).

In the following cases, charging may stop or not start:

- The device is already fully charged.
- The temperature of the device is extremely high while charging.
- You are at a place that emits strong electromagnetic wave or noises, such as a TV station, electric power plant, or gas station.

A device may not charge if the size or shape of its chargeable side is not appropriate for use with the charging area.

Not all devices are compatible with the system.

During the charging phase, it is normal for the charging area and device to heat up.

Charging may be briefly interrupted when:

- Both doors and the trunk are closed - to avoid interference with the proper functioning of the smart entry system.
- The position of the device is altered.

Do not charge more than one device at a time on a charging area.

■ Coat Hooks

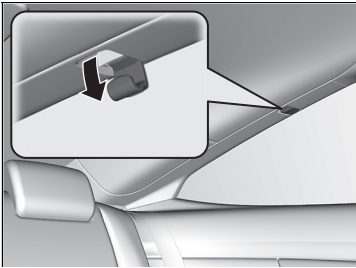

There are coat hooks behind the center pillar on both sides. Pull them down to use them.

☒ Coat Hooks

The coat hook is not designed for large or heavy items.

■ Seat Heaters*



The ignition switch must be in ON *1 to use the seat heaters.

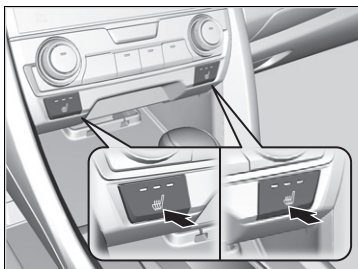

Press the seat heater button:

Once - The HI setting (three indicators on)

Twice - The MID setting (two indicators on)

Three times - The LO setting (one indicator on)

Four times - The OFF setting (no indicators on)

▣ Seat Heaters*

WARNING

Heat induced burns are possible when using seat heaters.

Persons with a diminished ability to sense temperature (e.g., persons with diabetes, lower-limb nerve damage, or paralysis) or with sensitive skin should not use seat heaters.

Do not use the seat heaters even in LO when the engine is off. Under such conditions, the battery may be weakened, making the engine difficult to start.

*1: Models with the smart entry system have an **ENGINE START/STOP** button instead of an ignition switch.

* Not available on all models

Using Automatic Climate Control

The automatic climate control system maintains the interior temperature you select. The system also selects the proper mix of heated or cooled air that raises or lowers the interior temperature to your preference as quickly as possible.

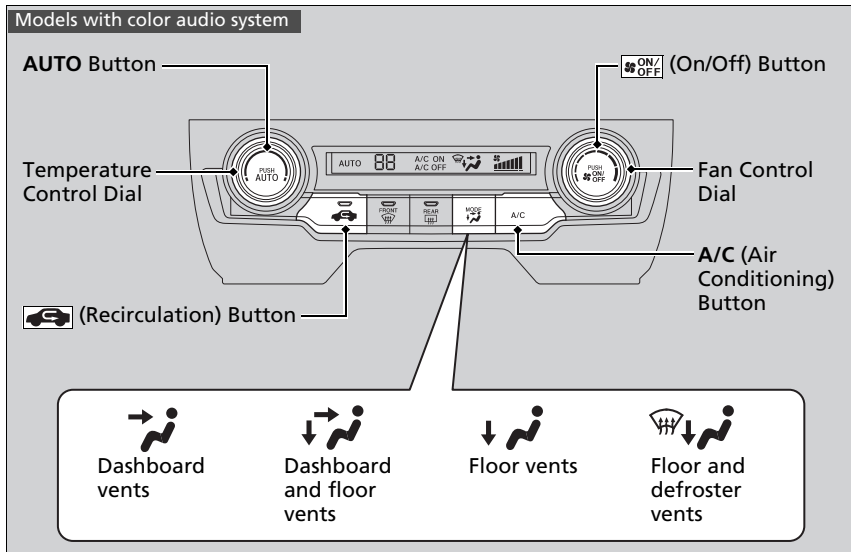

Use the system when the engine is running.

1. Press the **AUTO** button.
2. Adjust the interior temperature using the temperature control dial.
3. Press the **ON/OFF** (on/off) button to cancel.

* Not available on all models

Using Automatic Climate Control

If any buttons/icons* are pressed while using the climate control system in auto, the function of the button/icon* that was pressed will take priority.

The **AUTO** indicator will go off, but functions unrelated to the button/icon* that were pressed will be controlled automatically.

To prevent cold air from blowing in from outside, the fan may not start immediately when the **AUTO** button is pressed.

If the interior is very warm, you can cool it down more rapidly by partially opening the windows, turning the system on auto, and setting the temperature to low. Change the fresh air mode to recirculation mode until the temperature cools down.

When you set the temperature to the lower or upper limit, **Lo** or **Hi** is displayed.

Continued

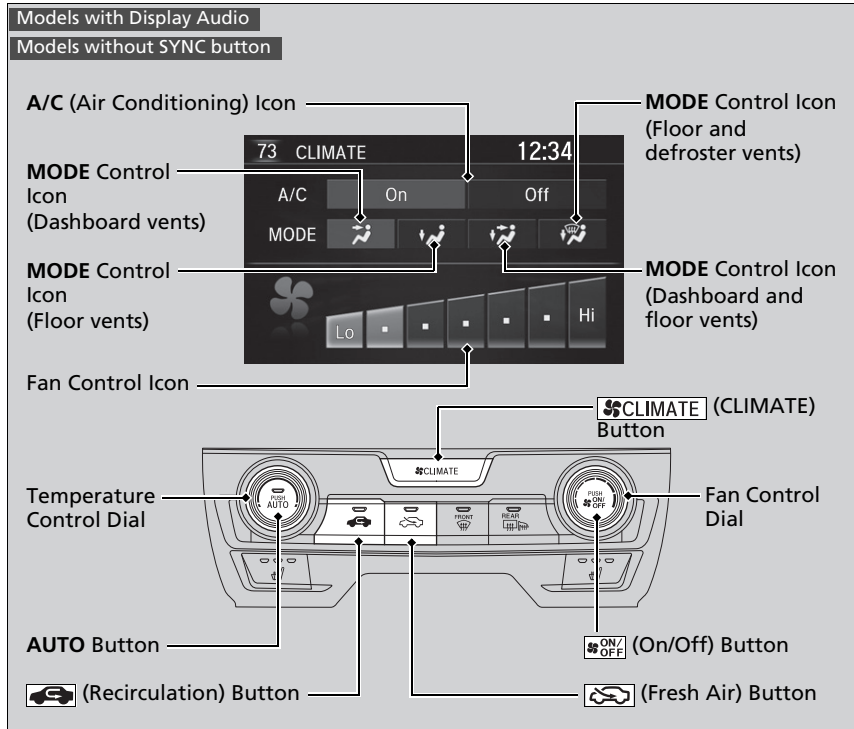

Use the system when the engine is running.

1. Press the **AUTO** button.
2. Adjust the interior temperature using the temperature control dial.
3. Press the **ON/OFF** (on/off) button to cancel.

►► Using Automatic Climate Control

Pressing the **ON/OFF** button switches the climate control system between on and off. When turned on, the system returns to your last selection.

Models with ECON button

While ECON mode is active, the climate control system may have reduced cooling performance.

Models with Display Audio

Press the **CLIMATE** (CLIMATE) button to display **A/C**, **MODE**, fan control information on the audio/info information screen to operate manually. Select icon to turn on or off **A/C**, change the vent mode, or change the fan speed.

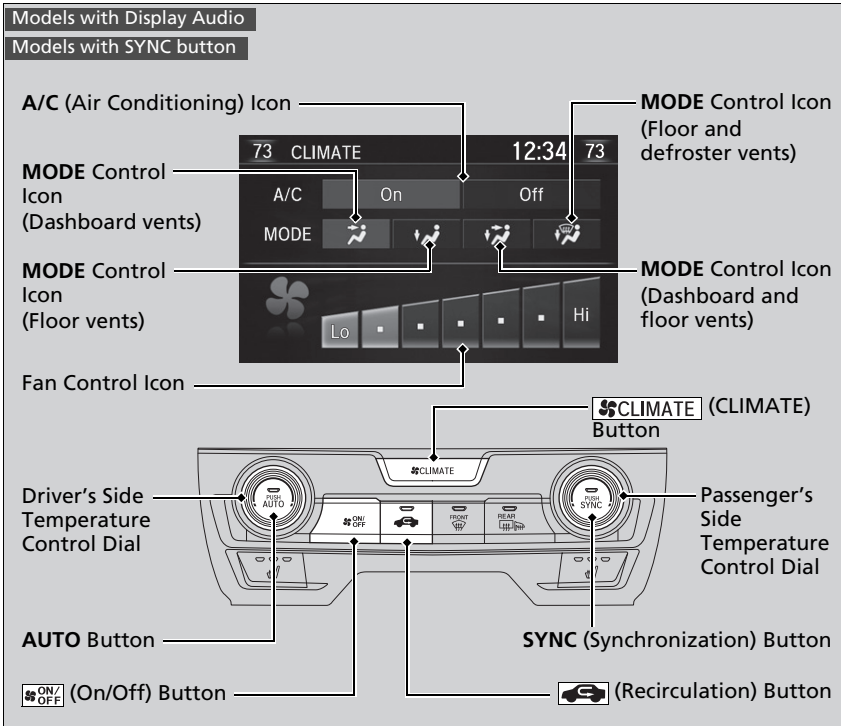

Use the system when the engine is running.

1. Press the **AUTO** button.
2. Adjust the interior temperature using the driver's side or passenger's side temperature control dial.
3. Press the  (on/off) button to cancel.

Continued

■ Switching between the recirculation and fresh air modes



Models without fresh air button

Press the  (recirculation) button and switch the mode depending on environmental conditions.

Recirculation mode (indicator on): Recirculates air from the vehicle's interior through the system.

Fresh air mode (indicator off): Maintains outside ventilation. Keep the system in fresh air mode in normal situations.

Models with fresh air button

Press the  (recirculation) or  (fresh air) button to switch the mode depending on environmental conditions.

 Recirculation mode (indicator on): Recirculates air from the vehicle's interior through the system.

 Fresh air mode (indicator on): Maintains outside ventilation. Keep the system in fresh air mode in normal situations.

Defrosting the Windshield and Windows

Models with color audio system

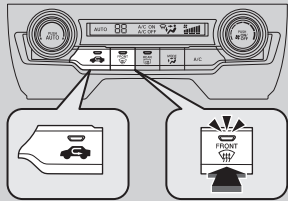

Pressing the  (windshield defroster) button turns the air conditioning system on and automatically switches the system to fresh air mode.

Press the  button again to turn off, the system returns to the previous settings.

Models with Display Audio

Models without SYNC button

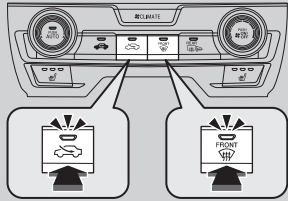

Models with Display Audio

Models with SYNC button

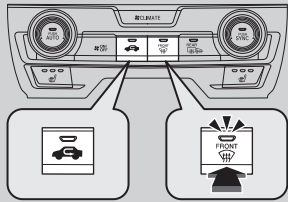

Defrosting the Windshield and Windows

For your safety, make sure you have a clear view through all the windows before driving.

Do not set the temperature near the upper or lower limit.

When cold air hits the windshield, the outside of the windshield may fog up.

If the side windows fog up, adjust the vents so that the air hits the side windows.

■ To rapidly defrost the windows

Models with color audio system

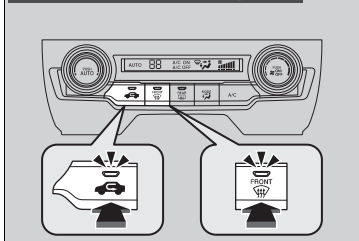

Models with Display Audio

Models without SYNC button

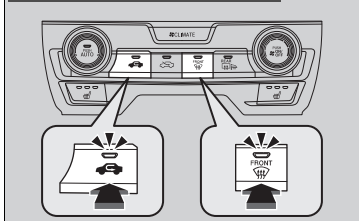

Models with Display Audio

Models with SYNC button

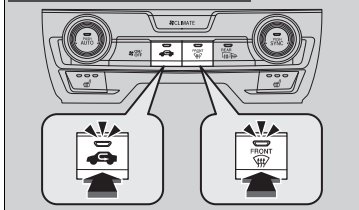

1. Press the  button.
2. Press the  button.

▶▶ To rapidly defrost the windows

After defrosting the windows, switch over to fresh air mode. If you keep the system in recirculation mode, the windows may fog up from humidity. This impedes visibility.

Synchronization Mode*

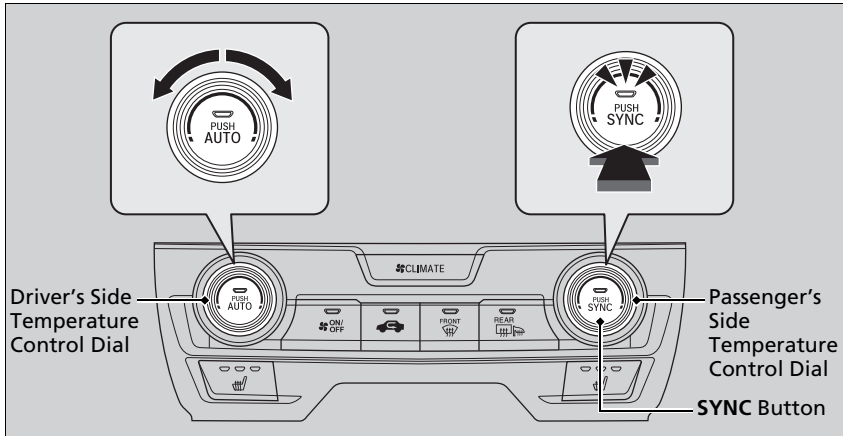

You can set the temperature synchronously for the driver's side and the passenger's side in synchronization mode.

1. Press the **SYNC** button.
 - The system switches to synchronization mode.
2. Adjust the temperature using the driver's side temperature control dial.

Press the **SYNC** button to return to dual mode.

Synchronization Mode*

When the system is in dual mode, the driver's side temperature and the passenger's side temperature can be set separately.

When you press the  button, the system changes to synchronization mode.

* Not available on all models

Automatic Climate Control Sensors

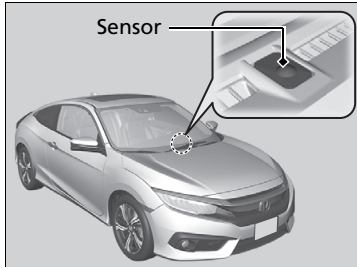

The automatic climate control system is equipped with sensors. Do not cover or spill any liquid on them.

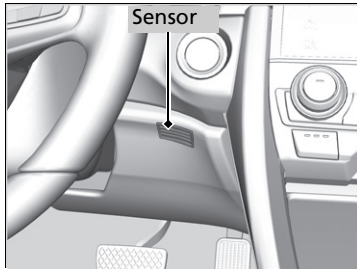

Features

This chapter describes how to operate technology features.

Audio System

About Your Audio System	200
USB Port(s)	201
Audio System Theft Protection	202
Audio Remote Controls	203

Models with color audio system

Audio System Basic Operation	207
Audio/Information Screen	208
Adjusting the Sound	212
Display Setup	213
Playing the AM/FM Radio	214
Playing an iPod	216

Playing a USB Flash Drive	219
Playing <i>Bluetooth</i> ® Audio	222

Models with Display Audio

Audio System Basic Operation	225
Audio/Information Screen	226
Adjusting the Sound	247
Display Setup	248
Voice Control Operation	250
Playing AM/FM Radio	254
Playing SiriusXM® Radio *	258
Playing an iPod	266
Song By Voice™ (SBV)	269
Playing Pandora®*	273

Playing a USB Flash Drive	275
Playing <i>Bluetooth</i> ® Audio	278
HondaLink®	280
Wi-Fi Connection	285
Siri Eyes Free	287
Apple CarPlay	288
Android Auto	291

Audio Error Messages

General Information on the Audio

System	298
---------------------	-----

Customized Features	316
----------------------------------	-----

<i>Bluetooth</i>® HandsFreeLink®	349, 372
---	----------

* Not available on all models

About Your Audio System

The audio system features AM/FM radio and SiriusXM® Radio service*. It can also play USB flash drives, and iPod, iPhone and *Bluetooth*® devices.

You can operate the audio system from the buttons and switches on the panel, the remote controls on the steering wheel, or the icons on the touchscreen interface*.

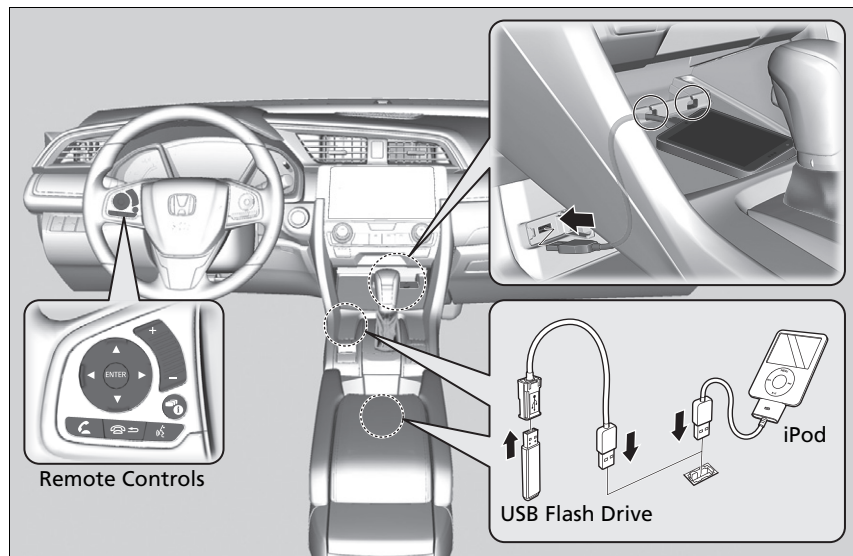

About Your Audio System

SiriusXM® Radio* is available on a subscription basis only. For more information on SiriusXM® Radio*, contact a dealer.

General Information on the Audio System P. 298

SiriusXM® Radio* is available in the United States and Canada, except Hawaii, Alaska, and Puerto Rico.

SiriusXM®* is a registered trademark of SiriusXM Radio, Inc.

iPod, iPhone and iTunes are trademarks of Apple Inc.

State or local laws may prohibit the operation of handheld electronic devices while operating a vehicle.

USB Port(s)

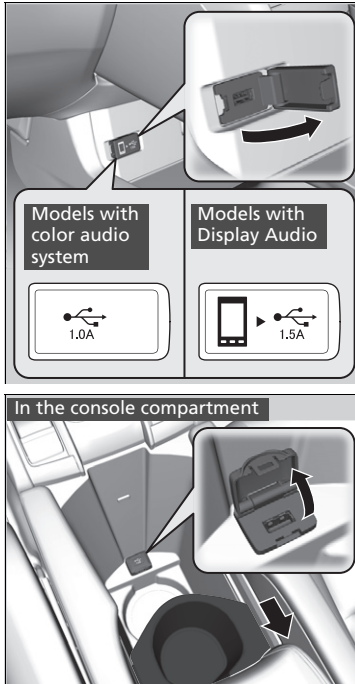

Install the iPod USB connector or the USB flash drive to the front USB port.

Models with color audio system

- ▶ The USB port (1.0A) is for playing audio files on a USB flash drive and connecting a cellular phone and charging device.

Models with Display Audio

- ▶ The USB port (1.5A) is for charging devices, playing audio files and connecting compatible phones with Apple CarPlay or Android Auto.

■ In the console compartment*

The USB port (1.0A) is for playing audio files on the USB flash drive and connecting a cellular phone and charging device.

- ▶ Move the removable beverage holder tray rearward.

⊠ USB Port(s)

- Do not leave the iPod or USB flash drive in the vehicle. Direct sunlight and high temperatures may damage it.
- We recommend using an extension cable with the USB port.
- Do not connect the iPod or USB flash drive using a hub.
- Do not use a device such as a card reader or hard disk drive, as the device or your files may be damaged.
- We recommend keeping your data backed up before using the device in your vehicle.
- Displayed messages may vary depending on the device model and software version.

If the audio system does not recognize the iPod, try reconnecting it a few times or reboot the device. To reboot, follow the manufacturer's instructions provided with the iPod or visit www.apple.com/ipod.

USB charge (1.5A)

The front USB port can supply up to 1.5A of power. It does not output 1.5A unless requested by the device.

For amperage details, read the operating manual of the device that needs to be charged.

Turn the ignition switch to ACCESSORY **I** or ON **II***¹ first.

Under certain conditions, a device connected to the port may generate noise in the radio you are listening to.

*1: Models with the smart entry system have an **ENGINE START/STOP** button instead of an ignition switch.

* Not available on all models

Audio System Theft Protection

The audio system is disabled when it is disconnected from the power source, such as when the battery is disconnected or goes dead. In certain conditions, the system may display a code entry screen. If this occurs, reactivate the audio system.

■ Reactivating the audio system

1. Turn the ignition switch to ON *1.
2. Turn on the audio system.
3. Press and hold the audio system power button for more than two seconds.
 - ▶ The audio system is reactivated when the audio control unit establishes a connection with the vehicle control unit. If the control unit fails to recognize the audio unit, you must go to a dealer and have the audio unit checked.

*1: Models with the smart entry system have an **ENGINE START/STOP** button instead of an ignition switch.

Audio Remote Controls

Models with color audio system

Allow you to operate the audio system while driving.

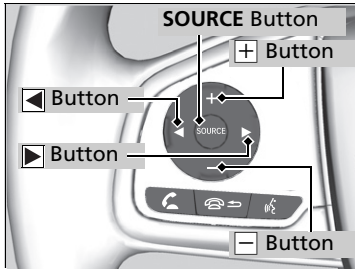

SOURCE Button

Cycles through the audio modes as follows:
FM→AM→USB→iPod→*Bluetooth*® Audio

+ - (Volume) Buttons

Press +: To increase the volume.

Press -: To decrease the volume.

◀ ▶ Buttons

- When listening to the radio
 - Press** ▶: To select the next preset radio station.
 - Press** ◀: To select the previous preset radio station.
 - Press and hold** ▶: To select the next station with strong reception.
 - Press and hold** ◀: To select the previous station with strong reception.
- When listening to an iPod, USB flash drive, or *Bluetooth*® Audio
 - Press** ▶: To skip to the next song.
 - Press** ◀: To go back to the beginning of the current or previous song.
- When listening to a USB flash drive
 - Press and hold** ▶: To skip to the next folder.
 - Press and hold** ◀: To go back to the previous folder.

▶▶ Audio Remote Controls

Some modes appear only when an appropriate device or medium is used.

Depending on the *Bluetooth*® device you connect, some functions may not be available.

Models with Display Audio

Allow you to operate the audio system while driving. The information is shown on the driver information interface.

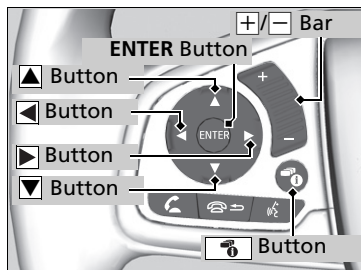

▲/▼ Buttons

Press ▲ or ▼ to cycle through the audio mode as follows:
 FM→AM→SiriusXM®*→USB→iPod
 →Bluetooth® Audio→Pandora®*→Apps*
 →Audio Apps*

ENTER Button

- When listening to the radio and SiriusXM®*
 1. Press **ENTER** to switch the display to a preset list you stored in the preset buttons.
 2. Press ▲ or ▼ to select a preset, then press **ENTER**.
- When listening to a USB flash drive
 1. Press **ENTER** to display the folder list.
 2. Press ▲ or ▼ to select a folder.
 3. Press **ENTER** to display a list of tracks in that folder.
 4. Press ▲ or ▼ to select a track, then press **ENTER**.

▶▶ Audio Remote Controls

Some modes appear only when an appropriate device or medium is used.

Depending on the *Bluetooth*® device you connect, some functions may not be available.

Press the (Hang-up/back) button to go back to the previous command or cancel a command.

Press the button to switch display.

▶▶ Switching the Display P. 115











- When listening to an iPod
 1. Press **ENTER** to display the iPod music list.
 2. Press ▲ or ▼ to select a category.
 3. Press **ENTER** to display a list of items in the category.
 4. Press ▲ or ▼ to select an item, then press **ENTER**.
 - ▶ Press **ENTER** and press ▲ or ▼ repeatedly until the desired mode you want to listen to is displayed.
- When listening to Internet Radio*
 1. Press **ENTER** to display the station list.
 2. Press ▲ or ▼ to select an item, then press **ENTER**.
- When listening to *Bluetooth*® Audio
 1. Press **ENTER** to display the track list.
 2. Press ▲ or ▼ to select a track, then press **ENTER**.

⊕/⊖ (Volume) Bar

Press ⊕: To increase the volume.

Press ⊖: To decrease the volume.

Buttons

- When listening to the radio
 - Press **: To select the next preset radio station.
 - Press **: To select the previous preset radio station.
 - Press and hold **: To select the next strong station.
 - Press and hold **: To select the previous strong station.
- When listening to an iPod, USB flash drive, or *Bluetooth*® Audio
 - Press **: To skip to the next song.
 - Press **: To go back to the beginning of the current or previous song.
- When listening to a USB flash drive
 - Press and hold **: To skip to the next folder.
 - Press and hold **: To go back to the previous folder.
- When listening to Internet radio*
 - Press **: To skip to the next song.
 - Press and hold **: To select the next station.
 - Press and hold **: To select the previous station.

Models with color audio system

To use the audio system, the ignition switch must be in ACCESSORY **I** or ON **II***1.

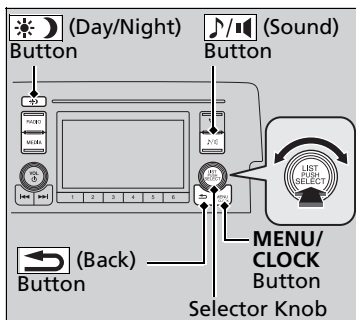

Use the selector knob or **MENU/CLOCK** button to access some audio functions.

Press  to switch between the normal and extended display for some functions.

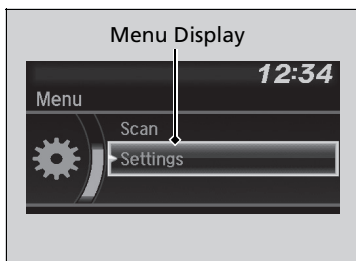



Selector knob: Rotate left or right to scroll through the available choices. Press  to set your selection.



MENU/CLOCK button: Press to select any mode.

The available mode includes the wallpaper, display, clock, language setup, and play modes. Play modes can be also selected from scan, random, repeat, and so on.

 **(Back) button:** Press to go back to the previous display.

 **(Sound) button:** Press to select the sound setting mode.

 **(Day/Night) button:** Press to change the audio/information screen brightness.

Press , then adjust the brightness using .

► Each time you press , the mode switches between the daytime mode, nighttime mode and **OFF** mode.

*1: Models with the smart entry system have an **ENGINE START/STOP** button instead of an ignition switch.

Audio System Basic Operation





These indications are used to show how to operate the selector knob.

Rotate  to select.

Press  to enter.

Menu Items

- **Adjust Clock** P. 126
- **Wallpaper Setup** P. 210
- **Display Setup** P. 213
- **Scan** P. 215, 221
- **Play Mode** P. 218, 221
- **RDS Settings** P. 215
- **Bluetooth** P. 222

Press the **SOURCE**, , ,  or  button on the steering wheel to change any audio setting.

➤ **Audio Remote Controls** P. 203

Audio/Information Screen

Displays the audio status and wallpaper. From this screen, you can go to various setup options.

■ Switching the Display

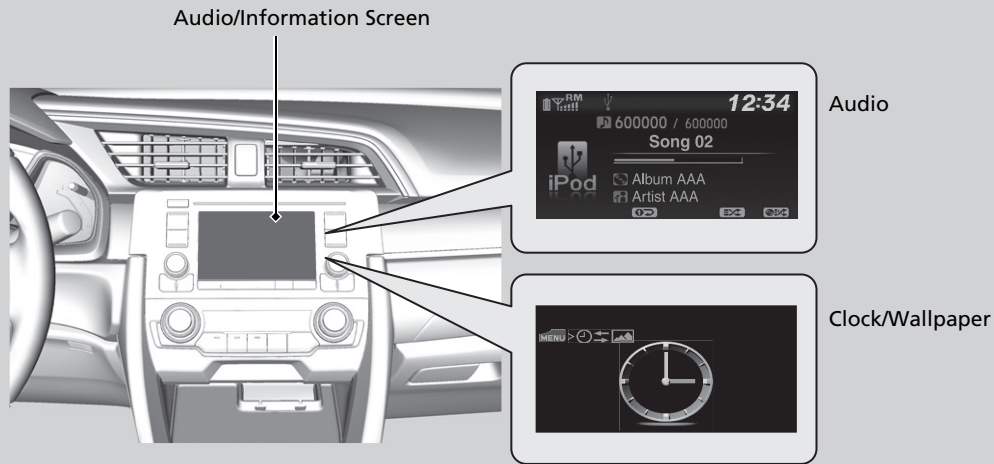







■ Audio

Shows the current audio information.

■ Clock/Wallpaper

Shows a clock screen or an image you import.

■ Change display

1. Press the **MENU/CLOCK** button.
2. Rotate  to select **Settings**, then press .
3. Rotate  to select **Display Change**, then press .
4. Rotate  to select **Wallpaper**, then press .
 - ▶ If you want to return to the audio display, select **Audio**.

■ Wallpaper Setup

You can change, store, and delete the wallpaper on the audio/information screen.

■ Import wallpaper

You can import up to three images, one at a time, for wallpaper from a USB flash drive.

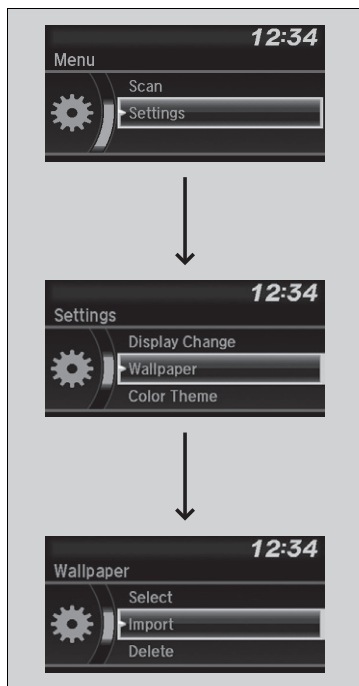









1. Connect the USB flash drive to the USB port.
 ▶ **USB Port(s)** P. 201
2. Press the **MENU/CLOCK** button.
3. Rotate to select **Settings**, then press .
4. Rotate to select **Wallpaper**, then press .
5. Rotate to select **Import**, then press .
 ▶ The picture name is displayed on the list.
6. Rotate to select a desired picture, then press .
 ▶ The selected picture is displayed.
7. Press to save the picture.
8. Press to select **OK**.
9. Rotate to select a location to save the picture, then press .
 ▶ The display will return to the wallpaper setting screen.









▶▶ Wallpaper Setup

- When importing wallpaper files, the image must be in the USB flash drive's root directory. Images in a folder cannot be imported.
- The file name must be fewer than 64 characters.
- The file format of the image that can be imported is BMP (bmp) or JPEG (jpg).
- The individual file size limit is 2 MB.
- The maximum image size is 1,920 x 936 pixels. If the image size is less than 480 x 234 pixels, the image is displayed in the middle of the screen with the extra area appearing in black.
- Up to 255 files can be selected.
- If the USB flash drive does not have any pictures, a message appears.

■ Select wallpaper

1. Press the **MENU/CLOCK** button.
2. Rotate  to select **Settings**, then press .
3. Rotate  to select **Wallpaper**, then press .
4. Rotate  to select **Select**, then press .
 - ▶ The screen changes to the wallpaper list.
5. Rotate  to select a desired wallpaper, then press .

■ To view wallpaper once it is set

1. Press the **MENU/CLOCK** button.
2. Rotate  to select **Settings**, then press .
3. Rotate  to select **Display Change**, then press .
4. Rotate  to select **Wallpaper**, then press .
 - ▶ The screen changes to the wallpaper list.
5. Rotate  to select a wallpaper that you want to set, then press .

■ Delete wallpaper

1. Press the **MENU/CLOCK** button.
2. Rotate  to select **Settings**, then press .
3. Rotate  to select **Wallpaper**, then press .
4. Rotate  to select **Delete**, then press .
 - ▶ The screen changes to the wallpaper list.
5. Rotate  to select a wallpaper that you want to delete, then press .
6. Rotate  to select **Yes**, then press .
 - ▶ The display will return to the wallpaper setting screen.



Wallpaper Setup

To go back to the previous screen, press the  (Back) button.

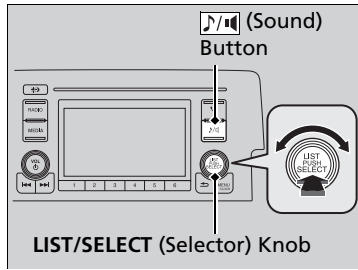

When the file size is large, it takes a while to be previewed.

Adjusting the Sound

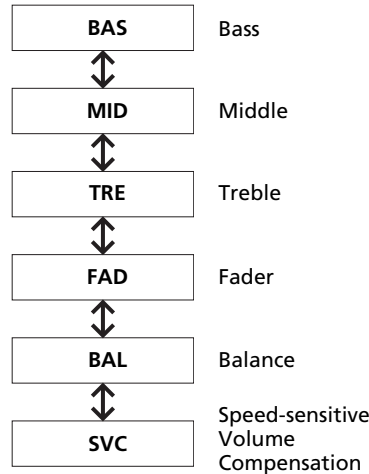
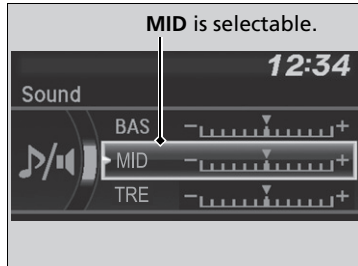

Press the  (sound) button, and rotate  to scroll through the following choices:



Rotate  to adjust the sound setting, then press .

▶▶ Adjusting the Sound

The SVC has four modes: **Off**, **Low**, **Mid**, and **High**. SVC adjusts the volume level based on the vehicle speed. As you go faster, audio volume increases. As you slow down, audio volume decreases.

Display Setup

You can change the brightness or color theme of the audio/information screen.

Changing the Screen Brightness

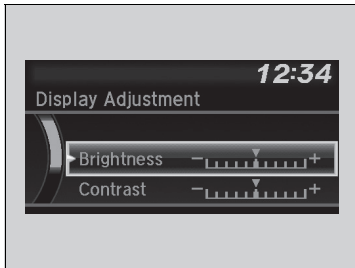

1. Press the **MENU/CLOCK** button.
2. Rotate to select **Settings**, then press .
3. Rotate to select **Display Adjustment**, then press .
4. Rotate to select **Brightness**, then press .
5. Rotate to adjust the setting, then press .

Changing the Screen's Color Theme

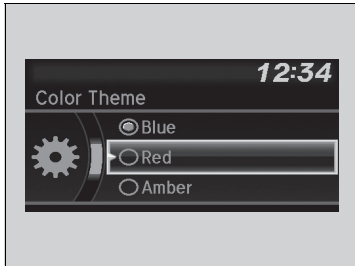

1. Press the **MENU/CLOCK** button.
2. Rotate to select **Settings**, then press .
3. Rotate to select **Color Theme**, then press .
4. Rotate to select the setting you want, then press .

Changing the Screen Brightness

You can change the **Contrast** and **Black Level** settings in the same manner.

Playing the AM/FM Radio

RADIO Button
Press to select a band.

Audio/Information Screen

VOL/⏻ (Volume/power) Knob
Press to turn the audio system on and off.
Turn to adjust the volume.

⏮ / ⏭ (Seek/Skip) Buttons
Press **⏮** or **⏭** to search up and down the selected band for a station with a strong signal.

Preset Buttons (1-6)
To store a station:
1. Tune to the selected station.
2. Pick a preset button and hold it until you hear a beep.
To listen to a stored station, select a band, then press the preset button.

Selector Knob
Turn to tune the radio frequency.
Press, and then turn to select an item. After that, press again to make your selection.



MENU/CLOCK Button
Press to display the menu items.

⏪ (Back) Button
Press to go back to the previous display or cancel a setting.

Radio Data System (RDS)



Provides text data information related to your selected RDS capable FM station.

■ To find an RDS station from Station List

1. Press  while listening to an FM station.
2. Rotate  to select the station, then press .







■ Update List

Updates your available station list at any time.

1. Press  while listening to an FM station.
2. Rotate  to select **Update List**, then press .

■ Radio text

Displays the radio text information of the selected RDS station.

1. Press the **MENU/CLOCK** button.
2. Rotate  to select **Settings**, then press .
3. Rotate  to select **RDS Settings**, then press .
4. Rotate  to select **Radio Text**, then press .

■ Scan

Samples each of the strongest stations on the selected band for 10 seconds.

1. Press the **MENU/CLOCK** button.
2. Rotate  to select **Scan**, then press .

To turn off scan, press .

▶▶ Playing the AM/FM Radio

The **ST** indicator appears on the display indicating stereo FM broadcasts.
Stereo reproduction in AM is not available.

You can store 6 AM stations and 12 FM stations into the preset memory.

Switching the Audio Mode

Press the **SOURCE** button on the steering wheel.

▶ **Audio Remote Controls** P. 203

▶▶ Radio Data System (RDS)

When you select an RDS-capable FM station, the RDS automatically turns on, and the frequency display changes to the station name. However, when the signals of that station become weak, the display changes from the station name to the frequency.

Playing an iPod

Connect the iPod using your USB connector to the USB port, then press the **MEDIA** button.

➔ **USB Port(s)** P. 201

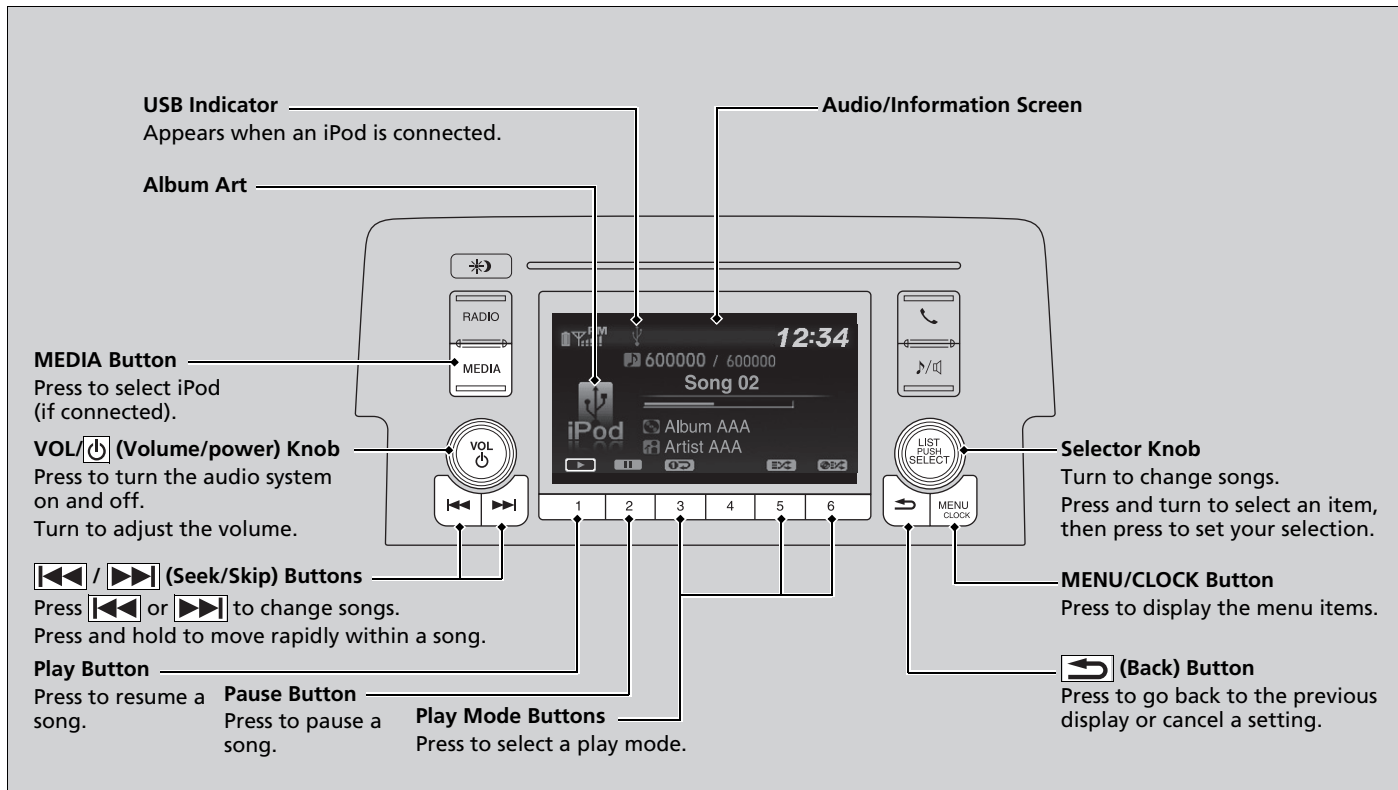

How to Select a Song from the iPod Music List with the Selector Knob



1. Press to display the iPod music list.

2. Rotate to select a category.

3. Press to display a list of items in the category.

4. Rotate to select an item, then press .

- ▶ Press and rotate repeatedly until a desired item you want to listen is displayed.

▶▶ Playing an iPod

Available operating functions vary on models or versions. Some functions may not be available on the vehicle's audio system.

If there is a problem, you may see an error message on the audio/information screen.

iPod/USB Flash Drive P. 295

■ How to Select a Play Mode

You can select repeat and shuffle modes when playing a song.

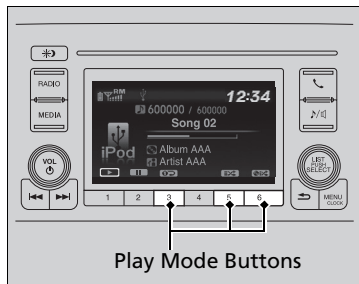

Available mode icons appear above the play mode buttons.

Press the button corresponding to the mode you want to select.

■ To turn off a play mode

Press the selected button.

▶▶ How to Select a Play Mode

Play Mode Menu Items

Shuffle Album: Plays all available albums in a selected category (playlists, artists, albums, songs, genres, or composers) in random order.

Shuffle All: Plays all available songs in a selected category (playlists, artists, albums, songs, genres, or composers) in random order.

Repeat One Track: Repeats the current song.

You can also select a play mode by pressing the **MENU/CLOCK** button.

Rotate to select **Play Mode**, then press .

Rotate to select a mode, then press .

To turn it off, rotate to select **Normal Play**, then press .

Playing a USB Flash Drive

Your audio system reads and plays sound files on a USB flash drive in either MP3, WMA or AAC*1 format.

Connect your USB flash drive to the USB port, then press the **MEDIA** button.

📌 **USB Port(s)** P. 201

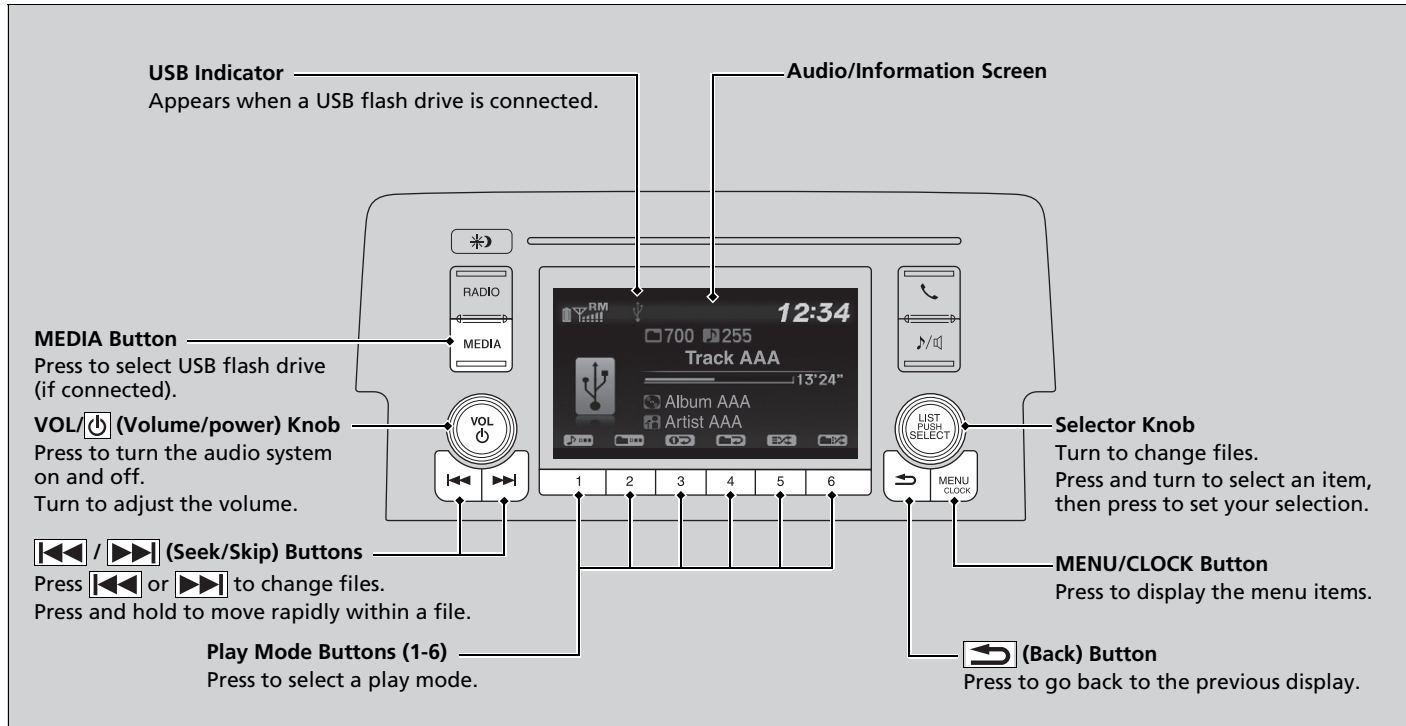

*1: Only AAC format files recorded with iTunes are playable on this unit.

How to Select a File from a Folder with the Selector Knob

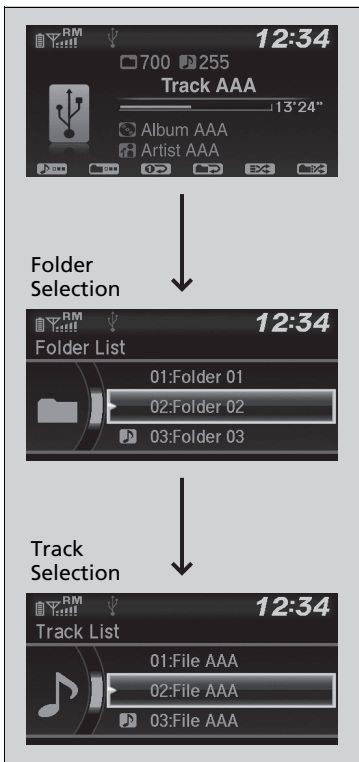

1. Press to display a folder list.
2. Rotate to select a folder.
3. Press to display a list of files in that folder.
4. Rotate to select a file, then press .

▶▶ Playing a USB Flash Drive

Use the recommended USB flash drives.

- ▶ **General Information on the Audio System** P. 298

Files in WMA format protected by digital rights management (DRM) cannot be played. The audio system displays **Unplayable File**, and then skips to the next file.

If there is a problem, you may see an error message on the audio/information screen.

- ▶ **iPod/USB Flash Drive** P. 295

How to Select a Play Mode

You can select repeat, random, and scan modes when playing a file.

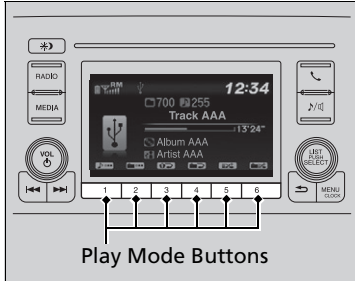

Available mode icons appear above the play mode buttons.

Press the button corresponding to the mode you want to select.

To turn off a play mode

Press the selected button.

How to Select a Play Mode

Play Mode Menu Items

Repeat

Repeat One Folder: Repeats all files in the current folder.

Repeat One Track: Repeats the current file.

Random

Random in Folder: Plays all files in the current folder in random order.

Random All: Plays all files in random order.

Scan

Scan Folders: Provides 10-second sampling of the first file in each of the main folders.

Scan Tracks: Provides 10-second sampling of all files in the current folder.

You can also select a play mode by pressing the **MENU/CLOCK** button.

Rotate to select **Play Mode**, then press .

Rotate to select a mode, then press .

To turn it off, rotate to select **Normal Play**, then press .

Playing *Bluetooth*® Audio

Your audio system allows you to listen to music from your *Bluetooth*-compatible phone.

This function is available when the phone is paired and connected to the vehicle's *Bluetooth*® HandsFreeLink® (HFL) system.

☑ **Phone Setup** P. 355

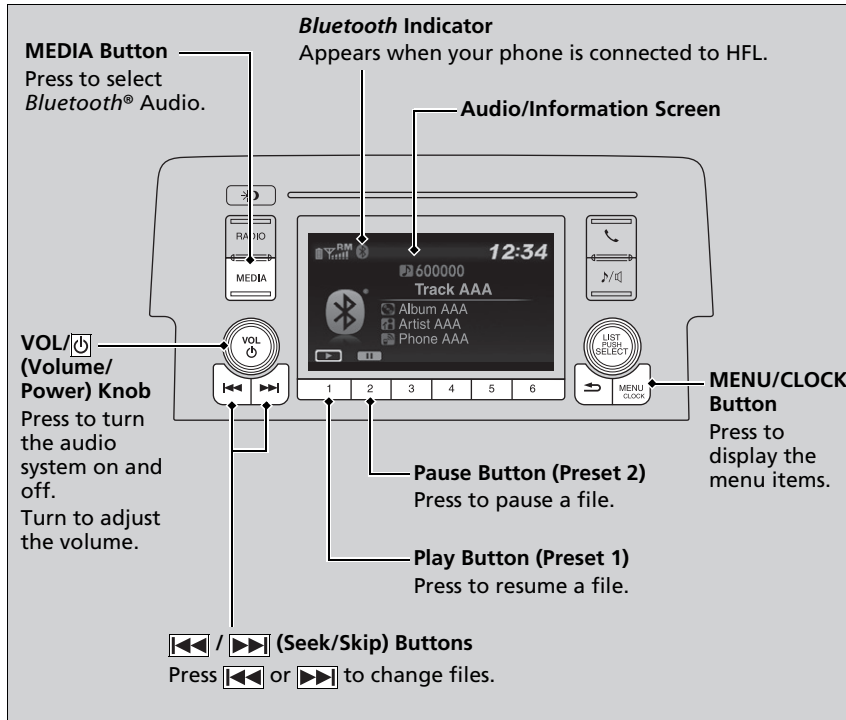

▶▶ Playing *Bluetooth*® Audio

Not all *Bluetooth*-enabled phones with streaming audio capabilities are compatible with the system. For a list of compatible phones:

- U.S.: Visit automobiles.honda.com/handsfreelink/, or call 1-888-528-7876.
- Canada: For more information on smartphone compatibility, call 1-888-528-7876.

In some states, it may be illegal to perform some data device functions while driving.

Only one phone can be used with HFL at a time. When there are more than two paired phones in the vehicle, the first paired phone the system finds is automatically connected.

If more than one phone is paired to the HFL system, there will be a delay before the system begins to play.

In some cases, the name of the artist, album, or track may not appear correctly.

Some functions may not be available on some devices.

■ To Play *Bluetooth*® Audio Files

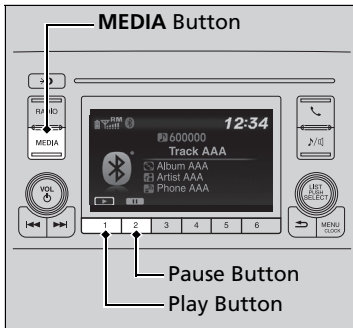

1. Make sure that your phone is paired and connected to HFL.
2. Press the **MEDIA** button until the *Bluetooth*® Audio Source is selected.

If the phone is not recognized, another HFL-compatible phone, which is not compatible for *Bluetooth*® Audio, may already be connected.

■ To pause or resume a file

Press the play or pause button to select a mode.

▶▶ To Play *Bluetooth*® Audio Files

To play the audio files, you may need to operate your phone. If so, follow the phone maker's operating instructions.

The pause function may not be available on some phones.

If any audio device is connected to the auxiliary input jack or USB port, you may need to press the **MEDIA** button repeatedly to select the *Bluetooth*® Audio system.

Switching to another mode pauses the music playing from your phone.

■ How to Select a Song from the Music Search List with the Selector Knob

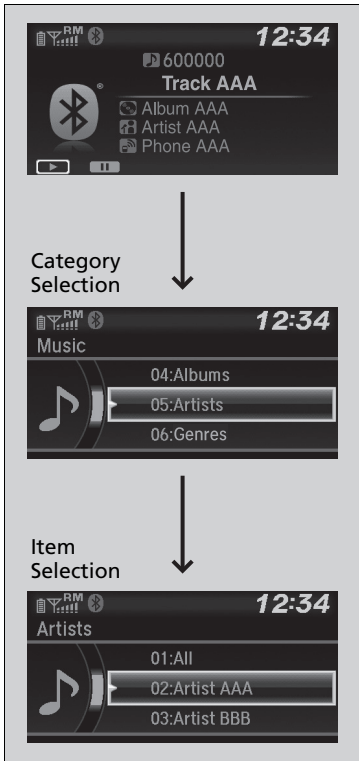

1. Press to display the music search list.

2. Rotate to select a category.



3. Press to display a list of items in the category.
4. Rotate to select an item, then press .
 - ▶ Press and rotate repeatedly until a desired item you want to listen is displayed.

▶▶ How to Select a Song from the Music Search List with the Selector Knob

Depending on the *Bluetooth*® device you connect, some or all of the categories may not be displayed.

Audio System Basic Operation

Models with Display Audio

To use the audio system function, the ignition switch must be in ACCESSORY  or ON *1.

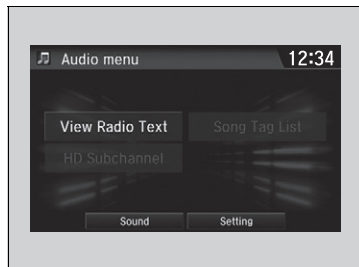
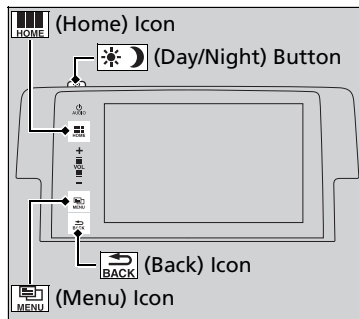





: Select to go to the home screen.

 **Switching the Display** P. 226

: Select to display available options including **Sound**, **View Radio Text**, **Music Search**, and playback modes.

: Select to go back to the previous screen when the icon is illuminated.

 **button**: Press to change the audio/information screen brightness.

Press  once and select  or  to make an adjustment.

▶ Each time you press , the mode switches between daytime, nighttime and off.

Audio System Basic Operation

Audio Menu Items

- ▶ **Station List** P. 255, 256
- ▶ **Music Search List** P. 267, 276, 279
- ▶ **Scan** P. 256, 257, 265, 277
- ▶ **Play Mode** P. 268, 277

*1: Models with the smart entry system have an **ENGINE START/STOP** button instead of an ignition switch.

Audio/Information Screen

Displays the audio status and wallpaper. From this display, you can go to various setup options.

■ Switching the Display

■ Using the button

Press the  (display) button to change the display.

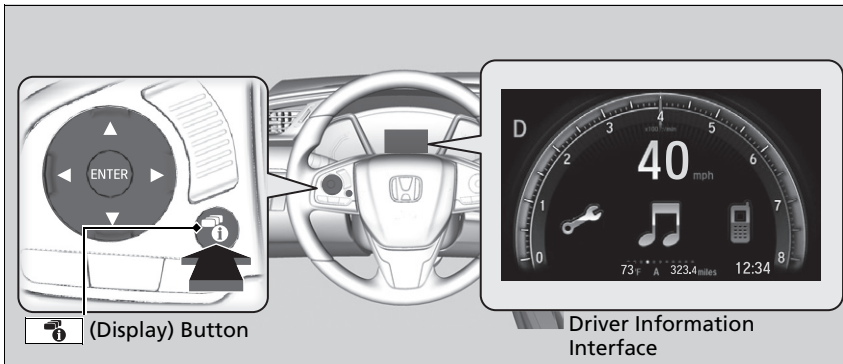



▶▶ Using the button

You can edit, add, and delete the contents shown on the driver information interface.

▶▶ Customizing the Meter P. 231

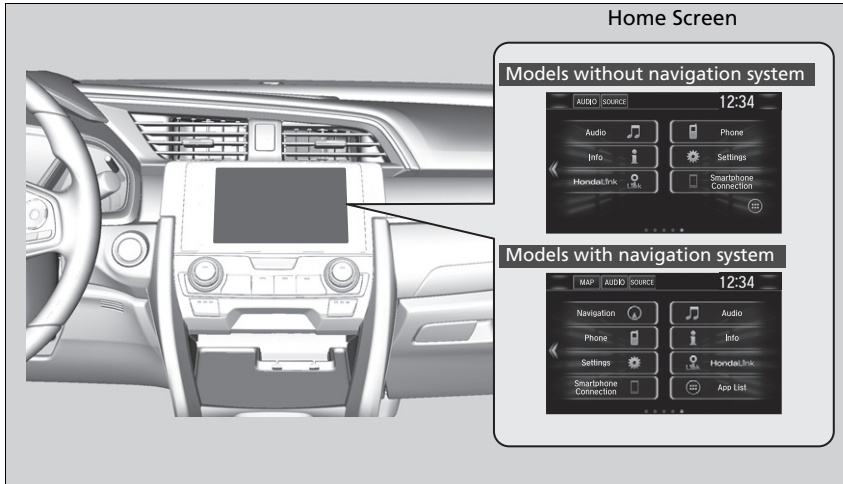
■ Using the audio/information screen



Select  to go to the home screen.

Select **Phone**, **Info**, **Audio**, **Settings**, **Navigation***, **HondaLink**, **Smartphone Connection** (**Apple CarPlay**, **Android Auto**), **App List**, or **Instrument Panel**.

■ Phone

Displays the HFL information.

 **Bluetooth® HandsFreeLink®** P. 372

▶▶ Using the audio/information screen

Touchscreen operation

- Use simple gestures - including touching, swiping and scrolling - to operate certain audio functions.
- Some items may be grayed out during driving to reduce the potential for distraction.
- You can select them when the vehicle is stopped or use voice commands.
- Wearing gloves may limit or prevent touchscreen response.

You can change the touchscreen sensitivity setting.

 **Customized Features** P. 339

■ Info

Displays **Trip Computer** or **Clock/Wallpaper**. Select  on the **Info Menu** screen to see all available options: **Trip Computer**, **Voice Info**, **Clock/Wallpaper** and **System/Device Information**.

Trip Computer:

- **Current Drive** tab: Displays the current trip information.
- **History of Trip A** tab: Displays information for the three previous drives. The information is stored every time you reset Trip A.
To delete the history manually, select **Delete History** on the **History of Trip A** tab. The confirmation message appears on the screen, then select **Yes**.

Voice Info: Displays the all commands list.

Clock/Wallpaper: Displays the clock and wallpaper.

System/Device Information:

- **System Info**: Displays the software version of the audio system.
- **USB Info**: Displays the memory usage of the USB device.

■ Audio

Displays the current audio information.

■ Settings

Enters the customizing menu screen.

- **Customized Features** P. 316

■ Navigation*

Displays the navigation screen.

- **Refer to the Navigation System Manual**

■ HondaLink®

Connects with your smartphone*1 to play personalized music, information, and social media streams.

➤ **HondaLink®** P. 280

■ Smartphone Connection

Connects with your smartphone*1 and allows some apps on your smartphone to be used on the audio system.

➤ **Apple CarPlay** P. 288

➤ **Android Auto** P. 291

■ App List

Adds or removes apps or widgets on the home screen.

➤ **Home Screen** P. 237

■ Instrument Panel

Selects from three customizable settings for the driver information interface.

*1: Available on specific phones only. Check automobiles.honda.com/handsfreelink/ for U.S. and www.handsfreelink.ca for Canada for compatible phones and hondalink.com for U.S. and honda.ca/hondalink for Canada for feature details.

Continued

■ Changing the Home Screen Icon Layout



1. Select .
2. Select and hold an icon.
 - ▶ The screen switches to the customization screen.
3. Drag and drop the icon to where you want it to be.
4. Select **OK**.
 - ▶ The screen will return to the home screen.

■ Customizing the Meter

You can edit, add, or delete the meter contents on the driver information interface.

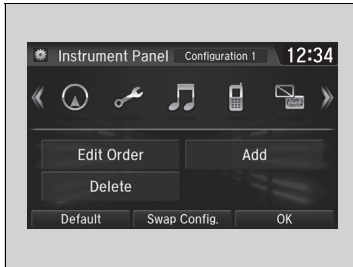

1. 
2. **Settings**
3. **System**
4. **Configuration of Instrument Panel**

☒ Customizing the Meter

You can store up to three customized configurations. To select or customize a configuration, press **Swap Config.**

When you select **Swap Config.** during customization, the settings you changed will be saved.

When you select  during customization, the settings you changed will not be saved and you will be returned to the **Configuration of Instrument Panel** screen.

■ Editing order

To change the order of the icons on the driver information interface, first select:

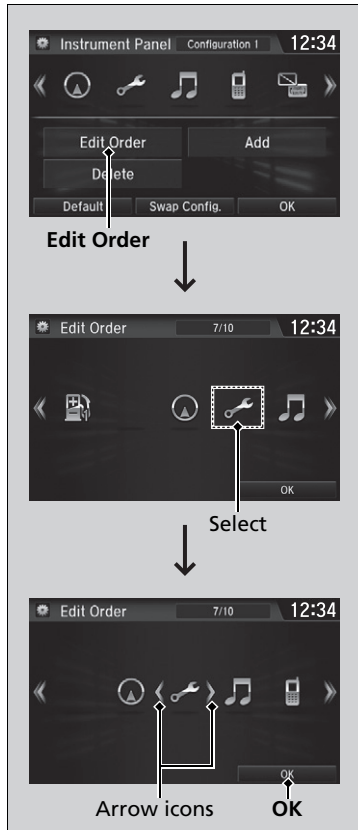

1. Edit Order

2. Select the icon you want to move.

- ▶ You will see arrows on both sides of the selected icon.

3. Select the left or right arrow repeatedly to move the icon to your desired position.

4. Select **OK**.

- ▶ The screen will return to the **Configuration of Instrument Panel** screen.

▶▶ Editing order

You can use an alternative method to change the order of the icons. First select:

1. **Edit Order**

2. Select and hold the icon you want to move.
3. Drag and drop the icon to where you want it to be.
4. Select **OK**.

- ▶ The screen will return to the **Configuration of Instrument Panel** screen.

■ Adding contents

You can add up to 10 contents on the driver information interface. To add contents, first select:

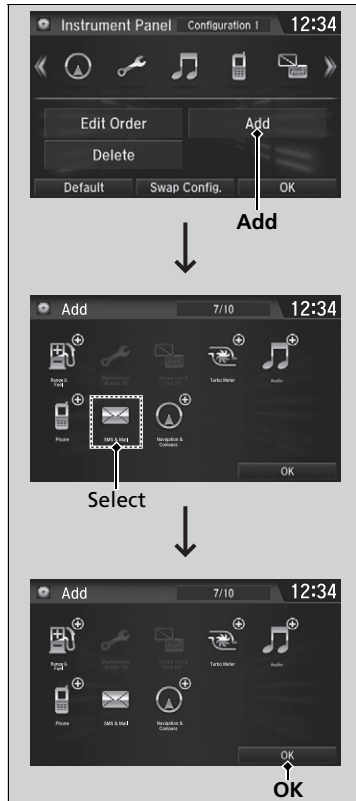

1. Add

2. Select an icon you want to add.

- ▶ You will see a plus mark on the upper right hand corner of the selected icon.

3. Select **OK**.

- ▶ The screen will return to the **Configuration of Instrument Panel** screen.

▶▶ Adding contents

Icons that are grayed out cannot be selected.

If an icon has a plus mark in the upper-right corner, it means that the icon has already been added.

■ Deleting contents

To delete contents on the driver information interface, first select:

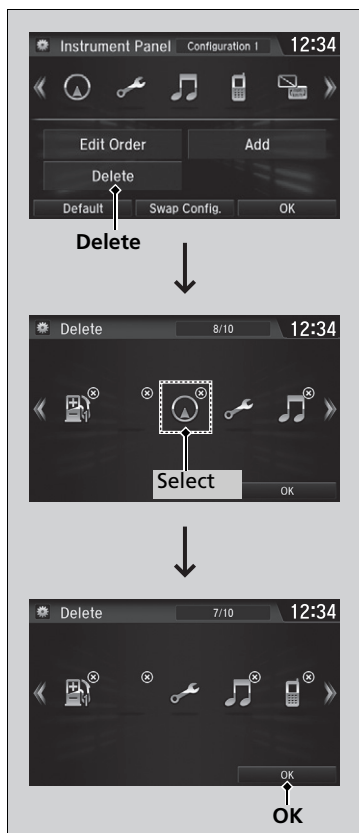

1. Delete

2. Select an icon you want to delete.

- ▶ The icon with an X on the upper right hand corner can be deleted.

3. Select **OK**.

- ▶ The screen will return to the **Configuration of Instrument Panel** screen.

▶▶ Deleting contents

You can also delete contents by selecting:

1. **Delete** or **Edit Order**
2. Select and hold an icon you want to delete.
3. Drag and drop the icon to the trash icon.
4. Select **OK**.

- ▶ The screen will return to the **Configuration of Instrument Panel** screen.

Wallpaper Setup

You can change, store, and delete the wallpaper on the audio/information screen.

Import wallpaper

You can import up to five images, one at a time, for wallpaper from a USB flash drive.

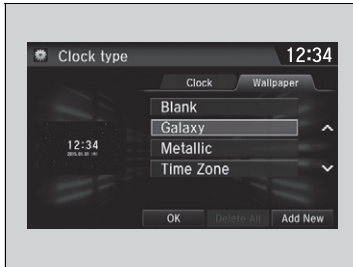

1. Connect the USB flash drive to the USB port.

➤ **USB Port(s)** P. 201

2. Select **Settings**.

3. Select **Clock**.

4. Select **Clock/Wallpaper Type**, then open the **Wallpaper** tab.

5. Select **Add New**.

▶ The picture name is displayed on the list.

6. Select a desired picture.

▶ The preview is displayed on the left side on the screen.

7. Select **Start Import** to save the data.

▶ The display will return to the wallpaper list.

Wallpaper Setup

The wallpaper you set up on **Clock/Wallpaper Type** cannot be displayed on the driver information interface.

- When importing wallpaper files, the image must be in the USB flash drive's root directory. Images in a folder cannot be imported.
- The file name must be fewer than 64 characters.
- The file format of the image that can be imported is BMP (bmp) or JPEG (jpg).
- The individual file size limit is 5 MB.
- The maximum image size is 4,096 × 4,096 pixels. If the image size is less than 800 × 480 pixels, the image is displayed in the middle of the screen with the extra area appearing in black.
- If the USB flash drive does not have any pictures, the **No files detected** message appears.

After changing the screen interface design, you can change the wallpaper by following procedure.

1. Select .
2. Select and hold empty space on the home screen. The pop-up menu appears on the screen.
3. Select **Change Wallpaper**.
4. Select **Gallery**, **Live wallpapers**, or **Wallpapers**.

■ Select wallpaper

1. Select **Settings**.
2. Select **Clock**.
3. Select **Clock/Wallpaper Type**, then open the **Wallpaper** tab.
 - ▶ The screen changes to the wallpaper list.
4. Select a desired wallpaper.
 - ▶ The preview is displayed on the left side on the screen.
 - ▶ The pop-up menu appears on the screen.
5. Select **Set**.
 - ▶ The display will return to the wallpaper list.

■ To view wallpaper once it is set

1. Select .
2. Select **Info**.
3. Select .
4. Select **Clock/Wallpaper**.

■ Delete wallpaper

1. Select **Settings**.
2. Select **Clock**.
3. Select **Clock/Wallpaper Type**, then open the **Wallpaper** tab.
 - ▶ The screen changes to the wallpaper list.
4. Select a wallpaper that you want to delete.
 - ▶ The preview is displayed on the left side on the screen.
 - ▶ The pop-up menu appears on the screen.
5. Select **Delete**.
 - ▶ A confirmation message appears on the screen.
6. Select **Yes** to delete completely.
 - ▶ The display will return to the wallpaper list.

Wallpaper Setup

From the pop-up menu, select **Preview** to see a preview at full-size screen.

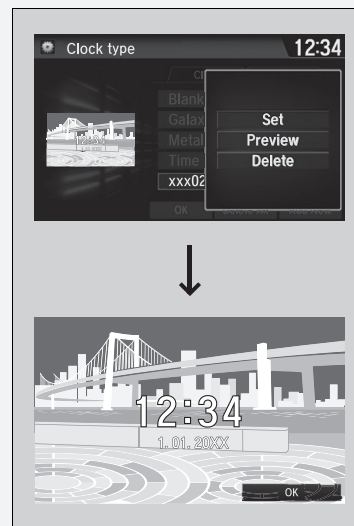

To go back to the previous screen, select **OK**, or select .



When the file size is large, it takes a while to be previewed.

To delete all wallpapers you add, select **Delete All**, then **Yes**.

Home Screen

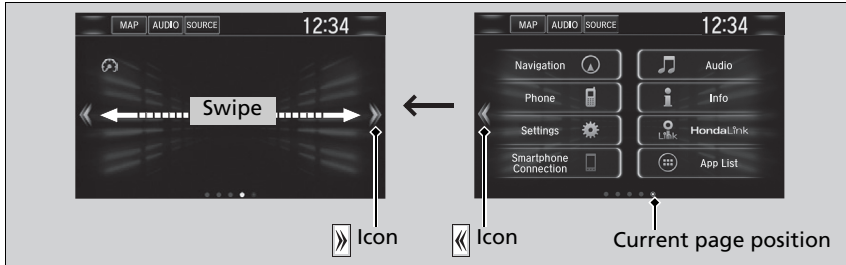
■ To change to a next screen



Selecting  or , or swiping the screen left or right changes to the next screen.



Home Screen

The home screen has 5 pages (fixed). You cannot add any more pages.

Select  to go directly back to the first page of the home screen from any page.

■ To use apps or widgets



1. Select .
2. Select .
3. Select **App List**.
▶ The **Apps** screen appears.
4. Select the app or widget you want to use.

Preinstall app list:

- **App Installer**: Check with a Honda dealer for apps that are available for installation.
- **Calculator**: Displays Calculator.
- **Downloads***1: Displays the data downloaded from the web browser and so on.

▶▶ To use apps or widgets

Select and hold a selected app or widget to add that app's or widget's shortcut on the home screen.

Pre-installed apps may not start up normally. If this occurs, you need to reset the system.

 **Defaulting All the Settings** P. 348

If you perform **Factory Data Reset**, it may reset all the settings to their factory default.

 **Defaulting All the Settings** P. 348

In case those apps still do not startup normally even after **Factory Data Reset**, contact your dealer.

Do not install apps other than those confirmed by a Honda dealer. Installation of unauthorized apps may introduce data corruption risks to your vehicle's information and your privacy.

You can delete user installed apps by the following procedure.

1. Select .
2. Select **Settings**.
3. Select **System**.
4. Select the **Others** tab.
5. Select **Detail Information**.
6. Select an app that you want to delete.
7. Select **Delete**.

Pre-installed apps cannot be deleted.

*1: **Downloads** app cannot be used because there is no Browser function in this system.

■ To add app or widget icons on the home screen

App or widget icons can be added on the home screen.

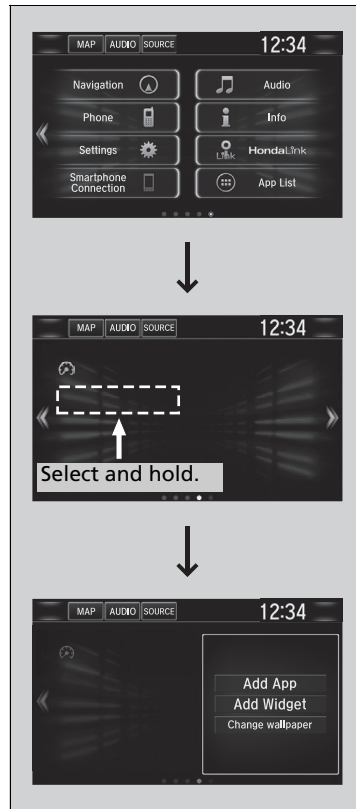

1. Select .
2. Select .
3. Select and hold empty space on the home screen.
 - ▶ The pop-up menu appears on the screen.
4. Select **Add App** or **Add Widget**.
 - ▶ The **App/Widget** screen appears.

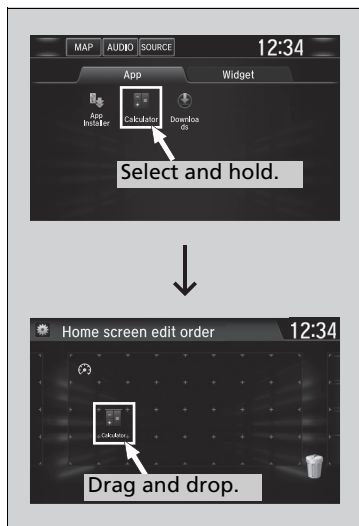

5. Select and hold an app or widget icon you want to add.
 - ▶ The screen switches to the customization screen.
6. Drag and drop the icon to where you want it to be.
7. Select **OK**.
 - ▶ The screen will return to the home screen.

■ To move icons on the home screen

You can change location on the home screen.

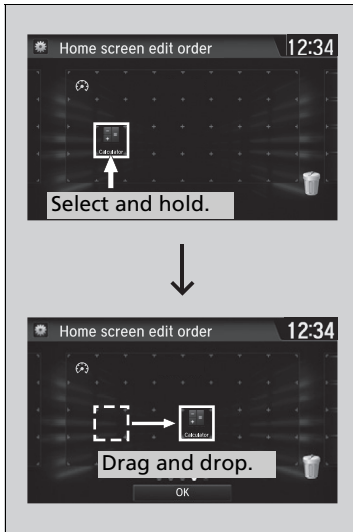

1. Select and hold an icon.
 - ▶ The screen switches to the customization screen.
2. Drag and drop the icon to where you want it to be.
3. Select **OK**.
 - ▶ The screen will return to the home screen.

☒ To move icons on the home screen

You can also move the **Phone, Info, Audio, Settings, Navigation***, **HondaLink, Smartphone Connection, App List**, and **Instrument Panel** icons in the same manner.

* Not available on all models

Continued

■ To remove icons from the home screen

You can delete the icons on the home screen.

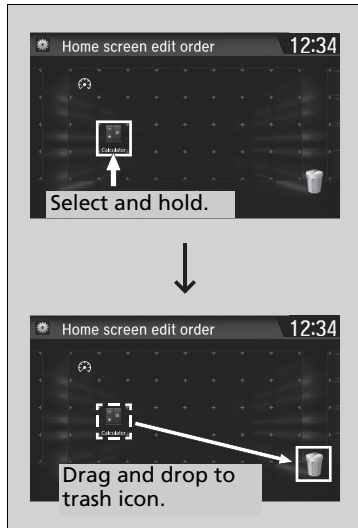

1. Select and hold an icon.
 - ▶ The screen switches to the customization screen.
2. Drag and drop the icon you want to remove to the trash icon.
 - ▶ The icon is removed from the home screen.
3. Select **OK**.
 - ▶ The screen will return to the home screen.

▶▶ To remove icons from the home screen

You cannot delete the **Phone, Info, Audio, Settings, Navigation*, HondaLink, Smartphone Connection, App List, and Instrument Panel** icons.

Apps or widgets will not be deleted by deleting the icon on the home screen.

Status Area

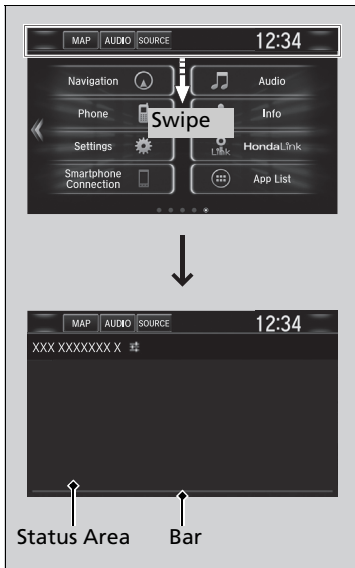

1. Swipe the upper area of the screen.
▶ The status area appears.
2. Select an item to see the details.
3. Select  or swipe up the bottom bar to close the area.

■ Changing the Screen Interface

You can change the screen interface design.



1. Select .
2. Select **Settings**.
3. Select **System**.
4. Select the **Others** tab.
5. Select **Change Skin**.
6. A confirmation message appears on the screen. Select **Yes**.

▶▶ Changing the Screen Interface

After changing the screen interface design, you can change the wallpaper by following procedure.

1. Select .
2. Select and hold empty space on the home screen. The pop-up menu appears on the screen.
3. Select **Change Wallpaper**.
4. Select **Gallery**, **Live wallpapers**, or **Wallpapers**.

If you change the screen interface, some of the setting items will change.

▶ **Customized Features** P. 316

Menu Customize

You can change menu icons on the right side of **Audio**, **Phone**, and **Info** screen.

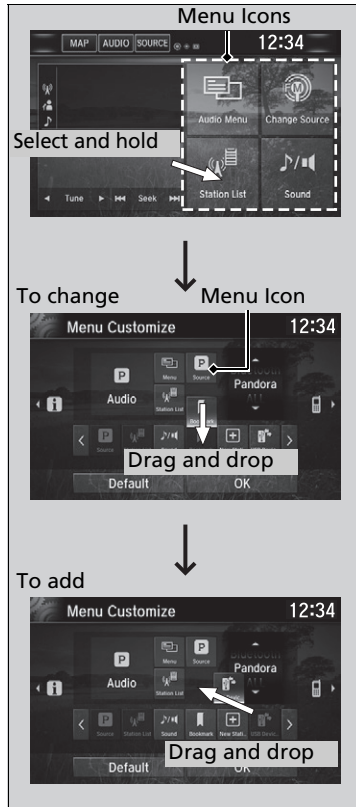

1. Select and hold menu icon.

2. Select ◀ or ▶ icon, then **Audio**, **Phone**, or **Info** from **Menu Customize**.

3. Select and hold the menu icon you want to change, then drag and drop the icon to the bottom.

4. Select and hold the menu icon you want to add, then drag and drop the icon to above.

5. Select **OK**.

Menu Customize

You can also use the method below to change menu icon:

Select **Settings**→**System**→**Home** tab→**Menu icon position**

■ Closing Apps

You can close specific apps running in the background on the system.

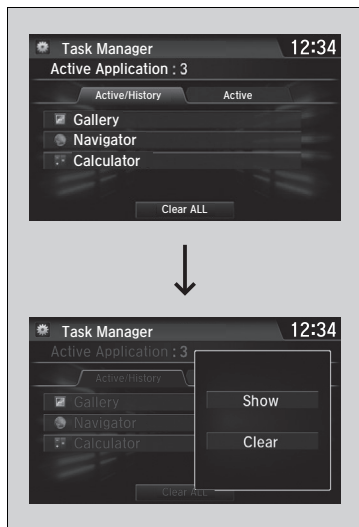

1. Select and hold .
2. Select the **Active** tab.
 - ▶ If you select the **Active/History** tab, you can close the apps that are currently running and delete the app activity history simultaneously.
3. Select an app you want to close.
4. Select **Clear**.
 - ▶ The display will return to the app list.

▶▶ Closing Apps

If you have a number of apps running in the background and something goes wrong with the audio system, some of those apps may not work properly. If this happens, close all the apps and re-launch the app/apps that you want to use.

To close all apps on the system, select **Clear All**, then **Yes**.

You cannot close the HondaLink® and Garmin* apps.

Adjusting the Sound

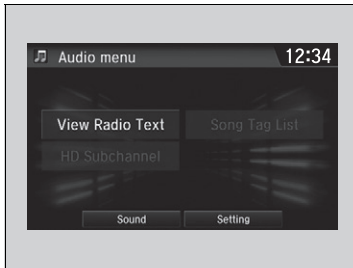

1. Select .
2. Select **Audio**.
3. Select .
4. Select **Sound**.

Select a tab from the following choices:

- **BAS-MID-TRE**: Bass, Middle, Treble
- **FAD-BAL-SUBW***: Fader, Balance, Subwoofer*
- **SVC-Neural***: Speed Volume Compensation, DTS Neural Surround™*

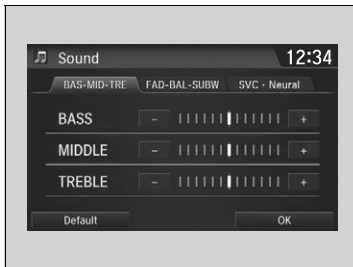

Adjusting the Sound

The SVC has four modes: **Off**, **Low**, **Mid**, and **High**. SVC adjusts the volume level based on the vehicle speed. As you go faster, audio volume increases. As you slow down, audio volume decreases.

* Not available on all models

Display Setup

You can change the brightness or color theme of the audio/information screen.

■ Changing the Screen Brightness

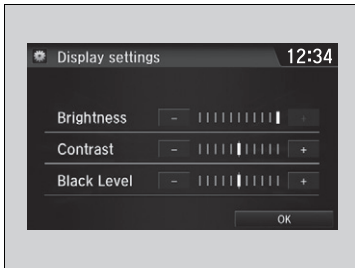

1. Select .
2. Select **Settings**.
3. Select **System**.
4. Select the **Display** tab.
5. Select **Display Settings**.
6. Select the setting you want.
7. Select **OK**.

■ Changing the Screen's Color Theme



1. Select .
2. Select **Settings**.
3. Select **System**.
4. Select the **Display** tab.
5. Select **Background Color**.
6. Select the setting you want.
7. Select **OK**.

☒ Changing the Screen Brightness

You can change the **Contrast** and **Black Level** settings in the same manner.

Selecting an Audio Source

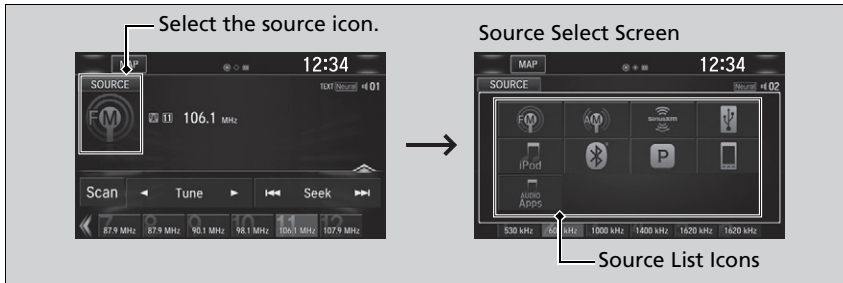

Select the current source icon, then select an icon on the source list to switch the audio source.

Limitations for Manual Operation

Certain manual functions are disabled or inoperable while the vehicle is in motion. You cannot select a grayed-out option until the vehicle is stopped.

Selecting an Audio Source

If you startup preinstalled audio apps, **AUDIO Apps** is displayed on the screen.



These preinstalled apps cannot be displayed on the source select screen.

You can startup those audio apps from **AUDIO Apps**.

Pandora® is available only in the U.S..

Voice Control Operation

Your vehicle has a voice control system that allows hands-free operation.

The voice control system uses the  (Talk) and  (hang-up/back) buttons on the steering wheel and a microphone near the map lights on the ceiling.

Voice Recognition

To achieve optimum voice recognition when using the voice control system:



- Make sure the correct screen is displayed for the voice command that you are using.

The system recognizes only certain commands. Available voice commands.

 **Voice Portal Screen** P. 251

- Close the windows and moonroof*.
- Adjust the dashboard and side vents so air does not blow onto the microphone on the ceiling.
- Speak clearly in a natural speaking voice without pausing between words.
- Reduce any background noise if possible. The system may misinterpret your command if more than one person is speaking at the same time.

Voice Control Operation

When you press the  button, a helpful prompt asks what you would like to do. Press and release the  button again to bypass this prompt and give a command.

Voice Recognition

The voice control system can only be used from the driver's seat because the microphone unit removes noises from the front passenger's side.

Voice Portal Screen

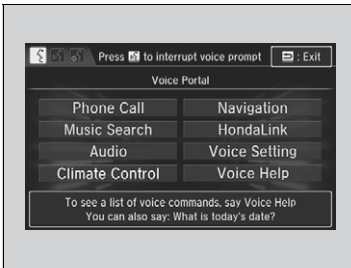

When the  (Talk) button is pressed, available voice commands appear on the screen.

For a complete list of commands, say “Voice Help” after the beep or select **Voice Help**.

You can see the list of commands in **Voice Info** on the **Info menu** screen. Select **Info**, then select .

The system only recognizes the commands on the following pages, at certain screens. Free form voice commands are not recognized.

*1: Models with navigation system

* Not available on all models

Phone Call

This can be only used when the phone is connected. When the system recognizes the *Phone call* command, the screen will change to the voice recognition screen for phone commands.

- *Dial by number*
- *Call history*
- *Redial*
- *Call <Your Contact Name>*
- *Call <Phone Number>*
- *Call Police*
- *Call 911*

Phone Call commands are not available if using Apple CarPlay.

Music Search

This can be only used when the iPod or USB device is connected.

Climate Control*1

When the system recognizes the *Climate Control* command, the screen will change the dedicated screen to the climate control voice recognition screen.

 **Climate Control Commands*1** P. 253

Audio*1

When the system recognizes the *Audio* command, the screen will change to the audio voice recognition screen.

- *Audio On*
- *Audio Off*
- *Radio FM*
- *Radio AM*
- *Radio SXM**
- *Pandora**
- *iPod*
- *USB*
- *Other Sources*

Pandora®* cannot be used while Android Auto is active.

Navigation*1

The screen changes to the navigation screen.

 **Refer to the Navigation System Manual**

HondaLink

This can be only used when the phone is connected.

Voice Setting

The screen changes to the **Voice Recog** tab on the **System settings** screen.

■ Voice Help

You can see a list of the available commands on the screen.

- *Useful Commands*
- *Phone Commands*
- *Audio Commands**¹
- *On Screen Commands*
- *Music Search Commands*
- *General Commands*
- *Climate Control Commands**¹

■ Useful Commands

The system accepts these commands on the voice portal top screen.

- *Call <Phone Number>*
- *Call <Your Contact Name>*
- *What time is it?*
- *What is today's date?*

*1: Models with navigation system

* Not available on all models

■ Phone Commands

The system accepts these commands on the dedicated screen for the voice recognition of the phone.

- *Call by Number*
- *Call by Name*
- *Call <Phone Number>*
- *Call <Your Contact Name>*

■ Audio Commands*¹

The system accepts these commands on the dedicated screen for the voice recognition of the audio.

■ Radio FM Commands

- *Radio tune to <87.7-107.9> FM*
- *Radio tune to <87.7 -107.9> HD <1-8> FM*
- *Radio FM preset <1-12>*

■ Radio AM Commands

- *Radio tune to <530-1710> AM*
- *Radio AM preset <1-6>*

■ Radio SXM Commands*

- *SXM channel <1-255>*

- *SXM channel <channel name, category name, traffic and weather city name, sports team name>*
- *Radio SXM preset <1-12>*

■ Pandora Commands*

- *Pandora play*

■ iPod Commands

- *iPod play*
- *iPod play track <1-30>*
- *Music Search*
- *What album is this?*
- *What am I listening to?*

■ USB Commands

- *USB play*
- *USB play track <1-30>*
- *Music Search*
- *What album is this?*
- *What am I listening to?*

■ Bluetooth® Audio Commands

- *Bluetooth® Audio play*

NOTE:

Bluetooth® Audio commands may not work on some phones or *Bluetooth®* Audio devices.

■ On Screen Commands

When **On Screen Commands** is selected, the explanation screen is displayed.

■ Music Search Commands

The system accepts these commands on the **Music Search** screen.

■ Using Song By Voice

Song By Voice™ is a feature that allows you to select music from your iPod or USB device using Voice Commands. To activate this mode, you must push the talk switch and say: "Music search".

■ Song By Voice Commands

- *What am I listening to?*
- *Who am I listening to?*
- *Who is this?*
- *What's playing?*
- *Who's playing?*
- *What album is this?*

*1: Models with navigation system

*2: These commands toggle the function on and off, so the command may not match your intended action.

*3: U.S. models

*4: Canadian models

■ Play Commands

- *Play artist <Name>*
- *Play track/song <Name>*
- *Play album <Name>*
- *Play genre/category <Name>*
- *Play playlist <Name>*
- *Play composer <Name>*

■ List Commands

- *List artist <Name>*
- *List album <Name>*
- *List genre/category <Name>*
- *List playlist <Name>*
- *List composer <Name>*

■ General Commands

- *What time is it?*
- *What is today's date?*

■ Climate Control Commands*1

- *Climate Control on*2*
- *Climate Control off*2*
- *Fan Speed <1-7>*
- *Temperature max heat*
- *Temperature max cool*
- *Temperature <57-87> degrees*3*
- *Temperature <15-29> degrees*4*
- *Defrost on*
- *Defrost off*
- *Air conditioner on*2*
- *Air conditioner off*2*
- *More*
- *Climate control automatic*
- *Vent*
- *Dash and floor*
- *Fan speed up*
- *Fan speed down*
- *Floor vents*
- *Floor and defrost*
- *Temperature up*
- *Temperature down*

Playing AM/FM Radio



Driver Information Interface

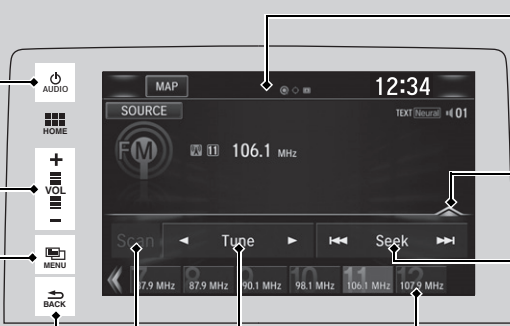

Audio/Information Screen

/AUDIO (Power/Audio) Icon

Select to turn the audio system on and off.

VOL (Volume) Icons

Select to adjust the volume.

(Menu) Icon

Select to display the menu items.

(Back) Icon

Select to go back to the previous display.

Scan Icon

Select to scan each station with a strong signal.

Tune Icons

Select or to tune the radio frequency.

Open/Close Icon^{*1}

Displays/hides the detailed information.

Seek Icons

Select or to search the selected band up or down for a station with a strong signal.

Preset Icons

Tune the preset radio frequency. Select and hold the preset icon to store that station. Select to display preset 7 onwards.

*1: Some or all of the lists may not be displayed.

■ Preset Memory

To store a station:

1. Tune to the selected station.
2. Select and hold the preset number for the station you want to store.

You can also store a preset station by the following procedure.

1. Tune to the selected station.
2. Select the open/close icon to display a list.
3. Select the **Preset** tab.
4. Select and hold the preset number for the station you want to store.

■ Station List

Lists the strongest stations on the selected band.

1. Select the open/close icon to display a list.
2. Select the **Station List** tab.
3. Select the station.

■ Manual update



Updates your available station list at any time.

1. Select the open/close icon to display a list.
2. Select the **Station List** tab.
3. Select **Refresh**.

▶▶ Preset Memory

The **ST** indicator appears on the display indicating stereo FM broadcasts. Stereo reproduction in AM is not available.

Switching the Audio Mode

Press the  or  button on the steering wheel or select **SOURCE** on the screen.

 **Audio Remote Controls** P. 203

You can store 6 AM stations and 12 FM stations into preset memory.

▶▶ Models with HD Radio™ feature

HD Radio Technology manufactured under license from iBiquity Digital Corporation. U.S. and Foreign Patents. HD Radio™ and the HD, HD Radio, and “Arc” logos are proprietary trademarks of iBiquity Digital Corp.



■ Scan

Samples each of the strongest stations on the selected band for 10 seconds. To turn off scan, select **Cancel** or .

Models with HD Radio™ feature

■ HD Subchannel

Displays the subchannel list when an HD Radio™ station is selected while listening to an FM station.

1. Select .
2. Select **HD Subchannel**.
3. Select the channel number.

■ Radio Data System (RDS)

Provides text data information related to your selected RDS-capable FM station.

■ To find an RDS station from Station List

1. Select the open/close icon to display a list while listening to an FM station.
2. Select the **Station List** tab.
3. Select the station.

■ Manual update

Updates your available station list at any time.

1. Select the open/close icon to display a list while listening to an FM station.
2. Select the **Station List** tab.
3. Select **Refresh**.

☒ Radio Data System (RDS)

When you select an RDS-capable FM station, the RDS automatically turns on, and the frequency display changes to the station name. However, when the signals of that station become weak, the display changes from the station name to the frequency.

■ Radio text

Displays the radio text information of the selected RDS station.

1. Select .
2. Select **View Radio Text**.

■ Scan

Samples each of the strongest stations on the selected band for 10 seconds.

To turn off scan, select **Cancel** or .

Playing SiriusXM® Radio*

Driver Information Interface

Channel Icons
 Select or to the previous or next channel.
 Select and hold to rapidly skip 10 channels at a time.

Audio/Information Screen

Album Art

Station Art

Open/Close Icon¹
 Displays/hides the detailed information.

Power/Audio (Power/Audio) Icon
 Press to turn the audio system on and off.

VOL (Volume) Icons
 Select to adjust the volume.

Menu (Menu) Icon
 Select to display the menu items.

Back (Back) Icon
 Select to go back to the previous display.

Scan Icon
 Select to scan each channel.

Category Icons
 Select or to display and select a SiriusXM® Radio category.

Skip Icons
 Select or to change section in the channel. Select and hold to move rapidly within the section.

Preset Icons
 Tune the preset radio station. Select and hold the preset icon to store that station. Select to display preset 7 onwards.

*1: Some or all of the lists may not be displayed.

To Change the Tune Mode

1. Select .
2. Select **Tune Mode**.
3. Select **Channel Mode** or **Category Mode**.



▶▶ Playing SiriusXM® Radio*

In the channel mode, all available channels are selectable. In the category mode, you can select a channel within a category (Jazz, Rock, Classical, etc.).

There may be instances when SiriusXM® Radio does not broadcast all the data fields (artist name, title). This does not indicate a problem with your audio system.

SiriusXM® Radio stations load in ascending order, which can take about a minute. Once they have loaded you will be able to scroll up or down to make your selections.

Switching the Audio Mode

Press the  or  button on the steering wheel or select **SOURCE** on the screen.

 **Audio Remote Controls** P. 203

Tune Start:

When you change to a preset channel, a song being played on that channel restarts from the beginning with this function. This can be turned on or off from the **Audio settings** screen.

 **Customized Features** P. 316

■ Preset Memory

To store a channel:

1. Tune to the selected channel.
2. Press and hold the preset number for the station you want to store.
3. Select **OK**.

You can also store a channel by the following procedure.

1. Tune to the selected channel.
2. Select the open/close icon to display a list.
3. Select the **Preset** tab.
4. Select and hold the preset number for the station you want to store.

■ Multi-channel preset (for music channels only)

You can store up to four of your preferred music channels per preset.



1. Tune a station.
2. Select the open/close icon to display a list.
3. Select the **Preset** tab.
4. Select and hold the preset number you want to add a music channel.
 - ▶ A message appears if there are no available presets.
5. Select **Combine**.

▶▶ Playing SiriusXM® Radio*

You can store 12 SiriusXM® channels into the preset memory.

■ Listening to Featured Channels

Suggested channel listing received from SiriusXM® can be displayed and selected.

1. Select the open/close icon to display a channel list.
2. Select the **Channel** tab.
3. Select the featured channel list title you want to listen to.
 - ▶ The selected channel list of the title is displayed.
4. Select the channel.

▶▶ Listening to Featured Channels

Up to three featured channels by SiriusXM® can be displayed.

Featured channel lists are at the top of the channel list.

Continued

■ Replay Function

The system can record up to the last 60 minutes of your currently tuned channel's broadcast, as well as the last 30 minutes of your preset channel's broadcast, starting from the moment you turn the vehicle on. If you tuned to a preset channel, the system records up to 60 minutes of a broadcast instead of up to 30 minutes. You can rewind and replay the last 30 or 60 minutes of a broadcast.

1. Select .
2. Select **Playback**.
3. Move the time marker to the position you want to replay.

The following items are available on the pop-up screen:

 (Skip Down): Skips to the previously stored channel. Select and hold to fast-rewind the current selection.

 (Skip Up): Skips to the next channel. Select and hold to fast-forward the current selection.

 (15Sec Back): Select to skip back 15 seconds in the current selection. Select and hold to fast-rewind the current selection.

 (15Sec Skip): Select to skip forward 15 seconds in the current selection. Select and hold to fast-forward the current selection.

- ▶ Select **OK** to close the pop-up menu. Replay in playback mode continues.

To play or pause on playback mode:

1. Select .
2. Select **Play/Pause**.

▶▶ Replay Function

The system starts storing broadcast in memory when the power mode is turned ON. You can go back to the program from that point.

You can no longer replay any program once the power mode is turned off as it erases memory. You can check how long the program has been stored in memory from the audio/information screen.

After 30 or 60 minutes of recording the system will automatically start deleting the oldest data.

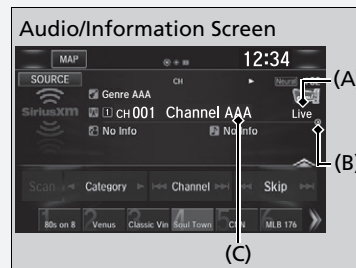

(A): Shows how much time the replayed segment is behind the real-time broadcast

(B): Replayed segment

(C): Length stored in memory

When you listen a multi-channel preset while at the playback mode, the replayed segment is not displayed.

■ Returning to real-time broadcast

1. Select .
2. Select **Go to Live**.

■ Live Sports Alert

While listening to other channels, you can receive sports alerts such as scores from the games of your favorite teams.

■ To set up a favorite team



1. Select .
2. Select **Settings**.
3. Select **Audio**.
4. Select **SportsFlash Setup**.
5. Select **Favorite Team**.
6. Select a team.

■ To set up an alert message

1. Select .
2. Select **Settings**.
3. Select **Audio**.
4. Select **SportsFlash Setup**.
5. Select **Interrupt**.
6. Select **On(one time)** or **On(continue)**.

☒ Live Sports Alert

The sports alert function is available in SiriusXM® mode only.

☒ To set up a favorite team

Sports alerts cut in only when SiriusXM® mode is on. Selecting **On(one time)** from the customize settings disables the alert feature next time you set the power mode to ON.

➤ **Customized Features** P. 316

You can also set up a favorite team by the following procedure.

1. Select **Audio**.
2. Select .
3. Select **Setting**.
4. Select **SportsFlash Setup**.

■ To set up an alert beep

1. Select .
2. Select **Settings**.
3. Select **Audio**.
4. Select **SportsFlash Setup**.
5. Select **Interrupt Beep**.
6. Select **On**.

■ Receiving a sports alert

1. A pop-up appears and notifies you of a sports alert.
2. Select **Listen**.
 - ▶ You can use the same items as the playback mode pop-up screen.

 **Replay Function** P. 262

To go back to the previous screen, select **Back**.

■ Listening to a missed sports alert

If you have missed a sports alert:

1. Select .
2. Select **SportsFlash List**.
3. Select alert.

▶▶ To set up an alert beep

You can also set up a alert beep by the following procedure.

1. Select **Audio**.
2. Select .
3. Select **Setting**.
4. Select **SportsFlash Setup**.

Traffic and Weather Information

You can receive traffic and weather information.

To set up a traffic & weather information

1. Select .
2. Select **Settings**.
3. Select **Audio**.
4. Select **Traffic & Weather Setup**.
5. Select the region.
 - ▶ When you do not want to receive the information, select **Unregistered**.

Listening a traffic and weather information

1. Select .
2. Select **Traffic & Weather**.
 - ▶ Play mode can also use the any items same as playback mode.
 - ▶ **Replay Function** P. 262
 - To go back to the previous screen, select **OK**.

Scan

Sample each channel on the selected mode for 10 seconds.

1. Select **Scan**.
2. Select **Scan Channels**.
 - ▶ You can select the desired channel by songs using **Scan Songs in Preset**.

To turn off scan, select **Cancel Scan**.

Traffic and Weather Information

The traffic and weather information function at SiriusXM® mode only.

You can also set up the traffic and weather information by the following procedure.

1. Select **Audio**.
2. Select .
3. Select **Setting**.
4. Select **Traffic & Weather Setup**.

Traffic & Weather Now are registered trademarks of SiriusXM® Radio, Inc.

Scan

The "Scan Songs in Preset" function is based on TuneScan™ technology of SiriusXM®.

The "Featured Channels" function is based on Featured Favorites™ technology of SiriusXM®.

TuneScan™ and Featured Favorites™ are registered trademarks of SiriusXM® Radio, Inc.

Playing an iPod

Connect the iPod using your USB connector to the USB port, then select the iPod mode.

➔ **USB Port(s)** P. 201

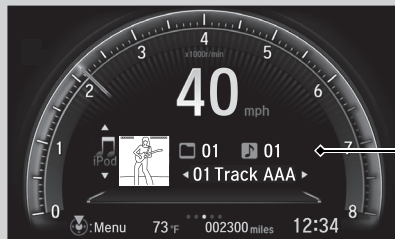

Driver Information Interface

- /AUDIO (Power/Audio) Icon** — Select to turn the audio system on and off.
- VOL (Volume) Icons** — Select to adjust the volume.
- (Menu) Icon** — Select to display the menu items.
- (Back) Icon** — Select to go back to the previous display.
- Cover Art** —

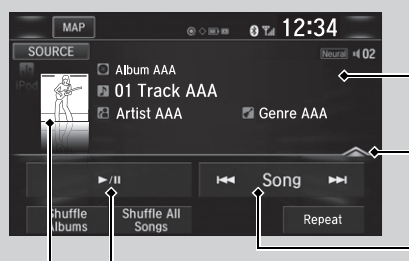

Audio/Information Screen

Open/Close Icon^{*1}
Displays/hides the detailed information.

Song Icons
Select or to change songs.
Select and hold to move rapidly within a song.

Play/Pause Icon

*1:Some or all of the lists may not be displayed.

How to Select a Song from the Music Search List

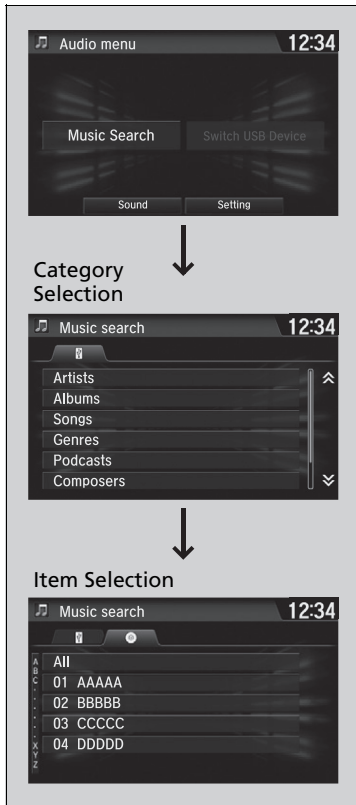

1. Select  and select **Music Search**.

2. Select the items on that menu.

▶▶ Playing an iPod

Available operating functions vary on models or versions. Some functions may not be available on the vehicle's audio system.

If there is a problem, you may see an error message on the audio/information screen.

 **iPod/USB Flash Drive** P. 295

If you operate any music app on your iPhone/iPod while the phone is connected to the audio system, you may no longer be able to operate the same app on the audio/information screen. Reconnect the device if necessary.

Select **Switch USB Device** in the **Audio menu** screen to switch to another USB device.

If an iPhone is connected via Apple CarPlay, the iPod/USB source is unavailable and audio files on the phone can only be played within Apple CarPlay.

■ How to Select a Play Mode

You can select shuffle and repeat modes when playing a file.
Select a play mode.

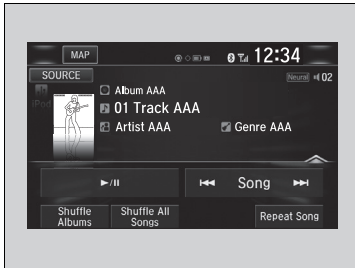

■ To turn off a play mode

Select the mode you want to turn off.

▶▶ How to Select a Play Mode

Play Mode Menu Items

Shuffle All Songs: Plays all available files in a selected list (playlists, artists, albums, songs, podcasts, genres, composers, or audiobooks) in random order.

Shuffle Albums: Plays all available albums in a selected list (playlists, artists, albums, songs, podcasts, genres, composers, or audiobooks) in random order.

Repeat Song: Repeats the current track.

Song By Voice™ (SBV)

Use SBV to search for and play music from your USB flash drive or iPod using voice commands.

■ To enable SBV

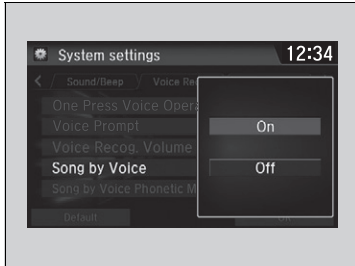

1. Select .
2. Select **Settings**.
3. Select **System**.
4. Select the **Voice Recog.** tab.
5. Select **Song by Voice**.
6. Select **On** or **Off**.



⌘ Song By Voice™ (SBV)

Setting options:

- **On** (factory default): Song By Voice™ commands are available.
- **Off**: Disable the feature.

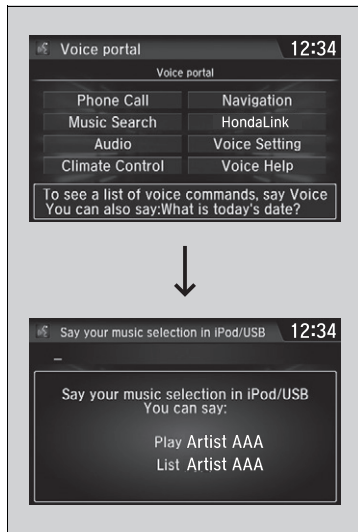
■ Searching for music using SBV



1. Set the **Song by Voice** setting to **On**.
2. Press the  (Talk) button and say “*Music Search*” to activate the SBV feature for the USB flash drive and iPod.
3. Then, say a next command.
 - ▶ Example 1: Say “(List) ‘Artist A’” to view a list of songs by that artist. Select the desired song to start playing.
 - ▶ Example 2: Say “Play ‘Artist A’” to start playing songs by that artist.
4. To cancel SBV, press the  (hang-up/back) button on the steering wheel. The selected song continues playing.

Once you have canceled this mode, you need to press the  button and say “*Music Search*” again to re-activate this mode.

▶▶ Searching for music using SBV

Song By Voice™ Commands List

▶ **Song By Voice Commands** P. 253

NOTE:

Song By Voice™ commands are available for tracks stored on the USB flash drive or iPod.

You can add phonetic modifications of difficult words so that it is easier for SBV to recognize artists, songs, albums, and composers in voice commands.

▶ **Phonetic Modification** P. 271

SBV is not available when using Apple CarPlay. Use Siri instead.

Phonetic Modification

Add phonetic modifications of difficult or foreign words so that it is easier for SBV to recognize artists, songs, albums, and composers in voice commands when searching for music on the USB flash drive or iPod.

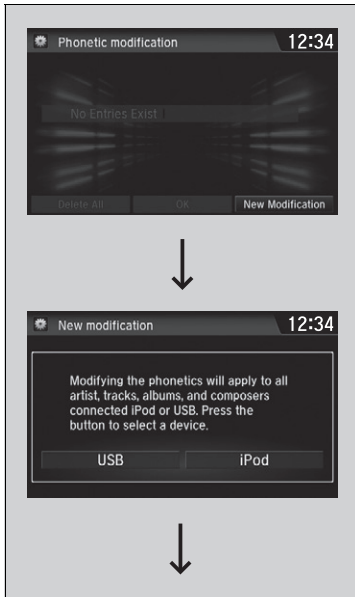



1. Select .
2. Select **Settings**.
3. Select **System**.
4. Select the **Voice Recog.** tab.
5. Select **Song by Voice Phonetic Modification**.
6. Select **New Modification**.
7. Select **USB** or **iPod**.

Phonetic Modification

Song by Voice Phonetic Modification is grayed out when **Song by Voice** is set to **Off**.

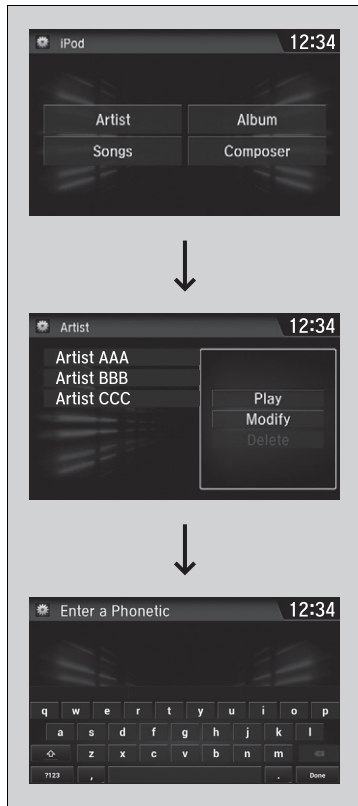
You can store up to 2,000 phonetic modification items.



8. Select the item to modify (e.g., **Artist**).
 - ▶ The list of the selected item appears on the screen.
9. Select an entry to modify.
 - ▶ The pop-up menu appears on the screen.
 - ▶ The listen to the current phonetic modification, select **Play**.
 - ▶ To delete the current phonetic modification, select **Delete**.
10. Select **Modify**.
11. Select the phonetic spelling you want to use (e.g., "Artist A") when prompted.
12. Select **OK**.
 - ▶ The artist "No Name" is phonetically modified to "Artist A." When in the SBV mode, you can press the  (Talk) button and use the voice command "Play 'Artist A'" to play songs by the artist "No Name."

U.S. models

Playing Pandora®*

Your audio system allows you to listen to music from the Pandora® app on a compatible smartphone.

This function is available when the phone is paired and connected to the vehicle's *Bluetooth*® HandsFreeLink® (HFL) system, or with an iPhone, you can connect using your USB cable to the USB port.

▶ **Phone Setup** P. 380

▶ **USB Port(s)** P. 201

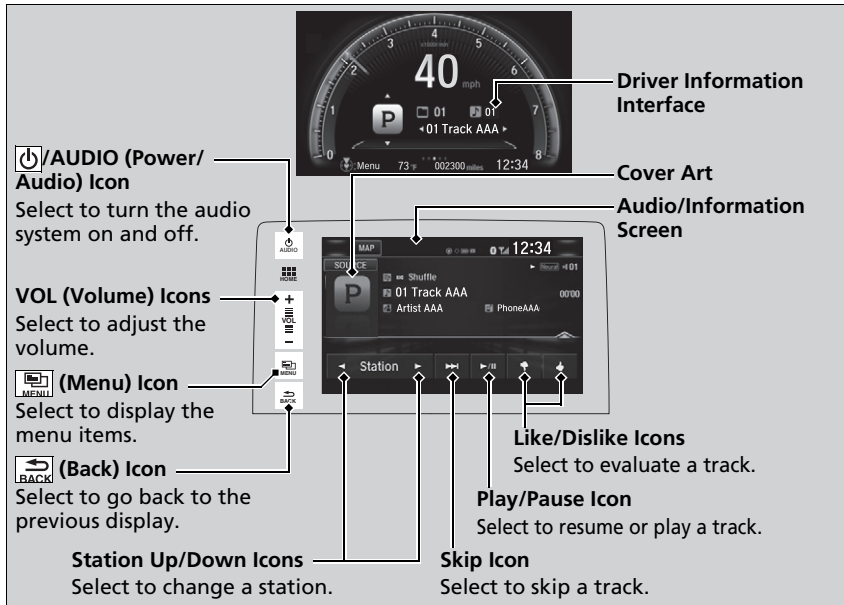

▶▶ Playing Pandora®*

Pandora®, the Pandora logo, and the Pandora trade dress are trademarks or registered trademarks of Pandora Media, Inc., used with permission. Pandora is only available in certain countries. Visit the Pandora website for more information.

To find out if your phone is compatible with this feature, visit automobiles.honda.com/handsfreelink/, or call 1-888-528-7876.

To use this service in your vehicle, the Pandora® app must first be installed on your phone. Visit www.pandora.com for more information.

Pandora® is free, personalized radio that plays music and comedy you'll love. Just start with the name of one of your favorite artists, tracks, comedians or composers and Pandora® will create a custom station that plays similar tracks. Pandora® also features hundreds of genre stations ranging from Dubstep to Smooth Jazz to Power Workout.

If you cannot operate Pandora® through the audio system, it may be streaming through *Bluetooth*® Audio. Make sure Pandora® mode on your audio system is selected.

If your phone is connected to Android Auto, Pandora is only available through the Android Auto interface. Visit the Android Auto website to check compatibility.

* Not available on all models

Continued

■ Pandora® Menu

You can operate some of the Pandora® menu items from your vehicle's audio system. The available items are:

- **Bookmark**
- **Station List**
- **New Station**
- **Sound**
- **Setting**

■ Operating a menu item

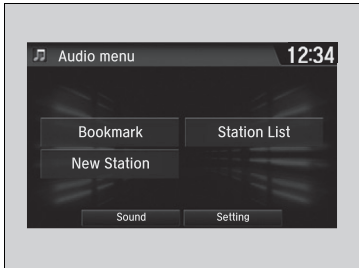

1. Select .
2. Select an item.

▶▶ Pandora® Menu

Available operating functions vary on software versions. Some functions may not be available on the vehicle's audio system.

If there is a problem, you may see an error message on the audio/information screen.

▶▶ **Pandora®*** P. 296

Pandora® may limit the total number of skips allowed on the service. If you dislike a track after the skip limit has been reached, your feedback will be saved but the current track will continue to play.

To change stations, activate the Pandora® menu, select **Station List**, and then select a new station. It also changes stations on the main Pandora® screen.

Playing a USB Flash Drive

Your audio system reads and plays sound files on a USB flash drive in either MP3, WMA, or AAC*1 format.

Connect your USB flash drive to the USB port, then select the USB mode.

📄 **USB Port(s)** P. 201

Driver Information Interface

AUDIO (Power/Audio) Icon
Select to turn the audio system on and off.

VOL (Volume) Icons
Select to adjust the volume.

(Menu) Icon
Select to display the menu items.

(Back) Icon
Select to go back to the previous display.

Folder Icons
Select ▶ to skip to the next folder, and ◀ to skip to the beginning of the previous folder.

Audio/Information Screen

Open/Close Icon*2
Displays/hides the detailed information.

Track Icons
Select ◀◀ or ▶▶ to change files. Select and hold to move rapidly within a track.

*1: Only AAC format files recorded with iTunes are playable on this unit.

*2: Some or all of the lists may not be displayed.

How to Select a File from the Music Search List

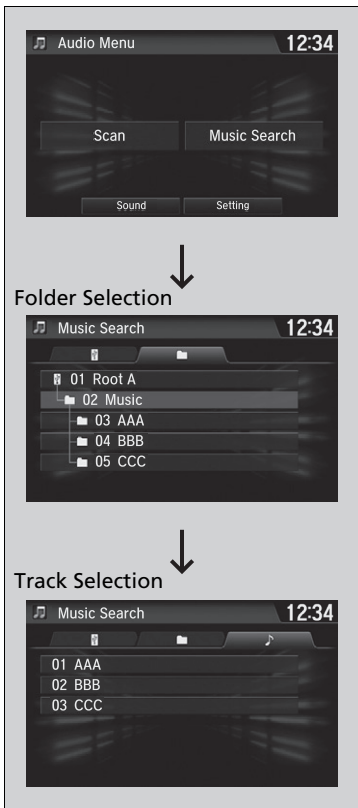

1. Select  and select **Music Search**.
2. Select **Music**.

3. Select a folder.

4. Select a track.

▶▶ Playing a USB Flash Drive

Use the recommended USB flash drives.

▶ **General Information on the Audio System**
P. 298

WMA files protected by digital rights management (DRM) cannot be played.

The audio system displays **Unplayable File**, then skips to the next file.

If there is a problem, you may see an error message on the audio/information screen.

▶ **iPod/USB Flash Drive** P. 295

How to Select a Play Mode

You can select scan, repeat, and random modes when playing a file.

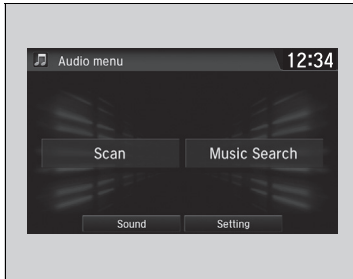

■ Scan

1. Select .
2. Select **Scan**.
3. Select a play mode.

■ Random/Repeat

Select a play mode.

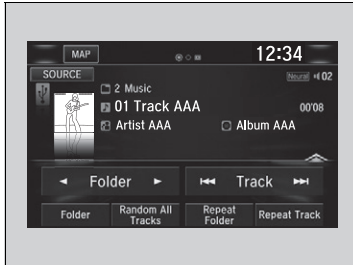

■ To turn off a play mode

To turn off **Scan**, select  or **Cancel**.

To turn off **Random/Repeat**, select the mode again.

How to Select a Play Mode

Play Mode Menu Items

Scan

Scan Folders: Provides 10-second sampling of the first file in each of the main folders.

Scan Tracks: Provides 10-second sampling of all files in the current folder.

Random/Repeat

Random in Folder: Plays all files in the current folder in random order.

Random All Tracks: Plays all files in random order.

Repeat Folder: Repeats all files in the current folder.

Repeat Track: Repeats the current file.

Playing *Bluetooth*® Audio

Your audio system allows you to listen to music from your *Bluetooth*-compatible phone.

This function is available when the phone is paired and connected to the vehicle's *Bluetooth*® HandsFreeLink® (HFL) system.

📄 **Phone Setup** P. 380

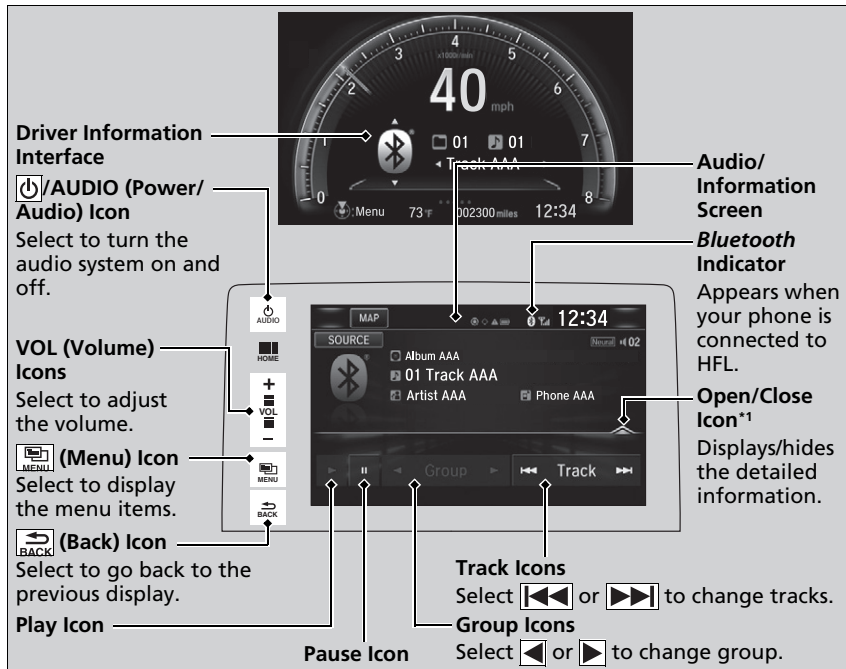

*1: Depending on the *Bluetooth*® device you connect, some or all of the lists may not be displayed.

▶▶ Playing *Bluetooth*® Audio

Not all *Bluetooth*-enabled phones with streaming audio capabilities are compatible.

To check if your phone is compatible, visit automobiles.honda.com/handsfreelink/.

It may be illegal to perform some data device functions while driving.

Only one phone can be used with HFL at a time. When there are more than two paired phones in the vehicle, the first paired phone the system finds is automatically connected.

The connected phone for *Bluetooth*® Audio can be different.

If more than one phone is paired to the HFL system, there may be a delay before the system begins to play.

In some cases, the name of the artist, album, or track may not appear correctly.

Some functions may not be available on some devices.

If a phone is currently connected via Apple CarPlay or Android Auto, *Bluetooth*® Audio from that phone is unavailable. However, a second previously paired phone can stream *Bluetooth*® Audio by selecting **Connect** from the **Bluetooth Device List**.

📄 **Phone Setup** P. 380

To Play *Bluetooth*® Audio Files

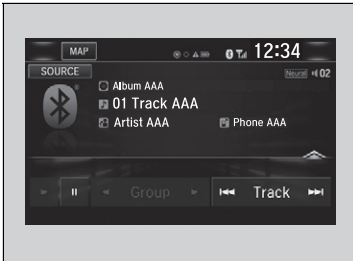

1. Make sure that your phone is paired and connected to the system.
 ▶ **Phone Setup** P. 380
2. Select the *Bluetooth*® Audio mode.

If the phone is not recognized, another HFL-compatible phone, which is not compatible for *Bluetooth*® Audio, may already be connected.

To pause or resume a file

Select the play icon or pause icon.

Searching for Music

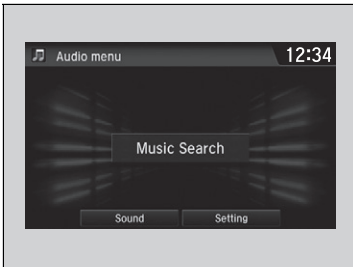

1. Select .
2. Select **Music Search**.
3. Select a search category (e.g., Albums).
4. Select an item.
 ▶ The selection begins playing.

To Play *Bluetooth*® Audio Files

To play the audio files, you may need to operate your phone. If so, follow the phone maker's operating instructions.

Switching to another mode pauses the music playing from your phone.

You can change the connected phone in the *Bluetooth*® settings on the **Audio menu** screen by the following procedure.

1. Select .
2. Select **Setting**.

Searching for Music

Depending on the *Bluetooth*® device you connect, some or all of the lists may not be displayed.

HondaLink®

HondaLink® connects you to the latest information from Honda. You can connect your phone wirelessly through Wi-Fi or *Bluetooth*®.

➔ **Wi-Fi Connection** P. 285

➔ **Phone Setup** P. 380

HondaLink® Menu

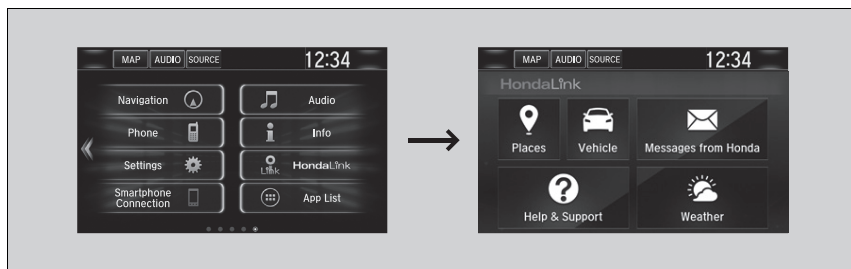

■ Places*

Displays restaurants, gas stations, Honda dealer, and so on. You can also navigate to the found locations via the navigation.

■ Vehicle

Displays instruction messages when the vehicle needs service.

■ Help & Support

Displays tips for vehicle usage, and get support via road side or customer service center.

▶▶ HondaLink®

The HondaLink® connect app is compatible with most iPhone and Android phones.

Some cell phone carriers charge for tethering and smartphone data use. Check your phone's data subscription package.

When Apple CarPlay or Android Auto is connected to the audio system, HondaLink® can be accessed even without a Wi-Fi connection.

■ Messages from Honda

Displays helpful and important information from Honda.

■ Weather*

Displays a weekly five-day weather forecast for any location you want. You can change the ZIP Code at any time.

■ To Set Up to Connect HondaLink® Service

Use the following procedure to connect to HondaLink® service.

■ To enable the HondaLink® service

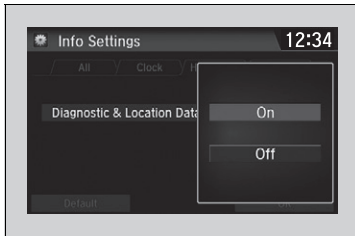

1. Select .
2. Select **Settings**.
3. Select **Info**.
4. Select the **HondaLink** tab.
5. Select **Diagnostics & Location Data**.
6. Select **On**.

You need to allow the consent of the location service to enable the HondaLink® service.

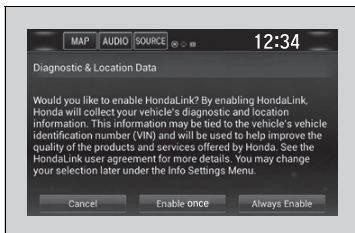

Enable once: Allows only one time. (Prompt shows again next time.)

Always Enable: Allows anytime. (Prompt does not show again.)

Cancel: Does not allow this consent.

* Not available on all models

Continued

■ To link with HondaLink®

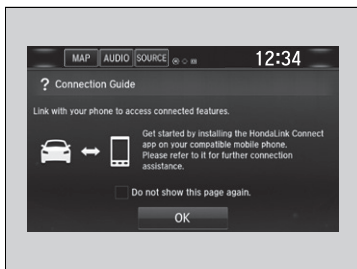

You can see the **Connection Guide** screen after launching HondaLink®. If you do not need this guide, select check-box and select **OK**.

Vehicle Information and Message from Honda Tips

You can check the messages that are received quickly in the shortcut operation.

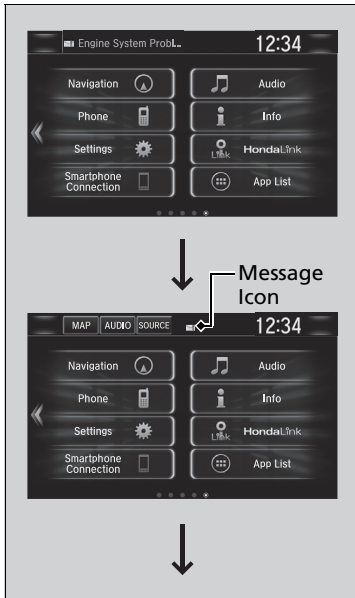

1. A message appears and notifies you of a new message on the header area.

▶ When the message is received, a notification ring can be heard.

2. A message icon is continuously displayed in the header area until the new message is read.

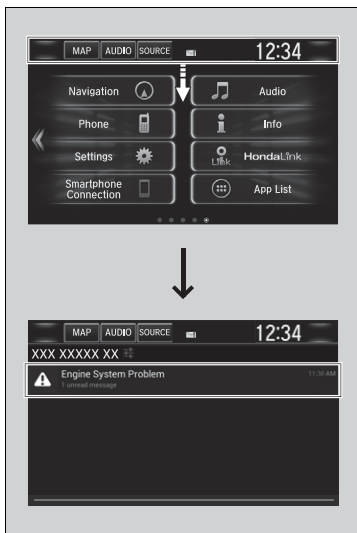

3. From the top of the screen, swipe down to see the messages.



4. Select a new message to open.

Wi-Fi Connection

You can connect the audio system to the Internet using Wi-Fi and browse websites or use online services on the audio/information screen. If your phone has wireless hotspot capabilities, the system can be tethered to the phone. Use the following steps to setup.

Wi-Fi mode (setting for the first time)



1. Select .
2. Select **Settings**.
3. Select **Bluetooth/Wi-Fi**.
4. Select the **Wi-Fi** tab.
5. Select **Wi-Fi On/Off Status**, then **On**.
6. Select **Wi-Fi Device List**.
 - ▶ Make sure your phone's Wi-Fi setting is in access point (tethering) mode.
 - ▶ Select the phone you want to connect to the system.
 - ▶ If you do not find the phone you want to connect in the list, select **Scan**.
7. Select **Connect**.
 - ▶ If needed, enter a password for your phone and select **OK**.
 - ▶ When the connection is successful, the  icon is displayed on the top of the screen.
8. Select  to go back to the home screen.



Wi-Fi mode (setting for the first time)

You cannot go through the setting procedure while a vehicle is moving. Park in a safe place to setup the Wi-Fi connection.

Some cell phone carriers charge for tethering and smartphone data use. Check your phone's data subscription package.

Check your phone manual to find out if the phone has Wi-Fi connectivity.

You can confirm whether Wi-Fi connection is on or off with the  icon on **Wi-Fi Device List**. Network speed will not be displayed on this screen.

■ Wi-Fi mode (after the initial setting has been made)

Make sure your phone's Wi-Fi setting is in access point (tethering) mode.

▶▶ Wi-Fi mode (after the initial setting has been made)

iPhone users

You may need to go through an initial setup for Wi-Fi connection again after you boot your phone.

Siri Eyes Free

You can talk to Siri using the  (Talk) button on the steering wheel when your iPhone is paired to the *Bluetooth*® HandsFreeLink® (HFL) system.

 **Phone Setup** P. 380

Siri Eyes Free

Siri is a trademark of Apple Inc.

Check Apple Inc. website for features available for Siri.

We recommend against using Siri other than in Siri Eyes Free mode while operating a vehicle.

Using Siri Eyes Free

Some commands work only on specific phone features or apps.

Using Siri Eyes Free

(Hang-up/back) Button

Press to deactivate Siri Eyes Free.

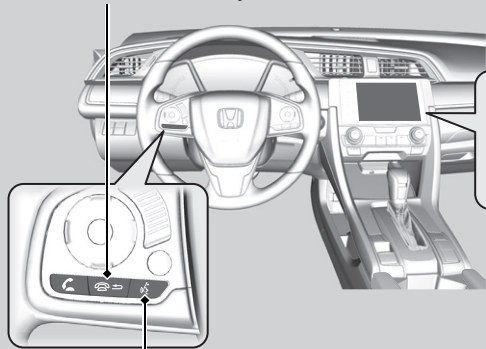

(Talk) Button

Press and hold until the display changes as shown.

Voice Recognition



Appears when Siri is activated in Siri Eyes Free

While in Siri Eyes Free:
The display remains the same.
No feedback or commands appear.

Apple CarPlay

If you connect an Apple CarPlay-compatible iPhone to the system via the front USB, you can use the audio/information screen, instead of the iPhone display, to make a phone call, listen to music, view maps (navigation), and access messages.

➤ **USB Port(s)** P. 201

Apple CarPlay Menu

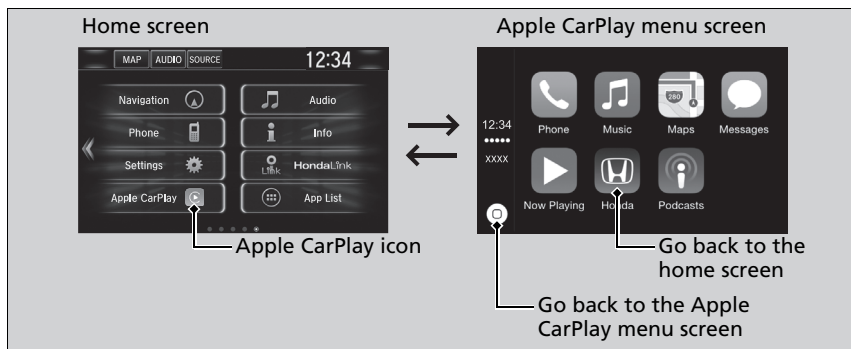

■ Phone

Access the contact list, make phone calls, or listen to voice mail.

■ Messages

Check and reply to text messages, or have messages read to you.

■ Music

Play music stored on your iPhone.

➤ Apple CarPlay

Only iPhone 5 or newer versions with iOS 8.4 or later are compatible with Apple CarPlay.

Park in a safe place before connecting your iPhone to Apple CarPlay and when launching any compatible apps.

To use Apple CarPlay, connect the USB cable to the front USB port. The USB port located in the center console storage will not enable Apple CarPlay operation.

➤ **USB Port(s)** P. 201

To directly access the Apple CarPlay phone function, select **Phone** on the home screen. While connected to Apple CarPlay, calls are only made through Apple CarPlay. If you want to make a call with HandsFreeLink, turn Apple CarPlay OFF or detach the USB cable from your iPhone.

➤ **Setting Up Apple CarPlay** P. 289

When your iPhone is connected to Apple CarPlay, it is not possible to use the *Bluetooth*® Audio or *Bluetooth*® HandsFreeLink®. However, other previously paired phones can stream audio via *Bluetooth*® while Apple CarPlay is connected.

➤ **Phone Setup** P. 380

For details on countries and regions where Apple CarPlay is available, as well as information pertaining to function, refer to the Apple homepage.

■ Maps

Display Apple Maps and use the navigation function just as you would on your iPhone.

Models with navigation system

Only one navigation system (pre-installed navigation or Apple CarPlay) can give directions at a time. When you are using one system, directions to any prior destination set on the other system will be canceled, and the system you are currently using will direct you to your destination.

■ Setting Up Apple CarPlay

After you have connected your iPhone to the system via the front USB, use the following procedure to set up Apple CarPlay. Use of Apple CarPlay will result in the transmission of certain user and vehicle information (such as vehicle location, speed, and status) to your iPhone to enhance the Apple CarPlay experience. You will need to consent to the sharing of this information on the audio/information screen.

■ Enabling Apple CarPlay

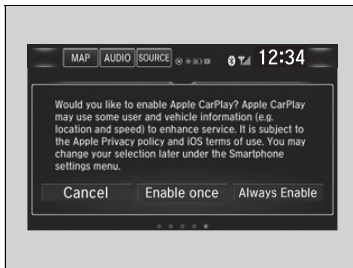

Enable Once: Allows only once. (Prompt shows again next time.)

Always Enable: Allows anytime. (Prompt does not show again.)

Cancel: Does not allow this consent.

You may change the consent settings under the **Smartphone** settings menu.

Continued

▶ Apple CarPlay

Apple CarPlay Operating Requirements & Limitations

Apple CarPlay requires a compatible iPhone with an active cellular connection and data plan. Your carrier's rate plans will apply.

Changes in operating systems, hardware, software, and other technology integral to providing Apple CarPlay functionality, as well as new or revised governmental regulations, may result in a decrease or cessation of Apple CarPlay functionality and services. Honda cannot and does not provide any warranty or guarantee of future Apple CarPlay performance or functionality.

It is possible to use 3rd party apps if they are compatible with Apple CarPlay. Refer to the Apple homepage for information on compatible apps.

▶ Setting Up Apple CarPlay

You can also use the method below to set up Apple CarPlay:
Select HOME→Settings→Smartphone→Apple CarPlay

Use of user and vehicle information

The use and handling of user and vehicle information transmitted to/from your iPhone by Apple CarPlay is governed by the Apple iOS terms and conditions and Apple's Privacy Policy.

■ Operating Apple CarPlay with Siri

Press and hold the talk button to activate Siri.



▣ Operating Apple CarPlay with Siri

Below are examples of questions and commands for Siri.

- What movies are playing today?
- Call dad at work.
- What song is this?
- How's the weather tomorrow?
- Read my latest email.
- Find a table for four tonight in Chicago.

For more information, please visit www.apple.com/ios/siri.

Android Auto

When you connect an Android phone to the audio system via the front USB, Android Auto is automatically initiated. When connected via Android Auto, you can use the audio/information screen to access the Phone, Google Maps (Navigation), Google Play Music, and Google Now functions. When you first use Android Auto, a tutorial will appear on the screen.

We recommend that you complete this tutorial while safely parked before using Android Auto.

➤ **USB Port(s)** P. 201

➤ **Auto Pairing Connection** P. 293

Android Auto

To use Android Auto, you need to download the Android Auto app from Google Play to your smartphone.

Only Android 5.0 (Lollipop) or later versions are compatible with Android Auto.

Bluetooth A2DP cannot be used on your phone while connected to Android Auto.

Park in a safe place before connecting your Android phone to Android Auto and when launching any compatible apps.

To use Android Auto, connect the USB cable to the front USB port. The USB port in the center console storage will not enable Android Auto operation.

➤ **USB Port(s)** P. 201

When your Android phone is connected to Android Auto, it is not possible to use the *Bluetooth*® Audio. However, other previously paired phones can stream audio via *Bluetooth*® while Android Auto is connected.

➤ **Phone Setup** P. 380

■ Android Auto Menu

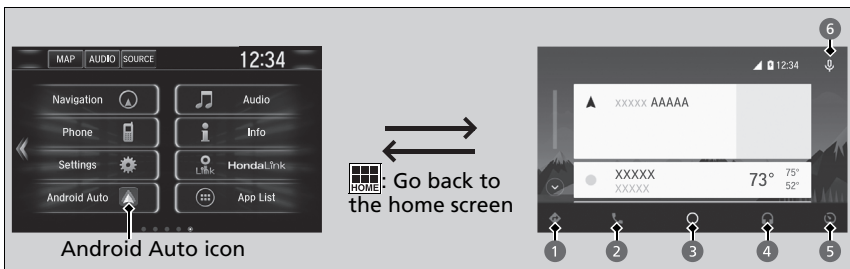

1 Maps (Navigation)

Display Google Maps and use the navigation function just as you would with your Android phone. When the vehicle is in motion, it is not possible to make keyboard entries. Stop the vehicle in a safe location to undertake a search or provide other inputs.

Models with navigation system

Only one navigation system (pre-installed navigation or Android Auto) can give directions at a time. When you are using one system, directions to any prior destination set on the other system will be canceled, and the system you are currently using will direct you to your destination.

The audio/information screen shows you turn-by-turn driving directions to your destination.

2 Phone (Communication)

Make and receive phone calls as well as listen to voicemail.

3 Google Now (Home screen)

Display useful information organized by Android Auto into simple cards that appear just when they're needed.

▶▶ Android Auto

For details on countries and regions where Android Auto is available, as well as information pertaining to function, refer to the Android Auto homepage.

Android Auto Operating Requirements & Limitations

Android Auto requires a compatible Android phone with an active cellular connection and data plan. Your carrier's rate plans will apply.

Changes in operating systems, hardware, software, and other technology integral to providing Android Auto functionality, as well as new or revised governmental regulations, may result in a decrease or cessation of Android Auto functionality and services. Honda cannot and does not provide any warranty or guarantee of future Android Auto performance or functionality.

It is possible to use 3rd party apps if they are compatible with Android Auto. Refer to the Android Auto homepage for information on compatible apps.

4 Music and audio

Play Google Play Music and music apps that are compatible with Android Auto. To switch between music apps, press this icon.

5 Go back to the Home Screen.**6 Voice**

Operate Android Auto with your voice.

Auto Pairing Connection

When you connect an Android phone to the unit via the front USB, Android Auto is automatically initiated.

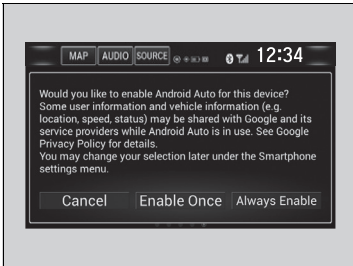
Enabling Android Auto

Enable Once: Allows only once. (Prompt shows again next time.)

Always Enable: Allows anytime. (Prompt does not show again.)

Cancel: Does not allow this consent.

You may change the consent settings under the **Smartphone** settings menu.

Enabling Android Auto

Only initialize Android Auto when you are safely parked. When Android Auto first detects your phone, you will need to set up your phone so that auto pairing is possible. Refer to the instruction manual that came with your phone.

You can use the method below to change Android Auto settings after you have completed the initial setup:
Select HOME→Settings→Smartphone→Android Auto

Use of user and vehicle information

The use and handling of user and vehicle information transmitted to/from your phone by Android Auto is governed by Google's Privacy Policy.

■ Operating Android Auto with Voice Recognition

Press and hold the talk button to operate Android Auto with your voice.

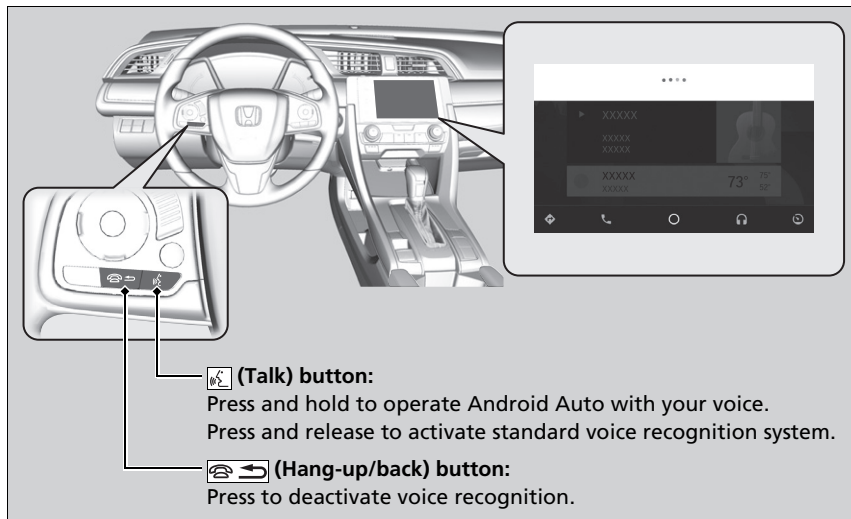

▶▶ Operating Android Auto with Voice Recognition

Below are examples of commands you can give with voice recognition:

- Reply to text.
- Call my wife.
- Navigate to Honda.
- Play my music.
- Send a text message to my wife.
- Call flower shop.

For more information, please refer to the Android Auto homepage.

You can also activate the voice recognition function by pressing the  icon in the upper-right corner of the screen.

iPod/USB Flash Drive

If an error occurs while playing an iPod or USB flash drive, you may see the following error messages. If you cannot clear the error message, contact a dealer.

Error Message	Solution
USB Error ^{*1, *2}	Appears when there is a problem with the audio system. Check if the device is compatible with the audio system.
Bad USB Device Please Check Owners Manual ^{*1} The connected USB device has a problem. See Owner's Manual ^{*2}	Appears when an incompatible device is connected. Disconnect the device. Then turn the audio system off, and turn it on again. Do not reconnect the device that caused the error.
Unsupported Ver ^{*1} Unsupported Version ^{*2}	Appears when an unsupported iPod is connected. If it appears when a supported iPod is connected, update the iPod software to the newer version.
Retry Connection ^{*1} Connect Retry ^{*2}	Appears when the system does not acknowledge the iPod. Reconnect the iPod.
Unplayable File ^{*1, *2}	Appears when the files in the USB flash drive are copyright protected or an unsupported format. This error message appears for about three seconds, then plays the next song.
USB No Song ^{*1} iPod No Song ^{*1} No Data ^{*2}	iPod Appears when the iPod is empty.
	USB flash drive Appears when the USB flash drive is empty or there are no MP3, WMA, or AAC files in the USB flash drive.
	iPod and USB flash drive Check that compatible files are stored on the device.
Unsupported ^{*1, *2}	Appears when an unsupported device is connected. If it appears when a supported device is connected, reconnect the device.

*1:Models with color audio system

*2:Models with Display Audio

U.S. models

Models with Display Audio

Pandora®*

If an error occurs while playing Pandora®, you may see the following error messages.

If you cannot clear the error message, contact a dealer.

Error Message	Solution
To begin listening, select a station from the Stations list.	Appears when there is no station list on the device. Use the device to create a station.
Unable to rate track. Please try again. Skip limit reached.	Appears when you try to skip a track or select Like/Dislike over the predetermined number of times in an hour.
Unable to play Pandora. Please try again later. Unable to retrieve a track explanation. Please try again later. Unable to create bookmark. Please try again later.	Appears when the commanded operation fails. Try again later.
No Data	Appears when no data is available with Pandora® activated. Reboot the app and reconnect the device.
Pandora App version is not supported	Appears when Pandora® version is not supported. Update Pandora® to the latest version.
Unable to complete the operation. Please try again later.	Appears when the Pandora® server is in maintenance. Try again later.
Unable to connect Pandora. When stopped, check your mobile phone	Appears when Pandora® is unable to play music. Check your device.
Unable to connect Pandora. When stopped, check your mobile phone	Appears when Pandora® app is not installed on your device. Install Pandora® app to your device.

Models with Display Audio

Android/Apps

If an error occurs while using the audio system or apps, you may see the following error messages. If you cannot clear the error message, contact a dealer.

Error Message*1	Solution
Unfortunately, **** has stopped.	Error has occurred within app, select OK on the screen to close the app.
**** is not responding. Would you like to close it?	App is not responding. Select Wait if you can wait for a response from app a little longer. If it does not respond even if you keep waiting, select OK to close the app and start it up. If the error message continues, perform Factory Data Reset . ➤ Defaulting All the Settings P. 348

*1:****part is variable characters, and will change depending upon where an error occurs.

SiriusXM® Radio Service*

■ Subscribing to SiriusXM® Radio

1. You need your radio ID ready before registering for subscription. To see the ID on the screen, select **Channel 0**.
2. Have your radio ID ready, and either call SiriusXM® or visit the SiriusXM® website to subscribe.

■ Receiving SiriusXM® Radio

Switch to the SiriusXM® mode by using the **SOURCE** button on the steering wheel, or through the audio/information screen, and stay in this mode for about 30 minutes until the service is activated. Make sure your vehicle is in an open area with good reception.

■ SiriusXM® Radio Display Messages

Channel Not Subscribed:

You are not subscribed to the channel selected.

Subscription Update:

SiriusXM® radio is receiving information update from the network.

Channel Not Available:

No such channel exists, or the artist or title information is unavailable.

No Signal:

The signal is too weak in the current location.

Antenna Disconnected:

The SiriusXM® antenna is disconnected. Contact a dealer.

☒ Subscribing to SiriusXM® Radio

Contact Information for SiriusXM® Radio:

- U.S.: SiriusXM® Radio at www.siriusxm.com/subscribe-now, or 1-866-635-2349
- Canada: SiriusXM® Canada at www.siriusxm.ca/subscribe-now, or 1-877-209-0079

☒ Receiving SiriusXM® Radio

The SiriusXM® satellites are in orbit over the equator; therefore, objects south of the vehicle may cause satellite reception interruptions. Satellite signals are more likely to be blocked by tall buildings and mountains the farther north you travel from the equator.

You may experience reception problems under the following circumstances:

- In a location with an obstruction to the south of your vehicle.
- In tunnels
- On the lower level of a multi-tiered road
- Large items carried on the roof rack

Compatible iPod, iPhone, and USB Flash Drives

■ iPod and iPhone Model Compatibility

Model
iPod (5th generation)
iPod classic 80GB/160GB (launch in 2007)
iPod classic 120GB (launch in 2008)
iPod classic 160GB (launch in 2009)
iPod nano (1st to 7th generation) released between 2005 and 2012
iPod touch (1st to 5th generation) released between 2007 and 2012
iPhone 3G/iPhone 3GS/iPhone 4/iPhone 4S/iPhone 5/iPhone 5c ^{*1} /iPhone 5s ^{*1} / iPhone 6 ^{*1} /iPhone 6 Plus ^{*1}

*1: Models with Display Audio

■ USB Flash Drives

- A USB flash drive of 256 MB or higher is recommended.
- Some digital audio players may not be compatible.
- Some USB flash drives (e.g., a device with security lockout) may not work.
- Some software files may not allow for audio play or text data display.
- Some versions of MP3, WMA, or AAC formats may be unsupported.

⌘ iPod and iPhone Model Compatibility

This system may not work with all software versions of these devices.

⌘ USB Flash Drives

Files on the USB flash drive are played in their stored order. This order may be different from the order displayed on your PC or device.

Honda App License Agreement

■ END USER LICENSE AGREEMENT

PLEASE CAREFULLY READ THIS END USER LICENSE AGREEMENT (THIS “AGREEMENT”) WHICH GOVERNS YOUR USE OF THE SOFTWARE INSTALLED ON YOUR HONDA OR ACURA VEHICLE (YOUR “VEHICLE”) AS WELL AS THE APPLICATIONS, SERVICES, FUNCTIONS, AND CONTENT PROVIDED THROUGH THE SOFTWARE (COLLECTIVELY, THE “SERVICES”). YOUR USE OF THE SOFTWARE OR SERVICES WILL SERVE AS YOUR CONSENT TO THE TERMS OF THIS AGREEMENT. THE SOFTWARE IS OWNED (OR LICENSED), PROVIDED, AND/OR OPERATED BY AMERICAN HONDA MOTOR CO. INC., (“HONDA,” “US,” “WE,” OR “OUR”), WITH ITS BUSINESS ADDRESS AT 1919 TORRANCE BLVD., TORRANCE, CA 90501. REFERENCE TO “HONDA” IN THIS AGREEMENT INCLUDES HONDA’S PARENT COMPANY AND ITS AFFILIATES AND DESIGNATED AGENTS. THE SERVICES ARE OWNED (OR LICENSED), PROVIDED, AND/OR OPERATED BY HONDA OR A THIRD-PARTY SERVICE PROVIDER (A “PROVIDER”). REFERENCE TO A “PROVIDER” IN THIS AGREEMENT INCLUDES SUCH PROVIDER’S PARENT COMPANY, AFFILIATES, AND DESIGNATED AGENTS.

A. Description of the Software. The SOFTWARE includes the software, firmware and the like, installed and executing on your VEHICLE during manufacture, and thereafter updated from time to time by HONDA, you or an authorized HONDA dealer (a “DEALER”). The SOFTWARE allows you to access and use a variety of SERVICES, including but not limited to: (a) HONDA applications, services, and content provided through the SOFTWARE (together, “HONDA SERVICES”); and (b) PROVIDER applications, services, and content provided through the SOFTWARE (together, “PROVIDER SERVICES”), each of which may provide access to various information, media, content, and services.

B. SOFTWARE Licensing and Intellectual Property.

1. SOFTWARE. This AGREEMENT grants you a non-exclusive, limited, and revocable license to use the SOFTWARE and SERVICES solely (a) as installed on your VEHICLE by HONDA, (b) as updated on your Vehicle by HONDA, you (but only as and when directed by HONDA), or a DEALER and (c) as permitted under the terms of this AGREEMENT.

2. HONDA Services. The SOFTWARE may provide you with access to various HONDA SERVICES. Installation, activation, or use of HONDA SERVICES may require your consent to additional terms, conditions, and privacy policies applicable to those HONDA SERVICES (the “HONDA TERMS”). You acknowledge and agree that any collection, use, sharing of data generated by your VEHICLE or your use of your VEHICLE, and your use of the HONDA SERVICES shall be subject to this AGREEMENT and any additional HONDA TERMS that may be specifically applicable to such HONDA SERVICES or data generation. The HONDA SERVICES may collect, use, and share such data while you are using the SOFTWARE.

3. Open-Source Software. The SOFTWARE and SERVICES may incorporate software licensed to HONDA under free or open-source licenses which govern HONDA's distribution and your use of such software. HONDA and the third-party authors, licensors, and distributors of such software disclaim all warranties and all liability arising from any and all use or distribution of the software. To the extent such software is provided under terms that differ from the applicable free or open-source licenses, those terms are offered by HONDA alone. Additional information regarding free and open-source software incorporated in the SOFTWARE and SERVICES is available in this manual or within the SOFTWARE.

4. Provider Services. The SOFTWARE may provide you with access to various PROVIDER SERVICES. Installation or use of such PROVIDER SERVICES may require your consent to additional terms, conditions, and privacy policies of the applicable PROVIDER (the "PROVIDER TERMS"). This AGREEMENT restricts the manner in which you can install and use PROVIDER SERVICES but does not grant you a license or permission to use such PROVIDER SERVICES. Your permission to use PROVIDER SERVICES is limited and subject to any license grants, conditions, and limitations included in the PROVIDER TERMS. You acknowledge that any collection, use, sharing of your information, targeted advertising practices by PROVIDERS, and your use of the PROVIDER SERVICES shall be subject to both this AGREEMENT and any applicable PROVIDER TERMS. The PROVIDER SERVICES may collect, use, and share such information while you are using the SOFTWARE.

5. License Limitations and Restrictions on Use.

(a) Limited License. You understand and agree that the SOFTWARE and SERVICES are licensed, not sold, to you solely for use in accordance with this AGREEMENT and any applicable PROVIDER TERMS, and any documentation for the VEHICLE made available to you by HONDA (any "DOCUMENTATION"). HONDA and its licensors reserve all rights in the SOFTWARE and HONDA SERVICES not expressly granted to you under this AGREEMENT. PROVIDERS and their licensors reserve all rights in the PROVIDER SERVICES not expressly granted to you under the applicable PROVIDER TERMS.

(b) Restrictions on Use. The licenses granted under this AGREEMENT do not permit you to use the SOFTWARE or SERVICES on a device other than your VEHICLE. As a condition of using the SOFTWARE and SERVICES, you agree that you may not and will not:

- (1) copy, download, distribute, modify, publish, sell, rent, lease, lend, license, sublicense, reuse, or create derivative works of the SOFTWARE or SERVICES or any of the content or other material within the SOFTWARE or SERVICES, including without limitation, HONDA or PROVIDER names, logos, or any other trademarks of HONDA or PROVIDERS or used in association with the SOFTWARE or any SERVICES, except as required to use the SOFTWARE or SERVICES in accordance with this AGREEMENT, any applicable PROVIDER TERMS, and the DOCUMENTATION;
- (2) access or use the SOFTWARE or SERVICES in any manner intended to damage or impair the operation of the SOFTWARE or SERVICES or interfere with anyone else's use and enjoyment of the SOFTWARE or SERVICES;
- (3) access or attempt to access any system or server on which the SOFTWARE or SERVICES is hosted or modify or alter the SOFTWARE or SERVICES in any way;
- (4) use the SOFTWARE or SERVICES for any unlawful purpose, or in violation of any third party rights;
- (5) use the SOFTWARE or SERVICES in violation of any applicable traffic regulations, rules or laws, including but not limited to any driver distraction laws, rules or regulations;
- (6) violate the terms of this AGREEMENT, any HONDA TERMS, any PROVIDER TERMS or other applicable third-party terms, conditions, and privacy policies; or
- (7) reverse engineer, decompile, disassemble, attempt to derive the source code of, nor permit others to reverse engineer, decompile, or disassemble, or attempt to derive the source code of the SOFTWARE or SERVICES, except and only to the extent that such activity is expressly permitted (a) by applicable law notwithstanding this limitation or (b) the terms of applicable free or opensource software licenses.

6. Intellectual Property Rights. All title and intellectual property rights in and to the SOFTWARE and SERVICES, the accompanying DOCUMENTATION, and all copies of the SOFTWARE or SERVICES are owned by HONDA, PROVIDERS, or their suppliers or licensors. This AGREEMENT does not grant you any rights in connection with any trademarks or service marks of HONDA, PROVIDERS, or their licensors, affiliates, or suppliers.

7. Export Restrictions: You acknowledge that the SOFTWARE and SERVICES are subject to U.S., European Union, and other export jurisdictions. You agree to comply with all applicable international and national laws that apply to the SOFTWARE and SERVICES, including the U.S. Export Administration Regulations, as well as end-user, end-use, and destination restrictions issued by the U.S. and other governments.

C. SOFTWARE Operation

- 1.** HONDA reserves the right to suspend or terminate your access to and use of the SOFTWARE or SERVICES if you are found to be in violation of this AGREEMENT or as reasonably deemed necessary by HONDA.
- 2. Eligibility/Registration/Activation.** The SOFTWARE is intended for and available to individuals who (a) are of legal age of majority in their jurisdiction of residence (and at least 18 years of age), or are younger than 18 years of age and possess a valid driver's license issued by their jurisdiction of residence, and (b) own or have permissive access to a compatible VEHICLE. We do not knowingly collect any information, including personal information, from children under 13. If we learn or are notified that we have collected personal information of a child under 13, we will immediately take steps to delete such information.
- 3. Use of PROVIDER SERVICES through the SOFTWARE.** Certain PROVIDER SERVICES made available through the SOFTWARE may require that you register or otherwise have an account with the PROVIDER and agree to PROVIDER TERMS. Any use of any of such PROVIDER SERVICES within the SOFTWARE is subject to this AGREEMENT and the applicable PROVIDER TERMS. HONDA does not exercise control over such PROVIDER SERVICES and is not responsible or liable for the availability, security, or content of such PROVIDER SERVICES, and the inclusion of any PROVIDER SERVICES does not imply a referral from, the approval of, or the endorsement by HONDA of such PROVIDER SERVICES. HONDA is not responsible or liable, directly or indirectly, for any damage relating to or resulting from your use of the PROVIDER SERVICES.
- 4. Links to Third Party Sites:** The SOFTWARE may provide you with the ability to access third-party sites and content through the use of the SOFTWARE or SERVICES. The third-party sites and content are not under the control of HONDA. HONDA is not responsible or liable, directly or indirectly, for such third-party websites and their content or for any damage relating to or resulting from your access or use of such websites and content.

5. Unauthorized Use and Abuse. You are responsible for ensuring your (and any authorized third parties') use of the SOFTWARE and SERVICES remains in compliance with this AGREEMENT and all other applicable HONDA TERMS and PROVIDER TERMS. You acknowledge and agree that any use of the SOFTWARE or SERVICES occurring through your VEHICLE will be deemed your actions and that HONDA and PROVIDERS may rely upon such actions. You agree to immediately notify us if you suspect fraudulent or abusive activity involving the SOFTWARE or SERVICES. If you so notify us or if we otherwise suspect fraudulent or abusive activity, you agree to cooperate with us in any fraud investigation and to use any fraud prevention measures we prescribe. Your failure to immediately notify us or cooperate to use such measures will result in your liability for all fraudulent usage or abusive activity associated with your VEHICLE.

6. SOFTWARE Updates. The SOFTWARE and SERVICES may be updated when your VEHICLE is serviced by a DEALER or remotely, over-the-air, by HONDA from time to time; such updates may occur with or without further notice or your future consent. The SOFTWARE may be updated at HONDA's discretion and for any purpose including, without limitation, to patch or otherwise improve the SOFTWARE or SERVICES functionality, security, or stability. All updates to the SOFTWARE and SERVICES are subject to this AGREEMENT and any other applicable HONDA TERMS and PROVIDER TERMS.

7. Uninstalling, Removing, and Replacing the SOFTWARE. Replacing SOFTWARE or HONDA SERVICES with software or firmware not provided and installed by HONDA or a DEALER will render all representations and warranties for the SOFTWARE, HONDA SERVICES, and VEHICLE functionality reliant upon the SOFTWARE or HONDA SERVICES null and void.

D. SOFTWARE Operational Notices and Warnings

1. Vehicle Geolocation Information. You acknowledge that your VEHICLE may be equipped with certain traffic and map features. The traffic feature will automatically collect and transmit, through GPS technology, your Vehicle's current location (longitude and latitude), travel direction and speed ("VEHICLE GEOLOCATION INFORMATION") to HONDA and PROVIDERS. The VEHICLE GEOLOCATION INFORMATION is used by HONDA and PROVIDERS to provide traffic and navigation-related information to you, but may also be used to provide other SERVICES or offers to you. HONDA will not use such VEHICLE GEOLOCATION INFORMATION for its own marketing efforts, or provide such information to unaffiliated third parties for their own purposes, without your express consent.

2. Potential Map Inaccuracy and Route Safety. Maps used by this system may be inaccurate because of changes in roads, traffic controls, routing, or driving conditions. Always use good judgment and common sense when following suggested routes. Do not follow the route suggestions if doing so would result in an unsafe or illegal driving maneuver, if you would be placed in an unsafe situation, or if you would be directed into an area that you consider unsafe. Do not rely on any navigation features included in the system to route you to emergency services. Not all emergency services such as police, fire stations, hospitals, or clinics are likely to be contained in the map database for such navigation features. Ask local authorities or an emergency services operator for such locations and routes. The driver is ultimately responsible for the safe operation of the vehicle and therefore, must evaluate whether it is safe to follow the suggested directions. Any navigation features are provided only as an aid. Make your driving decisions based on your observations of local conditions and existing traffic regulations. Navigation features are not a substitute for your personal judgment. Any route suggestions made by the SOFTWARE or SERVICES should never replace any local traffic regulations or your personal judgment or knowledge of safe driving practices.

3. Speech Recognition: You acknowledge and understand that HONDA and PROVIDERS may record, retain, and use voices commands when you use the speech recognition components of the SOFTWARE or SERVICES. You and all VEHICLE operators and passengers (a) consent to the recording and retention of voice commands in support of providing speech recognition components and (b) release HONDA and PROVIDERS from all claims, liabilities, and losses that may result from any use of such recorded voice commands. Recognition errors are inherent in speech recognition. It is your responsibility to monitor any speech recognition functions included in the system and address any errors. Neither HONDA nor PROVIDERS will be liable for any damages arising out of errors in the speech recognition process.

4. Distraction Hazards. Navigation features may require manual (non-verbal) input or setup. Attempting to perform such set-up or insert data while driving can seriously distract your attention and could cause a crash or other serious consequences; the ability to undertake such interactions may also be limited by state or local law, which laws you are responsible to know and follow. Even occasional short scans of the screen may be hazardous if your attention has been diverted away from your driving at a critical time. Pull over and stop the vehicle in a safe and legal manner before attempting to access a function of the system requiring prolonged attention. Do not raise the volume excessively. Keep the volume at a level where you can still hear outside traffic and emergency signals while driving. Driving while unable to hear these sounds could result in a crash.

E. Information Collection and Storage

1. Information Collection, Use, Transmission and Storage of Data. Consent to Use of Data: You agree that HONDA and PROVIDERS may collect and use your information gathered in any manner as part of product support services related to the SOFTWARE or related services. HONDA may share such information with third parties, including, without limitation, PROVIDERS, third party software and services suppliers, their affiliates and/or their designated agents, solely to improve their products or to provide services or technologies to you. HONDA, third party software and systems suppliers, their affiliates and/or their designated agent may disclose this information to others, but not in a form that personally identifies you.

2. Information Storage. Depending on the type of multimedia system you have in your VEHICLE, certain information may be stored for ease of use of the SOFTWARE including, without limitation, search history, location history in certain applications, previous and saved destinations, map locations within certain applications, and device numbers and contact information.

(a) Vehicle Health Information. Your VEHICLE may remotely transmit information regarding the status and health of your VEHICLE ("VEHICLE INFORMATION") to HONDA without notification to you. VEHICLE INFORMATION may contain VEHICLE maintenance and malfunction status that is derived from VEHICLE diagnostic data and includes, but is not limited to, status of powered doors and windows, battery life data, battery charging data, VEHICLE speed, coolant temperature, air compressor revolution, output power, warning codes, diagnostic trouble codes, fuel injection volume, and engine rotations per minute. VEHICLE HEALTH INFORMATION may be used by HONDA for research and development, to deliver HONDA SERVICES and information to you, and to contact you, and is retained only for a period of time necessary to fulfill these goals.

(b) VEHICLE Geolocation Data (non-navigation/map based). If you opt-in to geolocation-based SERVICES, your vehicle's geolocation data (latitude and longitude) will be automatically sent from your VEHICLE to HONDA and PROVIDERS.

(c) You understand that the inputting or uploading of information to your VEHICLE's multimedia system or the SOFTWARE or SERVICES is at your own risk and that HONDA is not responsible for unauthorized access to or use of any personal or other information. All information uploaded to the SOFTWARE and SERVICES may be stored on your VEHICLES's multimedia system and you understand that the security and safety of your VEHICLE's multimedia system is your sole responsibility.

F. NO WARRANTY. You understand and agree that your use of the SOFTWARE and SERVICES are solely at your own risk and that you will be solely responsible for any damage to your VEHICLE's multimedia system or any other equipment or any loss of data that may result from your use of the SOFTWARE or SERVICES. THE SOFTWARE AND SERVICES ARE PROVIDED ON AN "AS IS" AND "AS AVAILABLE" BASIS WITHOUT ANY WARRANTY OF ANY KIND, EXPRESSED, IMPLIED OR STATUTORY. WE SPECIFICALLY DISCLAIM ANY IMPLIED WARRANTIES OF MERCHANTABILITY, FITNESS FOR A PARTICULAR PURPOSE, AND NON-INFRINGEMENT. HONDA makes no warranties that the SOFTWARE or SERVICES will meet your requirements, or that the SOFTWARE or SERVICES will be uninterrupted, timely, secure, non-infringing or error free. You understand and agree that you are responsible for any and all charges, costs or expenses associated with your use of the SOFTWARE or SERVICES. Advice or information, whether oral or written, obtained by you from us or through the SOFTWARE or SERVICES are provided for informational purposes only and will not create any warranty not expressly made herein. You should not rely on any such information or advice. We assume no liability or responsibility for any errors or omissions in the SOFTWARE or SERVICES. We do not make any warranty or representation that your use of the material displayed on, or obtained through, the SOFTWARE or SERVICES is non-infringing of any rights of any third party. Any decision or action taken by you on the basis of information or content provided via the application is at your sole discretion and risk. HONDA and PROVIDERS are not responsible or liable for any such decision, or for the accuracy, completeness, usefulness, or availability of any content or information displayed, transmitted, or otherwise made available via the SOFTWARE or SERVICES. To the extent jurisdictions do not allow the exclusion of certain warranties, some of the above exclusions may not apply to you.

G. LIMITATIONS ON LIABILITY. You and HONDA are each waiving important rights.

1. Limitations on YOUR liability. HONDA cannot recover from you any consequential, indirect, incidental, or special damages, or attorney's fees in connection with your use of the SOFTWARE or HONDA SERVICES. HONDA WAIVES TO THE FULLEST EXTENT ALLOWED BY LAW ANY CLAIM FOR DAMAGES OTHER THAN DIRECT, COMPENSATORY DAMAGES AS LIMITED IN THIS AGREEMENT.

2. Limitation on HONDA and PROVIDER liability. Neither HONDA nor PROVIDERS will be liable to you or any other party for consequential, indirect, incidental, special, or punitive damages (including without limitation lost profits) in connection with your use of the SOFTWARE or SERVICES, even if HONDA or PROVIDERS are aware of the possibility of such damages. These limitations apply to all claims, including, without limitation, claims in contract and tort (such as negligence, product liability and strict liability). To the extent that a jurisdiction does not permit the exclusion or limitation of liability as set forth herein our liability is limited to the maximum extent permitted by law in such states. If HONDA or PROVIDERS are found liable to you for any reason, you agree that the aggregate liability of all these parties to you for any claim is limited to ten U.S. dollars (US \$10.00). Neither HONDA nor any PROVIDER would have agreed to provide the SOFTWARE or SERVICES to you if you did not agree to this limitation. This amount is the sole and exclusive liability of HONDA and PROVIDERS to you, and is payable as liquidated damages and not as a penalty. Except where prohibited by law, you may not bring any claim against HONDA or any third-party beneficiary more than two (2) years after the claim arises. We do not have any liability for SOFTWARE or SERVICES interruptions of any length.

(a) **Release of HONDA and PROVIDERS** For yourself and anyone else claiming under you, you agree to release and discharge HONDA, PROVIDERS, their respective officers, directors, and employees, and each third-party beneficiary from all claims, liabilities and losses in connection with the SOFTWARE or SERVICES, including, but not limited to claims for personal injury or property damage arising from the total or partial failure of performance of the SOFTWARE or SERVICES, even if caused by or based upon the negligence, gross negligence, strict products liability, Deceptive Trade Practices Act violations, bad faith, or breach of warranty of us or the malfunction of the SOFTWARE or SOFTWARE SERVICES. YOU AGREE TO WAIVE TO THE FULLEST EXTENT ALLOWED BY LAW, ANY CLAIM FOR DAMAGES OTHER THAN DIRECT, COMPENSATORY DAMAGES AS LIMITED IN THIS AGREEMENT. YOU HEREBY RELEASE AND DISCHARGE HONDA AND ITS LICENSORS AND CONTRACTORS (INCLUDING ANY THIRD PARTIES PROVIDING ALL OR PART OF THE SOFTWARE OR SERVICES) FROM AND AGAINST ANY CLAIMS, DAMAGES, EXPENSES AND LIABILITY ARISING FROM OR RELATED TO ANY INJURIES, DAMAGES, OR LOSSES TO ANY PERSON (INCLUDING DEATH) OR PROPERTY OF ANY KIND RESULTING IN WHOLE OR PART, DIRECTLY OR INDIRECTLY, FROM YOUR USE OF THE SOFTWARE OR SERVICES.

H. Survival. You agree that the limitations of liability and indemnities in this AGREEMENT will survive even after the AGREEMENT has ended. These limitations of liability apply not only to you, but to anyone using the SOFTWARE or SERVICES via your VEHICLE, to anyone making a claim on your behalf, and to any claims made by your family, employees, customers, or others arising out of or relating to your VEHICLE, the SOFTWARE, or SERVICES.

I. Availability/Interruption. The SOFTWARE and certain SERVICES are made available through your VEHICLE's compatible multimedia system when the VEHICLE is turned on. Certain SERVICES may be available only through your compatible mobile device when it is within the operating range of the VEHICLE and a wireless carrier. The availability of the SOFTWARE and SERVICES may be subject to transmission limitation or interruption, including but not limited to technical obsolescence or sunset of the hardware, software or firmware, inside of or external to the Vehicle, required for data transmission or receipt. HONDA does not guarantee that the SOFTWARE, SERVICES, or any portion thereof will be available at all times or in all areas. You acknowledge and agree that HONDA is not responsible for performance degradation, interruption or delays. You acknowledge that HONDA shall not be liable to you if the SOFTWARE or SERVICES in a given location are not available. If the SOFTWARE or SERVICES are not available within your intended location, you agree that your sole remedy shall be to cease using the SOFTWARE and SERVICES.

J. PRODUCT SUPPORT: Product support for the SOFTWARE is provided by HONDA. For product support, please refer to HONDA instructions provided in the DOCUMENTATION. Should you have any questions concerning this AGREEMENT, or if you desire to contact HONDA for any other reason, please refer to the HONDA contact information provided in the DOCUMENTATION.

K. Termination and Transfer.

1. Termination. This AGREEMENT is effective until terminated by you or US. WE may terminate this AGREEMENT for any or no reason, and with or without notice to you. Your rights under this AGREEMENT will terminate automatically without notice from US if you fail to comply with any term of this AGREEMENT. Upon termination of this AGREEMENT, you shall cease all use of the SOFTWARE and SERVICES.

2. Transfer: You may permanently transfer your rights under this AGREEMENT only as part of a sale or transfer of the VEHICLE, provided you retain no copies, you transfer all of the SOFTWARE and HONDA SERVICES (including all component parts, the media and printed materials, and any upgrades), and the recipient agrees to the terms of this AGREEMENT. You agree to notify HONDA upon the sale or transfer of the VEHICLE. To contact HONDA, please refer to the HONDA contact information provided in the DOCUMENTATION.

L. Changes to the SOFTWARE or SERVICES. WE may change, modify, or update the SOFTWARE or SERVICES from time to time. Unless explicitly stated otherwise, any new features or services that augment or enhance the SOFTWARE or SERVICES in the future shall respectively be considered part of the SOFTWARE or SERVICES and subject to this AGREEMENT. WE reserve the right at any time and from time to time to interrupt, restrict, modify, suspend, discontinue, temporarily or permanently, the SOFTWARE or SERVICES (or any portion thereof), with or without notice to you, and you agree that HONDA shall not be liable to you or to any third party for any modification, suspension or discontinuance of the SOFTWARE or SERVICES.

M. ARBITRATION:

PLEASE READ THIS ARBITRATION PROVISION CAREFULLY TO UNDERSTAND YOUR RIGHTS. YOU AGREE THAT ANY CLAIM THAT YOU MAY HAVE IN THE FUTURE MUST BE RESOLVED THROUGH BINDING ARBITRATION. YOU WAIVE THE RIGHT TO HAVE YOUR DISPUTE HEARD IN COURT AND WAIVE THE RIGHT TO BRING CLASS CLAIMS. YOU UNDERSTAND THAT DISCOVERY AND APPEAL RIGHTS ARE MORE LIMITED IN ARBITRATION.

Arbitration is a method of resolving a claim, dispute or controversy without filing a lawsuit. By agreeing to arbitrate, the right to go to court is waived and instead claims, disputes or controversies are submitted to binding arbitration. This provision sets forth the terms and conditions of our agreement. YOU and HONDA agree and acknowledge that this Agreement affects interstate commerce and the Federal Arbitration Act ("FAA") applies. By using the Software, Vehicle, or Services, YOU elect to have disputes resolved by arbitration. YOU, HONDA or any involved third party may pursue a Claim. "Claim" means any dispute between YOU, HONDA, or any involved third party relating to your use of the Software, the Vehicle, or the Services, this Agreement, or our relationship, including any representations, omissions or warranties. "Claim" does not include personal injury or wrongful death claims. YOU or HONDA may seek remedies in small claims court or provisional judicial remedies without arbitrating. In addition, notwithstanding anything herein to the contrary, YOU or HONDA may seek equitable relief in a court of competent jurisdiction.

YOU or HONDA may select arbitration with American Arbitration Association, JAMS or National Arbitration and Mediation. Contact these sponsors for their rules. The hearing will be in the federal district where YOU reside. If agreed, it may be by telephone or written submissions. Filing and arbitrator fees to be paid per the sponsor rules. You may contact the sponsor for a fee waiver. If no fee waivers, HONDA will pay filing and arbitrator fees up to \$5,000, unless law requires more. Each party is responsible for other fees. Arbitrator may award costs or fees to prevailing party, if permitted by law. HONDA will not seek fees, unless the claims are frivolous.

Arbitrator shall be an attorney or current or retired judge familiar with automotive or consumer software. The arbitrator shall follow substantive law, statute of limitations and decide all issues relating to the interpretation, construction, enforceability and applicability of this provision. The arbitrator may order relief permitted by law. This provision is governed and enforceable by the FAA. An award shall include a written opinion and be final, subject to appeal by the FAA.

This provision survives termination of this Agreement or relationship, bankruptcy, assignment or transfer. If part of this provision is unenforceable, the remainder remains in effect. If unenforceability allows arbitration as a class action, then this provision is entirely unenforceable. YOU may opt out within 30 days of your initial use of the Software by sending a signed, written notice to HONDA at Honda Financial Services, P.O. Box 165007, Irving, TX 75016. HONDA reserves the right to make changes to this provision after providing written notice and an opportunity to opt out.

N. Miscellaneous: You may not assign this AGREEMENT without HONDA's prior written consent. This AGREEMENT and any additional HONDA TERMS and PROVIDER TERMS represents the entire agreement between you and US. HONDA may amend the terms of this AGREEMENT by providing you with notices of such updated terms. If you do not consent to be bound by the updated terms, your sole remedy will be to cease using the SOFTWARE and SERVICES. If any part of this AGREEMENT is found invalid, void, or unenforceable, the balance of the AGREEMENT will remain valid and enforceable according to its terms. To the fullest extent permitted by law, and except as explicitly provided otherwise, this AGREEMENT and any disputes arising out of or relating to it will be governed by the laws of the State of California, except that California laws concerning choice of law or conflicts shall not apply if they would cause the substantive law of another jurisdiction to apply. Notwithstanding the foregoing, Section M shall be governed by the Federal Arbitration Act and the laws of the State of California, as applicable, as set forth therein. The failure to enforce any term of this AGREEMENT on one occasion shall not prevent enforcement on any other occasion or the enforcement of any other term. Headings and captions shall not be considered included for purposes of interpretation or application hereof, but are for convenience only.

Models with Display Audio

Legal Information on Apple CarPlay/Android Auto

OWNER'S MANUAL LICENSE/LIABILITY STATEMENTS

USE OF APPLE CARPLAY IS SUBJECT TO YOUR AGREEMENT TO THE CARPLAY TERMS OF USE, WHICH ARE INCLUDED AS PART OF THE APPLE iOS TERMS OF USE. IN SUMMARY, THE CARPLAY TERMS OF USE DISCLAIM APPLE AND ITS SERVICE PROVIDERS' LIABILITY IF THE SERVICES FAIL TO PERFORM CORRECTLY OR ARE DISCONTINUED, STRICTLY LIMIT APPLE AND ITS SERVICE PROVIDERS' OTHER LIABILITIES, DESCRIBE THE KINDS OF USER INFORMATION (INCLUDING, FOR EXAMPLE, VEHICLE LOCATION, VEHICLE SPEED, AND VEHICLE STATUS) BEING GATHERED AND STORED BY APPLE AND ITS SERVICE PROVIDERS, AND DISCLOSE CERTAIN POSSIBLE RISKS ASSOCIATED WITH THE USE OF CARPLAY, INCLUDING THE POTENTIAL FOR DRIVER DISTRACTION. SEE APPLE'S PRIVACY POLICY FOR DETAILS REGARDING APPLE'S USE AND HANDLING OF DATA UPLOADED BY CARPLAY.

USE OF ANDROID AUTO IS SUBJECT TO YOUR AGREEMENT TO THE ANDROID AUTO TERMS OF USE WHICH MUST BE AGREED TO WHEN THE ANDROID AUTO APPLICATION IS DOWNLOADED TO YOUR ANDROID PHONE. IN SUMMARY, THE ANDROID AUTO TERMS OF USE DISCLAIM GOOGLE AND ITS SERVICE PROVIDERS' LIABILITY IF THE SERVICES FAIL TO PERFORM CORRECTLY OR ARE DISCONTINUED, STRICTLY LIMIT GOOGLE AND ITS SERVICE PROVIDERS' OTHER LIABILITIES, DESCRIBE THE KINDS OF USER INFORMATION (INCLUDING, FOR EXAMPLE, VEHICLE LOCATION, VEHICLE SPEED, AND VEHICLE STATUS) BEING GATHERED AND STORED BY GOOGLE AND ITS SERVICE PROVIDERS, AND DISCLOSE CERTAIN POSSIBLE RISKS ASSOCIATED WITH THE USE OF ANDROID AUTO, INCLUDING THE POTENTIAL FOR DRIVER DISTRACTION. SEE GOOGLE'S PRIVACY POLICY FOR DETAILS REGARDING GOOGLE'S USE AND HANDLING OF DATA UPLOADED BY ANDROID AUTO.

DISCLAIMER OF WARRANTIES; LIMITATION ON LIABILITY





YOU EXPRESSLY ACKNOWLEDGE AND AGREE THAT USE OF APPLE CARPLAY OR ANDROID AUTO (“THE APPLICATIONS”) IS AT YOUR SOLE RISK AND THAT THE ENTIRE RISK AS TO SATISFACTORY QUALITY, PERFORMANCE, ACCURACY AND EFFORT IS WITH YOU TO THE MAXIMUM EXTENT PERMITTED BY APPLICABLE LAW, AND THAT THE APPLICATIONS AND INFORMATION ON THE APPLICATIONS IS PROVIDED “AS IS” AND “AS AVAILABLE,” WITH ALL FAULTS AND WITHOUT WARRANTY OF ANY KIND, AND HONDA HEREBY DISCLAIMS ALL WARRANTIES AND CONDITIONS WITH RESPECT TO THE APPLICATIONS AND INFORMATION ON THE APPLICATIONS, EITHER EXPRESS, IMPLIED OR STATUTORY, INCLUDING, BUT NOT LIMITED TO, THE IMPLIED WARRANTIES AND/OR CONDITIONS OF MERCHANTABILITY, SATISFACTORY QUALITY, FITNESS FOR A PARTICULAR PURPOSE, ACCURACY, QUIET ENJOYMENT, AND NON-INFRINGEMENT OF THIRD PARTY RIGHTS. NO ORAL OR WRITTEN INFORMATION OR ADVICE GIVEN BY HONDA OR AN AUTHORIZED REPRESENTATIVE SHALL CREATE A WARRANTY. AS EXAMPLES, AND WITHOUT LIMITATION, HONDA DISCLAIMS ANY WARRANTY REGARDING THE ACCURACY OF DATA PROVIDED BY THE APPLICATIONS, SUCH AS THE ACCURACY OF DIRECTIONS, ESTIMATED TRAVEL TIME, SPEED LIMITS, ROAD CONDITIONS, NEWS, WEATHER, TRAFFIC, OR OTHER CONTENT PROVIDED BY APPLE, GOOGLE, THEIR AFFILIATES, OR THIRD PARTY PROVIDERS; HONDA DOES NOT GUARANTEE AGAINST LOSS OF APPLICATION DATA, WHICH MAY BE LOST AT ANY TIME; HONDA DOES NOT GUARANTEE THAT THE APPLICATIONS OR ANY SERVICES PROVIDED THROUGH THEM WILL BE PROVIDED AT ALL TIMES OR THAT ANY OR ALL SERVICES WILL BE AVAILABLE AT ANY PARTICULAR TIME OR LOCATION. FOR EXAMPLE, SERVICES MAY BE SUSPENDED OR INTERRUPTED WITHOUT NOTICE FOR REPAIR, MAINTENANCE, SECURITY FIXES, UPDATES, ETC., SERVICES MAY BE UNAVAILABLE IN YOUR AREA OR LOCATION, ETC. IN ADDITION, YOU UNDERSTAND THAT CHANGES IN THIRD PARTY TECHNOLOGY OR GOVERNMENT REGULATION MAY RENDER THE SERVICES AND/OR APPLICATIONS OBSOLETE AND/OR UNUSABLE.

TO THE EXTENT NOT PROHIBITED BY LAW, IN NO EVENT SHALL HONDA OR ITS AFFILIATES BE LIABLE FOR PERSONAL INJURY, OR ANY INCIDENTAL, SPECIAL, INDIRECT OR CONSEQUENTIAL DAMAGES WHATSOEVER, INCLUDING, WITHOUT LIMITATION, DAMAGES FOR LOSS OF PROFITS, CORRUPTION OR LOSS OF DATA, FAILURE TO TRANSMIT OR RECEIVE ANY DATA, BUSINESS INTERRUPTION OR ANY OTHER COMMERCIAL DAMAGES OR LOSSES, ARISING OUT OF OR RELATED TO THE APPLICATIONS OR YOUR USE OF OR INABILITY TO USE THE APPLICATIONS OR INFORMATION ON THE APPLICATIONS, HOWEVER CAUSED, REGARDLESS OF THE THEORY OF LIABILITY (CONTRACT, TORT OR OTHERWISE) AND EVEN IF HONDA WERE ADVISED OF THE POSSIBILITY OF SUCH DAMAGES. SOME STATES AND JURISDICTIONS DISALLOW THE EXCLUSION OR LIMITATION OF LIABILITY FOR DAMAGES, SO THESE LIMITATIONS AND EXCLUSIONS MAY NOT APPLY TO YOU. IN NO EVENT SHALL HONDA’S TOTAL LIABILITY TO YOU FOR ALL DAMAGES (OTHER THAN AS MAY BE REQUIRED BY APPLICABLE LAW IN CASES INVOLVING PERSONAL INJURY) EXCEED THE AMOUNT OF FIVE DOLLARS (\$5.00). THE FOREGOING LIMITATIONS WILL APPLY EVEN IF THE ABOVE STATED REMEDY FAILS OF ITS ESSENTIAL PURPOSE.

About Open Source Licenses

To see the open source license information, follow these steps.

Models with color audio system

1. Press the **MENU/CLOCK** button.
2. Rotate  to select **Settings**, then press .
3. Rotate  to select **OSS Licenses**, then press .

Models with Display Audio

1. Select .
2. Select **Settings**.
3. Select **System**.
4. Select the **Others** tab.
5. Select **Detail Info**.
6. Select **About device**.
7. Select **Legal information**.
8. Select **Open source licenses**.

▶▶ About Open Source Licenses

Models with color audio system

LICENCE: Copyright © 2001 Bob Trower, Trantor Standard Systems Inc.

Permission is hereby granted, free of charge, to any person obtaining a copy of this software and associated documentation files (the "Software"), to deal in the Software without restriction, including without limitation the rights to use, copy, modify, merge, publish, distribute, sublicense, and/or sell copies of the Software, and to permit persons to whom the Software is furnished to do so, subject to the following conditions:

The above copyright notice and this permission notice shall be included in all copies or substantial portions of the Software.

THE SOFTWARE IS PROVIDED "AS IS", WITHOUT WARRANTY OF ANY KIND, EXPRESS OR IMPLIED, INCLUDING BUT NOT LIMITED TO THE WARRANTIES OF MERCHANTABILITY, FITNESS FOR A PARTICULAR PURPOSE AND NONINFRINGEMENT. IN NO EVENT SHALL THE AUTHORS OR COPYRIGHT HOLDERS BE LIABLE FOR ANY CLAIM, DAMAGES OR OTHER LIABILITY, WHETHER IN AN ACTION OF CONTRACT, TORT OR OTHERWISE, ARISING FROM, OUT OF OR IN CONNECTION WITH THE SOFTWARE OR THE USE OR OTHER DEALINGS IN THE SOFTWARE.

License Information

■ DOLBY DIGITAL

Manufactured under license from Dolby Laboratories. Dolby and the double-D symbol are registered trademarks of Dolby Laboratories.



■ DTS

For DTS patents, see <http://patents.dts.com>. Manufactured under license from DTS Licensing Limited. DTS, the Symbol, & DTS and the Symbol together are registered trademarks, and DTS Digital Surround and Neural Surround are trademarks of DTS, Inc. © DTS, Inc. All Rights Reserved.



Use the audio/information screen to customize certain features.

Models with color audio system

How to customize

While the vehicle is at a complete stop with the ignition switch in ON **II***1, press the **MENU/CLOCK** button, then select **Settings**. To customize the phone settings, press the  button, then select **Phone Setup**.

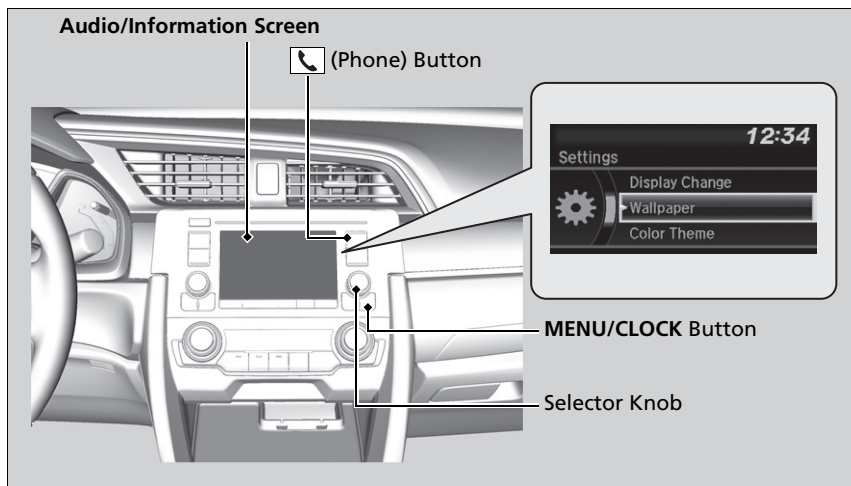

*1: Models with the smart entry system have an **ENGINE START/STOP** button instead of an ignition switch.

Customized Features

When you customize settings:

- Make sure that the vehicle is at a complete stop.

Continuously variable transmission models

- Shift to **P**.

Manual transmission models



- Set the parking brake.

How to customize

These indications are used to show how to operate the selector knob.

Rotate  to select.

Press  to enter.

To customize other features, select **Settings**, rotate , then press .

 **List of customizable options** P. 320

Models with color audio system

Customization Flow

Press the MENU/CLOCK button.

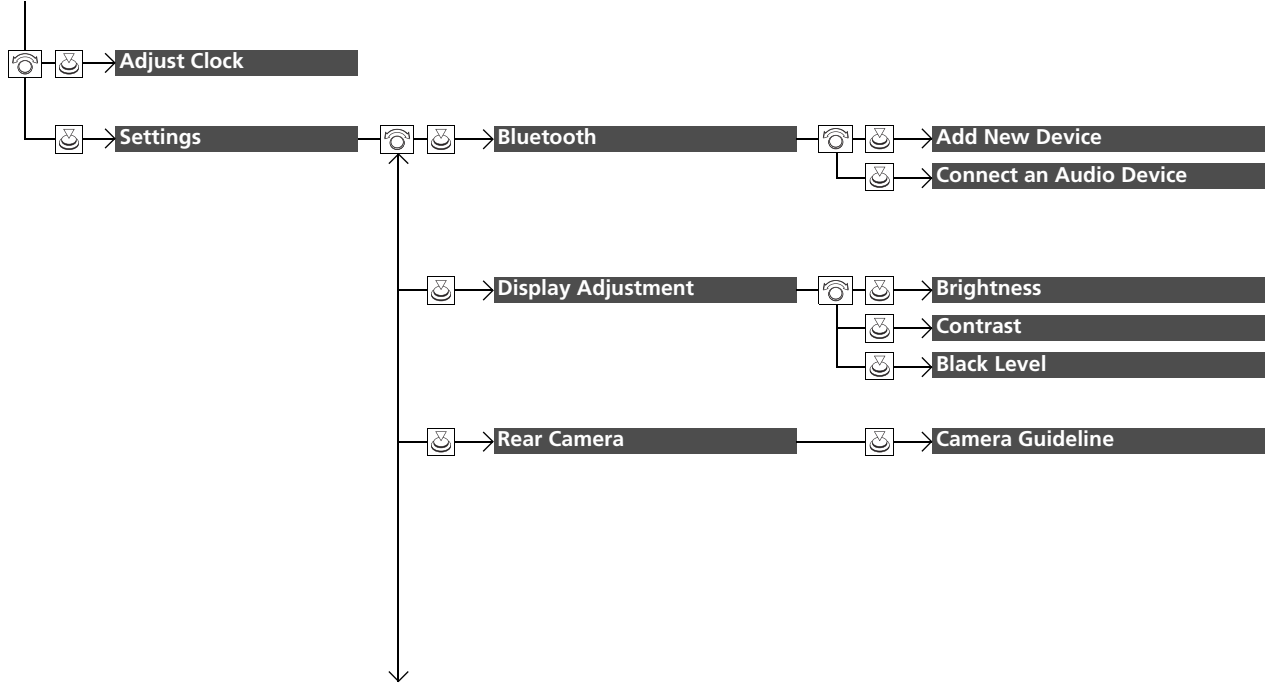

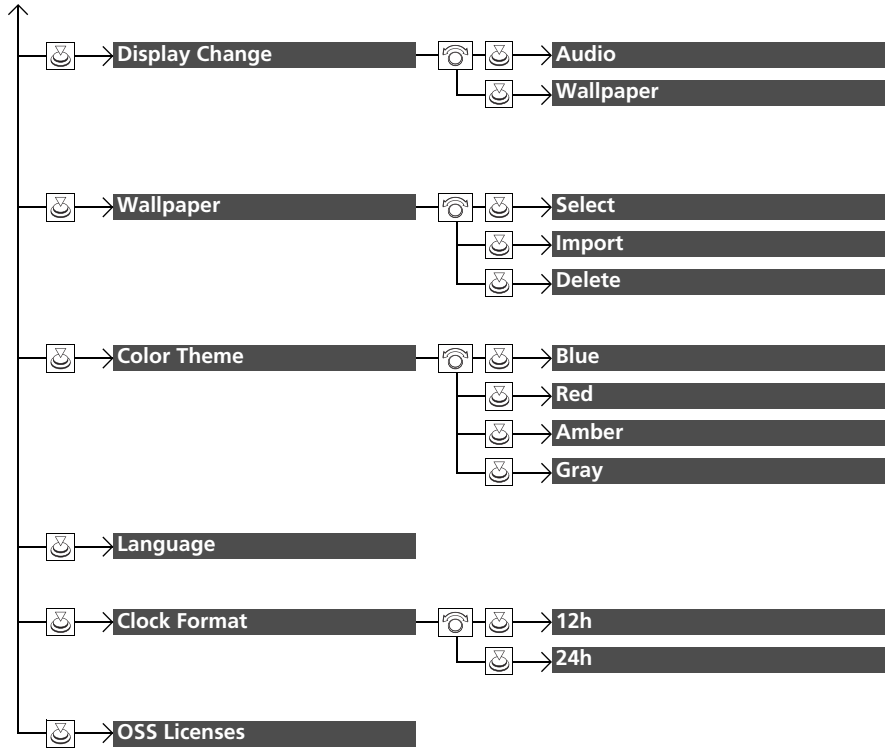

Press the  button and rotate  to select **Phone Setup**, then press .

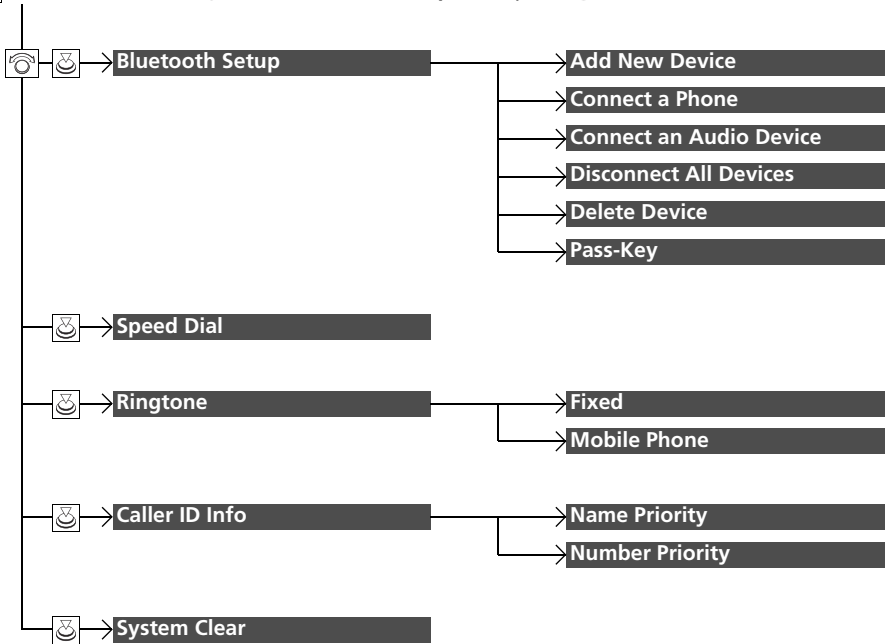

Models with color audio system

■ List of customizable options

Setup Group	Customizable Features	Description	Selectable Settings	
Settings	Adjust Clock	Adjust Clock. ☒ Clock P. 126	—	
	Bluetooth	Add New Device	Pairs a new phone to HFL, edits and deletes a paired phone, and create a code for a paired phone. ☒ Phone Setup P. 355	—
		Connect an Audio Device	Connects, disconnects or pairs a <i>Bluetooth</i> ® Audio device to HFL.	—
	Display Adjustment	Brightness	Changes the brightness of the audio/information screen.	—
		Contrast	Changes the contrast of the audio/information screen.	—
		Black Level	Changes the black level of the audio/information screen.	—
	Rear Camera	Camera Guideline	Selects whether the guidelines come on the audio/information screen.	On *1/ Off

*1:Default Setting

Setup Group	Customizable Features	Description	Selectable Settings	
Settings	Display Change	Changes the display type.	Audio^{*1}/Wallpaper	
	Wallpaper	Select	Changes the wallpaper type.	Clock^{*1}/Image1/Image2/ Image3
		Import	Imports an image file for a new wallpaper. 📁 Wallpaper Setup P. 210	—
		Delete	Deletes an image file for a wallpaper.	Image1^{*1}/Image2/Image3
	Color Theme	Changes the background color of the audio/ information screen.	Blue^{*1}/Red/Amber/Gray	
	Language	Changes the display language.	English^{*1}/Français/Español	
	Clock Format	Selects the digital clock display from 12H to 24H.	12H^{*1}/24H	
	OSS Licenses	Shows the legal information.	—	



*1:Default Setting

Setup Group	Customizable Features	Description	Selectable Settings
Phone Setup	Add New Device	Pairs a new phone to HFL. ➤ Phone Setup P. 355	—
	Connect a Phone	Pairs a new phone or connects a paired phone to HFL. ➤ Phone Setup P. 355	—
	Bluetooth Setup		
	Connect an Audio Device	Connects a <i>Bluetooth</i> ® Audio device to HFL.	—
	Disconnect All Devices	Disconnects a paired phone from HFL.	—
	Delete Device	Deletes a paired phone.	—
	Pass-Key	Inputs and changes a code for a paired phone.	—
	Speed Dial	Edits, adds or deletes a speed dial entry. ➤ Speed Dial P. 362	—
	Ringtone	Selects the ring tone.	Fixed/Mobile Phone *1
	Caller ID Info	Prioritizes the caller's name or phone number as the caller ID.	Name Priority *1/ Number Priority
System Clear	Cancels/Resets all customized items in the Phone Setup group as default.	—	

*1:Default Setting

Models with Display Audio

■ How to customize

While the vehicle is at a complete stop with the ignition switch in ON *1, select  and **Settings**, then select a setting item.

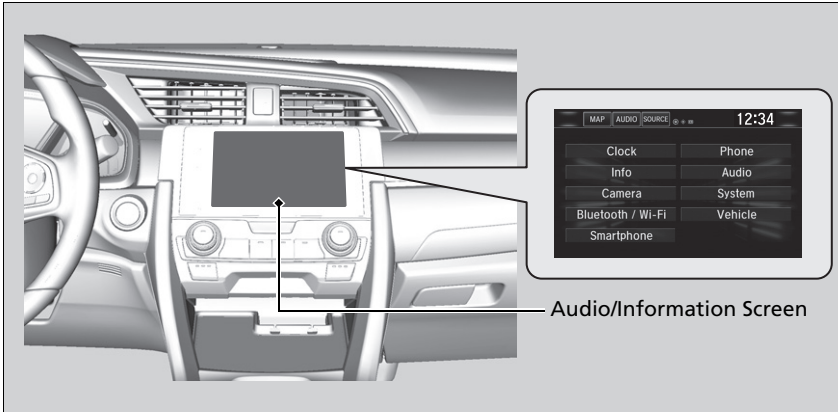

Audio/Information Screen

*1: Models with the smart entry system have an **ENGINE START/STOP** button instead of an ignition switch.

▶▶ Customized Features

When you customize settings:

- Make sure that the vehicle is at a complete stop.

Continuously variable transmission models

- Shift to .

Manual transmission models

- Set the parking brake.

To customize other features, select **Settings**.

➤ **List of customizable options** P. 331

Models with Display Audio

■ Customization flow

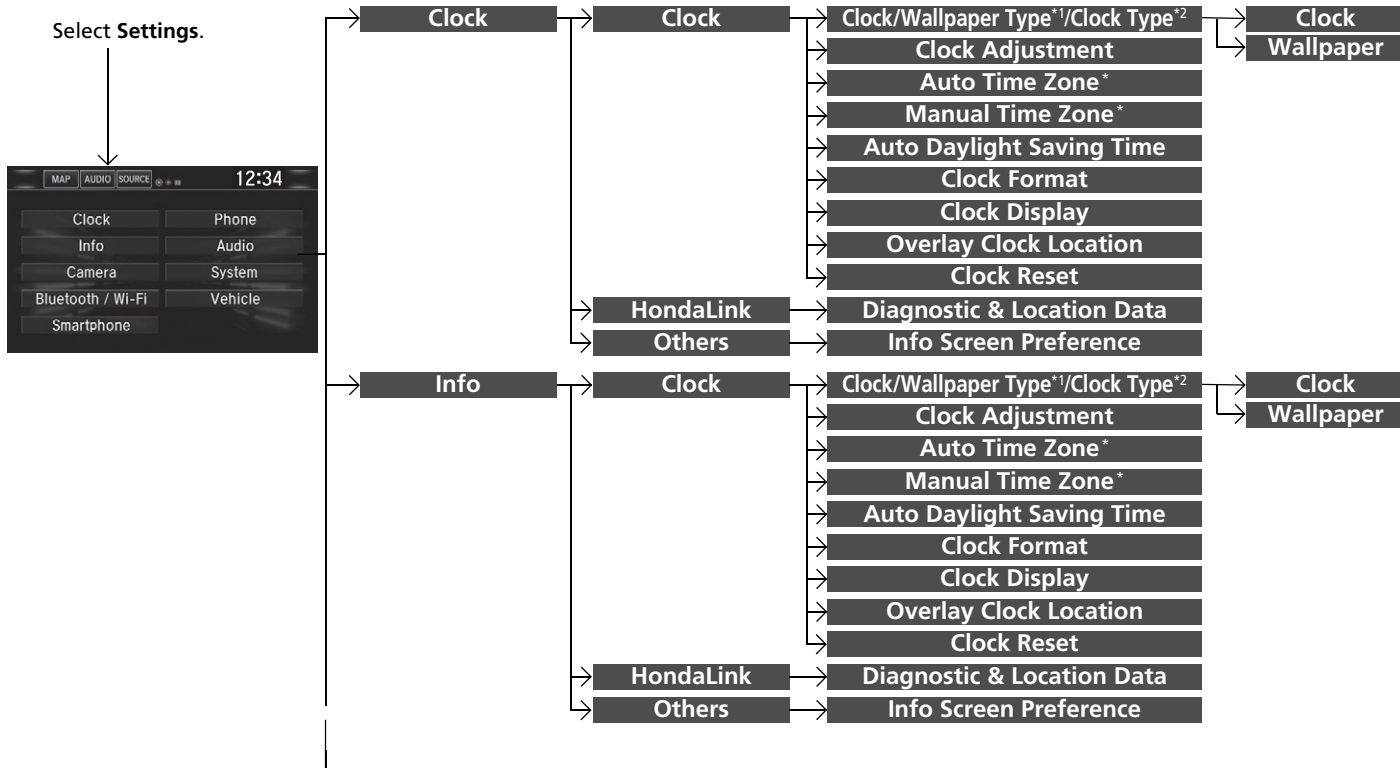

*1 : Does not appear when you change the screen interface design.

*2: Appears only when you change the screen interface design.

* Not available on all models

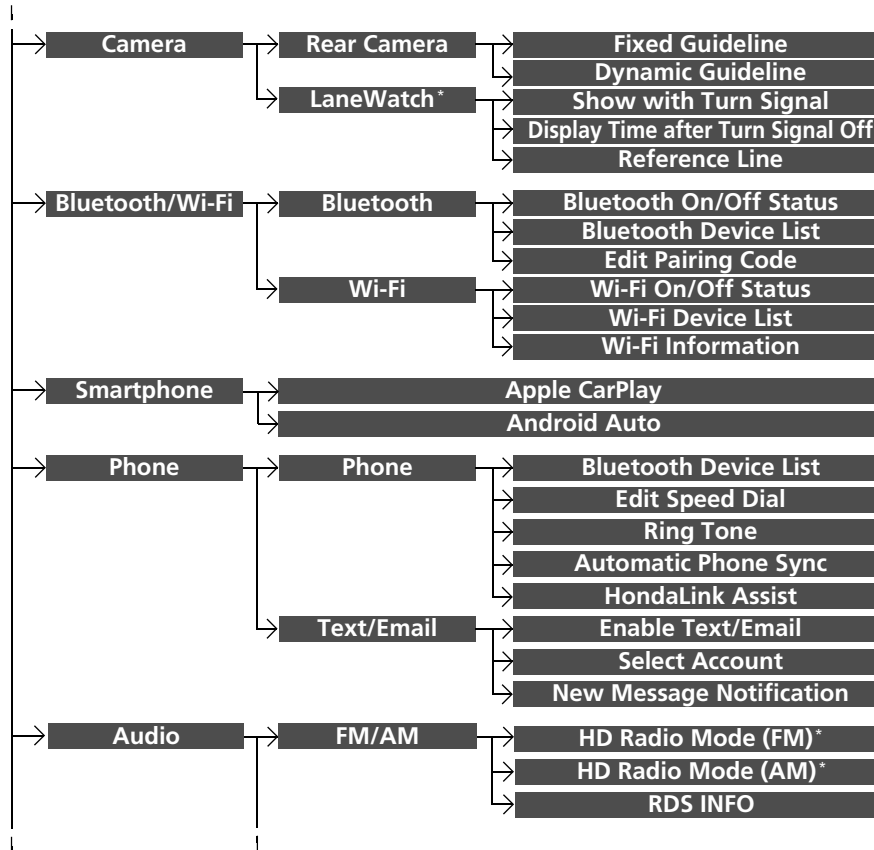

* Not available on all models

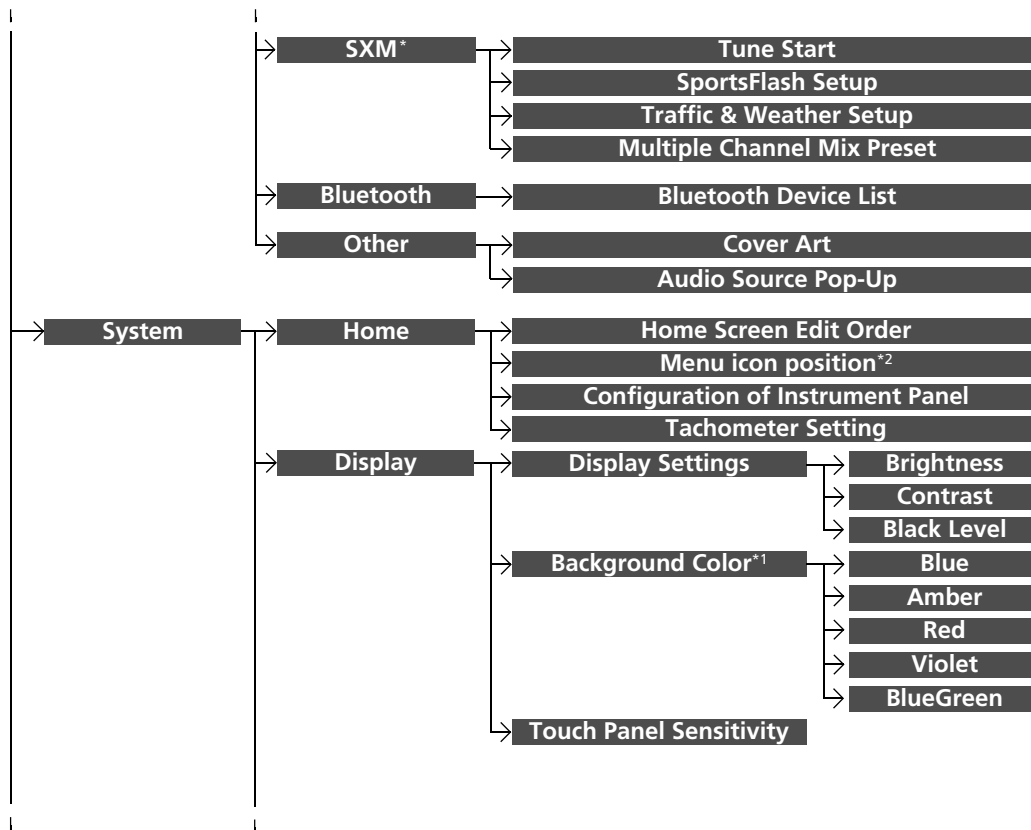

*1 : Does not appear when you change the screen interface design.

*2 : Appears only when you change the screen interface design.

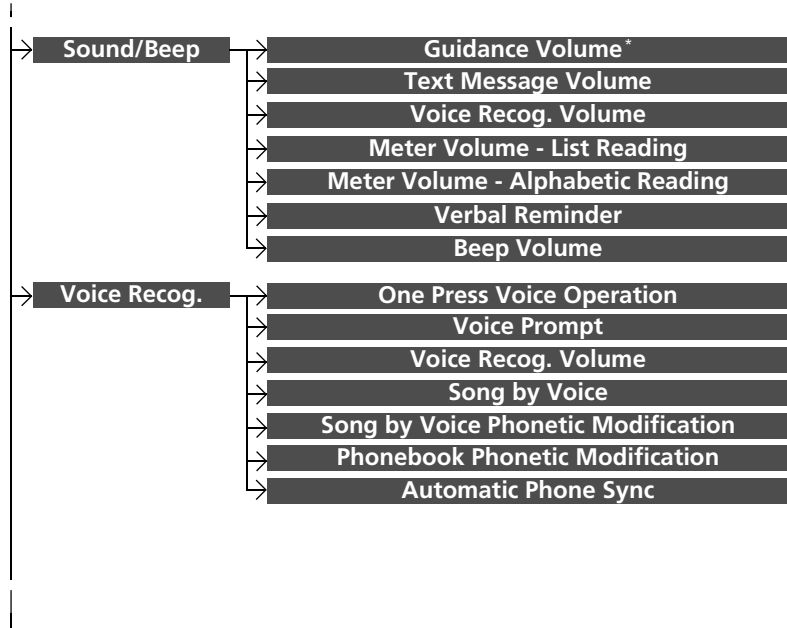

* Not available on all models

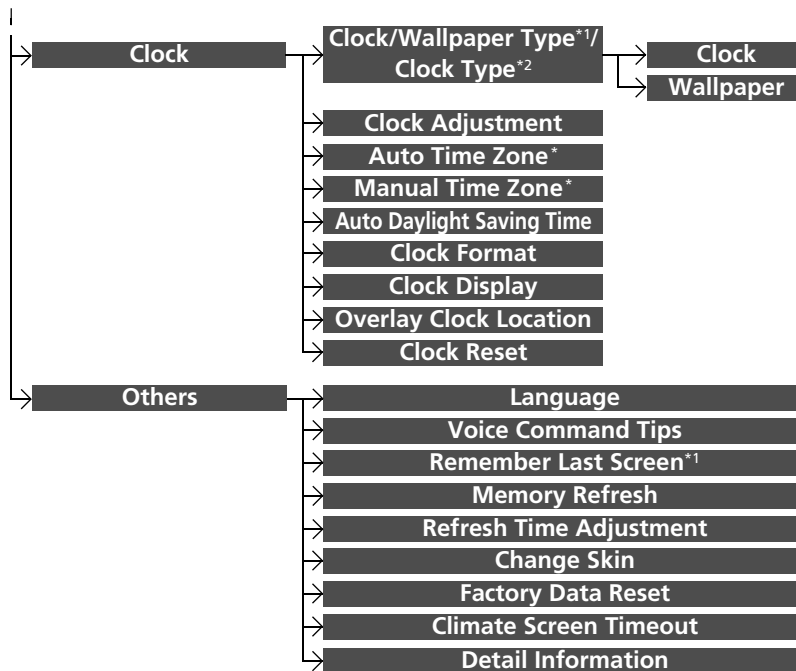

*1 : Does not appear when you change the screen interface design.

*2 : Appears only when you change the screen interface design.

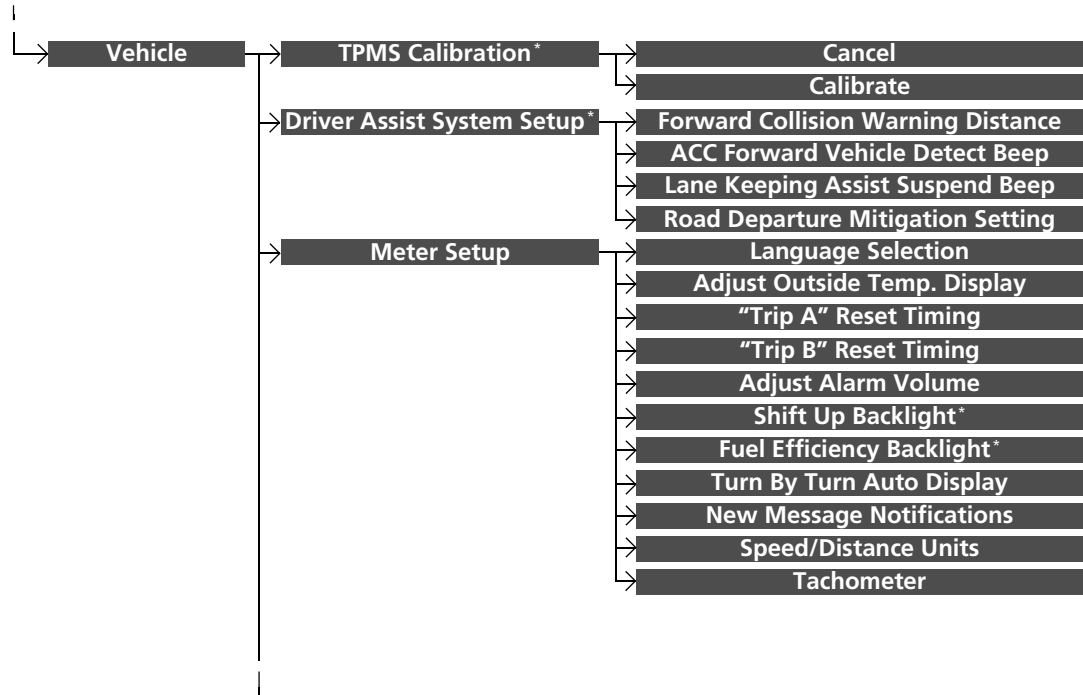

* Not available on all models

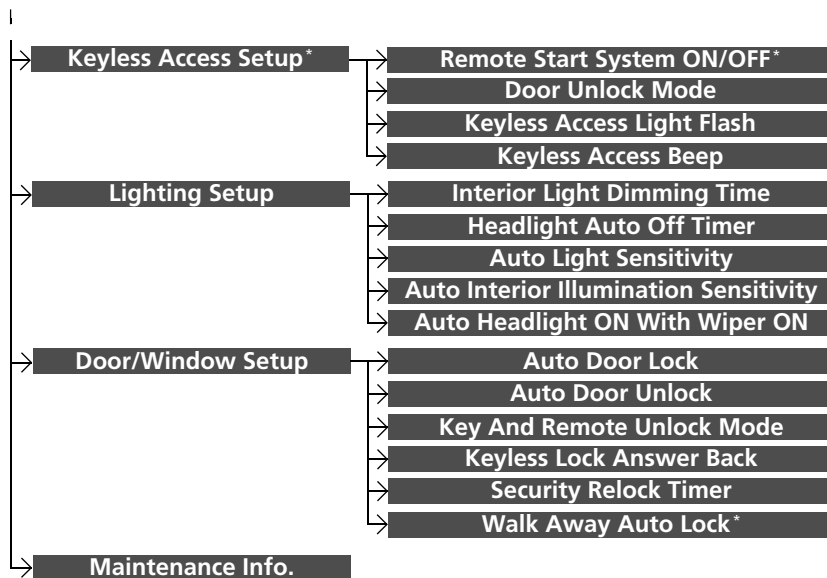

Models with Display Audio

■ List of customizable options

Setup Group	Customizable Features	Description	Selectable Settings
Clock	Clock/ Wallpaper Type* ¹ /Clock Type* ²	Clock Wallpaper	
	Clock Adjustment		
	Auto Time Zone*		
	Manual Time Zone*		
	Auto Daylight Saving Time		See Info on P. 332
	Clock Format		
	Clock Display		
	Overlay Clock Location		
	Clock Reset		
	HondaLink	Diagnostic & Location Data	
Others	Info Screen Preference		
Default		Cancels/Resets all customized items in the Clock group as default.	Yes/No

*1: Does not appear when you change the screen interface design.

*2: Appears only when you change the screen interface design.

* Not available on all models

Setup Group	Customizable Features		Description	Selectable Settings	
Info	Clock	Clock/ Wallpaper Type^{*2/}	Clock	Changes the clock display type.	Analog/Digital^{*1/} Small Digital/Off
		Clock Type^{*3}	Wallpaper	<ul style="list-style-type: none"> • Changes the wallpaper type. • Imports an image file for a new wallpaper. • Deletes an image file for a wallpaper. 	Blank/Galaxy^{*1/} Metallic/Time Zone
		Clock Adjustment		Adjusts Clock.	—
		Auto Time Zone[*]		Automatically adjusts the clock when driving through different time zones.	On^{*1/}Off
		Manual Time Zone[*]		Changes the time zone manually.	—
		Auto Daylight Saving Time		Select On to have the GPS automatically adjust the clock to daylight savings time. Select Off to cancel this function.	On^{*1/}Off
		Clock Format		Selects the digital clock display from 12H to 24H.	12H^{*1/}24H
		Clock Display		Selects whether the clock display comes on.	On^{*1/}Off
		Overlay Clock Location		Changes the clock display layout.	Upper Right^{*1/}Upper Left/Lower Right/ Lower Left/Off
		Clock Reset		Resets the clock settings to the factory default.	Yes/No

*1:Default Setting

*2:Does not appear when you change the screen interface design.

*3:Appears only when you change the screen interface design.

* Not available on all models

Setup Group	Customizable Features		Description	Selectable Settings
	HondaLink	Diagnostic & Location Data	Turns HondaLink® on and off.	On^{*1}/Off
Info	Others	Info Screen Preference	<p>Selects the top menu when the  button is pressed.</p> <ul style="list-style-type: none"> • Info Top- A brief menu pops up. • Info Menu- A full menu pops up. • Off- A menu does not pop up. 	Info Top/Info Menu^{*1}/Off
	Default		Cancels/Resets all customized items in the Info group as default.	Yes/No

*1:Default Setting

Setup Group	Customizable Features	Description	Selectable Settings	
Camera	Rear Camera	Fixed Guideline Selects whether the fixed guidelines come on the rear camera monitor. ➤ Multi-View Rear Camera P. 491	On ^{*1} /Off	
		Dynamic Guideline Selects whether the guidelines adjust to the movement of the steering wheel. ➤ Multi-View Rear Camera P. 491	On ^{*1} /Off	
	Default	Cancels/Resets all customized items in the Rear Camera setting group as default.	Yes/No	
	LaneWatch*	Show with Turn Signal	Selects whether the LaneWatch display comes on when you move the turn signal lever to indicate a right turn.	On ^{*1} /Off
		Display Time after Turn Signal Off	Changes the length of time the LaneWatch display stays on after the turn signal lever returns to the center.	0 second ^{*1} /2 seconds
		Reference Line	Selects whether the reference lines come on the LaneWatch monitor.	On ^{*1} /Off
		Default	Cancels/Resets all customized items in the LaneWatch group as default.	Yes/No

*1:Default Setting

Setup Group	Customizable Features	Description	Selectable Settings
Bluetooth /Wi-Fi	Bluetooth On/Off Status	Changes the <i>Bluetooth</i> ® status.	On*¹/Off
	Bluetooth Device List	Pairs a new phone to HFL, edits or deletes a paired phone. ☒ Phone Setup P. 380	—
	Edit Pairing Code	Edits a pairing code. ☒ To change the pairing code setting P. 381	Random/Fixed*¹
	Wi-Fi On/Off Status	Changes the Wi-Fi mode.	On/Off*¹
	Wi-Fi Device List	Connects, disconnects, or deletes the Wi-Fi device.	—
	Wi-Fi Information	Shows the Wi-Fi information of the head unit.	—
Default		Cancels/Resets all customized items in the Bluetooth/Wi-Fi group as default.	Yes/No
Smart- phone	Apple CarPlay	Sets up the Apple CarPlay connection.	—
	Android Auto	Sets up the Android Auto connection.	—
	Default	Cancels/Resets all customized items in the Smartphone group as default.	Yes/No

*1:Default Setting

Setup Group	Customizable Features	Description	Selectable Settings
Phone	Bluetooth Device List	Pairs a new phone to HFL, connects or disconnects a paired phone. 📄 Phone Setup P. 380	—
	Edit Speed Dial	Edits, adds or deletes a speed dial entry. 📄 Speed Dial P. 386	—
	Ring Tone	Selects the ring tone.	Fixed/Mobile Phone *1
	Automatic Phone Sync	Sets phonebook and call history data to be automatically imported when a phone is paired to HFL.	On *1/ Off
	HondaLink Assist	Turns HondaLink Assist on and off.	On/Off *1
	Enable Text/Email	Turns the text/e-mail message function on and off.	On *1/ Off
	Select Account	Selects a text or e-mail message account.	—
	New Message Notification	Selects whether a pop-up alert comes on the screen when HFL receives a new text/e-mail message.	On/Off
Default	Cancels/Resets all customized items in the Phone settings group as default.		Yes/No

*1:Default Setting

Setup Group	Customizable Features	Description	Selectable Settings	
Audio	FM/AM mode FM/AM	HD Radio Mode*	Selects whether the audio system automatically switches to the digital radio waves or receives the analog waves only.	Auto*¹/Analog Only
		RDS INFO	Turns on and off the RDS information.	On/Off*¹
		Tune Start	Turns on and off, starts the song from the beginning as you change preset stations.	On*¹/Off
		Interrupt	Turns on and off the sports alert function.	Off/On(one time)/ On(continue)*¹
	SiriusXM® mode SXM*	SportsFlash Setup	Favorite Team Selects your favorite sports teams. ▶ Live Sports Alert P. 263	—
		Interrupt Beep	Causes the system to beep when the sports alert is notified.	On*¹/Off
		Traffic & Weather Setup	Selects the region you want to receive the information.	—
		Multiple Channel Mix Preset	Turns multiple channel mix preset on and off.	On/Off*¹

*1:Default Setting

* Not available on all models

Setup Group	Customizable Features	Description	Selectable Settings
Audio	Bluetooth <i>Bluetooth® mode</i>	Bluetooth Device List Pairs a new phone to HFL, edits or deletes a paired phone. ☞ Phone Setup P. 380	—
	Other	Cover Art <i>iPod or USB mode</i> [Your selected media]	Turns the cover art display on and off. On*/Off
		Audio Source Pop-Up	Selects whether the list of selectable audio sources comes on when Audio is selected on the home screen. On/Off*1
	Default	Cancels/Resets all customized items in the Audio settings group as default. Yes/No	
System	Home	Home Screen Edit Order	Changes the HOME screen icon layout. —
		Menu icon position*2	Changes the position of the menu icons on the Audio , Phone , and Info screen. —
		Configuration of Instrument Panel	Changes the Instrument Panel screen icon layout. —
		Tachometer Setting	Turns on and off the tachometer display. On*/Off

*1:Default Setting

*2:Appears only when you change the screen interface design.



Setup Group	Customizable Features	Description	Selectable Settings	
System	Display Settings	Brightness	Changes the brightness of the audio/information screen.	—
		Contrast	Changes the contrast of the audio/information screen.	—
		Black Level	Changes the black level of the audio/information screen.	—
	Display	Background Color *2	Changes the background color of the audio/information screen.	Models without SPORT mode Blue/Amber/Red/Violet/BlueGreen *1
				Models with SPORT mode Blue/Amber/Red *1/ Violet/BlueGreen
		Touch Panel Sensitivity	Sets the sensitivity of the touch panel screen.	High/Low *1
Sound/Beep	Guidance Volume *	Changes the sound volume. Adjusts the guidance volume of the navigation system.	1~6 *1~ 11	
	Text Message Volume	Changes the text/e-mail message reading volume.	1~6 *1~ 11	

*1:Default Setting

*2:Does not appear when you change the screen interface design.

* Not available on all models

Continued

Setup Group	Customizable Features	Description	Selectable Settings
Sound /Beep	Voice Recog. Volume	Changes the volume of the voice prompt.	1~6*1~11
	Meter Volume - List Reading	Changes the list reading volume.	1~6*1~11
	Meter Volume - Alphabetic Reading	Changes the alphabetic reading volume.	1~6*1~11
	Verbal Reminder	Turns the verbal reminders on and off.	On*/Off
	Beep Volume	Changes the beep volume.	Off/1/2*1/3
System	One Press Voice Operation	Changes the setting of the  (Talk) button operation when using the voice operation.	On*/Off
	Voice Prompt	Turns the voice prompt on and off.	On*/Off
	Voice Recog. Volume	Changes the volume of the voice prompt.	1~6*1~11
	Song by Voice	Turns the Song By Voice™ on and off.	On*/Off
	Song by Voice Phonetic Modification	Modifies a voice command for music stored in the system or an iPod/iPhone.  Phonetic Modification P. 271	—
	Phonebook Phonetic Modification	Modifies a voice command for the phonebook.  Phonebook Phonetic Modification P. 389	—
	Automatic Phone Sync	Sets phonebook and call history data to be automatically imported when a phone is paired to HFL.	On*/Off

*1:Default Setting

Setup Group	Customizable Features	Description	Selectable Settings
System	Clock/ Wallpaper Type* ²	Clock	
	Clock Type* ³	Wallpaper	
	Clock Adjustment		
	Auto Time Zone*		
	Manual Time Zone*		See Info on P. 332
	Auto Daylight Saving Time		
	Clock Format		
	Clock Display		
	Overlay Clock Location		
	Clock Reset		
Others	Language	Change the display language.	English* ¹ /Français/ Español

*1:Default Setting

*2:Does not appear when you change the screen interface design.

*3:Appears only when you change the screen interface design.

* Not available on all models

Setup Group	Customizable Features	Description	Selectable Settings
System Others	Voice Command Tips	Alerts you when manual control of the system is disabled to prevent distraction while driving. Only voice commands are available.	On^{*1}/Off
	Remember Last Screen^{*3}	Selects whether the device remembers the last screen.	On/Off^{*1}
	Memory Refresh	Turns on the audio system automatically and restores the fragmentation of memory when the ignition switch is set to LOCK [0] ^{*2} .	On^{*1}/Off
	Refresh Time Adjustment	Sets the time for Memory Refresh .	—
	Change Skin	Changes the screen interface design.	Yes/No
	Factory Data Reset	Resets all the settings to their factory default.  Defaulting All the Settings P. 348	Yes/No

*1:Default Setting

*2:Models with the smart entry system have an **ENGINE START/STOP** button instead of an ignition switch.

*3:Does not appear when you change the screen interface design.

Setup Group	Customizable Features	Description	Selectable Settings	
System	Others	Climate Screen Timeout	Changes the length of time the climate control display stays on when you press the CLIMATE button.	Never/5 Seconds/10 Seconds* ¹ /20 Seconds
		Detail Information	Displays the details of the head unit and operating system information.	—
	Default		Cancels/Resets all customized items in the System group as default.	Yes/No
Vehicle		TPMS Calibration*	Cancels/Calibrates the TPMS.	Cancel/Calibrate
		Forward Collision Warning Distance	Changes CMBS™ alert distance.	Long/Normal* ¹ /Short
	Driver Assist System Setup*	ACC Forward Vehicle Detect Beep	Causes the system to beep when the system detects a vehicle, or when the vehicle goes out of the ACC range.	On/Off* ¹
		Lane Keeping Assist Suspend Beep	Causes the system to beep when LKAS is suspended.	On/Off* ¹
		Road Departure Mitigation Setting	Changes the setting for the road departure mitigation system.	Normal* ¹ /Wide/Warning Only

*1:Default Setting

* Not available on all models

Setup Group	Customizable Features	Description	Selectable Settings
Vehicle Meter Setup	Language Selection	Changes the displayed language on the driver information interface.	English^{*1}/Français/ Español
	Adjust Outside Temp. Display	Adjusts the temperature reading by a few degrees.	-5°F ~ ±0°F^{*1} ~ +5°F (U.S.) -3°C ~ ±0°C^{*1} ~ +3°C (Canada)
	“Trip A” Reset Timing	Changes the setting of how to reset trip meter A and average fuel economy A.	When Refueled/IGN Off/Manually Reset^{*1}
	“Trip B” Reset Timing	Changes the setting of how to reset trip meter B and average fuel economy B.	When Refueled/IGN Off/Manually Reset^{*1}
	Adjust Alarm Volume	Changes the alarm volume, such as buzzers, warnings, turn signal sound, and so on.	High/Mid^{*1}/Low
	Shift Up Backlight[*]	Turns the shift up backlight blink feature on and off.  Shift Up Backlight[*] P. 110	On^{*1}/Off
	Fuel Efficiency Backlight[*]	Turns the ambient meter feature on and off.	On^{*1}/Off
	Turn By Turn Auto Display	Selects whether the turn-by-turn display comes on during the route guidance.	On^{*1}/Off

*1: Default Setting

Setup Group	Customizable Features	Description	Selectable Settings	
Vehicle	New Message Notifications	Used to select whether a pop-up alert comes on the screen when HFL receives a new text/e-mail message.	On*¹/Off	
	Meter Setup	Speed/Distance Units	mph·miles*¹/km/h·km (U.S.)	
			mph·miles/km/h·km*¹ (Canada)	
		Tachometer	Selects whether the tachometer comes on the driver information interface.	On*¹/Off
		Remote Start System ON/OFF*	Turns the remote engine start feature on and off.	On*¹/Off
	Keyless Access Setup*	Door Unlock Mode	Changes which doors unlock when you grab the driver's door handle.	Driver Door Only*¹/ All Doors
		Keyless Access Light Flash	Causes some exterior lights to flash when you unlock/lock the doors.	On*¹/Off
Keyless Access Beep		Causes the beeper to sound when you unlock/lock the doors.	On*¹/Off	

*1:Default Setting

* Not available on all models

Setup Group	Customizable Features	Description	Selectable Settings	
Vehicle	Lighting Setup	Interior Light Dimming Time	Changes the length of time the interior lights stay on after you close the doors.	15seconds/ 30seconds^{*1}/ 60seconds
		Headlight Auto Off Timer	Changes the length of time the exterior lights stay on after you close the driver's door.	0seconds/ 15seconds^{*1}/ 30seconds/ 60seconds
		Auto Light Sensitivity	Changes the timing for the headlights to come on.	Max/High/Mid^{*1}/ Low/Min
		Auto Interior Illumination Sensitivity	Changes the sensitivity of the brightness of the instrument panel when the headlight switch is in the AUTO position.	Max/High/Mid^{*1}/ Low/Min
		Auto Headlight ON With Wiper ON	Changes the settings for the wiper operation when the headlights automatically come on while the headlight switch is in the AUTO position.	On^{*1}/Off

*1:Default Setting

Setup Group	Customizable Features	Description	Selectable Settings	
Vehicle	Auto Door Lock	Changes the setting for when the doors automatically lock.	With Vehicle Speed^{*1}/Shift from P²/Off	
	Auto Door Unlock	Changes the setting for when the doors unlock automatically.	All Doors When Driver's Door Opens^{*1}/All Doors When Shifted to Park^{*2}/All Doors When Ignition Switched Off/Off	
	Door/Window Setup	Key And Remote Unlock Mode	Sets up the driver's door or both doors to unlock on the first push of the remote.	Driver Door^{*1}/All Doors
	Keyless Lock Answer Back	LOCK/UNLOCK- The exterior lights flash. LOCK (2nd push)- The beeper sounds.	On^{*1}/Off	
	Security Relock Timer	Changes the time it takes for the doors to relock and the security system to set after you unlock the vehicle without opening either door.	90seconds/ 60seconds/ 30seconds^{*1}	
	Walk Away Auto Lock[*]	Changes the settings for the auto lock function when you walk away from the vehicle.	On/Off^{*1}	
	Maintenance Info.	Used to reset the engine oil life display when the maintenance service has been performed.	—	
Default	Cancels/Resets all customized items in the Vehicle group as default.	Yes/No		

*1:Default Setting

*2:Continuously variable transmission models

* Not available on all models

Models with Display Audio

Defaulting All the Settings

Reset all the menu and customized settings as the factory defaults.

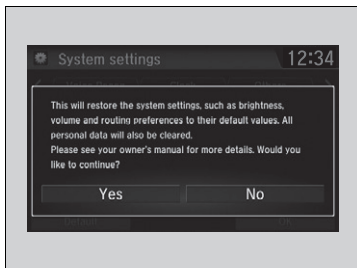

1. Select .
2. Select **Settings**.
3. Select **System**.
4. Select the **Others** tab.
5. Select **Factory Data Reset**.
 - A confirmation message appears on the screen.
6. Select **Yes** to reset the settings.
7. Select **Yes** again to reset the settings.
 - A confirmation message appears on the screen. Select **OK**.
 - After selecting **OK**, the system will reboot.

►► Defaulting All the Settings

When you transfer the vehicle to a third party, reset all settings to default and delete all personal data.

If you perform **Factory Data Reset**, it will reset the preinstalled apps to their factory default.

If you perform **Factory Data Reset**, you cannot use the HondaLink® because it becomes off line.

► **HondaLink®** P. 280

Models with color audio system

Bluetooth® HandsFreeLink® (HFL) allows you to place and receive phone calls using your vehicle's audio system, without handling your cell phone.

Using HFL

HFL Buttons

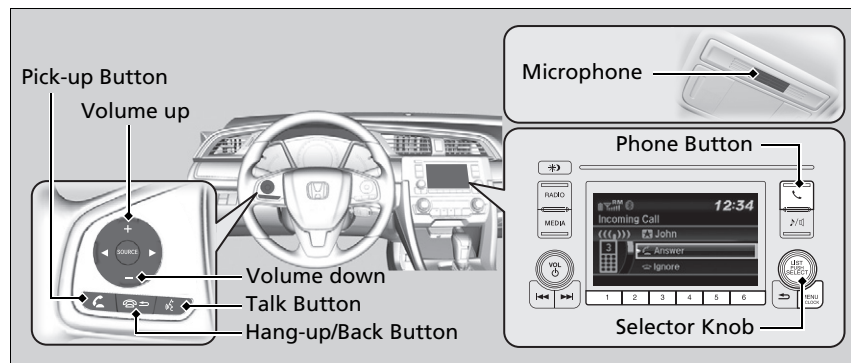

(Pick-up) button: Press to go directly to the **Phone** screen or to answer an incoming call.

(Hang-up/back) button: Press to end a call or to cancel a command.

(Talk) button: Press to call a number with a stored voice tag.

(Phone) button: Press to go directly to the **Phone** screen.

Selector knob: Rotate to select an item on the screen, then press.

Bluetooth® HandsFreeLink®

Place your phone where you can get good reception.

To use HFL, you need a Bluetooth-compatible cell phone. For a list of compatible phones, pairing procedures, and special feature capabilities:

- U.S.: Visit automobiles.honda.com/handsfreelink/, or call 1-888-528-7876.
- Canada: For more information on smartphone compatibility, call 1-888-528-7876.

Voice control tips

- Aim the vents away from the ceiling and close the windows, as noise coming from them may interfere with the microphone.
- Press and release the  button when you want to call a number using a stored voice tag. Speak clearly and naturally after a beep.
- If the microphone picks up voices other than yours, the command may be misinterpreted.
- To change the volume level, use the audio system's volume knob or the remote audio controls on the steering wheel.

State or local laws may prohibit the operation of handheld electronic devices while operating a vehicle.

If you receive a call while using the audio system, the system resumes its operation after ending the call.

Up to 20 speed dial entries can be stored. If there is no entry in the system, Speed Dial is disabled.

 **Speed Dial** P. 362

Up to 20 call histories can be stored. If there is no call history, Call History is disabled.

Continued

HFL Status Display

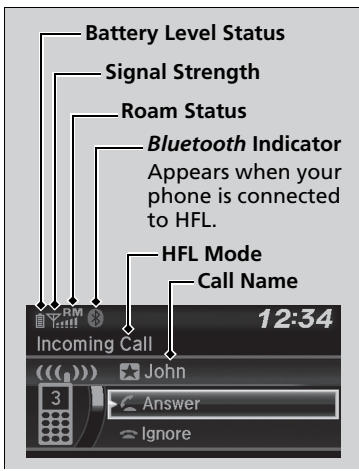

The audio/information screen notifies you when there is an incoming call.

Limitations for Manual Operation

Certain manual functions are disabled or inoperable while the vehicle is in motion. You cannot select a grayed-out option until the vehicle is stopped.

Only previously stored speed dial entries can be called using voice commands while the vehicle is in motion.

▶ **Speed Dial** P. 362

Bluetooth® HandsFreeLink®

Bluetooth® Wireless Technology
The *Bluetooth®* word mark and logos are registered trademarks owned by *Bluetooth SIG, Inc.*, and any use of such marks by Honda Motor Co., Ltd., is under license. Other trademarks and trade names are those of their respective owners.

HFL Limitations
An incoming call on HFL will interrupt the audio system when it is playing. It will resume when the call is ended.

HFL Status Display

The information that appears on the audio/information screen varies between phone models.

You can change the system language to English, French, or Spanish.

▶ **Customized Features** P. 316

HFL Menu

The ignition switch must be in ACCESSORY **I** or ON **II***1 to use HFL.

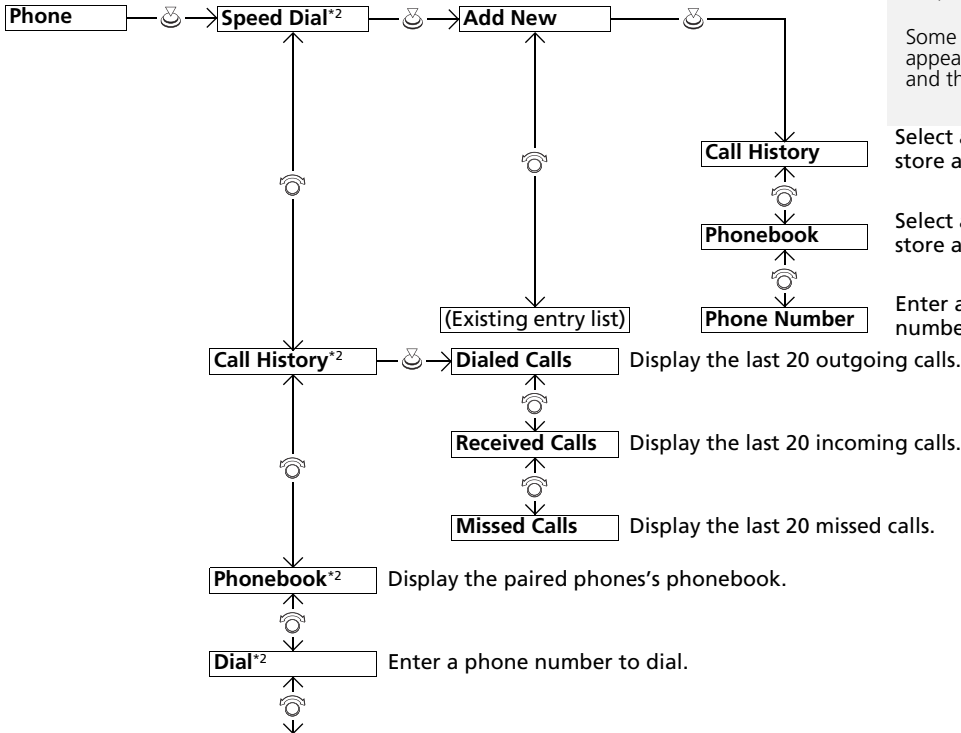
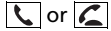

HFL Menu

To use HFL, you must first pair your *Bluetooth*-compatible cell phone to the system while the vehicle is parked.

Some functions are limited while driving. A message appears on the screen when the vehicle is moving and the operation is canceled.

Select a phone number from the call history to store as a speed dial number.

Select a phone number from the phonebook to store as a speed dial number.

Enter a phone number to store as a speed dial number.

Display the last 20 outgoing calls.

Display the last 20 incoming calls.

Display the last 20 missed calls.

Display the paired phones' phonebook.

Enter a phone number to dial.

*1: Models with the smart entry system have an **ENGINE START/STOP** button instead of an ignition switch.

*2: Appears only when a phone is connected to HFL.

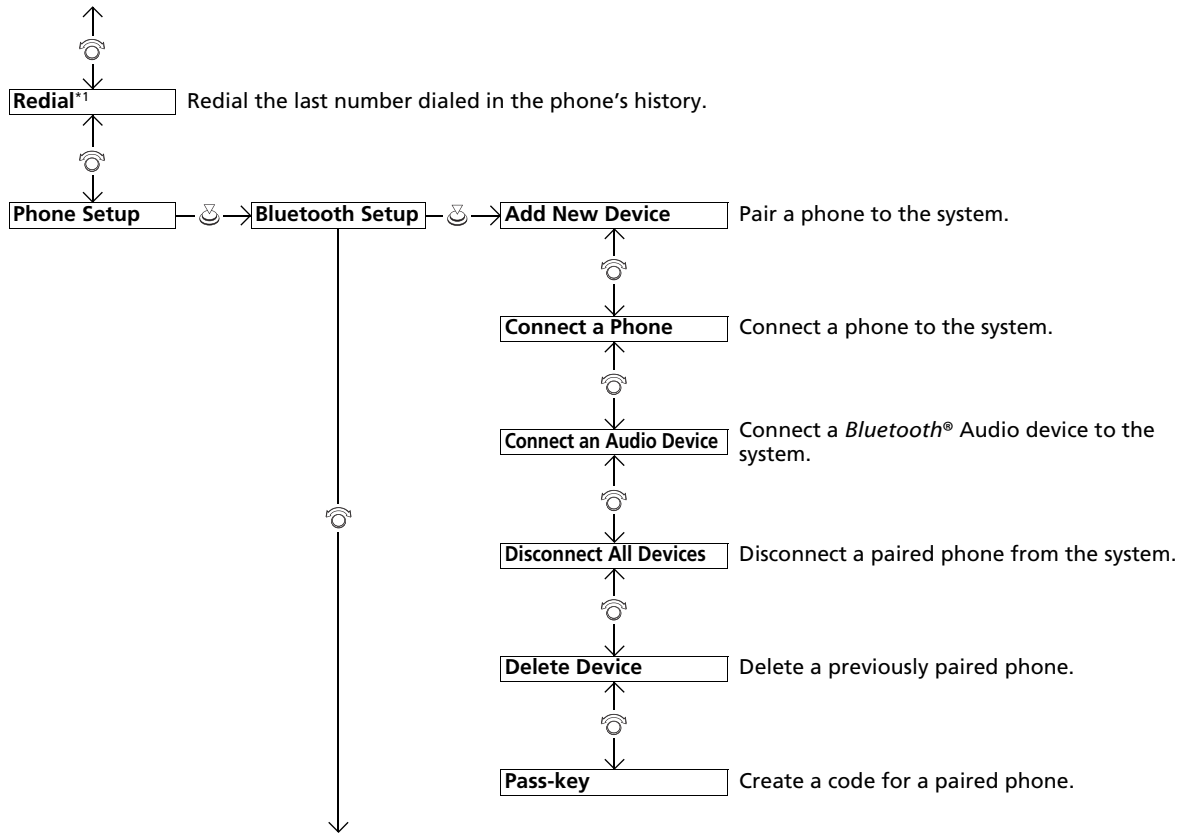

*1: Appears only when a phone is connected to HFL.

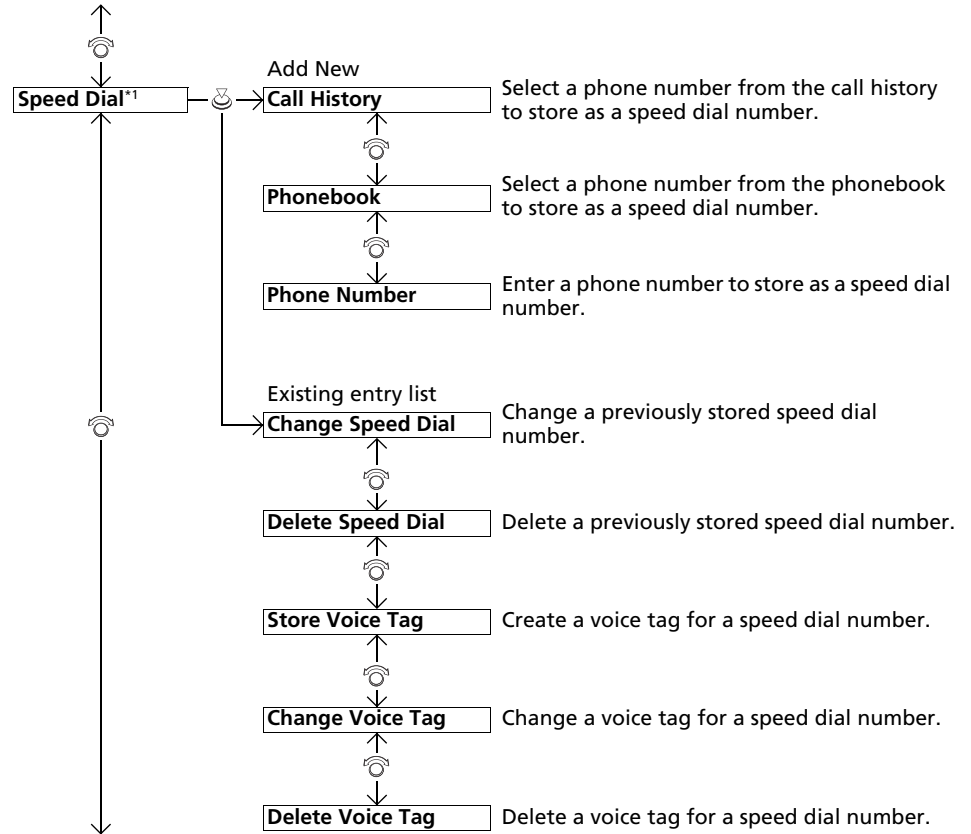

*1: Appears only when a phone is connected to HFL.

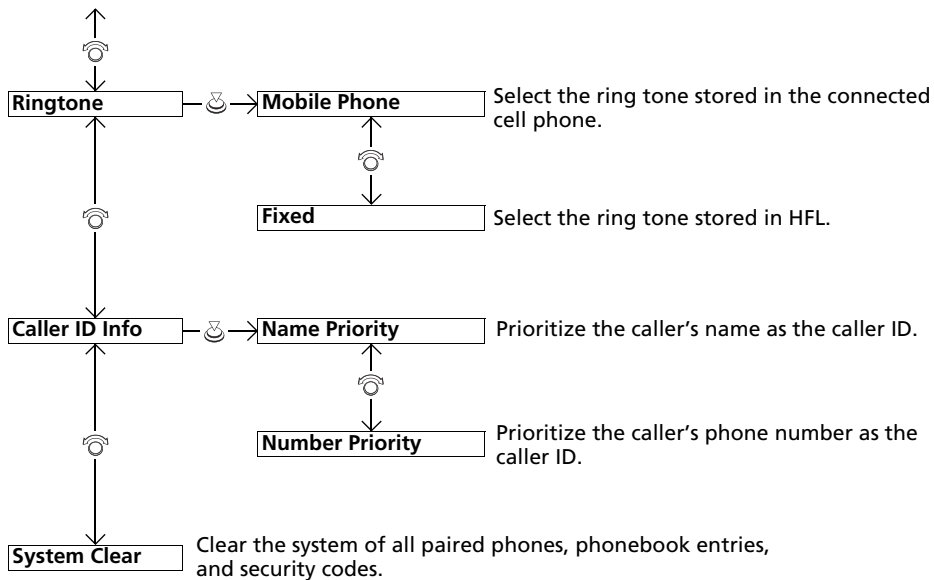

Phone Setup

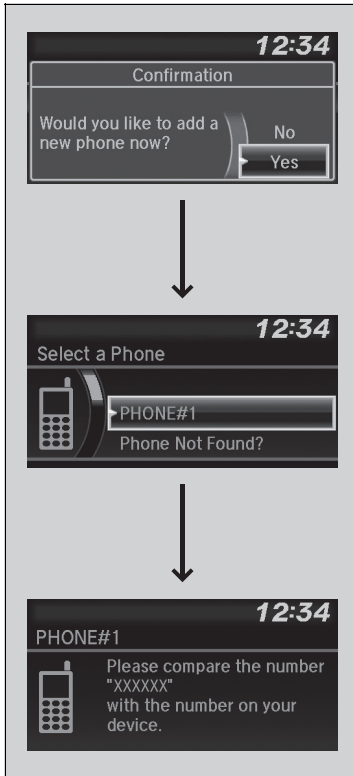

■ To pair a cell phone (No phone has been paired to the system)

1. Press the button or the button.
2. Rotate to select **Yes**, then press .
3. Make sure your phone is in search or discoverable mode, then press .
 - ▶ HFL automatically searches for a *Bluetooth*® device.
4. When your phone appears on the list, select it by pressing .
 - ▶ If your phone doesn't appear, select **Phone Not Found?** and search for *Bluetooth*® devices using your phone. From your phone, select **HandsFreeLink**.
5. The system gives you a pairing code on the audio/information screen.
 - ▶ Confirm if the pairing code on the screen and your phone match. This may vary by phone.
6. A notification appears on the screen if pairing is successful.

☒ Phone Setup

Your *Bluetooth*-compatible phone must be paired to HFL before you can make and receive hands-free calls.

Phone Pairing Tips:

- You cannot pair your phone while the vehicle is moving.
- Up to six phones can be paired.
- Your phone's battery may drain faster when it is paired to HFL.
- If your phone is not ready for pairing or not found by the system within three minutes, the system will time out and return to idle.

Once you have paired a phone, you can see it displayed on the screen with one or two icons on the right side.

These icons indicate the following:

: The phone can be used with HFL.

: The phone is compatible with *Bluetooth*® Audio.

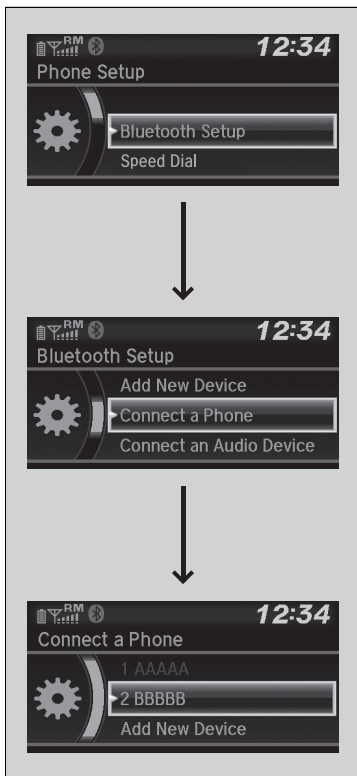

■ **To change the currently paired phone**

1. Press the button or the button.
2. Rotate to select **Phone Setup**, then press .
3. Rotate to select **Bluetooth Setup**, then press .
4. Rotate to select **Connect a Phone**, then press .
▶ The screen changes to a device list.
5. Rotate to select a desired device name, then press .
▶ HFL disconnects the connected phone and starts searching for another paired phone.

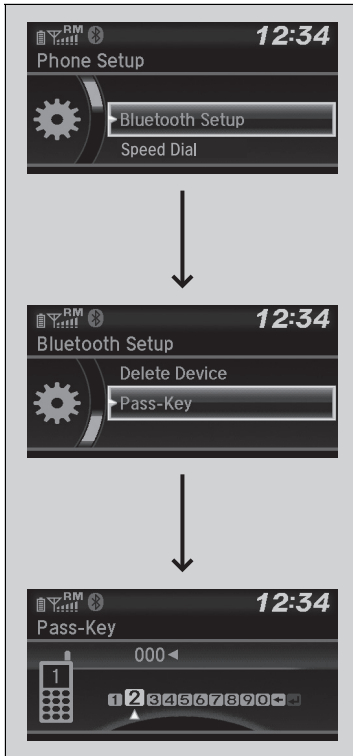

■ **To change the pairing code setting**

1. Press the button or the button.
2. Rotate to select **Phone Setup**, then press .
3. Rotate to select **Bluetooth Setup**, then press .
4. Rotate to select **Pass-Key**, then press .
5. Input a new pairing code, then press .

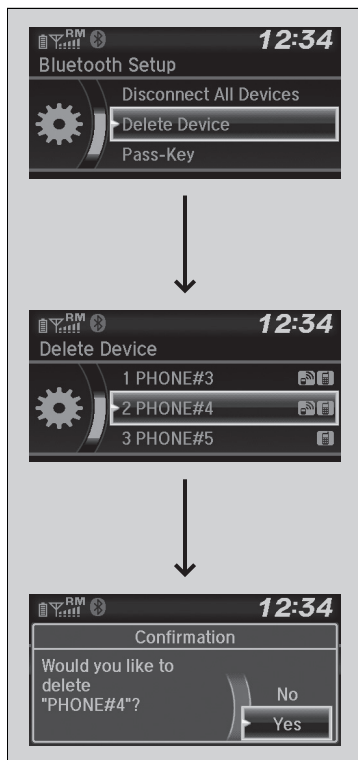

■ **To delete a paired phone**

1. Press the button or the button.
2. Rotate to select **Phone Setup**, then press .
3. Rotate to select **Bluetooth Setup**, then press .
4. Rotate to select **Delete Device**, then press .
 - ▶ The screen changes to a device list.
5. Rotate to select a phone you want to delete, then press .
6. A confirmation message appears on the screen. Rotate to select **Yes**, then press .

Ring Tone

You can change the ring tone setting.



1. Press the button or the button.
2. Rotate to select **Phone Setup**, then press .
3. Rotate to select **Ringtone**, then press .
4. Rotate to select **Fixed** or **Mobile Phone**, then press .

Caller's ID Information

You can select a caller's information to be displayed when you have an incoming call.

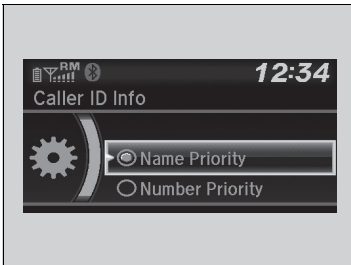

1. Press the button or the button.
2. Rotate to select **Phone Setup**, then press .
3. Rotate to select **Caller ID Info**, then press .
4. Rotate to select a mode you want, then press .

Ring Tone

Fixed: The fixed ring tone sounds from the speakers.
Mobile Phone: For certain connected phones, the ring tone stored in the phone sounds from the speakers.

Caller's ID Information

Name Priority: A caller's name is displayed if it is stored in the phonebook.
Number Priority: A caller's phone number is displayed.

■ To Clear the System

Pairing codes, paired phones, all stored voice tags, all speed dial entries, all call history data, and all imported phonebook data are erased.

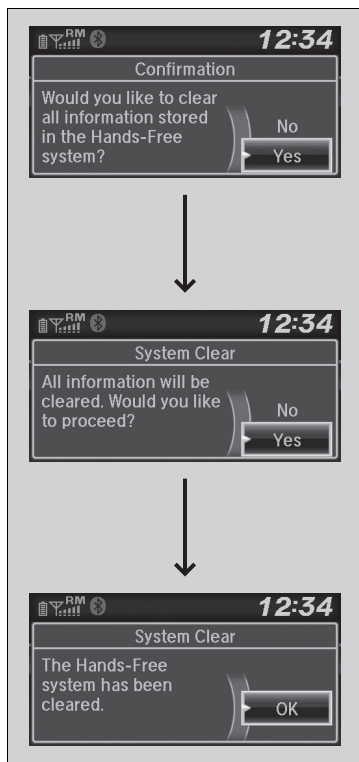

1. Press the button or the button.
2. Rotate to select **Phone Setup**, then press .
3. Rotate to select **System Clear**, then press .
4. Rotate to select **Yes**, then press .
5. A confirmation message appears on the screen. Rotate to select **Yes**, then press .
6. A notification appears on the screen. Press .

Automatic Import of Cellular Phonebook and Call History

When your phone is paired, the contents of its phonebook and call history are automatically imported to HFL.

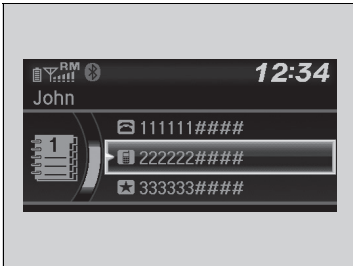

Automatic Import of Cellular Phonebook and Call History

When you select a person from the list in the cellular phonebook, you can see up to three category icons. The icons indicate what types of numbers are stored for that name.

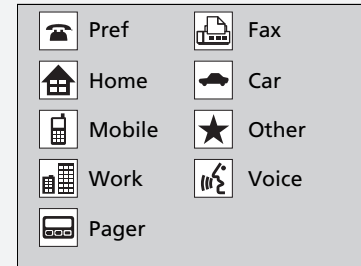

If a name has four or more numbers, ... appears instead of category icons.

On some phones, it may not be possible to import the category icons to HFL.

The phonebook is updated after every connection. Call history is updated after every connection or call.

■ Speed Dial

Up to 20 speed dial numbers can be stored per phone.

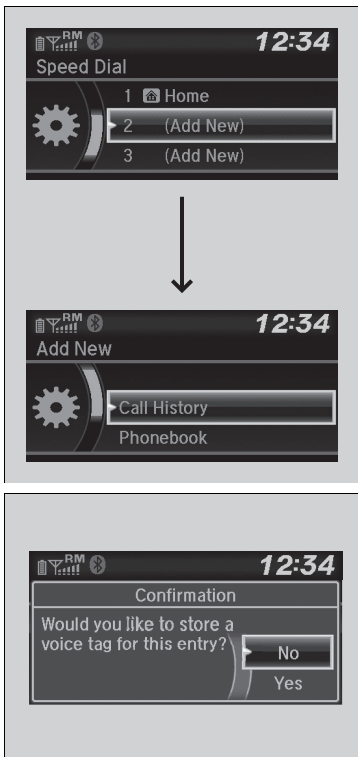

To store a speed dial number:

1. Press the button or the button.
2. Rotate to select **Speed Dial**, then press .
3. Rotate to select **Add New**, then press .
4. Rotate to select a place to choose a number from, then press .

From **Call History**:

- ▶ Select a number from the call history.

From **Phonebook**:

- ▶ Select a number from the connected cell phone's imported phonebook.

From **Phone Number**:

- ▶ Input the number manually.

5. When the speed dial is successfully stored, you are asked to create a voice tag for the number. Rotate to select **Yes** or **No**, then press .
6. Using the button, follow the prompts to say the name for the speed dial entry.

▶▶ Speed Dial

You can use the audio preset buttons during a call to store a speed dial number:

1. Press and hold the desired audio preset button during a call.
2. The contact information for the active call will be stored for the corresponding speed dial.

When a voice tag is stored, you can press the button and call the number using voice commands.

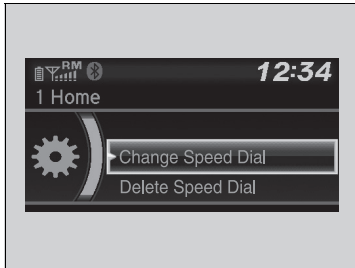

■ To edit a speed dial

1. Press the button or the button.
2. Rotate to select **Phone Setup**, then press .
3. Rotate to select **Speed Dial**, then press .
4. Select an existing speed dial entry.
5. Rotate to select **Change Speed Dial**, then press .
6. Select a new speed dial number, then press .

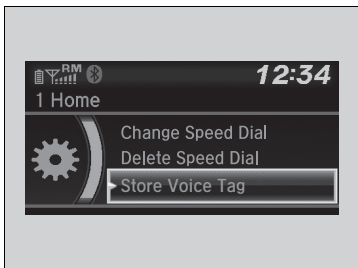

■ **To add a voice tag to a stored speed dial number**

1. Press the button or the button.
2. Rotate to select **Phone Setup**, then press .
3. Rotate to select **Speed Dial**, then press .
4. Select an existing speed dial entry.
5. Rotate to select **Store Voice Tag**, then press .
6. Using the button, follow the prompts to complete the voice tag.

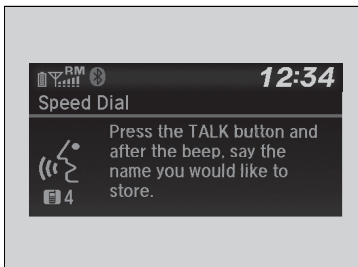

■ **To change a voice tag**

1. Press the button or the button.
2. Rotate to select **Phone Setup**, then press .
3. Rotate to select **Speed Dial**, then press .
4. Select an existing speed dial entry.
5. Rotate to select **Change Voice Tag**, then press .
6. Using the button, follow the prompts to complete the voice tag.

▶▶ Speed Dial

Avoid using duplicate voice tags.
 Avoid using "home" as a voice tag.
 It is easier for HFL to recognize a longer name. For example, use "John Smith" instead of "John."

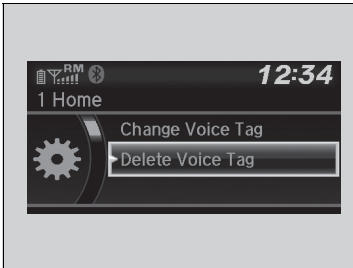

■ To delete a voice tag

1. Press the button or the button.
2. Rotate to select **Phone Setup**, then press .
3. Rotate to select **Speed Dial**, then press .
4. Select an existing speed dial entry.
5. Rotate to select **Delete Voice Tag**, then press .
 - ▶ A confirmation message appears on the screen. Rotate to select **Yes**, then press .

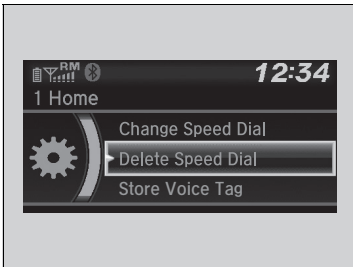

■ To delete a speed dial number

1. Press the button or the button.
2. Rotate to select **Phone Setup**, then press .
3. Rotate to select **Speed Dial**, then press .
4. Select an existing speed dial entry.
5. Rotate to select **Delete Speed Dial**, then press .
 - ▶ A confirmation message appears on the screen. Rotate to select **Yes**, then press .

■ Making a Call

You can make calls by inputting any phone number, or by using the imported phonebook, call history, speed dial entries, or redial.

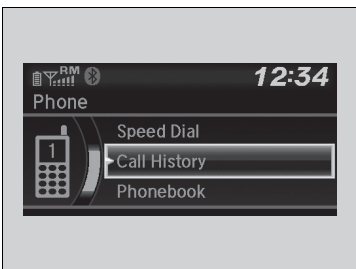

▣ Making a Call

Any voice-tagged speed dial entry can be dialed by voice from any screen.

Press the  button and follow the prompts.

The maximum range between your phone and vehicles is 30 feet (10 meters).

Once a call is connected, you can hear the voice of the person you are calling through the audio speakers.

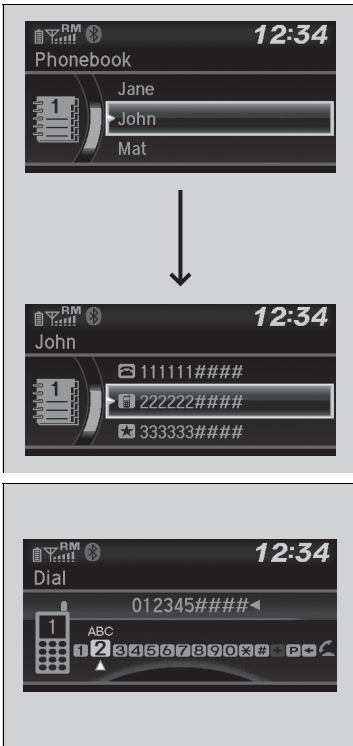

■ **To make a call using the imported phonebook**

When your phone is paired, the contents of its phonebook are automatically imported to HFL.

1. Press the button or the button.
 2. Rotate to select **Phonebook**, then press .
 3. The phonebook is stored alphabetically. Rotate to select the initial, then press .
 4. Rotate to select a name, then press .
 5. Rotate to select a number, then press .
- ▶ Dialing starts automatically.

■ **To make a call using a phone number**

1. Press the button or the button.
 2. Rotate to select **Dial**, then press .
 3. Rotate to select a number, then press .
 4. Rotate to select , then press .
- ▶ Dialing starts automatically.

☒ **To make a call using the imported phonebook**

You can call a stored voice-tagged speed dial number using voice commands.

▶ **Speed Dial** P. 362

☒ **To make a call using a phone number**

You can call a stored voice-tagged speed dial number using voice commands.

▶ **Speed Dial** P. 362

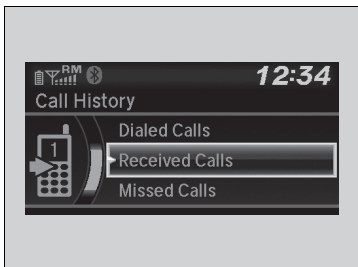

■ To make a call using redial

1. Press the button or the button.
2. Rotate to select **Redial**, then press .
- ▶ Dialing starts automatically.

■ To make a call using the call history

Call history is stored by **Dialed Calls**, **Received Calls**, and **Missed Calls**.

1. Press the button or the button.
2. Rotate to select **Call History**, then press .
3. Rotate to select **Dialed Calls**, **Received Calls**, or **Missed Calls**, then press .
4. Rotate to select a number, then press .
- ▶ Dialing starts automatically.

▶▶ To make a call using redial

Press and hold the button to redial the last number dialed in your phone's call history.

▶▶ To make a call using the call history

The call history appears only when a phone is connected to HFL, and displays the last 20 dialed, received, or missed calls.

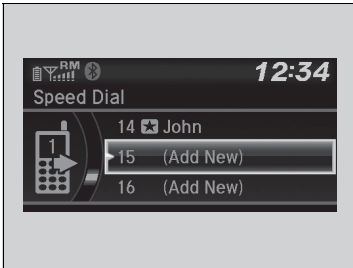

■ **To make a call using a speed dial entry**

1. Press the button or the button.
2. Rotate to select **Speed Dial**, then press .
3. Rotate to select a number, then press .
 - ▶ Dialing starts automatically.

☒ To make a call using a speed dial entry

On the **Phone** screen, the first six speed dials on the list can be directly selected by pressing the corresponding audio preset buttons (1-6).

Select **Others** to view another paired phone's speed dial list.

When a voice tag is stored, press the button and call the number using voice commands.

☒ **Speed Dial** P. 362

Any voice-tagged speed dial entry can be dialed by voice from any screen. Press the button and follow the prompts.

Receiving a Call

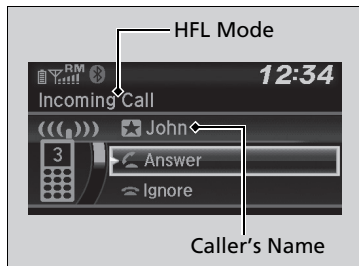

When there is an incoming call, an audible notification sounds and the **Incoming Call** screen appears.

Press the  button to answer the call.

Press the  button to decline or end the call.

Receiving a Call





Call Waiting

Press the  button to put the current call on hold to answer the incoming call.

Press the  button again to return to the current call.

Select **Ignore** to ignore the incoming call if you do not want to answer it.

Press the  button if you want to hang up the current call.

You can select the icons on the audio/information screen instead of the  and  buttons. Rotate  to select the icon, then press .

Options During a Call

The following options are available during a call.



Swap Call: Put the current call on hold to answer the incoming call.

Mute: Mute your voice.

Transfer Call: Transfer a call from HFL to your phone.

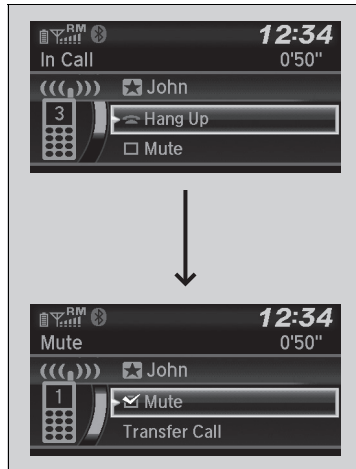
Dial Tones: Send numbers during a call. This is useful when you call a menu-driven phone system.



1. To view the available options, press the  button.
2. Rotate  to select the option, then press .
 - ▶ The check box is checked when **Mute** is selected. Select **Mute** again to turn it off.

Options During a Call

Dial Tones: Available on some phones.

Models with Display Audio

Bluetooth® HandsFreeLink® (HFL) allows you to place and receive phone calls using your vehicle's audio system, without handling your cell phone.

Using HFL

HFL Buttons

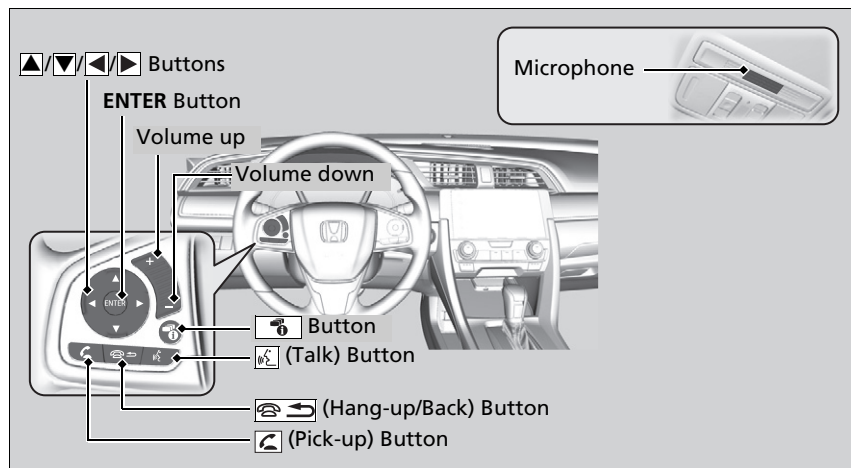

Bluetooth® HandsFreeLink®

Place your phone where you can get good reception.

To use HFL, you need a *Bluetooth*-compatible cell phone. For a list of compatible phones, pairing procedures, and special feature capabilities:

- U.S.: Visit automobiles.honda.com/handsfreelink/, or call 1-888-528-7876.
- Canada: For more information on smartphone compatibility, call 1-888-528-7876.

To use the system, the **Bluetooth On/Off Status** setting must be **On**. If there is an active connection to Apple CarPlay, HFL is unavailable.

➤ **How to customize** P. 323

Voice control tips

- Aim the vents away from the ceiling and close the windows, as noise coming from them may interfere with the microphone.
- Press the  button when you want to call a number using a stored voice tag. Speak clearly and naturally after a beep.
- If the microphone picks up voices other than yours, the command may be misinterpreted.
- To change the volume level, select the audio system's **VOL** (Volume) or use the remote audio controls on the steering wheel.

Up to five speed dial entries can be displayed among a total of 20 that can be entered.

➤ **Speed Dial** P. 386

Up to five previous calls can be displayed at a time among a total of 20 that can be entered. If there is no call history, Call History is disabled.

 **(Pick-up) button:** Press to go directly to the phone menu on the driver information interface, or to answer an incoming call.

 **(Hang-up/back) button:** Press to end a call, go back to the previous command, or cancel a command.



 **(Talk) button:** Press to access Voice Portal.

 **▲/▼ buttons:** Press to select an item displayed on the phone menu in the driver information interface.

ENTER button: Press to call a number listed in the selected item on the phone menu in the driver information interface.

 **button:** Select and press **ENTER** to display **Speed Dial, Call History, or Phonebook** on the phone menu in the driver information interface.

To go to the **Phone menu** screen:

1. Select .
2. Select **Phone** to switch the display to the phone screen.
3. Select .

Bluetooth® HandsFreeLink®

Bluetooth® Wireless Technology

The *Bluetooth®* word mark and logos are registered trademarks owned by *Bluetooth SIG, Inc.*, and any use of such marks by Honda Motor Co., Ltd., is under license. Other trademarks and trade names are those of their respective owners.

HFL Limitations

An incoming call on HFL will interrupt the audio system when it is playing. It will resume when the call is ended.

■ HFL Status Display

The audio/information screen notifies you when there is an incoming call.

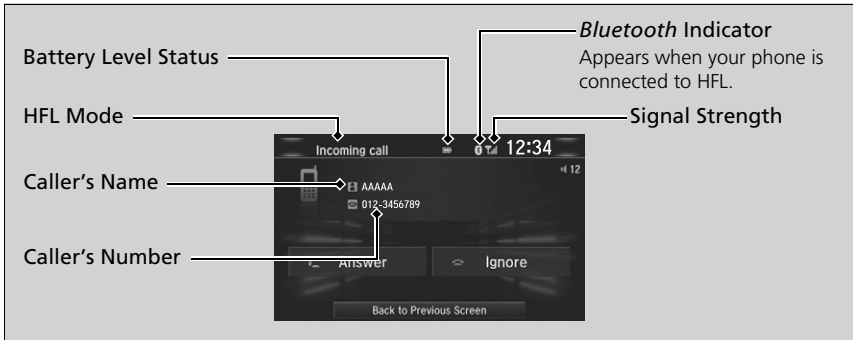

■ Limitations for Manual Operation

Certain manual functions are disabled or inoperable while the vehicle is in motion. You cannot select a grayed-out option until the vehicle is stopped.

Only previously stored speed dial entries with voice tags, phonebook names, or numbers can be called using voice commands while the vehicle is in motion.

▶ **Speed Dial** P. 386

▶ HFL Status Display

The information that appears on the audio/information screen varies between phone models.

You can change the system language.

▶ **How to customize** P. 323

HFL Menu

The ignition switch must be in ACCESSORY  or ON *1 to use HFL.

■ Phone settings screen



1. Select .
2. Select **Settings**.
3. Select **Phone**.

▶▶ HFL Menu

To use HFL, you must first pair your *Bluetooth*-compatible cell phone to the system while the vehicle is parked.

Some functions are limited while driving.

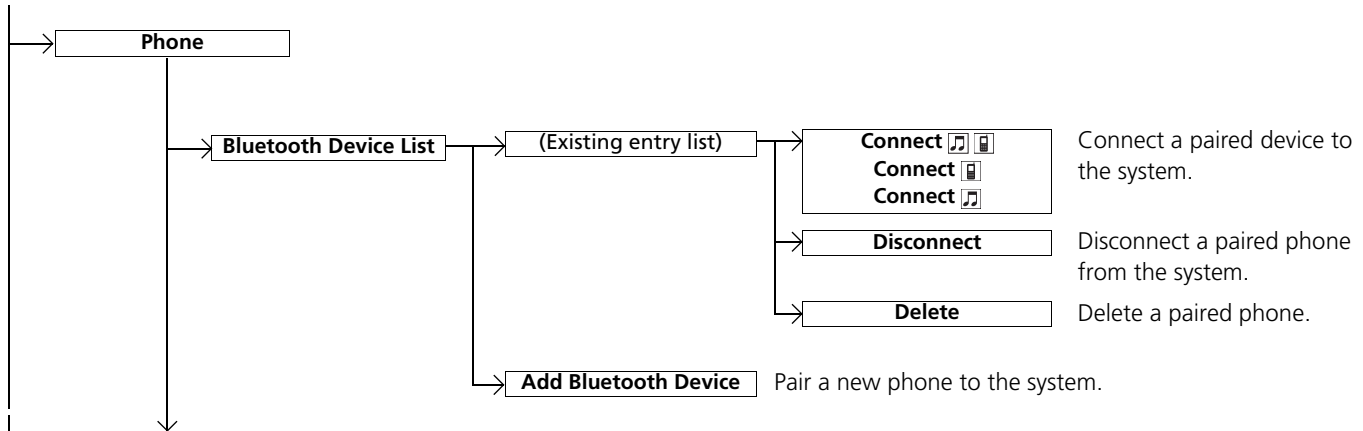

*1: Models with the smart entry system have an **ENGINE START/STOP** button instead of an ignition switch.

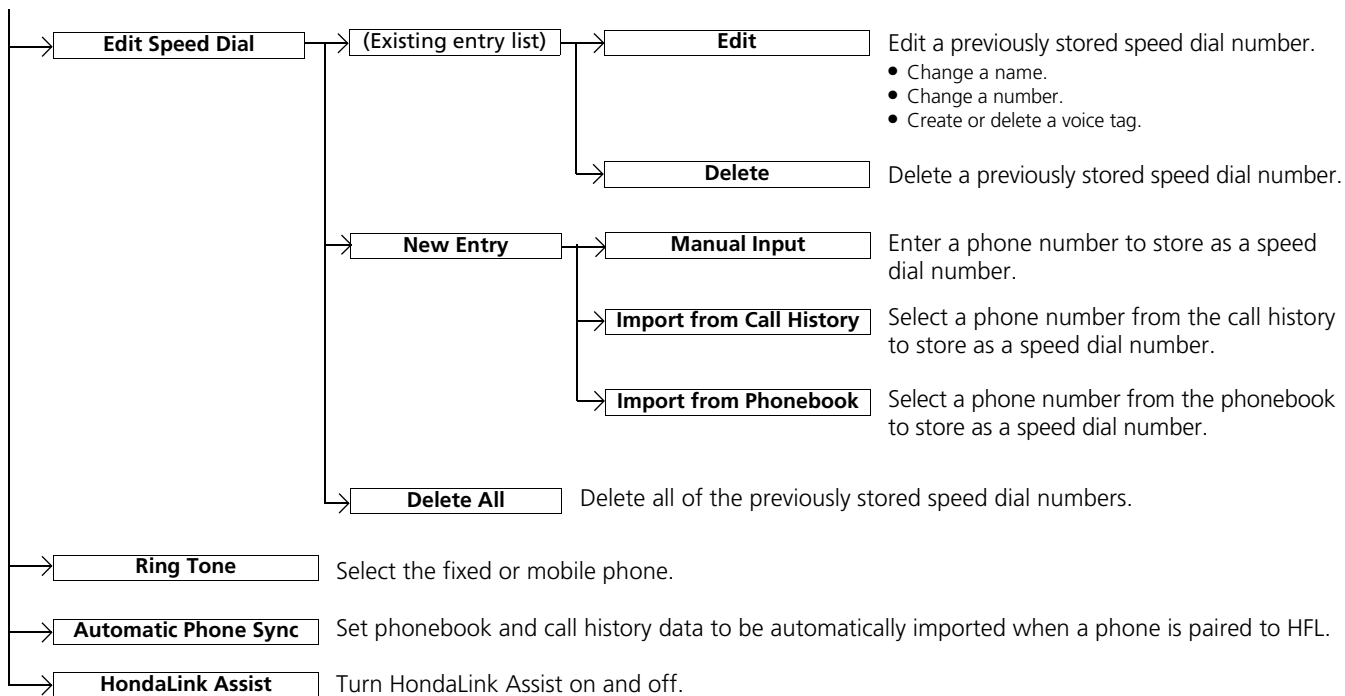

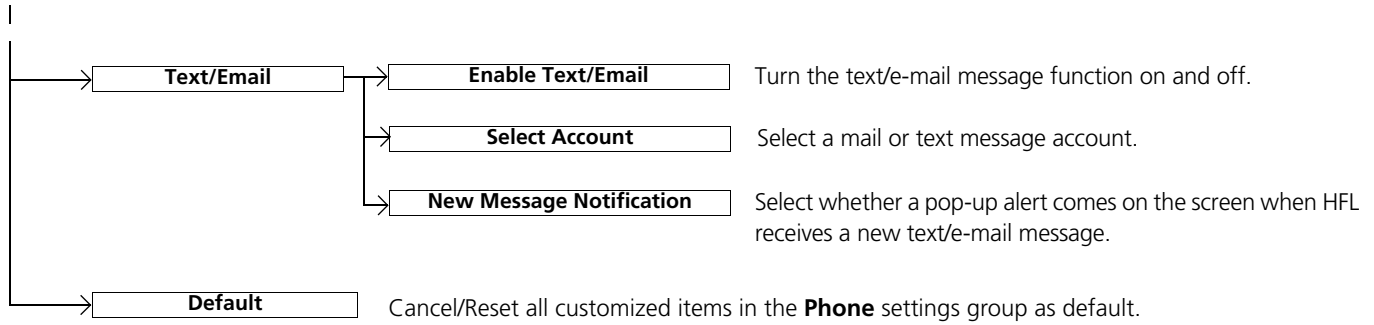

■ Phone menu screen

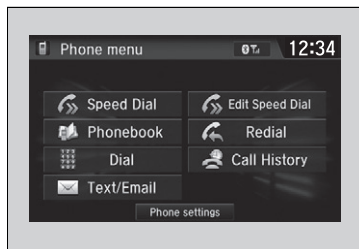

1. Select .
2. Select **Phone**.
3. Select .

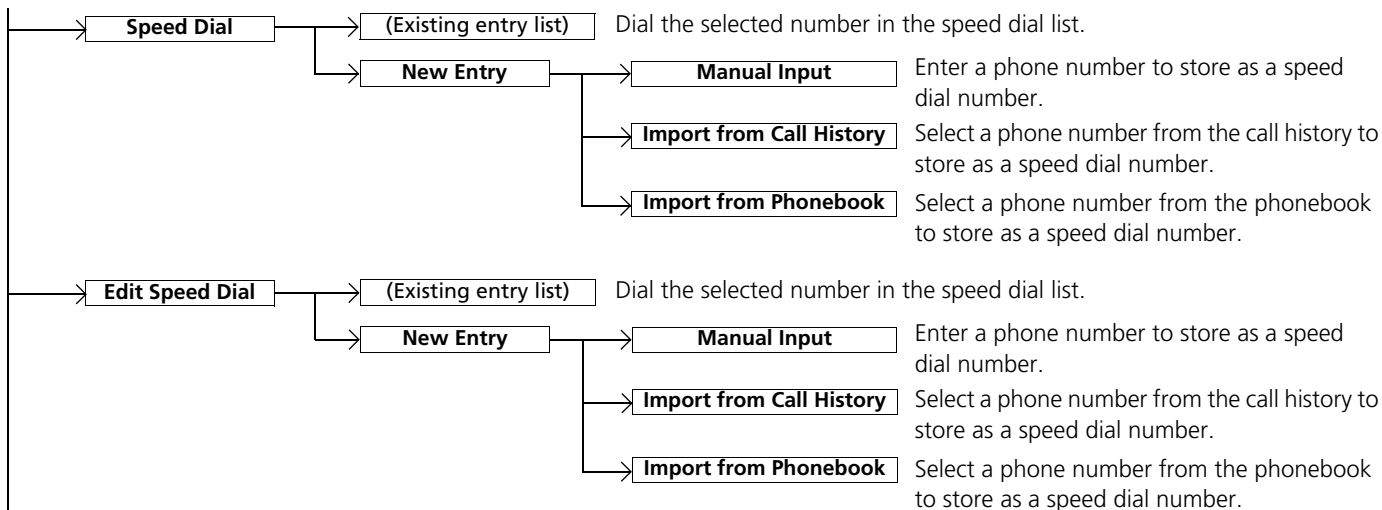

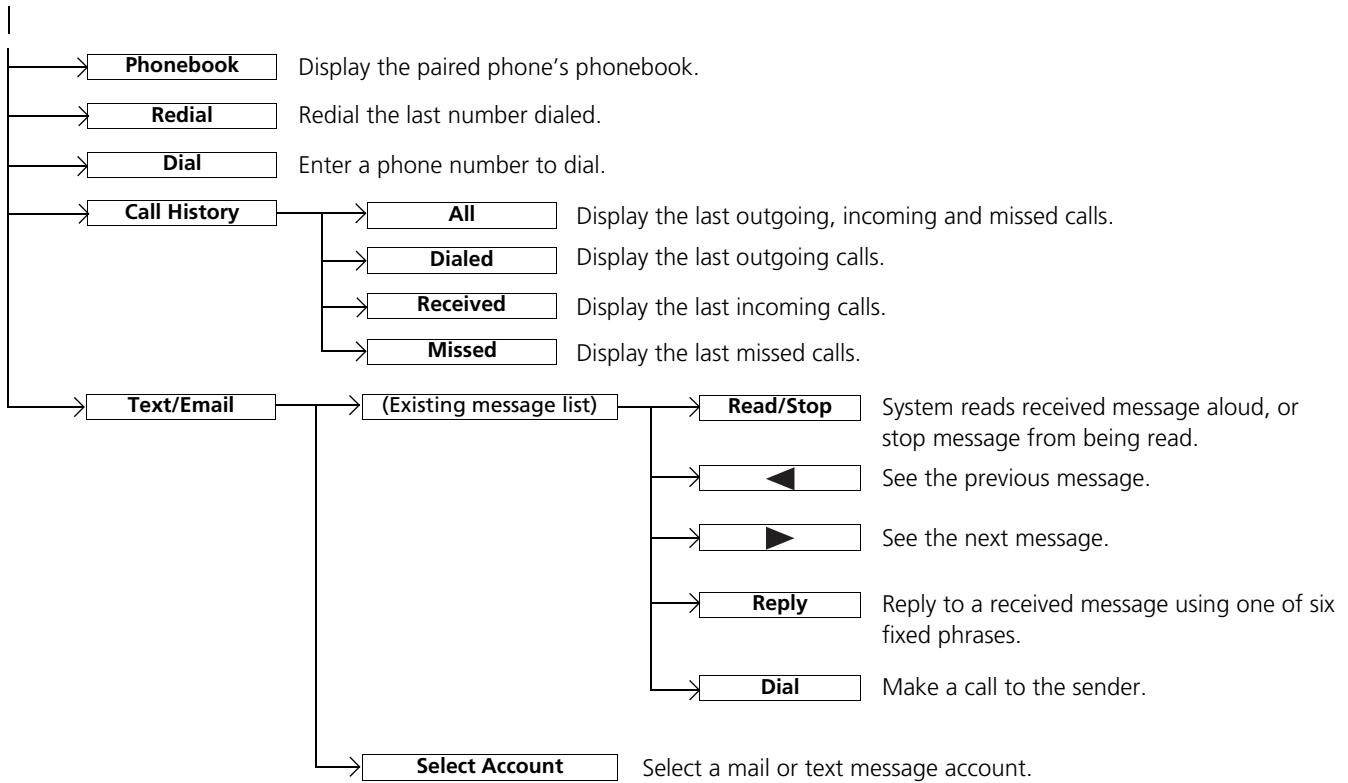

Phone Setup



■ To pair a cell phone (when there is no phone paired to the system)

1. Select **Phone**.
2. Select **Yes**.
3. Make sure your phone is in search or discoverable mode, then select **Continue**.
 - ▶ HFL automatically searches for a *Bluetooth*® device.
4. Select your phone when it appears on the list.
 - ▶ If your phone does not appear, you can select **Refresh** to search again.
 - ▶ If your phone still does not appear, select **Phone Not Found** and search for *Bluetooth*® devices using your phone. From your phone, search for **HandsFreeLink**.
5. The system gives you a pairing code on the audio/information screen.
 - ▶ Confirm if the pairing code on the screen and your phone match. This may vary by phone.

Phone Setup

Your *Bluetooth*-compatible phone must be paired to the system before you can make and receive hands-free calls.

Phone Pairing Tips:

- You cannot pair your phone while the vehicle is moving.
- Up to six phones can be paired.
- Your phone's battery may drain faster when it is paired to the system.
- If your phone is not ready for pairing or not found by the system within three minutes, the system will time out and return to idle.

Once you have paired a phone, you can see it displayed on the screen with one or two icons on the right side.



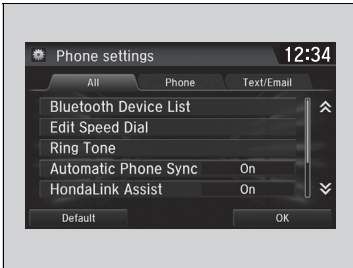

These icons indicate the following:

- : The phone can be used with HFL.
- : The phone is compatible with *Bluetooth*® Audio.

If there is an active connection to Apple CarPlay, pairing of additional *Bluetooth*-compatible devices is unavailable and **Add Bluetooth Device** is grayed out from the **Bluetooth Device List** screen.



■ **To change the currently paired phone**

1. Go to the phone settings screen.
 - ▶ **Phone settings screen** P. 375
2. Select **Bluetooth Device List**.
3. Select a phone to connect.
 - ▶ HFL disconnects the connected phone and starts searching for another paired phone.
4. Select **Connect**  , **Connect** , or **Connect** .

■ **To change the pairing code setting**

1. Select .
 2. Select **Settings**.
 3. Select **Bluetooth/Wi-Fi**.
 4. Select the **Bluetooth** tab.
 5. Select **Edit Pairing Code**.
6. Select **Random** or **Fixed**.

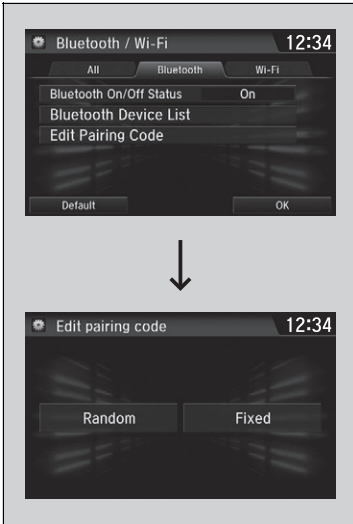

▶▶ To change the currently paired phone

If no other phones are found or paired when trying to switch to another phone, HFL will inform you that the original phone is connected again.

To pair other phones, select **Add Bluetooth Device** from the **Bluetooth device list** screen.

▶▶ To change the pairing code setting

The default pairing code is **0000** until you change the setting.

To create your own, select **Fixed**, and delete the current code, then enter a new one.

For a randomly generated pairing code each time you pair a phone, select **Random**.

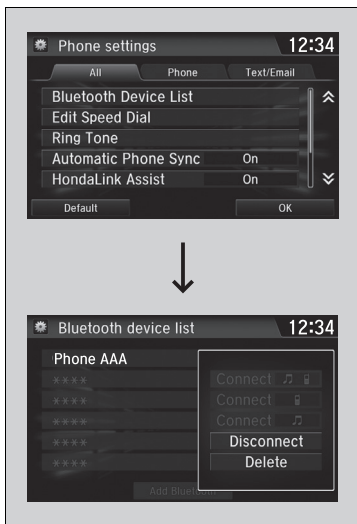

■ **To delete a paired phone**

1. Go to the phone settings screen.
 - ▶ **Phone settings screen** P. 375
2. Select **Bluetooth Device List**.
3. Select a phone you want to delete.
4. Select **Delete**.
5. A confirmation message appears on the screen. Select **Yes**.

To Set Up Text/E-mail Message Options

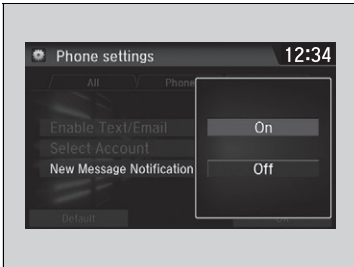
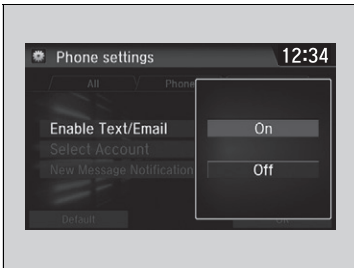

■ To turn on or off the text/e-mail function

1. Go to the phone settings screen.
 - ▶ Phone settings screen P. 375
2. Select the **Text/Email** tab, then **Enable Text/Email**.
 - ▶ A pop-up menu appears on the screen.
3. Select **On** or **Off**.

■ To turn on or off the text/e-mail notice

1. Go to the phone settings screen.
 - ▶ Phone settings screen P. 375
2. Select the **Text/Email** tab, then **New Message Notification**.
 - ▶ A pop-up menu appears on the screen.
3. Select **On** or **Off**.

☒ To Set Up Text/E-mail Message Options

To use the text/e-mail message function, it may be necessary to set up on your phone.

☒ To turn on or off the text/e-mail notice

On: A pop-up notification comes on every time you receive a new message.
Off: The message you receive is stored in the system without notification.

■ Ring Tone

You can change the ring tone setting.

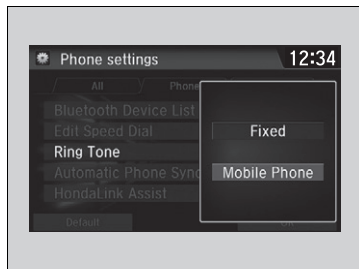

1. Go to the phone settings screen.
 - ▶ **Phone settings screen** P. 375
2. Select **Ring Tone**.
3. Select **Fixed** or **Mobile Phone**.

☒ Ring Tone

Fixed: The fixed ring tone sounds from the speakers.

Mobile Phone: For certain connected phones, the ring tone stored in the phone sounds from the speakers.

Automatic Import of Cellular Phonebook and Call History

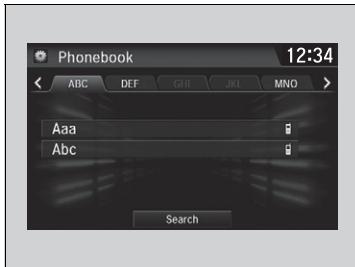

■ When Automatic Phone Sync is set to On:

When your phone is paired, the contents of its phonebook and call history are automatically imported to the system.

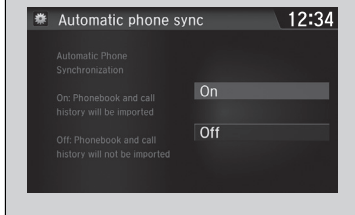
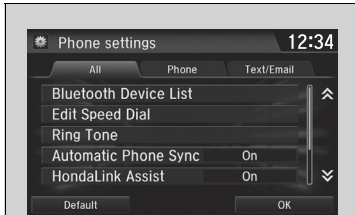

■ Changing the Automatic Phone Sync setting

1. Go to the phone settings screen.
 ▶ **Phone settings screen** P. 375
2. Select **Automatic Phone Sync**.
3. Select **On** or **Off**.

⌘ Automatic Import of Cellular Phonebook and Call History

When you select a name from the list in the cellular phonebook, you can see up to three category icons. The icons indicate what types of numbers are stored for that name.

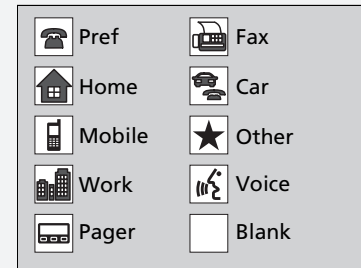

On some phones, it may not be possible to import the category icons to the system.

The phonebook is updated after every connection. Call history is updated after every connection or call.

■ Speed Dial

Up to 20 speed dial numbers can be stored per phone.

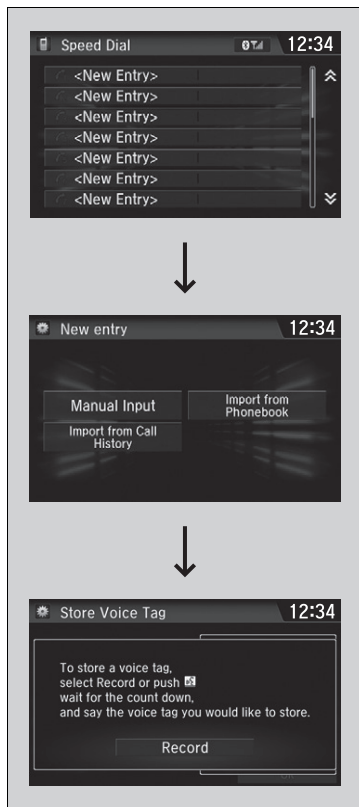

To store a speed dial number:

1. Go to the **Phone menu** screen.
 - ▶ **Phone menu screen** P. 378
2. Select **Speed Dial**.
3. Select **New Entry**.
 - From **Import from Call History**:
 - ▶ Select a number from the call history.
 - From **Manual Input**:
 - ▶ Input the number manually.
 - From **Import from Phonebook**:
 - ▶ Select a number from the connected cell phone's imported phonebook.
4. When the speed dial is successfully stored, you are asked to create a voice tag for the number. Select **Yes** or **No**.
5. Select **Record**, or use the  button and follow the prompts to complete the voice tag.

▶▶ Speed Dial

When a voice tag is stored, press the  button to call the number using the voice tag. Say the voice tag name.

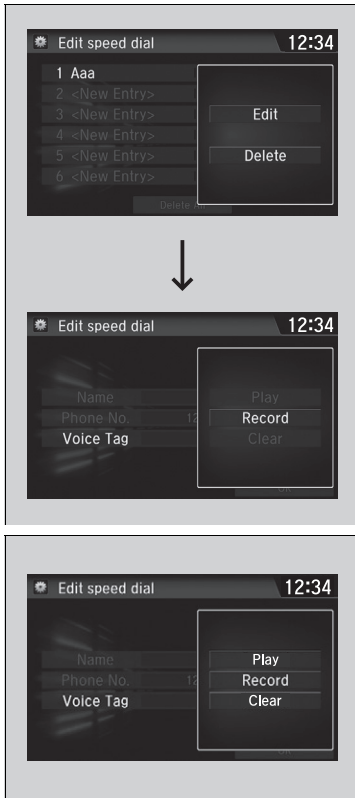

■ **To add a voice tag to a stored speed dial number**

1. Go to the phone settings screen.
 ▶ **Phone settings screen** P. 375
2. Select **Edit Speed Dial**.
3. Select an existing speed dial entry.
 ▶ From the pop-up menu, select **Edit**.
4. Select **Voice Tag**.
 ▶ From the pop-up menu, select **Record**.
5. Select **Record**, or use the  button and follow the prompts to complete the voice tag.

■ **To delete a voice tag**

1. Go to the phone settings screen.
 ▶ **Phone settings screen** P. 375
2. Select **Edit Speed Dial**.
3. Select an existing speed dial entry.
 ▶ From the pop-up menu, select **Edit**.
4. Select **Voice Tag**.
 ▶ From the pop-up menu, select **Clear**.
5. A confirmation message appears on the screen. Select **Yes**.

☞ Speed Dial

Avoid using duplicate voice tags.
 Avoid using "home" as a voice tag.
 It is easier for the system to recognize a longer name.
 For example, use "John Smith" instead of "John."

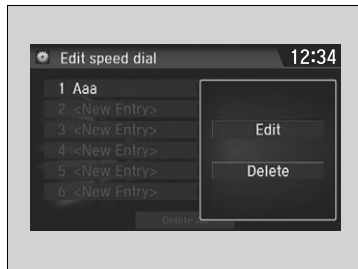

■ To edit a speed dial

1. Go to the phone settings screen.
 - ▶ **Phone settings screen** P. 375
2. Select **Edit Speed Dial**.
3. Select an existing speed dial entry.
 - ▶ From the pop-up menu, select **Edit**.
4. Select a setting you want.

■ To delete a speed dial

1. Go to the phone settings screen.
 - ▶ **Phone settings screen** P. 375
2. Select **Edit Speed Dial**.
3. Select an existing speed dial entry.
 - ▶ From the pop-up menu, select **Delete**.
4. A confirmation message appears on the screen. Select **Yes**.

Phonebook Phonetic Modification

Add phonetic modifications or a new voice tag to the phone's contact name so that it is easier for HFL to recognize voice commands.

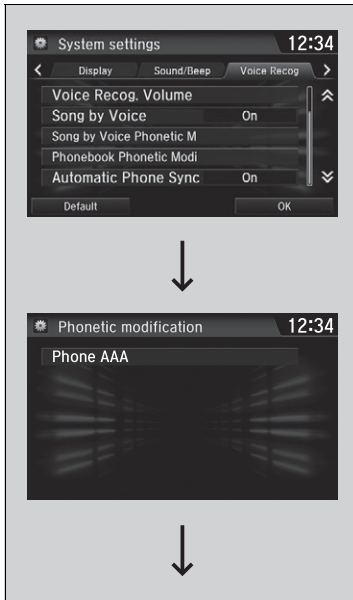

■ To add a new voice tag

1. Select .
2. Select **Settings**.
3. Select **System**.
4. Select the **Voice Recog** tab.
5. Select **Phonebook Phonetic Modification**.
6. Select the phone you want to add phonetic modification to.

☒ Phonebook Phonetic Modification

You can store up to 20 phonetic modification items.



7. Select **New Voice Tag**.

8. Select a contact name you want to add to.

▶ The pop-up menu appears on the screen.



9. Select **Modify**.

10. Using **Record** or the  button, follow the prompts to complete the voice tag.

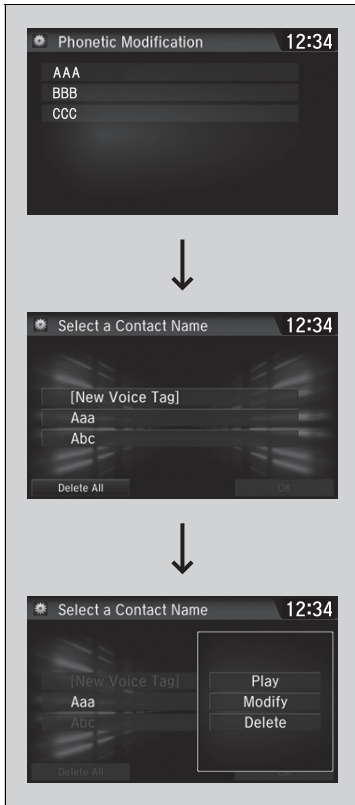
11. You will receive a confirmation message on the screen, then select **OK**.



■ **To modify a voice tag**

1. Select .
2. Select **Settings**.
3. Select **System**.
4. Select the **Voice Recog** tab.
5. Select **Phonebook Phonetic Modification**.
6. Select the phone you want to modify phonetic modification.
7. Select a contact name you want to modify.
 - ▶ The pop-up menu appears on the screen.
8. Select **Modify**.
9. Using **Record** or the  button, follow the prompts to complete the voice tag.
10. You will receive a confirmation message on the screen, then select **OK**.

☒ Phonebook Phonetic Modification

You can only modify or delete contact names for the currently connected phone.



■ **To delete a modified voice tag**

1. Select .
2. Select **Settings**.
3. Select **System**.
4. Select the **Voice Recog** tab.
5. Select **Phonebook Phonetic Modification**.
6. Select the phone you want to delete phonetic modification.
7. Select a contact name you want to delete.
 - ▶ The pop-up menu appears on the screen.
8. Select **Delete**.
 - ▶ The selected contact name has been selected.
9. Select **OK**.

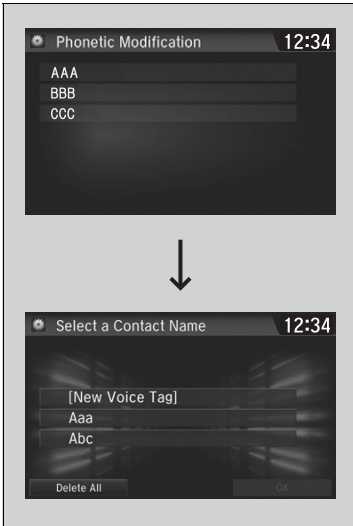

■ To delete all modified voice tags

1. Select .
2. Select **Settings**.
3. Select **System**.
4. Select the **Voice Recog** tab.
5. Select **Phonebook Phonetic Modification**.
6. Select the phone you want to delete phonetic modification.
 - ▶ The contact name list appears.
7. Select **Delete All**.
8. You will receive a confirmation message on the screen, then select **Yes**.

■ Making a Call

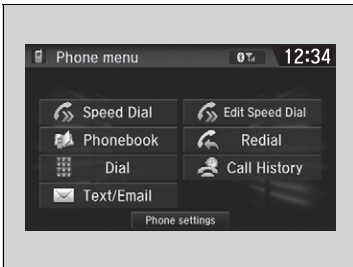

You can make calls by inputting any phone number, or by using the imported phonebook, call history, speed dial entries, or redial.

☒ Making a Call

Any voice-tagged speed dial entry can be dialed by voice from most screens.

Press the  button and say the voice tag name.

Once a call is connected, you can hear the voice of the person you are calling through the audio speakers.

While there is an active connection with Apple CarPlay, phone calls cannot be made with HandsFreeLink® and are only made from Apple CarPlay.

Continued

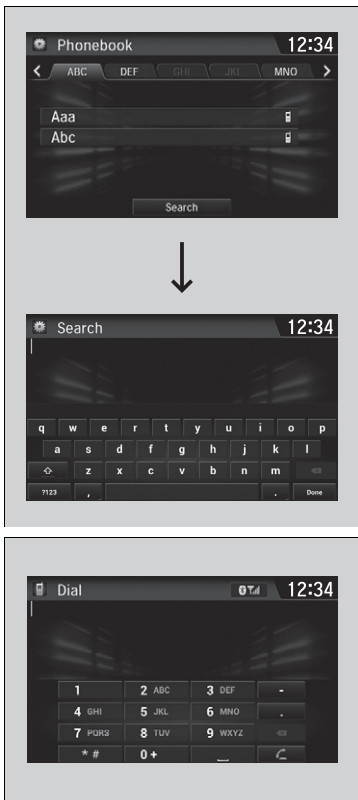

■ **To make a call using the imported phonebook**

1. Go to the **Phone menu** screen.
 - ▶ **Phone menu screen** P. 378
2. Select **Phonebook**.
3. Select a name.
 - ▶ You can also search by letter. Select **Search**.
 - ▶ Use the keyboard on the touch screen for entering name, if multiple numbers exist select a number.
4. Select a number.
 - ▶ Dialing starts automatically.

■ **To make a call using a phone number**

1. Go to the **Phone menu** screen.
 - ▶ **Phone menu screen** P. 378
2. Select **Dial**.
3. Select a number.
 - ▶ Use the keyboard on the touch screen for entering numbers.
4. Select .
 - ▶ Dialing starts automatically.

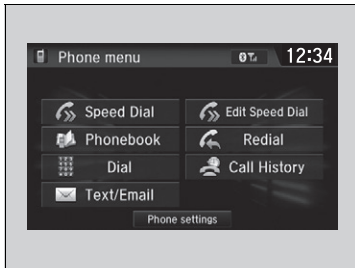

■ **To make a call using redial**

1. Go to the **Phone menu** screen.
 ▶ **Phone menu screen** P. 378
2. Select **Redial**.
 ▶ Dialing starts automatically.

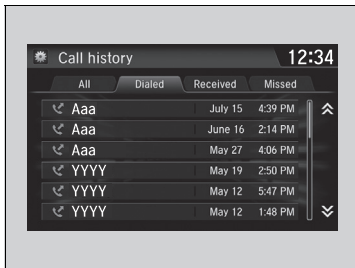

■ **To make a call using the Call History**

Call history is stored by **All, Dialed, Received, and Missed**.

1. Go to the **Phone menu** screen.
 ▶ **Phone menu screen** P. 378
2. Select **Call History**.
3. Select **All, Dialed, Received, or Missed**.
4. Select a number.
 ▶ Dialing starts automatically.



■ **To make a call using a Speed Dial entry**

1. Go to the **Phone menu** screen.
 ▶ **Phone menu screen** P. 378
2. Select **Speed Dial**.
3. Select a number.
 ▶ Dialing starts automatically.

☒ **To make a call using the Call History**

The call history displays the last 20 all, dialed, received, or missed calls.
 (Appears only when a phone is connected to the system.)

☒ **To make a call using a Speed Dial entry**

When a voice tag is stored, press the  button to call the number using the voice tag.

▶ **Speed Dial** P. 386



Any voice-tagged speed dial entry can be dialed by voice from any screen.

Press the  button and follow the prompts.

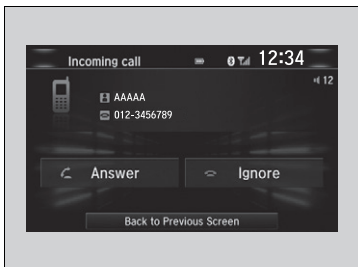
Receiving a Call



When there is an incoming call, an audible notification sounds (if activated) and the **Incoming call** screen appears.

Press the  button to answer the call.
 Press the  button to decline or end the call.

Options During a Call

The following options are available during a call.

Mute: Mute your voice.

Transfer: Transfer a call from the system to your phone.

Touch Tones: Send numbers during a call. This is useful when you call a menu-driven phone system.

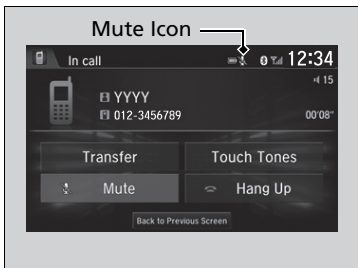

The available options are shown on the lower half of the screen.

Select the option.

- ▶ The mute icon appears when **Mute** is selected. Select **Mute** again to turn it off.

Receiving a Call



Call Waiting

Press the  button to put the current call on hold to answer the incoming call.

Press the  button again to return to the current call.

Select **Ignore** to ignore the incoming call if you do not want to answer it.

Press the  button if you want to hang up the current call.

You can select the icons on the audio/information screen instead of the  and  buttons.

Options During a Call

Touch Tones: Available on some phones.

You can select the icons on the audio/information screen.

Receiving a Text/E-mail Message

HFL can display newly received text or e-mail messages as well as 20 of the most recently received messages on a linked cell phone. Each received message can be read aloud and replied to using a fixed common phrase.



1. A pop-up appears and notifies you of a new text or e-mail message.
2. Select **Read** to listen to the message.
 - ▶ The text or e-mail message is displayed. The system automatically starts reading out the message.
3. To discontinue the message read-out, select **Stop**.

Receiving a Text/E-mail Message

The system does not display any received messages while you are driving. You can only hear them read aloud.

The system can only receive messages that are sent a text (SMS) messages. The message sent using the data services will not be displayed in the list.

With some phones, you may be able to display up to 20 most recent text and e-mail messages.

State or local laws may limit your use of the HFL text/e-mail message feature. Only use the text/e-mail message feature when conditions allow you to do so safely.

When you receive a text or e-mail message for the first time since the phone is paired to HFL, you are asked to turn the **New Message Notification** setting to **On**.

- ▶ **To turn on or off the text/e-mail notice**
P. 383

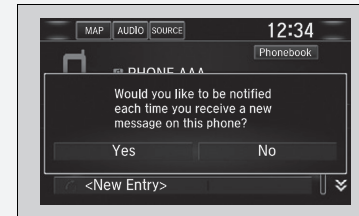

Continued

■ Selecting a Mail Account

If a paired phone has text or mail message accounts, you can select one of them to be active and receive notifications.

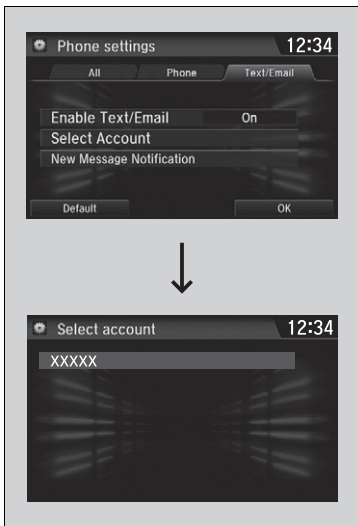

1. Go to the phone settings screen.
 ▶ **Phone settings screen** P. 375
2. Select the **Text/Email** tab, then **Select Account**.
 ▶ A pop-up menu appears on the screen.
3. Select **Text Messages** or an e-mail account you want.

▶▶ Selecting a Mail Account

You can also select a mail account from the folder list screen or the message list screen.

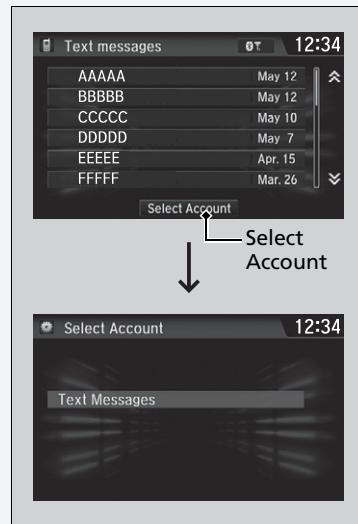

You can only receive notifications from one text or mail message account at a time.

Displaying Messages

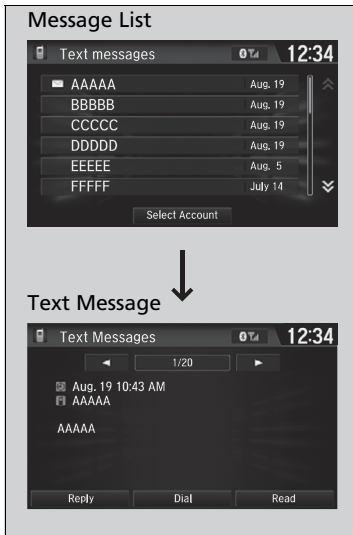

■ Displaying text messages

1. Go to the **Phone menu** screen.
 ▶ **Phone menu screen** P. 378
2. Select **Text/Email**.
 ▶ Select account if necessary.
3. Select a message.
 ▶ The text message is displayed. The system automatically starts reading the message aloud.

☒ Displaying Messages

The ☒ icon appears next to an unread message.

If you delete a message on the phone, the message is also deleted in the system. If you send a message from the system, the message goes to your phone's mailbox.

To see the previous or next message, select ☐ (previous) or ☐ (next) on the message screen.

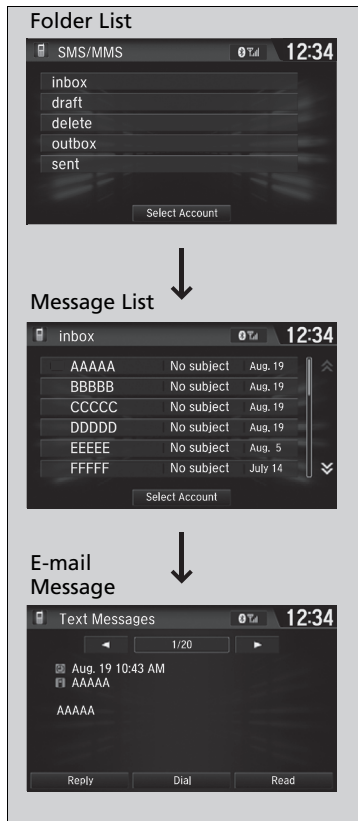

■ Displaying e-mail messages

1. Go to the **Phone menu** screen.
 - ▶ **Phone menu screen** P. 378
2. Select **Text/Email**.
 - ▶ Select **Select Account** if necessary.
3. Select a folder.
4. Select a message.
 - ▶ The e-mail message is displayed. The system automatically starts reading the message aloud.

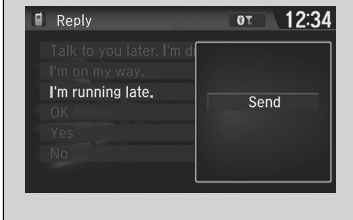
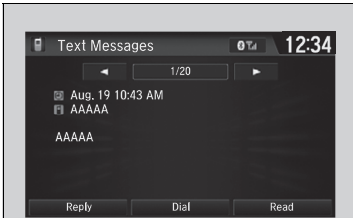
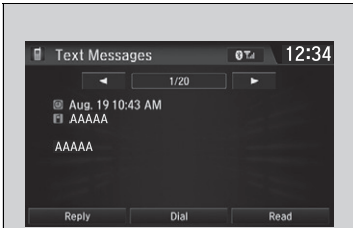

■ Read or Stop reading a message

1. Go to the text or e-mail message screen.
 - ▶ The system automatically starts reading the message aloud.
 - ▣ **Displaying Messages** P. 399
2. Select **Stop** to stop reading.
 - Select **Read** again to start reading the message from the beginning.

■ Reply to a message

1. Go to the text or e-mail message screen.
 - ▶ The system automatically starts reading the message aloud.
 - ▣ **Displaying Messages** P. 399
2. Select **Reply**.
3. Select the reply message.
 - ▶ The pop-up menu appears on the screen.
4. Select **Send** to send the message.
 - ▶ **Complete** appears on the screen when the reply message was successfully sent.

▣ Reply to a message

The available fixed reply messages are as follows:

- **Talk to you later, I'm driving.**
- **I'm on my way.**
- **I'm running late.**
- **OK**
- **Yes**
- **No**

You cannot add, edit, or delete reply messages.

Only certain phones receive and send messages when paired and connected. For a list of compatible phones:

- U.S.: Visit automobiles.honda.com/handsfreelink/, or call 1-888-528-7876.
- Canada: For more information on smartphone compatibility, call 1-888-528-7876.

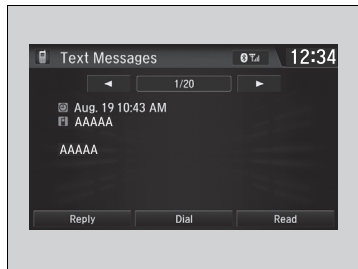

■ **Making a call to a sender**

1. Go to the text message screen.
2. Select **Dial**.

In Case of Emergency

Automatic collision notification

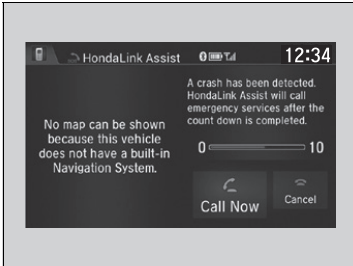

If your vehicle's airbags deploy or if the unit detects that the vehicle is severely impacted, your vehicle automatically will attempt to connect to the HondaLink operator. If connected, information about your vehicle, its location, and its condition can be sent to the operator*1; you also can speak to the operator when connected.

IMPORTANT: For vehicles equipped with HondaLink Assist, owner activation constitutes authorization for Honda to collect information from your vehicle needed to provide the service, and agreement to the Terms of Use at www.hondalink.com/termsAndConditions. In a crash, HondaLink Assist will attempt to notify emergency services but NEITHER Honda-PRO NOR ITS SERVICE PROVIDERS GUARANTEE THAT SUCH NOTIFICATION WILL OCCUR.

Honda reserves the right to terminate HondaLink Assist services at any time or for any reason, and in the future may not be able to provide services due to changes in, or obsolescence of, technology integral to the service or changes in governmental regulation.

*1: Depending on your phone and adequate cellular coverage, your vehicle's location may not be sent to the operator.

In Case of Emergency

Your vehicle may not be able to connect to the operator if the battery level is low, the line is disconnected, or you do not have adequate cellular coverage.

You cannot use this emergency service when:

- You travel outside the HondaLink service coverage areas.
- There is a problem with the connecting devices, such as the microphones, speakers, or the unit itself.

You cannot operate other phone-related functions using the screen while talking to the operator. Select **Hang Up** to terminate the connection to your vehicle.

Automatic collision notification

If the unit fails to connect to the operator, it repeatedly tries until it succeeds.

■ To enable notification

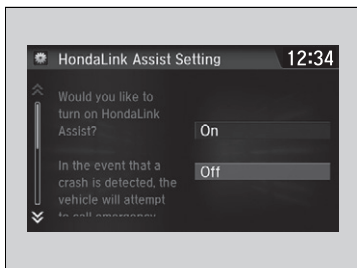

1. Go to the phone settings screen.
 - ▶ **Phone settings screen** P. 375
2. Select the **Phone** tab, then **HondaLink Assist**.
 - ▶ A pop-up menu appears on the screen.
3. Select **On** or **Off**.

☒ To enable notification

Setting options:

- **On:** Notification is available.
- **Off:** Disable the feature.

Driving



This chapter discusses driving and refueling.

Before Driving

Driving Preparation	406
Maximum Load Limit.....	409

Towing a Trailer..... 411

When Driving

Starting the Engine	412, 415
Precautions While Driving.....	420
Continuously Variable Transmission* ...	421
Shifting	422, 424, 428
SPORT Mode*	431
ECON Button*	432
Cruise Control*.....	433
Front Sensor Camera*.....	436

Adaptive Cruise Control (ACC) with Low Speed Follow (LSF)*	438
Road Departure Mitigation (RDM) System*	452
Lane Keeping Assist System (LKAS)*	456
Vehicle Stability Assist (VSA®), aka Electronic Stability Control (ESC), System.....	463
Agile Handling Assist	465
LaneWatch™*	467
Tire Pressure Monitoring System (TPMS)	469
Tire Pressure Monitoring System (TPMS) - Required Federal Explanation	472

Braking

Brake System	474
Anti-lock Brake System (ABS)	480

Brake Assist System	481
Collision Mitigation Braking System™ (CMBS™)*	482

Parking Your Vehicle

When Stopped	490
Multi-View Rear Camera	491

Refueling

Fuel Information	493
How to Refuel	494

Fuel Economy and CO₂ Emissions

Improving Fuel Economy and Reducing CO ₂ Emissions.....	496
---	-----

Turbo Engine Vehicle*

Handling Precautions	497
----------------------------	-----

* Not available on all models

Driving Preparation

Check the following items before you start driving.

Exterior Checks

- Make sure there are no obstructions on the windows, door mirrors, exterior lights, or other parts of the vehicle.
 - ▶ Remove any frost, snow, or ice.
 - ▶ Remove any snow on the roof, as this can slip down and obstruct your field of vision while driving. If frozen solid, remove ice once it has softened.
 - ▶ When removing ice from around the wheels, be sure not to damage the wheel or wheel components.
- Make sure the hood is securely closed.
 - ▶ If the hood opens while driving, your front view will be blocked.
- Make sure the tires are in good condition.
 - ▶ Check air pressure, check for damage and excessive wear.
 - ✦ **Checking and Maintaining Tires** P. 539
- Make sure there are no people or objects behind or around the vehicle.
 - ▶ There are blind spots from the inside.

Exterior Checks

NOTICE

When doors are frozen shut, use warm water around the door edges to melt any ice. Do not try to force them open, as this can damage the rubber trim around the doors. When done, wipe dry to avoid further freezing.

Do not pour warm water into the key cylinder. You will be unable to insert the key if the water freezes in the hole.

Heat from the engine and exhaust can ignite flammable materials left under the hood, causing a fire. If you've parked your vehicle for an extended period, inspect and remove any debris that may have collected, such as dried grass and leaves that have fallen or have been carried in for use as a nest by a small animal. Also check under the hood for leftover flammable materials after you or someone else has performed maintenance on your vehicle.

Interior Checks

- Store or secure all items on board properly.
 - ▶ Carrying too much cargo, or improperly storing it, can affect your vehicle's handling, stability, stopping distance, and tires, and make it unsafe.
 - ✎ **Maximum Load Limit** P. 409
- Do not pile items higher than the seat height.
 - ▶ They can block your view and may be thrown forward in the event of sudden braking.
- Do not place anything in the front seat footwells. Make sure to secure the floor mat.
 - ▶ An object or unsecured floor mat can interfere with your brake and accelerator pedal operation while driving.
- If you have any animals on board, do not let them move around in the vehicle.
 - ▶ They may interfere with driving and a crash could occur.
- Securely close and lock both doors and the trunk.
 - ✎ **Locking/Unlocking the Doors from the Inside** P. 138
- Adjust your seating position properly.
 - ▶ Adjust the front head restraint*¹, too.
 - ✎ **Adjusting the Seats** P. 171
 - ✎ **Adjusting the Front Head Restraints** P. 174
- Adjust the mirrors and steering wheel properly for your driving.
 - ▶ Adjust them while sitting in the proper driving position.
 - ✎ **Adjusting the Mirrors** P. 169
 - ✎ **Adjusting the Steering Wheel** P. 168

*1: Models without SPORT mode

Interior Checks

The headlight aim is set by the factory, and does not need to be adjusted. However, if you regularly carry heavy items in the trunk, have the aiming readjusted at a dealer or by a qualified technician.

- Be sure items placed on the floor behind the front seats cannot roll under the seats.
 - ▶ They can interfere with the driver's ability to operate the pedals, the operation of the seats, or the operation of the sensors under the seats.
- Everyone in the vehicle must fasten their seat belt.
 - 📄 **Fastening a Seat Belt** P. 42
- Make sure that the indicators in the instrument panel come on when you start the vehicle, and go off soon after.
 - ▶ Always have a dealer check the vehicle if a problem is indicated.
 - 📄 **Indicators** P. 76

Maximum Load Limit

The maximum load for your vehicle is 850 lbs (385 kg). See the Tire and Loading Information label attached to the driver's doorjamb.

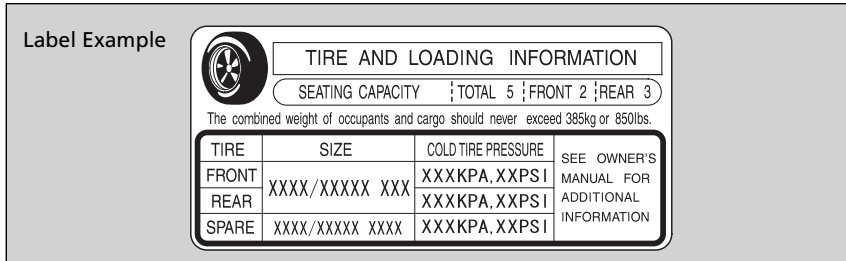

This figure includes the total weight of all occupants, cargo, and accessories, and the tongue load if you are towing a trailer.

Steps for Determining Correct Load Limit -

- (1) Locate the statement "The combined weight of occupants and cargo should never exceed XXX kg or XXX lbs." on your vehicle's placard.
- (2) Determine the combined weight of the driver and passengers that will be riding in your vehicle.
- (3) Subtract the combined weight of the driver and passengers from XXX kg or XXX lbs.
- (4) The resulting figure equals the available amount of cargo and luggage load capacity. For example, if the "XXX" amount equals 1,400 lbs. and there will be five 150 lb. passengers in your vehicle, the amount of available cargo and luggage load capacity is 650 lbs. (1,400 - 750 (5 x 150) = 650 lbs.)

Continued

Maximum Load Limit

⚠ WARNING

Overloading or improper loading can affect handling and stability and cause a crash in which you can be hurt or killed.

Follow all load limits and other loading guidelines in this manual.

Gross Vehicle Weight Rating (GVWR):

The maximum allowable weight of the vehicle, all occupants, all accessories and all cargo.

➤ **Specifications** P. 606, 608

Gross Axle Weight Rating (GAWR):

The maximum allowable weight of the vehicle axle.

➤ **Specifications** P. 606, 608

- (5) Determine the combined weight of luggage and cargo being loaded on the vehicle. That weight may not safely exceed the available cargo and luggage load capacity calculated in step 4.
- (6) If your vehicle will be towing a trailer, load from your trailer will be transferred to your vehicle. Consult this manual to determine how this reduces the available cargo and luggage load capacity of your vehicle.

In addition, the total weight of the vehicle, all occupants, accessories, cargo, and trailer tongue load must not exceed the Gross Vehicle Weight Rating (GVWR) or the Gross Axle Weight Rating (GAWR). Both are on a label on the driver's doorjamb.

Load Limits Example

Example1



Max Load
850 lbs
(385 kg)



Passenger Weight
150 lbs x 2 = 300 lbs
(68 kg x 2 = 136 kg)



Cargo Weight
550 lbs
(249 kg)

Example2



Max Load
850 lbs
(385 kg)



Passenger Weight
150 lbs x 5 = 750 lbs
(68 kg x 5 = 340 kg)



Cargo Weight
100 lbs
(45 kg)

Your vehicle is not designed to tow a trailer. Attempting to do so can void your warranties.

Towing Your Vehicle

Your vehicle is not designed to be towed behind a motor home. If your vehicle needs to be towed in an emergency, refer to the emergency towing information.

📄 **Emergency Towing** P. 601

Models without smart entry system

Starting the Engine



1. Make sure the parking brake is applied.
 - ▶ The parking brake and brake system indicator comes on for 15 seconds when you pull up the electric parking brake switch.

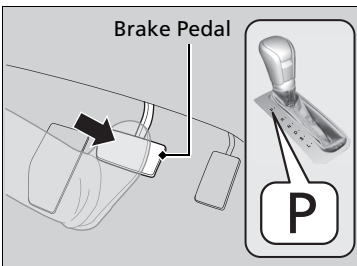

- Continuously variable transmission models**
2. Check that the transmission is in **P**, then depress the brake pedal.
 - ▶ Although it is possible to start the vehicle in **N**, it is safer to start it in **P**.

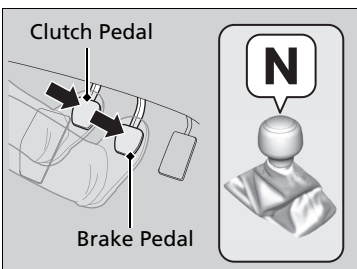

- Manual transmission models**
2. Check that the shift lever is in **N**. Then depress the brake pedal with your right foot, and the clutch pedal with your left foot.
 - ▶ The clutch pedal must be fully depressed to start the engine.

Starting the Engine

Keep your foot firmly on the brake pedal when starting the engine.

The engine is harder to start in cold weather and in thinner air found at altitudes above 8,000 feet (2,400 meters).

When starting the engine in cold weather, turn off all electrical accessories such as the lights, climate control system, and rear defogger in order to reduce battery drain.

If you live in a region where winter is extremely cold, an engine block heater will improve starting and warming of the engine. Consult a dealer for details.

If the exhaust system sounds abnormal or you can smell exhaust gas inside the vehicle, have your vehicle checked by a dealer. There may be a problem with the engine or exhaust system.

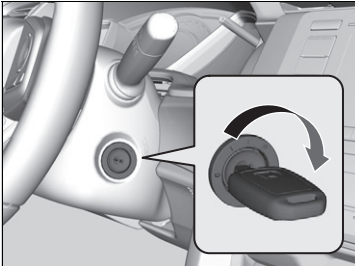



All models

3. Turn the ignition switch to START  without depressing the accelerator pedal.

Starting to Drive

Continuously variable transmission models

1. Keeping your right foot on the brake pedal, put the shift lever in . Select  when reversing.
2. With the parking brake applied, release the brake pedal and gently depress the accelerator pedal.
 - ▶ Make sure the parking brake indicator goes off.
 - **Parking Brake** P. 474

Starting the Engine

Do not hold the key in START  for more than 10 seconds.

- If the engine does not start right away, wait for at least 30 seconds before trying again.
- If the engine starts, but then immediately stops, wait at least 30 seconds before repeating step 3 while gently depressing the accelerator pedal. Release the accelerator pedal once the engine starts.

The immobilizer system protects your vehicle from theft. If an improperly coded device is used, the engine's fuel system is disabled.

➤ **Immobilizer System** P. 148

Starting to Drive

You can also release the parking brake by pressing the electric parking brake switch while depressing the brake pedal.

When facing downhill, you can start your vehicle more smoothly by manually releasing it with the electric parking brake switch than by releasing it with the accelerator pedal.

■ Hill start assist system

Hill start assist keeps the brake engaged briefly to help prevent the vehicle from rolling on inclines as you move your foot from the brake pedal to the accelerator.

Manual transmission models

Depress the clutch pedal, and shift to one of the forward gears when facing uphill, or **R** when facing downhill, then release the brake pedal.

Continuously variable transmission models

Move the shift lever to **D**, **S**, or **L** when facing uphill, or **R** when facing downhill, then release the brake pedal.

⌘ Hill start assist system

Hill start assist may not prevent the vehicle from rolling downhill on a very steep or slippery slope, and does not operate on small inclines.

Hill start assist is not a replacement for the parking brake.

Hill start assist will operate even when VSA® is switched off.

Models with smart entry system

Starting the Engine

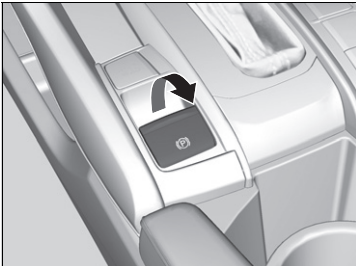

1. Make sure the parking brake is applied.
 - ▶ The parking brake and brake system indicator comes on for 15 seconds when you pull up the electric parking brake switch.

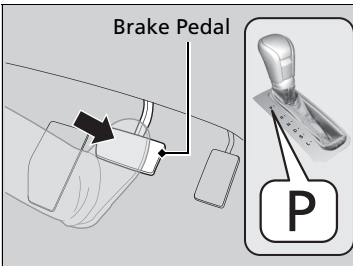

Continuously variable transmission models

2. Check that the transmission is in **P**, then depress the brake pedal.
 - ▶ Although it is possible to start the vehicle in **N**, it is safer to start it in **P**.

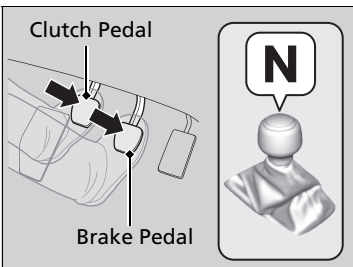

Manual transmission models

2. Check that the shift lever is in **N**. Then depress the brake pedal with your right foot, and the clutch pedal with your left foot.
 - ▶ The clutch pedal must be fully depressed to start the engine.

▶▶ Starting the Engine

Keep your foot firmly on the brake pedal when starting the engine.

The engine is harder to start in cold weather and in thinner air found at altitudes above 8,000 feet (2,400 meters).

When starting the engine in cold weather, turn off all electrical accessories such as the lights, climate control system, and rear defogger in order to reduce battery drain.

If you live in a region where winter is extremely cold, an engine block heater will improve starting and warming of the engine. Consult a dealer for details.

If the exhaust system sounds abnormal or you can smell exhaust gas inside the vehicle, have your vehicle checked by a dealer. There may be a problem with the engine or exhaust system.

The immobilizer system protects your vehicle from theft.

If an improperly coded device is used, the engine's fuel system is disabled.

▶ **Immobilizer System** P. 148

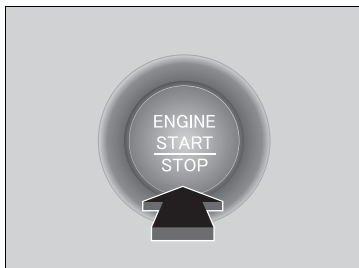

All models

3. Press the **ENGINE START/STOP** button without depressing the accelerator pedal.

Stopping the Engine

You can turn the engine off when the vehicle is completely stopped.

Continuously variable transmission models

1. Put the transmission into **P**.
2. Press the **ENGINE START/STOP** button.

Manual transmission models

- If the transmission is in **N**, press the **ENGINE START/STOP** button.
- If the transmission is in any gear other than **N**, depress the clutch pedal, then press the **ENGINE START/STOP** button.

Starting the Engine

Bring the smart entry remote close to the **ENGINE START/STOP** button if the battery in the smart entry remote is weak.

- ▶ **If the Smart Entry Remote Battery is Weak**
P. 583

The engine may not start if the smart entry remote is subjected to strong radio waves.

Do not hold the **ENGINE START/STOP** button to start the engine.

If the engine does not start, wait at least 30 seconds before trying again.



Remote Engine Start with Vehicle Feedback *

You can remotely start the engine using the  button on the smart entry remote.

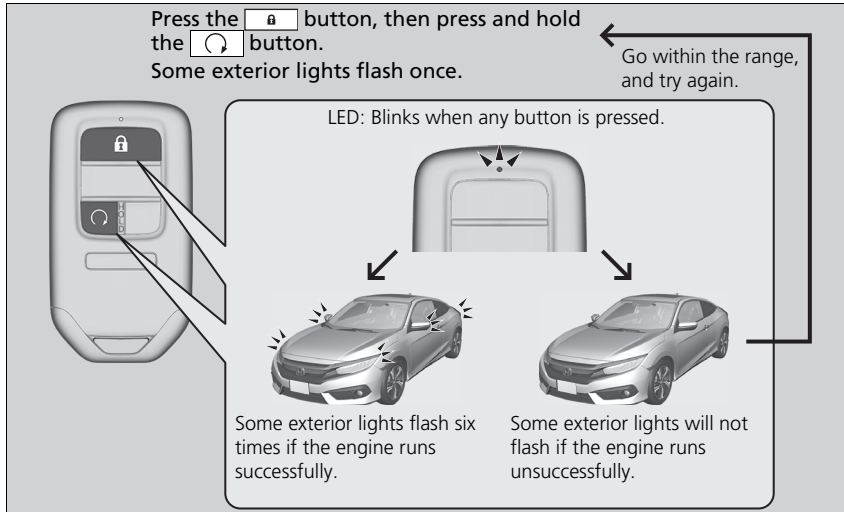
To start the engine



When started remotely, the engine automatically shuts off after 10 minutes of idling and/or the brake pedal and **ENGINE START/STOP** button have not been pressed simultaneously.

To extend the run time for another 10 minutes during the first run, press the  button, then press and hold the  button.

- ▶ Some exterior lights flash six times if a 10-minute extension request was transmitted successfully.

* Not available on all models

Continued

Remote Engine Start with Vehicle Feedback *

WARNING: Carbon monoxide gas is toxic and can rapidly accumulate in closed or even partly enclosed areas.

Breathing it can cause unconsciousness and even kill you.

Never use the remote engine starter with the vehicle parked in a garage or other areas with limited ventilation.

The remote engine start may violate local laws. Before using the remote engine start, check your local laws.

If there are buildings and obstacles between your vehicle and the remote, the range will be reduced. The range may be less when the vehicle is running. This distance may vary by external electrical interference.

The engine may not start by the remote engine start if:

- You have disabled a remote engine start setting using the audio/information screen *.
- The power mode is not in VEHICLE OFF (LOCK).
- The transmission is in a position other than **P**.
- The hood is open, or either door or the trunk is unlocked.

■ To stop the engine

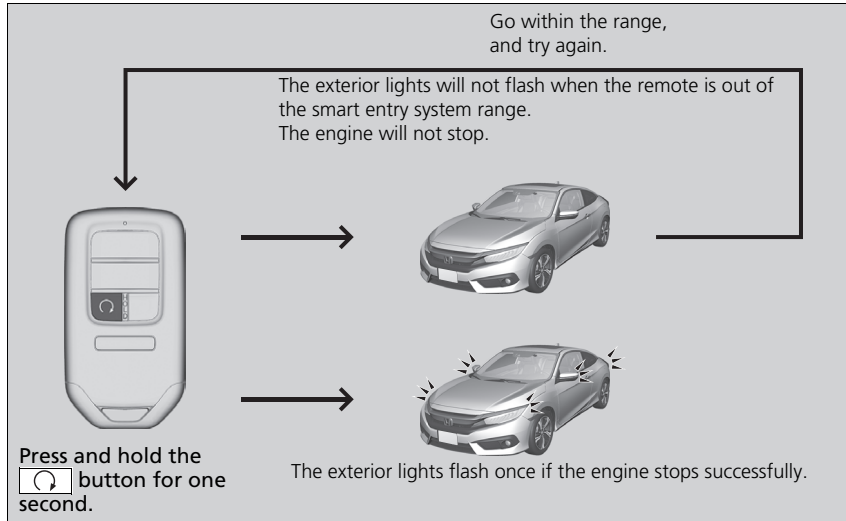

⊠ Remote Engine Start with Vehicle Feedback*

- You have already used the remote twice to start the engine.
- Another registered smart entry remote is in the vehicle.
- There is an antenna failure.
- Door is unlocked with the built-in key.
- The engine oil pressure is low.
- The engine coolant temperature is extremely high.
- The security system alarm is not set.

While the engine is running, the vehicle will automatically activate climate control with a preset temperature of 72°F (22°C).

When it is warm outside:

- The air conditioning is activated in recirculation mode.

When it is cold outside:

- The defroster is activated at a moderately warm temperature.
- The rear defogger, door mirror heaters*, and seat heaters* are activated.

Starting to Drive

Continuously variable transmission models

When the engine was started using the  button on the smart entry remote

1. Depress the brake pedal and press the **ENGINE START/STOP** button simultaneously.

When the engine was started in any case

2. Keeping your right foot on the brake pedal, put the shift lever in **D**. Select **R** when reversing.
3. With the parking brake is applied, release the brake pedal and gently depress the accelerator pedal.
 - ▶ Make sure the parking brake and brake system indicator goes off.
 - **Parking Brake** P. 474

Hill start assist system

Hill start assist keeps the brake engaged briefly to help prevent the vehicle from rolling on inclines as you move your foot from the brake pedal to the accelerator.

Manual transmission models

Depress the clutch pedal, and shift to one of the forward gears when facing uphill, or **R** when facing downhill, then release the brake pedal.

Continuously variable transmission models

Move the shift lever to **D**, **S**, or **L*** when facing uphill, or **R** when facing downhill, then release the brake pedal.

* Not available on all models

Starting to Drive

When the engine was started using the  button on the smart entry remote

The engine stops when the shift lever is moved out of **P** before the **ENGINE START/STOP** button is pressed. Follow step 1 when starting to drive.

You can also release the parking brake by pressing the electric parking brake switch while depressing the brake pedal.

When facing downhill, you can start your vehicle more smoothly by manually releasing it with the electric parking brake switch than by releasing it with the accelerator pedal.

Hill start assist system

Hill start assist may not prevent the vehicle from rolling downhill on a very steep or slippery slope, and does not operate on small inclines.

Hill start assist is not a replacement for the parking brake.

Hill start assist will operate even when VSA® is switched off.

Precautions While Driving

In Rain

Avoid driving in deep water and on flooded roads. This can damage the engine or driveline, or cause electrical component failure.

Other Precautions

If there is a strong impact with something under the vehicle, stop in a safe location. Check the underside of the vehicle for damage or any fluid leaks.

Precautions While Driving

NOTICE

Do not operate the shift lever while pressing the accelerator pedal. You could damage the transmission.

NOTICE

If you repeatedly turn the steering wheel at an extremely low speed, or hold the steering wheel in the full left or right position for a while, the electric power steering (EPS) system heats up. The system goes into a protective mode, and limits its performance. The steering wheel becomes harder and harder to operate. Once the system cools down, the EPS system is restored.

Repeated operation under these conditions can eventually damage the system.

If the ignition switch is turned to ACCESSORY **I***1 while driving, the engine will shut down and all steering and brake power assist functions will stop, making it difficult to control the vehicle.

Do not put the shift lever in **N**, as you will lose engine braking (and acceleration) performance.

During the first 600 miles (1,000 km) of operation, avoid sudden acceleration or full throttle operation so as not to damage the engine or powertrain.

Avoid hard braking for the first 200 miles (300 km). You should also follow this when the brake pads are replaced.

*1: Models with the smart entry system have an **ENGINE START/STOP** button instead of an ignition switch.

Continuously Variable Transmission *

■ Creeping

The engine runs at a higher idle speed and creeping increases.
Keep the brake pedal firmly depressed when stopped.

■ Kickdown

Quickly depressing the accelerator pedal while driving uphill may cause the transmission to drop to a lower ratio, unexpectedly increasing vehicle speed.
Depress the accelerator pedal carefully, especially on slippery roads and curves.

ⓘ Precautions While Driving

NOTICE

Models with SPORT mode

The following can damage the under spoiler:

- Parking the vehicle by a parking block
- Parallel parking along the road shoulder
- Driving toward the bottom of a hill
- Driving up or down to a different surface level (such as a road shoulder)
- Driving on a rutted or bumpy road
- Driving on a road with potholes

Continuously variable transmission models without paddle shifters

Shifting

Change the shift position in accordance with your driving needs.

■ Shift lever positions

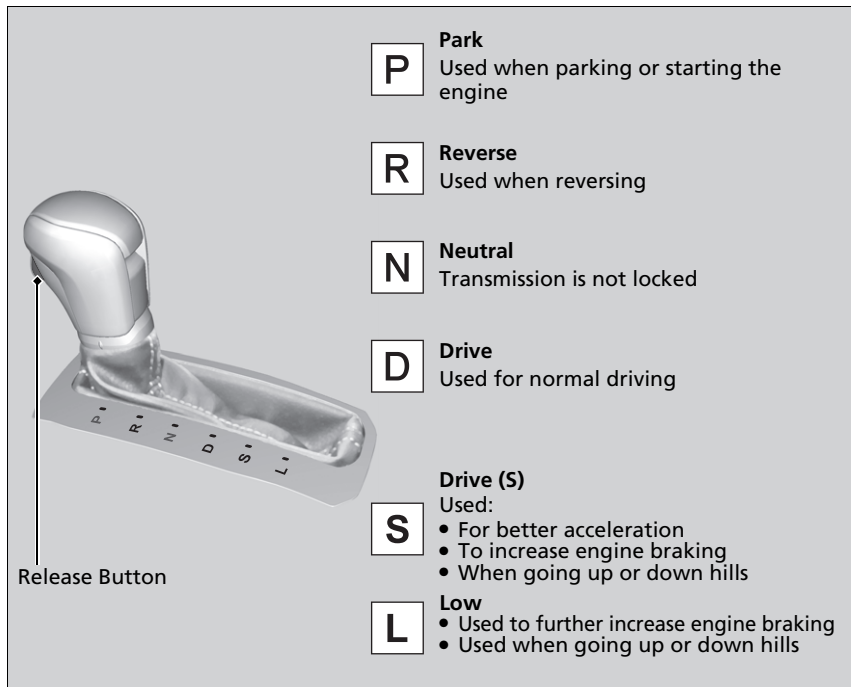

*1: Models with the smart entry system have an **ENGINE START/STOP** button instead of an ignition switch.

▶▶ Shifting

You cannot turn the ignition switch to LOCK [0]*1 and remove the key unless the shift lever is in [P].

The vehicle may move forward very slightly even in [N] while the engine is cold. Depress the brake pedal firmly and, when necessary, apply the parking brake.

Shift Lever Operation

Models with information display

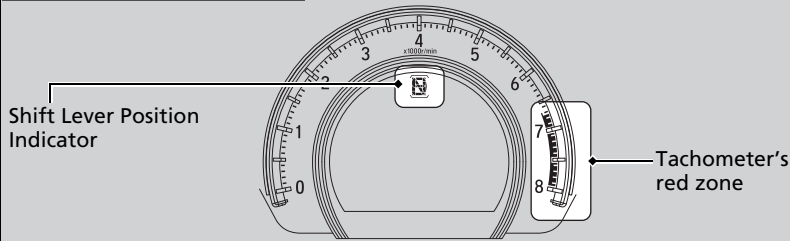

Models with driver information interface

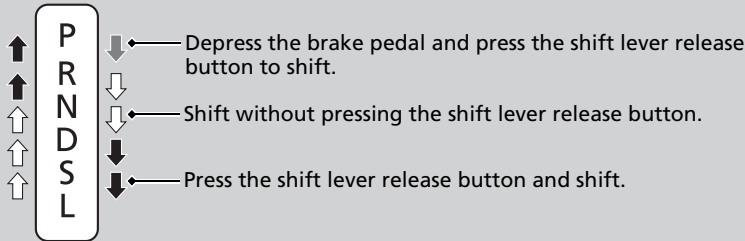
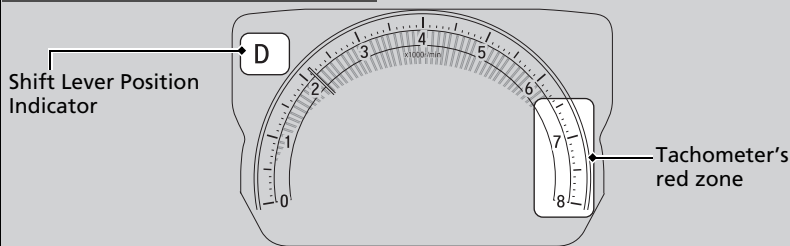

Shift Lever Operation

NOTICE

When you change the shift lever from **[D]** to **[R]** and vice versa, come to a complete stop and keep the brake pedal depressed. Operating the shift lever before the vehicle has come to a complete standstill can damage the transmission.

Use the shift lever position indicator to check the lever position before pulling away.

If the transmission indicator blinks when driving, in any shift position, there is a problem with the transmission. Avoid sudden acceleration and have the transmission checked by a dealer as soon as possible.

The fuel supply may be cut off if you drive at engine speeds in or over the tachometer's red zone (engine speed limit). If this happens, you may experience a slight jolt.

It may not be possible to operate the shift lever if the brake pedal is applied while the shift lever release button is held down. Depress the brake pedal first.

When shifting positions in extremely low temperatures (-22°F/-30°C), there may be a short delay before the shift position is displayed. Always confirm you are in the correct shift position before driving.

Continuously variable transmission models with paddle shifters

Shifting

Change the shift position in accordance with your driving needs.

■ Shift lever positions

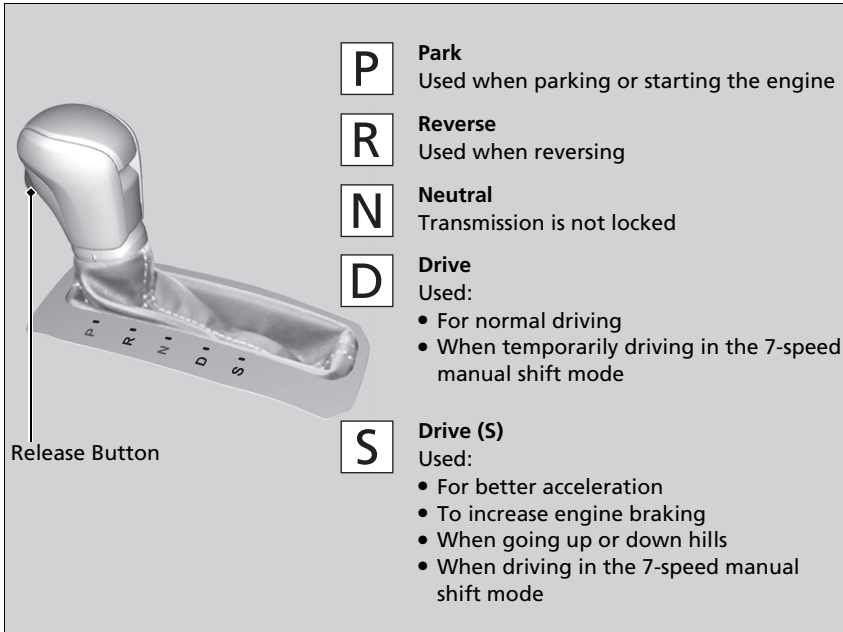

▶▶ Shifting

You cannot change the power mode from ON to VEHICLE OFF (LOCK) unless the shift lever is in **P**.

The vehicle may move forward very slightly even in **N** while the engine is cold.

Depress the brake pedal firmly and, when necessary, apply the parking brake.

Shift Lever Operation

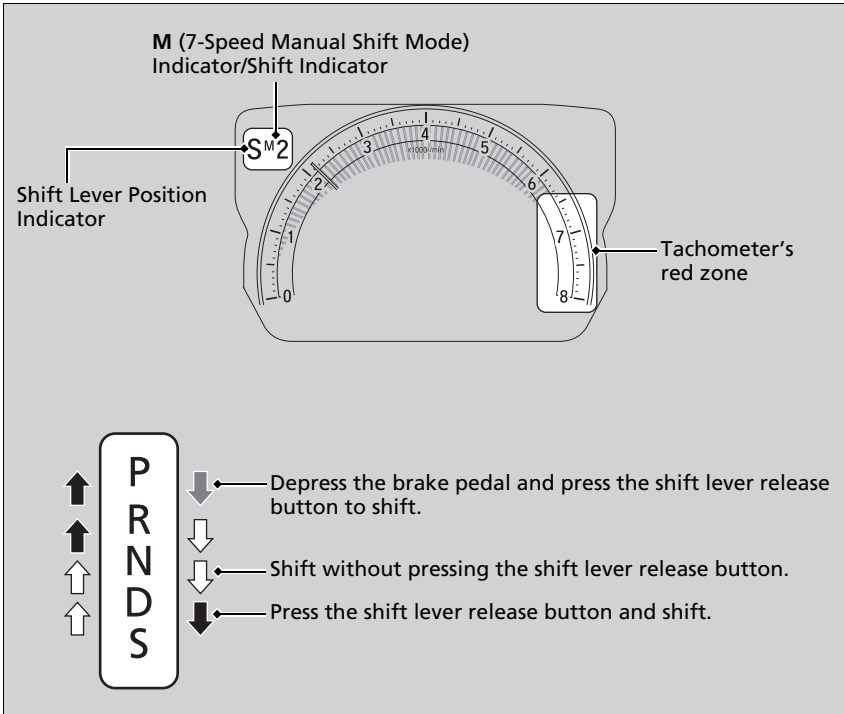

Shift Lever Operation

NOTICE

When you change the shift lever from **[D]** to **[R]** and vice versa, come to a complete stop and keep the brake pedal depressed. Operating the shift lever before the vehicle has come to a complete standstill can damage the transmission.

Use the shift lever position indicator to check the lever position before pulling away.

If the transmission indicator blinks when driving, in any shift position, there is a problem with the transmission. Avoid sudden acceleration and have the transmission checked by a dealer as soon as possible.

The fuel supply may be cut off if you drive at engine speeds in or over the tachometer's red zone (engine speed limit). If this happens, you may experience a slight jolt.

It may not be possible to operate the shift lever if the brake pedal is applied while the shift lever release button is held down. Depress the brake pedal first.

When shifting positions in extremely low temperatures (-22°F/-30°C), there may be a short delay before the shift position is displayed. Always confirm you are in the correct shift position before driving.

■ 7-Speed Manual Shift Mode

Use the paddle shifters to change between 1st and 7th speeds without removing your hands from the steering wheel. The transmission switches to the 7-speed manual shift mode when you pull a paddle shifter while driving. This mode is useful when engine braking is needed.

■ When the shift lever is in **[D]**:

The shift mode goes into the 7-speed manual shift mode temporarily, and the number is displayed in the shift indicator.

The 7-speed manual shift mode is canceled automatically if you drive at constant speed or accelerate, and the number in the shift indicator goes off.

You can cancel this mode by pulling the **[+]** paddle shifter for a few seconds.

The 7-speed manual shift mode is especially useful when reducing the vehicle speed temporarily before making a turn.

■ When the shift lever is in **[S]**:

The shift mode goes into the 7-speed manual shift mode. The **M** indicator and the speed number are displayed in the shift indicator. As the vehicle speed slows down, the transmission automatically shifts down accordingly. When the vehicle comes to a stop, it automatically shifts down into 1st.

If the vehicle speed increases and the engine speed reaches near the tachometer's red zone, the transmission automatically shifts up.

You can only pull away in 1st speed.

When canceling the 7-speed manual shift mode, move the shift lever from **[S]** to **[D]**. When the 7-speed manual shift mode is canceled, the **M** indicator and shift indicator go off.

⌘ 7-Speed Manual Shift Mode

To improve fuel economy, the transmission may shift up to a higher speed than the seventh under certain circumstances. In this case, the number in the shift indicator remains as **7**.

In the 7-speed manual shift mode, the transmission shifts up or down by operating either paddle shifter under the following conditions:

Shift Up: The engine speed reaches the lowest threshold of the higher speed position.

Shift Down: The engine speed reaches the highest threshold of the lower speed position.

When the engine speed reaches near the tachometer's red zone, the transmission shifts up automatically.

When the engine speed reaches the lowest threshold of the selected speed position, the transmission shifts down automatically.

Operating the paddle shifters on slippery surfaces may cause the tires to lock up. In this case, the 7-speed manual shift mode is canceled and goes back to the normal D driving mode.

7-Speed Manual Shift Mode Operation

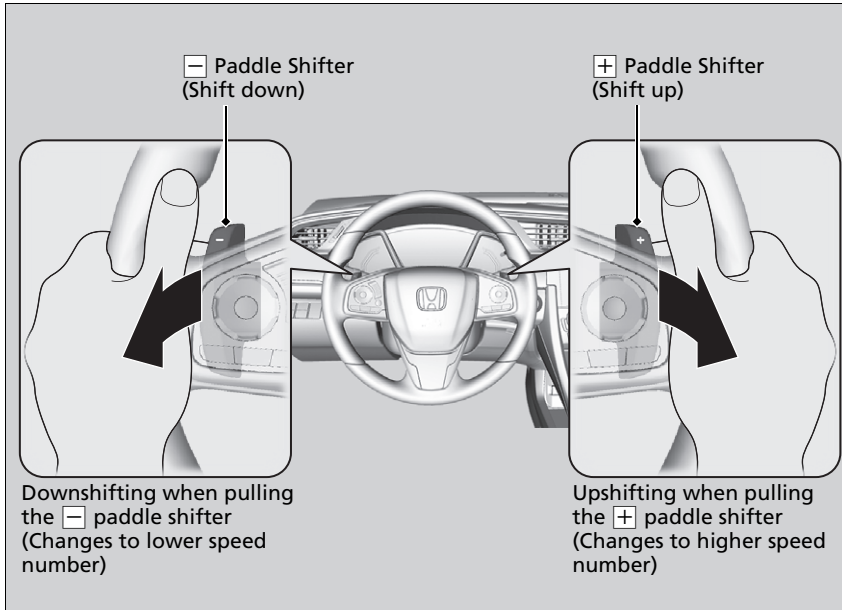

7-Speed Manual Shift Mode Operation

Each paddle shift operation makes a single speed change.

To change continuously, release the paddle shifter before pulling it again for the next speed.

The shift indicator blinks when you cannot shift up or down. It indicates that your vehicle speed is not in its allowable shifting range.

Slightly accelerate to shift up and decelerate to shift down while the indicator is blinking.

Manual transmission models

Shifting

Shift Lever Operation

Fully depress the clutch pedal to operate the shift lever and change gears, then slowly release the pedal.

Depress the clutch pedal, and pause for a few seconds before shifting into **[R]**, or shift into one of the forward gears for a moment. This stops the gears so they do not “grind.”

Shifting

NOTICE

Do not shift to **[R]** before the vehicle comes to a complete stop. Shifting to **[R]** before stopping can damage the transmission.

NOTICE

Before downshifting, make sure the engine will not go into the tachometer's red zone. Should this occur, it can severely damage your engine.

There is a metallic part on the shift lever. If you leave the vehicle parked outside for a long time on a hot day, be careful before moving the shift lever. Because of heat, the shift lever may be extremely hot. If the outside temperature is low, the shift lever may feel cold.

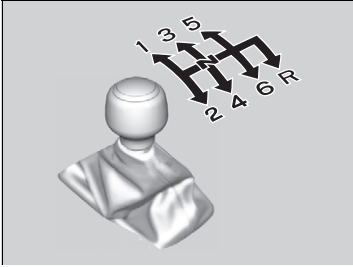

When you are not shifting, do not rest your foot on the clutch pedal. This can cause your clutch to wear out faster.

Shifting

If you exceed the maximum speed for the gear you are in, the engine speed will enter into the tachometer's red zone. When this happens, you may experience a slight jolt.

Continued

Reverse Lockout

The manual transmission has a lockout mechanism that stops you from accidentally shifting into **R** from a forward gear while the vehicle is moving above a certain speed.

If you cannot shift to **R** when the vehicle is stopped, do the following:

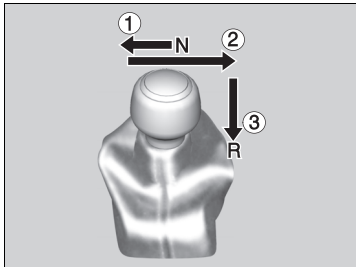

1. Depress the clutch pedal, move the shift lever all the way to the left, and shift to **R**.
2. If you still cannot shift into **R**, apply the parking brake, and turn the ignition switch to ACCESSORY **I** or LOCK **O***1.
3. Depress the clutch pedal and shift into **R**.
4. Keep depressing the clutch pedal and start the engine.

Have the vehicle checked by a dealer if you have to go through this procedure repeatedly.

*1: Models with the smart entry system have an **ENGINE START/STOP** button instead of an ignition switch.

SPORT Mode*

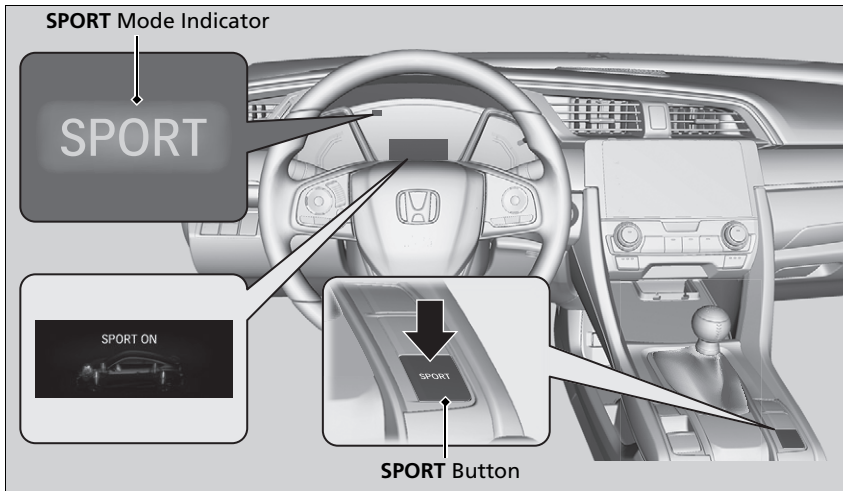

To turn the SPORT mode on and off, press the **SPORT** button.

With SPORT mode activated, the driver can enjoy enhanced engine response, and greater stability and handling.

The SPORT mode is turned off every time you start the engine, even if you turned it on the last time you drove the vehicle.

* Not available on all models

SPORT Mode*

The mode may not be able to be changed under some driving conditions. If mode change is necessary, reduce speed or cornering speed. This message will also appear if you try to change mode when there is a vehicle system failure.

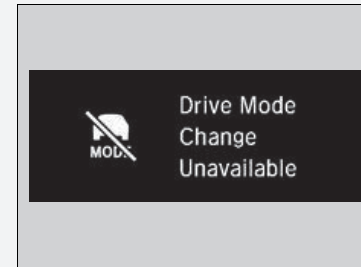

ECON Button*

Models with information display

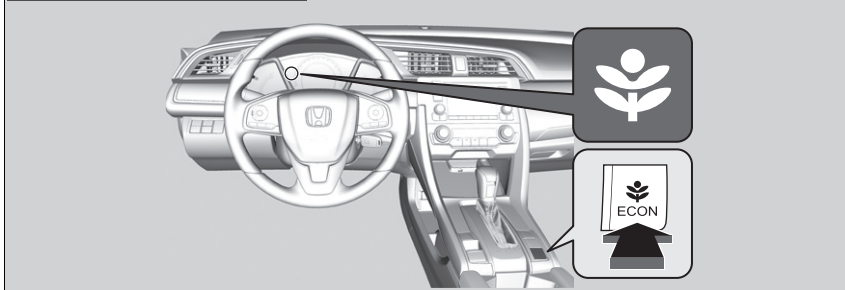

Models with driver information interface

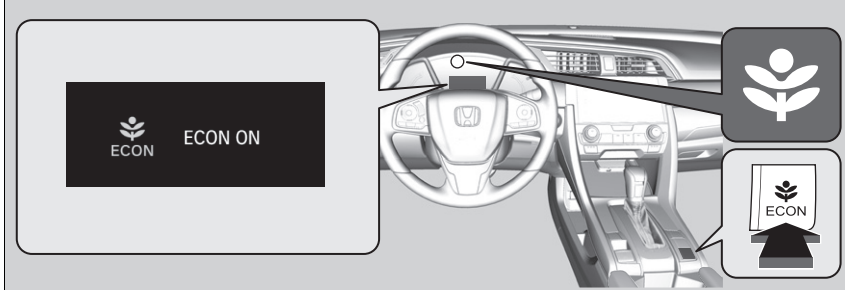

The **ECON** button turns the ECON mode on and off.

The ECON mode helps you improve your fuel economy by adjusting the performance of the engine, transmission, climate control system, and cruise control*.

» ECON Button*

While in the ECON mode, the climate control system has greater temperature fluctuations.

Cruise Control*

Maintains a constant vehicle speed without having to keep your foot on the accelerator. Use cruise control on freeways or open roads where you can travel at a constant speed with little acceleration or deceleration.

When to use

- **Vehicle speed for cruise control:**
Desired speed in a range above roughly 25 mph (40 km/h) ~
- **Shift positions for cruise control:**
In **D** or **S**

Always keep sufficient distance between you and the vehicle in front of you.

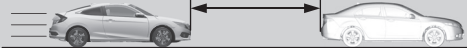

How to use

CRUISE MAIN is on in the instrument panel.
Cruise control is ready to use.

- Press the **CRUISE** button on the steering wheel.

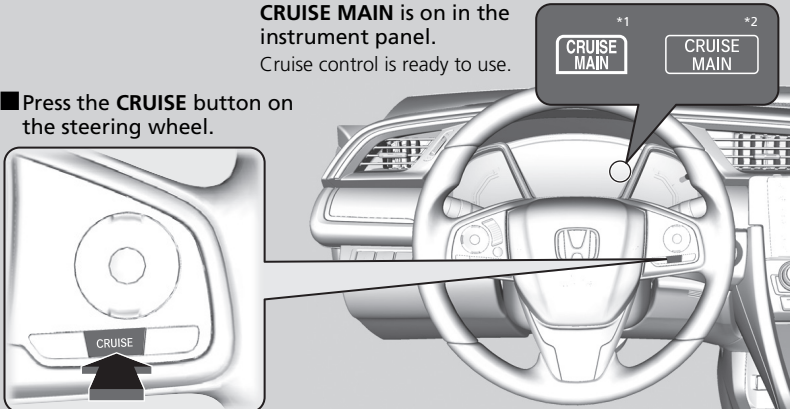

*1: Models with information display
*2: Models with driver information interface

* Not available on all models

⚠ Cruise Control*

⚠ WARNING

Improper use of the cruise control can lead to a crash.

Use the cruise control only when traveling on open highways in good weather.

It may not be possible to maintain a constant speed when driving uphill or downhill.

When not using cruise control:
Turn off cruise control by pressing the **CRUISE** button.

Models with ECON system
While in ECON mode, it may take relatively more time to accelerate to maintain the set speed.

Manual transmission models
When the engine speed slows down, try to downshift.
You can maintain the set speed if you change gear within five seconds.

■ To Set the Vehicle Speed

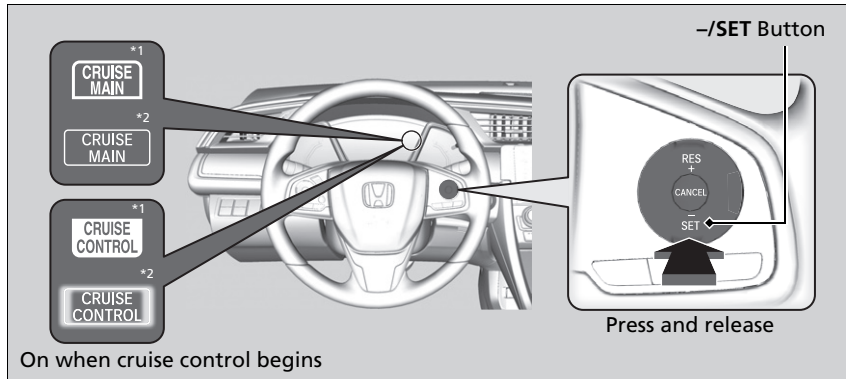

Take your foot off the pedal and press the **-/SET** button when you reach the desired speed.

The moment you release the **-/SET** button, the set speed is fixed, and cruise control begins. The **CRUISE CONTROL** indicator comes on.

When you use cruise control, Straight Driving Assist (a feature of the Electric Power Steering system) is activated.

By enabling the steering system to automatically compensate for natural steering pull, Straight Driving Assist makes it easier for you to keep your vehicle in a straight line.

*1 : Models with information display

*2 : Models with driver information interface

■ To Adjust the Vehicle Speed

Increase or decrease the vehicle speed using the **RES/+** or **-/SET** buttons on the steering wheel.

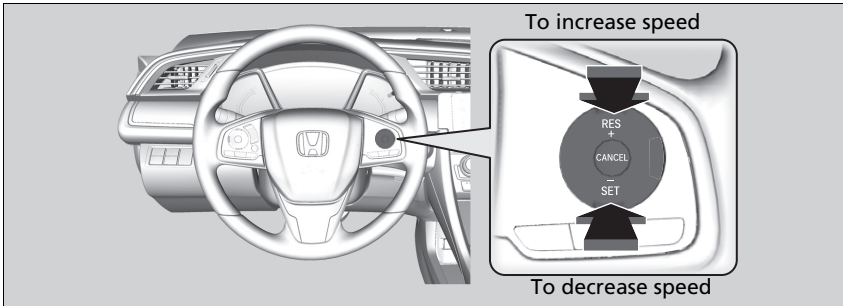

- Each time you press the button, the vehicle speed is increased or decreased by about 1 mph (1.6 km/h).
- If you keep the button pressed, the vehicle speed increases or decreases until you release it. This speed is then set.

■ To Cancel

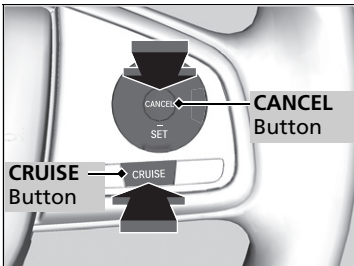

To cancel cruise control, do any of the following:

- Press the **CANCEL** button.
- Press the **CRUISE** button.
- Depress the brake pedal.
- Depress the clutch pedal* for five seconds or more.

The **CRUISE CONTROL** indicator goes off.

* Not available on all models

☒ To Adjust the Vehicle Speed

You can set the vehicle speed using the **-/SET** button on the steering wheel when adjusting the speed with the accelerator and brake pedals.

☒ To Cancel

Resuming the prior set speed:

After cruise control has been canceled, you can still resume the prior set speed by pressing the **RES/+** button while driving at a speed of at least 25 mph (40 km/h) or more.

You cannot set or resume in the following situations:

- When vehicle speed is less than 25 mph (40 km/h)
- When the **CRUISE** button is turned on.

At vehicle speeds of 22 mph (35 km/h) or less, cruise control is canceled automatically.

Front Sensor Camera*

The camera, used in systems such as LKAS, RDM, ACC with LSF, and CMBS™, is designed to detect an object that triggers any of the systems to operate its functions.

Camera Location and Handling Tips

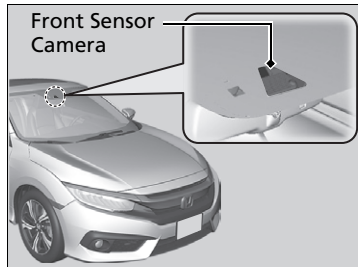

This camera is located behind the rearview mirror.

To help reduce the likelihood that high interior temperatures will cause the camera's sensing system to shut off, when parking, find a shady area or face the front of the vehicle away from the sun. If you use a reflective sun shade, do not allow it to cover the camera housing.

Covering the camera can concentrate heat on it.

Front Sensor Camera*

Never apply a film or attach any objects to the windshield, the hood, or the front grill that could obstruct the camera's field of vision and cause the system to operate abnormally.

Scratches, nicks, and other damage to the windshield within the camera's field of vision can cause the system to operate abnormally. If this occurs, we recommend that you replace the windshield with a genuine Honda replacement windshield. Making even minor repairs within the camera's field of vision or installing an aftermarket replacement windshield may also cause the system to operate abnormally. After replacing the windshield, have a dealer recalibrate the camera. Proper calibration of the camera is necessary for the system to operate properly.

Do not place an object on the top of the instrument panel. It may reflect onto the windshield and prevent the system from detecting lane lines properly.

⌘ Front Sensor Camera*

If the **Some Driver Assist Systems Cannot Operate: Camera Temperature Too High** message appears:

- Use the climate control system to cool down the interior and, if necessary, also use defroster mode with the airflow directed toward the camera.
- Start driving the vehicle to lower the windshield temperature, which cools down the area around the camera.

If the **Some Driver Assist Systems Cannot Operate: Clean Front Windshield** message appears:

- Park your vehicle in a safe place, and clean the windshield. If the message does not disappear after you have cleaned the windshield and driven for a while, have your vehicle checked by a dealer.

Adaptive Cruise Control (ACC) with Low Speed Follow (LSF)*

Helps maintain a constant vehicle speed and a set following-interval behind a vehicle detected ahead of yours and, if the detected vehicle comes to a stop, can decelerate and stop your vehicle, without you having to keep your foot on the brake or the accelerator.

When ACC with LSF slows your vehicle by applying the brakes, your vehicle's brake lights will illuminate.

▶ Adaptive Cruise Control (ACC) with Low Speed Follow (LSF)*

⚠ WARNING

Improper use of ACC with LSF can lead to a crash.

Use ACC with LSF only when driving on expressways or freeways and in good weather conditions.

⚠ WARNING

ACC with LSF has limited braking capability and may not stop your vehicle in time to avoid a collision with a vehicle that quickly stops in front of you.

Always be prepared to apply the brake pedal if the conditions require.

Important Reminder

As with any system, there are limits to ACC with LSF. Use the brake pedal whenever necessary, and always keep a safe interval between your vehicle and other vehicles.

When to use

The camera is located behind the rearview mirror.

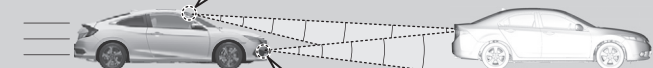
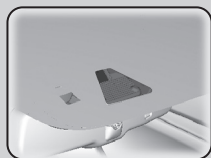

The radar sensor is in the lower bumper next to the fog light*.

Be careful not to have the radar sensor cover strongly impacted.

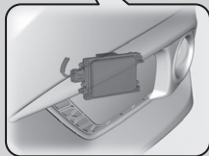

■ Vehicle speed for ACC with LSF: **A vehicle is detected ahead within ACC with LSF range** – ACC with LSF operates at speeds up to 90 mph (145 km/h).

No vehicle is detected within ACC with LSF range – ACC with LSF operates at the speed of 25 mph (40 km/h) or above.

■ Shift position for ACC with LSF: In **D** or **S**.

■ How to activate the system

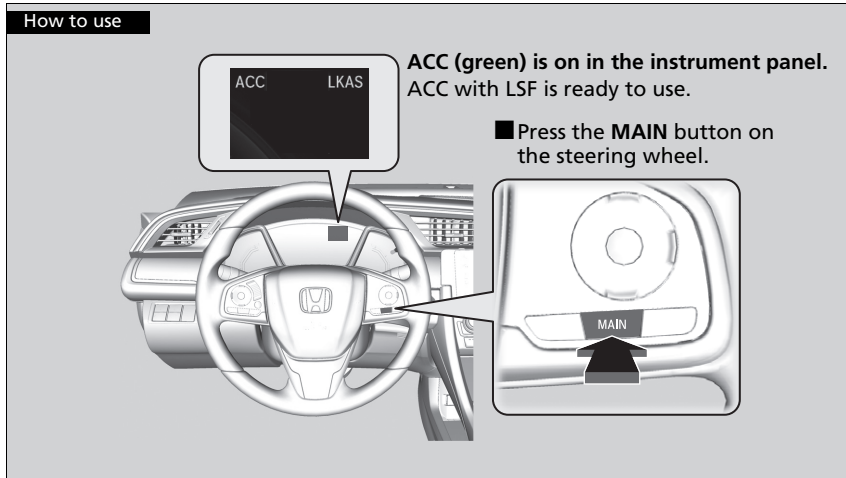

▣ Adaptive Cruise Control (ACC) with Low Speed Follow (LSF)*

When the **MAIN** button is pressed, both ACC with LSF and the Lane Keeping Assist System (LKAS) are either turned on or off.

ACC with LSF may not work properly under certain conditions.

▣ **ACC with LSF Conditions and Limitations**
P. 443

When not using ACC with LSF: Turn off adaptive cruise by pressing the **MAIN** button. This also will turn off the Lane Keeping Assist System (LKAS).

Do not use ACC with LSF under the following conditions:

- On roads with heavy traffic or while driving in continuous stop and go traffic.
- On roads with sharp turns.
- On roads with steep downhill sections, as the set vehicle speed can be exceeded by coasting. In such cases, ACC with LSF will not apply the brakes to maintain the set speed.
- On roads with toll collection facilities or other objects between lanes of traffic, or in parking areas, or facilities with drive through access.

■ To Set the Vehicle Speed

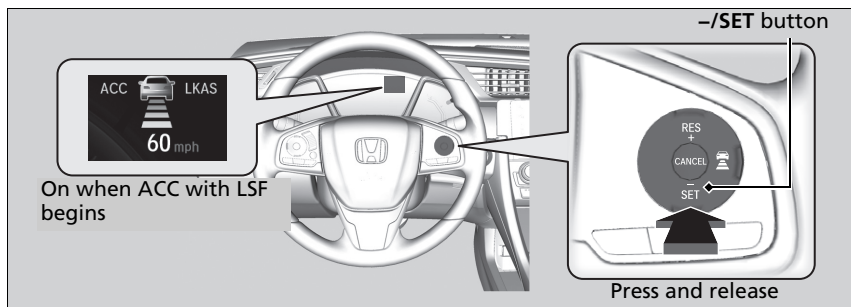

When driving at about 25 mph (40 km/h) or above: Take your foot off the pedal and press the **-/SET** button when you reach the desired speed. The moment you release the button, the set speed is fixed, and ACC with LSF begins.

When driving slower than about 25 mph (40 km/h): If the vehicle is moving and the brake pedal is not depressed, pressing the button fixes the set speed to 25 mph (40 km/h) regardless of current vehicle speed. If your vehicle is stationary and a vehicle is detected ahead, your vehicle speed can be set, even with the brake pedal depressed.

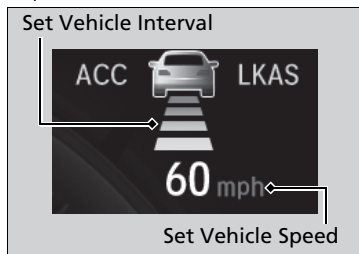

When ACC with LSF starts operating, the vehicle icon, interval bars and set speed appear on the driver information interface. When you use ACC with LSF, Straight Driving Assist (a feature of the Electric Power Steering system) is activated.

By enabling the steering system to automatically compensate for natural steering pull, Straight Driving Assist makes it easier for you to keep your vehicle in a straight line.

▶▶ To Set the Vehicle Speed

You can switch the displayed set speed measurements on the driver information interface/audio/information screen between mph and km/h.

▶ **Customized Features** P. 316

■ When in Operation

■ There is a vehicle ahead

ACC with LSF monitors if a vehicle ahead of you enters the ACC with LSF range. If a vehicle is detected doing so, the ACC with LSF system maintains or decelerates your vehicle's set speed in order to keep the vehicle's set following-interval from the vehicle ahead.

📖 **To Set or Change Following-Interval** P. 446

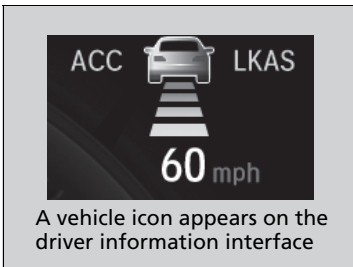
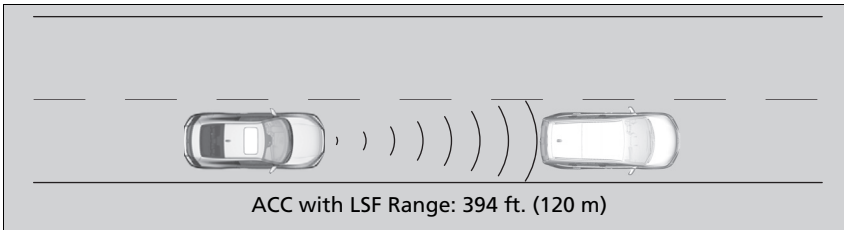

When a vehicle whose speed is slower than your set speed is detected in front of you, your vehicle starts to slow down.

📖 When in Operation

If the vehicle ahead of you slows down abruptly, or if another vehicle cuts in front of you, the beeper sounds, a message appears on the driver information interface.

Depress the brake pedal, and keep an appropriate interval from the vehicle ahead.

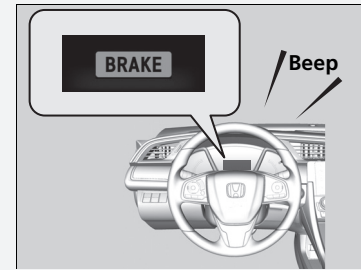

Even if the interval between your vehicle and the vehicle detected ahead is short, ACC with LSF may start accelerating your vehicle under the following circumstances:

- The vehicle ahead of you is going at almost the same speed as, or faster than, your vehicle.
- A vehicle that cuts in front of you is going faster than your vehicle, gradually increasing the interval between the vehicles.

You can also set the system to beep when a vehicle in front of you comes in and goes out of the ACC with LSF detecting range. Change the **ACC Forward Vehicle Detect Beep** setting.

📖 **Customized Features** P. 316

■ There is no vehicle ahead

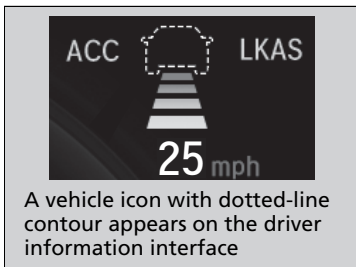

A vehicle icon with dotted-line contour appears on the driver information interface

Your vehicle maintains the set speed without having to keep your foot on the brake or accelerator pedal.

If there previously was a vehicle detected ahead that kept your vehicle from traveling at the set speed, ACC with LSF accelerates your vehicle to the set speed, and then maintains it.

■ When you depress the accelerator pedal

You can temporarily increase the vehicle speed. In this case, there is no audible or visual alert even if a vehicle is in the ACC with LSF range.

ACC with LSF stays on unless you cancel it. Once you release the accelerator pedal, the system resumes an appropriate speed for keeping the following-interval while a vehicle ahead is within the ACC with LSF range.

■ A vehicle detected ahead is within ACC with LSF range and slows to a stop

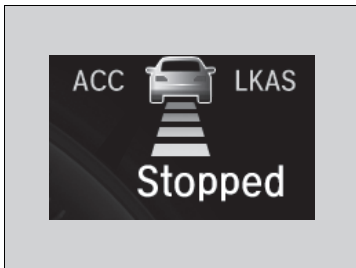

Your vehicle also stops, automatically. The **Stopped** message appears on the driver information interface.

When the vehicle ahead of you starts again, the vehicle icon on the driver information interface blinks. If you press the **RES/+** or **-/SET** button, or depress the accelerator pedal, ACC with LSF operates again within the prior set speed.

▶▶ When in Operation

⚠ WARNING

Exiting a vehicle that has been stopped while the ACC with LSF system is operating can result in the vehicle moving without operator control.

A vehicle that moves without operator control can cause a crash, resulting in serious injury or death.

Never exit a vehicle when the vehicle is stopped by ACC with LSF.

Limitations

You may need to use the brake to maintain a safe interval when using ACC with LSF. Additionally, ACC with LSF may not work properly under certain conditions.

▶ **ACC with LSF Conditions and Limitations**
P. 443

■ ACC with LSF Conditions and Limitations

The system may automatically shut off and the **ACC** indicator will come on under certain conditions. Some examples of these conditions are listed below. Other conditions may reduce some of the ACC functions.

➤ **Front Sensor Camera*** P. 436

■ Environmental conditions

- Driving in bad weather (rain, fog, snow, etc.).

■ Roadway conditions

- Driving on a snowy or wet roadway (obscured lane marking, vehicle tracks, reflected lights, road spray, high contrast).

■ Vehicle conditions

- The outside of the windshield is blocked by dirt, mud, leaves, wet snow, etc.
- An abnormal tire or wheel condition (Wrong size, varied size or construction, improperly inflated, compact spare tire, etc.).
- The camera temperature gets too high.
- The parking brake is applied.
- When the lower bumper next to the fog light* is dirty.
- The vehicle is tilted due to a heavy load or suspension modifications.
- When tire chains are installed.

* Not available on all models

Continued

☒ ACC with LSF Conditions and Limitations

The radar sensor for ACC with LSF is shared with the collision mitigation braking system™ (CMBS™).

➤ **Collision Mitigation Braking System™ (CMBS™)*** P. 482

You can read about handling information for the camera equipped with this system.

➤ **Front Sensor Camera*** P. 436

Always keep the radar sensor cover clean.

Never use chemical solvents or polishing powder for cleaning the sensor cover. Clean it with water or a mild detergent.

Do not put a sticker on the radar sensor cover or replace the radar sensor cover.

If you need the radar sensor to be repaired, or removed, or the radar sensor cover is strongly impacted, turn off the system by pressing the **MAIN** button and take your vehicle to a dealer.

Have your vehicle checked by a dealer if you find any unusual behavior of the system (e.g., the warning message appears too frequently).

■ Detection limitations

- A vehicle or pedestrian suddenly crosses in front of you.
- The interval between your vehicle and the vehicle or pedestrian ahead of you is too short.
- A vehicle cuts in front of you at a slow speed, and it brakes suddenly.
- When you accelerate rapidly and approach the vehicle or pedestrian ahead of you at high speed.
- The vehicle ahead of you is a motorcycle, bicycle, mobility scooter, or other small vehicle.
- When there are animals in front of your vehicle.
- When you drive on a curved or winding or undulating road that makes it difficult for the sensor to properly detect a vehicle or a pedestrian in front of you.
- The speed difference between your vehicle and a vehicle or pedestrian in front of you is significantly large.
- An oncoming vehicle suddenly comes in front of you.
- Your vehicle abruptly crosses over in front of an oncoming vehicle.
- When driving through a narrow iron bridge.
- When the vehicle ahead of you brakes suddenly.
- When the vehicle ahead of you has a unique shape.
- When your vehicle or the vehicle ahead of you is driving on one edge of the lane.

⚠ ACC with LSF Conditions and Limitations

If the front of the vehicle is impacted in any of the following situations, the radar sensor may not work properly. Have your vehicle checked by a dealer:

- The vehicle mounted onto a bump, curb, chock, embankment, etc.
- You drive the vehicle where the water is deep.
- Your vehicle has a frontal collision.

■ To Adjust the Vehicle Speed

Increase or decrease the vehicle speed using the **RES/+** or **-/SET** button on the steering wheel.

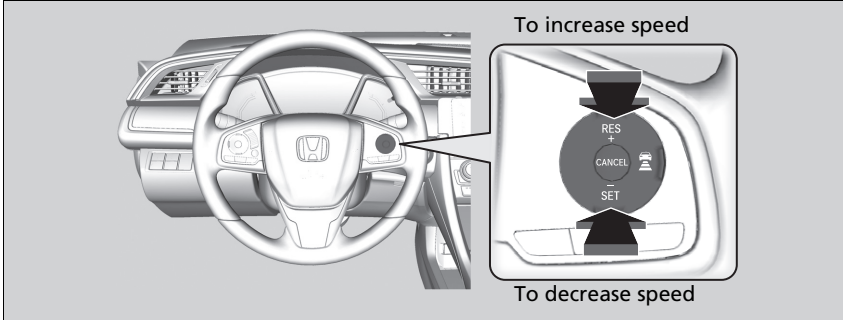



- Each time you press the **RES/+** or **-/SET** button, the vehicle speed is increased or decreased by about 1 mph or 1 km/h accordingly.
- If you keep pressing the **RES/+** or **-/SET** button, the vehicle speed increases or decreases by about 5 mph or 5 km/h accordingly.

☒ To Adjust the Vehicle Speed

If a vehicle detected ahead is going at a speed slower than your increased set speed, ACC with LSF may not accelerate your vehicle. This is to maintain the set interval between your vehicle and the vehicle ahead.

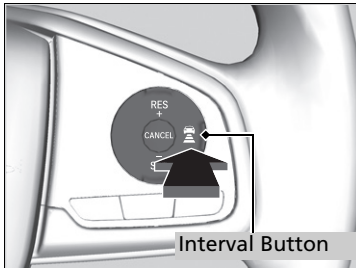



■ To Set or Change Following-Interval



Press the  (interval) button to change the ACC with LSF following-interval. Each time you press the button, the following-interval (the interval behind a vehicle detected ahead of you) setting cycles through extra long, long, middle, and short following-intervals.

Determine the most appropriate following-interval setting based on your specific driving conditions. Be sure to adhere to any following-interval requirements set by local regulation.

The higher your vehicle's following-speed is, the longer the short, middle, long or extra long following-interval becomes. See the following examples for your reference.

Following-Interval		When the Set Speed is:	
		50 mph (80 km/h)	65 mph (104 km/h)
Short		83 feet 25 meters 1.1 sec	100 feet 31 meters 1.1 sec
Middle		110 feet 33 meters 1.5 sec	137 feet 42 meters 1.5 sec
Long		154 feet 47 meters 2.1 sec	200 feet 61 meters 2.1 sec
Extra Long		204 feet 62 meters 2.8 sec	265 feet 81 meters 2.8 sec

When your vehicle stops automatically because a vehicle detected ahead of you has stopped, the interval between the two vehicles will vary based on the ACC with LSF interval setting.

■ To Cancel

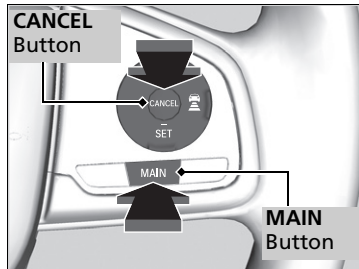

To cancel ACC with LSF, do any of the following:

- Press the **CANCEL** button.
- Press the **MAIN** button.
 - ▶ ACC with LSF indicator goes off.
- Depress the brake pedal.
 - ▶ When the LSF function has stopped the vehicle, you cannot cancel ACC with LSF by depressing the brake pedal.

▶▶ To Cancel

Resuming the prior set speed: After you have canceled ACC with LSF, you can resume the prior set speed while it is still displayed. Press the **RES/+** button.

The set speed cannot be set or resumed when ACC with LSF has been turned off using the **MAIN** button. Press the **MAIN** button to activate the system, then set the desired speed.

■ Automatic cancellation

The beeper sounds and a message appears on the driver information interface when ACC with LSF is automatically canceled. Any of these conditions may cause the ACC with LSF to automatically cancel:

- Bad weather (rain, fog, snow, etc.)
- When the radar sensor in the lower bumper next to the fog light* gets dirty.
- The vehicle ahead of you cannot be detected.
- An abnormal tire condition is detected, or the tires are skidding.
- Driving on a mountainous road, or driving off road for extended periods.
- Abrupt steering wheel movement.
- When the ABS, VSA® or CMBS™ is activated.
- When the ABS or VSA® system indicator comes on.
- When the vehicle is stopped on a very steep slope.
- When you manually apply the parking brake.
- When the detected vehicle within the ACC with LSF range is too close to your vehicle.
- The camera behind the rearview mirror, or the area around the camera, including the windshield, gets dirty.

The ACC with LSF automatic cancellation can be also triggered by the following causes. In these cases, the parking brake will be automatically applied.

- The driver's seat belt is unfastened when the vehicle is stationary.
- The vehicle stops for more than 10 minutes.
- The engine is turned off.

* Not available on all models

Continued

⌘ Automatic cancellation

Even though ACC with LSF has been automatically canceled, you can still resume the prior set speed. Wait until the condition that caused ACC with LSF to cancel improves, then press the **-/SET** button.

■ To Switch ACC with LSF to Cruise Control

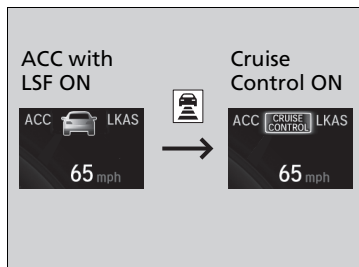

Press and hold the  (interval) button for one second. **Cruise Mode Selected** appears on the driver information interface for two seconds, and then the mode switches to Cruise.

To switch back to ACC with LSF, press and hold the  button again for one second. **ACC Mode Selected** appears on the driver information interface for two seconds.

■ When to use

Desired speed in a range above roughly 25 mph (40 km/h) ~.

■ To Set the Vehicle Speed

Take your foot off the pedal and press the **-/SET** button when you reach the desired speed.

The moment you release the **-/SET** button, the set speed is fixed, and cruise control begins. The **CRUISE CONTROL** indicator comes on.

When you use cruise control, Straight Driving Assist (a feature of the Electric Power Steering system) is activated.

By enabling the steering system to automatically compensate for natural steering pull, Straight Driving Assist makes it easier for you to keep your vehicle in a straight line.

▶▶ To Switch ACC with LSF to Cruise Control

Always be aware which mode you are in. When you are driving in Cruise mode, the system will not assist you to maintain a following interval from a vehicle ahead of you.

To Adjust the Vehicle Speed

- Each time you press the **RES/+** or **-/SET** button, the vehicle speed is increased or decreased by about 1 mph or 1.6 km/h accordingly.
- If you keep the **RES/+** or **-/SET** button pressed, the vehicle speed increases or decreases until you release it. This speed is then set.

To Cancel

To cancel cruise control, do any of the following:

- Press the **CANCEL** button.
- Press the **MAIN** button.
- Depress the brake pedal.

The **CRUISE CONTROL** indicator goes off.

☒ To Cancel

Resuming the prior set speed:

After cruise control has been canceled, you can still resume the prior set speed by pressing the **RES/+** button while driving at a speed of at least 25 mph (40 km/h) or more.

You cannot set or resume in the following situations:

- When vehicle speed is less than 25 mph (40 km/h)
- When the **MAIN** button is turned off.

At vehicle speeds of 22 mph (35 km/h) or less, cruise control canceled automatically.

Road Departure Mitigation (RDM) System*

Alerts and helps to assist you when the system detects a possibility of your vehicle unintentionally crossing over detected lane markings and/or leaving the roadway altogether.

How the System Works

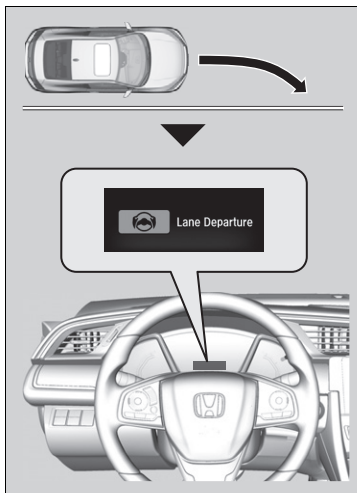

The front camera behind the rearview mirror monitors left and right lane markings (in white or yellow). If your vehicle is getting too close to detected lane markings without a turn signal activated, the system, in addition to a visual alert, applies steering torque and alerts you with rapid vibrations on the steering wheel, to help you remain within the detected lane.

▶ **Customized Features** P. 316

As a visual alert, the **Lane Departure** message appears on the driver information interface.

If the system determines that its steering input is insufficient to keep your vehicle on the roadway, it may apply braking.

▶ Braking is applied only when the lane markings are solid continuous lines.

The system cancels assisting operations when you turn the steering wheel to avoid crossing over detected lane markings.

If the system operates several times without detecting driver response, the system beeps to alert you.

⚠ Road Departure Mitigation (RDM) System*

Important Safety Reminder

Like all assistance systems, the RDM system has limitations.

Over-reliance on the RDM system may result in a collision. It is always your responsibility to keep the vehicle within your driving lane.

The RDM system only alerts you when lane drift is detected without a turn signal in use. The RDM system may not detect all lane markings or lane or roadway departures; accuracy will vary based on weather, speed and lane marker condition. It is always your responsibility to safely operate the vehicle and avoid collisions.

You can read about handling information for the camera equipped with this system.

▶ **Front Sensor Camera*** P. 436

The RDM system may not work properly or may work improperly under the certain conditions:

▶ **RDM Conditions and Limitations** P. 454

There are times when you may not notice RDM functions due to your operation of the vehicle, or road surface conditions.

How the System Activates

The system becomes ready to start searching for lane markings when all the following conditions are met:

- The vehicle is traveling between about 45 and 90 mph (72 and 145 km/h).
- The vehicle is on a straight or slightly curved road.
- The turn signals are off.
- The brake pedal is not depressed.
- The wipers are not in continuous operation.
- The vehicle is not accelerating or braking, and the steering wheel is not being turned.
- The system makes a determination that the driver is not actively accelerating, braking or steering.

RDM On and Off

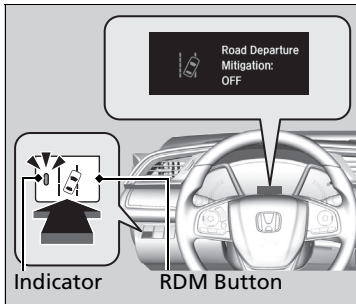

Press the RDM button to turn the system on and off.

- ▶ The indicator in the button comes on and the message appears on the driver information interface when the system is on.

How the System Activates

The RDM system may automatically shut off and the  indicator comes and stays on.

▶ **Indicators** P. 76

RDM system function can be impacted when the vehicle is:

- Not driven within a traffic lane.
- Driven on the inside edge of a curve, or outside of a lane.
- Driven in a narrow lane.

RDM On and Off

When you have selected **Warning Only** from the customized options using the audio/information screen, the system does not operate the steering wheel and braking.

■ RDM Conditions and Limitations

The system may not properly detect lane markings and the position of your vehicle under certain conditions. Some examples of these conditions are listed below.

■ Environmental conditions

- Driving in bad weather (rain, fog, snow, etc.).
- Sudden changes between light and dark, such as an entrance or exit of a tunnel.
- There is little contrast between lane lines and the roadway surface.
- Driving into low sunlight (e.g., at dawn or dusk).
- Strong light is reflected onto the roadway.
- Driving in the shadows of trees, buildings, etc.
- Shadows of adjacent objects are parallel to lane markings.
- Roadway objects or structures are misinterpreted as lane markers.
- Reflections on the interior of the windshield.
- Driving at night or in a dark condition such as a tunnel.

■ Roadway conditions

- Driving on a snowy or wet roadway (obscured lane marking, vehicle tracks, reflected lights, road spray, high contrast).
- Driving on a road with temporary lane markings.
- Faint, multiple, or varied lane markings are visible on the roadway due to road repairs or old lane markings.
- The roadway has merging, split, or crossing lines (e.g., such as at an intersection or crosswalk).
- The lane markings are extremely narrow, wide, or changing.
- The vehicle in front of you is driving near the lane lines.
- The road is hilly or the vehicle is approaching the crest of a hill.
- Driving on rough or unpaved roads, or over bumpy surfaces.
- When objects on the road (curb, guard rail, pylons, etc.) are recognized as white lines (or yellow lines).
- Driving on roads with double lines.

■ Vehicle conditions

- Headlight lenses are dirty or the headlights are not properly adjusted.
- The outside of the windshield is streaked or blocked by dirt, mud, leaves, wet snow, etc.
- The inside of the windshield is fogged.
- The camera temperature gets too high.
- An abnormal tire or wheel condition (wrong sized, varied size or construction, improperly inflated, compact spare tire, etc.).
- The vehicle is tilted due to a heavy load or suspension modifications.
- When tire chains are installed.

Lane Keeping Assist System (LKAS)*

Provides steering input to help keep the vehicle in the middle of a detected lane and provides tactile and visual alerts if the vehicle is detected drifting out of its lane.

■ Steering input assist

The system applies torque to the steering to keep the vehicle between the left and right lane lines. The applied torque becomes stronger as the vehicle gets closer to either of the lane lines.

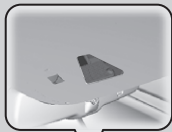

■ LKAS camera
Monitors the lane lines

■ Tactile and visual alerts
Rapid vibrations on the steering wheel and a warning display alert you that the vehicle is drifting out of a detected lane.

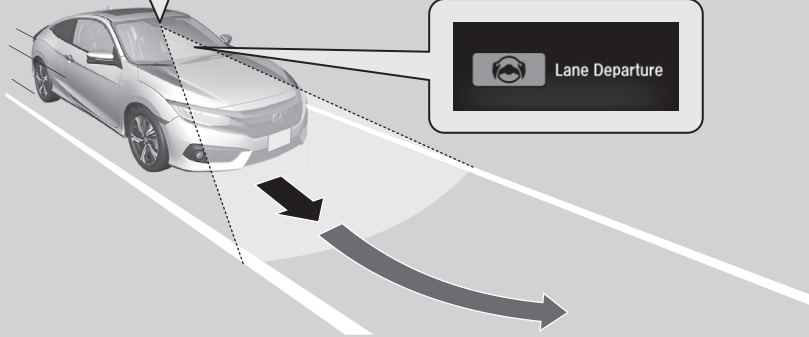
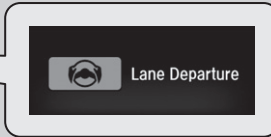

When you operate the turn signals to change lanes, the system is suspended, and resumes after the signals are off.

➡ If you make a lane change without operating the turn signals, the LKAS alerts activate, and torque is applied to the steering.

▶ Lane Keeping Assist System (LKAS)*

Important Safety Reminders

The LKAS is for your convenience only. It is not a substitute for your vehicle control. The system does not work if you take your hands off the steering wheel or fail to steer the vehicle.

▶ Driver Information Interface Warning and Information Messages* P. 97

Do not place objects on the instrument panel. Objects may reflect on the front windshield and prevent correct detection of the traffic lanes.

LKAS only alerts you when lane drift is detected without a turn signal in use. The LKAS may not detect all lane markings or lane departures; accuracy will vary based on weather, speed, and lane marker condition.

It is always your responsibility to safely operate the vehicle and avoid collisions.

The LKAS is convenient when it is used on freeways.

The LKAS may not work properly or may work improperly under the certain conditions:

▶ LKAS Conditions and Limitations P. 461

You can read about handling information for the camera equipped with this system.

▶ Front Sensor Camera* P. 436

■ Lane Keep Support Function

Provides assistance to keep the vehicle in the center of the lane. When the vehicle nears a white or yellow line, steering force of the electric power steering will become stronger.

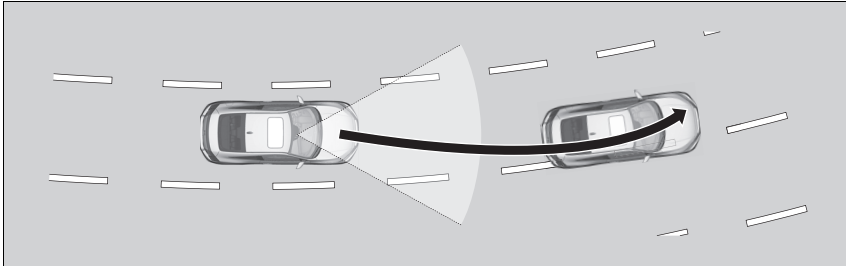

■ Lane Departure Warning Function

When the vehicle enters the warning area, the LKAS alerts you with slight steering wheel vibration as well as a warning display.

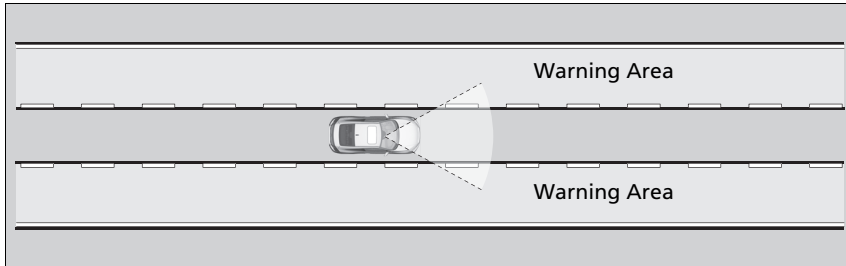

☒ Lane Keeping Assist System (LKAS)*

The LKAS may not function as designed while driving in frequent stop and go traffic, or on roads with sharp curves.

When it fails to detect lanes, the system will temporarily be canceled. When lane is detected, system will recover automatically.

* Not available on all models

■ When the System can be Used

The system can be used when the following conditions are met.

- The lane in which you are driving has detectable lane markers on both sides, and your vehicle is in the center of the lane.
- The vehicle speed is between 45 and 90 mph (72 and 145 km/h).
- You are driving on a straight or slightly curved road.
- The turn signals are off.
- The brake pedal is not depressed.
- The wipers are not in continuous operation.

■ How to activate the system

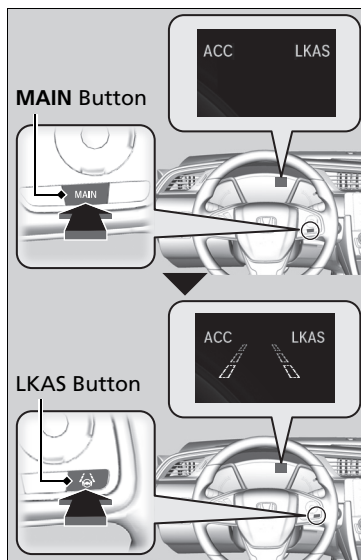

1. Press the **MAIN** button.
 - ▶ The **LKAS** indicator comes on in the driver information interface.
The system is ready to use.
2. Press the **LKAS** button.
 - ▶ Lane outlines appear on the driver information interface.
The system is activated.

▶▶ When the System can be Used

If the vehicle drifts toward either the left or right lane line due to the system applying torque, turn off the LKAS and have your vehicle checked by a dealer.

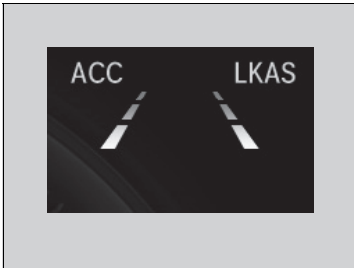

3. Keep your vehicle near the center of the lane while driving.
 - ▶ The dotted outer lines change to solid ones once the system starts operating after detecting the left and right lane markings.

To Cancel

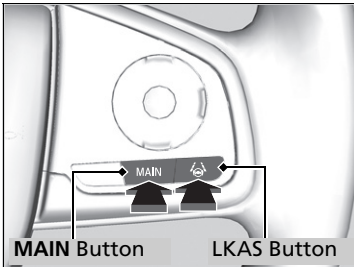

To cancel the LKAS:
Press the **MAIN** or LKAS button.

The LKAS is turned off every time you stop the engine, even if you turned it on the last time you drove the vehicle.

▶▶ To Cancel

Pressing the **MAIN** button also turns ACC with LSF on and off.



When the LKAS is suspended, the lane lines on the driver information interface change to contour lines, and the beeper sounds (if activated).

■ **The system operation is suspended if you:**

- Set the wipers to continuous operation.
 - ▶ Turning the wipers off resumes the LKAS.

Models with automatic intermittent wipers

- Set the wiper switch to **AUTO** and the wipers operate continuously.
 - ▶ The LKAS resumes when the wipers stop or operate intermittently.

All models

- Decrease the vehicle speed to 40 mph (64 km/h) or less.
 - ▶ Increasing the vehicle speed to 45 mph (72 km/h) or more resumes the LKAS.
- Depress the brake pedal.
 - ▶ The LKAS resumes and starts detecting the lane lines again once you release the brake pedal.

■ **The LKAS may automatically be suspended when:**

- The system fails to detect lane lines.
- The steering wheel is quickly turned.
- You fail to steer the vehicle.
- The vehicle runs on a curved road over the speed limit.
- When driving through a sharp curve.
- When driving at a speed in excess of approximately 90 mph (145 km/h).

Once these conditions no longer exist, the LKAS automatically resumes.

■ The LKAS may automatically be canceled when:

- The camera temperature gets extremely high or low.
- The camera behind the rearview mirror, or the area around the camera, including the windshield, gets dirty.
- When the ABS or VSA® systems engage.

A beeper sounds if the LKAS is automatically canceled.

■ LKAS Conditions and Limitations

The system may not detect lane markings and therefore may not keep the vehicle in the middle of a lane under certain conditions, including the following:

■ Environmental conditions

- Driving in bad weather (rain, fog, snow, etc.).
- Sudden changes between light and dark, such as an entrance or exit of a tunnel.
- There is little contrast between lane lines and the roadway surface.
- Driving into low sunlight (e.g., at dawn or dusk).
- Strong light is reflected onto the roadway.
- Driving in the shadows of trees, buildings, etc.
- Shadows of adjacent objects are parallel to lane markings.
- Roadway objects or structures are misinterpreted as lane markers.
- Reflections on the interior of the front windshield.
- Driving at night or in a dark condition such as a tunnel.

■ **Roadway conditions**

- Driving on a snowy or wet roadway (obscured lane marking, vehicle tracks, reflected lights, road spray, high contrast).
- Driving on a road with temporary lane markings.
- Faint, multiple, or varied lane markings are visible on the roadway due to road repairs or old lane markings.
- The roadway has merging, split, or crossing lines (e.g., such as at an intersection or crosswalk).
- The lane markings are extremely narrow, wide, or changing.
- The vehicle in front of you is driving near the lane lines.
- The road is hilly or the vehicle is approaching the crest of a hill.
- Driving on rough or unpaved roads, or over bumpy surfaces.
- When objects on the road (curb, guard rail, pylons, etc.) are recognized as white lines (or yellow lines).
- Driving on roads with double lines.

■ **Vehicle conditions**

- Headlight lenses are dirty or the headlights are not properly adjusted.
- The outside of the windshield is streaked or blocked by dirt, mud, leaves, wet snow, etc.
- The inside of the windshield is fogged.
- The camera temperature gets too high.
- An abnormal tire or wheel condition (wrong size, varied size or construction, improperly inflated, compact spare tire, etc.).
- The vehicle is tilted due to a heavy load or suspension modifications.

Vehicle Stability Assist (VSA®), aka Electronic Stability Control (ESC), System

VSA® helps to stabilize the vehicle during cornering if the vehicle turns more or less than what was intended. It also assists in maintaining traction on slippery surfaces. It does so by regulating engine output and selectively applying the brakes.

■ VSA® Operation

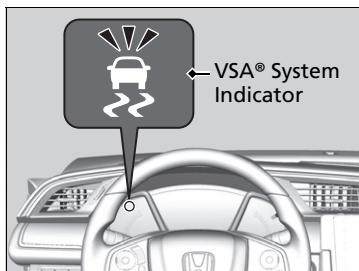

When VSA® activates, you may notice that the engine does not respond to the accelerator. You may also notice some noise from the hydraulic system. You will also see the indicator blink.

▣ Vehicle Stability Assist (VSA®), aka Electronic Stability Control (ESC), System

VSA® may not function properly if tire types and sizes are mixed. Make sure to use the same size and type of tire, and the air pressures are as specified.

When the VSA® system indicator comes on and stays on while driving, there may be a problem with the system. While this may not interfere with normal driving, have your vehicle checked by a dealer immediately.

The indicators for the Vehicle Stability Assist (VSA®) system, Vehicle Stability Assist (VSA®) OFF, Low Tire Pressure/TPMS* and Collision Mitigation Braking System™ (CMBS™)* may come on after re-connecting the battery. Drive a short distance at more than 12 mph (20 km/h). The indicators should go off. If they do not, have your vehicle checked by a dealer.

VSA® cannot enhance stability in all driving situations and does not control the entire braking system. You still need to drive and corner at speeds appropriate for the conditions and always leave a sufficient margin of safety.

The main function of the VSA® system is generally known as Electronic Stability Control (ESC). The system also includes a traction control function.

* Not available on all models

■ VSA® On and Off

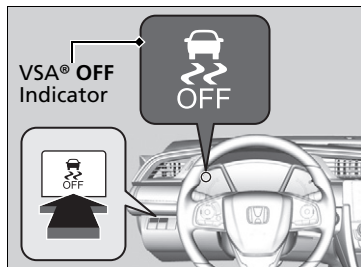

This button is on the driver side control panel. To partially disable VSA® functionality/features, press and hold it until you hear a beep.

Your vehicle will have normal braking and cornering ability, but traction control function will be less effective.

To restore VSA® functionality/features, press the  (VSA® OFF) button until you hear a beep.

VSA® is turned on every time you start the engine, even if you turned it off the last time you drove the vehicle.

▶▶ Vehicle Stability Assist (VSA®), aka Electronic Stability Control (ESC), System

In certain unusual conditions when your vehicle gets stuck in shallow mud or fresh snow, it may be easier to free it with the VSA® temporarily switched off.

When the  button is pressed, the traction control function becomes less effective. This allows for the wheels to spin more freely at low speed. You should only attempt to free your vehicle with the VSA® off if you are not able to free it when the VSA® is on.

Immediately after freeing your vehicle, be sure to switch VSA® on again. We do not recommend driving your vehicle with the VSA® system switched off.

You may hear a motor sound coming from the engine compartment while system checks are being performed immediately after starting the engine or while driving. This is normal.

Agile Handling Assist

Lightly brakes selective wheels, as needed, when you turn the steering wheel, and helps support the vehicle's stability and performance during cornering.

ⓘ Agile Handling Assist

The agile handling assist cannot enhance stability in all driving situations. You still need to drive and corner at speeds appropriate for the conditions and always leave a sufficient margin of safety.

When the VSA® system indicator comes on and stays on while driving, the agile handling assist does not activate.

You may hear a sound coming from the engine compartment while the agile handling assist is activated. This is normal.

Models with SPORT mode

Limited Slip Differential (LSD)

Limited Slip Differential (LSD)

LSD (limited slip differential) is a type of differential that delivers extra torque to the wheel or the wheels with the most traction to minimize wheel slip and maintain control of the vehicle.

» Limited Slip Differential (LSD)

NOTICE

Make sure both front tires of your vehicle are of the same brand and specified size, and have equal wear. Otherwise, the LSD may not function properly.

LaneWatch™*

LaneWatch is an assistance system that allows you to check the passenger side rear areas displayed on the audio/information screen when the turn signal is activated to the passenger's side. A camera in the passenger side door mirror monitors these areas and allows you to check for vehicles, in addition to your visual check and use of the passenger door mirror. You can also keep the system on for your convenience while driving.

1 The system activates when you:

Move the turn signal lever to the passenger side.



Press the LaneWatch button.



The system deactivates when you press the LaneWatch button again.

2 The passenger side view display appears on the audio/information screen.



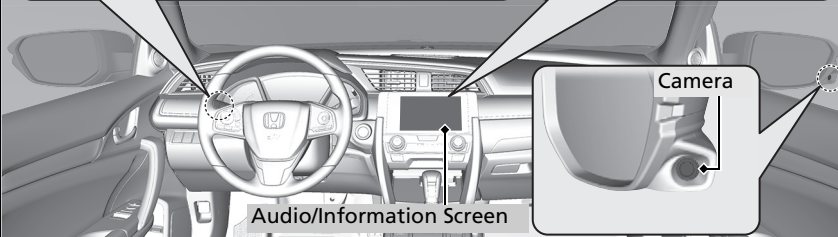

Audio/Information Screen

Camera

ⓘ LaneWatch™*

⚠ WARNING

Failure to visually confirm that it is safe to change lanes before doing so may result in a crash and serious injury or death.

Do not rely only on LaneWatch while driving.

Always look in your mirrors, to either side of your vehicle, and behind you for other vehicles before changing lanes.

Important Safety Reminder

Like all assistance systems, LaneWatch has limitations. Over reliance on LaneWatch may result in a collision.

The LaneWatch function can be affected by weather, lighting (including headlights and low sun angle), ambient darkness, camera condition, and loading.

The LaneWatch may not provide the intended display of traffic to the side and rear under the following conditions:

- Your vehicle's suspension has been altered, changing the height of the vehicle.
- Your tires are over or under inflated.
- Your tires or wheels are of varied size or construction.

* Not available on all models

■ Customizing the LaneWatch settings

You can customize the following items using the audio/information screen.

- **Show with Turn Signal:** Selects whether LaneWatch monitor comes on when you operate the turn signal light lever.
- **Display Time after Turn Signal Off:** Changes the length of time the LaneWatch display stays on after you pull the turn signal lever back.
- **Reference Line:** Selects whether the reference lines appear on the LaneWatch monitor.
- **Display:** Allows for display adjustments of items, such as brightness, contrast and black level. This setting is part of the **System** setup group.

📄 **Customized Features** P. 316

■ Reference Lines

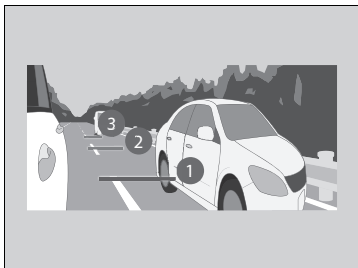

Three lines that appear on the screen can give an idea of how far the vehicles or objects on the screen are from your vehicle, respectively. If an object is near line 1 (in red), it indicates that it is close to your vehicle whereas an object near line 3 farther away.

📄 LaneWatch™*

The LaneWatch camera view is restricted. Its unique lens makes objects on the screen look slightly different from what they are.

LaneWatch display does not come on when the shift lever is in **R**.

For proper LaneWatch operation:

- The camera is located in the passenger side door mirror. Always keep this area clean. If the camera lens is covered with dirt or moisture, use a soft, moist cloth to keep the lens clean and free of debris.
- Do not cover the camera lens with labels or stickers of any kind.
- Do not touch the camera lens.

📄 Reference Lines

The area around the reference line 1 (red) is very close to your vehicle. As always, make sure to visually confirm the safety of a lane change before changing lanes.

The distance between your vehicle and lines 1, 2 and 3 on the screen vary depending on road conditions and vehicle loading. For example, the reference lines on the screen may seem to appear closer than the actual distances when the rear of your vehicle is more heavily loaded.

Consult a dealer if:

- The passenger side door mirror, or area around it is severely impacted, resulting in changing the camera angle.
- The LaneWatch display does not come on at all.

U.S. models

Tire Pressure Monitoring System (TPMS)

Instead of directly measuring the pressure in each tire, the TPMS on this vehicle monitors and compares the rolling radius and rotational characteristics of each wheel and tire while you are driving to determine if one or more tires are significantly under-inflated. This will cause the low tire pressure/TPMS indicator to come on and a message to appear on the driver information interface*.

TPMS Calibration

You must start TPMS calibration every time you:

- Adjust the pressure in one or more tires.
- Rotate the tires.
- Replace one or more tires.

Before calibrating the TPMS:

- Set the cold tire pressure in all four tires.

➔ **Checking Tires** P. 539

Make sure:

- The vehicle is at a complete stop.

Manual transmission models

- The shift lever is in **N**.

Continuously variable transmission models

- The shift lever is in **P**.

All models

- The ignition switch is in ON **II***1.

*1: Models with the smart entry system have an **ENGINE START/STOP** button instead of an ignition switch.

* Not available on all models

Tire Pressure Monitoring System (TPMS)

The system does not monitor the tires when driving at low speed.

Conditions such as low ambient temperature and altitude change directly affect tire pressure and can trigger the low tire pressure/TPMS indicator to come on.

Tire pressure checked and inflated in:

- Warm weather can become under-inflated in colder weather.
- Cold weather can become over-inflated in warmer weather.

The low tire pressure indicator will not come on as a result of over inflation.

The TPMS may not function properly if tire type and size are mixed. Make sure to use the same size and type of tire.

➔ **Checking and Maintaining Tires** P. 539

The low tire pressure/TPMS indicator may come on with a delay or may not come on at all when:

- You rapidly accelerate, decelerate, or turn the steering wheel.
- You drive on snowy or slippery roads.
- Snow chains are used.

The low tire pressure/TPMS indicator may come on under the following conditions:

- A compact spare tire* is used.
- There is a heavier and uneven load on the tires, such as when towing a trailer, than the condition at calibration.
- Snow chains are used.

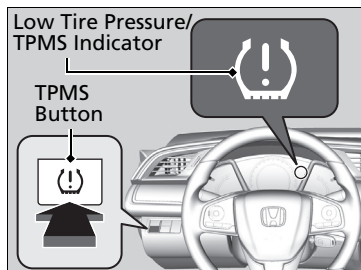

Models with color audio system

Press and hold the TPMS button until the low tire pressure/TPMS indicator blinks twice, indicating the calibration process has begun.

- If the low tire pressure/TPMS indicator does not blink, confirm the above conditions then press and hold the TPMS button again.
- The calibration process finishes automatically.

▶▶ TPMS Calibration

- TPMS cannot be calibrated if a compact spare tire* is installed.
- The calibration process requires approximately 30 minutes of cumulative driving at speeds between 30-65 mph (48-105 km/h).
- During this period, if the ignition switch is turned to ON (II)*¹ and the vehicle is not moved within 45 seconds, you may notice the low tire pressure indicator comes on briefly. This is normal and indicates that the calibration process is not yet complete.

If the snow chains are installed, remove them before calibrating the TPMS.

If the low tire pressure/TPMS indicator comes on even when the properly inflated specified regular tires are installed, have your vehicle checked by a dealer.

We recommend that the tires be replaced with the same brand, model, and size as the originals. Ask a dealer for details.

The indicators for the Vehicle Stability Assist (VSA®) system, Vehicle Stability Assist (VSA®) OFF, Low Tire Pressure/TPMS and Collision Mitigation Braking System™ (CMBS™)* may come on after re-connecting the battery. Drive a short distance at more than 12 mph (20 km/h). The indicators should go off. If they do not, have your vehicle checked by a dealer.

*1: Models with the smart entry system have an **ENGINE START/STOP** button instead of an ignition switch.

* Not available on all models

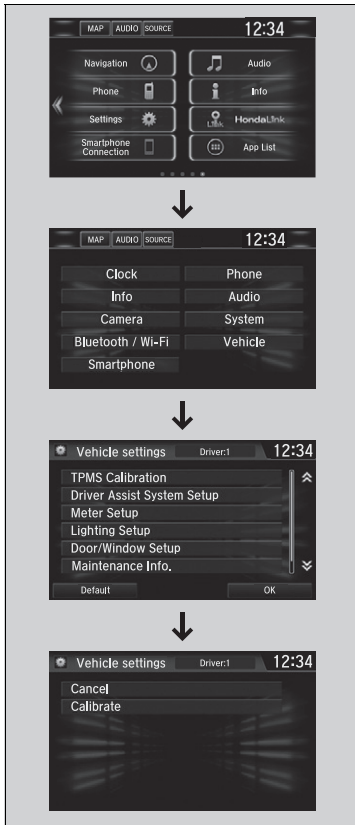

Models with Display Audio

You can calibrate the system from the customized feature on the audio/information screen.

1. Select **HOME**.
2. Select **Settings**.
3. Select **Vehicle**.
4. Select **TPMS Calibration**.
5. Select **Cancel** or **Calibrate**.
 - ▶ When the calibration is complete, the display returns to the customization menu screen.

- If the **Calibration Failed To Start** message appears, repeat steps 3-5.
- The calibration process finishes automatically.

U.S. models

Tire Pressure Monitoring System (TPMS) - Required Federal Explanation

Each tire, including the spare (if provided), should be checked monthly when cold and inflated to the inflation pressure recommended by the vehicle manufacturer on the vehicle placard or tire inflation pressure label.

(If your vehicle has tires of a different size than the size indicated on the vehicle placard or tire inflation pressure label, you should determine the proper tire inflation pressure for those tires.)

As an added safety feature, your vehicle has been equipped with a tire pressure monitoring system (TPMS) that illuminates a low tire pressure telltale



when one or more of your tires is significantly under-inflated.

Accordingly, when the low tire pressure telltale illuminates, you should stop and check your tires as soon as possible, and inflate them to the proper pressure.

Driving on a significantly under-inflated tire causes the tire to overheat and can lead to tire failure. Under-inflation also reduces fuel efficiency and tire tread life, and may affect the vehicle's handling and stopping ability.

Please note that the TPMS is not a substitute for proper tire maintenance, and it is the driver's responsibility to maintain correct tire pressure, even if under-inflation has not reached the level to trigger illumination of the TPMS low tire pressure telltale.

Your vehicle has also been equipped with a TPMS malfunction indicator to indicate when the system is not operating properly. The TPMS malfunction indicator is combined with the low tire pressure telltale. When the system detects a malfunction, the telltale will flash for approximately one minute and then remain continuously illuminated. This sequence will continue upon subsequent vehicle start-ups as long as the malfunction exists.

When the malfunction indicator is illuminated, the system may not be able to detect or signal low tire pressure as intended.

TPMS malfunctions may occur for a variety of reasons, including the installation of replacement or alternate tires or wheels on the vehicle that prevent the TPMS from functioning properly.

Always check the TPMS malfunction telltale after replacing one or more tires or wheels on your vehicle to ensure that the replacement or alternate tires and wheels allow the TPMS to continue to function properly.

Brake System

■ Parking Brake

Use the parking brake to keep the vehicle stationary when parked. When the parking brake is applied, you can manually or automatically release it.



■ To apply

The electric parking brake can be applied any time the vehicle has battery, no matter which position the ignition switch*¹ is in.

Pull the electric parking brake switch up gently and securely.

- ▶ The parking brake and brake system indicator comes on.



■ To release

The ignition switch must be ON **II***¹ in order to release the electric parking brake.

1. Depress the brake pedal.
2. Press the electric parking brake switch.
 - ▶ The parking brake and brake system indicator goes off.

Manually releasing the parking brake using the switch helps your vehicle start slowly and smoothly when facing down hill on steep hills.

⊞ Parking Brake

You may hear the electric parking brake system motor operating from the rear wheel area when you apply or release the parking brake, or turn the ignition switch to LOCK **0***¹. This is normal.

The brake pedal may slightly move due to the electric parking brake system operation when you apply or release the parking brake. This is normal.

You cannot apply or release the parking brake if the battery goes dead.

▶ **Jump Starting** P. 585

If you pull up and hold the electric parking brake switch while driving, the brakes on all four wheels are applied by the VSA® system until the vehicle comes to a stop. The electric parking brake then applies, and the switch should be released.

In the following situations, the parking brake automatically operates.

- When your vehicle is stopped with the automatic brake hold system activated for more than 10 minutes.
- When the driver's seat belt is unfastened while your vehicle is stopped and the brake hold system is applied.
- When the engine is turned off while the brake hold system is applied.
- When there is a problem with the brake hold system while brake hold is applied.

Models with ACC with LSF

- When your vehicle is stopped for more than 10 minutes while ACC with LSF is activated.

*1: Models with the smart entry system have an **ENGINE START/STOP** button instead of an ignition switch.

■ To release automatically

Use the accelerator pedal to release the parking brake when you are starting the vehicle facing uphill, or in a traffic jam.

Continuously variable transmission models

Depressing the accelerator pedal releases the parking brake.

Manual transmission models

Depress the accelerator pedal while releasing the clutch pedal releases the parking brake.

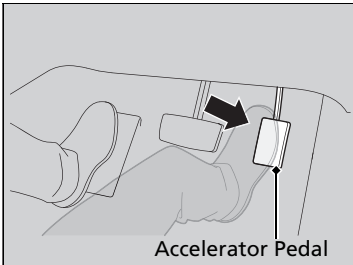

Continuously variable transmission models

Gently depress the accelerator pedal.

- ▶ The parking brake and brake system indicator goes off.

Manual transmission models

Gently depress the accelerator pedal and release the clutch pedal.

- ▶ The parking brake and brake system indicator goes off.

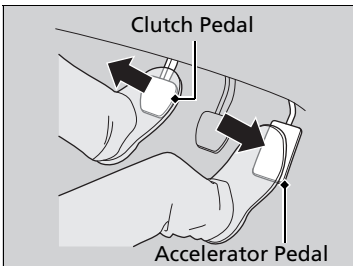

⌘ Parking Brake

- When the driver's seat belt is unfastened while your vehicle is stopped automatically by ACC with LSF.
- When the engine is turned off while ACC with LSF is activated.

Manual transmission models

- When there is a problem with the electric parking brake switch, after you turn the ignition switch to LOCK [0]*1.

If the parking brake cannot be released automatically, release it manually.

When the vehicle is travelling uphill, the accelerator pedal may need to be pressed farther to automatically release the electric parking brake.

The parking brake cannot be released automatically while the following indicators are on:

- Malfunction indicator lamp
- Transmission system indicator

The parking brake may not be released automatically while the following indicators are on:

- Parking brake and brake system indicator
- VSA® system indicator
- **ABS** indicator
- Supplemental restraint system indicator

Manual transmission models

The clutch pedal must be fully depressed before gently depressing the accelerator pedal and releasing the clutch pedal.

The parking brake automatically releases as you depress the accelerator pedal when:

- You are wearing the driver's seat belt.
- The engine is running.

Continuously variable transmission models

- The transmission is not in **P** or **N**.

Manual transmission models

- The transmission is not in **N**.

Foot Brake

Your vehicle is equipped with disc brakes at all four wheels. A vacuum power assist helps to reduce the effort needed on the brake pedal. The brake assist system increases the stopping force when you depress the brake pedal hard in an emergency situation. The anti-lock brake system (ABS) helps you retain steering control when braking very hard.

➤ **Brake Assist System** P. 481

➤ **Anti-lock Brake System (ABS)** P. 480

Foot Brake

Check the brakes after driving through deep water, or if there is a buildup of road surface water. If necessary, dry the brakes by lightly depressing the pedal several times.

If you hear a continuous metallic friction sound when applying the brakes, this is caused by the brake wear indicator rubbing on the brake rotor and indicates that the brake pads need to be replaced. Have the vehicle checked by a dealer. If you hear only an occasional squeak or squeal when you initially apply the brake pedal, this may be normal and caused by high frequency vibration of the brake pads against the rotating brake disc.





Constantly using the brake pedal while going down a long hill builds up heat, which reduces the brake effectiveness. Apply engine braking by taking your foot off the accelerator pedal and downshifting to a lower gear/speed position. With manual transmission use a lower gear for greater engine braking.

Do not rest your foot on the brake pedal while driving, as it will lightly apply the brakes and cause them to lose effectiveness over time and reduce pad life. It will also confuse drivers behind you.

Automatic Brake Hold

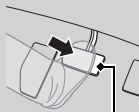
Continuously variable transmission models

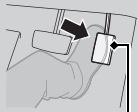
Keeps the brake applied after releasing the brake pedal until the accelerator pedal is pressed. You can use this system while the vehicle is temporarily stopped, like at traffic lights and in heavy traffic.

■ Turning on the system	■ Activating the system	■ Canceling the system
 <p>Automatic Brake Hold Button</p>	 <p>Brake Pedal</p> 	 <p>Accelerator Pedal</p> 
<p>Fasten your seat belt properly, then start the engine. Press the automatic brake hold button.</p> <ul style="list-style-type: none"> The automatic brake hold system indicator comes on. The system is turned on. 	<p>Depress the brake pedal to come to a complete stop. The shift lever must not be in P or R.</p> <ul style="list-style-type: none"> The automatic brake hold indicator comes on. Braking is kept for up to 10 minutes. Release the brake pedal after the automatic brake hold indicator comes on. 	<p>Depress the accelerator pedal while the shift lever is in a position other than P or N. The brake hold is disengaged and the vehicle starts to move.</p> <ul style="list-style-type: none"> The automatic brake hold indicator goes off. The system releases the brake automatically.

Automatic Brake Hold

⚠ WARNING

Activating the automatic brake hold system on steep hills or slippery roads may still allow the vehicle to move if you remove your foot from the brake pedal.

If a vehicle unexpectedly moves, it may cause a crash resulting in serious injury or death.

Never activate the automatic brake hold system or rely on it to keep a vehicle from moving when stopped on a steep hill or slippery roads.

⚠ WARNING

Using the automatic brake hold system to park the vehicle may result in the vehicle unexpectedly moving.

If a vehicle moves unexpectedly, it may cause a crash, resulting in serious injury or death.



Never leave the vehicle when braking is temporarily kept by automatic brake hold and always park the vehicle by putting the transmission in **P** and applying the parking brake.

Manual transmission models

Keeps the brake applied after releasing the brake pedal until you change a gear to a position other than **[N]** and:

- Release the clutch pedal on a level road or when facing downhill.
- Release the clutch pedal and depress the accelerator pedal when facing uphill.

You can use this system while the vehicle is temporarily stopped, like at traffic lights and in heavy traffic.

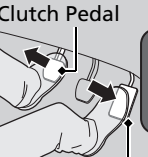
■ Turning on the system	■ Activating the system	■ Canceling the system
 <p>Automatic Brake Hold Button</p> <p>BRAKE HOLD Comes On</p>	 <p>Brake Pedal</p> <p>BRAKE HOLD On HOLD Comes On U.S. (A) Comes On Canada</p>	<p>Clutch Pedal</p>  <p>Accelerator Pedal</p> <p>BRAKE HOLD On : Goes Off</p>
<p>Fasten your seat belt properly, then start the engine. Press the automatic brake hold button.</p> <ul style="list-style-type: none"> • The automatic brake hold system indicator comes on. The system is turned on. 	<p>Depress the brake pedal to come to a complete stop.</p> <ul style="list-style-type: none"> • The automatic brake hold indicator comes on. Braking is kept for up to 10 minutes. • Release the brake pedal after the automatic brake hold indicator comes on. 	<p>Shift into one of the gears other than [N] and:</p> <ul style="list-style-type: none"> • Release the clutch pedal on a level road or when facing downhill. • Release the clutch pedal and depress the accelerator pedal when facing uphill. <p>The system is canceled and the vehicle starts to move.</p> <ul style="list-style-type: none"> • The automatic brake hold indicator goes off. The system releases the brake automatically.

■ **The system automatically cancels when:**

- You engage the parking brake.

Continuously variable transmission models

- You depress the brake pedal and move the shift lever to **P** or **R**.

■ **The system automatically cancels and the parking brake is applied when:**

- Braking is kept for more than 10 minutes.
- The driver's seat belt is unfastened.
- The engine is turned off.
- There is a problem with automatic brake hold system.
- The battery is disconnected.

Manual transmission models

- The engine stalls.

■ **Turning off the automatic brake hold system**

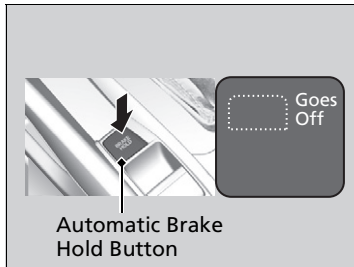

While the system is on, press the automatic brake hold button again.

- ▶ The automatic brake hold system indicator goes off.

If you want to turn off automatic brake hold while the system is in operation, press the automatic brake hold button with the brake pedal depressed.

⌘ **Automatic Brake Hold**

While the system is activated, you can turn off the engine or park the vehicle through the same procedure as you normally do.

➤ **When Stopped** P. 490

Whether the system is on, or the system is activated, the automatic brake hold turns off once the engine is off.

Manual transmission models

The system turns off if the engine stalls while automatic brake hold is active or the system is on.

⌘ **Turning on the system**

Make sure to turn off the automatic brake hold system before using an automated car wash.

You may hear an operating noise if the vehicle moves while the automatic brake hold system is in operation. The system generates sound while holding the vehicle and it moves.

Anti-lock Brake System (ABS)

■ ABS

Helps prevent the wheels from locking up, and helps you retain steering control by pumping the brakes rapidly, much faster than you.

The electronic brake distribution (EBD) system, which is part of the ABS, also balances the front-to-rear braking distribution according to vehicle loading.

You should never pump the brake pedal. Let the ABS work for you by always keeping firm, steady pressure on the brake pedal. This is sometimes referred to as “stomp and steer.”

■ ABS operation

The brake pedal may pulsate slightly when the ABS is working. Keep holding the pedal firmly down. On dry pavement, you will need to press on the brake pedal very hard before the ABS activates. However, you may feel the ABS activate immediately if you are trying to stop on snow or ice.

ABS may activate when you depress the brake pedal when driving on:

- Wet or snow covered roads.
- Roads paved with stone.
- Roads with uneven surfaces, such as potholes, cracks, manholes, etc.

When the vehicle speed goes under 6 mph (10 km/h), the ABS stops.

►► Anti-lock Brake System (ABS)

NOTICE

The ABS may not function correctly if you use a tire of the wrong size or type.

If the **ABS** indicator comes on while driving, there may be a problem with the system. While normal braking will not be affected, there is a possibility that the ABS will not operating. Have the vehicle checked by a dealer immediately.

The ABS is not designed for the purpose of reducing the time or distance it takes for a vehicle to stop: It is designed to limit brake lockup which can lead to skidding and loss of steering control.

In the following cases, your vehicle may need more distance to stop than a vehicle without the ABS:

- You are driving on rough or uneven road surfaces, such as gravel or snow.
- The tires are equipped with snow chains.

The following may be observed with the ABS system:

- Motor sounds coming from the engine compartment when the brakes are applied, or when system checks are being performed after the engine has been started and while vehicle is accelerates.
- Brake pedal and/or the vehicle body vibration when ABS activates.

These vibrations and sounds are normal to ABS systems and are no cause for concern.

Brake Assist System

■ Brake Assist System

Designed to assist the driver by generating greater braking force when you depress the brake pedal hard during emergency braking.

■ Brake assist system operation

Press the brake pedal firmly for more powerful braking.

When brake assist operates, the pedal may wiggle slightly and an operating noise may be heard. This is normal. Keep holding the brake pedal firmly down.

Collision Mitigation Braking System™ (CMBS™)*

Can assist you when there is a possibility of your vehicle colliding with a vehicle or a pedestrian detected in front of yours. The CMBS™ is designed to alert you when a potential collision is determined, as well as to reduce your vehicle speed to help minimize collision severity when a collision is deemed unavoidable.

■ How the system works

When to use

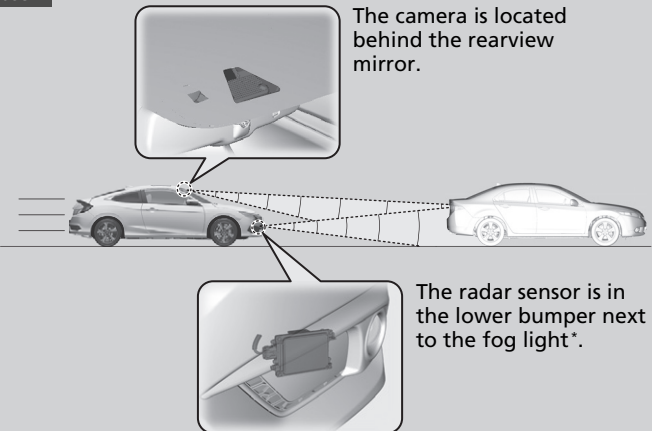

The camera is located behind the rearview mirror.

The radar sensor is in the lower bumper next to the fog light*.

The system starts monitoring the roadway ahead when your vehicle speed is about 3 mph (5 km/h) and there is a vehicle in front of you.

The CMBS™ activates when:

- The speed difference between your vehicle and a vehicle or pedestrian detected in front of you becomes about 3 mph (5 km/h) and over with a chance of a collision.
- Your vehicle speed is about 62 mph (100 km/h) or less and there is a chance of a collision with an oncoming detected vehicle or a pedestrian in front of you.

►► Collision Mitigation Braking System™ (CMBS™)*

Important Safety Reminder

The CMBS™ is designed to reduce the severity of an unavoidable collision. It does not prevent collision nor stop the vehicle automatically. It is still your responsibility to operate the brake pedal and steering wheel appropriately according to the driving conditions.

The CMBS™ may not activate or may not detect a vehicle in front of your vehicle under certain conditions:

► **CMBS™ Conditions and Limitations** P. 486

You can read about handling information for the camera equipped with this system.

► **Front Sensor Camera*** P. 436

Be careful not to have the radar sensor cover strongly impacted.

►► How the system works

Rapid vibrations on the steering wheel alert you when your vehicle speed is between 19 and 62 mph (30 and 100 km/h) with an oncoming vehicle detected in front of you.

When the CMBS™ activates, it may automatically apply the brake. It will be canceled when your vehicle stops or a potential collision is not determined.

■ When the system activates

The system provides visual, audible and tactile alerts of a possible collision, and stops if the collision is avoided.

- ▶ Take appropriate action to prevent a collision (apply the brakes, change lanes, etc.)

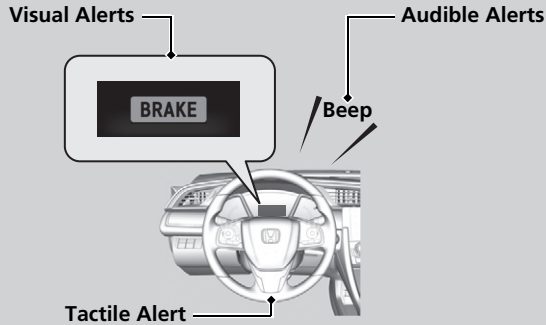

At system's earliest collision alert stage, you can change the distance (**Long/Normal/Short**) between vehicles at which alerts will come on through audio/information screen setting options.

- ▶ **List of customizable options** P. 331

■ Vibration alert on the steering wheel

When a potential collision to an oncoming detected vehicle is determined, the system alerts you with rapid vibration on the steering wheel, in addition to visual and audible alerts.

- ▶ Take appropriate action to prevent a collision (apply the brakes, operate the steering wheel, etc.).

▶▶ When the system activates

The camera in the CMBS™ is also designed to detect pedestrians.

However, this pedestrian detection feature may not activate or may not detect a pedestrian in front of your vehicle under certain conditions. Refer to the ones indicating the pedestrian detection limitations from the list.

- ▶ **CMBS™ Conditions and Limitations** P. 486



▶▶ Vibration alert on the steering wheel

Vibration alert function is disabled when the electric power steering (EPS) system indicator comes on.

- ▶ **Electric Power Steering (EPS) System Indicator** P. 83

■ Collision Alert Stages

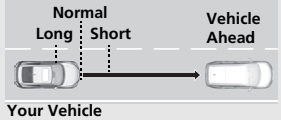
The system has three alert stages for a possible collision. However, depending on circumstances, the CMBS™ may not go through all of the stages before initiating the last stage.

Distance between vehicles	CMBS™			
	The radar sensor detects a vehicle	Audible & Visual WARNINGS	Steering Wheel	Braking
Stage one 	There is a risk of a collision with the vehicle ahead of you.	When in Long , visual and audible alerts come on at a longer distance from a vehicle ahead than in Normal setting, and in Short , at a shorter distance than in Normal .	In case of an oncoming vehicle detected, rapid vibration is provided.	—
Stage two 	The risk of a collision has increased, time to respond is reduced.	Visual and audible alerts.	—	Lightly applied
Stage three 	The CMBS™ determines that a collision is unavoidable.			Forcefully applied

Driving

■ CMBS™ On and Off

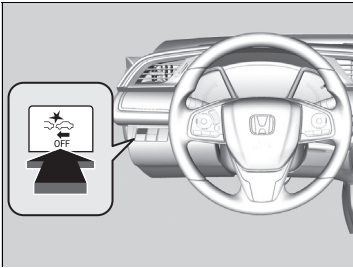

Press and hold the button until the beeper sounds to switch the system on or off.

When the CMBS™ is off:

- The CMBS™ indicator in the instrument panel comes on.
- A message on the driver information interface reminds you that the system is off.

The CMBS™ is in the previously selected ON or OFF setting each time you start the engine.

⊠ Collision Mitigation Braking System™ (CMBS™)*

The CMBS™ may automatically shut off, and the CMBS™ indicator will come and stay on under certain conditions:

➤ **CMBS™ Conditions and Limitations** P. 486

The indicators for the Vehicle Stability Assist (VSA®) system, Vehicle Stability Assist (VSA®) OFF, Low Tire Pressure/TPMS* and Collision Mitigation Braking System™ (CMBS™) may come on after re-connecting the battery. Drive a short distance at more than 12 mph (20 km/h). The indicators should go off. If they do not, have your vehicle checked by a dealer.

* Not available on all models

■ CMBS™ Conditions and Limitations

The system may automatically shut off and the CMBS™ indicator will come on under certain conditions. Some examples of these conditions are listed below. Other conditions may reduce some of the CMBS™ functions.

➤ **Front Sensor Camera*** P. 436

■ Environmental conditions

- Driving in bad weather (rain, fog, snow, etc.).
- Sudden changes in ambient light, such as an entrance or exit of a tunnel.
- There is little contrast between objects and the background.
- Driving into low sunlight (e.g., at dawn or dusk).
- Strong light is reflected onto the roadway.
- Driving in the shadows of trees, buildings, etc.
- Roadway objects or structures are misinterpreted as vehicles and pedestrians.
- Reflections on the interior of the windshield.
- Driving at night or in a dark condition such as a tunnel.

■ Roadway conditions

- Driving on a snowy or wet roadway (obscured lane marking, vehicle tracks, reflected lights, road spray, high contrast on a snowy or wet roadway).
- Driving on curvy, winding, or undulating roads.
- The road is hilly or the vehicle is approaching the crest of a hill.

☒ CMBS™ Conditions and Limitations

Do not put a sticker on the radar sensor cover or replace the radar sensor cover.

If you need the radar sensor to be repaired, or removed, or the radar sensor cover is strongly impacted, turn off the system by pressing the CMBS™ off button and take your vehicle to a dealer.

■ Vehicle conditions

- Headlight lenses are dirty or the headlights are not properly adjusted.
- The outside of the windshield is blocked by dirt, mud, leaves, wet snow, etc.
- The inside of the windshield is fogged.
- An abnormal tire or wheel condition (wrong size, varied size or construction, improperly inflated, compact spare tire, etc.).
- When tire chains are installed.
- The vehicle is tilted due to a heavy load or suspension modifications.
- The camera temperature gets too high.
- Driving with the parking brake applied.
- When the radar sensor in the lower bumper gets dirty.

■ Detection limitations

- A vehicle or pedestrian suddenly crosses in front of you.
- The distance between your vehicle and the vehicle or pedestrian ahead of you is too short.
- A vehicle cuts in front of you at a slow speed, and it brakes suddenly.
- When you accelerate rapidly and approach the vehicle or pedestrian ahead of you at high speed.
- The vehicle ahead of you is a motorcycle, bicycle, mobility scooter or other small vehicle.
- When there are animals in front of your vehicle.
- When you drive on a curved, winding or undulating road that makes it difficult for the sensor to properly detect a vehicle in front of you.
- The speed difference between your vehicle and a vehicle or pedestrian in front of you is significantly large.
- An oncoming vehicle suddenly comes in front of you.
- Another vehicle suddenly comes in front of you at an intersection, etc.
- Your vehicle abruptly crosses over in front of an oncoming vehicle.
- When driving through a narrow iron bridge.
- When the lead vehicle suddenly slows down.

Limitations applicable to pedestrian detection only

- When there is a group of people in front of your vehicle walking together side by side.
- Surrounding conditions or belongings of the pedestrian alter the pedestrian's shape, preventing the system from recognizing that the person is a pedestrian.
- When the pedestrian is shorter than about 3.3 feet (1 meter) or taller than about 6.6 feet (2 meters) in height.
- When a pedestrian blends in with the background.
- When a pedestrian is bent over or squatting, or when their hands are raised or they are running.
- When several pedestrians are walking ahead in a group.
- When the camera cannot correctly identify that a pedestrian is present due to an unusual shape (holding luggage, body position, size).

■ Automatic shutoff

The CMBS may automatically shut itself off and the CMBS indicator comes and stays on when:

- The temperature inside the system is high.
- You drive off-road or on a mountain road, or curved and winding road for an extended period.
- An abnormal tire condition is detected (wrong tire size, flat tire, etc.).
- The camera behind the rearview mirror, or the area around the camera, including the windshield, gets dirty.

Once the conditions that caused the CMBS to shut off improve or are addressed (e.g., cleaning), the system comes back on.

■ With Little Chance of a Collision

The CMBS™ may activate even when you are aware of a vehicle ahead of you, or when there is no vehicle ahead. Some examples of this are:

■ When Passing

Your vehicle approaches another vehicle ahead of you and you change lanes to pass.

■ At an intersection

Your vehicle approaches or passes another vehicle that is making a left or right turn.

■ On a curve

When driving through curves, your vehicle comes to a point where an oncoming vehicle is right in front of you.

■ Through a low bridge at high speed

You drive under a low or narrow bridge at high speed.

■ Speed bumps, road work sites, train tracks, roadside objects, etc.

You drive over speed bumps, steel road plates, etc., or your vehicle approaches train tracks or roadside objects (such as a traffic sign and guard rail) on a curve or, when parking, stationary vehicles and walls.

▣ Collision Mitigation Braking System™ (CMBS™)*

For the CMBS™ to work properly:

Always keep the radar sensor cover clean.

Never use chemical solvents or polishing powder for cleaning the sensor cover. Clean it with water or a mild detergent.

Do not paint, or apply any coverings or paint to the radar sensor area. This can impact CMBS™ operation.

If you need the radar sensor to be repaired, or removed, or the radar sensor cover is strongly impacted, turn off the system by pressing the CMBS™ off button and take your vehicle to a dealer.

Have your vehicle checked by a dealer if you find any unusual behavior of the system (e.g., the warning message appears too frequently).

If the front of the vehicle is impacted in any of the following situations, the radar sensor may not work properly. Have your vehicle checked by a dealer:

- The vehicle mounted onto a bump, curb, chock, embankment, etc.
- You drive the vehicle where the water is deep.
- Your vehicle has a frontal collision.

* Not available on all models

When Stopped

1. Depress the brake pedal firmly.
2. With the brake pedal depressed, pull up the electric parking brake switch slowly, but fully.

Continuously variable transmission models

3. Move the shift lever from **D** to **P**.

Manual transmission models

3. Move the shift lever to **R** or **1**.

All models

4. Turn off the engine.
 - ▶ The parking brake and brake system indicator goes off in about 15 seconds.

Always confirm the electric parking brake is set, in particular if you are parked on an incline.

▶ Parking Your Vehicle

Do not park your vehicle near flammable objects, such as dry grass, oil, or timber. Heat from the exhaust can cause a fire.

▶ When Stopped

NOTICE

Continuously variable transmission models

The following can damage the transmission:

- Depressing the accelerator and brake pedals simultaneously.
- Holding the vehicle in place when facing uphill by depressing the accelerator pedal.
- Moving the shift lever into **P** before the vehicle stops completely.

In extremely cold temperatures, the parking brake may freeze up if applied. If such temperatures are expected, do not apply the parking brake but, if parking on a slope, either turn the front wheels so they will contact the curb if the vehicle rolls down the slope or block the wheels to keep the vehicle from moving. If you do not take either precaution, the vehicle may roll unexpectedly, leading to a crash.

About Your Multi-View Rear Camera

The audio/information screen can display your vehicle's rear view.

The display automatically changes to a rear view when the transmission is put into **R**.

Multi-View Rear Camera Display Area

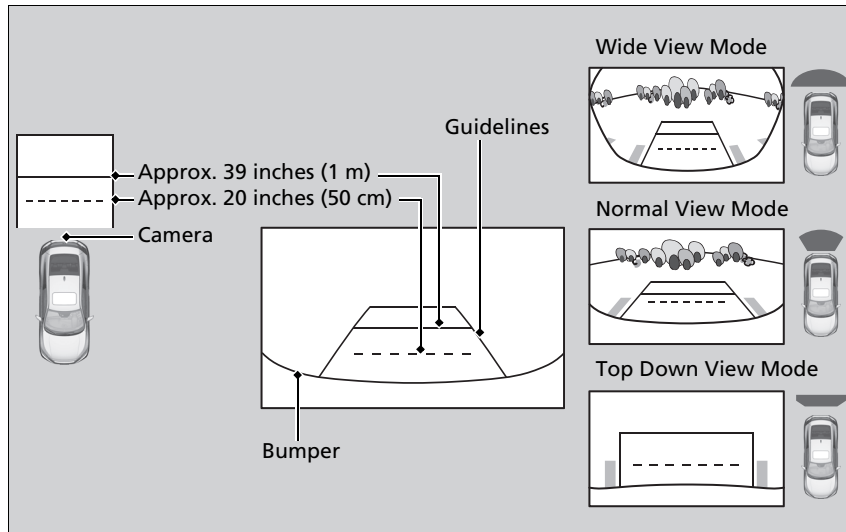

About Your Multi-View Rear Camera

The rear camera view is restricted. You cannot see the corner ends of the bumper or what is underneath the bumper. Its unique lens also makes objects appear closer or farther than they actually are.

Visually confirm that it is safe to drive before backing up. Certain conditions (such as weather, lighting, and high temperatures) may also restrict the rear view. Do not rely on the rearview display which does not give you all information about conditions at the back of your vehicle.

If the camera lens is covered with dirt or moisture, use a soft, moist cloth to keep the lens clean and free of debris.

Models with Display Audio

You can change the **Fixed Guideline** and **Dynamic Guideline** settings.

➤ **Customized Features** P. 316

Fixed Guideline

On: Guidelines appear when you put the transmission into **R**.

Off: Guidelines do not appear.

Dynamic Guideline

On: Guidelines move according to the steering wheel direction.

Off: Guidelines do not move.

You can view three different camera angles on the rearview display.

Models with color audio system

Press the **LIST/SELECT** (selector) knob to switch the angle.

Models with Display Audio

Touch the appropriate icon to switch the angle.

 : Wide view

 : Normal view

 : Top down view

All models

- If the last used viewing mode was Wide or Normal, the same mode is selected the next time you put the transmission into **R**.
- If Top down view was last used before you turned off the engine, Wide View mode is selected next time you turn the ignition switch to ON **II***1 and put the transmission into **R**.
- If Top down view was last used more than 10 seconds after you put the transmission from **R**, Wide View mode is selected the next time you put the transmission into **R**.

*1: Models with the smart entry system have an **ENGINE START/STOP** button instead of an ignition switch.

▶▶ About Your Multi-View Rear Camera

Models with color audio system

You can change the **Camera Guideline** settings.

➔ **Customized Features** P. 316

Camera Guideline

On: Guidelines appear when you put the transmission into **R**.

Off: Guidelines do not appear.

Fuel Information

■ Fuel recommendation

Models without SPORT mode

Unleaded gasoline, pump octane number 87 or higher

Use of a lower octane gasoline can cause a persistent, heavy metallic knocking noise that can lead to engine damage.

Models with SPORT mode

Unleaded premium gasoline, pump octane number 91 or higher

Use of a lower octane gasoline can cause occasional metallic knocking noise in the engine and will result in decreased engine performance.

Use of a gasoline with a pump octane less than 87 can lead to engine damage.

■ Top tier detergent gasoline

Because the level of detergency and additives in gasoline vary in the market, Honda endorses the use of "TOP TIER Detergent Gasoline" where available to help maintain the performance and reliability of your vehicle. TOP TIER Detergent Gasoline meets a new gasoline standard jointly established by leading automotive manufacturers to meet the needs of today's advanced engines.

Qualifying gasoline retailers will, in most cases, identify their gasoline as having met "TOP TIER Detergent Gasoline" standards at the retail location. This fuel is guaranteed to contain the proper level of detergent additives and be free of metallic additives. The proper level of detergent additives, and absence of harmful metallic additives in gasoline, help avoid build-up of deposits in your engine and emission control system.

⌘ Fuel Information

NOTICE

We recommend quality gasoline containing detergent additives that help prevent fuel system and engine deposits. In addition, in order to maintain good performance, fuel economy, and emissions control, we strongly recommend the use of gasoline that does NOT contain harmful manganese-based fuel additives such as MMT, if such gasoline is available.

Use of gasoline with these additives may adversely affect performance, and cause the malfunction indicator lamp on your instrument panel to come on. If this happens, contact a dealer for service. Some gasoline today is blended with oxygenates such as ethanol. Your vehicle is designed to operate on oxygenated gasoline containing up to 15% ethanol by volume. Do not use gasoline containing methanol. If you notice any undesirable operating symptoms, try another service station or switch to another brand of gasoline.

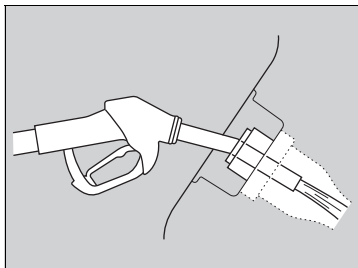

5. Place the end of the filler nozzle on the lower part of filler opening, then insert it slowly and fully.
 - ▶ Make sure that the end of the filler nozzle goes down along with the filler pipe.
 - ▶ Keep the filler nozzle level.
 - ▶ When the tank is full, the filler nozzle will click off automatically.
 - ▶ After filling, wait about five seconds before removing the filler nozzle.
6. Shut the fuel fill door by hand.

How to Refuel

Use the lock tab or the master door lock switch to unlock the fuel fill door.

The vehicle doors and fuel fill door automatically relock if the remote unlock function is used. This can be deactivated by briefly opening then closing the driver's door.

The fuel fill door and its latching mechanism can be permanently damaged if the fuel fill door is forced closed when the driver's door is locked.

The filler nozzle automatically stops to leave space in the fuel tank so that fuel does not overflow as a result of changes in air temperature.

If the filler nozzle keeps turning off when the tank is not full, there may be a problem with the pump's fuel vapor recovery system. Try filling at another pump. If this does not fix the problem, consult a dealer.

Do not continue to add fuel after the nozzle has automatically stopped. Additional fuel can exceed the full tank capacity.

If you have to refuel your vehicle from a portable container, use the funnel provided with your vehicle.

Refueling From a Portable Fuel Container

P. 604

Improving Fuel Economy and Reducing CO₂ Emissions

Achieving fuel economy and reducing CO₂ emissions is dependent on several factors, including driving conditions, load weight, idling time, driving habits, and vehicle condition. Depending on these and other factors, you may not achieve the rated fuel economy of this vehicle.

Maintenance and Fuel Economy

You can optimize your fuel economy with proper maintenance of your vehicle. Always maintain your vehicle in accordance with the messages displayed on the information display*/driver information interface*.

- Use the recommended viscosity engine oil, displaying the API Certification Seal.
- Maintain the specified tire pressure.
- Do not load the vehicle with excess cargo.
- Keep your vehicle clean. A buildup of snow or mud on your vehicle's underside adds weight and increases wind resistance.

Improving Fuel Economy and Reducing CO₂ Emissions

Direct calculation is the recommended method to determine actual fuel consumed while driving.



In Canada, posted fuel economy numbers are established following a simulated test. For more information on how this test is performed, please visit <http://oee.nrcan.gc.ca/>

Handling Precautions

The turbocharger is a high-precision device to obtain greater horsepower by delivering a large volume of compressed air into the engine using a turbine driven by the engine's exhaust gas pressure.

- When the engine is cold just after starting, avoid revving the engine or sudden acceleration.
- Always replace the engine oil and engine oil filter according to the Maintenance Minder. The turbine rotates at very high speeds over 100,000 rpm and its temperature reaches over 1,292°F (700°C). It is lubricated and cooled by engine oil. If you fail to replace the engine oil and filter at the scheduled distance or interval, deteriorated engine oil may cause failure such as sticking and abnormal noise of the turbine bearing.

☒ Turbo Engine Vehicle*

The scheduled maintenance intervals for replacing the filter is indicated on the driver information interface. Follow the information of when to replace them.

☒ **Maintenance Minder™** P. 503

The temperature gauge pointer is at the **[H]** mark when you restart the engine after driving under high load conditions such as at high speed or in hilly terrain. This is normal. The gauge goes down after you idle or drive the vehicle for about one minute.

* Not available on all models

Maintenance

This chapter discusses basic maintenance.



Before Performing Maintenance

Inspection and Maintenance	500
Safety When Performing Maintenance.....	501
Parts and Fluids Used in Maintenance Service	502

Maintenance Minder™	503
----------------------------------	-----

Maintenance Under the Hood

Maintenance Items Under the Hood	512
Opening the Hood	514
Recommended Engine Oil	515
Oil Check	516
Adding Engine Oil	518
Changing the Engine Oil and Oil Filter.....	519

Engine Coolant	522
Transmission Fluid	524
Brake/Clutch * Fluid	525
Refilling Window Washer Fluid.....	526

Replacing Light Bulbs	527
------------------------------------	-----

Checking and Maintaining Wiper Blades	536
--	-----

Checking and Maintaining Tires

Checking Tires	539
Tire and Loading Information Label	540
Tire Labeling	540
DOT Tire Quality Grading (U.S. Vehicles).....	542
Wear Indicators.....	544
Tire Service Life	544

Tire and Wheel Replacement	545
----------------------------------	-----

Tire Rotation	546
---------------------	-----

Winter Tires	547
--------------------	-----

Battery	549
----------------------	-----

Remote Transmitter Care

Replacing the Button Battery	551
------------------------------------	-----

Climate Control System Maintenance	553
---	-----

Cleaning

Interior Care	554
---------------------	-----

Exterior Care.....	556
--------------------	-----

Accessories and Modifications

Accessories	559
-------------------	-----

Modifications.....	560
--------------------	-----

* Not available on all models

Inspection and Maintenance

For your safety, perform all listed inspections and maintenance to keep your vehicle in good condition. If you become aware of any abnormality (noise, smell, insufficient brake fluid, oil residue on the ground, etc.), have your vehicle inspected by a dealer. (Note, however, that service at a dealer is not mandatory to keep your warranties in effect.)

Types of Inspection and Maintenance

■ Daily inspections

Perform inspections before long distance trips, when washing the vehicle, or when refueling.

■ Periodic inspections

- Check the brake/clutch* fluid level monthly.
 - **Brake/Clutch* Fluid** P. 525
- Check the tire pressure monthly. Examine the tread for wear and foreign objects.
 - **Checking and Maintaining Tires** P. 539
- Check the operation of the exterior lights monthly.
 - **Replacing Light Bulbs** P. 527
- Check the condition of the wiper blades at least every six months.
 - **Checking and Maintaining Wiper Blades** P. 536

Inspection and Maintenance

U.S. models

Maintenance, replacement, or repair of emissions control devices and systems may be done by any automotive repair establishment or individuals using parts that are "certified" to EPA standards.

According to state and federal regulations, failure to perform maintenance on the maintenance main items marked with # will not void your emissions warranties. However, all maintenance services should be performed in accordance with the intervals indicated by the information display*/driver information interface*.

➤ **Maintenance Service Items** P. 505, 509

If you want to perform complex maintenance tasks that require more skills and tools, you can purchase a subscription to the Service Express website at www.techinfo.honda.com.

➤ **Authorized Manuals** P. 617

If you want to perform maintenance yourself, make sure that you have the necessary tools and skills first. After performing maintenance, update the records in the separate maintenance booklet.

Safety When Performing Maintenance

Some of the most important safety precautions are given here. However, we cannot warn you of every conceivable hazard that can arise in performing maintenance. Only you can decide whether or not you should perform a given task.

Maintenance Safety

- To reduce the possibility of fire or explosion, keep cigarettes, sparks, and flames away from the battery and all fuel related parts.
- Never leave rags, towels, or other flammable objects under the hood.
 - ▶ Heat from the engine and exhaust can ignite them causing a fire.
- To clean parts, use a commercially available degreaser or parts cleaner, not gasoline.
- Wear eye protection and protective clothing when working with the battery or compressed air.
- Engine exhaust contains carbon monoxide, which is poisonous and can kill you.
 - ▶ Only operate the engine if there is sufficient ventilation.

Vehicle Safety

- The vehicle must be in a stationary condition.
 - ▶ Make sure your vehicle is parked on level ground, the parking brake is set, and the engine is off.
- Be aware that hot parts can burn you.
 - ▶ Make sure to let the engine and exhaust system cool thoroughly before touching vehicle parts.
- Be aware that moving parts can injure you.
 - ▶ Do not start the engine unless instructed, and keep your hands and limbs away from moving parts.

⚠ Safety When Performing Maintenance

⚠ WARNING

Improperly maintaining this vehicle or failing to correct a problem before driving can cause a crash in which you can be seriously hurt or killed.

Always follow the inspection and maintenance recommendations according to the schedules in this owner's manual.

⚠ WARNING

Failure to properly follow maintenance instructions and precautions can cause you to be seriously hurt or killed.

Always follow the procedures and precautions in this owner's manual.

Parts and Fluids Used in Maintenance Service

The use of Honda genuine parts and fluids is recommended when maintaining and servicing your vehicle. Honda genuine parts are manufactured according to the same high quality standards used in Honda vehicles.

If the engine oil life is less than 15%, you will see the Maintenance Minder messages appear on the information display* or the driver information interface* every time you turn the ignition switch to ON **II***1. The messages notify you when to change the engine oil, or when to bring your vehicle to a dealer for indicated maintenance services.

Models with information display

To Use Maintenance Minder™

■ Displaying the Maintenance Minder Information

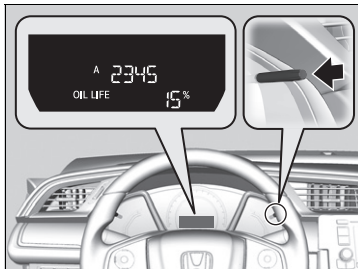

1. Turn the ignition switch to ON **II***1.
2. Press the **(TRIP)** knob repeatedly until the engine oil life appears on the information display.

The Maintenance Minder indicator () stays on in the instrument panel after the engine oil life becomes **0%**. Have the indicated maintenance done by a dealer immediately.

*1: Models with the smart entry system have an **ENGINE START/STOP** button instead of an ignition switch.

* Not available on all models

▣ Displaying the Maintenance Minder Information







Based on the engine operating conditions and oil age, the remaining engine oil life is calculated and displayed as a percentage.

Displayed Engine Oil Life (%)	Calculated Engine Oil Life (%)
100	100 to 91
90	90 to 81
80	80 to 71
70	70 to 61
60	60 to 51
50	50 to 41
40	40 to 31
30	30 to 21
20	20 to 16
15	15 to 11
10	10 to 6
5	5 to 1
0	0

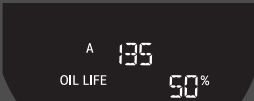
Continued

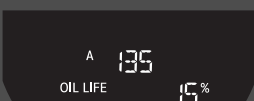
■ Maintenance Minder Messages on the Information Display

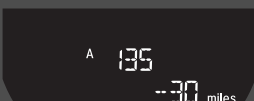
To switch the display, press the  (TRIP) knob.

Oil Life Display	Explanation	Information	Maintenance Minder Indicator
	<p>When you select the Maintenance Minder screen, it displays codes for maintenance items due at the next engine oil change, along with the percentage of engine oil life remaining.</p>		 Comes on for a few seconds when you turn the ignition switch to ON  ^{*1} , then goes off.
	<p>The engine oil life indicator starts to appear along with other due-soon maintenance item codes when the remaining oil life drops to 15 percent.</p>	<p>The engine oil is approaching the end of its service life.</p>	 Starts to come on when the remaining engine oil life drops to 15 percent. It goes off when the display is switched.
	<p>The remaining engine oil has passed its service life, and a negative distance appears after driving over 10 miles (U.S. models) or 10 km (Canadian models). The negative distance on the display blinks.</p>	<p>The engine oil life has passed. The maintenance items must be inspected and serviced immediately.</p>	 Stays on as a reminder even when the display is switched.

*1: Models with the smart entry system have an **ENGINE START/STOP** button instead of an ignition switch.

Maintenance Service Items

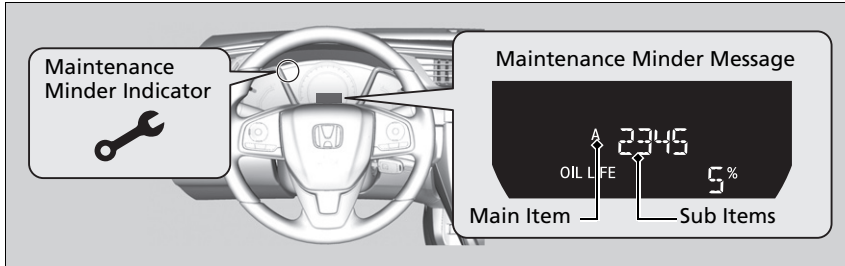

Maintenance Service Items

- Adjust the valves during services A, B, 1, 2, or 3 if they are noisy.

U.S. models

CODE	Maintenance Main Items
A	<ul style="list-style-type: none"> • Replace engine oil*¹
B	<ul style="list-style-type: none"> • Replace engine oil*¹ and oil filter • Inspect front and rear brakes • Inspect these items: <ul style="list-style-type: none"> • Tie rod ends, steering gearbox, and boots • Suspension components • Driveshaft boots • Brake hoses and lines (including ABS/VSA) • All fluid levels and condition of fluids • Exhaust system[#] • Fuel lines and connections[#]

CODE	Maintenance Sub Items
1	<ul style="list-style-type: none"> • Rotate tires
2	<ul style="list-style-type: none"> • Replace air cleaner element*² • Replace dust and pollen filter*³ • Inspect drive belt
3	<ul style="list-style-type: none"> • Replace transmission fluid*⁴
4	<ul style="list-style-type: none"> • Replace spark plugs • Inspect valve clearance
5	<ul style="list-style-type: none"> • Replace engine coolant
7	<ul style="list-style-type: none"> • Replace brake fluid*⁵

*1: If a Maintenance Minder indicator does not appear more than 12 months after the display is reset, change the engine oil every year.

#: See information on maintenance and emissions warranty.

*2: If you drive in dusty conditions, replace the air cleaner element every 15,000 miles (24,000 km).

*3: If you drive primarily in urban areas that have high concentrations of soot in the air from industry and from diesel-powered vehicles, replace the dust and pollen filter every 15,000 miles (24,000 km).

*4: Continuously variable transmission models

Driving in mountainous areas at very low vehicle speeds results in higher transmission temperatures. This requires transmission fluid changes more frequently than recommended by the Maintenance Minder. If you regularly drive your vehicle under these conditions, have the transmission fluid changed every 25,000 miles (40,000 km).

*5: If a Maintenance Minder Indicator does not appear more than 36 months after the display for item 7 is reset, change the brake fluid every 3 years.

Continued

Resetting the Display

Reset the maintenance minder information display if you have performed the maintenance service.

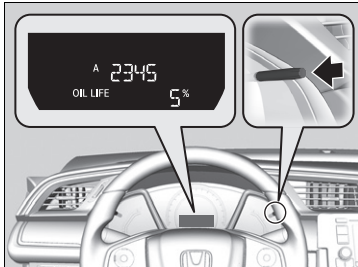

1. Turn the ignition switch to ON **II***1 and have the vehicle at a complete stop.
2. Display the Maintenance Minder by repeatedly pressing the (TRIP) knob.
3. Press and hold the knob for 10 seconds or more.
 - The display will blink to show it is in reset mode.
4. Rotate the knob to select the item you wish to reset.
 - Reset the selected item by pushing the knob for five seconds or more.

Resetting the Display

NOTICE

Failure to reset the Maintenance Minder™ display after a maintenance service results in the system showing incorrect maintenance intervals, which can lead to serious mechanical problems.

The dealer will reset the Maintenance Minder™ display after completing the required maintenance service. If someone other than a dealer performs maintenance service, reset the Maintenance Minder™ display yourself.



*1: Models with the smart entry system have an **ENGINE START/STOP** button instead of an ignition switch.

Models with driver information interface

To Use Maintenance Minder™

■ Displaying the Maintenance Minder Information

Maintenance items, which should be serviced at the same time that you replace the engine oil, appear on the driver information interface. You can view them on the **Maintenance Minder** screen at any time.

1. Turn the ignition switch to ON *1.
2. Press the  button several times until  is displayed.
3. Press **ENTER** to go to the **Maintenance Minder** screen. The engine oil life appears on the driver information interface along with maintenance items due soon.

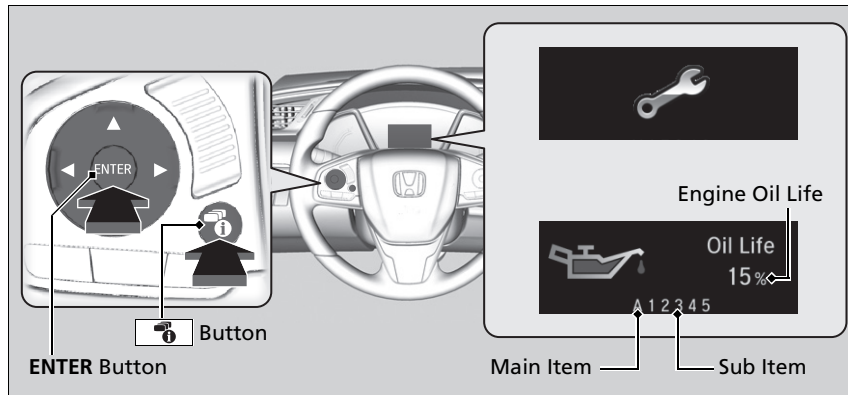

*1: Models with the smart entry system have an **ENGINE START/STOP** button instead of an ignition switch.

▣ Displaying the Maintenance Minder Information







Based on the engine operating conditions and oil age, the remaining engine oil life is calculated and displayed as a percentage.

Displayed Engine Oil Life (%)	Calculated Engine Oil Life (%)
100	100 to 91
90	90 to 81
80	80 to 71
70	70 to 61
60	60 to 51
50	50 to 41
40	40 to 31
30	30 to 21
20	20 to 16
15	15 to 11
10	10 to 6
5	5 to 1
0	0

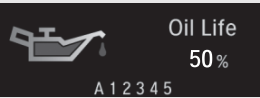
There is a list of maintenance main and sub items you can view on the driver information interface.

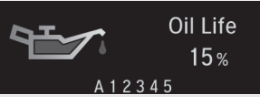
➤ **Maintenance Service Items** P. 509

Maintenance Minder Messages on the Driver Information Interface

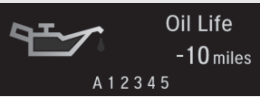
Maintenance Message	Oil Life Display	Explanation	Information
		When you select the Maintenance Minder screen, it displays codes for maintenance items due at the next engine oil change, along with the percentage of engine oil life remaining.	
Maintenance Due Soon  Maintenance Due Soon A 1 2 3 4 5		The engine oil life indicator starts to appear along with other due-soon maintenance item codes when the remaining oil life drops to 15 percent.	The engine oil is approaching the end of its service life.
Maintenance Due Now  Maintenance Due Now A 1 2 3 4 5		The remaining engine oil life is 5 to 1 percent. Press the  button to switch to another display.	The engine oil has almost reached the end of its service life, and the maintenance items should be inspected and serviced as soon as possible.
Maintenance Past Due  Maintenance Past Due 10 miles A 1 2 3 4 5		The engine oil has passed its service life, and a negative distance appears after driving over 10 miles (U.S. models) or 10 km (Canadian models). The negative distance on the display blinks.	The engine oil life has passed. The maintenance items must be inspected and serviced immediately.

The system message indicator (ⓘ) comes on along with the Maintenance Minder message.

Maintenance Service Items

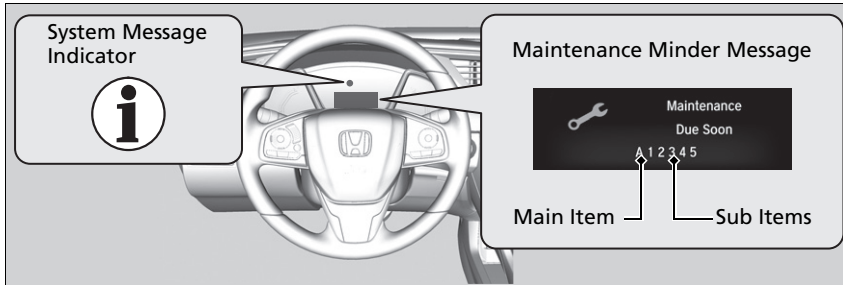

Maintenance Service Items

- Adjust the valves during services A, B, 1, 2, or 3 if they are noisy.

U.S. models

CODE	Maintenance Main Items
A	<ul style="list-style-type: none"> • Replace engine oil*¹
B	<ul style="list-style-type: none"> • Replace engine oil*¹ and oil filter • Inspect front and rear brakes • Check expiration date for temporary tire repair kit bottle (if equipped) • Inspect these items: <ul style="list-style-type: none"> • Tie rod ends, steering gearbox, and boots • Suspension components • Driveshaft boots • Brake hoses and lines (including ABS/VSA) • All fluid levels and condition of fluids • Exhaust system[#] • Fuel lines and connections[#]

*1: If a Maintenance Minder message does not appear more than 12 months after the display is reset, change the engine oil every year.

#: See information on maintenance and emissions warranty.

*2: If you drive in dusty conditions, replace the air cleaner element every 15,000 miles (24,000 km).

CODE	Maintenance Sub Items
1	<ul style="list-style-type: none"> • Rotate tires
2	<ul style="list-style-type: none"> • Replace air cleaner element*² • Replace dust and pollen filter*³ • Inspect drive belt
3	<ul style="list-style-type: none"> • Replace transmission fluid*⁴
4	<ul style="list-style-type: none"> • Replace spark plugs • Inspect valve clearance
5	<ul style="list-style-type: none"> • Replace engine coolant
7	<ul style="list-style-type: none"> • Replace brake fluid*⁵

*3: If you drive primarily in urban areas that have high concentrations of soot in the air from industry and from diesel-powered vehicles, replace the dust and pollen filter every 15,000 miles (24,000 km).

*4: **Continuously variable transmission models**

Driving in mountainous areas at very low vehicle speeds results in higher transmission temperatures. This requires transmission fluid changes more frequently than recommended by the Maintenance Minder. If you regularly drive your vehicle under these conditions, have the transmission fluid changed every 25,000 miles (40,000 km).

*5: If a Maintenance Minder message does not appear more than 36 months after the display for item 7 is reset, change the brake fluid every 3 years.

Continued

Canadian models

» Maintenance Service Items

- Adjust the valves during services A, 0, 9, 1, 2, or 3 if they are noisy.

CODE	Maintenance Main Items
A	• Replace engine oil* ¹
0	• Replace engine oil* ¹ and oil filter

- *1: If a Maintenance Minder message does not appear more than 12 months after the display is reset, change the engine oil every year.
- *2: If you drive in dusty conditions, replace the air cleaner element every 24,000 km (15,000 miles).
- *3: If you drive primarily in urban areas that have high concentrations of soot in the air from industry and from diesel-powered vehicles, replace the dust and pollen filter every 24,000 km (15,000 miles).
- *4: **Continuously variable transmission models**
 Driving in mountainous areas at very low vehicle speeds results in higher transmission temperatures. This requires transmission fluid changes more frequently than recommended by the Maintenance Minder. If you regularly drive your vehicle under these conditions, have the transmission fluid changed every 40,000 km (25,000 miles).
- *5: If a Maintenance Minder message does not appear more than 36 months after the display for item 7 is reset, change the brake fluid every 3 years.
- #: See information on maintenance and emissions warranty.

CODE	Maintenance Sub Items
1	• Rotate tires
2	• Replace air cleaner element* ² • Replace dust and pollen filter* ³ • Inspect drive belt
3	• Replace transmission fluid* ⁴
4	• Replace spark plugs • Inspect valve clearance
5	• Replace engine coolant
7	• Replace brake fluid* ⁵
9	• Service front and rear brakes • Inspect these items: • Tie rod ends, steering gearbox, and boots • Suspension components • Driveshaft boots • Brake hoses and lines (including ABS/VSA) • All fluid levels and condition of fluids • Exhaust system# • Fuel lines and connections#

Resetting the Display

Reset the maintenance minder information display if you have performed the maintenance service.

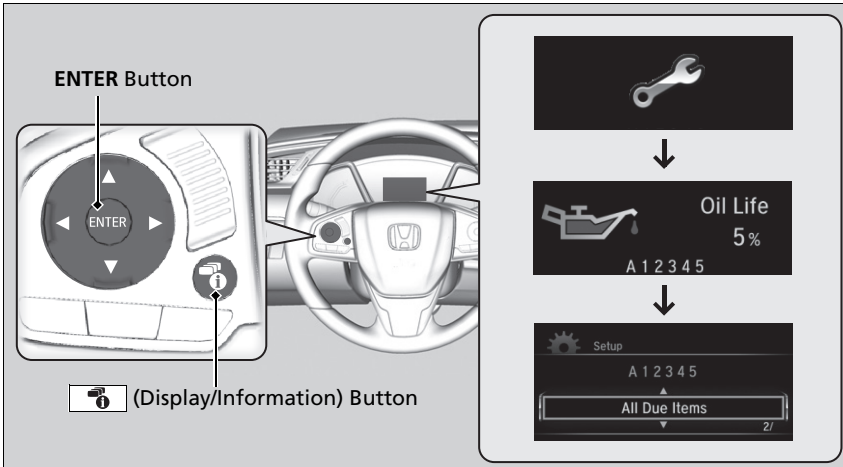

1. Turn the ignition switch to ON *1.
2. Press the (display/information) button repeatedly until the appears.
3. Press the **ENTER** button.
4. Press and hold the **ENTER** button for about 10 seconds to enter the reset mode.
5. Press / to select a maintenance item to reset, or to select **All Due Items** (You can also select **Cancel** to end the process).
6. Press the **ENTER** button to reset the selected item.
7. Repeat from step 4 for other items you wish to reset.

*1: Models with the smart entry system have an **ENGINE START/STOP** button instead of an ignition switch.

Resetting the Display

NOTICE

Failure to reset the Maintenance Minder™ display after a maintenance service results in the system showing incorrect maintenance intervals, which can lead to serious mechanical problems.

The dealer will reset the Maintenance Minder™ display after completing the required maintenance service. If someone other than a dealer performs maintenance service, reset the Maintenance Minder™ display yourself.

Models with Display Audio

You can also reset the Maintenance Minder™ display using the audio/information screen.

➤ **Customized Features** P. 316

Maintenance Items Under the Hood

1.5 L engine models

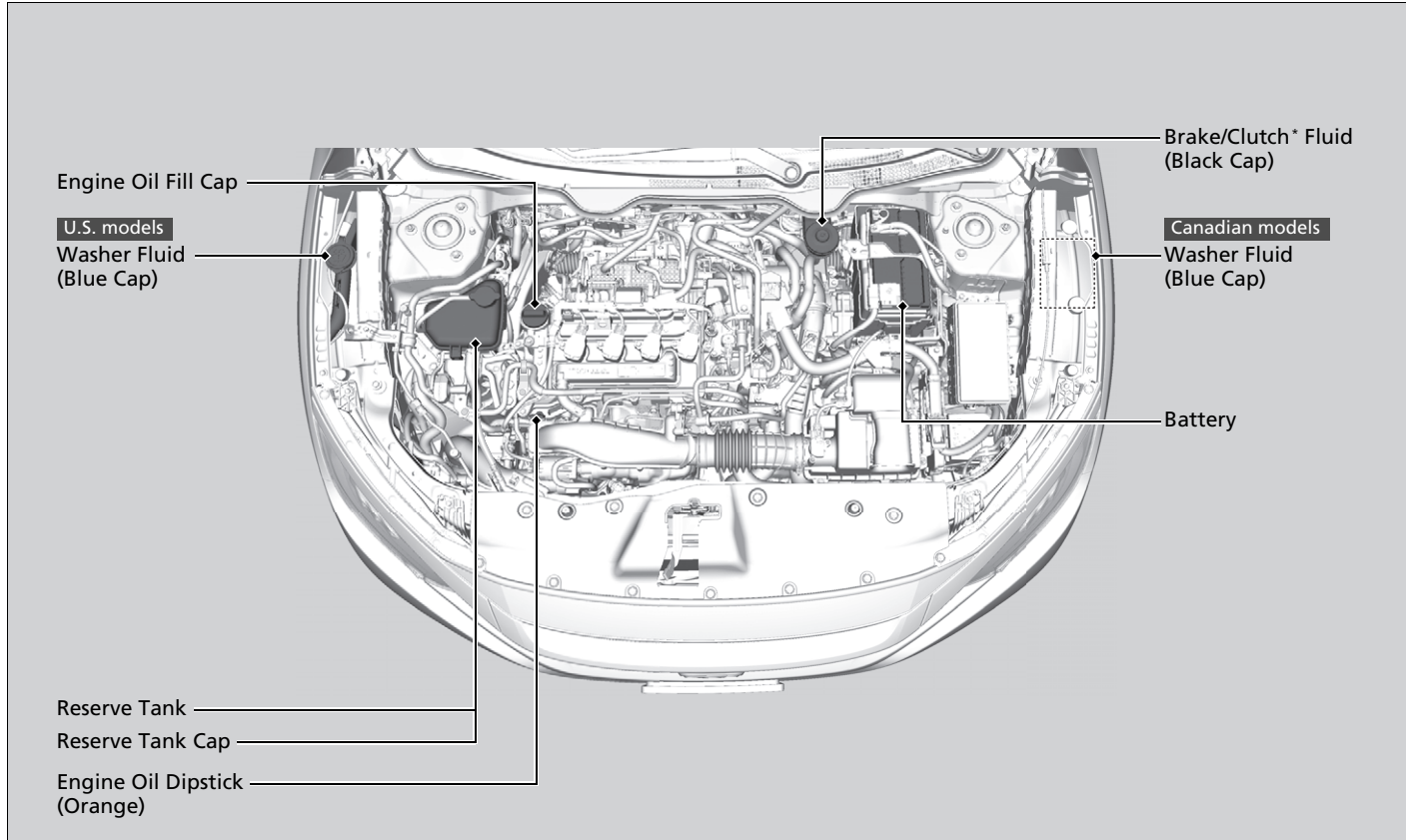

2.0 L engine models

Engine Oil Dipstick
(Orange)

Engine Oil Fill Cap

Washer Fluid
(Blue Cap)

Reserve Tank

Reserve Tank Cap

Brake/Clutch* Fluid
(Black Cap)

Battery

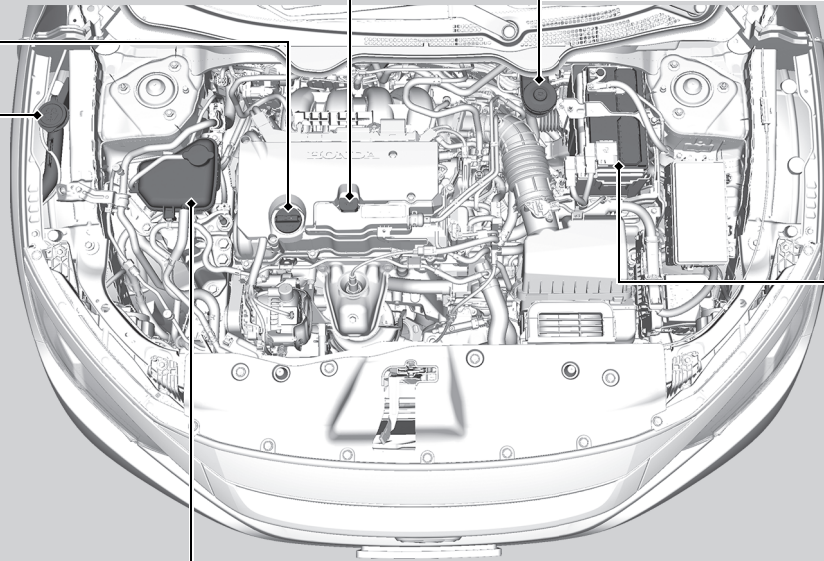

* Not available on all models

Opening the Hood

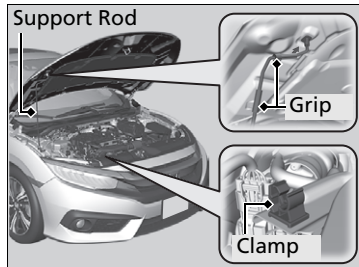
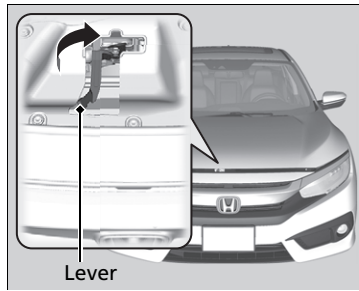
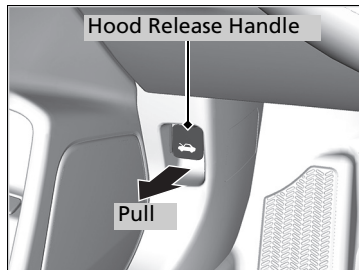

1. Park the vehicle on a level surface, and set the parking brake.
2. Pull the hood release handle under the driver's side lower left corner of the dashboard.
 - The hood will pop up slightly.
3. Pull up the hood latch lever (located under the front edge of the hood to the center) and raise the hood. Once you have raised the hood slightly, you can release the lever.
4. Remove the support rod from the clamp using the grip. Mount the support rod in the hood.

When closing, remove the support rod, and stow it in the clamp, then gently lower the hood. Remove your hand at a height of approximately 12 inches (30 cm) and let the hood close.

►► Opening the Hood

⚠ WARNING

The hood support rod can become very hot due to heat from the engine.

To ensure against possible burns, do not handle the metal section of the rod: Use the foam grip instead.

NOTICE

Do not open the hood when the wiper arms are raised. The hood will strike the wipers, resulting in damage to the hood and/or the wipers.

When closing the hood, check that the hood is securely latched.

If the hood latch lever moves stiffly, or if you can open the hood without lifting the lever, the latch mechanism should be cleaned and lubricated.

Recommended Engine Oil

- **Genuine Honda Motor Oil**
- **Premium-grade 0W-20 detergent oil with an API Certification Seal on the container.**



Oil is a major contributor to your engine's performance and longevity. If you drive the vehicle with insufficient or deteriorated oil, the engine may fail or be damaged.

This seal indicates the oil is energy conserving and that it meets the American Petroleum Institute's latest requirements.

Use Genuine Honda Motor Oil or another commercial engine oil of suitable viscosity for the ambient temperature as shown.

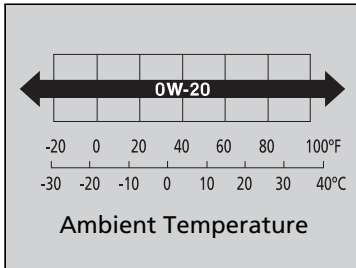

■ Synthetic oil

You may also use synthetic motor oil if it is labeled with the API Certification Seal and is the specified viscosity grade.

☒ Recommended Engine Oil

Engine Oil Additives

Your vehicle does not require oil additives. In fact, they may adversely affect the engine performance and durability.

Oil Check

We recommend that you check the engine oil level every time you refuel.

Park the vehicle on level ground.

Wait approximately three minutes after turning the engine off before you check the oil.

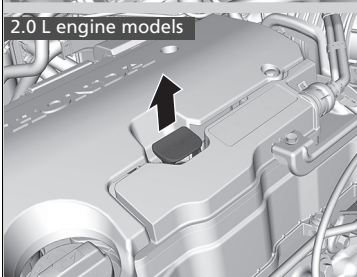
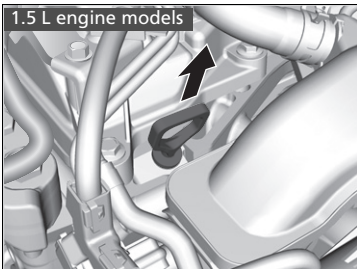

1. Remove the dipstick (orange).
2. Wipe the dipstick with a clean cloth or paper towel.
3. Insert the dipstick back all the way into its hole.

Oil Check

If the oil level is near or below the lower mark, slowly add oil, being careful not to overfill.

1.5 L engine models

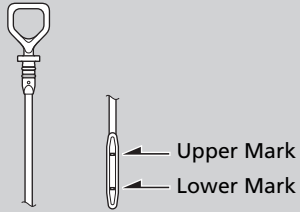

2.0 L engine models

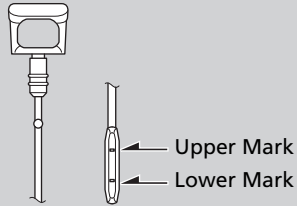

4. Remove the dipstick again, and check the level. It should be between the upper and lower marks. Add oil if necessary.

Oil Check

Under certain driving conditions, it is normal for the engine oil level to rise above the upper mark. If you have a concern, consult a dealer for details.

Adding Engine Oil

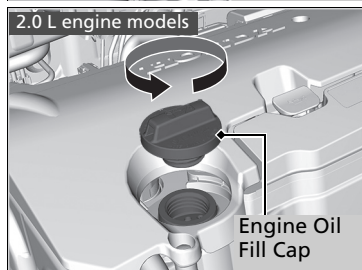
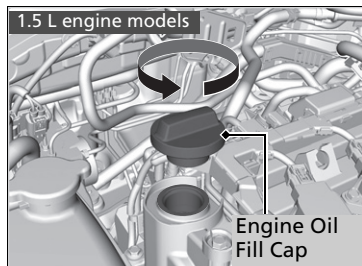

1. Unscrew and remove the engine oil fill cap.
2. Add oil slowly.
3. Reinstall the engine oil fill cap, and tighten it securely.
4. Wait for three minutes and recheck the engine oil dipstick.

► Adding Engine Oil

NOTICE

Do not fill the engine oil above the upper mark. Overfilling the engine oil may result in leaks and engine damage.

If any oil spills, wipe it away immediately. Spilled oil may damage the engine compartment components.

Changing the Engine Oil and Oil Filter

You must change the engine oil and oil filter regularly in order to maintain the engine's lubrication. The engine may be damaged if they are not changed regularly.

Change the oil and filter in accordance with the maintenance message on the information display*/driver information interface*.

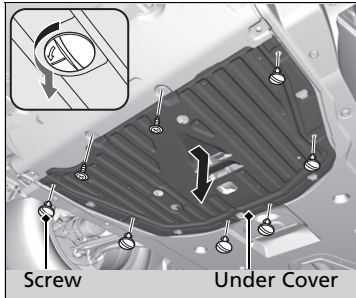

1. Run the engine until it reaches normal operating temperature, and then turn the engine off.
2. Open the hood and remove the engine oil fill cap.
3. Remove the Phillips-head screws and slotted head screws by turning 90° counter-clockwise on the undercarriage and remove the under cover.

Changing the Engine Oil and Oil Filter

NOTICE

You may damage the environment if you do not dispose of the oil in a suitable way. If you are changing the oil by yourself, appropriately dispose of the used oil. Put the oil in a sealed container and take it to a recycling center. Do not throw the oil away into a garbage can or onto the ground.

* Not available on all models

Continued

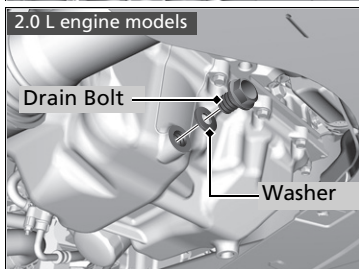
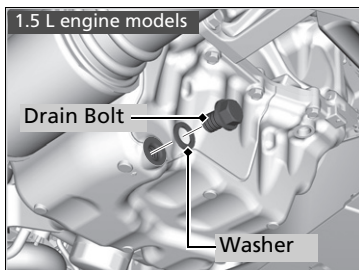

4. Remove the drain bolt and washer from the bottom of the engine, and drain the oil into a suitable container.

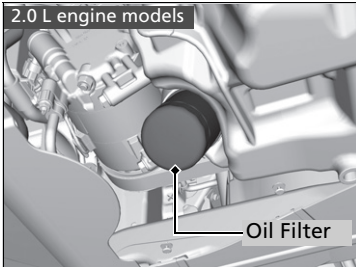
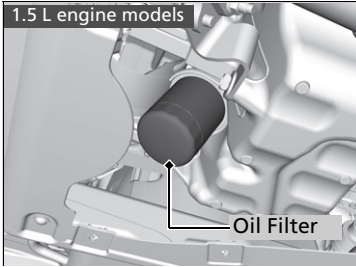

5. Remove the oil filter and dispose of the remaining oil.
6. Check that the filter gasket is not stuck to the engine contact surface.
 - If it is stuck, you must detach it.
7. Wipe away dirt and dust adhering to the contact surface of the engine block, and install a new oil filter.
 - Apply a light coat of new engine oil to the oil filter gasket.
8. Put a new washer on the drain bolt, then reinstall the drain bolt.
 - Tightening torque:
30 lbf·ft (40 N·m, 4.0 kgf·m)
9. Pour the recommended engine oil into the engine.
 - Engine oil change capacity (including filter):
 - 1.5 L engine models**
3.7 US qt (3.5 L)
 - 2.0 L engine models**
4.4 US qt (4.2 L)
10. Reinstall the engine oil fill cap securely and start the engine.
11. Run the engine for a few minutes, and then check that there are no leaks from the drain bolt or oil filter.
12. Stop the engine, wait for three minutes, and then check the oil level on the dipstick.
 - If necessary, add more engine oil.

✘ Changing the Engine Oil and Oil Filter

You will need a special wrench to replace the oil filter. You can buy this wrench from a dealer.

When installing the new oil filter, follow the instructions supplied with the oil filter.

Reinstall the engine oil fill cap. Start the engine. The low oil pressure indicator should go off within five seconds. If it does not, turn off the engine, and check your work.

Engine Coolant

Specified coolant: Honda Long Life Antifreeze/Coolant Type 2

This coolant is premixed with 50% antifreeze and 50% water. Do not add any straight antifreeze or water.

We recommend you check the engine coolant level every time you refuel. Check the reserve tank. Add the engine coolant accordingly.

Checking the Coolant

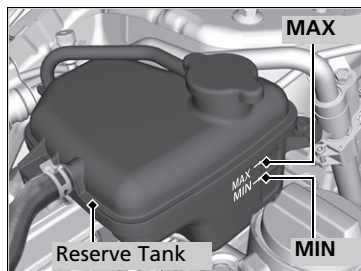

1. **Make sure the engine and radiator are cool.**
2. Check the amount of coolant in the reserve tank.
 - If the coolant level is below the **MIN** mark, add the specified coolant until it reaches the **MAX** mark.
3. Inspect the cooling system for leaks.

Engine Coolant

WARNING

Removing the reserve tank cap while the engine is hot can cause the coolant to spray out, seriously scalding you.

Always let the engine and radiator cool down before removing the reserve tank cap.

NOTICE

Genuine Honda engine coolant is a 50/50 mixture of antifreeze and water that can withstand freezing at temperatures as low as about -31°F (-35°C). If your vehicle is consistently subjected to temperatures below this, the concentration of antifreeze in the coolant should be increased. Consult a dealer for details.

If Honda antifreeze/coolant is not available, you may use another major brand of non-silicate coolant as a temporary replacement. Check that it is a high quality coolant recommended for aluminum engines. Continued use of any non-Honda coolant can result in corrosion, causing the cooling system to malfunction or fail. Have the cooling system flushed and refilled with Honda antifreeze/coolant as soon as possible.

Adding the Coolant

1.5 L engine models

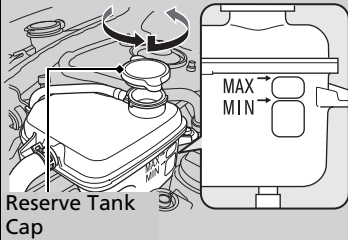

2.0 L engine models

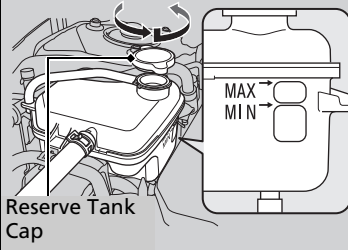

1. **Make sure the engine and radiator are cool.**
2. Turn the reserve tank cap 1/8 turn counter-clockwise and relieve any pressure in the cooling system.
3. Push down and turn the reserve tank cap counter-clockwise to remove it.
4. Pour coolant into the reserve tank until it reaches the **MAX** mark.
5. Put the reserve tank cap back on, and tighten it fully.

Engine Coolant

Do not add rust inhibitors or other additives to your vehicle's cooling system. They may not be compatible with the coolant or with the engine components.

Adding the Coolant

NOTICE

Pour the fluid slowly and carefully so you do not spill any. Clean up any spills immediately; they can damage components in the engine compartment.

Transmission Fluid

Models with continuously variable transmission

Continuously Variable Transmission (CVT) Fluid

Specified fluid: Honda HCF-2 Transmission Fluid

Have a dealer check the fluid level and replace if necessary.

Do not attempt to check or change the continuously variable transmission fluid yourself.

Models with manual transmission

Manual Transmission Fluid

Specified fluid: Honda Manual Transmission Fluid (MTF)

Have a dealer check the fluid level and replace if necessary.

Do not attempt to check or change the manual transmission fluid yourself.

⌘ Continuously Variable Transmission (CVT) Fluid

NOTICE

Do not mix HCF-2 with other transmission fluids.

Using a transmission fluid other than HCF-2 may adversely affect the operation and durability of your vehicle's transmission, and damage the transmission. Any damage caused by using a transmission fluid that is not equivalent to HCF-2 is not covered by Honda's new vehicle limited warranty.

⌘ Manual Transmission Fluid

If Honda MTF is not available, you may use the API certificated SAE 0W-20 or 5W-20 viscosity motor oil as a temporary measure.

Replace with MTF as soon as possible. Motor oil does not contain the proper additives for the transmission and continued use can cause decreased shifting performance and lead to transmission damage.

Brake/Clutch * Fluid

Specified fluid: Honda Heavy Duty Brake Fluid DOT 3

Use the same fluid for both the brakes and clutch.

Checking the Brake Fluid

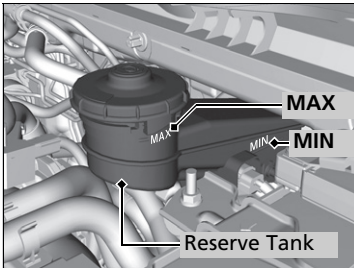

The fluid level should be between the **MIN** and **MAX** marks on the side of the reserve tank.

Manual transmission models

The brake fluid reserve tank is also used for your vehicle's clutch fluid. As long as you keep the brake fluid level as instructed above, there is no need for checking the clutch fluid level.

Brake/Clutch * Fluid

NOTICE

Brake fluid marked DOT 5 is not compatible with your vehicle's braking system and can cause extensive damage.

If the specified brake fluid is not available, you should use only DOT 3 or DOT 4 fluid from a sealed container as a temporary replacement.

Using any non-Honda brake fluid can cause corrosion and decrease the longevity of the system. Have the brake system flushed and refilled with Honda Heavy Duty Brake Fluid DOT 3 as soon as possible.

If the brake fluid level is at or below the **MIN** mark, have a dealer inspect the vehicle for leaks or worn brake pads as soon as possible.

* Not available on all models

Refilling Window Washer Fluid

Check the amount of window washer fluid by looking at the reservoir.

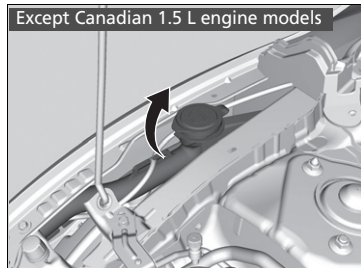

If the level is low, fill the washer reservoir.

Canadian models

If the washer fluid is low, a message appears on the driver information interface.

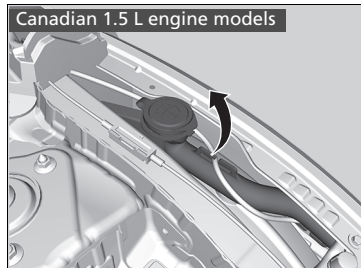

Pour the washer fluid carefully. Do not overflow the reservoir.

Refilling Window Washer Fluid

NOTICE

Do not use engine antifreeze or a vinegar/water solution in the windshield washer reservoir. Antifreeze can damage your vehicle's paint. A vinegar/water solution can damage the windshield washer pump. Use only commercially available windshield washer fluid. Avoid prolonged use of hard water to prevent lime scale build up.

Headlight Bulbs

When replacing, use the following bulbs.

High beam headlight: 60 W (HB3 for halogen bulb type)*

High beam headlight: LED type*

Low beam headlight: 55 W (H11 for halogen bulb type)*

Low beam headlight: LED type*

High Beam Headlights

Models with halogen headlights

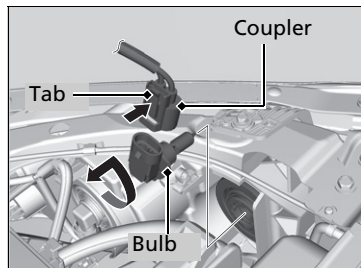

1. Push the tab to remove the coupler.
2. Rotate the old bulb counter-clockwise to remove.
3. Insert a new bulb into the headlight assembly and turn it clockwise.
4. Insert the coupler into the connector of the bulb.

* Not available on all models

Headlight Bulbs

Models with halogen headlights

NOTICE

Halogen bulbs get very hot when lit. Oil, perspiration, or a scratch on the glass can cause the bulb to overheat and shatter.

The headlight aim is set by the factory, and does not need to be adjusted. However, if you regularly carry heavy items in the trunk, have the aiming readjusted at a dealer or by a qualified technician.

When replacing a halogen bulb, handle it by its base, and protect the glass from contact with your skin or hard objects. If you touch the glass, clean it with denatured alcohol and a clean cloth.

Models with LED headlights

Headlights are LED type. Have an authorized Honda dealer inspect and replace the light assembly.

Continued

Low Beam Headlights

Models with halogen headlights

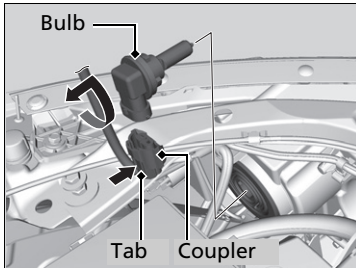

1. Push the tab to remove the coupler.
2. Rotate the old bulb counter-clockwise to remove.
3. Insert a new bulb into the headlight assembly and turn it clockwise.
4. Insert the coupler into the connector of the bulb.

Fog Light Bulbs*

When replacing, use the following bulbs.

Fog Light: 35 W (H8 for halogen bulb type)

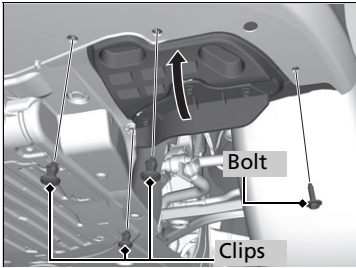

1. Remove the clips using a flat-tip screwdriver, remove the bolt, and push up the under cover.

▶ Fog Light Bulbs*

Insert a flat-tip screwdriver, lift and remove the center pin to remove the clip.

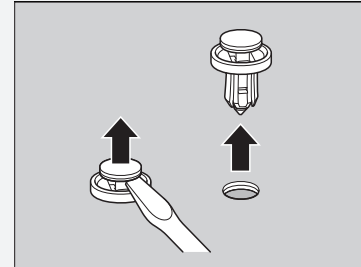

Insert the clip with the center pin raised, and push until it is flat.

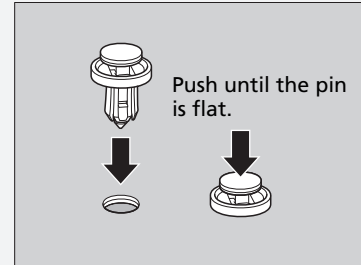

* Not available on all models

Continued

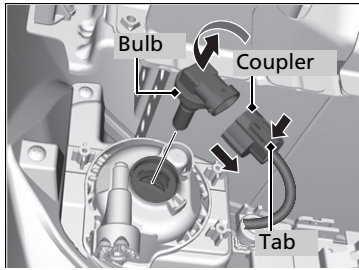

2. Push the tab to remove the coupler.
3. Rotate the old bulb counter-clockwise to remove.
4. Insert a new bulb into the fog light assembly and turn it clockwise.
5. Insert the coupler into the connector of the bulb.

⌘ Fog Light Bulbs*

NOTICE

Halogen bulbs get very hot when lit. Oil, perspiration, or a scratch on the glass can cause the bulb to overheat and shatter.

When replacing a halogen bulb, handle it by its plastic case, and protect the glass from contact with your skin or hard objects. If you touch the glass, clean it with denatured alcohol and a clean cloth.

Models with halogen headlights

Front Turn Signal Light Bulbs

When replacing, use the following bulbs.

Front Turn Signal Light: 21 W (Amber)

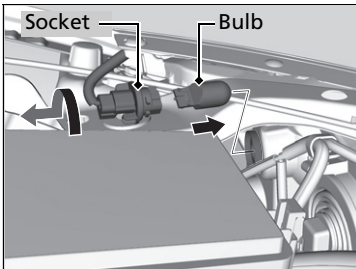

1. Turn the socket counter-clockwise and remove it.
2. Remove the old bulb and insert a new bulb.

Models with LED headlights

Front Turn Signal Lights

Front turn signal lights are LED type. Have an authorized Honda dealer inspect and replace the light assembly.

Front Side Marker Light Bulbs

When replacing, use the following bulbs.

Front Side Marker Light: 3 W

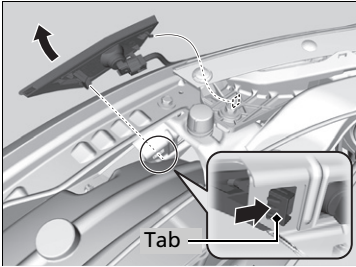

1. Push the tab to remove the light assembly.
2. Push the tab to remove the coupler.

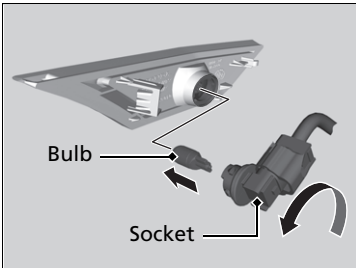

Driver side

3. Turn the socket counter-clockwise to remove it, then remove the old bulb.
4. Insert a new bulb.

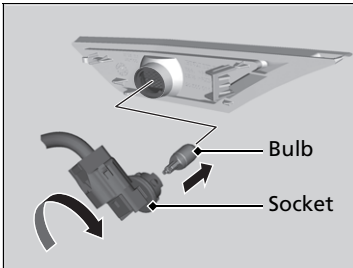
**Passenger side**

3. Turn the socket clockwise to remove it, then remove the old bulb.
4. Insert a new bulb.

Parking/Daytime Running Lights

Parking/daytime running lights are LED type. Have an authorized Honda dealer inspect and replace the light assembly.

Side Turn Signal/Emergency Indicator Lights *

Door mirror side turn lights are LED type. Have an authorized Honda dealer inspect and replace the light assembly.

* Not available on all models

Brake Light, Tail/Rear Side Marker Light, Rear Turn Signal Light and Back-Up Light Bulbs

When replacing, use the following bulbs.

Brake Light: 21 W
Tail/Rear Side Marker Light: LED
Rear Turn Signal Light: 21 W (Amber)
Back-Up Light: 6 W

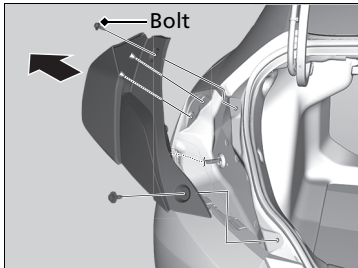

1. Use a Phillip-head screwdriver or socket to remove the bolts.
2. Pull the light assembly out of the rear pillar.

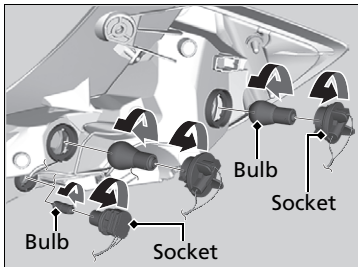

3. Turn the socket counter-clockwise and remove it.
4. Remove the old bulb and insert a new bulb.
5. Slide the light assembly onto the guide on the body.
6. Align the pins with the body grommets, then push in until they fully seat.

▶▶ Brake Light, Tail/Rear Side Marker Light, Rear Turn Signal Light and Back-Up Light Bulbs

Tail/rear side marker lights are LED type. Have an authorized Honda dealer inspect and replace the light assembly.

Taillight

Taillight is LED type. Have an authorized Honda dealer inspect and replace the light assembly.

Rear License Plate Light

Rear license plate light is LED type. Have an authorized Honda dealer inspect and replace the light assembly.

High-Mount Brake Light

High-mount brake light is LED type. Have an authorized Honda dealer inspect and replace the light assembly.

Checking Wiper Blades

If the wiper blade rubber has deteriorated, it will leave streaks and the hard surfaces of the blade may scratch the window glass.

Changing the Wiper Blade Rubber

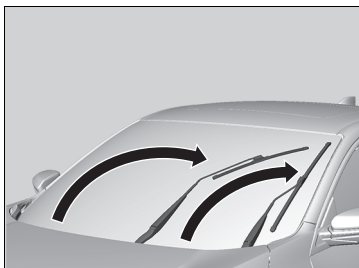

1. Turn the ignition switch to LOCK **0***1.
2. While holding the wiper switch in the **MIST** position, turn the ignition switch to ON **II***1, then to LOCK **0***1.
 - ▶ Both wiper arms are set to the maintenance position as shown in the image.

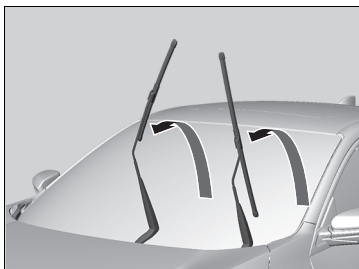

3. Lift both wiper arms.

✕ Changing the Wiper Blade Rubber

NOTICE

Avoid dropping the wiper arm onto the windshield, it may damage the wiper arm and/or the windshield.

*1: Models with the smart entry system have an **ENGINE START/STOP** button instead of an ignition switch.

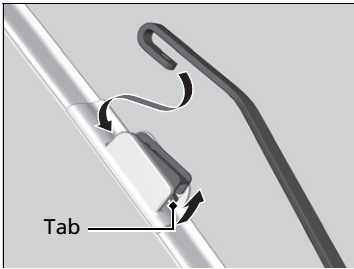

4. Press and hold the tab, then slide the holder off the wiper arm.

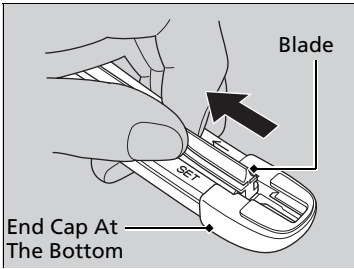

5. Pull the end of the wiper blade in the direction of the arrow in the image until it is out of the holder's end cap.

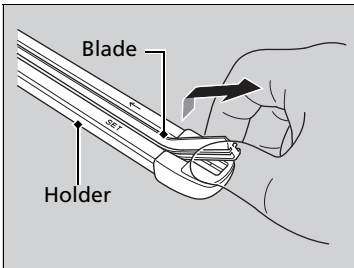

6. Pull the wiper blade in the opposite direction to slide it out of the holder.

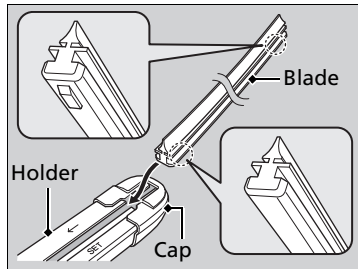

7. Insert the flat side of the new wiper blade onto the bottom part of the holder. Insert the blade all the way.
8. Install the end of the wiper blade into the cap.
9. Slide the holder onto the wiper arm until it locks.
10. Lower both wiper arms.
11. Turn the ignition switch to ON *1 and hold the wiper switch in the **MIST** position until both wiper arms return to the standard position.

*1: Models with the smart entry system have an **ENGINE START/STOP** button instead of an ignition switch.

Checking Tires

To safely operate your vehicle, your tires must be of the proper type and size, in good condition with adequate tread, and properly inflated.

■ Inflation guidelines

Properly inflated tires provide the best combination of handling, tread life, and comfort. Refer to the driver's doorjamb label or specification's page for the specified pressure.

Underinflated tires wear unevenly, adversely affect handling and fuel economy, and are more likely to fail from overheating.

Overinflated tires make your vehicle ride harshly, are more prone to road hazards, and wear unevenly.

Every day before you drive, look at each of the tires. If one looks lower than the others, check the pressure with a tire gauge.

At least once a month or before long trips, use a gauge to measure the pressure in all tires, including the spare*. Even tires in good condition can lose 1-2 psi (10-20 kPa, 0.1-0.2 kgf/cm²) per month.

■ Inspection guidelines

Every time you check inflation, also examine the tires and valve stems. Look for:

- Bumps or bulges on the side or in the tread. Replace the tire if you find any cuts, splits, or cracks in the side of the tire. Replace it if you see fabric or cord.
- Remove any foreign objects and inspect for air leaks.
- Uneven tread wear. Have a dealer check the wheel alignment.
- Excessive tread wear.

➔ **Wear Indicators** P. 544

- Cracks or other damage around valve stem.

* Not available on all models

ⓘ Checking Tires

⚠ WARNING

Using tires that are excessively worn or improperly inflated can cause a crash in which you can be seriously hurt or killed.

Follow all instructions in this owner's manual regarding tire inflation and maintenance.

Measure the air pressure when tires are cold. This means the vehicle has been parked for at least three hours, or driven less than 1 mile (1.6 km). If necessary, add or release air until the specified pressure is reached.

If checked when hot, tire pressure can be as much as 4–6 psi (30–40 kPa, 0.3–0.4 kgf/cm²) higher than if checked when cold.

U.S. models

Whenever tire pressure is adjusted, you must calibrate the TPMS.

➔ **TPMS Calibration** P. 469

Have a dealer check the tires if you feel a consistent vibration while driving. New tires and any that have been removed and reinstalled should be properly balanced.

Models with a spare tire

Check the spare tire pressure once a month or before long trips.

Tire and Loading Information Label

The label attached to the driver’s doorjamb provides necessary tire and loading information.

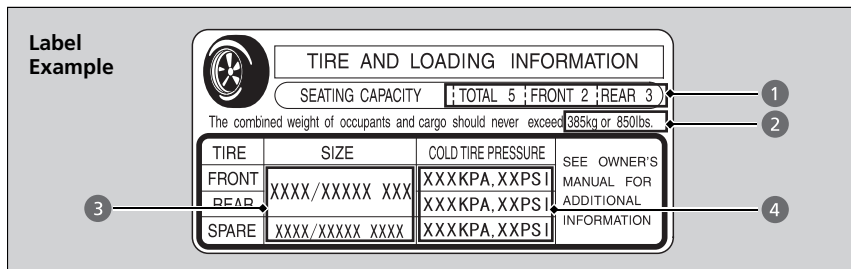

▶▶ Tire and Loading Information Label

The tire and loading information label attached to the driver’s doorjamb contains:

- 1 The number of people your vehicle can carry.
- 2 The total weight your vehicle can carry. Do not exceed this weight.
- 3 The original tire sizes for front, rear, and spare.
- 4 The proper cold tire pressure for front, rear, and spare.

Tire Labeling

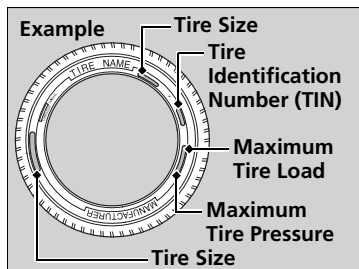

The tires that came on your vehicle have a number of markings. Those you should be aware of are described below.

▶▶ Tire Sizes

Following is an example of tire size with an explanation of what each component means.

P205/55 R16 89H

P: Vehicle type (P indicates passenger vehicle).

205: Tire width in millimeters.

55: Aspect ratio (the tire’s section height as a percentage of its width).

R: Tire construction code (R indicates radial).

16: Rim diameter in inches.

89: Load index (a numerical code associated with the maximum load the tire can carry).

H: Speed symbol (an alphabetical code indicating the maximum speed rating).

Tire Sizes

Whenever tires are replaced, they should be replaced with tires of the same size.

■ Tire Identification Number (TIN)

The tire identification number (TIN) is a group of numbers and letters that look like the example in the side column. TIN is located on the sidewall of the tire.

■ Glossary of Tire Terminology

Cold Tire Pressure – The tire air pressure when the vehicle has been parked for at least three hours or driven less than 1 mile (1.6 km).

Load Rating – Means the maximum load that a tire is rated to carry for a given inflation pressure.

Maximum Inflation Pressure – The maximum tire air pressure that the tire can hold.

Maximum Load Rating – Means the load rating for a tire at the maximum permissible inflation pressure for that tire.

Recommended Inflation Pressure – The cold tire inflation pressure recommended by the manufacturer.

Treadwear Indicators (TWI) – Means the projections within the principal grooves designed to give a visual indication of the degrees of wear of the tread.

☒ Tire Identification Number (TIN)

DOT B97R FW6X 2209

DOT: This indicates that the tire meets all requirements of the U.S. Department of Transportation.

B97R: Manufacturer's identification mark.

FW6X: Tire type code.

22 09: Date of manufacture.

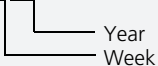

 Year
 Week

DOT Tire Quality Grading (U.S. Vehicles)

The tires on your vehicle meet all U.S. Federal Safety Requirements. All tires are also graded for treadwear, traction, and temperature performance according to Department of Transportation (DOT) standards. The following explains these gradings.

■ Uniform Tire Quality Grading

Quality grades can be found where applicable on the tire sidewall between tread shoulder and maximum section width.

■ Treadwear

The treadwear grade is a comparative rating based on the wear rate of the tire when tested under controlled conditions on a specified government test course. For example, a tire graded 150 would wear one and one-half (1 1/2) times as well on the government course as a tire graded 100. The relative performance of tires depends upon the actual conditions of their use, however, and may depart significantly from the norm due to variations in driving habits, service practices and differences in road characteristics and climate.

▣ Uniform Tire Quality Grading

For example:

Treadwear 200
Traction AA
Temperature A

All passenger car tires must conform to Federal Safety Requirements in addition to these grades.

■ Traction

The traction grades, from highest to lowest, are AA, A, B, and C. Those grades represent the tire's ability to stop on wet pavement as measured under controlled conditions on specified government test surfaces of asphalt and concrete. A tire marked C may have poor traction performance.

■ Temperature

The temperature grades are A (the highest), B, and C, representing the tire's resistance to the generation of heat and its ability to dissipate heat when tested under controlled conditions on a specified indoor laboratory test wheel. Sustained high temperature can cause the material of the tire to degenerate and reduce tire life, and excessive temperature can lead to sudden tire failure. The grade C corresponds to a level of performance which all passenger car tires must meet under the Federal Motor Vehicle Safety Standard No. 109. Grades B and A represent higher levels of performance on the laboratory test wheel than the minimum required by law.

⌘ Traction

Warning: The traction grade assigned to this tire is based on straight-ahead braking traction tests, and does not include acceleration, cornering, hydroplaning, or peak traction characteristics.

⌘ Temperature

Warning: The temperature grade for this tire is established for a tire that is properly inflated and not overloaded. Excessive speed, underinflation, or excessive loading, either separately or in combination, can cause heat buildup and possible tire failure.

Wear Indicators

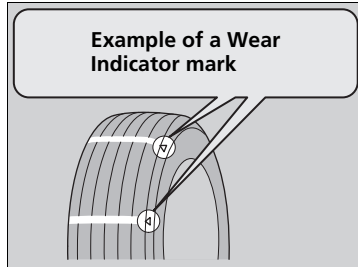

The groove where the wear indicator is located is 1/16 inch (1.6 mm) shallower than elsewhere on the tire. If the tread has worn so that the indicator is exposed, replace the tire.

Worn out tires have poor traction on wet roads.

Tire Service Life

The life of your tires is dependent on many factors, including driving habits, road conditions, vehicle loading, inflation pressure, maintenance history, speed, and environmental conditions (even when the tires are not in use).

In addition to regular inspections and inflation pressure maintenance, it is recommended that you have annual inspections performed once the tires reach five years old. All tires, including the spare*, should be removed from service after 10 years from the date of manufacture, regardless of their condition or state of wear.

Tire and Wheel Replacement

Replace your tires with radials of the same size, load range, speed rating, and maximum cold tire pressure rating (as shown on the tire's sidewall). Using tires of a different size or construction can cause certain vehicle systems such as the ABS and Vehicle Stability Assist (VSA®) system to work incorrectly.

It is best to replace all four tires at the same time. If that isn't possible, replace the front or rear tires in pairs.

Make sure that the wheel's specifications match those of the original wheels.

⚠ Tire and Wheel Replacement

⚠ WARNING

Installing improper tires on your vehicle can affect handling and stability. This can cause a crash in which you can be seriously hurt or killed.

Always use the size and type of tires recommended in this owner's manual.

Tire Rotation

Rotating tires according to the maintenance messages on the information display*/ driver information interface* helps to distribute wear more evenly and increase tire life.

■ Tires without rotation marks

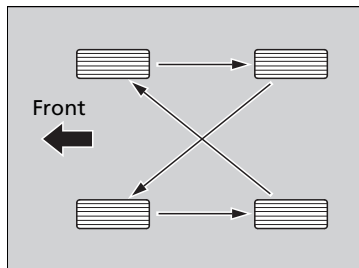

Rotate the tires as shown here.

■ Tires with rotation marks

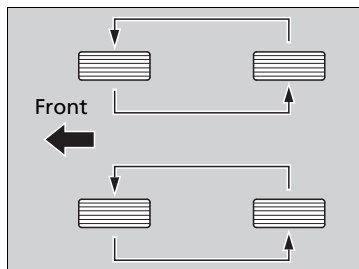

Rotate the tires as shown here.

▶▶ Tire Rotation

Tires with directional tread patterns should only be rotated front to back (not from one side to the other). Directional tires should be mounted with the rotation indication mark facing forward, as shown below.

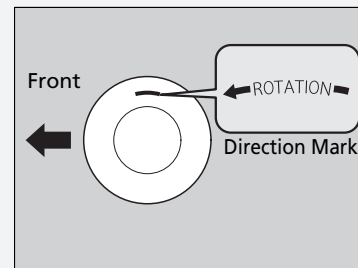

U.S. models

Whenever tires are rotated, you must calibrate the TPMS.

▶▶ **TPMS Calibration** P. 469

Winter Tires

If driving on snowy or frozen roads, mount all season marked **M+S** tires, snow tires, or tire chains; reduce speed; and maintain sufficient distance between vehicles when driving.

Be particularly careful when operating the steering wheel or brakes to prevent skidding.

Use tire chains, snow tires, or all season tires when necessary or according to the law.

When mounting, refer to the following points.

For winter tires:

- Select the size and load ranges that are the same as the original tires.
- Mount the tires to all four wheels.

❗ Winter Tires

⚠ WARNING

Using the wrong chains, or not properly installing chains, can damage the brake lines and cause a crash in which you can be seriously injured or killed.

Follow all instructions in this owner's manual regarding the selection and use of tire chains.

NOTICE

Traction devices that are the wrong size or improperly installed can damage your vehicle's brake lines, suspension, body, and wheels. Stop driving if they are hitting any part of the vehicle.

Continued

For tire chains:

- Install them on the front tires only.
- Because your vehicle has limited tire clearance, we strongly recommend using the chains listed below:

Models with 215/55R16 tires

Cable-type: Autotrac 0154505

Models with 215/50R17 tires

Cable-type: Autotrac 0154005

Models with 235/40R18 tires

Not recommended to use any type of chains

- Follow the chain manufacturer's instruction when installing. Mount them as tightly as you can.
- Check that the chains do not touch the brake lines or suspension.
- Drive slowly.

Models with 235/40R18 tires

Your vehicle's tires are not suitable for mounting any traction device.

❧ Winter Tires

When tire chains are mounted, follow the chain manufacturer's instructions regarding vehicle operational limits.

If your vehicle is equipped with summer tires, be aware that these tires are not designed for winter driving conditions. For more information, contact a dealer.

Checking the Battery

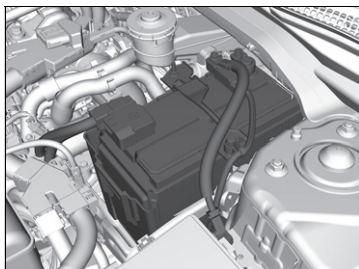

The condition of the battery is monitored by a sensor located on the negative terminal of the battery. If there is a problem with this sensor, the information display*/driver information interface* will display a warning message. If this happens, have your vehicle inspected by a dealer.

Check the battery terminals for corrosion monthly.

If your vehicle's battery is disconnected or goes dead:

- The audio system is disabled.
 - **Reactivating the audio system** P. 202
- The clock resets.
 - **Adjusting the Clock** P. 126
- The navigation system* is disabled.
 - **Refer to the Navigation System Manual**
- **Canadian models only**

The immobilizer system needs to be reset.

- **Immobilizer System Indicator** P. 86

Battery

⚠ WARNING

The battery gives off explosive hydrogen gas during normal operation.

A spark or flame can cause the battery to explode with enough force to kill or seriously hurt you.

When conducting any battery maintenance, wear protective clothing and a face shield, or have a skilled technician do it.

WARNING: Battery post, terminals, and related accessories contain lead and lead compounds.

Wash your hands after handling.

* Not available on all models

Charging the Battery

Disconnect both battery cables to prevent damaging your vehicle's electrical system. Always disconnect the negative (–) cable first, and reconnect it last.

⌘ Battery

When you find corrosion, clean the battery terminals by applying a baking powder and water solution. Clean the terminal with a damp towel. Cloth/towel dry the battery. Coat the terminals with grease to help prevent future corrosion.

When replacing the battery, the replacement must be of the same specifications. Please consult a dealer for more information.

The indicators for the Vehicle Stability Assist (VSA®) system, Vehicle Stability Assist (VSA®) OFF, Low Tire Pressure/TPMS* and Collision Mitigation Braking System™ (CMBS™)* may come on after re-connecting the battery. Drive a short distance at more than 12 mph (20 km/h). The indicators should go off. If they do not, have your vehicle checked by a dealer.

*1: Models with the smart entry system have an **ENGINE START/STOP** button instead of an ignition switch.

* Not available on all models

Replacing the Button Battery

If the indicator does not come on when the button is pressed, replace the battery.

Master Keys with Remote Transmitter*

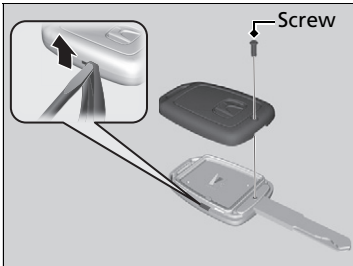

Battery type: CR1620

1. Unscrew the cover with a small Phillips-head screwdriver.
2. Open the remote transmitter.
 - ▶ Wrap the small flat-tip screwdriver with a cloth to prevent scratching the transmitter.
3. Remove the button battery with the small flat-tip screwdriver.
4. Make sure to replace the battery with the correct polarity.

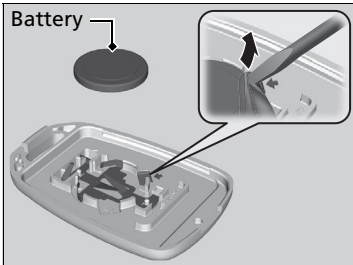

Replacing the Button Battery

⚠ WARNING

CHEMICAL BURN HAZARD

The battery that powers the remote transmitter can cause severe internal burns and can even lead to death if swallowed. Keep new and used batteries away from children.

If you suspect that a child has swallowed the battery, seek medical attention immediately.

NOTICE

An improperly disposed of battery can damage the environment. Always confirm local regulations for battery disposal.

Replacement batteries are commercially available or at a dealer.

* Not available on all models

■ Smart Entry Remote *



Battery type: CR2032

1. Remove the built-in key.
2. Remove the upper half of the cover by carefully prying on the edge with a coin.
 - ▶ Remove carefully to avoid losing the buttons.
 - ▶ Wrap a coin with a cloth to prevent scratching the smart entry remote.
3. Make sure to replace the battery with the correct polarity.

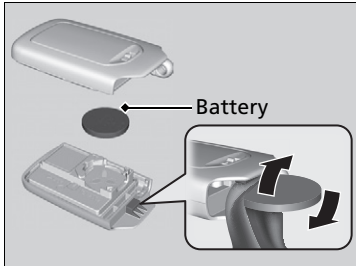

Air Conditioning

To ensure proper and safe operation, the Society of Automotive Engineers (SAE J2845) recommends that the refrigerant system only be serviced by trained and certified technicians.

Never repair or replace the air conditioning evaporator (cooling coil) with one removed from a used or salvaged vehicle.

New replacement mobile air conditioning evaporators must be certified (and labeled) as meeting SAE Standard J2842.

Dust and Pollen Filter

The climate control system is equipped with a dust and pollen filter that collects pollen, dust, and other debris in the air. The Maintenance Minder™ messages will let you know when to replace the filter.

We recommend that you replace the dust and pollen filter sooner when using your vehicle in areas with high concentrations of dust.

Climate Control System Maintenance

NOTICE

Vented refrigerant is harmful to the environment. To avoid refrigerant from venting, never replace the evaporator with one removed from a used or salvaged vehicle.

Refrigerant in your vehicle's air conditioning system is flammable and can be ignited during servicing if proper procedures are not followed.

The air conditioner label is found under the hood:

➤ **Safety Labels** P. 74

➤ **Specifications** P. 606, 608

Canadian models



 : Caution

 : Flammable Refrigerant

 : Requires Registered Technician to Service

 : Air Conditioning System

Dust and Pollen Filter

If the airflow from the climate control system deteriorates noticeably, and the windows fog up easily, the filter may need to be replaced. Please contact a dealer for replacement.

Interior Care

Use a damp cloth with a mixture of mild detergent and warm water to remove dirt. Use a clean cloth to remove detergent residue.

Cleaning Seat Belts

Use a soft brush with a mixture of mild soap and warm water to clean the seat belts. Let the belts air dry. Wipe the loops of the seat belt anchors using a clean cloth.

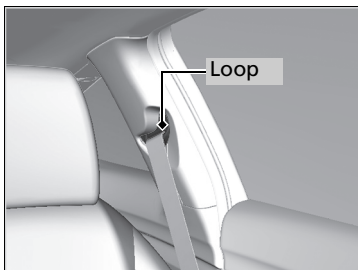

Cleaning the Window

Wipe using a glass cleaner.

Interior Care

Do not spill liquids inside the vehicle. Electrical devices and systems may malfunction if liquids are splashed on them.

Do not use silicone based sprays on electrical devices such as audio devices and switches. Doing so may cause the items to malfunction or cause a fire inside the vehicle.

If a silicone based spray is inadvertently used on electrical devices, consult a dealer.

Depending on their composition, chemicals and liquid aromatics may cause discoloration, wrinkles, and cracking to resin-based parts and textiles. Do not use alkali solvents or organic solvents such as benzene or gasoline.

After using chemicals, make sure to gently wipe them away using a dry cloth.

Do not place used cloths on top of resin based parts or textiles for long periods of time without washing.

Cleaning the Window

Wires are mounted to the inside of the rear window. Wipe along the same direction as the wires with a soft cloth so as not to damage them.

Models with Front Sensor Camera

Be careful not to spill fluids, such as water or glass cleaner, on or around the cover of both the front sensor camera and the rainfall/light sensor*.

Floor Mats

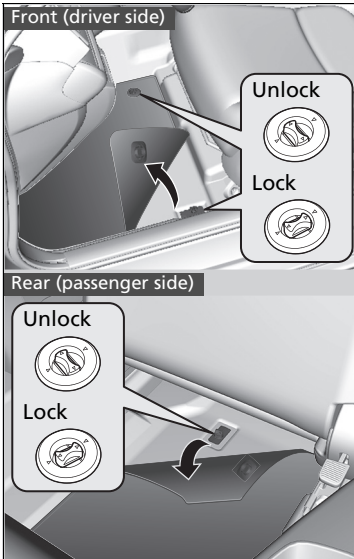

The driver position and rear passenger side floor mats hook over floor anchors, which keep them from sliding forward. To remove a mat for cleaning, turn the anchor knobs to the unlock position. When reinstalling the mat after cleaning, turn the knobs to the lock position.

Do not put additional floor mats on top of the anchored mat.

Maintaining Genuine Leather*

To properly clean leather:

1. Use a vacuum or soft dry cloth first to remove any dirt or dust.
2. Clean the leather with a soft cloth dampened with a solution comprised of 90% water and 10% neutral soap.
3. Wipe away any soap residue with a clean damp cloth.
4. Wipe away residual water and allow leather to air dry in the shade.

* Not available on all models

⌘ Floor Mats

If you use any floor mats that were not originally provided with your vehicle, make sure they are designed for your specific vehicle, fit correctly, and are securely anchored by the floor anchors. Position the rear-seat floor mats properly. If they are not properly positioned, the floor mats can interfere with the front seat functions.

⌘ Maintaining Genuine Leather*

It is important to clean or wipe away dirt or dust as soon as possible. Spills can soak into leather resulting in stains. Dirt or dust can cause abrasions in the leather. In addition, please note that some dark colored clothing can rub onto the leather seats resulting in discoloration or stains.

Exterior Care

Dust off the vehicle body after you drive. Regularly inspect your vehicle for scratches on painted surfaces. A scratch on a painted surface can result in body rust. If you find a scratch, promptly repair it.

■ Washing the Vehicle

Wash the vehicle regularly. Wash more frequently when driving in the following conditions:

- If driving on roads with road salt.
- If driving in coastal areas.
- If tar, soot, bird droppings, insects, or tree sap are stuck to painted surfaces.

■ Using an Automated Car Wash

- Make sure to follow the instructions indicated on the automated car wash.
- Fold in the door mirrors.
- Turn off the automatic intermittent wipers*.

■ Using High Pressure Cleaners

- Keep sufficient distance between the cleaning nozzle and the vehicle body.
- Take particular care around the windows. Standing too close may cause water to enter the vehicle interior.
- Do not spray high pressure water directly into the engine compartment. Instead, use low pressure water and a mild detergent.

🔧 Washing the Vehicle

Do not spray water into the air intake vents. It can cause a malfunction.

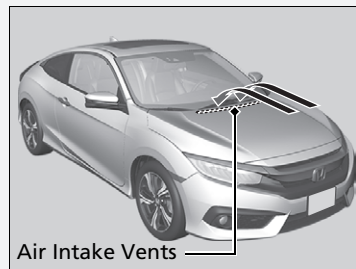

Do not spray water onto the capless unit when the fuel fill door is open. It can cause damage to the fuel system or engine.

If you need to lift the wiper arms away from the windshield, first set the wiper arms to the maintenance position.

🔧 **Changing the Wiper Blade Rubber** P. 536

■ Applying Wax

A good coat of automotive body wax helps protect your vehicle's paint from the elements. Wax will wear off over time and expose your vehicle's paint to the elements, so reapply as necessary.

■ Maintaining the Bumpers and Other Resin Coated Parts

If you get gasoline, oil, engine coolant, or battery fluid on resin coated parts, they may be stained or the coating may peel. Promptly wipe it away using a soft cloth and clean water.

■ Cleaning the Window

Wipe using a glass cleaner.

■ Maintaining Aluminum Wheels

Aluminum is susceptible to deterioration caused by salt and other road contaminants. When necessary, as early as possible use a sponge and mild detergent to wipe away these contaminants. Do not use a stiff brush or harsh chemicals (including some commercial wheel cleaners). These can damage the protective finish on aluminum alloy wheels, resulting in corrosion. Depending on the type of finish, the wheels also may lose their luster or appear burnished. To avoid water stains, wipe the wheels dry with a cloth while they are still wet.

☒ Applying Wax

NOTICE

Chemical solvents and strong cleaners can damage the paint, metal, and plastic on your vehicle. Wipe away spills immediately.

☒ Maintaining the Bumpers and Other Resin Coated Parts

Ask a dealer about the correct coating material when you want to repair the painted surface of the parts made of resin.

Continued

■ Fogged Exterior Light Lenses

The inside lenses of exterior lights (headlights, brake lights, etc.) may fog temporarily if you have driven in the rain, or after the vehicle has been run through a car wash. Dew condensation also may build up inside the lenses when there is a significant enough difference between the ambient and inside-lens temperatures (similar to vehicle windows fogging up in rainy conditions). These conditions are natural processes, not structural design problems in the exterior lights.

Lens design characteristics may result in moisture developing on the lens frame surfaces. This also is not a malfunction. However, if you see large amounts of water accumulation, or large water drops building up inside the lenses, have your vehicle inspected by a dealer.

Accessories

When installing accessories, check the following:

- Do not install accessories on the windshield. They can obstruct your view and delay your reaction to driving conditions.
- Do not install accessories over areas marked **SRS AIRBAG**, on the sides or backs of the front seats, on front or side pillars, or near the side windows. Accessories installed in these areas may interfere with proper operation of the vehicle's airbags or may be propelled into you or another occupant if the airbags deploy.
- Be sure electronic accessories do not overload electrical circuits or interfere with proper operation of your vehicle.
 - **Fuses** P. 597
- Before installing any electronic accessory, have the installer contact a dealer for assistance. If possible, have a dealer inspect the final installation.

Accessories and Modifications

WARNING

Improper accessories or modifications can affect your vehicle's handling, stability, and performance, and cause a crash in which you can be seriously hurt or killed.

Follow all instructions in this owner's manual regarding accessories and modifications.

Honda Genuine accessories are recommended to ensure proper operation on your vehicle.

Modifications

Do not modify your vehicle in a manner that may affect its handling, stability, or reliability, or install non-genuine Honda parts or accessories that may have a similar effect.

Even minor modifications to vehicle systems can affect overall vehicle performance.

Always make sure all equipment is properly installed and maintained, and do not make any modification to your vehicle or its systems that might cause your vehicle to no longer meet federal, state, province, territory, and local regulations.

The on-board diagnostic port (OBD-II/SAE J1962 connector) installed on this vehicle is intended to be used with automobile system diagnostic devices or other devices that Honda has approved. Use of any other type of device may adversely affect the vehicle's electronic systems or allow them to be compromised, possibly resulting in a system malfunction, drained battery, or other unexpected problems.

Do not modify or attempt to repair any of the electrical components.

Handling the Unexpected

This chapter explains how to handle unexpected troubles.

Tools

Types of Tools..... 562

If a Tire Goes Flat

Changing a Flat Tire* 563

Temporarily Repairing a Flat Tire*..... 570

Engine Does Not Start

Checking the Engine..... 582

If the Smart Entry Remote Battery is Weak..... 583

Emergency Engine Stop 584

Jump Starting..... 585

Shift Lever Does Not Move..... 588

Overheating

How to Handle Overheating..... 589

Indicator, Coming On/Blinking

If the Low Oil Pressure Indicator Comes On 591

If the Charging System Indicator Comes On 591

If the Malfunction Indicator Lamp Comes On or Blinks 592

If the Brake System Indicator (Red) Comes On or Blinks 593

If the Brake System Indicator (Red) Comes On or Blinks at the Same Time When the Brake System Indicator (Amber) Comes

On 594

If the Electric Power Steering (EPS) System Indicator Comes On 595

If the Low Tire Pressure/TPMS Indicator Comes On or Blinks 596

Fuses

Fuse Locations 597

Inspecting and Changing Fuses..... 600

Emergency Towing..... 601

When You Cannot Unlock the Fuel Fill Door..... 602

When You Cannot Open the Trunk..... 603

Refueling..... 604

* Not available on all models

Types of Tools

Models with a compact spare tire

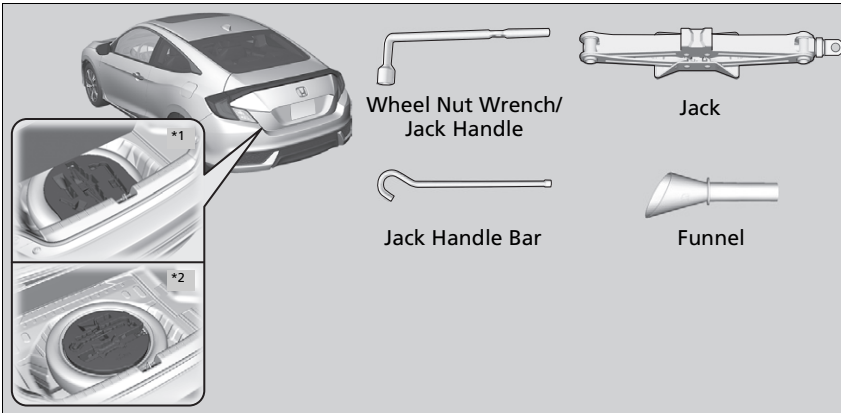

*1: Models without SPORT mode

*2: Models with SPORT mode

Models with tire repair kit



Types of Tools

The tools are stored in the trunk.

Changing a Flat Tire*

If a tire goes flat while driving, grasp the steering wheel firmly, and brake gradually to reduce speed. Then, stop in a safe place. Replace the flat tire with a compact spare tire. Go to a dealer as soon as possible to have the full-size tire repaired or replaced.

1. Park the vehicle on firm, level, and non-slippery surface, and apply the parking brake.

Continuously variable transmission models

2. Move the shift lever to **P**.

Manual transmission models

2. Move the shift lever to **R**.

All models

3. Turn on the hazard warning lights and turn the ignition switch to LOCK **0***1.

*1: Models with the smart entry system have an **ENGINE START/STOP** button instead of an ignition switch.

* Not available on all models

Changing a Flat Tire*

NOTICE

Do not use the jack if it doesn't work properly. Call your dealer or a professional towing service.

Follow compact spare precautions:
Periodically check the tire pressure of the compact spare. It should be set to the specified pressure.
Specified Pressure: 60 psi (420 kPa, 4.2 kgf/cm²)

When driving with the compact spare tire, keep the vehicle speed under 50 mph (80 km/h). Replace with a full-size tire as soon as possible.

The compact spare tire and wheel in your vehicle are specifically for this model. Do not use them with another vehicle. Do not use another type of compact spare tire or wheel with your vehicle.

Do not mount tire chains on a compact spare tire. If a chain-mounted front tire goes flat, remove one of the full-size rear tires and replace it with the compact spare tire. Remove the flat front tire and replace it with the full-size tire that was removed from the rear. Mount the tire chains on the front tire.

Continued

■ Getting Ready to Replace the Flat Tire

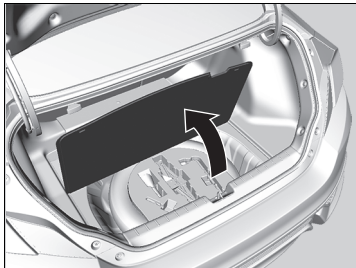

1. Open the trunk floor lid.

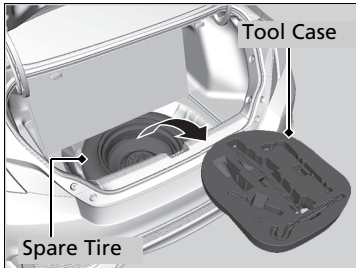

2. Take the tool case out of the trunk. Take the jack and wheel nut wrench out of the tool case.
3. Unscrew the wing bolt, and remove the spacer cone. Then, remove the spare tire.

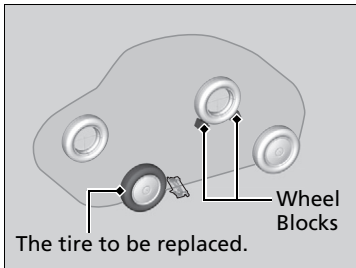

4. Place a wheel block or rock in front and rear of the wheel diagonal to the flat tire.

▶▶ Getting Ready to Replace the Flat Tire

Models with T125/70 R17 size spare tire

NOTICE

Do not mount the compact spare on the front. If mounted on the front, the compact spare, smaller in size than the normal tire, may damage the differential.

If either front tire goes flat, remove the rear tire on the same side, and mount the compact spare on the rear and the rear tire on the front.

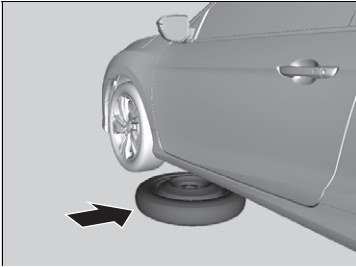

5. Place the compact spare tire (wheel side up) under the vehicle body, near the tire that needs to be replaced.



6. Loosen each wheel nut about one turn using the wheel nut wrench.

■ How to Set Up the Jack

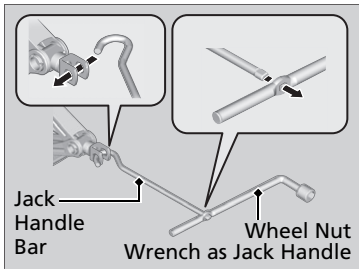
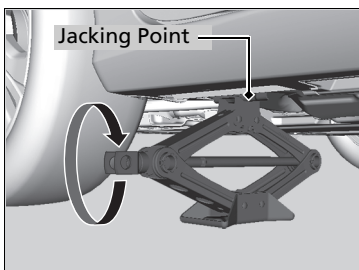
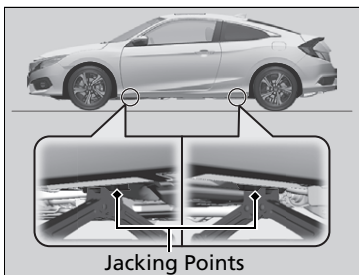

1. Place the jack under the jacking point closest to the tire to be changed.
2. Turn the end bracket clockwise as shown in the image until the top of the jack contacts the jacking point.
 - ▶ Make sure that the jacking point tab is resting in the jack notch.
3. Raise the vehicle, using the jack handle bar and the jack handle, until the tire is off the ground.

🔧 How to Set Up the Jack

⚠ WARNING

The vehicle can easily roll off the jack, seriously injuring anyone underneath.

Follow the directions for changing a tire exactly, and no person should place any portion of their body under a vehicle that is supported by a jack.

Do not use the jack with people or luggage in the vehicle.

Use the jack provided in your vehicle. Other jacks may not support the weight ("load") or their shape may not match.

- The following instructions must be followed to use the jack safely:
- Do not use while the engine is running.
 - Use only where the ground is firm and level.
 - Use only at the jacking points.
 - Do not get in the vehicle while using the jack.
 - Do not put anything on top of or underneath the jack.

Replacing the Flat Tire

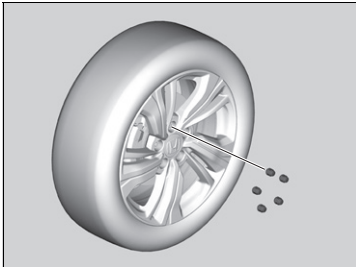

1. Remove the wheel nuts and flat tire.

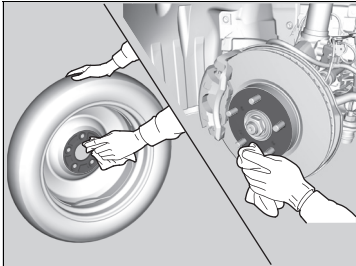

2. Wipe the mounting surfaces of the wheel with a clean cloth.

3. Mount the compact spare tire.

4. Screw the wheel nuts until they touch the lips around the mounting holes, and stop rotating.

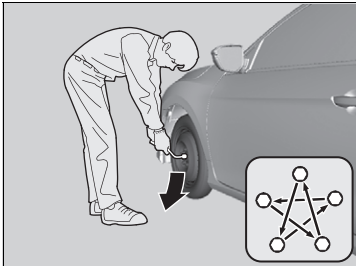

5. Lower the vehicle and remove the jack. Tighten the wheel nuts in the order indicated in the image. Go around, tightening the nuts, two to three times in this order.

Wheel nut torque:

80 lbf-ft (108 N·m, 11 kgf·m)

Replacing the Flat Tire

Do not over tighten the wheel nuts by applying extra torque using your foot or a pipe.

■ Storing the Flat Tire

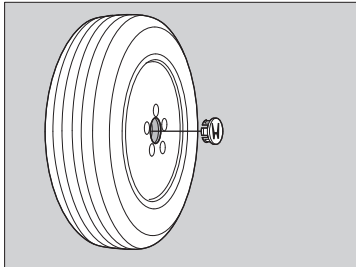

1. Remove the center cap.

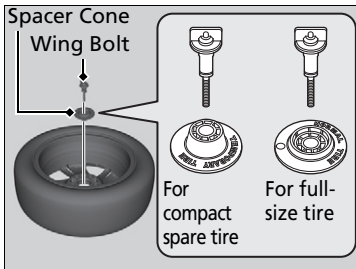

2. Place the flat tire face down in the spare tire well.
3. Remove the spacer cone from the wing bolt, flip it over, and insert it back on the bolt. Secure the flat tire with the wing bolt.
4. Securely put the jack and wheel nut wrench back in the tool case. Store the case in the trunk.

▶▶ Storing the Flat Tire

⚠ WARNING

Loose items can fly around the interior in a crash and can seriously injure the occupants.

Store the wheel, jack, and tools securely before driving.

U.S. models

TPMS and the Compact Spare Tire

If you replace a flat tire with the spare tire, the low tire pressure/TPMS indicator comes on while you are driving. After driving for a few miles (kilometers), the indicator will start blinking for a short time and then stay on. **Tire Pressure Monitor Problem** or **Tire Pressures Low** appears on the driver information interface*, but this is normal.

Calibrate the TPMS when you replace the tire with a specified regular tire.

📄 **TPMS Calibration** P. 469

The system cannot monitor the pressure of the spare tire. Manually check the spare tire pressure to be sure that it is correct.

* Not available on all models

Temporarily Repairing a Flat Tire*

If the tire has a large cut or is otherwise severely damaged, you will need to have the vehicle towed. If the tire only has a small puncture, from a nail for instance, you can use the temporary tire repair kit so that you can drive to the nearest service station for a more permanent repair.

If a tire goes flat while driving, grasp the steering wheel firmly, and brake gradually to reduce speed. Then stop in a safe place.

1. Park the vehicle on a firm, level, and non-slippery surface and apply the parking brake.
2. Move the shift lever to **R**.
3. Turn on the hazard warning lights and set the power mode to VEHICLE OFF (LOCK).

Temporarily Repairing a Flat Tire*

The kit should not be used in the following situations. Instead, contact a dealer or a roadside assistant to have the vehicle towed.

- The tire sealant has expired.
- More than one tire is punctured.
- The puncture or cut is larger than 3/16 inch (4.8 mm).
- The tire side wall is damaged or the puncture is outside the contact area.

 <p>Contact Area</p>	When the puncture is:	Kit Use
	Smaller than 3/16 inch (4.8 mm)	Yes
	Larger than 3/16 inch (4.8 mm)	No

- Damage has been caused by driving with the tire extremely under inflated.
- The tire bead is no longer seated.
- The rim is damaged.

Do not remove a nail or screw that punctured the tire. If you remove it from the tire, you may not be able to repair the puncture using the kit.

Getting Ready to Temporarily Repair the Flat Tire

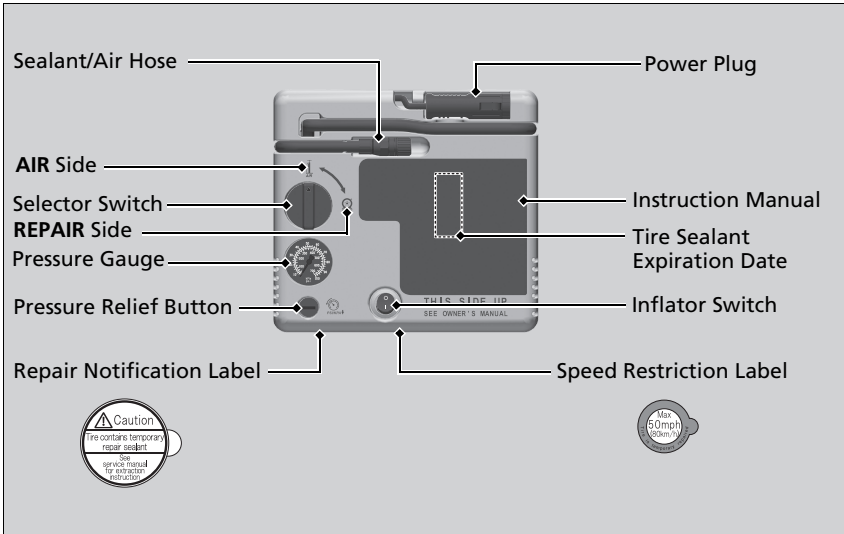

Getting Ready to Temporarily Repair the Flat Tire

Repair notification label and speed restriction label are applied to the side of temporary tire repair kit.

When making a temporary repair, carefully read the instruction manual provided with the kit.

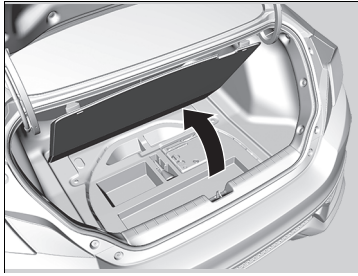

1. Open the trunk floor lid.

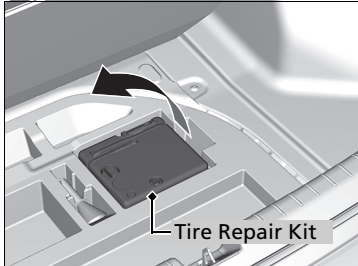

2. Take the kit out of the case.

3. Place the kit face up, on flat ground near the flat tire, and away from traffic. Do not place the kit on its side.

Injecting Sealant and Air

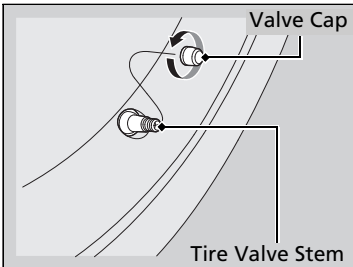

1. Remove the valve cap from the tire valve stem.

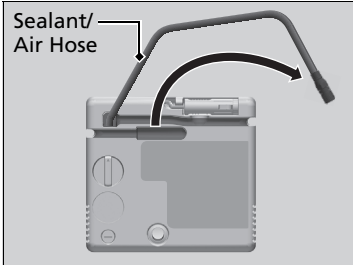

2. Remove the sealant/air hose from the packaging.

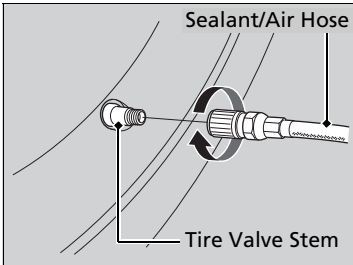

3. Attach the sealant/air hose onto the tire valve stem. Screw the sealant/air hose until it is tightly connected to the tire valve stem.

Injecting Sealant and Air

⚠ WARNING

Tire sealant contains substances that are harmful and can be fatal if swallowed.

If accidentally swallowed, do not induce vomiting. Drink plenty of water and get medical attention immediately.

For skin or eye contact, flush with cool water and get medical attention if necessary.

In cold temperatures, the sealant may not flow easily. In this situation, warm it up for five minutes before using.

The sealant can permanently stain clothing and other materials. Be careful during handling and wipe away any spills immediately.

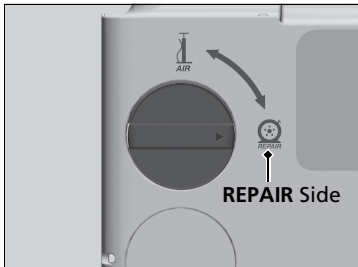
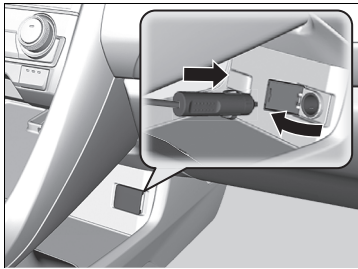

4. Plug in the compressor to the accessory power socket.
 - ▶ Be careful not to pinch the cord in a door or window.
 - ▶ **Accessory Power Socket** P. 186
5. Start the engine.
 - ▶ **Starting the Engine** P. 415
 - ▶ Keep the engine running while injecting sealant and air.
 - ▶ **Carbon Monoxide Gas** P. 73
6. Turn the selector switch to **REPAIR**.

▶▶ Injecting Sealant and Air

WARNING

Running the engine with the vehicle in an enclosed or even partly enclosed area can cause a rapid build-up of toxic carbon monoxide.

Breathing this colorless, odorless gas can cause unconsciousness and even death. Only run the engine to power the air compressor with the vehicle outdoors.

NOTICE

Do not operate the temporary tire repair kit compressor for more than 15 minutes. The compressor can overheat and become permanently damaged.

Until the sealant injection is complete, the pressure shown on the pressure gauge will appear higher than actual. After the sealant injection is complete the pressure will drop and then begin to rise again as the tire is inflated with air. This is normal. To accurately measure the air pressure using the gauge, turn the air compressor off only after the sealant injection is complete.

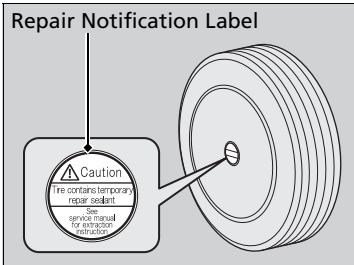
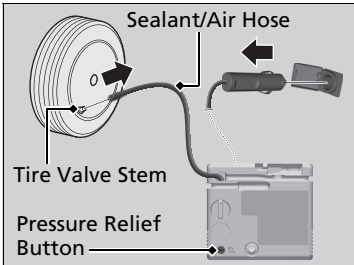
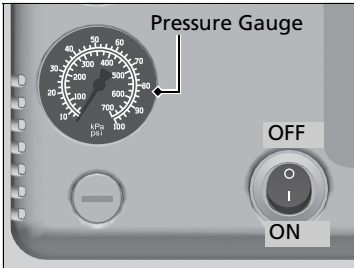

7. Press the inflator switch to turn on the kit.
 - ▶ The compressor starts injecting sealant and air into the tire.
 - ▶ When the sealant injection is complete, continue to add air.
8. After the air pressure reaches to specified pressure, turn off the kit.
 - ▶ To check the pressure, occasionally turn off the compressor and read the gauge.
 - ▶ Refer to the driver's doorjamb label for the specified pressure.
9. Unplug the power plug from the accessory power socket.
10. Unscrew the sealant/air hose from the tire valve stem. Reinstall the valve cap.
11. Press the pressure relief button until the gauge returns to 0 psi (0 kPa).
12. Apply the repair notification label to the flat surface of the wheel.
 - ▶ The wheel surface must be clean to ensure the label adheres properly.

▶▶ Injecting Sealant and Air

If the required air pressure is not reached within 10 minutes, the tire may be too severely damaged for the kit to provide the necessary seal, and your vehicle will need to be towed.

See a dealer for a replacement sealant bottle and proper disposal of an empty bottle.

■ Distributing the Sealant in the Tire

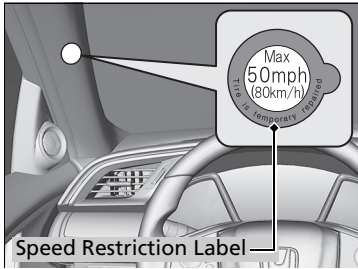

Speed Restriction Label

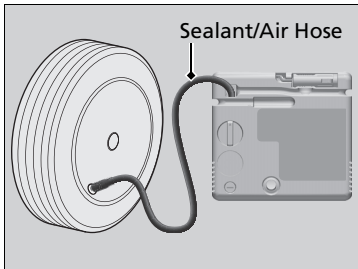

Sealant/Air Hose

1. Apply the speed restriction label to the location as shown.
2. Drive the vehicle for about 10 minutes.
 - Do not exceed 50 mph (80 km/h).
3. Stop the vehicle in a safe place.
4. Recheck the air pressure using the sealant/air hose on the compressor.

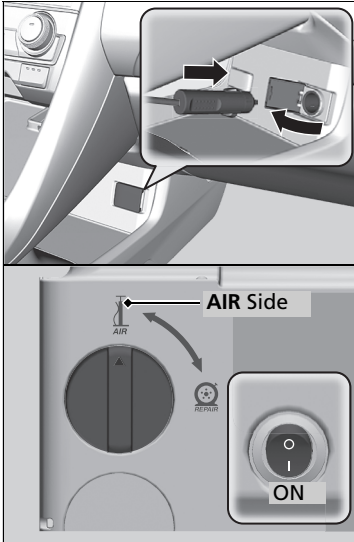

5. Turn the selector switch to AIR.

- ▶ Do not turn the air compressor on to check the pressure.

▶ **Inflating an Under-inflated Tire** P. 579

▶▶ Distributing the Sealant in the Tire

⚠ WARNING

Running the engine with the vehicle in an enclosed or even partly enclosed area can cause a rapid build-up of toxic carbon monoxide.

Breathing this colorless, odorless gas can cause unconsciousness and even death. Only run the engine to power the air compressor with the vehicle outdoors.

6. If the air pressure is

- Less than 25 psi (175 kPa):

Do not add air or continue driving. The leak is too severe. Call for help and have your vehicle towed.

🔧 **Emergency Towing** P. 601

- Front: 33 psi (225 kPa)/rear: 32 psi (220kPa) or more:

Continue driving for another 10 minutes or until you reach the nearest service station, whichever is sooner. Do not exceed 50 mph (80 km/h).

▶ Stop and check the air pressure again. If the air pressure does not go down after the 10 minute drive, you do not need to check the pressure any more.

Drive to the nearest service station to fix or replace the tire.

- Greater than 25 psi (175 kPa), but less than specified pressure:

Turn the air compressor on to inflate the tire until the tire pressure reaches specified pressure.

🔧 **Inflating an Under-inflated Tire** P. 579

Then drive carefully for 10 more minutes or until you reach the nearest service station, whichever is sooner. Do not exceed 50 mph (80 km/h).

▶ You should repeat this procedure as long as the air pressure is within this range.

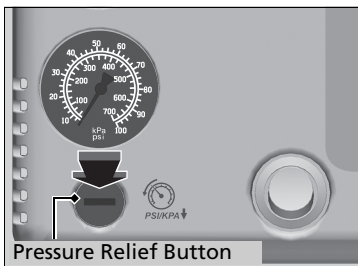

7. Unplug the kit from the accessory power socket.
8. Unscrew the sealant/air hose from the tire valve stem. Reinstall the valve cap.
9. Press the pressure relief button until the gauge returns to 0 psi (0 kPa).
10. Repackage and properly stow the kit.

■ Inflating an Under-inflated Tire

You can use the kit to inflate a non-punctured under-inflated tire.

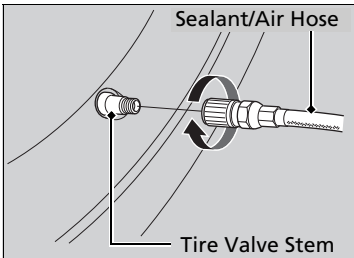
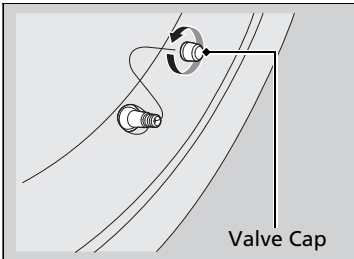
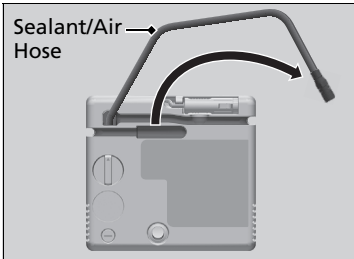

1. Open the trunk floor lid.
 - **Getting Ready to Temporarily Repair the Flat Tire** P. 571
2. Remove the kit from the case.
3. Place the kit, face up, on flat ground near the flat tire, away from traffic. Do not place the kit on its side.
4. Remove the sealant/air hose from the kit.
5. Remove the valve cap.
6. Attach the sealant/air hose onto the tire valve stem. Screw the sealant/air hose until it is tightly connected to the tire valve stem.

▶▶ Inflating an Under-inflated Tire

NOTICE

Do not operate the temporary tire repair kit compressor for more than 15 minutes. The compressor can overheat and become permanently damaged.

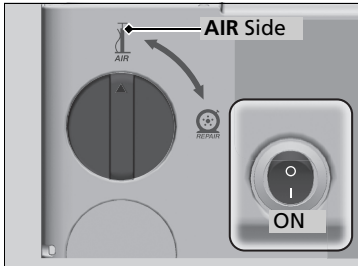
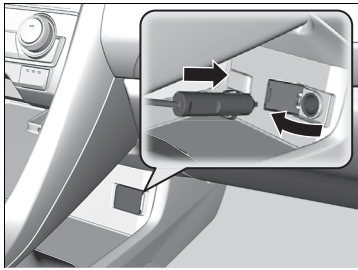

7. Plug in the kit to the accessory power socket.
 - ▶ Be careful not to pinch the cord in a door or window.
 - ❏ **Accessory Power Socket** P. 186
8. Start the engine.
 - ❏ **Starting the Engine** P. 415
 - ▶ Keep the engine running while injecting air.
 - ❏ **Carbon Monoxide Gas** P. 73
9. Turn the selector switch to **AIR**.
10. Press the inflator switch to turn on the kit.
 - ▶ The compressor starts to inject air into the tire.
11. Inflate the tire to the specified air pressure.

▶▶ Inflating an Under-inflated Tire

⚠ WARNING

Running the engine with the vehicle in an enclosed or even partly enclosed area can cause a rapid build-up of toxic carbon monoxide.

Breathing this colorless, odorless gas can cause unconsciousness and even death. Only run the engine to power the air compressor with the vehicle outdoors.

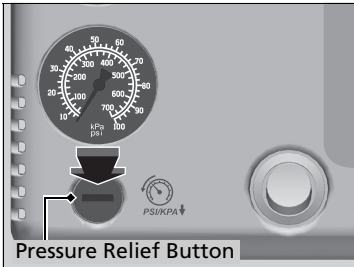

- 12.** Turn off the kit.
 - ▶ Check the pressure gauge on the air compressor.
 - ▶ If overinflated, press the pressure relief button.
- 13.** Unplug the kit from the accessory power socket.
- 14.** Unscrew the sealant/air hose from the tire valve stem. Reinstall the valve cap.
- 15.** Press the pressure relief button until the gauge returns to 0 psi (0 kPa).
- 16.** Repackage and properly stow the kit.

Checking the Engine

If the engine does not start, check the starter.

☞ Checking the Engine

If you must start the vehicle immediately, use an assisting vehicle to jump start it.

☞ **Jump Starting** P. 585

Starter condition

Checklist

Starter doesn't turn or turns over slowly.

The battery may be dead. Check each of the items on the right and respond accordingly.

Models with smart entry system

If a message **To Start, Hold Remote Near Start Button** appears on the driver information interface*, or you hear beeping when you push the **ENGINE START/STOP** button.

☞ **If the Smart Entry Remote Battery is Weak** P. 583

▶ Make sure the smart entry remote is in its operating range.

☞ **ENGINE START/STOP Button Operating Range** P. 156

Check the brightness of the interior lights.

Turn on the interior lights and check the brightness.

- If the interior lights are dim or do not come on at all

☞ **Battery** P. 549

- If the interior lights come on normally

☞ **Fuses** P. 597

The starter turns over normally but the engine doesn't start.

There may be a problem with the fuse. Check each of the items on the right and respond accordingly.

Review the engine start procedure.

Follow its instructions, and try to start the engine again.

☞ **Starting the Engine** P. 412, 415

Check the immobilizer system indicator.

When the immobilizer system indicator is blinking, the engine cannot be started.

☞ **Immobilizer System** P. 148

Check the fuel level.

There should be enough fuel in the tank.

☞ **Fuel Gauge** P. 110

Check the fuse.

Check all fuses, or have the vehicle checked by a dealer.

☞ **Inspecting and Changing Fuses** P. 600

If the problem continues:

☞ **Emergency Towing** P. 601

Models with smart entry system

If the Smart Entry Remote Battery is Weak

If the beeper sounds, the **ENGINE START/STOP** button flashes, and the engine won't start.

Models with driver information interface

The **To Start, Hold Remote Near Start Button** message appears on the driver information interface.

All models

Start the engine as follows:

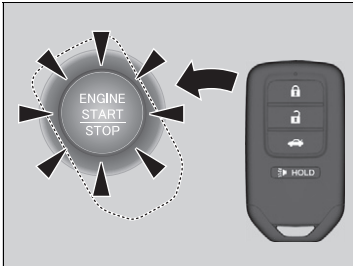

1. Touch the center of the **ENGINE START/STOP** button with the **H** logo on the smart entry remote while the **ENGINE START/STOP** button is flashing. The buttons on the smart entry remote should be facing you.

▶ The **ENGINE START/STOP** button flashes for about 30 seconds.

2. Depress the brake pedal (continuously variable transmission) or clutch pedal (manual transmission) and press the **ENGINE START/STOP** button within 10 seconds after the beeper sounds and the **ENGINE START/STOP** button changes from flashing to on.

▶ If you don't depress the pedal, the mode will change to **ACCESSORY**.

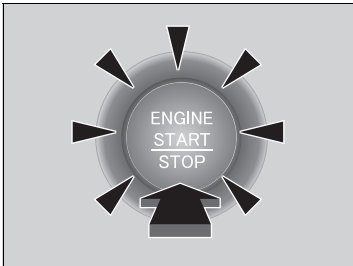

Models with smart entry system

Emergency Engine Stop

The **ENGINE START/STOP** button may be used to stop the engine due to an emergency situation even while driving. If you must stop the engine, do either of the following operations:

- Press and hold the **ENGINE START/STOP** button for about two seconds.
- Firmly press the **ENGINE START/STOP** button three times.

The steering wheel will not lock. However, because turning off the engine disables the power assist the engine provides to the steering and braking systems, it will require significantly more physical effort and time to steer and slow the vehicle. Use both feet on the brake pedal to slow down the vehicle and stop immediately in a safe place. With manual transmission models you can also downshift the transmission to utilize engine braking.

Continuously variable transmission models

The power mode is in ACCESSORY when the engine is stopped. To change the mode to VEHICLE OFF, move the shift lever to **P** after the vehicle comes to a complete stop.

Canadian continuously variable transmission models

Then press the **ENGINE START/STOP** button twice without depressing the brake pedal.

Manual transmission models

The power mode changes to VEHICLE OFF.

Emergency Engine Stop

Do not press the button while driving unless it is absolutely necessary for the engine to be switched off.

Jump Starting Procedure

Jump Starting Procedure

Turn off the power to electric devices, such as audio and lights. Turn off the engine, then open the hood.

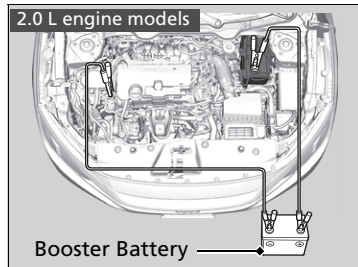
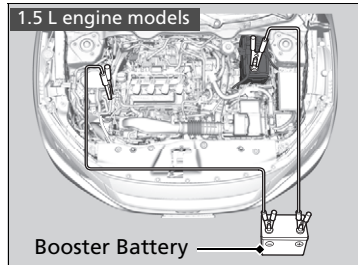

1. Connect the first jumper cable to your vehicle's battery \oplus terminal.
2. Connect the other end of the first jumper cable to the booster battery \oplus terminal.
 - ▶ Use a 12-volt booster battery only.
 - ▶ When using an automotive battery charger to boost your 12-volt battery, select a lower charging voltage than 15-volt. Check the charger manual for the proper setting.
3. Connect the second jumper cable to the booster battery \ominus terminal.

Jump Starting

⚠ WARNING

A battery can explode if you do not follow the correct procedure, seriously injuring anyone nearby.

Keep all sparks, open flames, and smoking materials away from the battery.

Securely attach the jumper cables clips so that they do not come off when the engine vibrates. Also be careful not to tangle the jumper cables or allow the cable ends to touch each other while attaching or detaching the jumper cables.

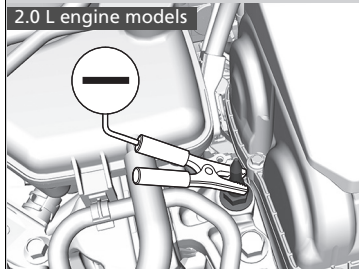
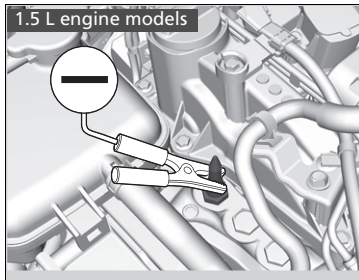

4. Connect the other end of the second jumper cable to the engine mounting bolt as shown. Do not connect this jumper cable to any other part.
5. If your vehicle is connected to another vehicle, start the assisting vehicle's engine and increase its rpm slightly.
6. Attempt to start your vehicle's engine. If it turns over slowly, check that the jumper cables have good metal-to-metal contact.

▶▶ Jump Starting

Battery performance degrades in cold conditions and may prevent the engine from starting.

What to Do After the Engine Starts

Once your vehicle's engine has started, remove the jumper cables in the following order.

1. Disconnect the jumper cable from your vehicle's ground.
2. Disconnect the other end of the jumper cable from the booster battery ⊖ terminal.
3. Disconnect the jumper cable from your vehicle's battery ⊕ terminal.
4. Disconnect the other end of the jumper cable from the booster battery ⊕ terminal.

Have your vehicle inspected by a nearby service station or a dealer.

What to Do After the Engine Starts

The indicators for the Vehicle Stability Assist (VSA®) system, Vehicle Stability Assist (VSA®) OFF, Low Tire Pressure/TPMS* and Collision Mitigation Braking System™ (CMBS™)* may come on after re-connecting the battery. Drive a short distance at more than 12 mph (20 km/h). The indicators should go off. If they do not, have your vehicle checked by a dealer.

* Not available on all models

Shift Lever Does Not Move

Continuously variable transmission models

Follow the procedure below if you cannot move the shift lever out of the **P** position.

Releasing the Lock

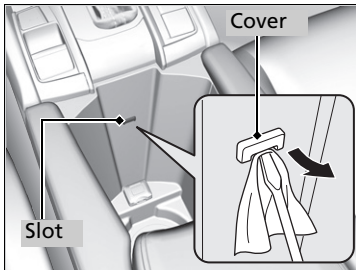

1. Set the parking brake.

Models without smart entry system

2. Remove the key from the ignition switch.

Models with smart entry system

2. Remove the built-in key from the smart entry remote.

All models

3. Move the removable beverage holder tray rearward.

➤ **Front seat beverage holders** P. 184

4. Wrap a cloth around the tip of a small flat-tip screwdriver to remove the cover of the shift lock release slot. Put the tip of the flat-tip screwdriver into the slot and remove it as shown in the image.

5. Insert the key into the shift lock release slot.

6. While pushing the key in, press the shift lever release button and place the shift lever into **N**.

▶ The lock is now released. Have the shift lever checked by a dealer as soon as possible.

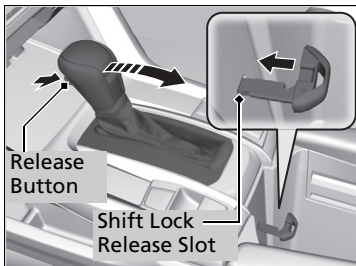

How to Handle Overheating

Overheating symptoms are as follows:

- The temperature gauge pointer is at the **H** mark or the engine suddenly loses power.
- Steam or spray comes out of the engine compartment.

■ First thing to do

1. Immediately park the vehicle in a safe place.
2. Turn off all accessories and turn on the hazard warning lights.
 - ▶ **No steam or spray present:** Keep the engine running and open the hood.
 - ▶ **Steam or spray is present:** Turn off the engine and wait until it subsides. Then open the hood.

☒ How to Handle Overheating

⚠ WARNING

Steam and spray from an overheated engine can seriously scald you.

Do not open the hood if steam is coming out.

NOTICE

Continuing to drive with the temperature gauge pointer at the **H** mark may damage the engine.

■ Next thing to do

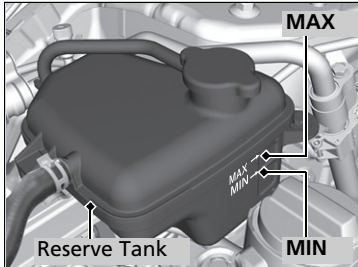

1. Check that the cooling fan is operating and stop the engine once the temperature gauge pointer comes down.
 - If the cooling fan is not operating, immediately stop the engine.
2. Once the engine has cooled down, inspect the coolant level and check the cooling system components for leaks.
 - If the coolant level in the reserve tank is low, or no coolant in the tank, check that the radiator is cool. Cover the reserve tank cap with a heavy cloth and open the cap. Add coolant until it reaches the **MAX** mark, and put the cap back on.

■ Last thing to do

Once the engine has cooled sufficiently, restart it and check the temperature gauge. If the temperature gauge pointer has gone down, resume driving. If it has not gone down, contact a dealer for repairs.

► How to Handle Overheating

⚠ WARNING

Removing the reserve tank cap while the engine is hot can cause the coolant to spray out, seriously scalding you.

Always let the engine and radiator cool down before removing the reserve tank cap.

If the coolant is leaking, contact a dealer for repairs.

Use water as an emergency/temporary measure only. Have a dealer flush the system with proper antifreeze as soon as possible.

If the Low Oil Pressure Indicator Comes On



■ Reasons for the indicator to come on

Comes on when the engine oil pressure is low.

■ What to do as soon as the indicator comes on

1. Immediately park the vehicle on level ground in a safe place.
2. If necessary, turn the hazard warning lights on.

■ What to do after parking the vehicle

1. Stop the engine and let it sit for about three minutes.
2. Open the hood and check the oil level.
 - ▶ Add oil as necessary.
📖 **Oil Check** P. 516
3. Start the engine and check the low oil pressure indicator.
 - ▶ The indicator goes off: Start driving again.
 - ▶ The indicator does not go off within 10 seconds: Stop the engine and contact a dealer for repairs immediately.

If the Charging System Indicator Comes On



■ Reasons for the indicator to come on

Comes on when the battery is not being charged.

■ What to do when the indicator comes on

Turn off the climate control system, rear defogger, and other electrical systems, and immediately contact a dealer for repairs.

📖 If the Low Oil Pressure Indicator Comes On

NOTICE

Running the engine with low oil pressure can cause serious mechanical damage almost immediately.

📖 If the Charging System Indicator Comes On

If you need to stop temporarily, do not turn off the engine. Restarting the engine may rapidly discharge the battery.

If the Malfunction Indicator Lamp Comes On or Blinks



■ Reasons for the indicator lamp to come on or blink

- Comes on when there is a problem with the engine emissions control system.
- Blinks when engine misfiring is detected.

■ What to do when the indicator lamp comes on

Avoid high speeds and immediately get your vehicle inspected at a dealer.

■ What to do when the indicator lamp blinks

Park the vehicle in a safe place with no flammable items and wait at least 10 minutes or more with the engine stopped until it cools.

ⓘ If the Malfunction Indicator Lamp Comes On or Blinks

NOTICE

If you drive with the malfunction indicator lamp on, the emissions control system and the engine could be damaged.

If the malfunction indicator lamp blinks again when restarting the engine, drive to the nearest dealer at 31 mph (50 km/h) or less. Have your vehicle inspected.

If the Brake System Indicator (Red) Comes On or Blinks



■ Reasons for the indicator to come on

- The brake fluid is low.
- There is a malfunction in the brake system.

■ What to do when the indicator comes on while driving

Depress the brake pedal lightly to check pedal pressure.

- If normal, check the brake fluid level the next time you stop.
- If abnormal, take immediate action. If necessary, downshift the transmission to slow the vehicle using engine braking.

■ Reason for the indicator to blink

- There is a problem with the electric parking brake system.

■ What to do when the indicator blinks

Avoid using the parking brake and have your vehicle checked by a dealer immediately.

▶▶ If the Brake System Indicator (Red) Comes On or Blinks

Have your vehicle repaired immediately.

It is dangerous to drive with low brake fluid. If there is no resistance from the brake pedal, stop immediately in a safe place. If necessary downshift the gears.

If the brake system indicator and **ABS** indicator come on simultaneously, the electronic brake distribution system is not working. This can result in vehicle instability under sudden braking. Have your vehicle inspected by a dealer immediately.

If the brake system indicator (red) blinks at the same time when the brake system indicator (amber) comes on, the parking brake may not work. Avoid using the parking brake and have your vehicle checked by a dealer immediately.

▶▶ **If the Brake System Indicator (Red) Comes On or Blinks at the Same Time When the Brake System Indicator (Amber) Comes On**
P. 594

If you repeatedly operate the electric parking brake in a short period of time, the brake stops operating to prevent heating of the system and the indicator blinks. It returns to its original state in approximately one minute.

If the Brake System Indicator (Red) Comes On or Blinks at the Same Time When the Brake System Indicator (Amber) Comes On

⚠ If the Brake System Indicator (Red) Comes On or Blinks at the Same Time When the Brake System Indicator (Amber) Comes On

If you apply the parking brake, you may not be able to release it.

If the brake system indicator (red) and the brake system indicator (amber) come on at the same time, the parking brake is working.

If the brake system indicator (red) blinks at the same time when the brake system indicator (amber) comes on, the parking brake may not work because it is checking the system.



■ If the brake system indicator (red) comes on or blinks at the same time when the brake system indicator (amber) comes on, release the parking brake manually or automatically.

🔧 **Parking Brake** P. 474

• If the brake system indicator (red) continuously comes on or blinks at the same time when the brake system indicator (amber) comes on, stop the vehicle in a safe place and have it inspected by a dealer immediately.

▶ Preventing the vehicle from moving

Continuously variable transmission models

Move the shift lever to **P**.

Manual transmission models

Move the shift lever to **1** or **R**.

• If the brake system indicator (amber) comes on alone, avoid using the parking brake and have your vehicle checked by a dealer immediately.



If the Electric Power Steering (EPS) System Indicator Comes On



■ Reasons for the indicator to come on

- Comes on when there is a problem with the EPS system.
- If you depress the accelerator pedal repeatedly to increase the engine speed while the engine is idling, the indicator comes on, and sometimes the steering wheel becomes harder to operate.
- Comes on when EPS steering angle center point memory is lost. This could be due to a number of problems to include: battery disconnect, main fuse blow, low battery causing reset of the EPS system, wire damage to EPS harness. Vehicle Stability Assist (VSA®) system, VSA® OFF, Collision Mitigation Braking System™ (CMBS™)*, and low tire pressure/TPMS* indicators also come on.

Models with driver information interface

The **Drive Carefully Systems Initializing...** message appears on the driver information interface.

■ What to do when the indicator comes on

- Stop the vehicle in a safe place and restart the engine.
If the indicator comes on and stays on, immediately have your vehicle inspected by a dealer.
- If the EPS indicator, VSA® system indicator, VSA® OFF indicator, CMBS™ indicator*, and low tire pressure/TPMS indicator* come on simultaneously, you need to calibrate the VSA and EPS systems.
Drive at a speed of more than 12 mph (20 km/h) to calibrate the VSA and EPS systems.
If the indicators come on and stay on, park your vehicle in a safe place, turn off and restart the engine, then repeat the above operation.
If the indicators still come on and stay on, immediately have your vehicle inspected by a dealer.

* Not available on all models

U.S. models

If the Low Tire Pressure/TPMS Indicator Comes On or Blinks



■ Reasons for the indicator to come on or blink

A tire pressure is significantly low, or the TPMS has not been calibrated. If there is a problem with the TPMS or the compact spare tire* is installed, the indicator blinks for about one minute, and then stays on.

■ What to do when the indicator comes on

Drive carefully and avoid abrupt cornering and hard braking. Stop your vehicle in a safe place. Check the tire pressure and adjust the pressure to the specified level. The specified tire pressure is on a label on the driver-side doorjamb.

▶ Calibrate the TPMS after the tire pressure is adjusted.

■ What to do when the indicator blinks, then remains on

Have the tire inspected by a dealer as soon as possible. If the compact spare tire causes the indicator to blink, change the tire to a full-size tire. The indicator goes off after driving for a few miles (kilometers).

▶ Calibrate the TPMS after a full-size tire is reinstalled.

▶▶ If the Low Tire Pressure/TPMS Indicator Comes On or Blinks

NOTICE

Driving on an extremely underinflated tire can cause it to overheat. An overheated tire can fail. Always inflate your tires to the prescribed level.

Fuse Locations

If any electrical devices are not working, turn the ignition switch to LOCK [0]^{*1} and check to see if any applicable fuse is blown.

Engine Compartment Fuse Box

Located near the battery. Push the tabs to open the box.

Fuse locations are shown on the fuse box cover. Locate the fuse in question by the fuse number and box cover number.

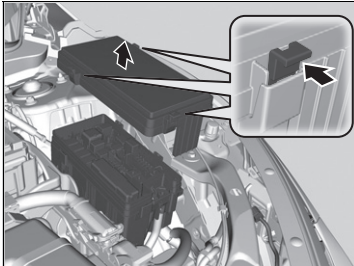

■ Circuit protected and fuse rating

	Circuit Protected	Amps
1	— ^{*2}	(60 A)
	Adaptive Damper System ^{*3}	60 A
	Cooling Fan ^{*4}	(30 A)
	Cooling Fan ^{*5}	(50 A)
	—	—
2	IG Main ^{*6}	30 A
	— ^{*7}	—
	Headlight High Beam Main	30 A
	Battery	125 A
	EPS	70 A
	IG Main	30 A ^{*6}
		50 A ^{*7}
	Fuse Box Option [*]	(40 A)
	Fuse Box	60 A
	Front Wiper Motor	30 A
3	Headlight Low Beam Main	30 A
	Rear Defroster	40 A
	Starter Motor ^{*6}	30 A
	— ^{*7}	—
	Fuse Box	40 A
	ABS/VSA Motor	40 A
	ABS/VSA FSR	40 A
Blower Motor	40 A	

	Circuit Protected	Amps
4	—	—
	—	—
	—	—
	—	—
5	Cooling Fan	5 A
6	Washer	15 A
7	FI Main	15 A
8	FI Sub	15 A
9	Stop Lights	10 A
10	Injector ^{*5}	(15 A)
11	LAF	5 A
12	FI ECU	10 A
13	Parking Lights	10 A
14	Hazard	15 A
15	IG Coil	15 A
16	Transmission ^{*8}	(15 A)

*1: Models with the smart entry system have an **ENGINE START/STOP** button instead of an ignition switch.

*2: Models without SPORT mode

*3: Models with SPORT mode

*4: 2.0L engine models

*5: 1.5L engine models

*6: Models with smart entry system

*7: Models without smart entry system

*8: Continuously variable transmission models

* Not available on all models

	Circuit Protected	Amps
17	Daytime Running Lights	10 A
18	Back Up	10 A
19	Audio	15 A
20	Audio AMP*	(30 A)
21	Interior Lights	10 A
22	Front Fog Lights*	(15 A)
23	A/C Compressor	(10 A)
24	Horn	10 A
25	Left Headlight Low Beam	10 A
26	Right Headlight Low Beam	10 A
27	VB ACT* ⁵	(10 A)
28	Left Headlight High Beam	10 A
29	Right Headlight High Beam	10 A
30	–	–
31	–	(15 A)
32	–	(20 A) ^{*2} – ^{*3}
33	– ^{*2} Adaptive Damper System ^{*3}	(20 A) 15 A
34	–	–
35	–	–
36	–	–

*2: Models without SPORT mode
 *3: Models with SPORT mode
 *5: 1.5L engine models

■ Interior Fuse Box

Located under the dashboard.

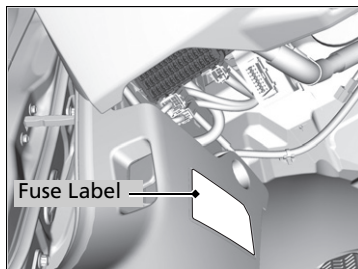

Fuse locations are shown on the label on the side panel.

Locate the fuse in question by the fuse number and label number.

■ Circuit protected and fuse rating

	Circuit Protected	Amps
1	Accessory	10 A
2	– ^{*1} Key Lock ^{*2}	– (5 A)
3	–	–
4	Front Sensor Camera ^{*1, *3} Transmission ^{*2, *4}	(5 A) (10 A)
5	Option	10 A
6	SRS Indicator	10 A
7	Meter	10 A
8	Fuel Pump	15 A

	Circuit Protected	Amps
9	AIRCON	10 A
10	–	–
11	Engine Control	5 A
12	Passenger Side Door Lock	10 A
13	–	(10 A)
14	–	(20 A)
15	Passenger's Side Power Window	20 A
16	Door Lock	20 A
17	Transmission ^{*1, *4} Front Sensor Camera ^{*2, *3}	(10 A) (5 A)
18	–	–
19	Moonroof*	(20 A)
20	–	–
21	ACG	10 A
22	Daytime Running Lights	10 A
23	–	–
24	Front Sensor Camera*	(5 A)
25	Driver's Door Lock	10 A
26	Passenger Side Door Unlock	10 A
27	–	(20 A)
28	Driver's Power Window	20 A

*1: Models with smart entry system
 *2: Models without smart entry system
 *3: Models with CMBS™
 *4: Continuously variable transmission models

	Circuit Protected	Amps
29	Front Accessory Power Socket	20 A
30	Smart Entry* ¹ _ ²	10 A –
31	–	(20 A)
32	Front Seat Heater*	(20 A)
33	–	(20 A)
34	VSA/ABS	10 A
35	SRS	10 A
36	–	–
37	–	–
38	–	(10 A)
39	Driver's Door Unlock	10 A

*1: Models with smart entry system

*2: Models without smart entry system

Inspecting and Changing Fuses

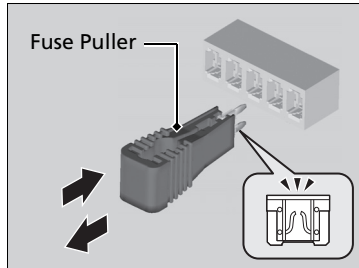
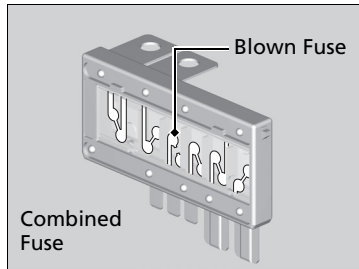

1. Turn the ignition switch to LOCK **0***1. Turn headlights and all accessories off.
2. Remove the fuse box cover.
3. Check the large fuse in the engine compartment.
 - If the fuse is blown, use a Phillips-head screwdriver to remove the screw and replace it with a new one.
4. Inspect the small fuses in the engine compartment and the vehicle interior.
 - If there is a burned out fuse, remove it with the fuse puller and replace it with a new one.

► Inspecting and Changing Fuses

NOTICE

Replacing a fuse with one that has a higher rating greatly increases the chances of damaging the electrical system.

There is a fuse puller on the back of the engine compartment fuse box cover.

*1: Models with the smart entry system have an **ENGINE START/STOP** button instead of an ignition switch.

Call a professional towing service if you need to tow your vehicle.

■ Flat bed equipment

The operator loads your vehicle on the back of a truck.

This is the best way to transport your vehicle.

■ Wheel lift equipment

The tow truck uses two pivoting arms that go under the front tires and lift them off the ground. The rear tires remain on the ground. **This is an acceptable way to tow your vehicle.**

» Emergency Towing

NOTICE

Trying to lift or tow your vehicle by the bumpers will cause serious damage. The bumpers are not designed to support the vehicle's weight.

NOTICE

Improper towing such as towing behind a motorhome or other motor vehicle can damage the transmission.

Never tow your vehicle with just a rope or chain. It is very dangerous, since ropes or chains may shift from side to side or break.

Make sure the parking brake is released. If you cannot release the parking brake, your vehicle must be transported by the flat bed equipment.

➤ **Parking Brake** P. 474

What to Do When Unable to Unlock the Fuel Fill Door

If you cannot unlock the fuel fill door, use the following procedure.

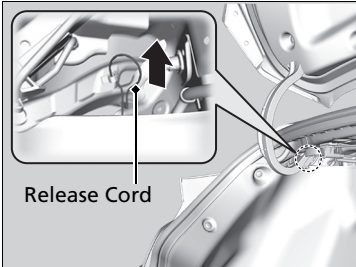

1. Open the trunk.
2. Pull the yellow release cord beneath the rear tray as shown.
 - ▶ The release cord unlocks the fuel fill door when it is pulled.

When You Cannot Unlock the Fuel Fill Door

After taking these steps, contact a dealer to have your vehicle checked.

What to Do When Unable to Open the Trunk

If you cannot open the trunk, use the following procedure.

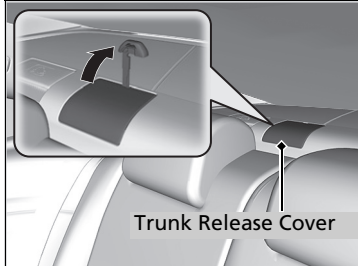

1. Remove the cover with a key.
 - ▶ Wrap a key with a cloth to prevent scratching the cover.

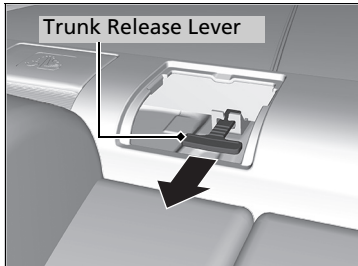

2. Pull the release lever.
3. Replace the cover.

When You Cannot Open the Trunk

Following up:

After taking these steps, contact a dealer to have your vehicle checked.

Refueling From a Portable Fuel Container

If you have run out of fuel and need to refuel your vehicle from a portable fuel container, use the funnel provided with your vehicle.

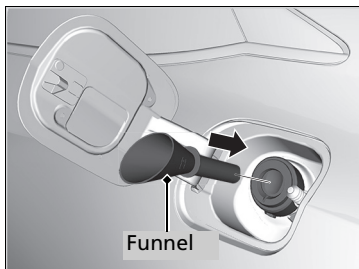

1. Turn off the engine.
2. Press on the edge of the fuel fill door to make it pop up slightly.
 - ▶ The fuel fill door opens.
3. Take the funnel out of the tool case in the trunk.
 - ▶ **Types of Tools** P. 562
4. Place the end of the funnel on the lower part of filler opening, then insert it slowly and fully.
 - ▶ Make sure that the end of the funnel goes down along with the filler pipe.
5. Fill the tank with fuel from the portable fuel container.
 - ▶ Pour fuel carefully so you do not spill any.
6. Remove the funnel from the filler neck.
 - ▶ Wipe up any fuel from the funnel before storing it.
7. Shut the fuel fill door by hand.

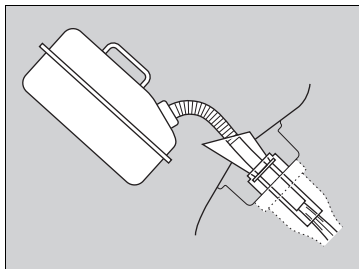

▶▶ Refueling From a Portable Fuel Container

WARNING

Gasoline is highly flammable and explosive. You can be burned or seriously injured when handling fuel.

- Stop the engine, and keep heat, sparks, and flame away.
- Handle fuel only outdoors.
- Wipe up spills immediately.

NOTICE

Do not insert the nozzle of a portable fuel container or any funnel other than the one provided with your vehicle. Doing so can damage the fuel system. Do not try to pry open or push open the sealed fuel tank with foreign objects. This can damage the fuel system and its seal.

Make sure the fuel in the portable fuel container is gasoline before you refuel.

Information

This chapter includes your vehicle's specifications, locations of identification numbers, and other information required by regulation.

Specifications	606
Identification Numbers	
Vehicle Identification Number (VIN), Engine Number, and Transmission Number	610
Devices that Emit Radio Waves	611
Reporting Safety Defects	612
Emissions Testing	
Testing of Readiness Codes	613
Warranty Coverages	615
Authorized Manuals	617
Customer Service Information	618

2.0 L engine models

Vehicle Specifications

Model	Civic Coupe
No. of Passengers:	
Front	2
Rear	3
Total	5
Weights:	
Gross Vehicle	U.S.: 3,737 lbs (1,695 kg)
Weight Rating	Canada: 1,695 kg
Gross Axle Weight	
Rating (Front)	U.S.: 1,984 lbs (900 kg) Canada: 900 kg
Gross Axle Weight	
Rating (Rear)	U.S.: 1,786 lbs (810 kg) Canada: 810 kg

Air Conditioning

Refrigerant Type	HFO-1234yf (R-1234yf)
Charge Quantity	13.2 – 15.0 oz (375 – 425 g)
Lubricant Type	RL85HM (POE)
Quantity	4.7 – 6.3 cu-in (77 – 103 cm ³)

Engine Specifications

Displacement	121.76 cu-in (1,996 cm ³)	
Spark Plugs	NGK	DILKAR7H11GS
		DILKAR7G11GS
	DENSO	DXE22HQR-D11S

Fuel

Fuel:	Unleaded gasoline, Pump octane number
Type	of 87 or higher
Fuel Tank Capacity	12.39 US gal (46.9 L)

Washer Fluid

Tank Capacity	U.S.: 2.6 US qt (2.5 L)
	Canada: 4.8 US qt (4.5 L)

Light Bulbs

Headlights (Low Beam)	55 W (H11)
Headlights (High Beam)	60 W (HB3)
Parking/Daytime Running Lights	LED
Front Side Marker Lights	3 W
Front Turn Signal Lights	21 W (Amber)
Brake Lights	21 W
Rear Turn Signal Lights	21 W (Amber)
Tail/Rear Side Marker Lights	LED
Back-Up Lights	6 W
Taillight	LED
High-Mount Brake Light	LED
Rear License Plate Light	LED
Interior Lights	
Map Lights	8 W
Ceiling Light	8 W
Trunk Light	5 W

■ Brake/Clutch* Fluid

Specified	Honda Heavy Duty Brake Fluid DOT 3
-----------	------------------------------------

■ Continuously Variable Transmission Fluid*

Specified	Honda HCF-2 Transmission Fluid
Capacity	Change 3.7 US qt (3.5 L)

■ Manual Transmission Fluid*

Specified	Honda Manual Transmission Fluid (MTF)
Capacity	Change 2.0 US qt (1.9 L)

■ Engine Oil

Recommended	-Genuine Honda Motor Oil 0W-20
	-API Premium-grade 0W-20 detergent oil
Capacity	Change 4.2 US qt (4.0 L)
	Change including filter 4.4 US qt (4.2 L)

■ Engine Coolant

Specified	Honda Long-Life Antifreeze/Coolant Type2
Ratio	50/50 with distilled water
Capacity	1.41 US gal (5.32 L)
	(change including the remaining 0.2 US gal (0.75 L) in the reserve tank)

■ Tire

Regular	Size	215/55R16 93H
	Pressure psi (kPa [kgf/cm ²])	32 (220 [2.2])
Compact Spare	Size	T125/80D16 97M
	Pressure psi (kPa [kgf/cm ²])	60 (420 [4.2])
Wheel Size	Regular	16 x 7J
	Compact Spare	16 x 4T

* Not available on all models

1.5 L engine models

Vehicle Specifications

Model	Civic Coupe
-------	-------------

No. of Passengers:	
Front	2
Rear	3
Total	5

Weights:	
Gross Vehicle Weight Rating	U.S.: 3,902 lbs (1,770 kg) ^{*1} Canada: 1,770 kg ^{*1} U.S.: 3,836 lbs (1,740 kg) ^{*2} Canada: 1,740 kg ^{*2}

Gross Axle Weight Rating (Front)	U.S.: 2,105 lbs (955 kg) ^{*1} Canada: 955 kg ^{*1} U.S.: 2,039 lbs (925 kg) ^{*2} Canada: 925 kg ^{*2}
----------------------------------	--

Gross Axle Weight Rating (Rear)	U.S.: 1,808 lbs (820 kg) ^{*1, *2} Canada: 820 kg ^{*1, *2}
---------------------------------	--

*1: Models without SPORT mode
*2: Models with SPORT mode

Air Conditioning

Refrigerant Type	HFO-1234yf (R-1234yf)
Charge Quantity	13.2 – 15.0 oz (375 – 425 g)
Lubricant Type	RL85HM (POE)
Quantity	4.7 – 6.3 cu-in (77 – 103 cm ³)

Engine Specifications

Displacement	91.38 cu-in (1,498 cm ³)
Spark Plugs	NGK ILZKAR8H8S ^{*1} NGK ILZKAR8J8SY ^{*2}

*1: Models without SPORT mode
*2: Models with SPORT mode

Fuel

Fuel:	Unleaded gasoline, Pump octane number of 87 or higher ^{*1}
Type	Unleaded premium gasoline, Pump octane number of 91 or higher ^{*2}
Fuel Tank Capacity	12.39 US gal (46.9 L)

*1: Models without SPORT mode
*2: Models with SPORT mode

Washer Fluid

Tank Capacity	U.S.: 2.6 US qt (2.5 L) Canada: 4.8 US qt (4.5 L)
---------------	--

Light Bulbs

Headlights (Low Beam)	55 W (H11) ^{*1} LED ^{*2}
Headlights (High Beam)	60 W (HB3) ^{*1} LED ^{*2}
Fog Lights	35 W (H8)
Parking/Daytime Running Lights	LED
Front Side Marker Lights	3 W
Front Turn Signal Lights	21 W (Amber) ^{*1} LED ^{*2}
Side Turn Signal Lights (on Door Mirrors) [*]	LED
Brake Lights	21 W
Rear Turn Signal Lights	21 W (Amber)
Tail/Rear Side Marker Lights	LED
Back-Up Lights	6 W
Taillight	LED
High-Mount Brake Light	LED
Rear License Plate Light	LED
Interior Lights	
Map Lights	8 W
Ceiling Light	8 W
Vanity Mirror Lights [*]	2 W
Trunk Light	5 W

*1: Models with halogen headlights
*2: Models with LED headlights

■ Brake/Clutch* Fluid

Specified	Honda Heavy Duty Brake Fluid DOT 3
-----------	------------------------------------

■ Continuously Variable Transmission Fluid*

Specified	Honda HCF-2 Transmission Fluid
Capacity	Change 3.9 US qt (3.7 L)

■ Manual Transmission Fluid*

Specified	Honda Manual Transmission Fluid (MTF)
Capacity	Change 2.0 US qt (1.9 L)

■ Engine Oil

Recommended	-Genuine Honda Motor Oil 0W-20
	-API Premium-grade 0W-20 detergent oil
Change	3.4 US qt (3.2 L)
	Capacity
Change including filter	3.7 US qt (3.5 L)

■ Engine Coolant

Specified	Honda Long-Life Antifreeze/Coolant Type2
Ratio	50/50 with distilled water
Capacity	1.34 US gal (5.09 L)*1
	(change including the remaining 0.2 US gal (0.75 L) in the reserve tank)
	1.32 US gal (5.01 L)*2
	(change including the remaining 0.2 US gal (0.75 L) in the reserve tank)

*1: Continuously variable transmission models
 *2: Manual transmission models

■ Tire

Regular	Size	215/50R17 91H*1 235/40R18 91W*2 235/40R18 95Y*3
	Pressure psi (kPa [kgf/cm ²])	Front 32 (220 [2.2])*1 33 (225 [2.3])*2, *3
		Rear 32 (220 [2.2])*1, *2, *3
Compact Spare*	Size	T125/80D16 97M*1 T125/70R17 98M*4, *5
	Pressure psi (kPa [kgf/cm ²])	60 (420 [4.2])
Wheel Size	Regular	17 x 7J*1 18 x 8J*2, *3
	Compact Spare*	16 x 4T*1 17 x 4T*4, *5

*1: Models without SPORT mode
 *2: Models with SPORT mode
 *3: U.S. model with SPORT mode with optional 235/40R18 95Y tires
 *4: U.S. model with SPORT mode with optional spare tire
 *5: Canadian model with SPORT mode

* Not available on all models

Vehicle Identification Number (VIN), Engine Number, and Transmission Number

Your vehicle has a 17-digit vehicle identification number (VIN) used to register your vehicle for warranty purposes, and for licensing and insuring your vehicle. The locations of your vehicle's VIN, engine number, and transmission number are shown as follows.

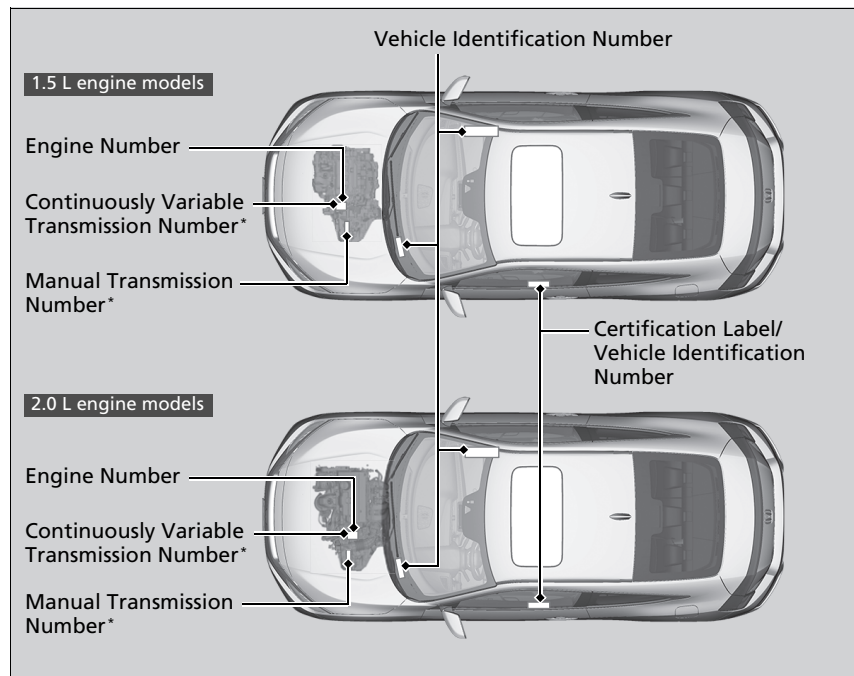

Vehicle Identification Number (VIN), Engine Number, and Transmission Number

The interior vehicle identification number (VIN) is located under the cover.

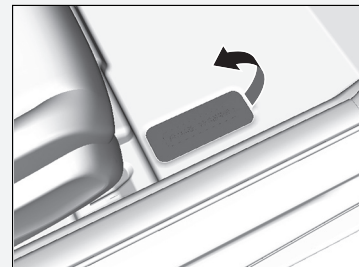

Devices that Emit Radio Waves

The following products and systems on your vehicle emit radio waves when in operation.

Audio System

Bluetooth® Audio

Bluetooth® HandsFreeLink®

Collision Mitigation Braking System™*

Immobilizer System

Keyless Access System *

Remote Transmitter

Wireless Charger*

Each of the above complies with the appropriate requirements or the required standards of FCC (Federal Communications Commission) and Industry Canada Standard, described below:

As required by the FCC:

This device complies with Part 15 of the FCC rules. Operation is subject to the following two conditions: (1) This device may not cause harmful interference, and (2) this device must accept any interference received, including interference that may cause undesired operation.

Changes or modifications not expressly approved by the party responsible for compliance could void the user's authority to operate the equipment.

This device complies with Industry Canada licence-exempt RSS standard(s).

Operation is subject to the following two conditions: (1) this device may not cause interference, and (2) this device must accept any interference, including interference that may cause undesired operation of the device.

* Not available on all models

In the U.S.

If you believe that your vehicle has a defect which could cause a crash or could cause injury or death, you should immediately inform the National Highway Traffic Safety Administration (NHTSA) in addition to notifying American Honda Motor Co., Inc.

If NHTSA receives similar complaints, it may open an investigation, and if it finds that a safety defect exists in a group of vehicles, it may order a recall and remedy campaign. However, NHTSA cannot become involved in individual problems between you, your dealer, or American Honda Motor Co., Inc.

To contact NHTSA, you may call the Vehicle Safety Hotline toll-free at 1-888-327-4236 (TTY: 1-800-424-9153); go to <http://www.safercar.gov>; or write to: Administrator, NHTSA, 1200 New Jersey Avenue, SE., Washington, DC 20590. You can also obtain other information about motor vehicle safety from <http://www.safercar.gov>.

In Canada

If you believe that your vehicle has a defect which could cause a crash or could cause injury or death, you should immediately inform Honda Canada Inc. and you may also inform Transport Canada.

If Transport Canada receives similar complaints, it may open an investigation, and if it finds that a safety defect exists in a group of vehicles, it may lead to a recall and remedy campaign. However, Transport Canada cannot become involved in individual problems between you, your dealer, or Honda Canada Inc.

To contact Transport Canada's Defect Investigations and Recalls Division, you may call 1-800-333-0510. For more information on reporting safety defects or about motor vehicle safety, go to <http://www.tc.gc.ca/roadsafety>.

Testing of Readiness Codes

Your vehicle has readiness code as part of the onboard self diagnostic system. Some states use these codes for testing to verify whether your vehicle's emissions components are working properly. The codes may not be read properly if testing is performed just after the battery has gone dead or been disconnected.

To check if they are set, turn the ignition switch to ON **[II]***1, without starting the engine. The malfunction indicator lamp will come on for several seconds. If it then goes off, the readiness codes are set. If it blinks five times, the readiness codes are not set.

If you are required to have your vehicle tested before the readiness codes are ready, prepare the vehicle for retesting by doing the following:

1. Fill the gas tank to approximately 3/4 full.
2. Park the vehicle and leave the engine off for 6 hours or more.
3. Make sure the ambient temperature is between 40°F and 95°F (4°C and 35°C).
4. Start the engine without touching the accelerator pedal, and let it idle for 20 seconds.
5. Keep the vehicle in **[P]** (continuously variable transmission) or **[N]** (manual transmission). Increase the engine speed to 2,000 rpm, and hold it there for about 3 minutes.
6. Let the engine idle with your foot off the accelerator for 20 seconds.

*1: Models with the smart entry system have an **ENGINE START/STOP** button instead of an ignition switch.

Testing of Readiness Codes

The readiness codes are erased when the battery is disconnected, and set again only after several days of driving under a variety of conditions.

If a testing facility determines that the readiness codes are not set, you may be requested to return at a later date to complete the test.

If the testing facility determines the readiness codes are still not set, see a dealer.

7. Select a nearby, lightly traveled major highway where you can maintain a speed of 50 to 60 mph (80 to 97 km/h) for at least 20 minutes. Drive on the highway in **D** (continuously variable transmission) or 5th (manual transmission). Do not use cruise control. When traffic allows, drive for 90 seconds without moving the accelerator pedal. (Vehicle speed may vary slightly; this is okay.) If you cannot do this for a continuous 90 seconds because of traffic conditions, drive for at least 30 seconds, then repeat it two more times (for a total of 90 seconds).
8. Drive in city or suburban traffic for at least 10 minutes. When traffic conditions allow, let the vehicle coast for several seconds without using the accelerator pedal or the brake pedal.
9. Park the vehicle and leave the engine off for 30 minutes.

■ U.S. Owners

Your new vehicle is covered by these warranties:

New Vehicle Limited Warranty – covers your new vehicle, except for the emissions control systems and accessories, against defects in materials and workmanship.

Emissions Control Systems Defects Warranty and Emissions Performance Warranty – these two warranties cover your vehicle's emissions control systems. Time, mileage, and coverage are conditional. Please read your warranty booklet for exact information.

Seat Belt Limited Warranty – a seat belt that fails to function properly is covered by a limited warranty. Please read your warranty booklet for details.

Rust Perforation Limited Warranty – all exterior body panels are covered against rusting from the inside out for the specified time period, regardless of mileage.

Accessory Limited Warranty – Honda accessories are covered under this warranty. Time and mileage limits depend on the type of accessory and other factors. Please read your warranty booklet for details.

Replacement Parts Limited Warranty – covers all Honda replacement parts against defects in materials and workmanship.

Replacement Battery Limited Warranty – provides prorated coverage for a replacement battery purchased from your dealer.

Replacement Muffler Lifetime Limited Warranty – provides coverage for as long as the purchaser of the muffler owns the vehicle.

Restrictions and exclusions apply to all these warranties. Please read the Honda warranty information booklet that came with your vehicle for precise information on warranty coverages. Your vehicle's original tires are covered by their manufacturer. Tire warranty information is in a separate booklet.

■ **Canadian Owners**

Please refer to the warranty manual that came with your vehicle.

■ **EPA Contact Information**

An owner may obtain further information concerning emission warranties or report violations of the terms of the emission warranties by contacting:

U.S. Environmental Protection Agency
Office of Transportation and Air Quality
Compliance Division, Light-Duty Vehicle Group
Attn: Warranty Complaints
2000 Traverwood Drive
Ann Arbor, MI 48105
Email: complianceinfo@epa.gov

■ Service Express

For electronic copies of service publications, you can purchase a subscription to Service Express. Visit www.techinfo.honda.com for pricing and options.

■ For U.S. Owners

Manuals can be purchased from Helm Incorporated. You can order a manual by phone at 1 (800) 782-4356 (credit card orders only), or online at www.helminc.com.

■ For Canadian Owners

Please contact a dealer to order any manuals that you may require.

Honda dealership personnel are trained professionals who should be able to deal with any problems you may encounter with your vehicle. If, however, you are faced with a problem that they cannot resolve to your satisfaction, contact Honda Customer Services.

U.S. Owners

American Honda Motor Co., Inc.
Honda Automobile Customer Services
Mail Stop 100-5E-8A
1919 Torrance Blvd.
Torrance, CA 90501-2746
Tel: 1 (800) 999-1009

Canadian Owners

Honda Canada Inc.
Customer Relations
180 Honda Boulevard
Markham, ON
L6C 0H9
Tel: 1-888-9-HONDA-9
Fax: 1-877-939-0909
E-mail: Honda_cr@ch.honda.com

In Puerto Rico and the U.S. Virgin Islands

Bella International
P.O. Box 190816
San Juan, PR 00919-0816
Tel: 1 (787) 620-7546

Customer Service Information

When you call or write, please give us the following information:

- Vehicle Identification Number
 - **Vehicle Identification Number (VIN), Engine Number, and Transmission Number** P. 610
- Date of purchase
- Odometer reading of your vehicle
- Your name, address, and telephone number
- A detailed description of the problem
- Name of the dealer who sold the vehicle to you

Numbers

7-Speed Manual Shift Mode	426
Operation	427

A

ABS (Anti-lock Brake System)	480
Accelerator Position Meter	121
Accessories and Modifications	559
Accessory Power Socket	186
Adaptive Cruise Control (ACC) with Low Speed Follow (LSF)	91, 438
Adding the Coolant	523
Additives	
Coolant	522
Engine Oil	515
Washer	526
Additives, Engine Oil	515
Adjusting	
Armrest	179
Clock	126
Front Head Restraints	174
Front Seats	172
Mirrors	169
Rear Seats	178
Steering Wheel	168
Temperature	113, 119
Adjusting the Clock	126
Adjusting the Sound	212, 247
Agile Handling Assist	465

Air Conditioning System (Climate Control System)	191
Changing the Mode	191, 192, 193
Defrosting the Windshield and Windows	195
Dust and Pollen Filter	553
Recirculation/Fresh Air Mode	194
Sensors	198
Synchronization Mode	197
Using Automatic Climate Control	191
Air Pressure	540, 607, 609
Airbags	46
Advanced Airbags	52
After a Collision	49
Airbag Care	59
Event Data Recorder	0
Front Airbags (SRS)	49
Indicator	57, 81
Passenger Front Airbag Off Indicator	58
Sensors	46
Side Airbags	53
Side Curtain Airbags	55
AM/FM Radio	214, 254
Android Auto	291
Anti-lock Brake System (ABS)	480
Indicator	81
Apple CarPlay	288
Armrest	179
Audio Remote Controls	203
Audio System	200, 207, 225
Adjusting the Sound	212, 247

Audio/Information Screen	208, 226
Changing the Home Screen Icon Layout ..	230
Changing the Screen Interface	244
Closing Apps	246
Customizing the Meter	231
Display Setup	213, 248
Error Messages	295
General Information	298
Home Screen	237
iPod	216, 266
Limitations for Manual Operation	249
Menu Customize	245
MP3/WMA/AAC	219, 275
Reactivating	202
Recommended Devices	299
Remote Controls	203
Security Code	202
Selecting an Audio Source	249
Status Area	243
Theft Protection	202
USB Flash Drives	299
USB Port(s)	201
Wallpaper Setup	210, 235
Audio/Information Screen	208, 226
Authorized Manuals	617
Auto Door Locking/Unlocking	141
Customize	142, 347
Automatic Brake Hold	477
Indicator	78, 477
Automatic Brake Hold System	
Indicator	78, 477

Automatic Lighting	161
Average Fuel Economy.....	112, 118
Average Speed.....	118

B

Battery	549
Charging System Indicator.....	79, 591
Jump Starting	585
Maintenance (Checking the Battery)	549
Maintenance (Replacing).....	551
Belts (Seat)	38
Beverage Holders	184
Bluetooth® Audio	222, 278
Bluetooth® HandsFreeLink®	349, 372
Booster Seats (For Children)	72
Brake System	474
Anti-lock Brake System (ABS).....	480
Automatic Brake Hold.....	477
Brake Assist System	481
Fluid	525
Foot Brake	476
Indicator (Red).....	76, 593, 594
Parking Brake	474
Braking Pressure Meter	121
Brightness Control (Instrument Panel)	166
Bulb Replacement	527
Brake Light, Tail/Rear Side Marker Light, Rear Turn Signal Lights and Back-Up Lights....	534
Fog Lights.....	529
Front Side Marker Lights.....	532

Front Turn Signal Lights.....	531
Headlights.....	527
High-Mount Brake Light	535
Parking/Daytime Running Lights	533
Rear License Plate Light	535
Side Turn Signal/Emergency Indicator Lights	533
Taillight	535
Bulb Specifications	606, 608

C

Carbon Monoxide Gas	73
Carrying Cargo	407, 409
Certification Label	610
Changing Bulbs	527
Charging System Indicator	79, 591
Child Safety	60
Emergency Trunk Opener	147
Child Seat	60
Booster Seats	72
Child Seat for Infants.....	62
Child Seat for Small Children.....	63
Installing a Child Seat with a Lap/Shoulder Seat Belt.....	67
Larger Children	71
Rear-facing Child Seat	62
Selecting a Child Seat.....	64
Using a Tether.....	69
Cleaning the Exterior	556
Cleaning the Interior	554

Climate Control System	191
Changing the Mode.....	191, 192, 193
Defrosting the Windshield and Windows	195
Dust and Pollen Filter	553
Recirculation/Fresh Air Mode.....	194
Sensors	198
Synchronization Mode	197
Using Automatic Climate Control.....	191
CMBS™ (Collision Mitigation Braking System™)	482
Coat Hooks	189
Collision Mitigation Braking System™ (CMBS™)	482
Compact Spare Tire	563, 607, 609
Console Compartment	183
Continuously Variable Transmission	
Creeping.....	421
Fluid	524
Kickdown	421
Operating the Shift Lever	423, 425
Shift Lever Does Not Move.....	588
Shifting.....	422, 424
Controls	125
Coolant (Engine)	522
Adding the Coolant	523
Overheating.....	589
Creeping (Continuously Variable Transmission)	421
Cruise Control	433
Indicator	87

Cup Holders	184
Customer Service Information	618
Customized Features	316

D

Daytime Running Lights	163
Dead Battery	585
Defaulting All the Settings.....	348
Defrosting the Windshield and Windows.....	195
Devices that Emit Radio Waves.....	611
Dimming	
Headlights	160
Rearview Mirror	169
Dipstick (Engine Oil)	516
Directional Signals (Turn Signal).....	160
Display Button.....	226
Display Setup.....	213, 248
Display/Information Button	115
Door Mirrors.....	170
Doors	128
Auto Door Locking.....	141
Auto Door Unlocking	141
Door and Trunk Open Indicator.....	37, 83
Door Open Message	37, 97
Keys.....	128
Locking/Unlocking the Doors from the Inside	138
Locking/Unlocking the Doors from the Outside	131

DOT Tire Quality Grading	542
Driver Information Interface	114
Warning and Information Messages	97
Driving.....	405
Braking.....	474
Continuously Variable Transmission	421
Cruise Control	433
Shifting Gear	428
Shifting Position	422, 424
Starting the Engine	412, 415
Dust and Pollen Filter	553

E

Eco Assist® System	9
ECON Button.....	432
Elapsed Time.....	118
Electric Power Steering (EPS) System	83
Indicator.....	83, 595
Electronic Stability Control (ESC).....	463
Emergency	601
Emergency Engine Stop	584
Emergency Trunk Opener	147, 603
Emissions Testing (Readiness Codes)	613
Engine	
Coolant	522
Jump Starting	585
Oil	515
Starting	412, 415
Switch Buzzer	155
Engine Coolant	522

Adding the Coolant.....	523
Overheating	589
Temperature Gauge	110
Engine Oil	515
Adding.....	518
Checking.....	516
Displaying Maintenance Minder Information	503, 507
Low Oil Pressure Indicator	78, 591
Recommended Engine Oil	515
ENGINE START/STOP Button	156
EPS (Electric Power Steering) System	595
Exhaust Gas Hazard (Carbon Monoxide) ..	73
Exterior Care (Cleaning).....	556
Exterior Mirrors	170

F

Features	199
Filters	
Dust and Pollen.....	553
Oil.....	519
Flat Tire	563
Floor Mats.....	555
Fluids	
Brake/Clutch	525
Continuously Variable Transmission (CVT).....	524
Engine Coolant	522
Manual Transmission.....	524
Windshield Washer	526

FM/AM Radio	214, 254
Fog Light Indicator	85
Folding Down the Rear Seats.....	178
Foot Brake.....	476
Front Airbags (SRS).....	49
Front Head Restraints.....	174
Front Seats	171
Adjusting.....	172
Front Sensor Camera	436
Fuel.....	25, 493
Economy	496
Gauge	110
Instant Fuel Economy.....	112, 119
Low Fuel Indicator	81
Range.....	112, 118
Recommendation	493
Refueling	493, 604
Fuel Economy.....	496
Fuel Fill Door.....	25, 494, 602
Fuses	597
Inspecting and Changing.....	600
Locations.....	597, 598

G

Gasoline (Fuel)	
Economy	496
Gauge	110
Information	493
Instant Fuel Economy.....	112, 119
Low Fuel Indicator	81

Refueling.....	493, 604
Gauges	109
Gear Shift Lever Positions	
Manual Transmission.....	429
Glass (care).....	554, 557
Glove Box.....	182
G-Meter.....	121

H

Halogen Bulbs	527, 530
Handling the Unexpected.....	561
HandsFreeLink® (HFL).....	349, 372
Automatic Import of Cellular Phonebook and Call History.....	361, 385
Displaying Messages.....	399
HFL Buttons.....	349, 372
HFL Menus.....	351, 375
HFL Status Display.....	350, 374
In Case of Emergency.....	403
Limitations for Manual Operation....	350, 374
Making a Call.....	366, 393
Options During a Call.....	371, 396
Phone Setup.....	355, 380
Phonebook Phonetic Modification.....	389
Receiving a Call.....	370, 396
Receiving a Text/E-mail Message.....	397
Ring Tone.....	359, 384
Selecting a Mail Account.....	398
Speed Dial.....	362, 386
To Set Up Text/E-mail Message Options...	383

Hazard Warning Button	4
HD Radio™	255
Headlights	160
Aiming.....	527
Automatic Operation	161
Dimming.....	160, 163
Operating	160
Heaters (Seat).....	190
HFL (HandsFreeLink®)	349, 372
High Beam Indicator.....	85
Hill Start Assist System.....	414, 419
Honda App License Agreement.....	300
Honda Sensing™.....	26
HondaLink®	280

I

Identification Numbers	
Vehicle Identification.....	610
Ignition Switch	155
Illumination Control	
Knob	166
Immobilizer System.....	148
Immobilizer System Indicator.....	86, 87
Indicators.....	76
Adaptive Cruise Control (ACC) with Low Speed Follow (LSF)	91, 438
Anti-lock Brake System (ABS)	81
Automatic Brake Hold.....	78, 477
Automatic Brake Hold System.....	78, 477
Brake Depressing	89

Charging System.....	79, 591
Collision Mitigation Braking System™ (CMBS™)	93, 94
CRUISE CONTROL.....	87, 434
CRUISE MAIN.....	87, 433
Door and Trunk Open.....	37, 83
ECON Mode	87, 432
Electric Power Steering (EPS) System.....	83, 595
Fog Light	85
High Beam.....	85
Immobilizer System	86, 87
Lane Keeping Assist System (LKAS) ...	92, 458
Lights On.....	85
Low Fuel.....	81
Low Oil Pressure	78, 591
Low Tire Pressure/TPMS	84, 469, 472, 596
Maintenance Minder.....	88, 503
Malfunction Indicator Lamp	79, 592
Parking Brake and Brake System (Amber).....	77, 594
Parking Brake and Brake System (Red).....	76, 593, 594
Road Departure Mitigation (RDM).....	90
Seat Belt Reminder.....	40, 80
Security System Alarm.....	87
Shift Lever Position.....	79
Smart Entry System.....	88
SPORT Mode.....	83, 431
Starter System.....	88
Supplemental Restraint System	57, 81

System Message	85
Transmission System.....	80
Turn Signal	85
Vehicle Stability Assist (VSA®) System.....	82, 463
VSA® OFF	82, 464
Information	605
Information Display	111
Warning and Information Messages	95
Instant Fuel Economy	112, 119
Instrument Panel	75
Brightness Control.....	166
Interior Lights	180
Interior Rearview Mirror	169
iPod	216, 266

J

Jack (Wheel Nut Wrench)	566
Jump Starting	585

K

Key Number Tag	129
Keys	128
Keys	128
Number Tag	129
Remote Transmitter	135
Types and Functions	128
Won't Turn.....	29

Kickdown (Continuously Variable Transmission)	421
--	-----

L

Lane Keeping Assist System (LKAS)	456
LaneWatch™	467
Language (HFL)	350, 374
LATCH (Child Seats)	65
Lights	160, 527
Automatic.....	161
Bulb Replacement	527
Daytime Running Lights.....	163
Fog Lights	163
High Beam Indicator.....	85
Interior.....	180
Light Switches.....	160
Lights On Indicator.....	85
Turn Signals	160
Limited Slip Differential (LSD)	466
Load Limits	409
Locking/Unlocking	128
Auto Door Locking/Unlocking.....	141
From Inside	138
From Outside	131
Keys.....	128
Using a Key.....	136
Low Battery Charge	591
Low Fuel Indicator	81
Low Oil Pressure Indicator	78, 591

Low Smart Entry Remote Signal Strength.....	130
Lower Anchors.....	65
Lubricant Specifications Chart.....	606, 608
Luggage (Maximum Load Limit).....	409

M

Maintenance.....	499
Adding the Coolant.....	523
Battery.....	549
Brake/Clutch Fluid.....	525
Cleaning.....	554
Climate Control System.....	553
Coolant.....	522
Maintenance Minder™.....	503
Oil.....	516
Precautions.....	500
Remote Transmitter.....	551
Replacing Light Bulbs.....	527
Safety.....	501
Service Items.....	505, 509
Tires.....	539
Transmission Fluid.....	524
Under the Hood.....	512
Malfunction Indicator Lamp.....	79, 592
Manual Transmission.....	428
Map Lights.....	181
Maximum Load Limit.....	409
Meters, Gauges.....	109
Mirrors.....	169

Adjusting.....	169
Door.....	170
Exterior.....	170
Interior Rearview.....	169
Modifications (and Accessories).....	559
Moonroof.....	154
MP3.....	219, 275
Multi-View Rear Camera.....	491

N

Numbers (Identification).....	610
-------------------------------	-----

O

Odometer.....	111, 117
Oil (Engine).....	515
Adding.....	518
Checking.....	516
Displaying Maintenance Minder Information.....	503, 507
Low Oil Pressure Indicator.....	78, 591
Recommended Engine Oil.....	515
Viscosity.....	515
Open Source Licenses.....	314
Opening	
Trunk.....	603
Opening/Closing	
Hood.....	514
Moonroof.....	154
Power Windows.....	151

Trunk.....	145
Outside Temperature Display.....	113, 119
Overheating.....	589

P

Paddle Shifters (7-Speed Manual Shift Mode).....	426
Pandora®.....	273
Panic Mode.....	150
Parking.....	490
Parking Brake.....	474
Parking Brake and Brake System Indicator (Amber).....	77, 594
Parking Brake and Brake System Indicator (Red).....	76, 593, 594
Passenger Front Airbag Off Indicator.....	58
Passing Indicators.....	160
Playing <i>Bluetooth</i> ® Audio.....	222, 278
Power Windows.....	151
Precautions While Driving	
Rain.....	420
Pregnant Women.....	44
Puncture (Tire).....	563

R

Radio (FM/AM).....	214, 254
Radio (SiriusXM®).....	258
Radio Data System (RDS).....	215, 256
Range.....	112, 118

RDS (Radio Data System)	215, 256
Readiness Codes (Emissions Testing)	613
Rear Defogger/Heated Door Mirror	
Button	167
Rear Seat Access	177
Rear Seats (Folding Down)	178
Rearview Mirror	169
Refueling	493
Fuel Gauge	110
Gasoline	493, 604, 606, 608
Low Fuel Indicator	81
Regulations	472, 542, 611
Remote Transmitter	135
Replacement	
Battery	551
Bulbs	527
Fuses	597, 598
Tires	545
Wiper Blade Rubber	536
Reporting Safety Defects	612
Resetting a Trip Meter	111, 117
Rev Indicators	122
Road Departure Mitigation (RDM)	452
On and Off	453

S

Safe Driving	33
Safety Check	37
Safety Labels	74
Safety Message	1

Seat Belts	38
Automatic Seat Belt Tensioners	41
Checking	45
Fastening	42
Installing a Child Seat with a Lap/Shoulder	
Seat Belt	67
Pregnant Women	44
Reminder	40
Warning Indicator	40, 80
Seat Heaters	190
Seats	171
Adjusting	171
Front Seats	171
Rear Seat Access	177
Rear Seats	178
Seat Heaters	190
Security System	148
Security System Alarm Indicator	87
Selecting a Child Seat	64
Selector Knob (Audio)	207
Setting the Clock	126
Shift Lever	23, 422, 424, 428
Releasing	588
Won't Move	588
Shift Lever Position Indicator	79, 423, 425
Shift Up Backlight	110
Shifting (Transmission)	422, 424, 428
Side Airbags	53
Side Curtain Airbags	55
Siri Eyes Free	287
SiriusXM® Radio	258

Smart Entry with Push Button Start	
System	131
Snow Tires	547
Song By Voice™ (SBV)	269
Spare Tire	563, 607, 609
Spark Plugs	606, 608
Specifications	606
Specified Fuel	493, 606, 608
Speedometer	109
SPORT Mode	431
SPORT Mode Indicator	83, 431
SRS Airbags (Airbags)	49
Starting the Engine	412, 415
Does Not Start	582
Engine Switch Buzzer	155
Jump Starting	585
Steering Wheel	
Adjusting	168
Stopping	490
Stopwatch	123
Summer Tires	548
Supplemental Restraint System (SRS)	49
Switches (Around the Steering	
Wheel)	4, 5, 155
System Message Indicator	85
T	
Tachometer	109
Temperature	
Gauge	109

- Outside Temperature Display 113, 119
 - Temperature Sensor** 113, 119
 - Temporary Repair Kit (TRK)** 570
 - Time (Setting)** 126
 - Tire Pressure Monitoring System (TPMS)**..... 469
 - Indicator 84, 596
 - Tires** 539
 - Air Pressure 540, 607, 609
 - Checking and Maintaining 539
 - Inspection 539
 - Labeling 540
 - Puncture (Flat Tire) 563
 - Regulations 542
 - Rotation 546
 - Spare Tire 563, 607, 609
 - Summer 548
 - Temporary Repair Kit (TRK) 570
 - Tire Chains 547
 - Wear Indicators 544
 - Winter 547
 - Tools** 562
 - Towing Your Vehicle** 411
 - Emergency 601
 - TPMS (Tire Pressure Monitoring System)** 469
 - Indicator 84, 596
 - Transmission**..... 422, 424, 428
 - Continuously Variable Transmission 422, 424
 - Fluid 524
 - Manual 428
 - Shift Lever Position Indicator 79, 423, 425
 - TRIP Knob** 111, 117
 - Trip Meter** 111, 117
 - TRK (Temporary Repair Kit)** 570
 - Troubleshooting**..... 561
 - Blown Fuse 597, 598
 - Brake Pedal Vibrates 30
 - Buzzer Sounds When Opening Door 30
 - Emergency Towing 601
 - Engine Won't Start 582
 - Noise When Braking 30
 - Overheating 589
 - Puncture/Flat Tire 563
 - Shift Lever Won't Move 588
 - Warning Indicators 76
 - Trunk**..... 145
 - Lid 145
 - Light Bulb 606, 608
 - Release Lever 603
 - Unable to Open 603
 - Turbo Engine Vehicle**..... 497
 - Turbo Meter** 119
 - Turn Signals** 160
 - Indicators (Instrument Panel) 85
- U**
- Unlocking the Doors 131
 - Unlocking the Doors from the Inside 138
 - USB Adapter Cable 200
 - USB Flash Drives 219, 275, 299
 - USB Port(s) 201
 - Using the Smart Entry with Push Button Start System 131
- V**
- Vanity Mirrors 7
 - Vehicle Identification Number 610
 - Vehicle Stability Assist (VSA®) 463
 - Off Button 464
 - Off Indicator 82
 - System Indicator 82
 - Viscosity (Oil) 515, 607, 609
 - Voice Control Operation** 250
 - Audio Commands 252
 - Climate Control Commands 253
 - General Commands 253
 - Music Search Commands 253
 - On Screen Commands 253
 - Phone Commands 252
 - Useful Commands 252
 - Voice Portal Screen 251
 - Voice Recognition 250
 - VSA® (Vehicle Stability Assist) 463
- W**
- Wallpaper 210, 235
 - Warning and Information Messages .. 95, 97
 - Warning Indicator On/Blinking 591

Warning Labels	74
Warranties (Warranty Manual provided separately)	615
Watts	606, 608
Wear Indicators (Tire)	544
Wheel Nut Wrench (Jack Handle)	566
Wi-Fi Connection	285
Window Washers	164
Adding/Refilling Fluid	526
Switch	164
Windows (Opening and Closing)	151
Windshield	164
Cleaning	554, 557
Defrosting/Defogging	195
Washer Fluid	526
Wiper Blades	536
Wipers and Washers	164
Winter Tires	
Snow Tires	547
Tire Chains	547
Wipers and Washers	164
Checking and Replacing Wiper Blades	536
Wireless Charger	187
WMA	219, 275
Worn Tires	539



31TBG6201
OM-10645
00X31-TBG-6201

owners.honda.com (U.S.)
myhonda.ca (Canada)

2018 Honda Civic Coupe Owner's Manual
©2019 Honda Motor Co., Ltd. — All Rights Reserved

Printed in U.S.A.