

Owner's Manual

2022 ACCORD

California Proposition 65 Warning

⚠ WARNING: Operating, servicing and maintaining a passenger vehicle or off-highway motor vehicle can expose you to chemicals including engine exhaust, carbon monoxide, phthalates, and lead, which are known to the State of California to cause cancer and birth defects or other reproductive harm. To minimize exposure, avoid breathing exhaust, do not idle the engine except as necessary, service your vehicle in a well-ventilated area and wear gloves or wash your hands frequently when servicing your vehicle. For more information go to www.P65Warnings.ca.gov/passenger-vehicle.

Event Data Recorders

This vehicle is equipped with an event data recorder (EDR). The main purpose of an EDR is to record, in certain crash or near crash-like situations, such as an air bag deployment or hitting a road obstacle, data that will assist in understanding how a vehicle's systems performed. **The EDR is designed to record data related to vehicle dynamics and safety systems for a short period of time, typically 30 seconds or less.** The EDR in this vehicle is designed to record such data as:

- How various systems in your vehicle were operating;
- Whether or not the driver and passenger safety belts were buckled/fastened;
- How far (if at all) the driver was depressing the accelerator and/or brake pedal; and,
- How fast the vehicle was traveling.

These data can help provide a better understanding of the circumstances in which crashes and injuries occur. NOTE: EDR data are recorded by your vehicle only if a non-trivial crash situation occurs; no data are recorded by the EDR under normal driving conditions and no personal data (e.g., name, gender, age, and crash location) are recorded. However, other parties, such as law enforcement, could combine the EDR data with the type of personally identifying data routinely acquired during a crash investigation.

To read data recorded by an EDR, special equipment is required, and access to the vehicle or the EDR is needed. In addition to the vehicle manufacturer, other parties, such as law enforcement, that have the special equipment, can read the information if they have access to the vehicle or the EDR.

The data belongs to the vehicle owner and may not be accessed by anyone else except as legally required or with the permission of the vehicle owner.

Service Diagnostic Recorders

This vehicle is equipped with service-related devices that record information about powertrain performance. The data can be used to verify emissions law requirements and/or help technicians diagnose and solve service problems. It may also be combined with data from other sources for research purposes, but it remains confidential. Some diagnostic and maintenance information is uploaded to Honda upon vehicle start up.

California Perchlorate Contamination Prevention Act

The airbags, seat belt tensioners, and CR type batteries in this vehicle may contain perchlorate materials - special handling may apply. See www.dtsc.ca.gov/hazardouswaste/perchlorate/

As you read this manual, you will find information that is preceded by a **NOTICE** symbol. This information is intended to help you avoid damage to your vehicle, other property, or the environment.

Software End User License Agreement

Your vehicle comes equipped with software, which is governed by the End User License Agreement in Owner's Manual, and which contains a binding arbitration clause. Please refer to the End User License Agreement for the terms and conditions governing your use of the installed software, as well as the applications, services, functions, and content provided through the software. Your use of the installed software will serve as your consent to the terms and conditions of the End User License Agreement.

You may opt out within 30 days of your initial use of the Software by sending a signed, written notice to HONDA at American Honda Motor Co., Inc., Honda Automobile Customer Service, Mail Stop CHI-5, 1919 Torrance Blvd., Torrance, CA 90501-2746.

Privacy Notice

This vehicle may share location and usage information. To manage this setting, visit www.hondalink.com/vehicle-data-choices.

To learn more about how we collect and use Personal Information, please read our Privacy Policy, accessible at www.honda.com.

A Few Words About Safety

Your safety, and the safety of others, is very important. And operating this vehicle safely is an important responsibility.

To help you make informed decisions about safety, we have provided operating procedures and other information on labels and in this manual. This information alerts you to potential hazards that could hurt you or others.

Of course, it is not practical or possible to warn you about all the hazards associated with operating or maintaining your vehicle. You must use your own good judgment.

You will find this important safety information in a variety of forms, including:

- **Safety Labels** - on the vehicle.
- **Safety Messages** - preceded by a safety alert symbol  and one of three signal words: **DANGER**, **WARNING**, or **CAUTION**. These signal words mean:

DANGER

You **WILL** be **KILLED** or **SERIOUSLY HURT** if you don't follow instructions.

WARNING

You **CAN** be **KILLED** or **SERIOUSLY HURT** if you don't follow instructions.

CAUTION

You **CAN** be **HURT** if you don't follow instructions.

- **Safety Headings** - such as Important Safety Precautions.
- **Safety Section** - such as Safe Driving.
- **Instructions** - how to use this vehicle correctly and safely.

This entire book is filled with important safety information - please read it carefully.

This owner's manual should be considered a permanent part of the vehicle and should remain with the vehicle when it is sold.

The Navigation Manual is available online at *owners.honda.com* (U.S.) or *honda.ca* (Canada). **If you are the first registered owner of your vehicle, you may request a complimentary printed copy of the Navigation Manual within the first six months of vehicle purchase.**

To request a copy, visit *owners.honda.com*. In Canada, please request a copy from your Honda dealer.

This owner's manual covers all models of your vehicle. You may find descriptions of equipment and features that are not on your particular model.

Images throughout this owner's manual (including the front cover) represent features and equipment that are available on some, but not all, models. Your particular model may not have some of these features.

This owner's manual is for vehicles sold in the United States and Canada.

The information and specifications included in this publication were in effect at the time of approval for printing. Honda Motor Co., Ltd. reserves the right, however, to discontinue or change specifications or design at any time without notice and without incurring any obligation.

➤ Safe Driving P. 33

For Safe Driving P. 34 Seat Belts P. 38 Airbags P. 46

➤ Instrument Panel P. 81

Indicators P. 82 Gauges and Displays P. 139

➤ Controls P. 165

Clock P. 166 Locking and Unlocking the Doors P. 167
Moonroof* P. 190
Seats P. 212

➤ Features P. 245

Audio System P. 246 Audio System Basic Operation P. 253
Customized Features P. 351 HomeLink® Universal Transceiver* P. 371

➤ Driving P. 401

Before Driving P. 402 Towing a Trailer P. 407
Multi-View Rear Camera P. 529 Refueling P. 531

➤ Maintenance P. 537

Before Performing Maintenance P. 538 Maintenance Minder™ P. 541
Checking and Maintaining Wiper Blades P. 572
Climate Control System Maintenance P. 587

➤ Handling the Unexpected P. 595

Tools P. 596 If a Tire Goes Flat P. 597
Overheating P. 611 Indicator, Coming On/Blinking P. 613
If You Cannot Open the Trunk P. 628

➤ Information P. 631

Specifications P. 632 Identification Numbers P. 636
Emissions Testing P. 639 Warranty Coverages P. 641

Contents

Child Safety P. 64	Exhaust Gas Hazard P. 78	Safety Labels P. 79
Opening and Closing the Trunk P. 181	Security System P. 184	Windows P. 187
Operating the Switches Around the Steering Wheel P. 191		Mirrors P. 210
Interior Convenience Items P. 223		Climate Control System P. 240
Audio Error Messages P. 327	General Information on the Audio System P. 329	
<i>Bluetooth</i> ® HandsFreeLink® P. 374	Refuel Recommend P. 400	
When Driving P. 412	Honda Sensing® P. 453	Braking P. 508
Fuel Economy and CO ₂ Emissions P. 534		Parking Your Vehicle P. 518
		Turbo Engine Vehicle P. 535
Maintenance Under the Hood P. 548	Replacing Light Bulbs P. 564	
Checking and Maintaining Tires P. 575	Battery P. 584	Remote Transmitter Care P. 586
Cleaning P. 588	Accessories and Modifications P. 593	
Engine Does Not Start P. 603	If the Battery Is Dead P. 606	Shift Lever Does Not Move P. 609
Fuses P. 620	Emergency Towing P. 626	If You Cannot Unlock the Fuel Fill Door P. 627
Refueling P. 630		
Devices that Emit Radio Waves P. 637	Reporting Safety Defects P. 638	
Authorized Manuals P. 644	Customer Service Information P. 645	

Quick Reference Guide P. 6

Safe Driving P. 33

Instrument Panel P. 81

Controls P. 165

Features P. 245

Driving P. 401

Maintenance P. 537

Handling the Unexpected P. 595

Information P. 631

Index P. 646

Visual Index

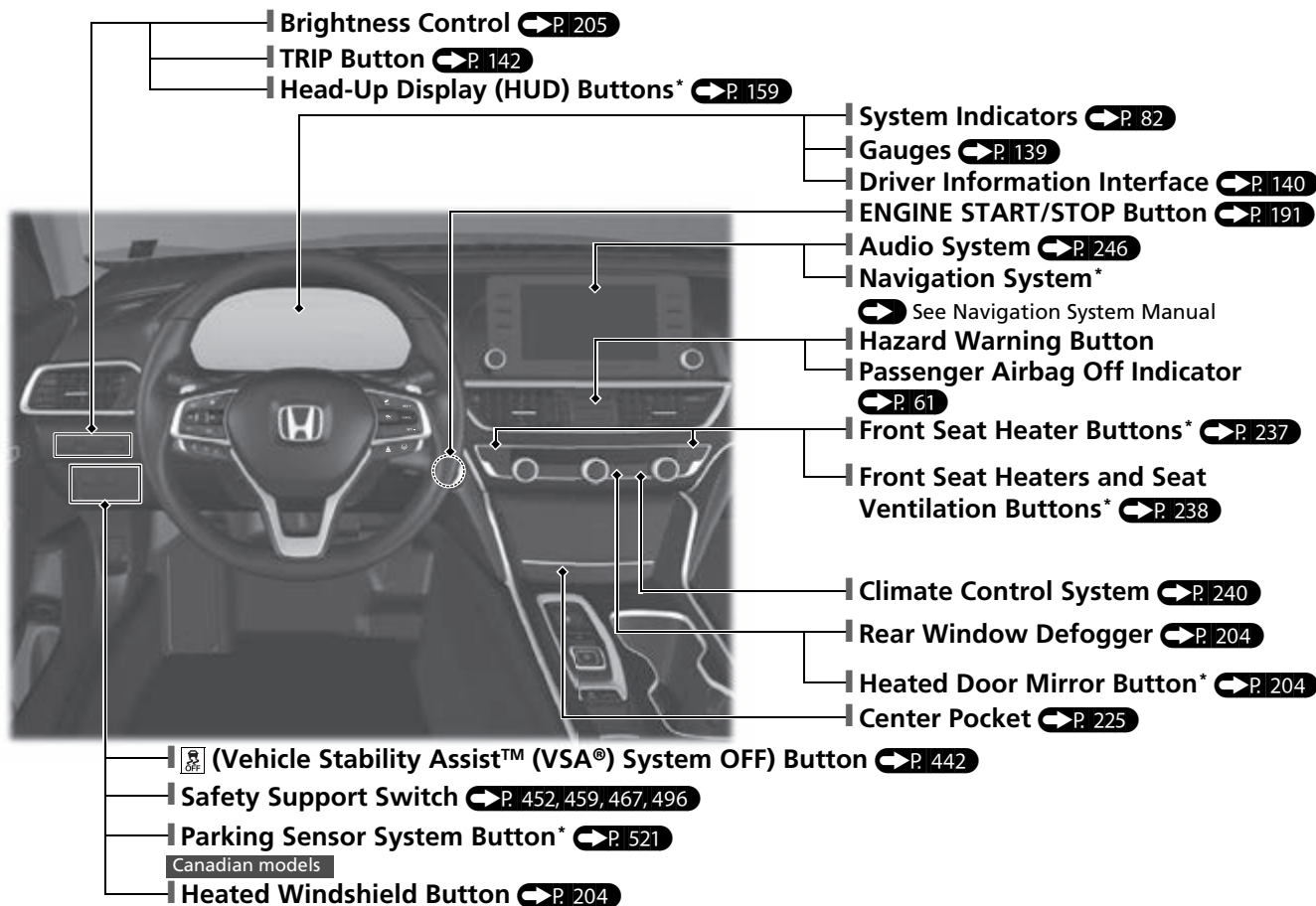

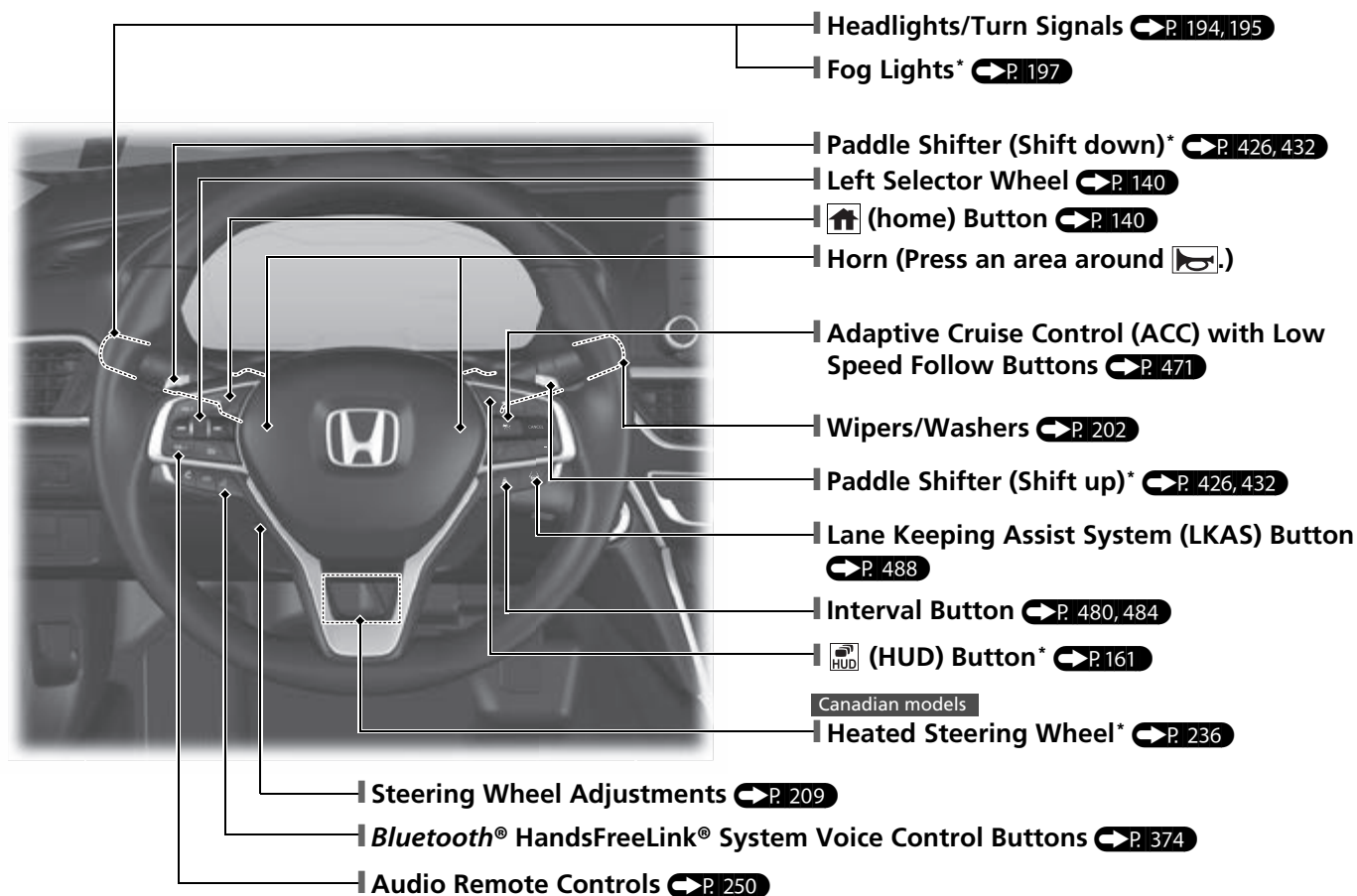

Visual Index

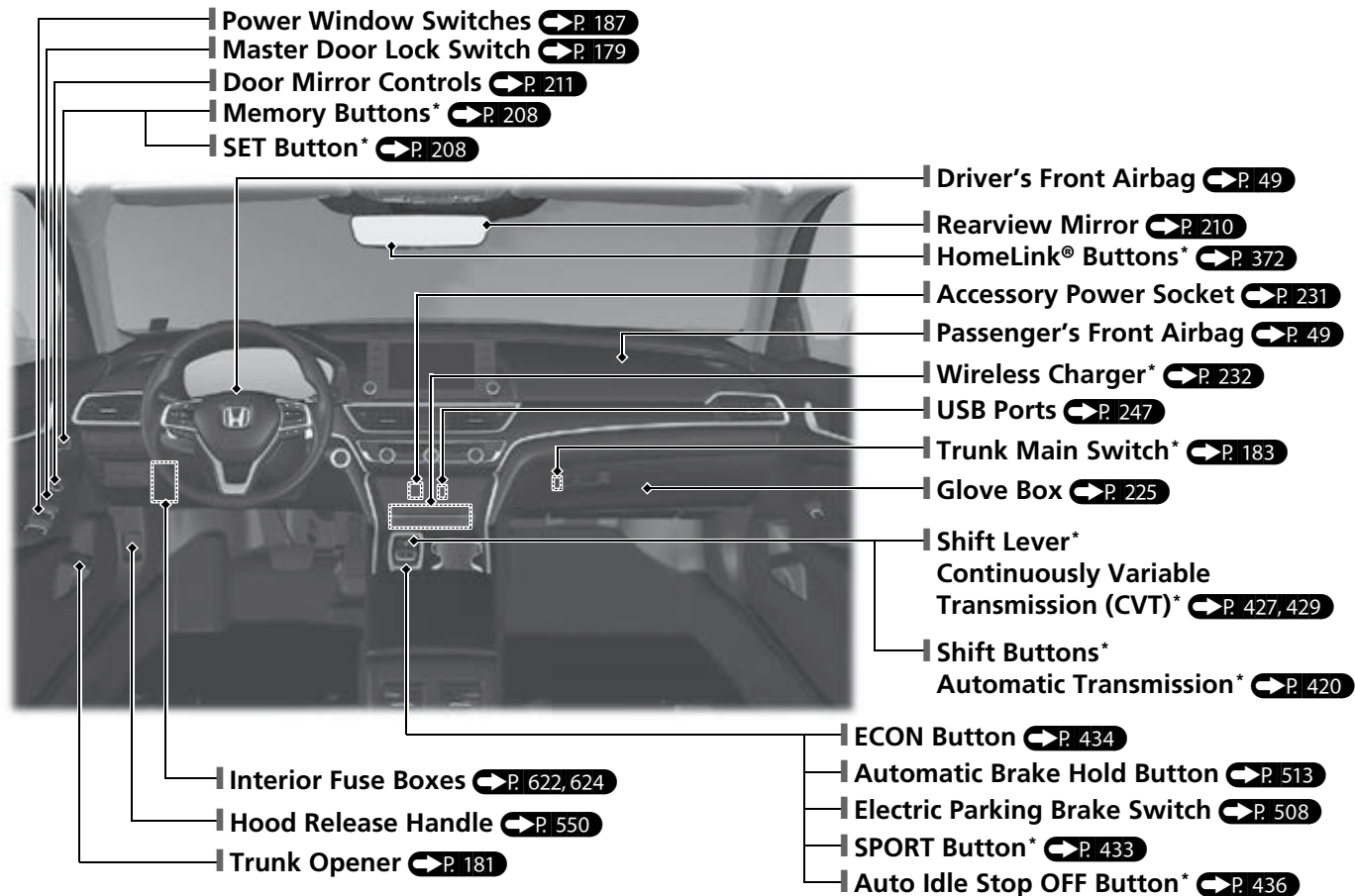

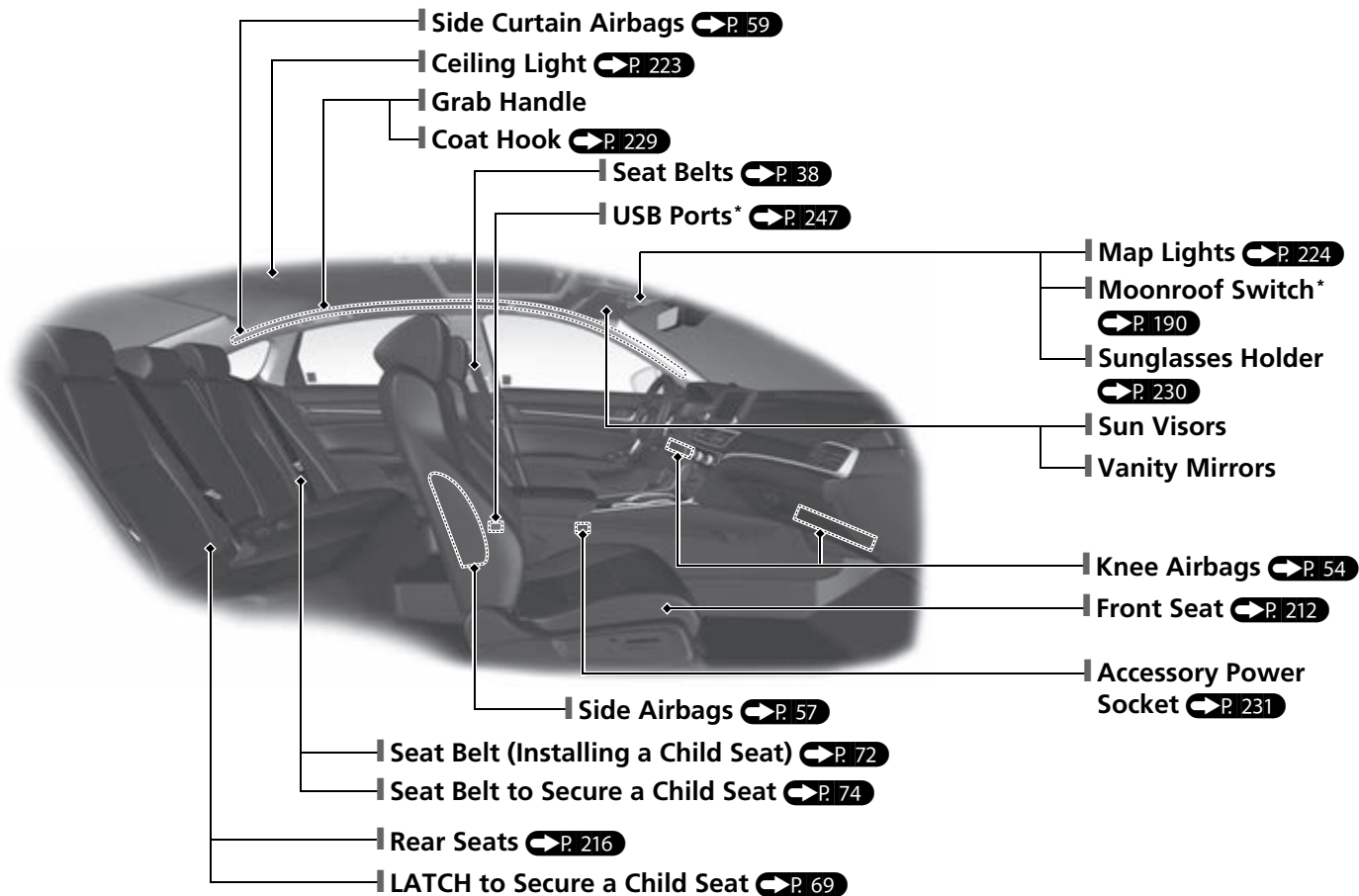



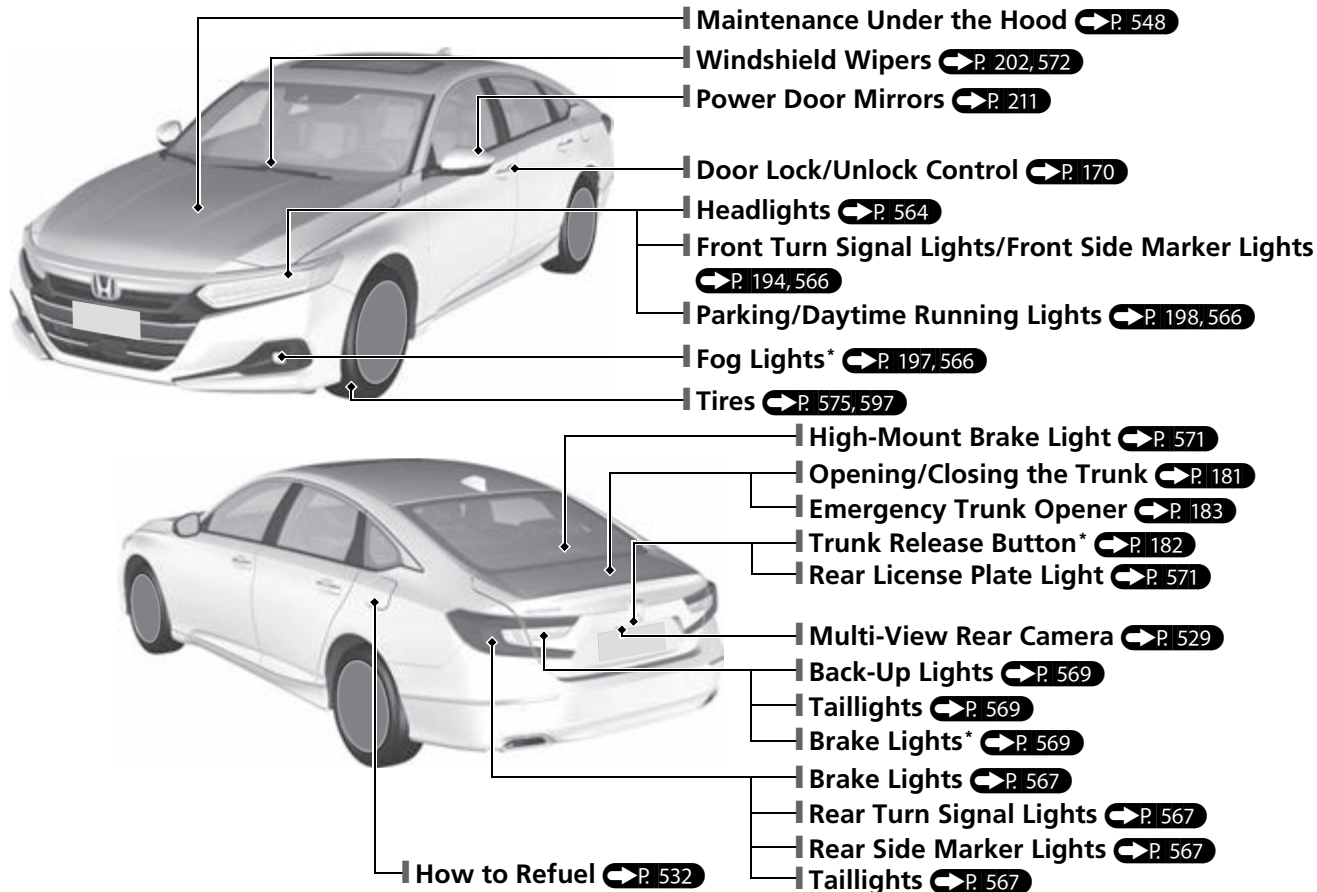

* Not available on all models

Visual Index

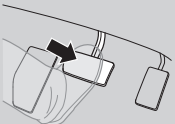
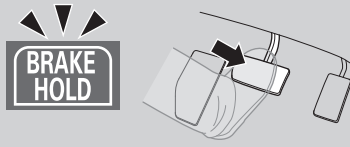
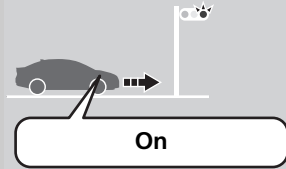

Auto Idle Stop Function*

To improve fuel economy, the engine stops and then restarts as detailed below. When Auto Idle Stop is on, the Auto Idle Stop indicator (green) comes on.  P.435

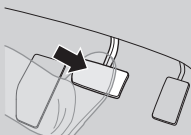
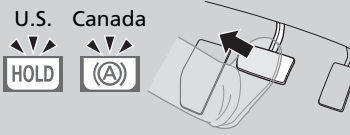
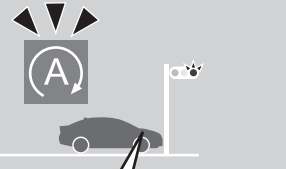
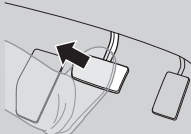
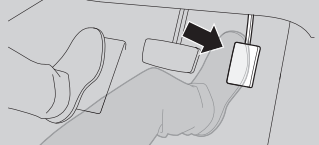
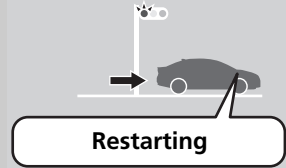
At	Continuously variable transmission	Engine status
Deceleration 	<div style="display: flex; justify-content: space-around;"> <div style="text-align: center;"> <p>Automatic Brake Hold Off</p>  </div> <div style="text-align: center;"> <p>Automatic Brake Hold On</p>  </div> </div> <p style="text-align: center;">Stop the vehicle and depress the brake pedal.</p>	 <p style="text-align: center;">On</p>
Stop 	<div style="display: flex; justify-content: space-around;"> <div style="text-align: center;">  <p>Keep the brake pedal depressed.</p> </div> <div style="text-align: center;"> <p>U.S. Canada</p>  <p>With the automatic brake hold system activated, you can release the brake pedal when the (A) indicator comes on.</p> </div> </div>	 <p style="text-align: center;">Off</p>
Start-up	<div style="display: flex; justify-content: space-around;"> <div style="text-align: center;">  <p>Release the brake pedal.</p> </div> <div style="text-align: center;">  <p>With the automatic brake hold system activated, depress the accelerator pedal.</p> </div> </div>	 <p style="text-align: center;">Restarting</p>

* Not available on all models

Eco Assist® System [P. 434](#)

Ambient Meter

- With SPORT mode* off, the color of the ambient meter changes to green to indicate that the vehicle is being driven in a fuel efficient manner.

Ambient Meter



ECON Button [P. 434](#)

Helps maximize fuel economy.



ECON Mode Indicator [P. 100](#)

Comes on when the ECON button is pressed.

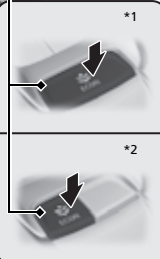

*1 : Models without SPORT mode

*2 : Models with SPORT mode

Safe Driving ↔ P. 33

Airbags ↔ P. 46

- Your vehicle is fitted with airbags to help protect you and your passengers during a moderate-to-severe collision.

Child Safety ↔ P. 64

- All children 12 and younger should be seated in the rear seat.
- Smaller children should be properly restrained in a forward-facing child seat.
- Infants must be properly restrained in a rear-facing child seat.

Exhaust Gas Hazard ↔ P. 78

- Your vehicle emits dangerous exhaust gases that contain carbon monoxide. Do not run the engine in confined spaces where carbon monoxide gas can accumulate.

Seat Belts ↔ P. 38

- Fasten your seat belt and sit upright well back in the seat.
- Check that your passengers are wearing their seat belts correctly.

Before Driving Checklist ↔ P. 37

- Before driving, check that the front seats, head restraints, steering wheel, and mirrors have been properly adjusted.

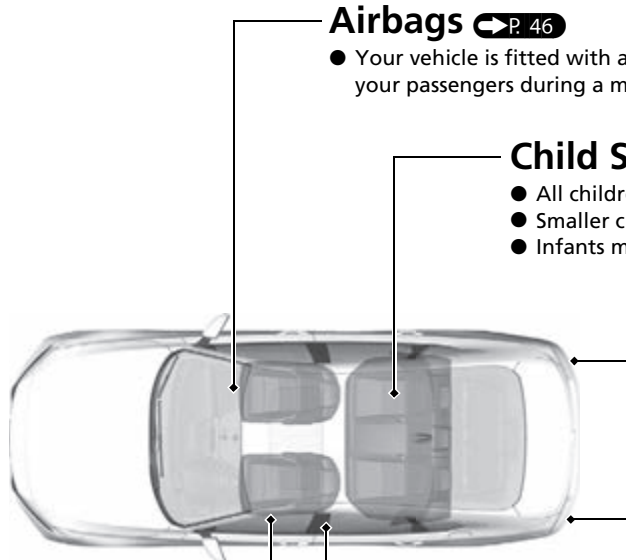

Fasten your lap belt as low as possible.

* Not available on all models

Instrument Panel [P. 81](#)

Indicators [P. 82](#) / Gauges [P. 139](#) / Driver Information Interface [P. 140](#) / Head-Up Display* [P. 159](#)

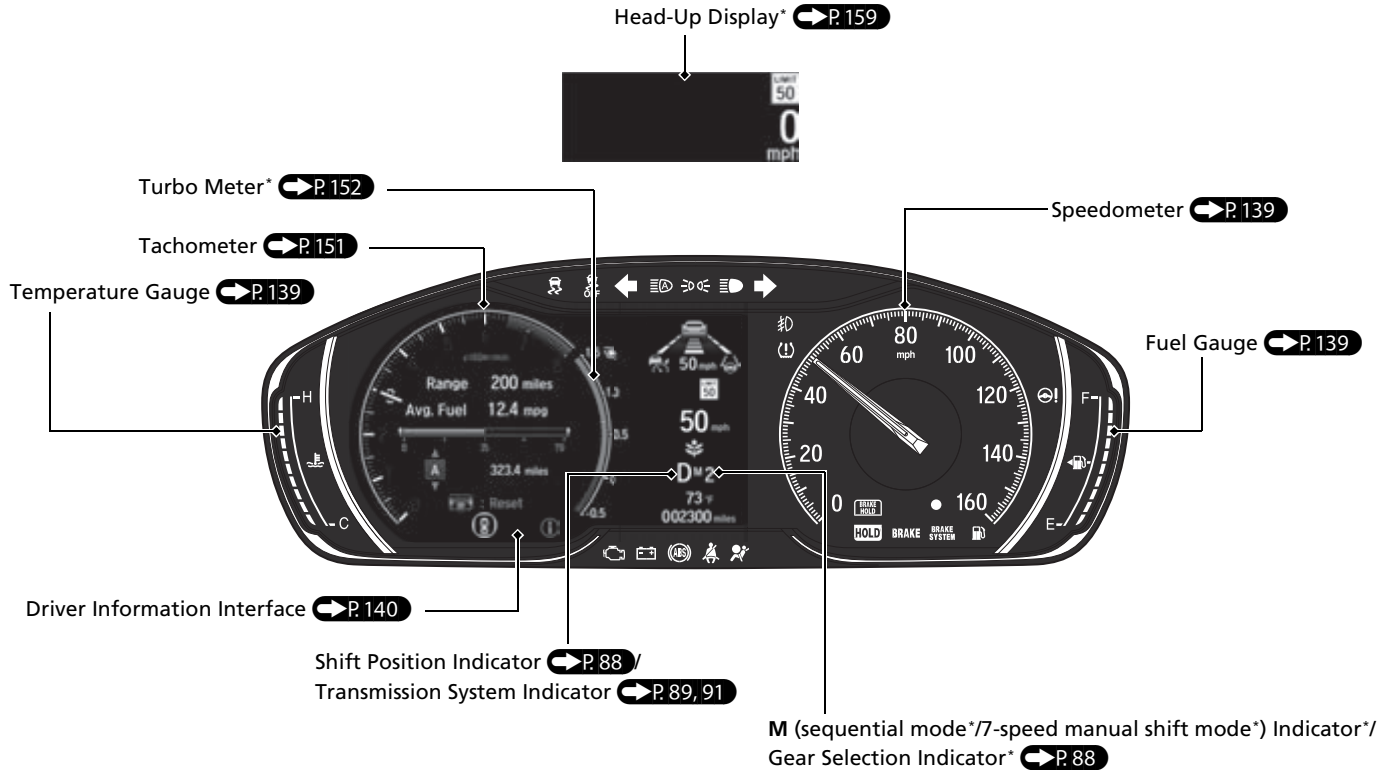

Controls P. 165

Clock P. 166



To adjust time



To adjust date



- 1 Press , then select **Settings**.
- 2 Select **System**, then **Day & Time**.
- 3 Select **Set Date & Time**.
- 4 Select **Automatic Date & Time**, then select **OFF**.

- 5 Select **Set Date** or **Set Time**.
- 6 Adjust the dates, hours, and minutes by selecting /.
- 7 Select **Save** to set the date or time.

Models with navigation system

The navigation system receives signals from GPS satellites, updating the clock automatically.

ENGINE START/STOP Button P. 191

Press the button to change the vehicle's power mode.



Turn Signals P. 194

Turn Signal Control Lever

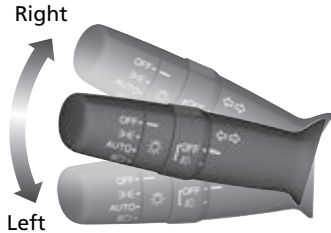

Lights P. 195

Light Control Switches

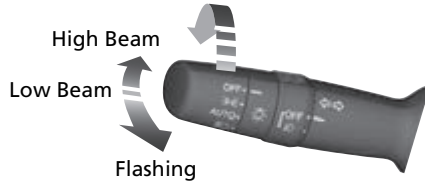





Wipers and Washers

 P. 202

Wiper/Washer Control Lever

Adjustment Ring

- : Low Sensitivity*¹
- : Lower speed, fewer sweeps*²
- : High Sensitivity*¹
- : Higher speed, more sweeps*²

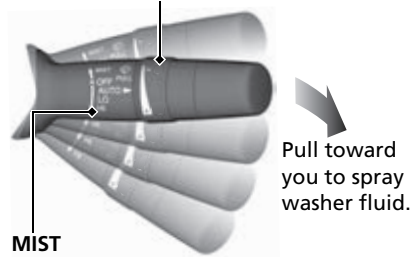

MIST
OFF

AUTO*¹: Wiper speed varies automatically
INT*²: Low speed with intermittent
LO: Low speed wipe
HI: High speed wipe

*1: Models with automatic intermittent wipers

*2: Models with manual intermittent wipers

Models with automatic intermittent wipers

AUTO should always be turned **OFF** before the following situations in order to prevent severe damage to the wiper system:

- Cleaning the windshield
- Driving through a car wash
- No rain present

Steering Wheel P. 209

- To adjust, push the adjustment lever down, adjust to the desired position, then lock the lever back in place.

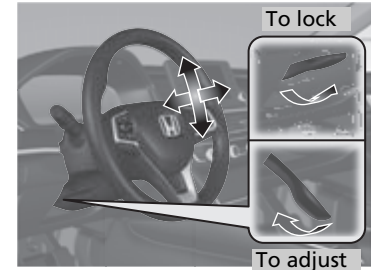

Unlocking the Front Doors from the Inside P. 178

- Pull either front door inner handle to unlock and open it at the same time.

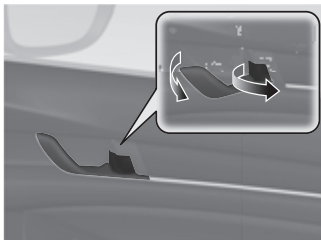

Trunk P. 181

- Press and hold the trunk opener on the driver's door to unlock and open the trunk.
- Press the trunk release button on the keyless remote to unlock and open the trunk.
- Press the trunk release button* on the trunk lid to unlock and open the trunk.

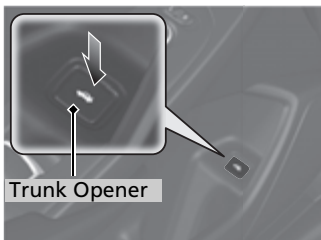

Power Door Mirrors P. 211

- With the power mode in ON, move the selector switch to L or R.
- Push the appropriate edge of the adjustment switch to adjust the mirror.

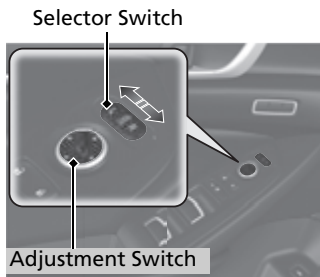

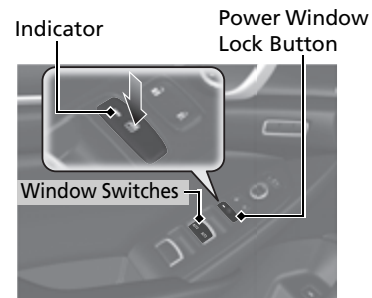

Power Windows P. 187

- With the power mode in ON, open and close the power windows.
- If the power window lock button is in the off position, each passenger's window can be opened and closed with its own switch.
- If the power window lock button is in the on position (indicator on), each passenger's window switch is disabled.



Climate Control System

- Press the **AUTO** button to activate the climate control system.
- Press the  button to turn the system on or off.
- Press the  button to defrost the windshield.

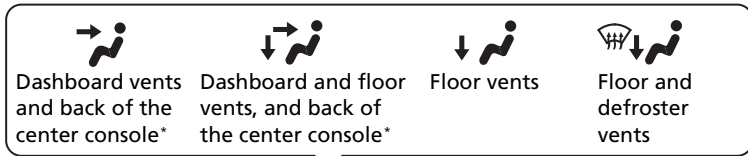

Driver's Side Temperature Control Dial

 (Recirculation) Button

AUTO Button

MODE Control Button

 (Windshield Defroster) Button



Fan Control Dial

Passenger's Side Temperature Control Dial

SYNC (Synchronization) Button

A/C (Air Conditioning) Button

 (ON/OFF) Button

Features ↔ P. 245

Audio Remote Controls

↔ P. 250

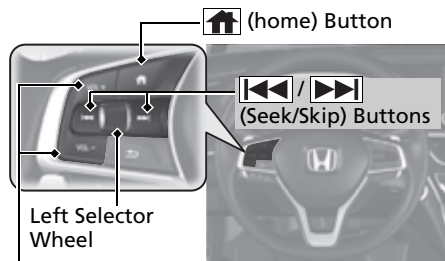

VOL+ / VOL- (Volume) Buttons

- VOL+ / VOL- (Volume) Buttons
Press to adjust the volume up/down.
- Left Selector Wheel
When selecting the audio mode
Press the (home) button, then roll up
or down to select **Audio** on the driver
information interface, and then press the
left selector wheel.

Roll up or down: To cycle through the audio modes, roll up or down and then press the left selector wheel:

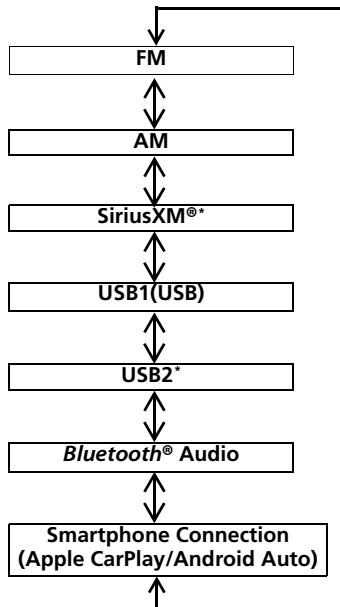

- ◀◀ / ▶▶ (Seek/Skip) Buttons
Radio: Press ◀◀ / ▶▶ to change the preset station.
iPod, USB device, *Bluetooth*® Audio or Smartphone Connection:
Press ◀◀ / ▶▶ to skip to the beginning of the next song or return to the beginning of the current song.
USB device:
Press and hold ◀◀ / ▶▶ to change a folder.

Audio System P. 253

For navigation system operation  See the Navigation System Manual



Driving P. 401

Automatic Transmission* P. 419, 420

- Select **P** and depress the brake pedal when starting the engine.
- **Shifting**

Shift Position Indicator
The shift position indicator and the shift button indicator indicate the current shift position.



Shift Position Indicator

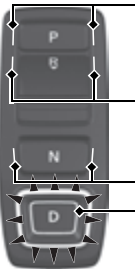

Shift Button Indicator

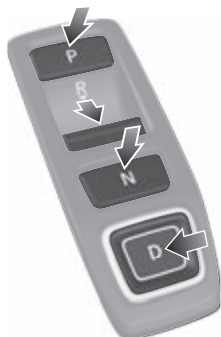

P

Park

Press the **P** button.

Used when parking or starting the engine.

Transmission is locked.

R

Reverse

Pull back the **R** button.

Used when reversing.

N

Neutral

Press the **N** button.

Transmission is not locked.

D

Drive

Press the **D** button.

- Normal driving (gears change between 1st and 10th automatically)
- Temporarily driving in the sequential mode
- Driving in the sequential mode (when driving in SPORT mode)

Sequential Mode P.425

- Paddle shifters allow you to shift gears much like a manual transmission (1st through 10th). This is useful for engine braking.

Shift Position Indicator

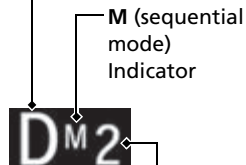

Gear Selection Indicator

Shift Down 
Paddle Shifter

Shift Up 
Paddle Shifter



When the transmission is in

D

- The transmission will shift back to automatic mode once the system detects that the vehicle is cruising.

When the transmission is in **D** with SPORT mode

- Holds the selected gear, and the M (sequential mode) indicator comes on.
- The gear selection is shown in the instrument panel.



Continuously Variable Transmission*

➔ P. 419, 427, 429

- Shift to **P** and depress the brake pedal when starting the engine.
- **Shifting**

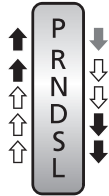

Models without paddle shifters

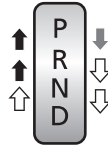

Models with paddle shifters

- Depress the brake pedal and press the shift lever release button to shift.
- Press the shift lever release button and shift.
- Shift without pressing the shift lever release button.

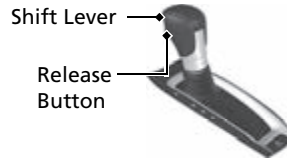

- P Park**
Used when parking or starting the engine.
- R Reverse**
Used when reversing.
- N Neutral**
Transmission is not locked.
- D Drive**
Used:
 - For normal driving

Models with paddle shifters

 - When temporarily driving in the 7-speed manual shift mode
 - When driving in the 7-speed manual shift mode (when driving in SPORT mode)

- S Drive (S)***
Used:
 - For better acceleration
 - To increase engine braking
 - When going up or down hills

- L Low***
Used:
 - To further increase engine braking
 - When going up or down hills

7-Speed Manual Shift Mode* ➔ P. 431

- Allows you to manually shift the transmission up or down without removing your hands from the steering wheel.

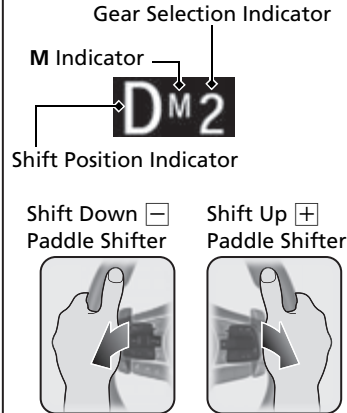

When the transmission is in **D** with SPORT mode

- Pulling a paddle shifter changes the mode from continuously variable transmission to 7-speed manual shift mode.
- The **M** indicator and the selected speed number are displayed in the gear selection indicator.

When the transmission is in **D**

- Pulling a paddle shifter temporarily changes the mode from continuously variable transmission to 7-speed manual shift mode. The selected speed number is displayed in the gear selection indicator.

VSA® On and Off P. 442

- The Vehicle Stability Assist™ (VSA®) system helps stabilize the vehicle during cornering and helps maintain traction while accelerating on loose or slippery road surfaces.
- VSA® comes on automatically every time you start the engine.
- To partially disable or fully restore VSA® function, press and hold the button until you hear a beep.

CMBS™ On and Off

 P. 459

- When a possible frontal collision is likely unavoidable, the CMBS™ can help you to reduce the vehicle speed and the severity of the collision.
- The CMBS™ is turned on every time you start the engine.
- To turn the CMBS™ on or off, use the safety support switch.

Tire Pressure Monitoring System (TPMS) P. 444

- Detects a change in tire conditions and overall dimensions due to decrease in tire pressures.
- The TPMS is turned on automatically every time you start the engine.
- A calibration procedure must be performed when certain conditions arise.

Refueling P. 531

Fuel recommendation: Unleaded gasoline, pump octane number 87 or higher

Fuel tank capacity: 14.8 US gal (56 L)

- 1 Unlock the driver's door.
- 2 Press the area indicated by the arrow to release the fuel fill door. You will hear a click.
- 3 After filling, wait about five seconds before removing the filler nozzle.

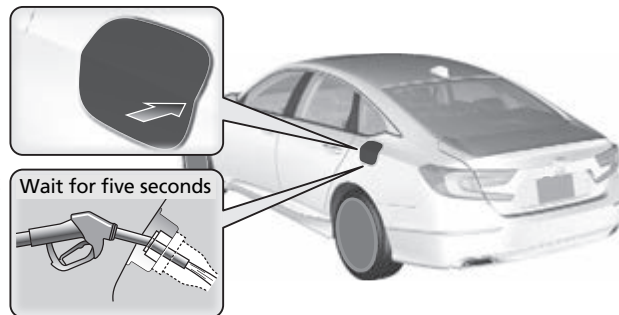

Honda Sensing®

➔ P. 453

Models with Low Speed Braking Control

Honda Sensing® is a driver support system which employs the use of three distinctly different kinds of sensors, a radar sensor located at the lower part of the front bumper, a front sensor camera mounted to the interior side of the windshield, behind the rearview mirror, and the sonar sensors located in the front and rear bumpers.

Models without Low Speed Braking Control

Honda Sensing® is a driver support system which employs the use of two distinctly different kinds of sensors, a radar sensor located at the lower part of the front bumper and a front sensor camera mounted to the interior side of the windshield, behind the rearview mirror.

All models

The camera is located behind the rearview mirror.

Front Sensor
Camera

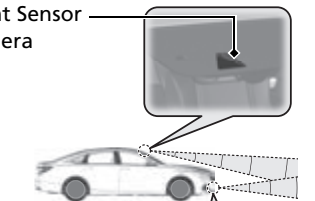

Radar Sensor

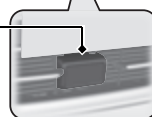

The radar sensor is at the lower part of the front bumper.

Models with Low Speed Braking Control

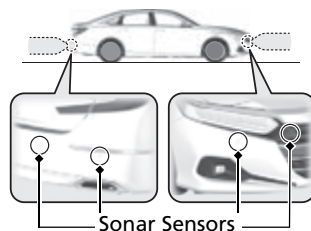

Collision Mitigation Braking System™ (CMBS™)

➔ P. 456

The system can assist you when it determines there is a possibility of your vehicle colliding with a vehicle or a pedestrian detected in front of your vehicle. The CMBS™ is designed to alert you when the potential for a collision is determined, as well as to reduce your vehicle speed to help minimize collision severity when a collision is deemed unavoidable.

Low Speed Braking Control*

➔ P. 465

Using sonar sensors located on the front and rear bumpers, the vehicle detects if there is danger of a potential collision with a wall or other obstacle. The system is designed to alert you when a potential collision is determined, as well as assist in reducing speed, avoiding collisions, and reducing collision severity.

Adaptive Cruise Control (ACC) with Low Speed Follow P. 470

Helps maintain a constant vehicle speed and a set following-interval behind a vehicle detected ahead of yours and, if the detected vehicle comes to a stop, can decelerate and stop your vehicle, without you having to keep your foot on the brake or the accelerator.

Lane Keeping Assist System (LKAS) P. 486

Provides steering input to help keep the vehicle in the middle of a detected lane and provides tactile and visual alerts if the vehicle is detected drifting out of its lane.

Road Departure Mitigation (RDM) System P. 494

Alerts and helps to assist you when the system detects a possibility of your vehicle unintentionally crossing over detected lane markings and/or leaving the roadway altogether.

Traffic Sign Recognition System P. 498

Reminds you of road sign information, such as the current speed limit, your vehicle has just passed through, showing it on the driver information interface and the head-up display*.

Maintenance P. 537

Under the Hood P. 548

- Check engine oil, engine coolant, and windshield washer fluid. Add when necessary.
- Check brake fluid.
- Check the battery condition monthly.

- 1 Pull the hood release handle under the corner of the dashboard.



- 2 Locate the hood latch lever, push it to the side, and then raise the hood. Once you have raised the hood slightly, you can release the lever.

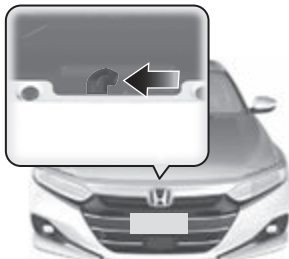

- 3 When finished, close the hood and make sure it is firmly locked in place.

Wiper Blades P. 572

- Replace blades if they leave streaks across the windshield or become noisy.

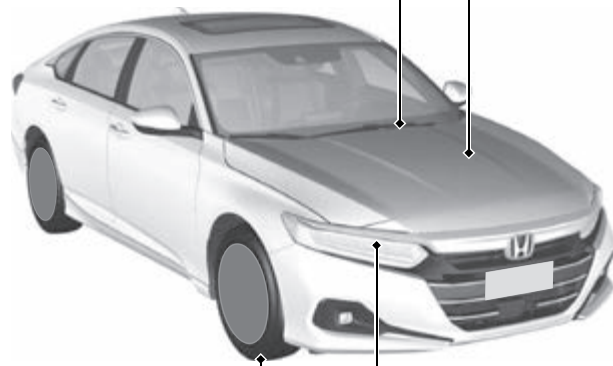

Tires P. 575

- Inspect tires and wheels regularly.
- Check tire pressures regularly.
- Install snow tires for winter driving.

Lights P. 564

- Inspect all lights regularly.

Handling the Unexpected P. 595

Flat Tire P. 597

- Park in a safe location and replace the flat tire with the compact spare tire in the trunk.



Engine Won't Start P. 603

- If the battery is dead, jump start using a booster battery.

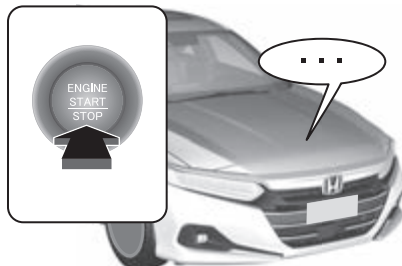

Overheating P. 611

- Park in a safe location. If you do not see steam under the hood, open the hood, and let the engine cool down.



Indicators Come On P. 613

- Identify the indicator and consult the owner's manual.



Blown Fuse P. 620

- Check for a blown fuse if an electrical device does not operate.

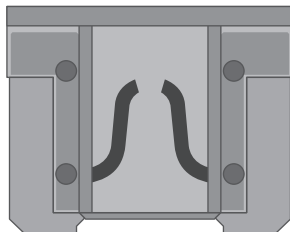

Emergency Towing P. 626

- Call a professional towing service if you need to tow your vehicle.

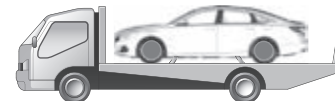

What to Do If



Continuously variable transmission models for Canadian models

The power mode does not change from VEHICLE OFF to ACCESSORY. Why?



- The steering wheel may be locked.
- Move the steering wheel left and right after pressing the **ENGINE START/STOP** button.



Continuously variable transmission models

The power mode does not change from ACCESSORY to VEHICLE OFF. Why?



The shift lever should be moved to **P**.



Why does the brake pedal pulsate slightly when applying the brakes?



This can occur when the ABS activates and does not indicate a problem. Apply firm, steady pressure on the brake pedal. Never pump the brake pedal.

➤ Anti-lock Brake System (ABS) ➔ P.516

Q The rear door cannot be opened from inside the vehicle. Why?

A Check if the childproof lock is in the lock position. If so, open the rear door with the outside door handle. To cancel this function, slide the lever up to the unlock position.

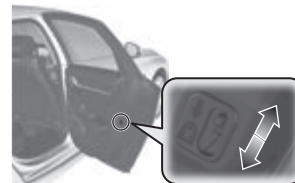

Q Why do the doors lock after I unlocked the doors?

A If you do not open the doors within 30 seconds, the doors are relocked automatically for security.

Q Why does the beeper sound when I open the driver's door?

A The beeper sounds when:

- The power mode is in ACCESSORY.
- The exterior lights are left on.

1.5 L engine models

- The Auto Idle Stop is in operation.

Q Why does a beeper sound when I walk away from the vehicle after I close the door?

A The beeper sounds if you move outside the walk away auto lock operating range before the door completely closes.

🔒 Locking the doors (Walk away auto lock®) ➔ P.172

Q Why does the beeper sound when I start driving?

A The beeper sounds when the driver and/or front passenger are not wearing their seat belts.

Q Pressing the electric parking brake switch does not release the parking brake. Why?

A Press the electric parking brake switch with the brake pedal depressed.

Q I'm seeing an amber indicator of a tire with an exclamation point. What is that?

A The Tire Pressure Monitoring System (TPMS) needs attention. If you recently inflated or changed a tire, you have to recalibrate the system.
➤ Tire Pressure Monitoring System (TPMS) ➔ P.444

Q Depressing the accelerator pedal does not release the parking brake automatically. Why?

A

- Fasten the driver's seat belt.
- Check if the transmission is in **P** or **N**. If so, select any other position.

Q **Automatic transmission models**
Why does the shift position automatically change to **P** when I open the driver's door to check for parking space lines when reversing?

A

- Fasten the driver's seat belt.
- Close the driver's door and manually change the shift position.
➤ When opening the driver's door ➔ P.422

Q Why do I hear a screeching sound when I apply the brake pedal?

A The brake pads may need to be replaced. Have your vehicle inspected by a dealer.

Safe Driving

You can find many safety recommendations throughout this chapter, and throughout this manual.

For Safe Driving

Important Safety Precautions.....	34
Your Vehicle's Safety Features.....	36
Safety Checklist	37

Seat Belts

About Your Seat Belts.....	38
Fastening a Seat Belt.....	42
Seat Belt Inspection.....	45

Airbags

Airbag System Components.....	46
Types of Airbags.....	49
Front Airbags (SRS)	49

Knee Airbags.....	54
Side Airbags.....	57
Side Curtain Airbags.....	59
Airbag System Indicators.....	60
Airbag Care	63

Child Safety

Protecting Child Passengers	64
Safety of Infants and Small Children.....	66
Safety of Larger Children	76

Exhaust Gas Hazard

Carbon Monoxide Gas.....	78
--------------------------	----

Safety Labels

Label Locations.....	79
----------------------	----

The following pages explain your vehicle's safety features and how to use them properly. The safety precautions below are ones that we consider to be among the most important.

Important Safety Precautions

■ Always wear your seat belt

A seat belt is your best protection in all types of collisions. Airbags are designed to supplement seat belts, not replace them. So even though your vehicle is equipped with airbags, make sure you and your passengers always wear your seat belts, and wear them properly.

■ Restrain all children

Children ages 12 and under should ride properly restrained in a back seat, not the front seat. Infants and small children should be restrained in a child seat. Larger children should use a booster seat and a lap/shoulder seat belt until they can use the belt properly without a booster seat.

■ Be aware of airbag hazards

While airbags can save lives, they can cause serious or fatal injuries to occupants who sit too close to them, or are not properly restrained. Infants, young children, and short adults are at the greatest risk. Be sure to follow all instructions and warnings in this manual.

■ Don't drink and drive

Alcohol and driving don't mix. Even one drink can reduce your ability to respond to changing conditions, and your reaction time gets worse with every additional drink. So don't drink and drive, and don't let your friends drink and drive, either.

▣ Important Safety Precautions

Some states, provinces and territories prohibit the use of cell phones other than hands-free devices by the driver while driving.

■ Pay appropriate attention to the task of driving safely

Engaging in cell phone conversation or other activities that keep you from paying close attention to the road, other vehicles, and pedestrians could lead to a crash. Remember, situations can change quickly, and only you can decide when it is safe to divert some attention away from driving.

■ Control your speed

Excessive speed is a major factor in crash injuries and deaths. Generally, the higher the speed, the greater the risk, but serious injuries can also occur at lower speeds. Never drive faster than is safe for current conditions, regardless of the maximum speed posted.

■ Keep your vehicle in safe condition

Having a tire blowout or a mechanical failure can be extremely hazardous. To reduce the possibility of such problems, check your tire pressures and condition frequently, and perform all regularly scheduled maintenance.

■ Do not leave children unattended in the vehicle

Children, pets, and people needing assistance left unattended in the vehicle may be injured if they activate one or more of the vehicle controls. They may also cause the vehicle to move, resulting in a crash in which they and/or another person(s) can be injured or killed. Also, depending on the ambient temperature, the temperature of the interior may reach extreme levels, which can result in harm or death. Even if the climate control system is on, never leave them in the vehicle unattended as the climate control system can shut off at any time.

Your Vehicle's Safety Features

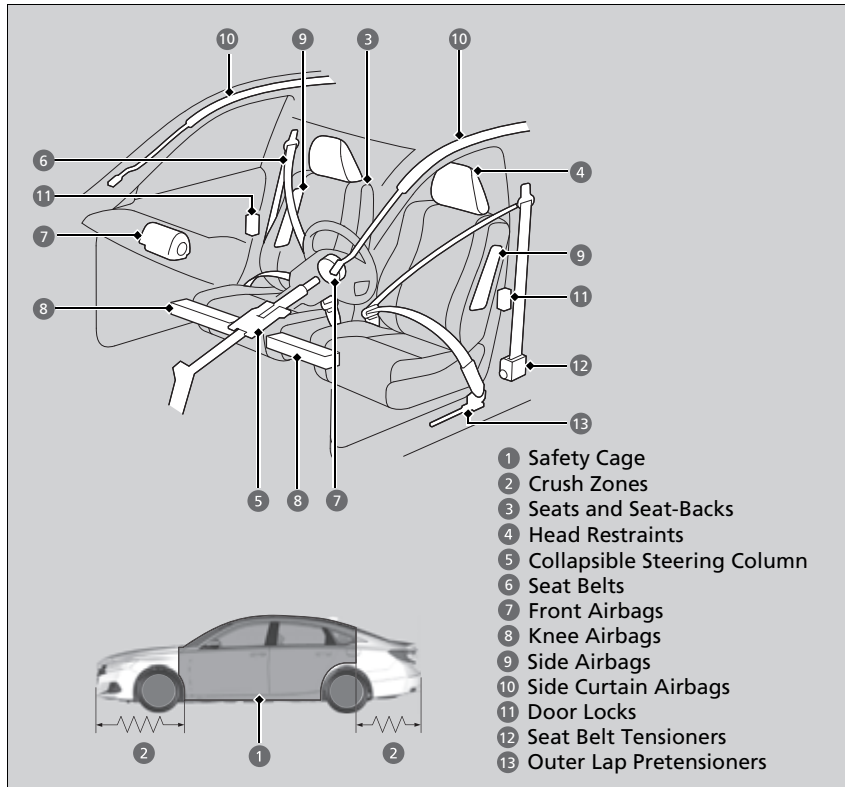

The following checklist will help you take an active role in protecting yourself and your passengers.

►► Your Vehicle's Safety Features

Your vehicle is equipped with many features that work together to help protect you and your passengers during a crash.

Some features do not require any action on your part. These include a strong steel framework that forms a safety cage around the passenger compartment, front and rear crush zones, a collapsible steering column, and tensioners that tighten the front seat belts in a sufficient crash.

However, you and your passengers cannot take full advantage of these features unless you remain seated in the correct position and always wear your seat belts. In fact, some safety features can contribute to injuries if they are not used properly.

Safety Checklist

For the safety of you and your passengers, make a habit of checking these items each time before you drive.

- After everyone has entered the vehicle, be sure all doors are closed and locked. Locking the doors helps prevent an occupant from being ejected and an outsider from unexpectedly opening a door.
 - **Locking/Unlocking the Doors from the Inside** P. 177
- Adjust your seat to a position suitable for driving. Be sure the front seats are adjusted as far to the rear as possible while allowing the driver to control the vehicle. Sitting too close to a front airbag can result in serious or fatal injury in a crash.
 - **Seats** P. 212
- Adjust head restraints to the proper position. Head restraints are most effective when the center of the head restraint aligns with the center of your head. Taller persons should adjust their head restraint to the highest position.
 - **Adjusting the Front and Rear Outer* Head Restraint Positions** P. 219
- Always wear your seat belt, and make sure you wear it properly. Confirm that any passengers are properly belted as well.
 - **Fastening a Seat Belt** P. 42
- Protect children by using seat belts or child seats according to a child's age, height, and weight.
 - **Child Safety** P. 64

* Not available on all models

➤ Safety Checklist

If the door and/or trunk open message appears on the driver information interface, a door and/or the trunk is not completely closed. Close all doors and the trunk tightly until the message disappears.

➤ **Driver Information Interface Warning and Information Messages** P. 109

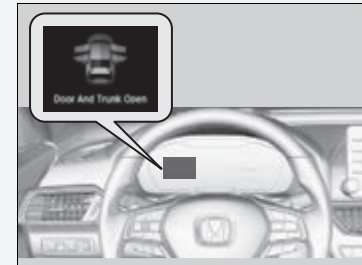

About Your Seat Belts

Seat belts are the single most effective safety device because they keep you connected to the vehicle so that you can take advantage of many built-in safety features. They also help keep you from being thrown against the inside of the vehicle, against any passengers, or out of the vehicle. When worn properly, seat belts also keep your body properly positioned in a crash so that you can take full advantage of the additional protection provided by the airbags.

In addition, seat belts help protect you in almost every type of crash, including:

- frontal impacts
- side impacts
- rear impacts
- rollovers

■ Lap/shoulder seat belts

All five seating positions are equipped with lap/shoulder seat belts with emergency locking retractors. In normal driving, the retractor lets you move freely while keeping some tension on the belt. During a collision or sudden stop, the retractor locks to restrain your body.

The front passenger's and rear seat belts also have a lockable retractor for use with child seats.

➤ **Installing a Child Seat with a Lap/Shoulder Seat Belt** P. 72

➤ About Your Seat Belts

WARNING

Not wearing a seat belt properly increases the chance of serious injury or death in a crash, even though your vehicle has airbags.

Be sure you and your passengers always wear seat belts and wear them properly.

If a front or rear seat passenger moves around and extends the seat belt, the lockable retractor may activate. If this happens, release the retractor by unfastening the seat belt and allow the belt to retract completely. Then, refasten the belt.

If you extend the seat belt too quickly, it will lock in place. If this happens, slightly retract the seat belt, then extend it slowly.

Seat belts cannot completely protect you in every crash. But in most cases, seat belts can reduce your risk of serious injury.

■ Proper use of seat belts

Follow these guidelines for proper use:

- All occupants should sit upright, well back in the seat, and remain in that position for the duration of the trip. Slouching and leaning reduce the effectiveness of the belt and can increase the chance of serious injury in a crash.
- Never place the shoulder part of a lap/shoulder seat belt under your arm or behind your back. This could cause very serious injuries in a crash.
- Two people should never use the same seat belt. If they do, they could be very seriously injured in a crash.
- Do not put any accessories on the seat belts. Devices intended to improve comfort or reposition the shoulder part of a seat belt can reduce the protective capability and increase the chance of serious injury in a crash.

■ Seat Belt Reminder



■ Front seats

The seat belt system includes an indicator on the instrument panel to remind the driver or a front passenger or both to fasten their seat belts.

If you set the power mode to ON and a seat belt is not fastened, a beeper will sound and the indicator will blink. After a few seconds, the beeper will stop and the indicator will come on and remain illuminated until the seat belt is fastened.

The beeper will periodically sound and the indicator will blink while the vehicle is moving until the seat belt is fastened.

▶▶ About Your Seat Belts

Most states and all Canadian provinces and territories require you to wear seat belts.

▶▶ Seat Belt Reminder

The indicator will also come on if a front passenger does not fasten their seat belt within six seconds after the power mode is set to ON.

When no one is sitting in the front passenger's seat, the indicator will not come on and the beeper will not sound.

The indicator also may not come on and the beeper may not sound when the occupant is not heavy enough to trigger the weight sensor. Such occupants (e.g., infants and smaller children) should be moved to the rear seat as a deploying front airbag likely will injure or kill them.

▶▶ **Protecting Child Passengers** P. 64

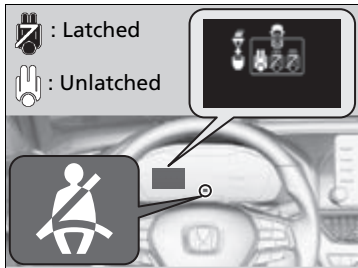

■ Rear seats

Your vehicle monitors rear seat belt use. A driver information interface notifies you if any of the rear seat belts are not used.

The display appears when:

- Any of the rear passengers' seat belts are unfastened when the power mode is turned to ON.
- A rear door is opened and then closed.
- Any of the rear passengers fastens or unfastens their seat belt.

The seat belt reminder indicator blinks and beeper sounds if any rear passenger's seat belt is unfastened while driving.

To see the display:

- ▶ **Switching the Display** P. 140

Automatic Seat Belt Tensioners

The front seats are equipped with automatic seat belt tensioners to enhance safety.

The tensioners automatically tighten the front seat belts during a moderate-to-severe frontal collision, sometimes even if the collision is not severe enough to inflate the front airbags or the knee airbags.

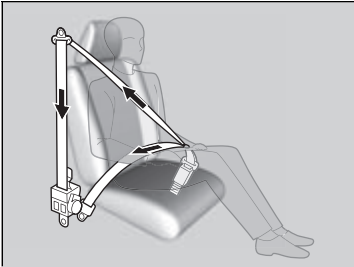

Automatic Seat Belt Tensioners

The seat belt tensioners can only operate once. If a tensioner is activated, the SRS indicator will come on. Have a dealer replace the tensioner and thoroughly inspect the seat belt system as it may not offer protection in a subsequent crash.

During a moderate-to-severe side impact, the tensioner on that side of the vehicle also activates.

Fastening a Seat Belt

After adjusting a front seat to the proper position, and while sitting upright and well back in the seat:

➤ **Seats** P. 212

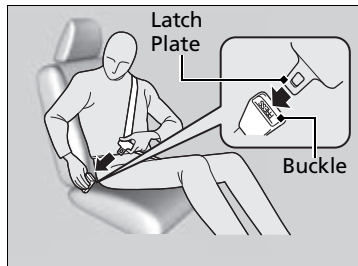
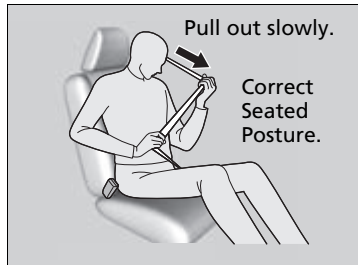

1. Pull the seat belt out slowly.

2. Insert the latch plate into the buckle, then tug on the belt to make sure the buckle is secure.

▶ Make sure that the belt is not twisted or caught on anything.

Fastening a Seat Belt

No one should sit in a seat with an inoperative seat belt or one that does not appear to be working correctly. Using a seat belt that is not working properly may not protect the occupant in a crash. Have a dealer check the belt as soon as possible.

If the seat belt appears to be locked in a fully retracted position, firmly pull out on the shoulder belt once, then push it back in. Then, smoothly pull it out of the retractor and fasten. If you are unable to release the seat belt from a fully retracted position, do not allow anyone to sit in the seat, and take your vehicle to a dealer for repair.

➤ **About Your Seat Belts** P. 38

➤ **Seat Belt Inspection** P. 45



3. Position the lap part of the belt as low as possible across your hips, then pull up on the shoulder part of the belt so the lap part fits snugly. This lets your strong pelvic bones take the force of a crash and reduces the chance of internal injuries.
4. If necessary, pull up on the belt again to remove any slack, then check that the belt rests across the center of your chest and over your shoulder. This spreads the forces of a crash over the strongest bones in your upper body.

■ Adjusting the Shoulder Anchor

The front seats have adjustable shoulder anchors to accommodate taller and shorter occupants.

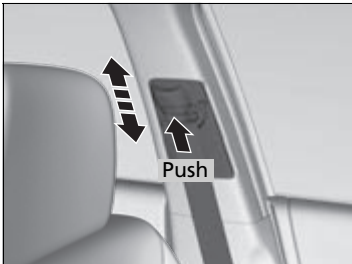

1. Move the anchor up and down while holding the release button.
2. Position the anchor so that the belt rests across the center of your chest and over your shoulder.

⊠ Fastening a Seat Belt

⚠ WARNING

Improperly positioning the seat belts can cause serious injury or death in a crash.

Make sure all seat belts are properly positioned before driving.

To release the belt, push the red **PRESS** button and then guide the belt by hand until it has retracted completely. When exiting the vehicle, be sure the belt is properly stowed so that it will not get caught in the closing door.

Never insert any foreign objects into the buckle or retractor mechanism.

⊠ Adjusting the Shoulder Anchor

After an adjustment, make sure that the shoulder anchor position is secure.

The shoulder anchor height can be adjusted to four levels. If the belt contacts your neck, lower the height one level at a time.

■ Advice for Pregnant Women

If you are pregnant, the best way to protect yourself and your unborn child when driving or riding in a vehicle is to always wear a seat belt and keep the lap part of the belt as low as possible across the hips.

Wear the shoulder belt across the chest avoiding the abdomen.



Wear the lap part of the belt as low as possible across the hips.

▣ Advice for Pregnant Women

Each time you have a checkup, ask your doctor if it is okay for you to drive.

To reduce the risk of injuries to both you and your unborn child that can be caused by an inflating front airbag:

- When driving, sit upright and adjust the seat as far back as possible while allowing full control of the vehicle.
- When sitting in the front passenger's seat, adjust the seat as far back as possible.

Seat Belt Inspection

Regularly check the condition of your seat belts as follows:

- Pull each belt out fully, and look for frays, cuts, burns, and wear.
- Check that the latch plates and buckles work smoothly and the belts retract easily.
 - ▶ If a belt does not retract easily, cleaning the belt may correct the problem. Only use a mild soap and warm water. Do not use bleach or cleaning solvents. Make sure the belt is completely dry before allowing it to retract.

Any belt that is not in good condition or working properly will not provide proper protection and should be replaced as soon as possible.

A belt that has been worn during a crash may not provide the same level of protection in a subsequent crash. Have your seat belts inspected by a dealer after any collision.

Seat Belt Inspection

⚠ WARNING

Not checking or maintaining seat belts can result in serious injury or death if the seat belts do not work properly when needed.

Check your seat belts regularly and have any problem corrected as soon as possible.

Airbag System Components

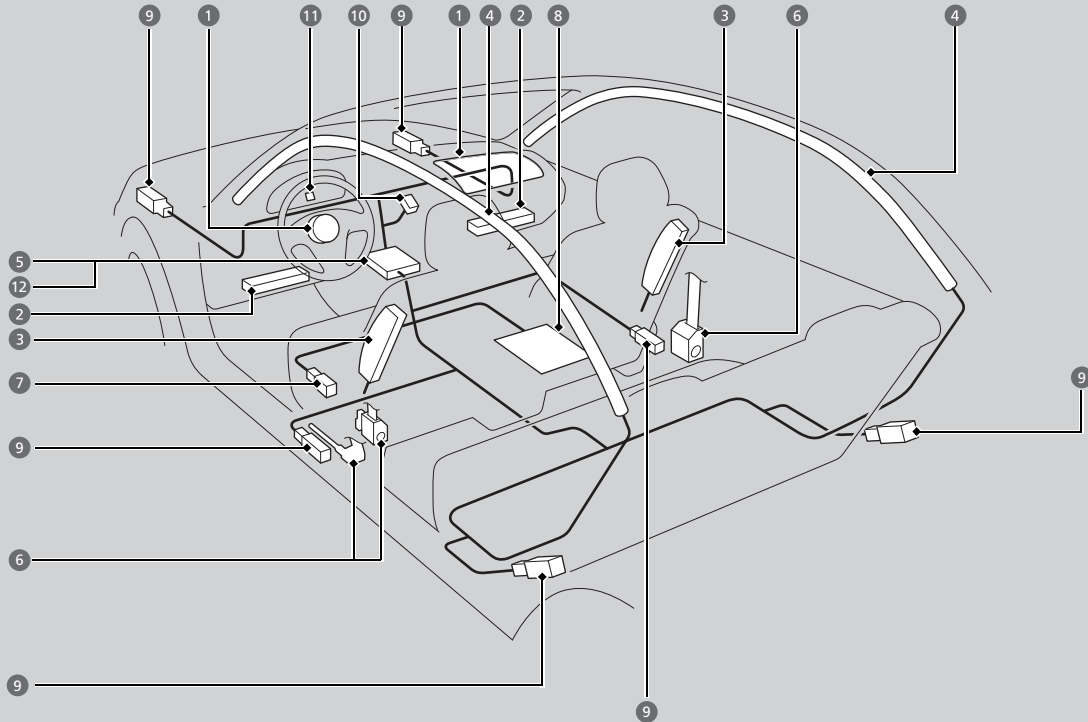

The front, front knee, side, and side curtain airbags are deployed according to the direction and severity of impact. Both side curtain airbags are deployed in a rollover. The airbag system includes:

- 1 Two SRS (Supplemental Restraint System) front airbags. The driver's airbag is stored in the center of the steering wheel; the front passenger's airbag is stored in the dashboard. Both are marked **SRS AIRBAG**.
- 2 Two knee airbags. The driver's knee airbag is stored under the steering column; the front passenger's knee airbag is stored under the glove box. Both are marked **SRS AIRBAG**.
- 3 Two side airbags, one for the driver and one for the front passenger. The airbags are stored in the outer edges of the seat-backs. Both are marked **SIDE AIRBAG**.
- 4 Two side curtain airbags, one for each side of the vehicle. The airbags are stored in the ceiling, above the side windows. The front and rear pillars are marked **SIDE CURTAIN AIRBAG**.
- 5 An electronic control unit that, when the power mode is in ON, continually monitors information about the various impact sensors, seat and buckle sensors, rollover sensor, airbag activators, seat belt tensioners, and other vehicle information. During a crash event the unit can record such information.
- 6 Automatic front seat belt tensioners. In addition, the driver's and front passenger's seat belt buckles incorporate sensors that detect whether or not the belts are fastened.
- 7 Driver's seat position sensor. This sensor detects the driver's seat slide position to help determine the optimal deployment of the driver's airbag.
- 8 Weight sensors in the front passenger's seat. The sensors are used for occupant classification to activate or deactivate the front passenger's airbag.
- 9 Impact sensors that can detect a moderate-to-severe front or side impact.
- 10 An indicator on the dashboard that alerts you that the front passenger's front airbag has been turned off.
- 11 An indicator on the instrument panel that alerts you to a possible problem with your airbag system or seat belt tensioners.
- 12 A rollover sensor that can detect if your vehicle is about to roll over and signal the control unit to deploy both side curtain airbags.

■ Important Facts About Your Airbags

Airbags can pose serious hazards. To do their job, airbags must inflate with tremendous force. So, while airbags help save lives, they can cause burns, bruises, and other minor injuries, sometimes even fatal ones if occupants are not wearing their seat belts properly and sitting correctly.

What you should do: Always wear your seat belt properly and sit upright and as far back from the steering wheel as possible while allowing full control of the vehicle. A front passenger should move their seat as far back from the dashboard as possible.

Remember, however, that no safety system can prevent all injuries or deaths that can occur in a severe crash, even when seat belts are properly worn and the airbags deploy.

Do not place hard or sharp objects between yourself and a front airbag.

Carrying hard or sharp objects on your lap, or driving with a pipe or other sharp object in your mouth, can result in injuries if your front airbag inflates.

Do not attach or place objects on the front and front knee airbag covers.

Objects on the covers marked **SRS AIRBAG** could interfere with the proper operation of the airbags or be propelled inside the vehicle and hurt someone if the airbags inflate.

▣ Important Facts About Your Airbags

Do not attempt to deactivate your airbags. Together, airbags and seat belts provide the best protection.

When driving, keep hands and arms out of the deployment path of the front airbag by holding each side of the steering wheel. Do not cross an arm over the airbag cover.

Types of Airbags

Your vehicle is equipped with four types of airbags:

- **Front airbags:** Airbags in front of the driver's and front passenger's seats.
- **Front knee airbags:** Airbags under the steering column and under the glove box.
- **Side airbags:** Airbags in the driver's and front passenger's seat-backs.
- **Side curtain airbags:** Airbags above the side windows.

Each is discussed in the following pages.

Front Airbags (SRS)

The front SRS airbags inflate in a moderate-to-severe frontal collision to help protect the head and chest of the driver and/or front passenger.

SRS (Supplemental Restraint System) indicates that the airbags are designed to supplement seat belts, not replace them. Seat belts are the occupant's primary restraint system.

Housing Locations

The front airbags are housed in the center of the steering wheel for the driver, and in the dashboard for the front passenger. Both airbags are marked **SRS AIRBAG**.

Types of Airbags

The airbags can inflate whenever the power mode is in ON.

After an airbag inflates in a crash, you may see a small amount of smoke. This is from the combustion process of the inflator material and is not harmful. People with respiratory problems may experience some temporary discomfort. If this occurs, get out of the vehicle as soon as it is safe to do so.

Front Airbags (SRS)

During a frontal crash severe enough to cause one or both front airbags to deploy, the airbags can inflate at different rates, depending on the severity of the crash, whether or not the seat belts are latched, and/or other factors. Frontal airbags are designed to supplement the seat belts to help reduce the likelihood of head and chest injuries in frontal crashes.

■ Operation

Front airbags are designed to inflate during moderate-to-severe frontal collisions. When the vehicle decelerates suddenly, the sensors send information to the control unit which signals one or both front airbags to inflate.

A frontal collision can be either head-on or angled between two vehicles, or when a vehicle crashes into a stationary object, such as a concrete wall.

■ How the Front Airbags Work

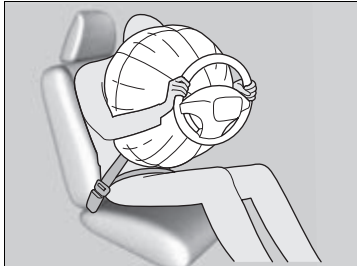

While your seat belt restrains your torso, the front airbag provides supplemental protection for your head and chest.

The front airbags deflate immediately so that they won't interfere with the driver's visibility or the ability to steer or operate other controls.

The total time for inflation and deflation is so fast that most occupants are not aware that the airbags deployed until they see them lying in front of them.

✎ How the Front Airbags Work

Although the driver's and front passenger's airbags normally inflate within a split second of each other, it is possible for only one airbag to deploy. This can happen if the severity of a collision is at the margin, or threshold, that determines whether or not the airbags will deploy. In such cases, the seat belt will provide sufficient protection, and the supplemental protection offered by the airbag would be minimal.

■ When front airbags should not deploy

Minor frontal crashes: Front airbags were designed to supplement seat belts and help save lives, not to prevent minor scrapes, or even broken bones that might occur during a less than moderate-to-severe frontal crash.

Side impacts: Front airbags can provide protection when a sudden deceleration causes a driver or front passenger to move toward the front of the vehicle. Side airbags and side curtain airbags have been specifically designed to help reduce the severity of injuries that can occur during a moderate-to-severe side impact which can cause the driver or passenger to move toward the side of the vehicle.

Rear impacts: Head restraints and seat belts are your best protection during a rear impact. Front airbags cannot provide any significant protection and are not designed to deploy in such collisions.

Rollovers: In a rollover, your best form of protection is a seat belt or, if your vehicle is equipped with a rollover sensor, both a seat belt and a side curtain airbag. Front airbags, however, are not designed to deploy in a rollover as they would provide little if any protection.

■ When front airbags deploy with little or no visible damage

Because the airbag system senses sudden deceleration, a strong impact to the vehicle framework or suspension might cause one or more of the airbags to deploy. Examples include running into a curb, the edge of a hole, or other low fixed object that causes a sudden deceleration in the vehicle chassis. Since the impact is underneath the vehicle, damage may not be readily apparent.

■ When front airbags may not deploy, even though exterior damage appears severe

Since crushable body parts absorb crash energy during an impact, the amount of visible damage does not always indicate proper airbag operation. In fact, some collisions can result in severe damage but no airbag deployment because the airbags would not have been needed or would not have provided protection even if they had deployed.

Advanced Airbags

The airbags have advanced features to help reduce the likelihood of airbag related injuries to smaller occupants.

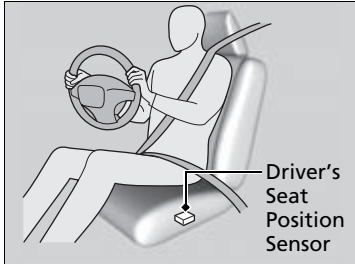

The driver's advanced airbag system includes a seat position sensor.

Based on information from this sensor and the severity of the impact, the advanced airbag system determines the optimal deployment of the driver's airbag.

Advanced Airbags

If there is a problem with the driver's seat position sensor or the passenger's seat weight sensors, the SRS indicator will come on, and in the event of a crash, the airbag will deploy (regardless of the driver's seating position or passenger's occupant classification) with a force corresponding to the severity of the impact.

▶ **Supplemental Restraint System (SRS) Indicator** P. 60

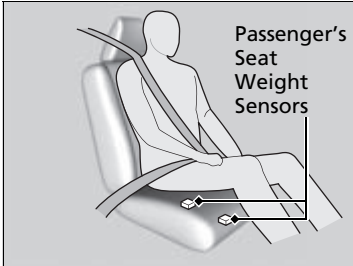

The front passenger's advanced airbag system has weight sensors. The sensors are used for occupant classification to activate or deactivate the front passenger's airbag.

For adult size occupants, the system will automatically activate the front passenger's airbag. If a small adult sits in the front passenger seat and the system does not recognize him/her as an adult, see

➤ **Passenger Airbag Off Indicator** P. 61

We advise against allowing a child age 12 or under to ride in the front passenger's seat. However, if you do allow a small child or infant to ride in the front passenger's seat, the system is designed to automatically deactivate the front passenger's airbag. Do not let a small child or infant ride in the front passenger's seat if the airbag does not automatically deactivate.

➤ Advanced Airbags

For the advanced front airbags to work properly, confirm that:

- The occupant is sitting in an upright position, wearing the seat belt properly and the seat-back is not excessively reclined.
- The occupant is not leaning against the door or center console.
- The occupant's feet are placed on the floor in front of them.
- There are no objects hanging from the front passenger's seat.
- Only small, lightweight objects are in the seat-back pocket.
- The steering wheel and passenger's side dashboard are not obstructed by any object.
- No liquid has been spilled on or under the seat.
- There is no child seat or other object pressing against the rear of the seat or seat-back.
- There is no rear passenger pushing or pulling on the back of the front passenger's seat.
- There are no objects placed under or beside the front passenger's seat. Improperly positioned objects can interfere with the advanced airbag sensors.
- The head restraint is not contacting the roof.
- The floor mat behind the front passenger's seat is set in the correct position evenly on the floor. An improperly placed mat can interfere with the advanced airbag sensors.

➤ **Floor Mats** P. 589

Knee Airbags

The knee SRS airbags inflate in a moderate-to-severe frontal collision to help keep the driver and/or front passenger in the proper position and to help maximize the benefit provided by the vehicle's other safety features.

SRS (Supplemental Restraint System) indicates that the airbags are designed to supplement seat belts, not replace them. Seat belts are the occupant's primary restraint system.

Housing Locations

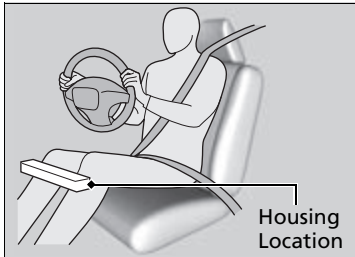

The knee airbag for the driver and the one for the front passenger are housed under the steering column and the glove box respectively.

Both are marked **SRS AIRBAG**.

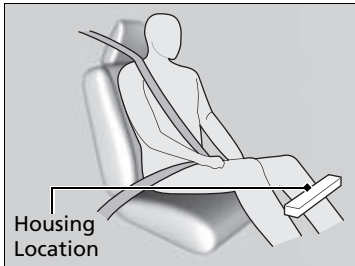

⚠ Knee Airbags

Do not attach accessories on or near a knee airbag as they can interfere with the proper operation of the airbag, or even hurt someone if the airbag inflates.

The driver and front passenger should not store any items under the seat or behind their feet. The items can interfere with proper airbag deployment in the event of a moderate to severe frontal collision and may result in inadequate protection.

■ Operation

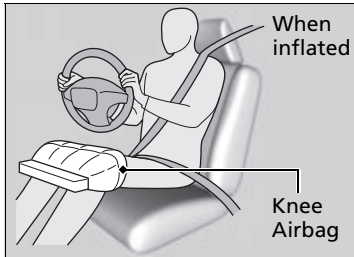

The driver's and front passenger's knee airbag deploy at the same time as the driver's and front passenger's airbag respectively.

Even if the collision is not severe enough to deploy the front airbags, the knee airbags may inflate alone.

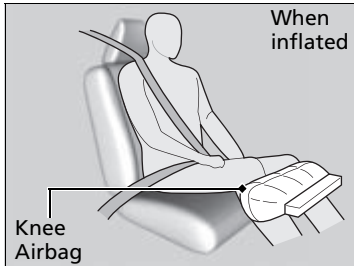

■ **When the knee airbags deploy with little or no visible damage**

Because the airbag system senses sudden deceleration, a strong impact to the vehicle framework or suspension might cause one or more of the airbags to deploy. Examples include running into a curb, the edge of a hole, or other low fixed object that causes a sudden deceleration in the vehicle chassis. Since the impact is underneath the vehicle, damage may not be readily apparent.

■ **When the knee airbags may not deploy, even though exterior damage appears severe**

Since crushable body parts absorb crash energy during an impact, the amount of visible damage does not always indicate proper airbag operation. In fact, some collisions can result in severe damage but no airbag deployment because the airbags would not have been needed or would not have provided protection even if they had deployed.

Side Airbags

The side airbags help protect the torso and pelvis of the driver or a front passenger during a moderate-to-severe side impact.

Housing Locations

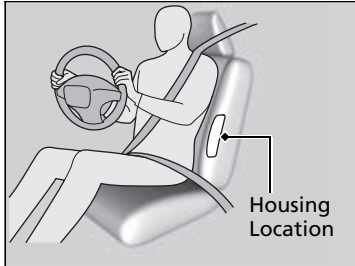

The side airbags are housed in the outside edge of the driver's and passenger's seat-backs.

Both are marked **SIDE AIRBAG**.

Operation

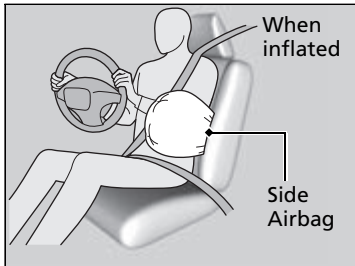

When the sensors detect a moderate-to-severe side impact, the control unit signals the side airbag on the impact side to immediately inflate.

Side Airbags

Make sure you and your front seat passenger always sit upright. Leaning into the path of a side airbag can prevent the airbag from deploying properly and increases your risk of serious injury.

Do not attach accessories on or near the side airbags. They can interfere with the proper operation of the airbags, or hurt someone if an airbag inflates.

Do not cover or replace the front seat-back covers without consulting a dealer. Improperly replacing or covering front seat-back covers can prevent your side airbags from properly deploying during a side impact.

■ **When a side airbag deploys with little or no visible damage**

Because the airbag system senses sudden acceleration, a strong impact to the side of the vehicle's framework can cause a side airbag to deploy. In such cases, there may be little or no damage, but the side impact sensors detected a severe enough impact to deploy the airbag.

■ **When a side airbag may not deploy, even though visible damage appears severe**

It is possible for a side airbag not to deploy during an impact that results in apparently severe damage. This can occur when the point of impact was toward the far front or rear of the vehicle, or when the vehicle's crushable body parts absorbed most of the crash energy. In either case, the side airbag would not have been needed nor provided protection even if it had deployed.

Side Curtain Airbags

The side curtain airbags help protect the heads of the driver and passengers in the outer seating positions during a moderate-to-severe side impact. The side curtain airbags equipped in this vehicle are also designed to help reduce the likelihood of partial and complete ejection of vehicle occupants through side windows in crashes, particularly rollover crashes.

■ Housing Locations

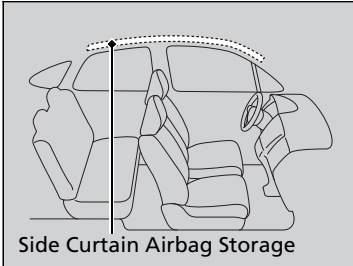

The side curtain airbags are located in the ceiling above the side windows on both sides of the vehicle.

■ Operation

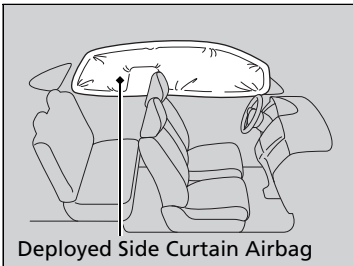

The side curtain airbag is designed to deploy in a rollover or a moderate-to-severe side impact.

▶ Side Curtain Airbags

To get the best protection from the side curtain airbags, occupants should wear their seat belts properly and sit upright and well back in their seats.

Do not attach any objects to the side windows or roof pillars as they can interfere with the proper operation of the side curtain airbags.

If the impact is on the passenger's side, the passenger's side curtain airbag deploys even if there are no occupants on that side of the vehicle.

If the SRS control unit senses that your vehicle is about to rollover, it immediately deploys both side curtain airbags and activates both front seat belt tensioners.

■ When side curtain airbags deploy in a frontal collision

One or both side curtain airbags may also inflate in a moderate-to-severe angled frontal collision.

Airbag System Indicators

If a problem occurs in the airbag system, the SRS indicator will come on and a message appears on the driver information interface.

■ Supplemental Restraint System (SRS) Indicator



■ When the power mode is set to ON

The indicator comes on for a few seconds, then goes off. This tells you the system is working properly.

If the indicator comes on at any other time, or does not come on at all, have the system checked by a dealer as soon as possible. If you don't, your airbags and seat belt tensioners may not work properly when they are needed.

▶▶ Supplemental Restraint System (SRS) Indicator

⚠ WARNING

Ignoring the SRS indicator can result in serious injury or death if the airbag systems or tensioners do not work properly.

Have your vehicle checked by a dealer as soon as possible if the SRS indicator alerts you to a possible problem.

Passenger Airbag Off Indicator

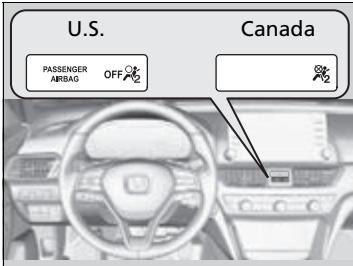

When the passenger airbag off indicator comes on

The indicator comes on to alert you that the passenger's airbag has been turned off. This occurs if the seat is empty or when the weight sensors determine that a small child or infant is on the passenger seat.

Children age 12 or under should always ride properly restrained in a back seat.

➤ **Child Safety** P. 64

If the indicator is on in the event of a crash, the passenger's airbag will not deploy. The passenger's knee airbag will not deploy, either.

Passenger Airbag Off Indicator

To ensure the passenger is detected properly, confirm that:

- The occupant is sitting in an upright position, wearing the seat belt properly and the seat-back is not excessively reclined.
- The occupant is not leaning against the door or center console.
- The occupant's feet are placed on the floor in front of them.
- There are no objects hanging from the front passenger's seat.
- Only small, lightweight objects are in the seat-back pocket.
- No liquid has been spilled on or under the seat.
- There is no child seat or other object pressing against the rear of the seat or seat-back.
- There is no rear passenger pushing or pulling on the back of the front passenger's seat.
- There are no objects placed under or beside the front passenger's seat. Improperly positioned objects can interfere with the advanced airbag sensors.
- The floor mat behind the front passenger's seat is set in the correct position evenly on the floor. An improperly placed mat can interfere with the advanced airbag sensors.
- The head restraint is not contacting the roof.

▶▶ Passenger Airbag Off Indicator

The passenger airbag off indicator may come on and go off periodically if the total weight on the seat is near the airbag cutoff threshold. For a small adult, depending on physique and posture, the system may not recognize him/her as an adult and thus deactivate the passenger's airbag.

If this occurs, please confirm that the conditions set forth in the above bullet points on the previous page are met.

If the above conditions are met and the indicator is still on, then with the transmission in **[P]**, set the power mode to OFF and back to ON.

Have your vehicle checked by a dealer as soon as possible if:

- All of the above conditions are met, and the indicator comes on with an adult seated in the front passenger seat.
- The seat is empty and the indicator is off.

Do not allow an adult passenger to ride in the front seat when the indicator is on.

Airbag Care

You do not need to, and should not, perform any maintenance on or replace any airbag system components yourself. However, you should have your vehicle inspected by a dealer in the following situations:

■ When the airbags have deployed

If an airbag has inflated, the control unit and other related parts must be replaced. Similarly, once an automatic seat belt tensioner has been activated, it must be replaced.

■ When the vehicle has been in a moderate-to-severe collision

Even if the airbags did not inflate, have your dealer inspect the following: the driver's seat position sensor, weight sensors in the passenger's seat, front seat belt tensioners, and each seat belt that was worn during the crash.

■ Do not remove or modify a front seat without consulting a dealer

This would likely disable or affect the proper operation of the driver's seat position sensor or the weight sensors in the passenger's seat. If it is necessary to remove or modify a front seat to accommodate a person with disabilities, contact a Honda dealer, or for U.S. vehicles, American Honda Automobile Customer Service at 1-800-999-1009 and for Canadian vehicles, Honda Canada Customer Relations at 1-888-9-HONDA-9.

✘ Airbag Care

We recommend against the use of salvaged airbag system components, including the airbag, tensioners, sensors, and control unit.

Protecting Child Passengers

Each year, many children are injured or killed in vehicle crashes because they are either unrestrained or not properly restrained. In fact, vehicle crashes are the number one cause of death of children ages 12 and under.

To reduce the number of child deaths and injuries, every state, Canadian province and territory requires that infants and children be properly restrained when they ride in a vehicle.

Children should sit properly restrained in a rear seat. This is because:

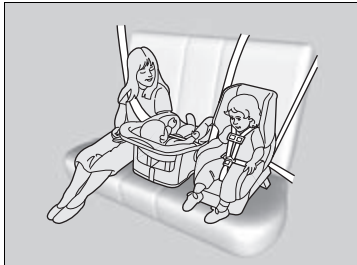

- An inflating front or side airbag can injure or kill a child sitting in the front seat.
- A child in the front seat is more likely to interfere with the driver's ability to safely control the vehicle.
- Statistics show that children of all sizes and ages are safer when they are properly restrained in a rear seat.

Protecting Child Passengers

WARNING

Children who are unrestrained or improperly restrained can be seriously injured or killed in a crash.

Any child too small for a seat belt should be properly restrained in a child seat. A larger child should be properly restrained with a seat belt, using a booster seat if necessary.

The National Highway Traffic Safety Administration and Transport Canada recommend that all children ages 12 and under be properly restrained in a rear seat. Some states or provinces/territories have laws restricting where children may ride.

- Any child who is too small to wear a seat belt correctly must be restrained in an approved child seat that is properly secured to the vehicle using either the seat belt or the lower anchors of the LATCH system.
- Never hold a child on your lap because it is impossible to protect them in the event of a collision.
- Never put a seat belt over yourself and a child. During a crash, the belt would likely press deep into the child and cause serious or fatal injuries.
- Never let two children use the same seat belt. Both children could be very seriously injured in a crash.
- Do not allow children to operate the doors, windows, or seat adjustments.
- Do not leave children in the vehicle unattended, especially in hot weather when the inside of the vehicle can get hot enough to kill them. They could also activate vehicle controls causing it to move unexpectedly.

▶▶ Protecting Child Passengers

⚠ WARNING

Allowing a child to play with a seat belt or wrap one around their neck can result in serious injury or death.

Instruct children not to play with any seat belt and make sure any unused seat belt a child can reach is buckled, fully retracted, and locked.

To deactivate a lockable retractor, release the buckle and allow the seat belt to wind up all the way.

To remind you of the passenger's front airbag hazards and child safety, your vehicle has warning labels on the dashboard (U.S. models) and on the front visors. Please read and follow the instructions on these labels.

▶▶ **Safety Labels** P. 79

Safety of Infants and Small Children

■ Protecting Infants

An infant must be properly restrained in a rear-facing child seat until the infant reaches the seat manufacturer's weight or height limit for the seat.

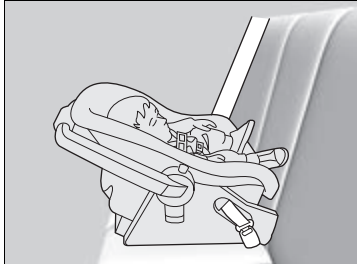

■ Positioning a rear-facing child seat

Child seats must be placed and secured in a rear seating position.

When properly installed, a rear-facing child seat may prevent the driver or a front passenger from moving their seat all the way back, or from locking their seat-back in the desired position. Make sure that there is no contact between the child seat and the seat in front of it.

It can also interfere with proper operation of the passenger's advanced front airbag system.

▶ **Airbags** P. 46

If this occurs, we recommend that you install the child seat directly behind the front passenger's seat, move the seat as far forward as needed, and leave it unoccupied. Or, you may wish to get a smaller rear-facing child seat.

▶▶ Protecting Infants

⚠ WARNING

Placing a rear-facing child seat in the front seat can result in serious injury or death during a crash.

Always place a rear-facing child seat in the rear seat, not the front.

Experts recommend use of a rear-facing seat for a child so long as the child's height and weight are appropriate for a rear-facing seat.

Infants should never be seated in a forward-facing position.

Always refer to the child seat manufacturer's instructions before installation.

Do not allow a front seat to rest against a child seat installed in a rear seating position. The weight sensor in the front seat may not correctly detect the actual weight of the occupant.

■ Protecting Smaller Children

If a child has exceeded the weight and height limitations of a rearward-facing child seat, the child should be properly restrained in a firmly secured forward-facing child seat until they exceed the weight and height limitations for the forward-facing child seat.

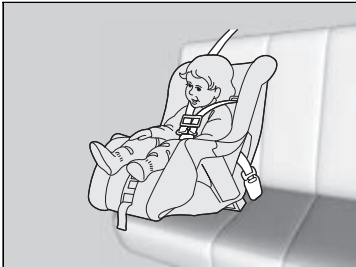

■ Forward-facing child seat placement

We strongly recommend placing a forward-facing child seat in a rear seating position.

Placing a forward-facing child seat in the front seat can be hazardous, even with advanced front airbags that automatically turn the passenger's front airbag off. A rear seat is the safest place for a child.

⊠ Protecting Smaller Children

⚠ WARNING

Placing a forward-facing child seat in the front seat can result in serious injury or death if the front airbag inflates.

If you must place a forward-facing child seat in front, move the vehicle seat as far back as possible, and properly restrain the child.

Educate yourself about the laws and regulations regarding child seat use where you are driving, and follow the child seat manufacturer's instructions.

■ Selecting a Child Seat

Most child seats are LATCH-compatible (Lower Anchors and Tethers for Children). Some have a rigid-type connector, while others have a flexible-type connector. Both are equally easy to use. Some existing and previously owned child seats can only be installed using the seat belt. Whichever type you choose, follow the child seat manufacturer's use and care instructions including recommended expiration dates as well as the instructions in this manual. Proper installation is key to maximizing your child's safety.

In seating positions and vehicles not equipped with LATCH, a LATCH-compatible child seat can be installed using the seat belt and a top tether for added security. This is because all child seats are required to be designed so that they can be secured with a lap belt or the lap part of a lap/shoulder belt. In addition, the child seat manufacturer may advise that a seat belt be used to attach a LATCH-compatible seat once a child reaches a specified weight. Please read the child seat owner's manual for proper installation instructions.

■ Important consideration when selecting a child seat

Make sure the child seat meets the following three requirements:

- The child seat is the correct type and size for the child.
- The child seat is the correct type for the seating position.
- The child seat is compliant with Federal Motor Vehicle Safety Standard 213 or Canadian Motor Vehicle Safety Standard 213.

▶▶ Selecting a Child Seat

Installation of a LATCH-compatible child seat is simple.

LATCH-compatible child seats have been developed to simplify the installation process and reduce the likelihood of injuries caused by incorrect installation.

■ Installing a LATCH-Compatible Child Seat

A LATCH-compatible child seat can be installed in either of the two outer rear seats. A child seat is attached to the lower anchors with either the rigid or flexible type of connectors.

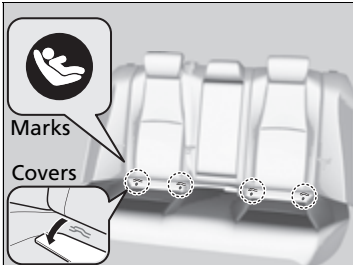

1. Locate the anchor marks affixed to the base of the seat cushion.
2. Pull out the anchor covers under the marks to expose the lower anchors.

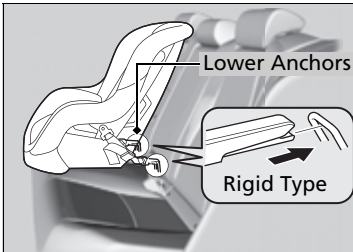

3. Place the child seat on the vehicle seat, then attach the child seat to the lower anchors according to the instructions that came with the child seat.

▶ When installing the child seat, make sure that the lower anchors are not obstructed by the seat belt or any other object.

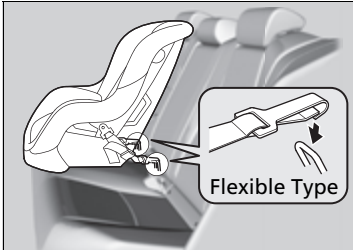

▣ Installing a LATCH-Compatible Child Seat

⚠ WARNING

Never attach two child seats to the same anchor. In a collision, one anchor may not be strong enough to hold two child seat attachments and may break, causing serious injury or death.

For your child's safety, when using a child seat installed using the LATCH system, make sure that the child seat is properly secured to the vehicle. A child seat that is not properly secured will not adequately protect a child in a crash and may cause injury to the child or other vehicle occupants.

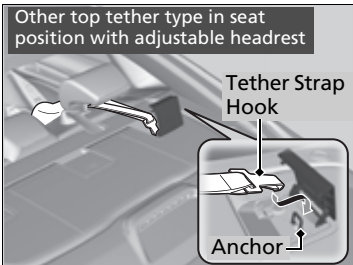
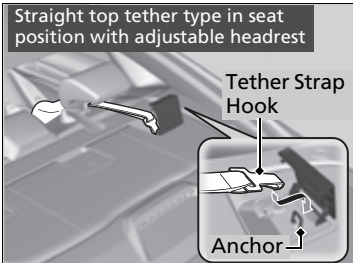

4. Open the tether anchor cover behind the head restraint.

Seat position with adjustable headrest

5. Put the head restraint to its upper-most position, then route the tether strap between the head restraint legs, and secure the tether strap hook to the anchor.

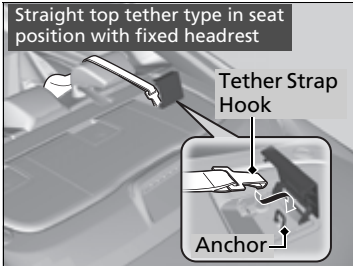

Straight top tether type in seat position with fixed headrest

5. Route the tether strap over the top of the head restraint and secure the tether strap hook to the anchor.

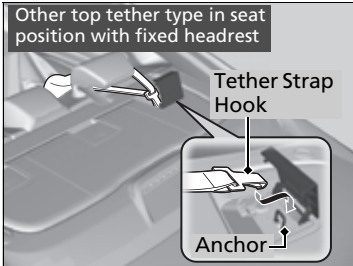

Other top tether type in seat position with fixed headrest

5. Route the tether strap over the side of the head restraint and secure the tether strap hook to the anchor.

All models

6. Tighten the tether strap as instructed by the child seat manufacturer.
7. Make sure the child seat is firmly secured by rocking it forward and back and side to side; little movement should be felt.
8. Make sure any unused seat belt that a child can reach is buckled, the lockable retractor is activated, and the belt is fully retracted and locked.

► Installing a LATCH-Compatible Child Seat

⚠ WARNING

Using the outer rear seats' inner anchors to secure a LATCH-compatible child seat in the center seating position may result in failure of the child seat, causing injury or death.

Only use the outer rear seats' inner anchors to install a child seat in the center seating position if the manufacturer's instructions expressly permit.

Installing a LATCH-compatible child seat in the rear center seat

Each outer rear seat is equipped with a pair of lower anchors which are used to secure a LATCH-compatible child seat. The rear center seat, however, is not equipped with anchors of any kind. The inner and outer anchors are spaced apart at a standard distance of 11 inches (280 mm). The distance between the two inner anchors is 15.4 inches (390 mm).

LATCH-compatible restraint systems that are fitted with rigid-type attachments cannot be installed in the rear center seat. However, a system fitted with flexible-type attachments can be installed in the center seat, provided that the manufacturer's instructions for that system permit the use of the inner anchors with the stated spacing.

Before seating a child, make sure that the system is properly attached to both the lower anchors and tether anchors.

■ Installing a Child Seat with a Lap/Shoulder Seat Belt

A child seat can be installed with a lap/shoulder belt in any rear seat or, if absolutely necessary, the front passenger seat.

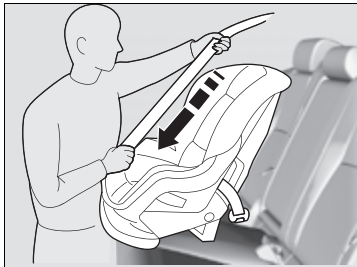

1. Place the child seat on the vehicle seat.
2. Route the seat belt through the child seat according to the seat manufacturer's instructions, and insert the latch plate into the buckle.
 - Insert the latch plate fully until it clicks.
3. Slowly pull the shoulder part of the belt all the way out until it stops. This activates the lockable retractor.
4. Let the seat belt retract a few inches and check that the retractor has switched modes by pulling on the webbing. It should not pull out again until it is reset by removing the latch plate from the buckle.
 - If you are able to pull the shoulder belt out, the lockable retractor is not activated. Slowly pull the seat belt all the way out, and repeat steps 3 – 4.

▣ Installing a Child Seat with a Lap/Shoulder Seat Belt

A child seat that is not properly secured will not adequately protect a child in a crash and may cause injury to the child or other vehicle occupants.



5. Grab the shoulder part of the seat belt near the buckle, and pull up to remove any slack from the lap part of the belt.

▶ When doing this, place your weight on the child seat and push it into the vehicle seat.

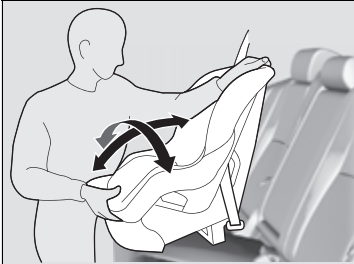

6. Make sure the child seat is firmly secured by rocking it forward and back and side to side; less than one inch of movement should occur near the seat belt.

7. Make sure any unused seat belt that a child can reach is buckled, the lockable retractor is activated, and the belt is fully retracted and locked.

✕ Installing a Child Seat with a Lap/Shoulder Seat Belt

To deactivate a lockable retractor, release the buckle and allow the seat belt to wind up all the way.

■ Adding Security with a Tether

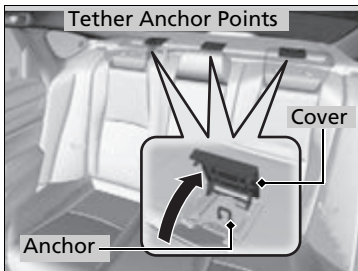

A tether anchor point is provided behind each rear seating position. If you have a child seat that comes with a tether but can be installed with a seat belt, the tether may be used for additional security.

1. Locate the appropriate tether anchor point and lift the cover.

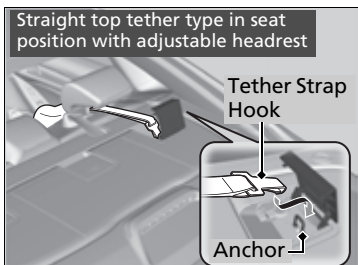

Seat position with adjustable headrest

2. Pull up the head restraint to its upper-most position, then route the tether strap between the head restraint legs. Make sure the strap is not twisted.

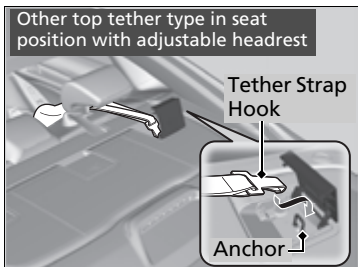

▶▶ Adding Security with a Tether

Always use a tether for forward-facing child seats whether using the seat belt or lower anchors.

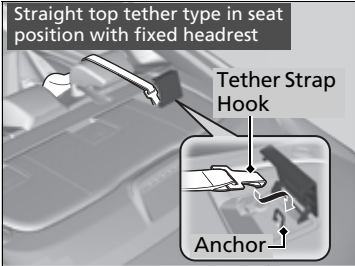

Straight top tether type in seat position with fixed headrest

2. Route the tether strap over the top of the head restraint. Make sure the strap is not twisted.

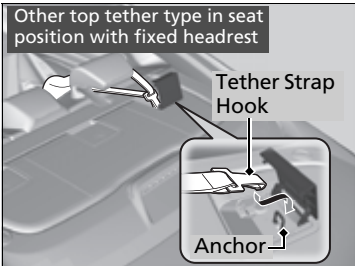

Other top tether type in seat position with fixed headrest

2. Route the tether strap over the side of the head restraint. Make sure the strap is not twisted.

All models

3. Secure the tether strap hook to the anchor.
4. Tighten the tether strap as instructed by the child seat manufacturer.

Safety of Larger Children

■ Protecting Larger Children

The following pages give instructions on how to check proper seat belt fit, what kind of booster seat to use if one is needed, and important precautions for a child who must sit in front.

■ Checking Seat Belt Fit

When a child is too big for a child seat, secure the child in a rear seat using the lap/shoulder seat belt. Have the child sit upright and all the way back, then answer the following questions.



■ Checklist

- Do the child's knees bend comfortably over the edge of the seat?
- Does the shoulder belt cross between the child's neck and arm?
- Is the lap part of the seat belt as low as possible, touching the child's thighs?
- Will the child be able to stay seated like this for the whole trip?

If you answer yes to all these questions, the child is ready to wear the lap/shoulder seat belt correctly. If you answer no to any question, the child needs to ride on a booster seat until the seat belt fits properly without a booster seat.

▶ Safety of Larger Children

⚠ WARNING

Allowing a child age 12 or under to sit in front can result in injury or death if the passenger's front airbag inflates.

If a larger child must ride in front, move the vehicle seat as far to the rear as possible, have the child sit up properly and wear the seat belt properly, using a booster seat if needed.

Booster Seats



If a lap/shoulder seat belt cannot be used properly, position the child in a booster seat in the rear seat. For the child's safety, check that the child meets the booster seat manufacturer's recommendations.

Protecting Larger Children - Final Checks

Your vehicle has a rear seat where children can be properly restrained. If you ever have to carry a group of children, and a child must ride in front:

- Make sure you read and fully understand the instructions and safety information in this manual.
- Move the front passenger seat as far back as possible.
- Have the child sit upright and well back in the seat.
- Check that the seat belt is properly positioned so that the child is secure in the seat.

Monitoring child passengers

We strongly recommend that you keep an eye on child passengers. Even older, more mature children sometimes need to be reminded to fasten their seat belts and sit up properly.

Booster Seats

When installing a booster seat, make sure to read the instructions that came with it, and install the seat accordingly.

There are high- and low-type booster seats. Choose a booster seat that allows the child to wear the seat belt correctly.

Some U.S. states and Canadian provinces and territories require children to use a booster seat until they reach a given age or weight (e.g. 6 years or 60 lbs). Be sure to check current laws in the state or province, or territory where you intend to drive.

Carbon Monoxide Gas

The engine exhaust from this vehicle contains carbon monoxide, a colorless, odorless, and highly toxic gas. As long as you properly maintain your vehicle, carbon monoxide gas will not get into the interior.

■ Have the exhaust system inspected for leaks whenever

- The exhaust system is making an unusual noise.
- The exhaust system may have been damaged.
- The vehicle is raised for an oil change.

When you operate a vehicle with the trunk open, airflow can pull exhaust gas into the interior and create a hazardous condition. If you must drive with the trunk open, open all the windows and set the climate control system as shown below.

1. Select the fresh air mode.
2. Select the  mode.
3. Set the fan speed to high.
4. Set the temperature control to a comfortable setting.

Adjust the climate control system in the same manner if you sit in your parked vehicle with the engine running.

Carbon Monoxide Gas

WARNING

Carbon monoxide gas is toxic.

Breathing it can cause unconsciousness and even kill you.

Avoid any enclosed areas or activities that expose you to carbon monoxide.

An enclosed area such as a garage can quickly fill up with carbon monoxide gas. Do not run the engine with the garage door closed. Even when the garage door is open, drive out of the garage immediately after starting the engine.

Label Locations

These labels are in the locations shown. They warn you of potential hazards that can cause serious injury or death. Read these labels carefully.

If a label comes off or becomes hard to read (except for the U.S. dashboard label which may be removed by the owner), contact a dealer for a replacement.

Sun Visor

U.S. models

⚠ WARNING

EVEN WITH ADVANCED AIR BAGS



- Children can be killed or seriously injured by the air bag.
- The back seat is the safest place for children.
- Never put a rear-facing child seat in the front.
- Always use seat belts and child restraints.
- See owner's manual for more information about air bags.

Canadian models

⚠ WARNING	⚠ ATTENTION
<p>To avoid serious injury</p> <ul style="list-style-type: none"> ■ For maximum safety protection in all types of crashes, you must always wear your safety belt. ■ Do not install rearward-facing child seats in any front passenger seat position. ■ Do not sit or lean unnecessarily close to the air bag. ■ Do not place any objects over the air bag or between the air bag and yourself. ■ See the owner's manual for further information and explanations. 	<p>Pour éviter des blessures graves</p> <ul style="list-style-type: none"> ■ Pour profiter d'une protection maximale lors d'une collision boucliez toujours votre ceinture de sécurité. ■ N'installez jamais un siège pour enfants faisant face à l'arrière sur le siège du passager avant. ■ Ne vous appuyez pas et ne vous assoyez pas près du coussin gonflable. ■ Ne déposez aucun objet sur le coussin gonflable ou entre le coussin gonflable et vous. ■ Lisez le guide utilisateur pour de plus amples renseignements.

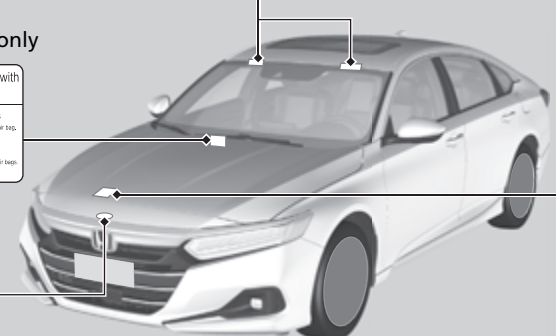

Dashboard

U.S. models only

This Vehicle is Equipped with Advanced Air Bags

Even with Advanced Air Bags

Children can be killed or seriously injured by the air bag. The back seat is the safest place for children. Never put a rear-facing child seat in the front. Always use seat belts and child restraints. See owner's manual for more information about air bags.

(See instruction book only.)

⚠ DANGER
⚠ 危險

NEVER OPEN WHEN HOT.
NEI COGNIBILI CALDI APRIRE.
NEVER OPEN WHEN UNDER HIGH PRESSURE.
NEI CONDIZIONI DI ALTA PRESSIONE APRIRE.
NEVER OPEN WHEN HOT. NEVER OPEN WHEN UNDER HIGH PRESSURE. NEVER OPEN WHEN UNDER HIGH PRESSURE. NEVER OPEN WHEN UNDER HIGH PRESSURE.

108kPa

Air Conditioner System

U.S. models

⚠ WARNING

Flammable Refrigerant
 CAUTION SYSTEM CONTAINS REFRIGERANT R-1234yf UNDER HIGH PRESSURE.
 TO BE SERVICED ONLY BY QUALIFIED PERSONNEL.
 Follow Instructions in the service manual.

AIR CONDITIONER SYSTEM
 REFRIGERANT : R-1234yf (SAE J639 J2842 J2845)
 REC. CHARGE : MAX 0.445kg MIN 0.395kg
 OIL TYPE : ND-OIL 14 (POE)

TVA Honda Motor Co., Ltd.

Canadian models



R-1234yf

Radiator Cap

This page intentionally left blank.

Instrument Panel





































This chapter describes the buttons, indicators, and gauges that are used while driving.







Indicators	82
Driver Information Interface Warning and Information Messages.....	109
Gauges and Displays	
Gauges.....	139
Driver Information Interface	140
Head-Up Display*	159

* Not available on all models



Indicators



	U.S. Canada	Brake System Parking Brake and Brake System Indicator (Red)	→ P. 83
	U.S. Canada	Brake System Parking Brake and Brake System Indicator (Amber)	→ P. 84
	Brake Hold	Automatic Brake Hold System Indicator	→ P. 86
	U.S. Canada	Automatic Brake Hold Indicator	→ P. 86
		Malfunction Indicator Lamp	→ P. 87
		Charging System Indicator	→ P. 88
		Shift Position Indicator	→ P. 88
		M (sequential mode*/7-speed manual shift mode*) Indicator*/Gear Selection Indicator*	→ P. 88
		Transmission System Indicator	→ P. 89, 91
		Seat Belt Reminder Indicator	→ P. 92
		Low Fuel Indicator	→ P. 93
	ABS	Anti-lock Brake System (ABS) Indicator	→ P. 93
		Supplemental Restraint System Indicator	→ P. 93
		Auto High-Beam Indicator	→ P. 94
		Vehicle Stability Assist™ (VSA®) System Indicator	→ P. 94
		Vehicle Stability Assist™ (VSA®) OFF Indicator	→ P. 95
		Electric Power Steering (EPS) System Indicator	→ P. 95
		Low Tire Pressure/TPMS Indicator	→ P. 96
		Turn Signal and Hazard Warning Indicators	→ P. 97
		High Beam Indicator	→ P. 97
		Lights On Indicator	→ P. 97
		Fog Light Indicator*	→ P. 97
		System Message Indicator	→ P. 99
		ECON Mode Indicator	→ P. 100
	SPORT	SPORT Mode Indicator*	→ P. 101
		Cruise Mode Indicator (White/Green)	→ P. 104
		Immobilizer System Indicator	→ P. 98
		Security System Alarm Indicator	→ P. 99
		Auto Idle Stop Indicator (Green)*	→ P. 102
		Auto Idle Stop System Indicator (Amber)*	→ P. 102
		Adaptive Cruise Control (ACC) with Low Speed Follow Indicator (Amber)	→ P. 103
		Adaptive Cruise Control (ACC) with Low Speed Follow Indicator (White/Green)	→ P. 104
		Lane Keeping Assist System (LKAS) Indicator (Amber)	→ P. 104
		Lane Keeping Assist System (LKAS) Indicator (White/Green)	→ P. 104
		Safety Support Indicator (Amber)	→ P. 105
		Safety Support Indicator (Green/Gray)	→ P. 108

*1 : When you set the power mode to ON, these indicators come on to indicate that system checks are being performed. They go off a few seconds later or after the engine has started. If an indicator does not come on or turn off, there may be a malfunction in the corresponding system. To resolve the issue, follow the instructions in the owner's manual.



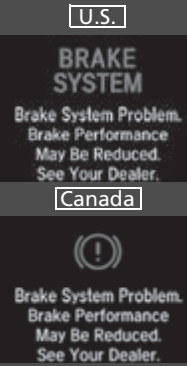

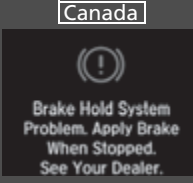
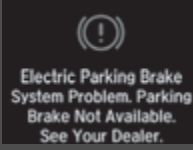

Indicator	Name	On/Blinking	Explanation	Message
<p>U.S. BRAKE</p> <p>Canada</p>  <p>(Red)</p>	<p>Parking Brake and Brake System Indicator (Red)</p>	<ul style="list-style-type: none"> • Comes on when the parking brake is applied, and goes off when it is released. • Comes on when the brake fluid level is low. • Comes on if there is a problem with the brake system. • The beeper sounds and the indicator comes on if you drive with the parking brake applied. • Comes on for about 30 seconds when you apply the electric parking brake while the power mode is in ACCESSORY or VEHICLE OFF, then goes off. • Stays on for about 30 seconds when you set the power mode to VEHICLE OFF while the electric parking brake is applied, then goes off. 	<ul style="list-style-type: none"> • Comes on while driving - Make sure the parking brake is released. Check the brake fluid level. <ul style="list-style-type: none"> ➤ What to do when the indicator comes on while driving P. 615 • Comes on along with the Parking Brake and Brake System Indicator (amber) - Immediately stop in a safe place. Contact a dealer for repair. The brake pedal becomes harder to operate. Depress the pedal further than you normally do. <ul style="list-style-type: none"> ➤ If the Brake System Indicator (Red) Comes On or Blinks at the Same Time When the Brake System Indicator (Amber) Comes On P. 616 • Comes on along with the ABS indicator - Have your vehicle checked by a dealer. <ul style="list-style-type: none"> ➤ If the Brake System Indicator (Red) Comes On or Blinks P. 615 • Blinks and the Parking Brake and Brake System Indicator (amber) comes on at the same time - There is a problem with the electric parking brake system. The parking brake may not be set. Avoid using the parking brake and have your vehicle checked by a dealer immediately. <ul style="list-style-type: none"> ➤ If the Brake System Indicator (Red) Comes On or Blinks at the Same Time When the Brake System Indicator (Amber) Comes On P. 616 	 <p>Release Parking Brake</p>  <p>Brake Fluid Low. Do Not Drive. Check Fluid Level.</p>  <p>Brake System Problem. Brake Performance May Be Reduced. See Your Dealer.</p>





Instrument Panel



Indicator	Name	On/Blinking	Explanation	Message
 	Parking Brake and Brake System Indicator (Amber)	<ul style="list-style-type: none"> Comes on if there is a problem with a system related to braking other than the conventional brake system. 	<ul style="list-style-type: none"> Comes on while driving - Avoid high speeds and sudden braking. Take the vehicle to a dealer immediately. 	

Indicator	Name	On/Blinking	Explanation	Message
<div style="text-align: center;">  <p>(Amber)</p> </div>	<p>Parking Brake and Brake System Indicator (Amber)</p>	<ul style="list-style-type: none"> Comes on if there is a problem with the electric parking brake system and/or the automatic brake hold system. 	<ul style="list-style-type: none"> Stays on constantly - Avoid using the parking brake and have your vehicle checked by a dealer immediately. 	<div style="text-align: center;">     </div>

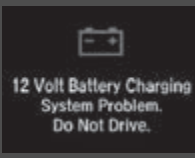

Instrument Panel

Indicator	Name	On/Blinking	Explanation	Message
 	Parking Brake and Brake System Indicator (Amber)	<ul style="list-style-type: none"> Comes on if there is a problem with the radar sensor. Indicator may come on temporarily when the Maximum Load Limit is exceeded. 	<ul style="list-style-type: none"> Make sure the total load is within the Maximum Load Limit. <ul style="list-style-type: none"> ➤ Maximum Load Limit P. 405 Stays on constantly - Have your vehicle checked by a dealer. 	—
	Automatic Brake Hold System Indicator	<ul style="list-style-type: none"> Comes on when the automatic brake hold system is on. 	<ul style="list-style-type: none"> ➤ Automatic Brake Hold P. 513 	
 	Automatic Brake Hold Indicator	<ul style="list-style-type: none"> Comes on when the automatic brake hold is activated. 	<ul style="list-style-type: none"> ➤ Automatic Brake Hold P. 513 	—

Indicator	Name	On/Blinking	Explanation	Message
	Malfunction Indicator Lamp	<ul style="list-style-type: none"> • After you have set the power mode to ON, the vehicle performs system checks. However, if the readiness codes have not been set by that time, this indicator will blink five times and then go off. 	<ul style="list-style-type: none"> • Readiness codes are part of the on-board diagnostics for the emissions control systems. <ul style="list-style-type: none"> ▶ Testing of Readiness Codes P. 639 	
		<ul style="list-style-type: none"> • Comes on if there is a problem with the emissions control systems. • Blinks when a misfire in the engine's cylinders is detected. 	<ul style="list-style-type: none"> ▶ If the Malfunction Indicator Lamp Comes On or Blinks P. 614 	<div data-bbox="1289 430 1495 580">  </div> <div data-bbox="1289 586 1495 748">  </div>

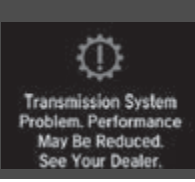
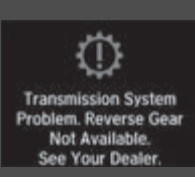
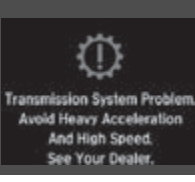

Indicator	Name	On/Blinking	Explanation	Message
	Charging System Indicator	<ul style="list-style-type: none"> Comes on when there is a problem with the charging system. 	<ul style="list-style-type: none"> Stop in a safe place and contact a dealer immediately. <ul style="list-style-type: none"> ➤ Checking the Battery P. 584 ➤ If the Charging System Indicator Comes On P. 613 	
	Shift Position Indicator	<ul style="list-style-type: none"> Indicates the current shift position. 	<ul style="list-style-type: none"> ➤ Shifting P. 420, 427, 429 	—
	M (sequential mode*/7-speed manual shift mode*) Indicator*/ Gear Selection Indicator*	<ul style="list-style-type: none"> Comes on when the sequential mode*/7-speed manual shift mode* is applied. 	<ul style="list-style-type: none"> ➤ Sequential Mode P. 425 ➤ 7-Speed Manual Shift Mode P. 431 	—

Automatic transmission models



Indicator	Name	On/Blinking	Explanation	Message
	Transmission System Indicator	<ul style="list-style-type: none"> The current shift position blinks if the transmission system has a problem. 	<ul style="list-style-type: none"> Blinks while driving - Avoid sudden starts and acceleration and have your vehicle checked by a dealer immediately. 	
		<ul style="list-style-type: none"> The indicated current shift position blinks if you cannot put the transmission into R due to a transmission system failure. 	<ul style="list-style-type: none"> Avoid sudden starts, sudden acceleration and high speed, and have your vehicle checked by a dealer immediately. 	
		<ul style="list-style-type: none"> The indicated current shift position blinks if the transmission system has a problem and the performance of the vehicle is reduced. 	<ul style="list-style-type: none"> Avoid sudden starts, sudden acceleration and high speed, and have your vehicle checked by a dealer immediately. 	
		<ul style="list-style-type: none"> The indicated current shift position blinks if the transmission system has a problem and the paddle shifters cannot be used. 	<ul style="list-style-type: none"> Have your vehicle checked by a dealer immediately. 	



Instrument Panel



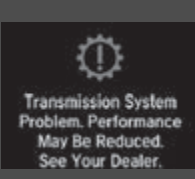
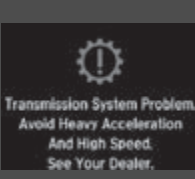

Automatic transmission models





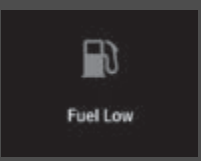

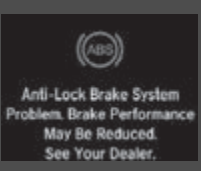
Indicator	Name	On/Blinking	Explanation	Message
	Transmission System Indicator	<ul style="list-style-type: none"> The current shift position or all the shift positions blink if there is a problem with the transmission and the vehicle is no longer able to run. 	<ul style="list-style-type: none"> Immediately park your car in a safe place. <ul style="list-style-type: none"> ➤ Emergency Towing P. 626 Have your vehicle checked by a dealer. 	 <p>Stop Driving When Safe. Transmission Problem. See Manual</p>
		<ul style="list-style-type: none"> The current shift position or all the shift positions blink if there is a problem with the transmission and it is not possible to select P. 	<ul style="list-style-type: none"> Depending on the circumstances, you can set the power mode to ON as an emergency measure. <ul style="list-style-type: none"> ➤ If the Transmission System Indicator Blinks along with the Warning Message P. 619 While the vehicle is stopped, apply the parking brake. Have your vehicle checked by a dealer immediately. 	 <p>Transmission System Problem. Apply Parking Brake When Parked. See Your Dealer.</p>

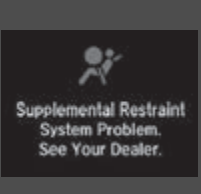



Continuously variable transmission models





Indicator	Name	On/Blinking	Explanation	Message
	Transmission System Indicator	<ul style="list-style-type: none"> Blinks if the transmission system has a problem. 	<ul style="list-style-type: none"> Blinks while driving - Avoid sudden starts and acceleration and have your vehicle checked by a dealer immediately. 	
		<ul style="list-style-type: none"> Blinks if the transmission system has a problem and the performance of the vehicle is reduced. 	<ul style="list-style-type: none"> Avoid sudden starts, sudden acceleration and high speed, and have your vehicle checked by a dealer immediately. 	
		<p>Models with paddle shifters</p> <ul style="list-style-type: none"> Blinks if the transmission system has a problem and the paddle shifters cannot be used. 	<ul style="list-style-type: none"> Have your vehicle checked by a dealer immediately. 	







Indicator	Name	On/Blinking	Explanation	Message
	<p>Seat Belt Reminder Indicator</p>	<ul style="list-style-type: none"> • Blinks and the beeper sounds for a few seconds if you are not wearing a seat belt when you set the power mode to ON, then the indicator comes on. • If the front passenger is not wearing a seat belt, the indicator comes on a few seconds later. • Comes on for a while when the rear seat belt is unfastened while the power mode in ON. • Blinks while driving if you and/or any passenger has not fastened a seat belt. The beeper sounds and the indicator blinks at regular intervals. 	<ul style="list-style-type: none"> • The beeper stops and the indicator goes off when you and the passengers fasten their seat belts. • Stays on after you and/or the passengers have fastened the seat belt(s) - A detection error may have occurred in the sensor. Have your vehicle checked by a dealer. <ul style="list-style-type: none"> ➤ Seat Belt Reminder P. 39 	

Indicator	Name	On/Blinking	Explanation	Message
	Low Fuel Indicator	<ul style="list-style-type: none"> • Comes on when the fuel reserve is running low (approximately 2.2 U.S. gal./8.4 L left). • Blinks if there is a problem with the fuel gauge. 	<ul style="list-style-type: none"> • Comes on - Refuel your vehicle as soon as possible. • Blinks - Have your vehicle checked by a dealer. 	 
	Anti-lock Brake System (ABS) Indicator	<ul style="list-style-type: none"> • Comes on if there is a problem with the ABS. 	<ul style="list-style-type: none"> • Stays on constantly - Have your vehicle checked by a dealer. With this indicator on, your vehicle still has normal braking ability but no anti-lock function. ➤ Anti-lock Brake System (ABS) P. 516 	
	Supplemental Restraint System Indicator	<ul style="list-style-type: none"> • Comes on if a problem with any of the following is detected: <ul style="list-style-type: none"> - Supplemental restraint system - Knee airbag system - Side airbag system - Side curtain airbag system - Seat belt tensioner 	<ul style="list-style-type: none"> • Stays on constantly - Have your vehicle checked by a dealer. 	



Indicator	Name	On/Blinking	Explanation	Message
	Auto High-Beam Indicator	<ul style="list-style-type: none"> Comes on when all the operating conditions of the auto high-beam are met. 	<ul style="list-style-type: none">  Auto High-Beam P. 199 	—
	Vehicle Stability Assist™ (VSA®) System Indicator	<ul style="list-style-type: none"> Blinks when VSA® is active. Comes on if there is a problem with the brake assist system, VSA® system or hill start assist system. <ul style="list-style-type: none"> Comes on if the VSA® system is deactivated temporarily after the battery has been disconnected, then re-connected. 	<ul style="list-style-type: none"> Stays on constantly - Have your vehicle checked by a dealer. <ul style="list-style-type: none">  Vehicle Stability Assist™ (VSA®), aka Electronic Stability Control (ESC), System P. 441 Drive a short distance at more than 12 mph (20 km/h). The indicator should go off. If it does not, have your vehicle checked by a dealer. 	<div data-bbox="1299 351 1501 497">  <p>Vehicle Stability Assist System Problem. Reduced Traction And Handling. See Your Dealer.</p> </div> <div data-bbox="1299 508 1501 654">  <p>Hill Start Assist Problem. Vehicle May Roll Upon Brake Release. See Your Dealer.</p> </div> <div data-bbox="1299 665 1501 810">  <p>Systems Initializing... Continue Driving.</p> </div>

Indicator	Name	On/Blinking	Explanation	Message
	Vehicle Stability Assist™ (VSA®) OFF Indicator	<ul style="list-style-type: none"> Comes on when you partially disable VSA®. 	<p>➤ VSA® On and Off P. 442</p>	
		<ul style="list-style-type: none"> Comes on if the VSA® system is deactivated temporarily after the battery has been disconnected, then re-connected. 	<ul style="list-style-type: none"> Drive a short distance at more than 12 mph (20 km/h). The indicator should go off. If it does not, have your vehicle checked by a dealer. 	
	Electric Power Steering (EPS) System Indicator	<ul style="list-style-type: none"> Comes on if there is a problem with the EPS system. 	<ul style="list-style-type: none"> Stays on constantly - Have your vehicle checked by a dealer. ➤ If the Electric Power Steering (EPS) System Indicator Comes On P. 617 	

Indicator	Name	On/Blinking	Explanation	Message
	Low Tire Pressure/TPMS Indicator	<ul style="list-style-type: none"> • May come on briefly if the power mode is set to ON and the vehicle is not moved within 45 seconds, to indicate the calibration process is not yet complete. • Comes on and stays on when: <ul style="list-style-type: none"> - One or more tires' pressures are determined to be significantly low. - The system has not been calibrated. 	<ul style="list-style-type: none"> • Comes on while driving - Stop in a safe place, check tire pressures, and inflate the tire(s) if necessary. • Stays on after the tires are inflated to the recommended pressures - The system needs to be calibrated. <ul style="list-style-type: none"> ► TPMS Calibration P. 446 	 <p>Tire Pressures Low</p>
		<ul style="list-style-type: none"> • Blinks for about one minute, and then stays on if there is a problem with the TPMS, or when a compact spare tire is temporarily installed. 	<ul style="list-style-type: none"> • Blinks and remains on - Have your vehicle checked by a dealer. If the vehicle is fitted with a compact spare tire, get your regular tire repaired or replaced and put back on your vehicle as soon as you can. 	
		<ul style="list-style-type: none"> • Comes on if the TPMS is deactivated temporarily after the battery has been disconnected, then re-connected. 	<ul style="list-style-type: none"> • Drive a short distance at more than 12 mph (20 km/h). The indicator should go off. If it does not, have your vehicle checked by a dealer. 	 <p>Systems Initializing... Continue Driving.</p>



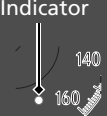

Indicator	Name	On/Blinking	Explanation	Message
	Turn Signal and Hazard Warning Indicators	<ul style="list-style-type: none"> • Blinks when you operate the turn signal lever. • Blink along with all turn signals when you press the hazard warning button. 	<ul style="list-style-type: none"> • Does not blink or blinks rapidly  Replacing Light Bulbs P. 566, 567 	—
	High Beam Indicator	<ul style="list-style-type: none"> • Comes on when the high beam headlights are on. 	—	—
	Lights On Indicator	<ul style="list-style-type: none"> • Comes on when the parking, tail, and other external lights are on. 	 Light Switches P. 195	—
	Fog Light Indicator*	<ul style="list-style-type: none"> • Comes on when the fog lights are on. 	 Fog Lights* P. 197	—



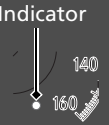

* Not available on all models

Indicator	Name	On/Blinking	Explanation	Message
	Immobilizer System Indicator	<ul style="list-style-type: none"> Blinks if the immobilizer system cannot recognize the key information. 	<ul style="list-style-type: none"> Blinks - You cannot start the engine. Set the power mode to VEHICLE OFF*¹, then select the ON mode again. Repeatedly blinks - The system may be malfunctioning. Have your vehicle checked by a dealer. Do not attempt to alter this system or add other devices to it. Electrical problems can occur. 	

*1:Canadian models only: Apply and hold the brake pedal before selecting the ON mode.





*2:Canadian models

Indicator	Name	On/Blinking	Explanation	Message
	Security System Alarm Indicator	<ul style="list-style-type: none"> Blinks when the security system alarm has been set. 	<p>  Security System Alarm P. 185 </p>	<p>—</p>
	System Message Indicator	<ul style="list-style-type: none"> Comes on along with a beep when a problem is detected. A system message on the driver information interface appears at the same time. 	<ul style="list-style-type: none"> While the indicator is on, press the  (home) button to see the message again. <ul style="list-style-type: none">  Accessing contents in the main display P. 140 Refer to the Indicators information in this chapter when a system message appears on the driver information interface. Respond to the message accordingly. The driver information interface does not return to the normal screen unless the warning is canceled, or the left selector wheel is pressed. 	<p>—</p>

Indicator	Name	On/Blinking	Explanation	Message
	<p>ECON Mode Indicator</p>	<ul style="list-style-type: none"> Comes on when the ECON mode is on. 	<p> ECON Mode P. 434</p>	<div style="text-align: right;">*1</div>  <div style="text-align: right;">*2</div> 





*1: Models without the adaptive damper system



*2: Models with the adaptive damper system

Indicator	Name	On/Blinking	Explanation	Message
	SPORT Mode Indicator*	<ul style="list-style-type: none"> Comes on when you press the SPORT button. 	<ul style="list-style-type: none"> The ambient meter remains lit up in red as long as SPORT mode is on.  SPORT Mode* P. 433 	<div style="text-align: right;">*1</div>  <div style="text-align: right;">*2</div> 





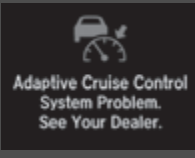
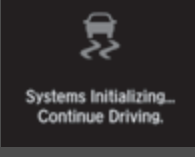



*1: Models without the adaptive damper system



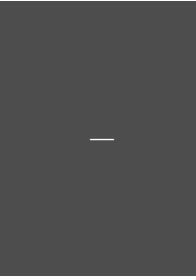

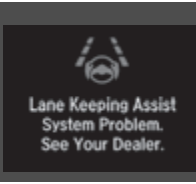

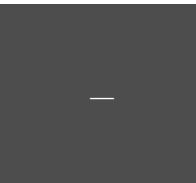
*2: Models with the adaptive damper system

Indicator	Name	On/Blinking	Explanation	Message
	Auto Idle Stop Indicator (Green)*	<ul style="list-style-type: none"> Comes on when Auto Idle Stop is in operation. The engine automatically shuts off. 	<ul style="list-style-type: none"> ➤ Auto Idle Stop* P. 435 	—
	Auto Idle Stop System Indicator (Amber)*	<ul style="list-style-type: none"> Comes on when the Auto Idle Stop system has been turned off by the Auto Idle Stop OFF button. 	<ul style="list-style-type: none"> ➤ Auto Idle Stop System ON/OFF P. 436 	 Auto Engine Idle Stop Disabled
		<ul style="list-style-type: none"> Blinks if there is a problem with the Auto Idle Stop system. 	<ul style="list-style-type: none"> • Blinks - Have your vehicle checked by a dealer. 	 Auto Idle-Stop System Problem. See Your Dealer.

Indicator	Name	On/Blinking	Explanation	Message
	Adaptive Cruise Control (ACC) with Low Speed Follow Indicator (Amber)	<ul style="list-style-type: none"> Comes on if there is a problem with ACC with Low Speed Follow. 	<ul style="list-style-type: none"> Comes on while driving - Have your vehicle checked by a dealer. 	
		<ul style="list-style-type: none"> Comes on if the ACC with Low Speed Follow is deactivated temporarily after the battery has been disconnected, then re-connected. 	<ul style="list-style-type: none"> Drive a short distance at more than 12 mph (20 km/h). The indicator should go off. If it does not, have your vehicle checked by a dealer. 	
		<ul style="list-style-type: none"> Indicator may come on temporarily when the Maximum Load Limit is exceeded. ACC with Low Speed Follow has been automatically canceled. 	<ul style="list-style-type: none"> Make sure the total load is within the Maximum Load Limit. ▶ Maximum Load Limit P. 405 Stays on constantly - Have your vehicle checked by a dealer. 	



Instrument Panel





Indicator	Name	On/Blinking	Explanation	Message
	Adaptive Cruise Control (ACC) with Low Speed Follow Indicator (White/Green)	<ul style="list-style-type: none"> Lights up in white when you press the  button. Lights up in green when you press the RES/+ button or SET/- button. 	<ul style="list-style-type: none"> ➤ Adaptive Cruise Control (ACC) with Low Speed Follow P. 470 	
	Lane Keeping Assist System (LKAS) Indicator (Amber)	<ul style="list-style-type: none"> Comes on if there is a problem with the LKAS. 	<ul style="list-style-type: none"> • Stays on constantly - Have your vehicle checked by a dealer. 	
	Lane Keeping Assist System (LKAS) Indicator (White/Green)	<ul style="list-style-type: none"> Lights up in white when you press the LKAS button. Lights up in green when the LKAS is in operation. 	<ul style="list-style-type: none"> ➤ Lane Keeping Assist System (LKAS) P. 486 	
	Cruise Mode Indicator (White/Green)	<ul style="list-style-type: none"> Lights up in white when you change to cruise mode. Lights up in green when you have set a speed for cruise control. 	<ul style="list-style-type: none"> ➤ To Switch ACC with Low Speed Follow to Cruise Control P. 484 	

Indicator	Name	On/Blinking	Explanation	Message
	Safety Support Indicator (Amber)	<ul style="list-style-type: none"> Comes on if there is a problem with RDM, Low Speed Braking Control*, CMBS™, or the blind spot information system*. 	<ul style="list-style-type: none"> Stays on constantly - Have your vehicle checked by a dealer. 	<div style="background-color: #333; color: white; padding: 5px; text-align: center;">  Road Departure Mitigation System Problem. See Your Dealer. </div> <div style="background-color: #333; color: white; padding: 5px; text-align: center;">  Low Speed Braking Control Problem. See Your Dealer. </div> <div style="background-color: #333; color: white; padding: 5px; text-align: center;">  Collision Mitigation Braking System Problem. See Your Dealer. </div> <div style="background-color: #333; color: white; padding: 5px; text-align: center;">  Blind Spot Information System Problem. See Your Dealer. </div>
		<ul style="list-style-type: none"> Comes on if the RDM, Low Speed Braking Control* and CMBS™ are deactivated temporarily after the battery has been disconnected and then re-connected. 	<ul style="list-style-type: none"> Drive a short distance at more than 12 mph (20 km/h). The indicator should go off. If it does not, have your vehicle checked by a dealer. 	<div style="background-color: #333; color: white; padding: 5px; text-align: center;">  Systems Initializing... Continue Driving. </div>

Instrument Panel



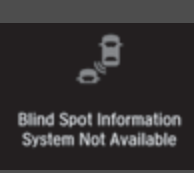

* Not available on all models

Indicator	Name	On/Blinking	Explanation	Message
	Safety Support Indicator (Amber)	<ul style="list-style-type: none"> Comes on when RDM, Low Speed Braking Control* and/or CMBS™ shuts itself off. 	<ul style="list-style-type: none"> Indicator may come on temporarily when passing through an enclosed space, such as a tunnel. The area around the radar sensor cover is blocked by dirt, mud, etc. Stop your vehicle in a safe place and wipe the debris off with a soft cloth. Indicator may take some time to go off after the radar sensor cover is cleaned. Have your vehicle checked by a dealer if the indicator does not go off even after you have cleaned the radar sensor cover. <ul style="list-style-type: none"> ➤ Collision Mitigation Braking System™ (CMBS™) P. 456 ➤ Radar Sensor P. 506 Stays on - The temperature inside the camera is too high. Use the climate control system to cool down the camera. The system activates when the temperature inside the camera cools down. <ul style="list-style-type: none"> ➤ Front Sensor Camera P. 504 	<div style="background-color: #333; color: white; padding: 5px; text-align: center;">  <p>Some Driver Assist Systems Cannot Operate: Radar Obstructed</p> </div> <div style="background-color: #333; color: white; padding: 5px; text-align: center; margin-top: 10px;">  <p>Some Driver Assist Systems Cannot Operate: Camera Temperature Too High</p> </div>

Indicator	Name	On/Blinking	Explanation	Message
	Safety Support Indicator (Amber)	<ul style="list-style-type: none"> Comes on when RDM, Low Speed Braking Control* and/or CMBS™ shuts itself off. 	<ul style="list-style-type: none"> Stays on - The area around the camera is blocked by dirt, mud, etc. Stop your vehicle in a safe place and wipe the debris off with a soft cloth. Have your vehicle checked by a dealer if the indicator and message are still displayed even after you have cleaned the area around the camera. <ul style="list-style-type: none"> ➤ Front Sensor Camera P. 504 	
		<p>Models with Low Speed Braking Control</p> <ul style="list-style-type: none"> Comes on when mud, snow, or ice accumulates in the vicinity of sonar. 	<ul style="list-style-type: none"> Remove the obstacle in the vicinity of sonar sensor. <ul style="list-style-type: none"> ➤ Low Speed Braking Control* P. 465 ➤ Sonar Sensors* P. 507 	
		<p>Models with blind spot information system</p> <ul style="list-style-type: none"> Comes on when mud, snow, or ice has accumulated in the vicinity of the blind spot information system sensor. 	<ul style="list-style-type: none"> Comes on while driving - Something may be interfering with the blind spot information system sensor. Check the vicinity of the blind spot information system sensor and remove any obstacles. <ul style="list-style-type: none"> ➤ Blind spot information System* P. 450 	
		<ul style="list-style-type: none"> Indicator may come on temporarily when the Maximum Load Limit is exceeded. 	<ul style="list-style-type: none"> Make sure the total load is within the Maximum Load Limit. <ul style="list-style-type: none"> ➤ Maximum Load Limit P. 405 	

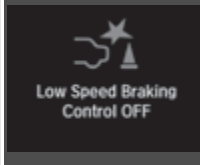

Instrument Panel





* Not available on all models



Indicator	Name	On/Blinking	Explanation	Message
	Safety Support Indicator (Green/Gray)	<ul style="list-style-type: none"> • Lights up in green when RDM, Low Speed Braking Control*, CMBS™, and the blind spot information system* are on. • Lights up in green and gray when RDM, Low Speed Braking Control*, CMBS™, or the blind spot information system* is off. • Lights up in gray when RDM, Low Speed Braking Control*, CMBS™, and the blind spot information system* are off. 	<ul style="list-style-type: none"> ➤ RDM On and Off P. 496 ➤ CMBS™ On and Off P. 459 ➤ Blind spot information System On and Off P. 452 ➤ System On and Off P. 467 	   



Driver Information Interface Warning and Information Messages

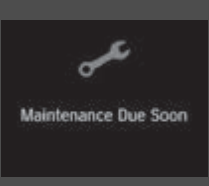
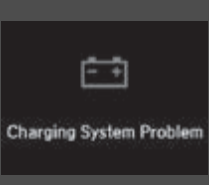

The following messages appear only on the driver information interface. Press the  (home) button, select **Warnings**, then press the left selector wheel to see the message again with the system message indicator on.

Message	Condition	Explanation
 <p>Critical Failure Detected. Stop Driving When Safe.</p>	<ul style="list-style-type: none"> Appears when the vehicle is no longer able to run due to a malfunction. 	<ul style="list-style-type: none"> Immediately stop in a safe place.
 <p>Depress Brake Pedal And Apply Parking Brake</p>	<ul style="list-style-type: none"> Appears when there is a risk that the vehicle will move unexpectedly after you have stopped due to a malfunction with the vehicle. 	<ul style="list-style-type: none"> While the vehicle is stopped, apply the parking brake. <ul style="list-style-type: none"> ▶ Parking Brake P. 508 Have your vehicle checked by a dealer.
 <p>To Continue to Drive, Depress Brake Pedal And Push Switch</p>	<p>Automatic transmission models</p> <ul style="list-style-type: none"> Appears when you set the power mode to ON again and the vehicle is able to run. 	<ul style="list-style-type: none"> ▶ Starting the Engine P. 412

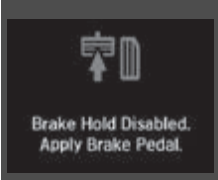
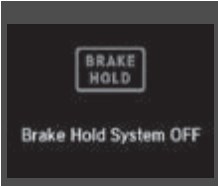



Message	Condition	Explanation
 <p>Door Open</p>  <p>Trunk Open</p>  <p>Door And Trunk Open</p>	<ul style="list-style-type: none"> • Appears if any door or the trunk is not completely closed. • Appears if any door or the trunk is opened while driving. The beeper sounds. 	<ul style="list-style-type: none"> • Disappears when all doors and the trunk are closed.
 <p>Engine Oil Pressure Low. Stop Engine. Do Not Drive.</p>	<ul style="list-style-type: none"> • Appears when the engine oil pressure is low. 	<ul style="list-style-type: none"> • Appears while driving - Immediately stop in a safe place. <ul style="list-style-type: none"> ☒ If the Low Oil Pressure Warning Appears P. 613

Message	Condition	Explanation
	<p>Models with shutter grille</p> <ul style="list-style-type: none"> • Appears if there is a problem with the shutter grille, and the radiator coolant temperature is too high. 	<ul style="list-style-type: none"> • Power output will be reduced, so you may not be able to accelerate or maintain your current speed. Have your vehicle checked by a dealer.
	<p>Canadian models</p> <ul style="list-style-type: none"> • Appears when the washer fluid is low. 	<ul style="list-style-type: none"> • Refill the washer fluid. <ul style="list-style-type: none"> ▶ Refilling Window Washer Fluid P. 563
	<ul style="list-style-type: none"> • Appears when the scheduled maintenance is due soon. • Consequently, Maintenance Due Now and Maintenance Past Due follow. 	<ul style="list-style-type: none"> ▶ Maintenance Minder Messages on the Driver Information Interface P. 543
	<ul style="list-style-type: none"> • Appears when there is a problem with the battery charging system. 	<ul style="list-style-type: none"> • Have your vehicle checked by a dealer.

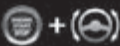



Message	Condition	Explanation
 <p>Engine Temperature Too Hot. Do Not Drive. Allow Engine To Cool.</p>	<ul style="list-style-type: none"> Appears when the engine coolant temperature gets abnormally high. 	<p>➤ Overheating P. 611</p>
 <p>Brake Hold Disabled. Apply Brake Pedal.</p>	<ul style="list-style-type: none"> Appears if the automatic brake hold is automatically canceled while it is in operation. 	<ul style="list-style-type: none"> Immediately depress the brake pedal.
 <p>BRAKE HOLD Brake Hold System OFF</p>	<ul style="list-style-type: none"> Appears when the automatic brake hold system is turned off. 	<p>➤ Automatic Brake Hold P. 513</p>
 <p>To Enable Brake Hold: Seat Belt + Push</p>	<ul style="list-style-type: none"> Appears when the automatic brake hold button is pressed without wearing the driver's seat belt. 	<ul style="list-style-type: none"> Fasten the driver's seat belt. <p>➤ Automatic Brake Hold P. 513</p>

Message	Condition	Explanation
 <p>To Disable Brake Hold: Brake + Push</p>	<ul style="list-style-type: none"> • Appears when the automatic brake hold button is pressed without depressing the brake pedal while the automatic brake hold is in operation. 	<ul style="list-style-type: none"> • Press the automatic brake hold button with the brake pedal depressed. <ul style="list-style-type: none"> ➤ Automatic Brake Hold P. 513
 <p>Parking Brake Engaged</p>	<ul style="list-style-type: none"> • Appears when the parking brake is applied automatically while it is in operation. 	<ul style="list-style-type: none"> ➤ Automatic Brake Hold P. 513 ➤ Parking Brake P. 508
 <p>To Release Parking Brake: Brake + Push</p>	<ul style="list-style-type: none"> • Appears when the electric parking brake switch is pressed without depressing the brake pedal while the electric parking brake is in operation. 	<ul style="list-style-type: none"> • Press the electric parking brake switch with the brake pedal depressed. <ul style="list-style-type: none"> ➤ Parking Brake P. 508

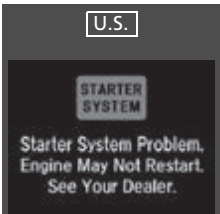
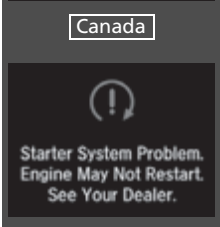
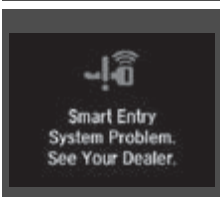
Message	Condition	Explanation
 <p data-bbox="148 311 268 350">To Start Engine: Brake + Push</p>	<ul data-bbox="327 219 834 367" style="list-style-type: none"> • Appears after you set the power mode to ACCESSORY or ON. <p data-bbox="327 286 499 309">Canadian models</p> <ul data-bbox="327 316 834 367" style="list-style-type: none"> • Appears after you unlock and open the driver's door. 	<p data-bbox="949 288 1241 314">➤ Starting the Engine P. 412</p>
 <p data-bbox="148 509 268 548">To Unlock Wheel: Push + Rotate</p>	<p data-bbox="327 412 715 456">Continuously variable transmission models for Canadian models</p> <ul data-bbox="327 473 798 496" style="list-style-type: none"> • Appears when the steering wheel is locked. 	<ul data-bbox="896 412 1495 462" style="list-style-type: none"> • Move the steering wheel left and right while pressing the ENGINE START/STOP button.

Message	Condition	Explanation
 <p>Accessory Mode</p>	<ul style="list-style-type: none"> Appears when the power mode is in ACCESSORY. 	—
 <p>To Switch Vehicle OFF: Push Twice</p>	<ul style="list-style-type: none"> Appears after the driver's door is opened when the power mode is in ACCESSORY. 	<ul style="list-style-type: none"> Change the power mode to VEHICLE OFF. <ul style="list-style-type: none"> ► ENGINE START/STOP Button P. 191
 <p>Keyless Remote Not Detected</p>	<ul style="list-style-type: none"> Appears when you close the door with the power mode in ON without the keyless remote inside the vehicle. 	<ul style="list-style-type: none"> Disappears when you bring the keyless remote back inside the vehicle and close the door. <ul style="list-style-type: none"> ► Keyless Remote Reminder P. 193
 <p>Keyless Remote Battery Low</p>	<ul style="list-style-type: none"> Appears when the keyless remote battery becomes weak. 	<ul style="list-style-type: none"> ► Replacing the Remote Battery P. 586



Message	Condition	Explanation
 <p>To Start, Hold Remote Near Start Button</p>	<ul style="list-style-type: none"> Appears if the keyless remote battery is too weak to start the engine or the key is not within operating range to start the engine. The beeper sounds six times. 	<ul style="list-style-type: none"> Bring the back of the keyless remote into contact with the ENGINE START/STOP button. <ul style="list-style-type: none"> ➤ If the Keyless Remote Battery is Weak P. 604
<div style="border: 1px solid black; padding: 2px; width: fit-content; margin-bottom: 5px;">U.S.</div>  <p>Starter System Problem. Engine May Not Restart. See Your Dealer.</p> <div style="border: 1px solid black; padding: 2px; width: fit-content; margin-bottom: 5px;">Canada</div>  <p>Starter System Problem. Engine May Not Restart. See Your Dealer.</p>	<ul style="list-style-type: none"> Appears when the starter system has a problem. 	<ul style="list-style-type: none"> As a temporary measure, press and hold the ENGINE START/STOP button for up to 15 seconds while pressing the brake pedal, manually start the engine. Have your vehicle checked by a dealer.
 <p>Smart Entry System Problem. See Your Dealer.</p>	<ul style="list-style-type: none"> Appears as soon as a problem is detected in the keyless access system* (smart entry system*) or push button starting system. 	<ul style="list-style-type: none"> Appears constantly - Have your vehicle checked by a dealer.

Message	Condition	Explanation
 <p>Pressing Button Again 2x Or Holding Will Cause Ignition OFF & Power Loss</p>	<ul style="list-style-type: none"> Appears if you press the ENGINE START/STOP button while the vehicle is moving. 	<ul style="list-style-type: none"> ➤ Emergency Engine Stop P. 605
 <p>Driver Attention Level Low</p>	<ul style="list-style-type: none"> Appears if the vehicle is being driven in a manner consistent with drowsy or inattentive driving. 	<ul style="list-style-type: none"> ➤ Driver Attention Monitor P. 154
 <p>Driver Attention Level Low. Time For A Break</p>		
 <p>Check Rear Seats</p>	<ul style="list-style-type: none"> Appears when you set the power mode to VEHICLE OFF, if the rear doors were opened shortly before or after the vehicle was powered on. 	<ul style="list-style-type: none"> Check the rear seat for passengers or items before exiting the vehicle. <ul style="list-style-type: none"> ➤ Rear Seat Reminder P. 217

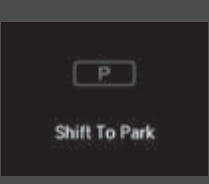

Automatic transmission models

Message	Condition	Explanation
 <p>Transmission Temperature Near Limit. Avoid Heavy Acceleration And High Speed.</p>	<ul style="list-style-type: none"> • Appears when the temperature of the transmission is starting to get too hot. • The performance of the vehicle may be reduced. 	<ul style="list-style-type: none"> • Until the message disappears, reduce your speed and allow the system to cool down.
<p>To Shift From Park Engine Must Be Running</p>	<ul style="list-style-type: none"> • Appears when you attempt to change to another shift position with the transmission in P and the engine OFF. 	<ul style="list-style-type: none"> • To select another shift position while in P, the engine must be ON.
<p>Transmission System Problem. Park Not Available. See Your Dealer.</p>	<ul style="list-style-type: none"> • Appears when you set the power mode to OFF while driving. 	<ul style="list-style-type: none"> • Immediately stop in a safe place, set the parking brake, then restart the engine. If the message disappears, continue driving.

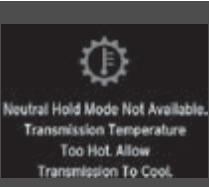



Automatic transmission models

Message	Condition	Explanation
 <p>Shift To Park</p>	<ul style="list-style-type: none"> Appears if the vehicle is stopped and the driver's seat belt is unfastened, as there is a possibility that the vehicle may roll. 	<ul style="list-style-type: none"> When the vehicle is idling or when you are parking or exiting the vehicle, put the transmission into P before releasing the brake pedal. <ul style="list-style-type: none"> ➤ Shift Operation P. 421
 <p>To Exit Vehicle In Neutral: Press N Again & Hold For 2sec</p>	<ul style="list-style-type: none"> Appears when you put the transmission into N, then release the N button. 	<ul style="list-style-type: none"> ➤ If you want to keep the transmission in N position [car wash mode] P. 423
 <p>Neutral Hold Mode Not Available. Transmission Temperature Too Hot. Allow Transmission To Cool.</p>	<ul style="list-style-type: none"> Appears when car wash mode is not available due to the transmission being too hot. 	<ul style="list-style-type: none"> When the transmission is too hot, car wash mode may not be available. Let the engine idle until the transmission has cooled down. <ul style="list-style-type: none"> ➤ If you want to keep the transmission in N position [car wash mode] P. 423





Automatic transmission models

Message	Condition	Explanation
 <p>To Shift: Release Accelerator Pedal</p>	<ul style="list-style-type: none"> Appears when you try to change the shift position without releasing your foot off the accelerator pedal. 	<ul style="list-style-type: none"> Release your foot off the accelerator pedal, then change the shift position.
<p>To Shift: Vehicle Must Be Stopped</p>	<ul style="list-style-type: none"> Appears when the P button is pressed while the vehicle is moving. Appears if you put the transmission into R while the vehicle is moving forward, or into D while the vehicle is reversing. 	<ul style="list-style-type: none"> Make sure that the vehicle comes to a stop before operating the shift button.
 <p>Fasten Seat Belt</p> <p>(White)</p>	<ul style="list-style-type: none"> Appears when you set the power mode to ON without fastening the driver's seat belt. Appears when you change the shift position after P has been automatically selected with the driver's door open, the driver's seat belt unfastened, then the brake pedal is released. 	<ul style="list-style-type: none"> Fasten the seat belt properly before you start to drive. <ul style="list-style-type: none"> ► Shift Operation P. 421
 <p>To Shift: Apply Brake Pedal</p>	<ul style="list-style-type: none"> Appears when you try to change the shift position without depressing the brake pedal. 	<ul style="list-style-type: none"> Depress the brake pedal, then change the shift position.

Automatic transmission models

Message	Condition	Explanation
 <p>Gear Position is N. Release Accelerator Pedal.</p>	<ul style="list-style-type: none"> Appears when you depress the accelerator pedal while the transmission is in [N]. 	<ul style="list-style-type: none"> Remove your foot off the accelerator pedal. When driving, depress the brake pedal and operate the shift position.
 <p>Gear Unavailable. Try Again After Awhile.</p>	<ul style="list-style-type: none"> Appears when you repeatedly change the shift position between [P] and other positions in short period. Appears when you try to take the transmission out of [P] immediately after you start engine. 	<ul style="list-style-type: none"> Take some time before changing the shift position. Try to take the transmission out of [P] again.
 <p>Shifting To Park Apply Brake Pedal</p>	<ul style="list-style-type: none"> Appears when you press the [P] button but it is not engaged due to low ATF temperature. 	<ul style="list-style-type: none"> Depress the brake pedal until this message disappear.
 <p>Neutral Hold Mode On. Shift to Park When Done.</p>	<ul style="list-style-type: none"> Appears when you press and hold [N] button for more than two seconds. 	<ul style="list-style-type: none"> Disappears when you set the shift position to a shift other than [N]. <ul style="list-style-type: none"> ➤ If you want to keep the transmission in [N] position [car wash mode] P. 423



Continuously variable transmission models



Message	Condition	Explanation
 <p>Shift To Park</p>	<ul style="list-style-type: none"> Appears if you press the ENGINE START/STOP button to turn the engine off without the shift lever in P. 	<p>U.S. models</p> <ul style="list-style-type: none"> Move the shift lever to P. The power mode changes to VEHICLE OFF. <p>Canadian models</p> <ul style="list-style-type: none"> Move the shift lever to P, then press the ENGINE START/STOP button twice.
 <p>System Problem Detected. Shift To Park.</p>	<ul style="list-style-type: none"> Appears when the engine stops without the transmission in P, and does not restart automatically. Appears if you open the hood while Auto Idle Stop activated. 	<ul style="list-style-type: none"> If you want to set the power mode to ON, put the transmission into P. If you want to start the engine, follow the normal procedure. <ul style="list-style-type: none"> ➤ Starting the Engine P. 412
 <p>To Continue to Drive, Depress Brake Pedal And Push Switch</p>	<ul style="list-style-type: none"> Appears when the engine does not restart automatically due to the following reasons: <ul style="list-style-type: none"> - The hood is open. - There is a problem in the system that disables Auto Idle Stop. 	<ul style="list-style-type: none"> Follow the normal procedure to start the engine. <ul style="list-style-type: none"> ➤ Starting the Engine P. 412
 <p>Auto Engine Idle Stop Enabled</p>	<ul style="list-style-type: none"> Appears when you turn the Auto Idle Stop system on. 	<ul style="list-style-type: none"> ➤ Auto Idle Stop System ON/OFF P. 436



Continuously variable transmission models

Message	Condition	Explanation
 <p>Auto Idle-Stop Unavailable</p>	<ul style="list-style-type: none"> • Appears when Auto Idle Stop does not activate for some reason. • Appears when the engine restarts automatically. • Appears when the battery temperature is around 41°F (5°C) or lower. 	<p>➤ Auto Idle Stop Activates When: P. 437</p>
	<ul style="list-style-type: none"> • Appears when Auto Idle Stop does not activate because the climate control system is in use, and the difference between the set temperature and actual interior temperature becomes significant. 	
	<ul style="list-style-type: none"> • Appears when Auto Idle Stop does not activate because the engine is not adequately warmed up or the coolant temperature is high. 	
	<ul style="list-style-type: none"> • Appears when Auto Idle Stop does not activate because the battery charge level is low. • Appears when the battery is low performance. 	







Continuously variable transmission models



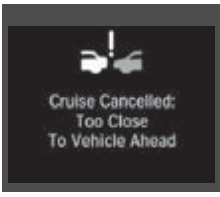

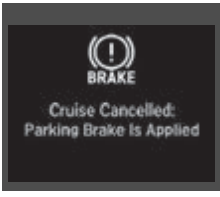
Message	Condition	Explanation
 <p>For Auto Engine Idle Stop, Fully Depress Brake Pedal</p>	<ul style="list-style-type: none"> • Appears when Auto Idle Stop does not activate because the pressure to the brake pedal is not enough. 	<ul style="list-style-type: none"> • Depress the brake pedal firmly. <ul style="list-style-type: none"> ➤ Auto Idle Stop* P. 435
 <p>Auto Engine Idle Stop: Engine Will Restart Soon</p>	<ul style="list-style-type: none"> • Appears when the system is under the following conditions while Auto Idle Stop activates: <ul style="list-style-type: none"> - The climate control system is in use, and the difference between the set temperature and actual interior temperature becomes significant. - The humidity in the interior is high. - The battery charge level is low. 	<ul style="list-style-type: none"> • The engine restarts automatically in a few seconds. <ul style="list-style-type: none"> ➤ Auto Idle Stop* P. 435 ➤ The Engine Automatically Restarts When: P. 439
 <p>Hood Open</p>	<ul style="list-style-type: none"> • Appears when the hood is opened. 	<ul style="list-style-type: none"> • Close the hood.

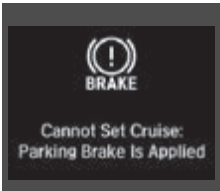

Message	Condition	Explanation
 <p>Automatic Lighting Control System Problem. Manual Controls Available. See Your Dealer.</p>	<ul style="list-style-type: none"> Appears if there is a problem with the automatic lighting control system. 	<ul style="list-style-type: none"> Appears while driving - Manually turn the lights on, and have your vehicle checked by a dealer.
 <p>Headlight System Problem. Headlight Performance May Be Reduced. See Your Dealer.</p>	<ul style="list-style-type: none"> Appears if there is a problem with the headlights. 	<ul style="list-style-type: none"> Appears while driving - The headlights may not be on. When conditions allow you to drive safely, have your vehicle checked by a dealer as soon as possible.
 <p>Parking Sensor System Problem.</p>	<p>Models with parking sensor system</p> <ul style="list-style-type: none"> Appears if there is a problem with the parking sensor system. 	<ul style="list-style-type: none"> Check if the area around the sensor(s) is covered with mud, ice, snow, etc. If the indicator(s) stays on even after you clean the area, have the system checked by a dealer.

Message	Condition	Explanation
 <p data-bbox="105 309 309 370">Auto High-Beam Problem. Manual Controls Available. See Your Dealer.</p>	<ul style="list-style-type: none"> • Appears if there is a problem with the auto high-beam. 	<ul style="list-style-type: none"> • Manually operate the headlight switch. • If you are driving with the high beam headlights when this happens, the headlights are changed to low beams.
	<ul style="list-style-type: none"> • Appears when ACC with Low Speed Follow has been automatically canceled. 	<ul style="list-style-type: none"> • You can resume the set speed after the condition that caused ACC with Low Speed Follow to cancel improves. Press the RES/+ button. <ul style="list-style-type: none"> ➤ Adaptive Cruise Control (ACC) with Low Speed Follow P. 470
	<ul style="list-style-type: none"> • Flashes when the system senses a likely collision. The beeper sounds. 	<ul style="list-style-type: none"> • Take appropriate action means to prevent a collision (apply the brakes, change lanes, etc.) <ul style="list-style-type: none"> ➤ Collision Mitigation Braking System™ (CMBS™) P. 456 ➤ Adaptive Cruise Control (ACC) with Low Speed Follow P. 470 ➤ Low Speed Braking Control* P. 465

Message	Condition	Explanation
Cruise Cancelled: Speed Too High	<ul style="list-style-type: none"> Appears when ACC with Low Speed Follow is canceled due to excessive high vehicle speed. 	<ul style="list-style-type: none"> Reduce the speed, then reset ACC with Low Speed Follow. <ul style="list-style-type: none"> ▶ Adaptive Cruise Control (ACC) with Low Speed Follow P. 470
Cannot Set Cruise: Speed Too High	<ul style="list-style-type: none"> Appears when the speed of the vehicle is too high for you to set ACC with Low Speed Follow. 	<ul style="list-style-type: none"> Reduce the speed, then set ACC with Low Speed Follow. <ul style="list-style-type: none"> ▶ Adaptive Cruise Control (ACC) with Low Speed Follow P. 470
Cruise Cancelled: Speed Too Low	<ul style="list-style-type: none"> Appears when cruise control is canceled due to excessive low vehicle speed. 	<ul style="list-style-type: none"> Raise the speed, then reset cruise control. <ul style="list-style-type: none"> ▶ To Switch ACC with Low Speed Follow to Cruise Control P. 484
Cannot Set Cruise: Speed Too Low	<ul style="list-style-type: none"> Appears when the speed of the vehicle is too low for you to set cruise control. 	<ul style="list-style-type: none"> Raise the speed, then set cruise control. <ul style="list-style-type: none"> ▶ To Switch ACC with Low Speed Follow to Cruise Control P. 484

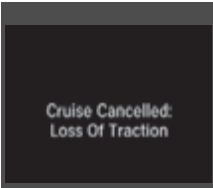

Message	Condition	Explanation
 <p>Cruise Cancelled: Too Close To Vehicle Ahead</p>	<ul style="list-style-type: none"> Appears when the distance between your vehicle and the vehicle ahead of you is too close while ACC with Low Speed Follow is in operation. 	<ul style="list-style-type: none"> ACC with Low Speed Follow has been automatically canceled. <ul style="list-style-type: none"> ➤ Adaptive Cruise Control (ACC) with Low Speed Follow P. 470
 <p>Cannot Set Cruise: Too Close To Vehicle Ahead</p>	<ul style="list-style-type: none"> Appears when pressing the SET/- button while the distance between your vehicle and the vehicle ahead of you is too close. 	<ul style="list-style-type: none"> ACC with Low Speed Follow cannot be set. <ul style="list-style-type: none"> ➤ Adaptive Cruise Control (ACC) with Low Speed Follow P. 470
 <p> Cruise Cancelled: Parking Brake Is Applied</p>	<ul style="list-style-type: none"> Appears when the parking brake is applied automatically while ACC with Low Speed Follow is in operation. 	<ul style="list-style-type: none"> ACC with Low Speed Follow has been automatically canceled. <ul style="list-style-type: none"> ➤ Adaptive Cruise Control (ACC) with Low Speed Follow P. 470 ➤ Parking Brake P. 508
 <p> Cannot Set Cruise: Parking Brake Is Applied</p>	<ul style="list-style-type: none"> Appears when pressing the SET/- button while the parking brake is applied. 	<ul style="list-style-type: none"> ACC with Low Speed Follow cannot be set. <ul style="list-style-type: none"> ➤ Adaptive Cruise Control (ACC) with Low Speed Follow P. 470 ➤ Parking Brake P. 508



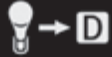

Message	Condition	Explanation
 <p>Cannot Set Cruise: Brake Pedal Is Applied</p>	<ul style="list-style-type: none"> Appears when pressing the SET/- button while the vehicle is moving and the brake pedal is depressed. 	<ul style="list-style-type: none"> ACC with Low Speed Follow cannot be set. <ul style="list-style-type: none"> ▶ Adaptive Cruise Control (ACC) with Low Speed Follow P. 470
 <p>Cruise Will Cancel Soon: Slope Too Steep</p>	<ul style="list-style-type: none"> Appears just before the ACC with Low Speed Follow is automatically canceled when you are descending a long hill etc (The following interval is automatically set to extra long). 	
  <p>Cruise Cancelled: Slope Too Steep. Watch Downhill Speed</p>	<ul style="list-style-type: none"> Appears when the ACC with Low Speed Follow has been automatically canceled. 	<ul style="list-style-type: none"> ▶ Adaptive Cruise Control (ACC) with Low Speed Follow P. 470
 <p>Cannot Set Cruise: Slope Too Steep</p>	<ul style="list-style-type: none"> Appears when you are descending a long hill etc and you press the RES/+ or SET/- button. 	<ul style="list-style-type: none"> ▶ Adaptive Cruise Control (ACC) with Low Speed Follow P. 470



Message	Condition	Explanation
 <p>Cruise Cancelled: Loss Of Traction</p>	<ul style="list-style-type: none"> Appears if the VSA® or traction control function operates while ACC with Low Speed Follow is in operation. 	<ul style="list-style-type: none"> ACC with Low Speed Follow has been automatically canceled. <ul style="list-style-type: none"> ► Adaptive Cruise Control (ACC) with Low Speed Follow P. 470
 <p>Cruise Cancelled: Fasten Seat Belt</p>	<ul style="list-style-type: none"> Appears when the driver's seat belt is unfastened while your vehicle is automatically stopped by ACC with Low Speed Follow. 	<ul style="list-style-type: none"> ACC with Low Speed Follow has been automatically canceled. <ul style="list-style-type: none"> ► Adaptive Cruise Control (ACC) with Low Speed Follow P. 470
 <p>Cannot Set Cruise: Fasten Seat Belt</p>	<ul style="list-style-type: none"> Appears when pressing the SET/- button while the driver's seat belt is unfastened. 	<ul style="list-style-type: none"> ACC with Low Speed Follow cannot be set. <ul style="list-style-type: none"> ► Adaptive Cruise Control (ACC) with Low Speed Follow P. 470



Message	Condition	Explanation
<p data-bbox="102 232 295 272">Automatic transmission models</p>  <p data-bbox="129 395 268 434">Cruise Cancelled: Shift To Drive</p> <p data-bbox="102 465 295 505">Continuously variable transmission models</p>  <p data-bbox="129 622 268 661">Cruise Cancelled: Shift To Drive</p>	<ul style="list-style-type: none"> Appears when the transmission is put into any position other than D or S* while ACC with Low Speed Follow is in operation. 	<ul style="list-style-type: none"> ACC with Low Speed Follow has been automatically canceled. <ul style="list-style-type: none"> ► Adaptive Cruise Control (ACC) with Low Speed Follow P. 470

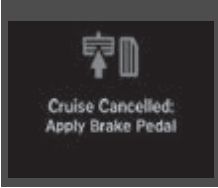
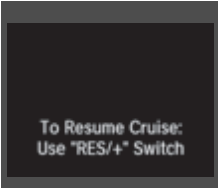
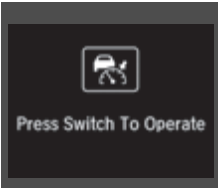

* Not available on all models

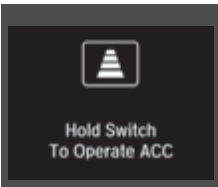

Message	Condition	Explanation
<div data-bbox="97 213 312 292">Automatic transmission models</div> <div data-bbox="97 292 312 456">  </div> <div data-bbox="97 456 312 529">Continuously variable transmission models</div> <div data-bbox="97 529 312 688">  </div>	<ul style="list-style-type: none"> Appears when pressing the SET/- button while the transmission is in any position other than D or S*. 	<ul style="list-style-type: none"> ACC with Low Speed Follow cannot be set. <ul style="list-style-type: none"> ► Adaptive Cruise Control (ACC) with Low Speed Follow P. 470

Message	Condition	Explanation
 <p>Cruise Cancelled: Slope Too Steep</p>	<ul style="list-style-type: none"> • Appears when the vehicle is stopped on a very steep slope while ACC with Low Speed Follow is in operation. 	<ul style="list-style-type: none"> • ACC with Low Speed Follow has been automatically canceled. <ul style="list-style-type: none"> ▶ Adaptive Cruise Control (ACC) with Low Speed Follow P. 470
 <p>Cruise Cancelled: Slope Too Steep</p>		
 <p>Cannot Set Cruise: Slope Too Steep</p>	<ul style="list-style-type: none"> • Appears when pressing the SET/- button while the vehicle is stopped on a very steep slope. 	<ul style="list-style-type: none"> • ACC with Low Speed Follow cannot be set. <ul style="list-style-type: none"> ▶ Adaptive Cruise Control (ACC) with Low Speed Follow P. 470
 <p>Cannot Set Cruise: Slope Too Steep</p>		

Message	Condition	Explanation
 <p>Cruise Cancelled: Apply Brake Pedal</p>	<ul style="list-style-type: none"> Appears if ACC with Low Speed Follow is canceled while your vehicle is automatically stopped by ACC with Low Speed Follow. 	<ul style="list-style-type: none"> Immediately depress the brake pedal.
 <p>To Resume Cruise: Use "RES/+" Switch</p>	<ul style="list-style-type: none"> Appears when the vehicle ahead of you resumes driving, after your vehicle has been stopped automatically by ACC with Low Speed Follow. 	<ul style="list-style-type: none"> Press the RES/+ or SET/- button or depress the accelerator pedal to resume. <ul style="list-style-type: none"> ► Adaptive Cruise Control (ACC) with Low Speed Follow P. 470
 <p>Press Switch To Operate</p>	<ul style="list-style-type: none"> Appears when the SET/-, RES/+, CANCEL or Interval button is pressed while ACC with Low Speed Follow is off. 	<ul style="list-style-type: none"> After pressing the  button, press the SET/-, RES/+, CANCEL or Interval button. <ul style="list-style-type: none"> ► Adaptive Cruise Control (ACC) with Low Speed Follow P. 470
 <p>Hold Switch To Operate ACC</p>	<ul style="list-style-type: none"> Appears when the Interval button is pressed while Cruise mode is selected. 	<ul style="list-style-type: none"> After selecting ACC with Low Speed Follow, press the Interval button. <ul style="list-style-type: none"> ► Adaptive Cruise Control (ACC) with Low Speed Follow P. 470

Message	Condition	Explanation
 <p>Some Driver Assist Systems Cannot Operate: Radar Obstructed</p>	<ul style="list-style-type: none"> • Appears if anything covers the radar sensor cover and prevents the sensor from detecting a vehicle in front. • May appear when driving in bad weather (rain, snow, fog, etc.). 	<ul style="list-style-type: none"> • When the radar sensor gets dirty, stop your vehicle in a safe place, and wipe off dirt using a soft cloth. The message may take some time to go off. • Have your vehicle checked by a dealer if the message does not disappear even after you clean the sensor cover. <ul style="list-style-type: none"> ▶ Radar Sensor P. 506 ▶ Honda Sensing® P. 453
 <p>Some Driver Assist Systems Cannot Operate: Camera Temperature Too High</p>	<ul style="list-style-type: none"> • Appears if the temperature inside the front sensor camera is too high and some driver assist systems and auto high-beam cannot be activated. 	<ul style="list-style-type: none"> • Use the climate control system to cool down the camera. • Disappears - The camera has been cooled down and the systems are activated normally. <ul style="list-style-type: none"> ▶ Front Sensor Camera P. 504 ▶ Auto High-Beam P. 199 ▶ Honda Sensing® P. 453
 <p>Some Driver Assist Systems Cannot Operate: Clean Front Windshield</p>	<ul style="list-style-type: none"> • Appears if the area around the front sensor camera is blocked by dirt, mud, etc. and be prevented from detecting a vehicle in front. • May appear when driving in bad weather (rain, snow, fog, etc.). 	<ul style="list-style-type: none"> • When the front window gets dirty, stop your vehicle in a safe place, and wipe it off with a soft cloth. • Have your vehicle checked by a dealer if the message does not disappear even after you cleaned the area around the camera. <ul style="list-style-type: none"> ▶ Front Sensor Camera P. 504 ▶ Auto High-Beam P. 199 ▶ Honda Sensing® P. 453

Message	Condition	Explanation
 <p>Lane Departure</p>	<p>Lane Keeping Assist System (LKAS)</p> <ul style="list-style-type: none"> • Appears when the vehicle is driving out of a detected lane. The steering wheel vibrates rapidly. <p>Road Departure Mitigation (RDM) System</p> <ul style="list-style-type: none"> • Appears when the vehicle is driving out of a detected lane. <p>When you selected Warning Only</p> <ul style="list-style-type: none"> - The steering wheel vibrates rapidly when the vehicle is drifting out of a detected lane. <p>When you selected Narrow, Normal or Wide</p> <ul style="list-style-type: none"> - The steering wheel vibrates rapidly when the vehicle is drifting out of a detected lane. The system also steers the vehicle to help you remain within your driving lane. 	<ul style="list-style-type: none"> • Keep the vehicle within the lane you are driving. <ul style="list-style-type: none"> ➤ Lane Keeping Assist System (LKAS) P. 486 • Keep the vehicle within the lane you are driving. <ul style="list-style-type: none"> ➤ Road Departure Mitigation (RDM) System P. 494 • You can change the setting for the Road Departure Mitigation system. Narrow, Normal, Wide, and Warning Only can be selected. <ul style="list-style-type: none"> ➤ Customized Features P. 351
 <p>Road Departure Mitigation Activated</p>	<p>Road Departure Mitigation (RDM) System</p> <p>When you selected Narrow</p> <ul style="list-style-type: none"> • Appears when the vehicle is likely to drive out of a detected lane. The RDM system also steers the vehicle to help you remain within your driving lane. 	<p>—</p>

Message	Condition	Explanation
 <p>Steering Required</p>	<ul style="list-style-type: none"> Blinks when you fail to steer the vehicle. The beeper sounds simultaneously. 	<ul style="list-style-type: none"> Operate the steering wheel to resume the LKAS.
 <p>Lane Keeping Assist Cannot Operate</p>	<ul style="list-style-type: none"> Appears when the LKAS is in operation, or the LKAS button is pressed, but there is a problem with a system related to the LKAS. The LKAS cancels automatically. The beeper sounds simultaneously. 	<ul style="list-style-type: none"> If any other system indicators come on, such as the VSA®, ABS and brake system, take appropriate action. <ul style="list-style-type: none"> ► Indicators P. 82
 <p>Low Speed Braking Control Activated. Object Detected.</p>	<p>Models with Low Speed Braking Control</p> <ul style="list-style-type: none"> Appears when the Low Speed Braking Control is activated. 	<p>—</p>

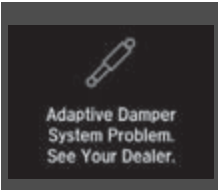
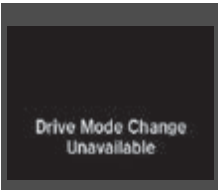
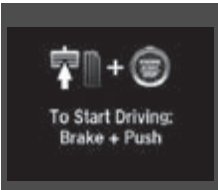
Message	Condition	Explanation
 <p>Adaptive Damper System Problem. See Your Dealer.</p>	<p>Models with adaptive damper system</p> <ul style="list-style-type: none"> • Appears if there is a problem with the adaptive damper system. 	<ul style="list-style-type: none"> • Have your vehicle checked by a dealer. Your vehicle will have normal damping ability without the adaptive damper feature.
 <p>Drive Mode Change Unavailable</p>	<ul style="list-style-type: none"> • Appears if the ECON mode or SPORT mode* cannot be changed due to certain situations, such as a system error or adverse driving conditions. 	<ul style="list-style-type: none"> ➤ ECON Mode P. 434 ➤ SPORT Mode* P. 433
 <p>To Start Driving: Brake + Push</p>	<p>Models with remote engine starter</p> <ul style="list-style-type: none"> • Appears when you unlock and open the driver's door while the engine is running by remote engine start. 	<ul style="list-style-type: none"> ➤ Remote Engine Start* P. 414

Gauges

Gauges include the speedometer, fuel gauge, and other related indicators. They are displayed when the power mode is in ON.

Speedometer

Displays your driving speed in mph (U.S.) or km/h (Canada).

Fuel Gauge

Displays the amount of fuel left in the fuel tank.

Temperature Gauge

Displays the temperature of the engine coolant.

Speedometer

You can show another speed unit on the driver information interface and set the displayed measurements to read in either mph or km/h.

➤ **Tachometer** P. 151

Fuel Gauge

NOTICE

You should refuel when the reading approaches **E**. Running out of fuel can cause the engine to misfire, damaging the catalytic converter.

The actual amount of remaining fuel may differ from the fuel gauge reading.

Temperature Gauge

NOTICE

Driving with the temperature gauge pointer in the upper zone can cause serious engine damage. Pull safely to the side of the road and allow engine temperature to return to normal.

➤ **Overheating** P. 611

Driver Information Interface

The driver information interface shows information such as the estimated travelable distance and fuel economy of the vehicle. It also displays messages such as warnings and other helpful information.

■ Switching the Display

■ Accessing contents in the main display

Press the  (home) button, then roll the left selector wheel to scroll to the content you want to see. Press the left selector wheel to see detailed information.

▶ Switching the Display

To go back to the previous screen, press the  (back) button.

You can edit, add, or delete the meter contents using the audio/information screen.

▶ **Customizing the Meter** P. 265

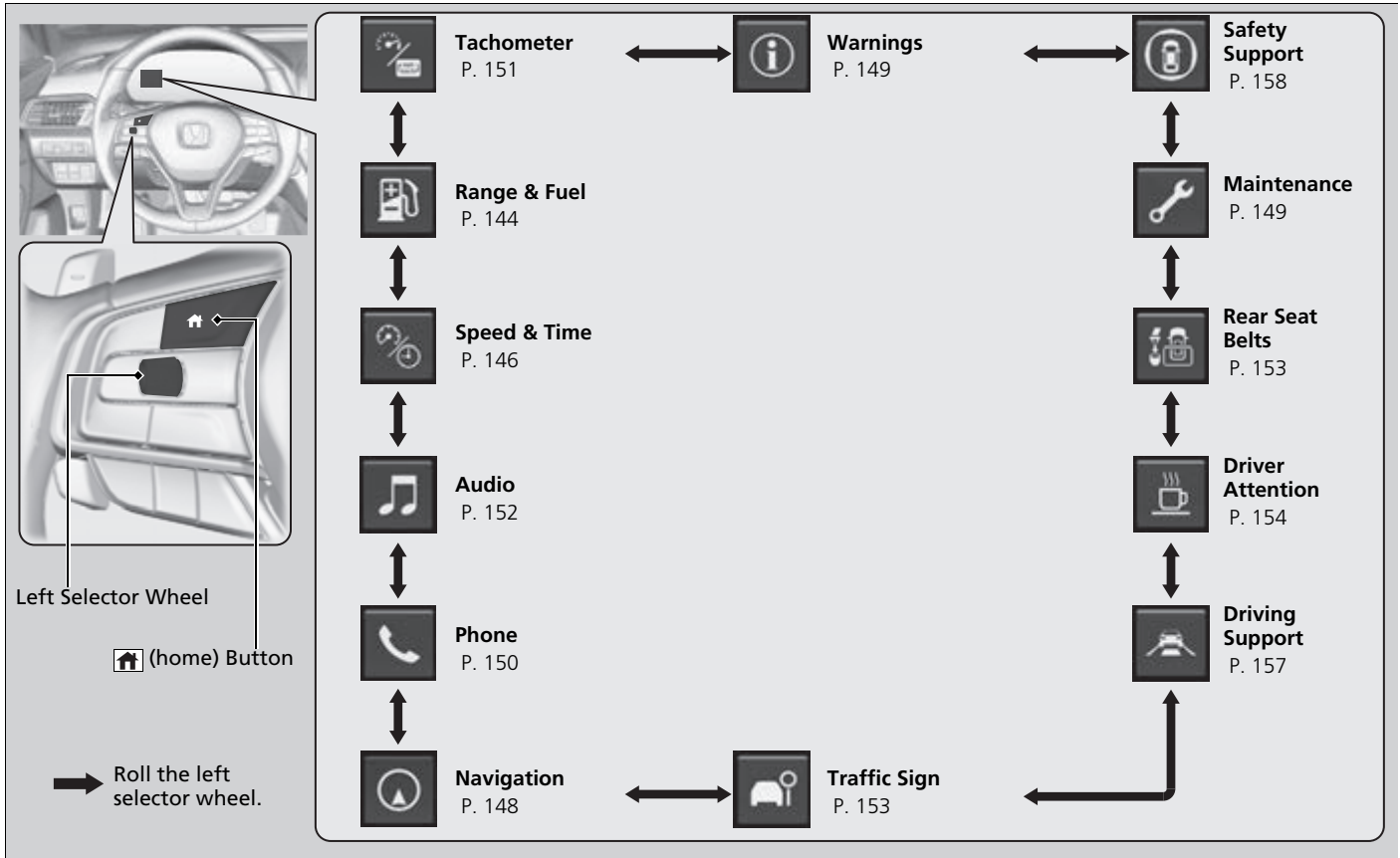

■ Sub display

Press the **TRIP** button to change the display.

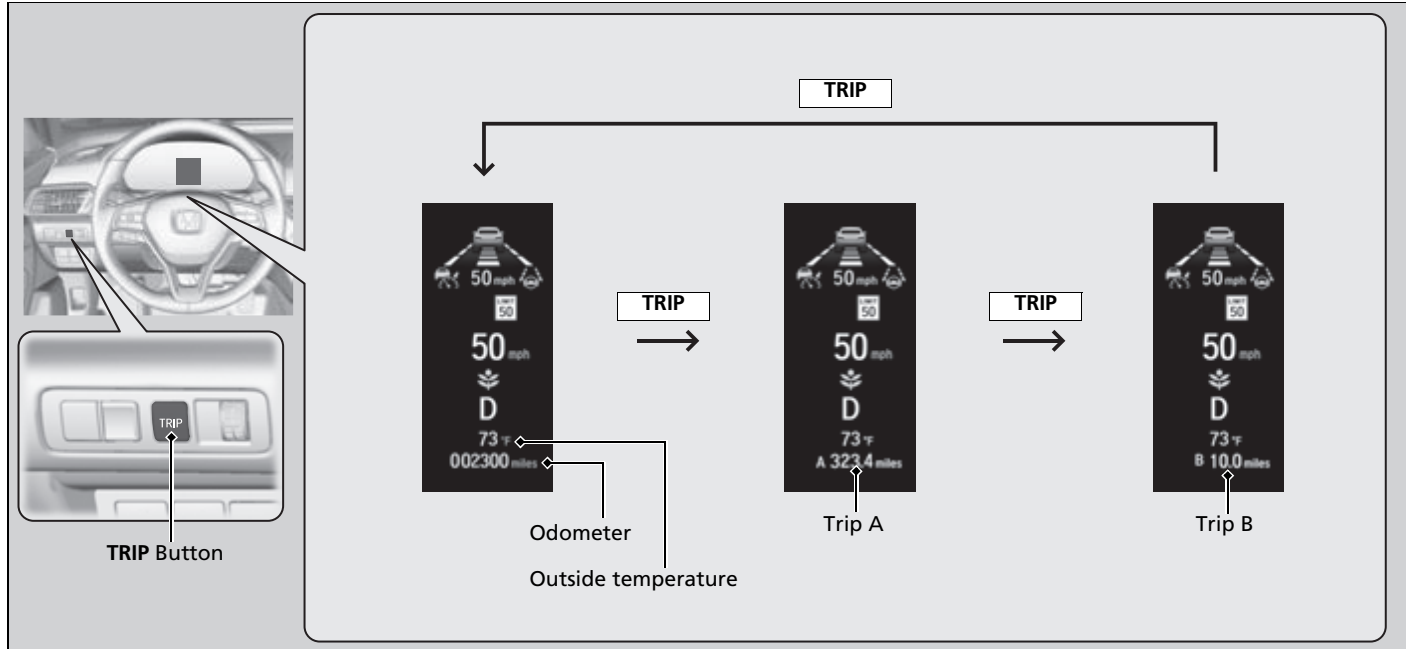

■ Odometer

Shows the total number of miles or kilometers that your vehicle has accumulated.

■ Trip Meter

Shows the total number of miles or kilometers driven since the last reset. Meters A and B can be used to measure two separate trips.

■ Resetting a trip meter

To reset a trip meter, display it, then press and hold the **TRIP** Button. The trip meter is reset to **0.0**.

■ Outside Temperature

Shows the outside temperature in Fahrenheit (U.S.) or Celsius (Canada).

■ Adjusting the outside temperature display

Adjust the temperature reading by up to $\pm 5^{\circ}\text{F}$ or $\pm 3^{\circ}\text{C}$ if the temperature reading seems incorrect.

⌘ Trip Meter

Switch between trip meter A and trip meter B by pressing the **TRIP** Button.

⌘ Outside Temperature

The temperature sensor is in the front bumper. Road heat and exhaust from another vehicle can affect the temperature reading when your vehicle speed is less than 19 mph (30 km/h).

It may take several minutes for the display to be updated after the temperature reading has stabilized.

You can adjust the temperature reading.

➤ **Customized Features** P. 351

■ Range & Fuel

Roll the left selector wheel to switch between trip computer A and trip computer B.

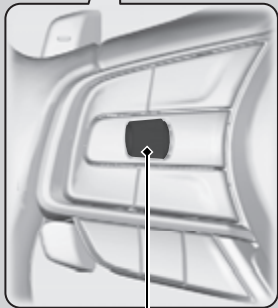
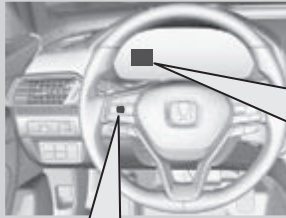

Left Selector Wheel

➔ Roll the left selector wheel.

Trip Computer A

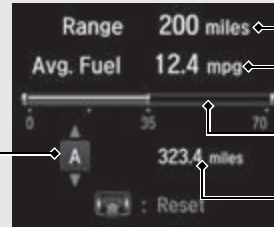

- Range
- Average Fuel Economy
- Instant Fuel Economy
- Trip Meter

Trip Computer B

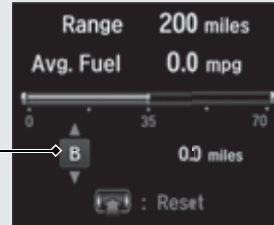

■ Trip meter

Shows the total number of miles or kilometers driven since the last reset. Meters A and B can be used to measure two separate trips.

Resetting a trip meter

To reset the trip meter, display it, press the left selector wheel and then select **Reset**.
▶ The trip meter is reset to **0.0**.

■ Average fuel economy (Avg. Fuel)

Shows the estimated average fuel economy of each trip meter in mpg or l/100 km. The display is updated at set intervals. When a trip meter is reset, the average fuel economy is also reset.

■ Instant fuel economy

Shows the instant fuel economy as a bar graph in mpg or l/100 km.

■ Range

Shows the estimated distance you can travel on the remaining fuel. This estimated distance is based on the vehicle's current fuel economy.

▶▶ Trip meter

Switch between trip meter A and trip meter B by rolling the left selector wheel.

When resetting the trip meter in the **Range & Fuel**, the trip meter in the sub display resets at the same time.

▶▶ Average fuel economy (Avg. Fuel)

You can change when to reset the average fuel economy.

▶ **Customized Features** P. 351

■ Speed & Time

Roll the left selector wheel to switch between trip computer A and trip computer B.

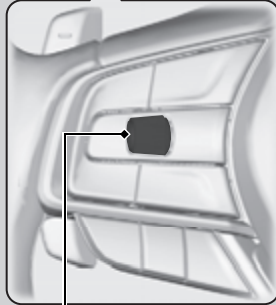
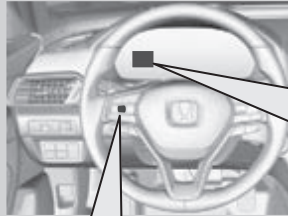

Left Selector Wheel

➔ Roll the left selector wheel.

Trip Computer A

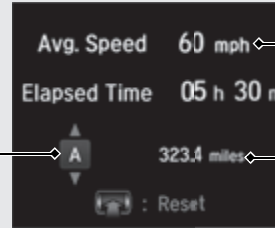

Average Speed

Elapsed Time

Trip Meter



Trip Computer B

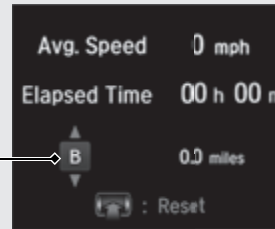

■ Trip meter

➤ **Trip meter** P. 145

■ Elapsed Time

Shows the time elapsed since Trip A or Trip B was reset.

■ Average Speed (Avg. Speed)

Shows the average speed in mph or km/h since Trip A or Trip B was reset.

⌘ Elapsed Time

You can change when to reset the elapsed time.

➤ **Customized Features** P. 351

⌘ Average Speed (Avg. Speed)

You can change when to reset the average speed.

➤ **Customized Features** P. 351

Navigation



Compass

Shows the compass screen.

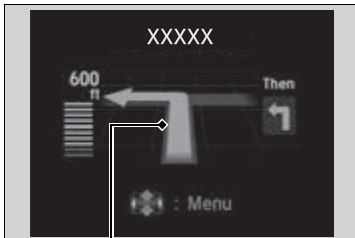

Turn-By-Turn Driving Directions

Turn-by-Turn Directions

When driving guidance is provided by the navigation system*, Android Auto or Apple CarPlay, turn-by-turn directions to your destination appear.

- ▶ Refer to the **Navigation System Manual**
- ▶ **Android Auto** P. 320
- ▶ **Apple CarPlay** P. 313

Navigation

You can select whether to have the turn-by-turn display come on or not during the route guidance.

- ▶ **Customized Features** P. 351

Turn-by-turn directions may not be available for all apps.

Models with navigation system

When the compass or turn-by-turn directions are displayed, you can control some navigation system functions on the driver information interface by scrolling the left selector wheel.

- ▶ **Refer to the Navigation System Manual**

■ Warnings

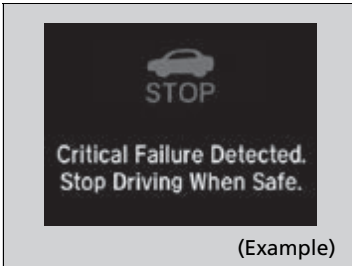

➤ **Driver Information Interface Warning and Information Messages** P. 109

■ Maintenance

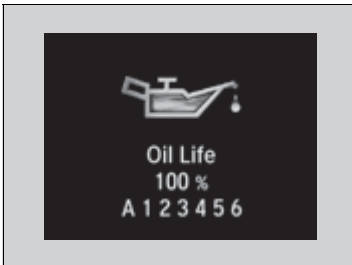

Shows the remaining oil life and Maintenance Minder™.

➤ **Maintenance Minder™** P. 541

⌘ Warnings

If there are no **Warnings**, **None** message appears on the driver information interface.

If there are multiple warnings, you can roll the left selector wheel to see other warnings.

■ Phone

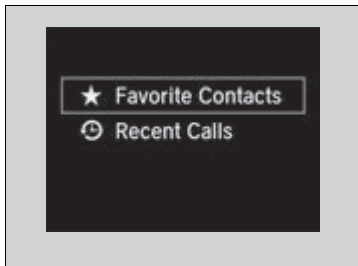

Shows the current phone information.

▶ **Bluetooth® HandsFreeLink®** P. 374

Tachometer



Shows the number of engine revolutions per minute.

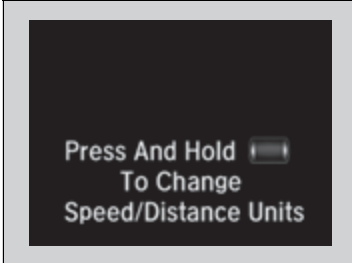

Speed/Distance Units

Enables you to show another unit on the driver information interface, head-up display* and audio/information screen and set the displayed measurements to read in either miles and mph or km and km/h.

Press and hold the left selector wheel when you select the **Tachometer** on the driver information interface. Each time you do this, the unit will change from miles and mph to km and km/h or vice versa. After this, a confirmation screen will appear for a few seconds.

Tachometer

The tachometer can be turned on and off using the audio/information screen.

▶ **Customized Features** P. 351

Even if you have turned off the tachometer on the audio/information screen, if **Tachometer** is selected on the driver information interface, it will change to a tachometer-only display.

* Not available on all models

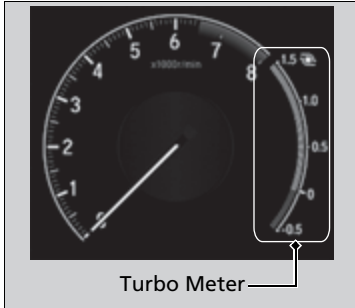

Models with SPORT mode

■ Turbo Meter

When the turbo charger is producing boost, this meter shows the boost pressure.

When the SPORT mode is turned on while the tachometer appears, the turbo meter appears on the driver information interface.

■ Audio

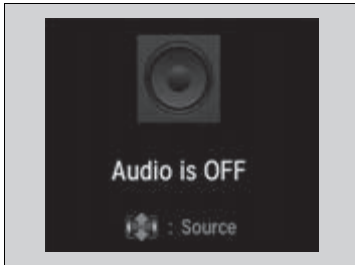

Shows the current audio information.

▶ **Audio System Basic Operation** P. 253

■ Traffic Sign Recognition System



Shows the traffic sign recognition system.

➤ **Traffic Sign Recognition System** P. 498

■ Rear Seat Belt Reminder

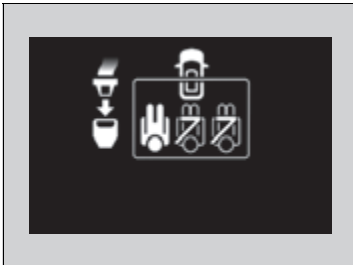

Appears when any of the rear seat belts are latched or unlatched.

➤ **Seat Belt Reminder** P. 39

■ Driver Attention Monitor

The Driver Attention Monitor analyzes steering inputs to determine if the vehicle is being driven in a manner consistent with drowsy or inattentive driving. If it determines that the vehicle is being driven in such a manner, it will display the degree of the driver's attention on the driver information interface.

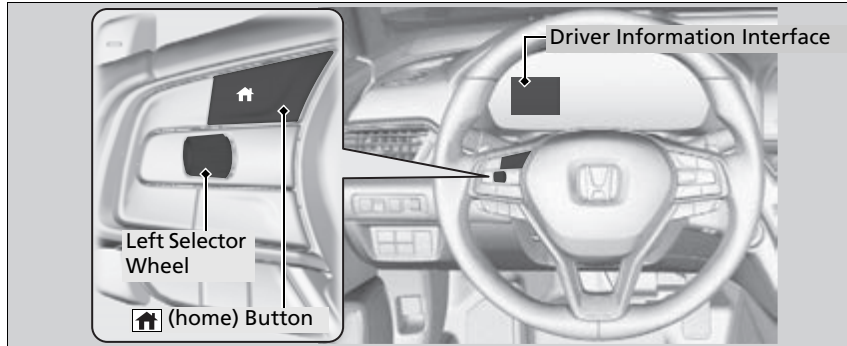

When you select **Driver Attention** on the driver information interface, bars on it light up in white to indicate the degree of the driver's attention.

▶ Accessing contents in the main display

P. 140

▶▶ Driver Attention Monitor

The Driver Attention Monitor cannot always detect if the driver is tired or inattentive. Regardless of the system's feedback, if you are feeling tired, stop in a safe location and rest for as long as needed.

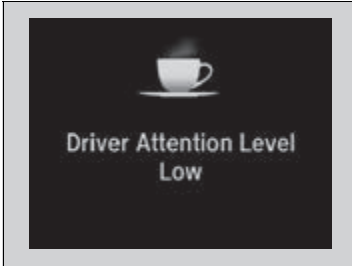

If two bars light up, the **Driver Attention Level Low** message will appear.

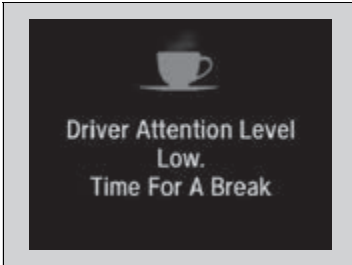

If one bar lights up, the **Driver Attention Level Low. Time For A Break** message will appear, a beep will sound, and the steering wheel will vibrate.

If this message appears, stop in a safe location and rest for as long as needed.

The message will disappear when the left selector wheel is pressed or when the system has determined that the driver is driving normally.

If the driver does not take a break and the monitor continues to detect that the driver is very tired, the message will appear again after approximately 15 minutes, accompanied by a beep and steering wheel vibrations.

The message does not appear when the traveling time is 30 minutes or less.

■ **The Driver Attention Monitor resets when:**

- The engine is turned off.
- The driver unfastens the seat belt and opens the door while the vehicle is stopped.

■ **For the Driver Attention Monitor to function:**

- The vehicle must be traveling above 25 mph (40 km/h).
- The electric power steering (EPS) system indicator must be off.

■ **Depending on driving conditions or other factors, the Driver Attention Monitor may not function in the following circumstances:**

- The steering assist function of the Lane Keeping Assist System (LKAS) is active.
 - **Lane Keeping Assist System (LKAS)** P. 486
- The condition of the road is poor, e.g. the surface is unpaved or bumpy.
- It is windy.
- The driver is frequently operating the vehicle in an assertive manner such as changing lanes or accelerating.

■ **Customizing**

You can change the Driver Attention Monitor settings. Select **Tactile And Audible Alert**, **Tactile Alert**, or **OFF**.

- **Customized Features** P. 351

►► For the Driver Attention Monitor to function:

The bars on the driver information interface remain grayed out unless the Driver Attention Monitor is functioning.

Driving Support Information

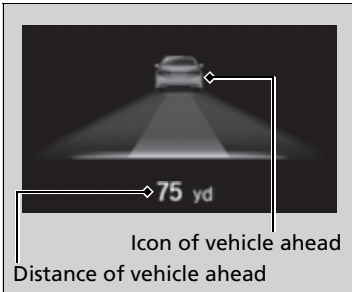

Shows the interval between your vehicle and the vehicle detected ahead.

Informs you whether ACC with Low Speed Follow and/or LKAS is activated or not. If ACC with Low Speed Follow is activated, the set following interval is displayed. If LKAS is activated, the displayed lane marks change to indicate that LKAS is activated.

❑ Adaptive Cruise Control (ACC) with Low Speed Follow P. 470

❑ Lane Keeping Assist System (LKAS) P. 486

When ACC and LKAS is in On Set Vehicle Interval



ACC on: The section behind the vehicle icon turns green.

LKAS on: The lane outlines appear on the display.

LKAS starts: The lane lines change to solid ones.

LKAS suspend: The lane lines change to dotted ones.

Driving Support Information

In case ACC with Low Speed Follow is not activated, when the distance between your vehicle and the vehicle ahead becomes too small, the section behind the vehicle icon turns amber and alerts you.

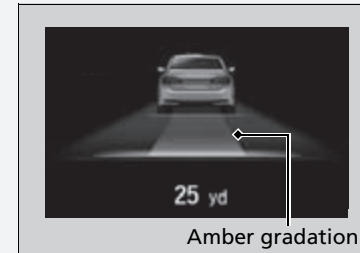

■ Safety Support

Indicates the status of RDM, CMBS™, Low Speed Braking Control* and the blind spot information system*, such as On, Off, or Failure, by color and letters.

The following colors indicate the status of any of the above mentioned systems:

- Green: The system is on.
- Gray: The system is off.
- Amber: There is a problem with the system.

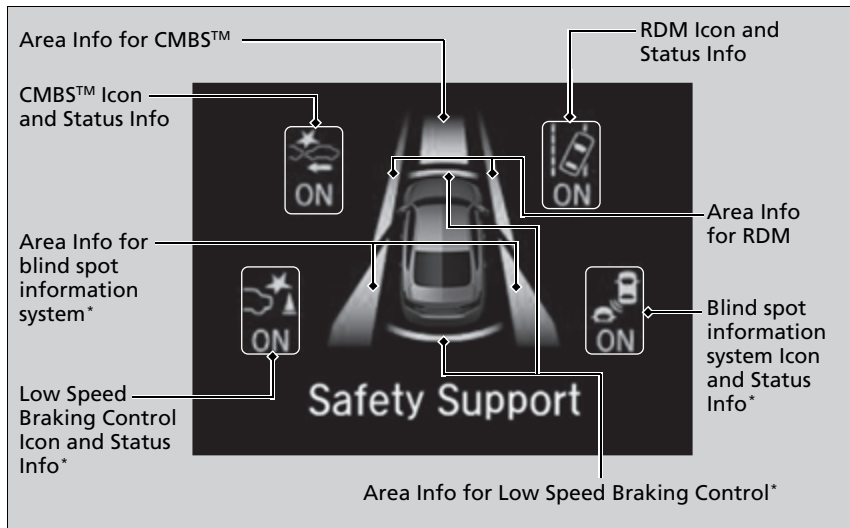

▶▶ Safety Support

If a system is indicated by the color amber, have your vehicle checked by a dealer immediately.

To turn on or off each system, first rotate the left selector wheel to switch displays. From the next display you can select which system to turn on or off.

- ▶▶ **RDM On and Off** P. 496
- ▶▶ **CMBS™ On and Off** P. 459
- ▶▶ **Blind spot information System On and Off** P. 452
- ▶▶ **System On and Off** P. 467

You can also confirm the status of each function by the color of the safety support indicator.

- ▶▶ **Safety Support Indicator (Amber)** P. 105
- ▶▶ **Safety Support Indicator (Green/Gray)** P. 108

Models with Low Speed Braking Control

Even when the Low Speed Braking Control icon is green, if the parking sensor is turned off for the rear only, the brake assist will not operate when reversing.

- ▶▶ **Turning off All Rear Sensors** P. 524

Head-Up Display*

Shows the current mode for ACC with Low Speed Follow and LKAS, tachometer, traffic sign recognition system, shift position indicator, **M** (sequential mode*/7-speed manual shift mode*) Indicator/Gear Selection Indicator, compass or turn-by-turn directions along with the vehicle speed. You can choose which item to be displayed using the  (HUD) button on the steering wheel. They are displayed when the power mode is in ON.

To turn the head-up display on and off: Press the **HUD** button on the driver side control panel.

The display can be moved up and down to become level with your eyes.

To raise or lower the head-up display: Press the  or  button until the desired position is reached.

Head-Up Display*

When you unlock and open the driver's door with a remote transmitter or keyless access system, the head-up display adjusts automatically to one of the two preset positions.

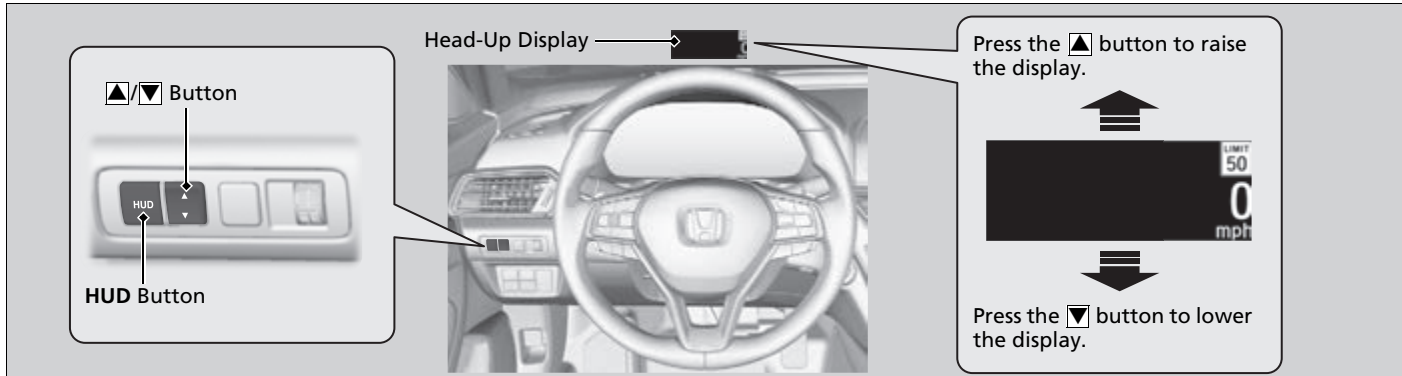

* Not available on all models

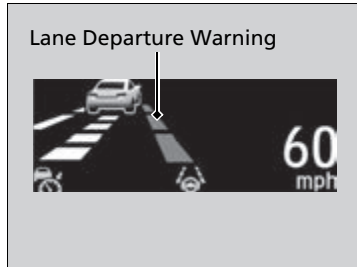

The display also shows the following warnings.

- **Lane Departure Warning:** When your vehicle is too close to the traffic lane lines, the lane departure warning appears.
 - ▣ **Lane Keeping Assist System (LKAS)**
P. 486
- **Head-up Warning Lights:** Flash when the **BRAKE** message appears on the driver information interface.
 - ▣ **Collision Mitigation Braking System™ (CMBS™)** P. 456
 - ▣ **Adaptive Cruise Control (ACC) with Low Speed Follow** P. 470
 - ▣ **Low Speed Braking Control*** P. 465

■ To Change Head-Up Display Content

Each time you press the  (HUD) button on the steering wheel, the head-up display content will change.

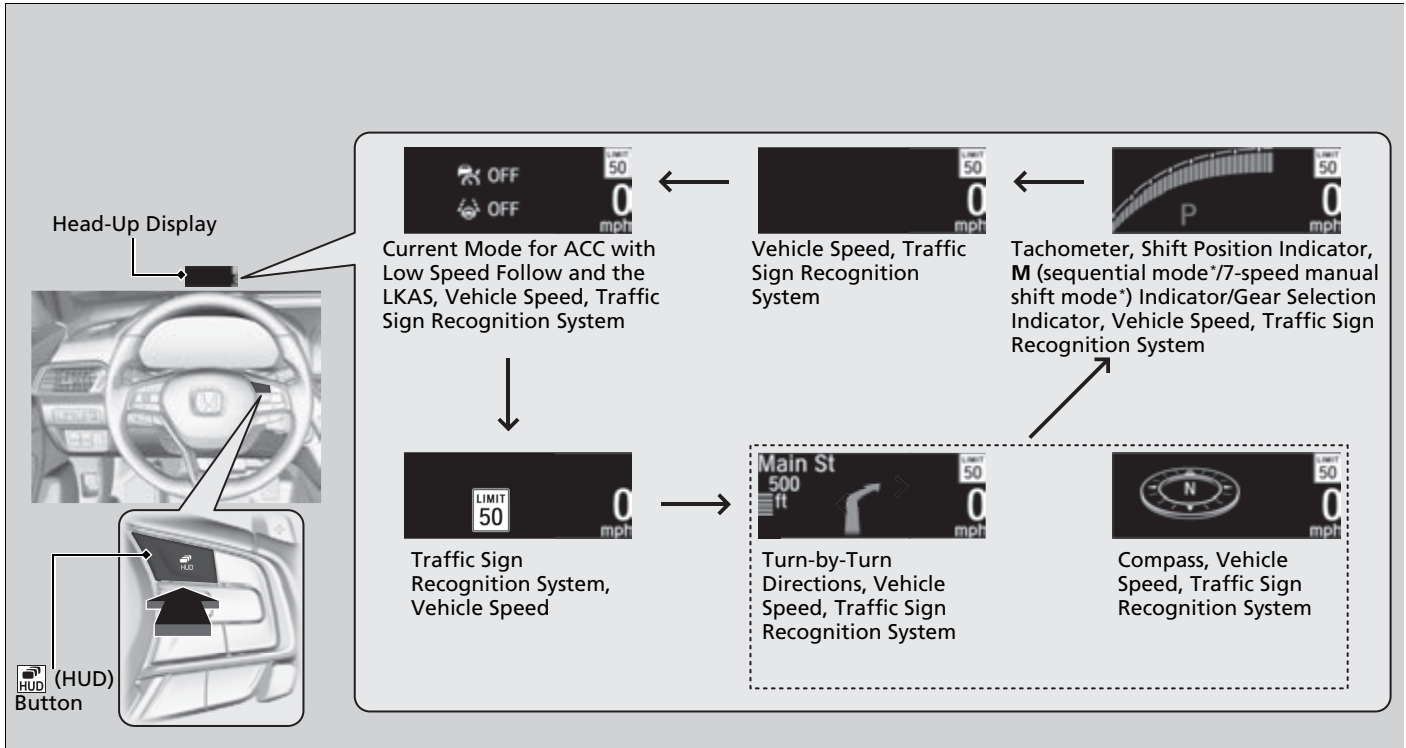

Instrument Panel

* Not available on all models

■ Vehicle Speed

Shows your driving speed in mph or km/h.

■ Tachometer

Shows the number of engine revolutions as a bar graph.

■ Shift Position Indicator

Shows the current shift position.

➤ **Shift Position Indicator** P. 88

■ M (sequential mode*/7-speed manual shift mode*) Indicator/Gear Selection Indicator

Shows the current mode for the sequential mode*/7-speed manual shift mode*.

■ Current Mode for ACC with Low Speed Follow and LKAS

Shows the current mode for ACC with Low Speed Follow and LKAS.

➤ **Adaptive Cruise Control (ACC) with Low Speed Follow** P. 470

➤ **Lane Keeping Assist System (LKAS)** P. 486

⌘ Vehicle Speed

Switch between mph and km/h by using the driver information interface or customized features on the audio/information screen.

➤ **Speed/Distance Units** P. 151

➤ **Customized Features** P. 351

■ Navigation

■ Compass

Shows the compass screen.

■ Turn-by-Turn Directions

When driving guidance is provided by the navigation system, Android Auto or Apple CarPlay, turn-by-turn directions to your destination appear.

➤ **Refer to the Navigation System Manual**

➤ **Android Auto** P. 320

➤ **Apple CarPlay** P. 313

■ Traffic Sign Recognition System

Shows the traffic sign recognition system.

➤ **Traffic Sign Recognition System** P. 498

☒ Navigation

You can select whether the turn-by-turn display comes on during the route guidance.

➤ **Customized Features** P. 351

Turn-by-turn directions may not be available for all apps.

This page intentionally left blank.

Controls

This chapter explains how to operate the various controls necessary for driving.



Clock	166
Locking and Unlocking the Doors	
Key	167
Low Keyless Remote Signal Strength ...	169
Locking/Unlocking the Doors from the Outside	170
Locking/Unlocking the Doors from the Inside	177
Childproof Door Locks	179
Auto Door Locking/Unlocking	180
Opening and Closing the Trunk	181
Security System	
Immobilizer System	184
Security System Alarm	185
Windows	187

Moonroof*	190
Operating the Switches Around the Steering Wheel	
ENGINE START/STOP Button.....	191
Turn Signals	194
Light Switches.....	195
Fog Lights*	197
Daytime Running Lights	198
Auto High-Beam	199
Wipers and Washers	202
Rear Defogger/Heated Door Mirror* Button	204

Canadian models	
Heated Windshield Button	204
Brightness Control	205
Driving Position Memory System*	207
Adjusting the Steering Wheel	209
Mirrors	
Interior Rearview Mirror	210
Power Door Mirrors	211
Seats	212
Interior Convenience Items	223
Climate Control System	
Using Automatic Climate Control	240
Automatic Climate Control Sensors ...	243

* Not available on all models

Adjusting the Clock



You can adjust the time manually in the audio/information screen, with the power mode in ON.

Adjusting the Time





1. Press the , then select **Settings**.
2. Select **System**.
3. Select **Day & Time**.
4. Select **Set Date & Time**.
5. Select **Automatic Date & Time**, then select **OFF**.

To adjust time:

6. Select **Set Time**.
7. Selecting /.
8. Select **Save** to set the time.

To adjust date:

6. Select **Set Date**.
7. Selecting /.
8. Select **Save** to set the date.





⌘ Clock

Models with navigation system

The clock is automatically updated through the navigation system, so the time does not need to be adjusted.

You can also adjust the clock by touching the clock displayed on the upper right corner of the display or the **Clock** icon on the home screen.

1. Touch the clock on the display.
The clock screen of the select face-type appears.
2. Select **Settings**.
3. Select **Day & Time**.
4. Select **Set Date & Time**.
5. Select **Automatic Date & Time**, then select **OFF**.
6. Select **Set Date** or **Set Time**.
7. Adjusting the dates, hours, and minutes by selecting /.
8. Select **Save** to set the time.

You can customize the clock display to show the 12 hour clock or 24 hour clock.

➤ **Customized Features** P. 351

You can customize the date display to MM/DD/YYYY, DD/MM/YYYY or YYYY/MM/DD.

➤ **Customized Features** P. 351

Locking and Unlocking the Doors

Key

This vehicle comes with the following keys:

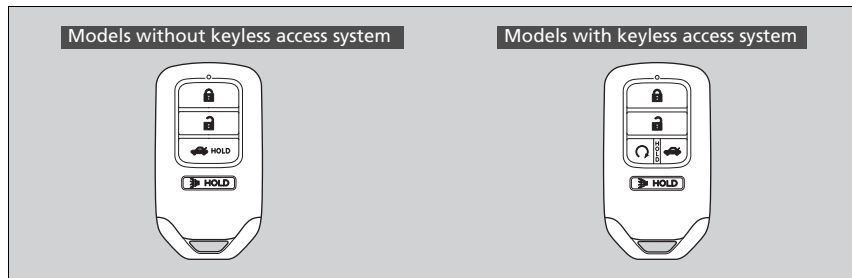

Use the key to start and stop the engine, lock and unlock all the doors and the fuel fill door, and open the trunk.

Key

All the keys have an immobilizer system. The immobilizer system helps to protect against vehicle theft.

➤ **Immobilizer System** P. 184

Follow the advice below to prevent damage to the keys:

- Do not leave the keys in direct sunlight, or in locations with high temperature or high humidity.
- Do not drop the keys or set heavy objects on them.
- Keep the keys away from liquids, dust and sand.
- Do not take the keys apart except for replacing the battery.

If the circuits in the keys are damaged, the engine may not start, and the remote transmitter may not work.

If the keys do not work properly, have them inspected by a dealer.

Models with remote engine starter

You can remotely start the engine using the keyless remote.

➤ **Remote Engine Start*** P. 414

* Not available on all models

■ Built-in Key

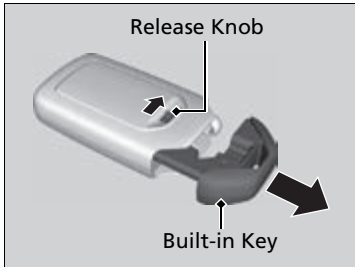

The built-in key can be used to lock/unlock the doors or open the trunk when the keyless remote battery becomes weak and the power door lock/unlock operation is disabled.

To remove the built-in key, slide the release knob and then pull out the key. To reinstall the built-in key, push the built-in key into the keyless remote until it clicks.

■ Key Number Tag

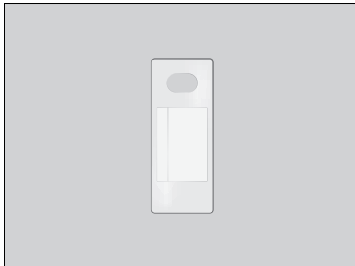

Contains a number that you will need if you purchase a replacement key.

▣ Key Number Tag

Keep the key number tag separate from the key in a safe place outside of your vehicle. If you wish to purchase an additional key, contact a dealer.

If you lose your key and you cannot start the engine, contact a dealer.

Low Keyless Remote Signal Strength

The vehicle transmits radio waves to locate the keyless remote to start the engine, lock and unlock* all the doors and the fuel fill door, and open* the trunk.

In the following cases, starting the engine, locking/unlocking* the doors/fuel fill door, or opening* the trunk may be inhibited or operation may be unstable:

- Strong radio waves are being transmitted by nearby equipment.
- You are carrying the keyless remote together with telecommunications equipment, laptop computers, cell phones, or wireless devices.
- A metallic object is touching or covering the keyless remote.

ⓘ Low Keyless Remote Signal Strength

Communication between the keyless remote and the vehicle consumes the keyless remote's battery.

Battery life is about two years, but this varies depending on regularity of use.

The battery is consumed whenever the keyless remote is receiving strong radio waves. Avoid placing it near electrical appliances such as televisions and personal computers.

* Not available on all models

Locking/Unlocking the Doors from the Outside

■ Using the Keyless Access System *

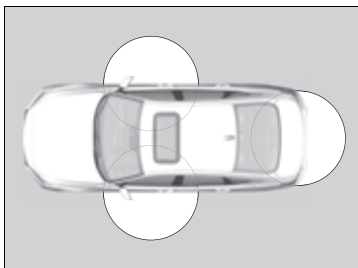

When you carry the keyless remote, you can lock/unlock the doors and fuel fill door, and open the trunk.

You can lock/unlock the doors, fuel fill door within a radius of about 32 inches (80 cm) of the outside door handle. You can open the trunk within about 32 inches (80 cm) radius from the trunk release button.

■ Locking the doors

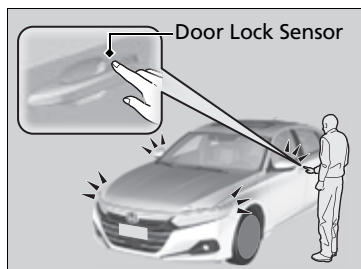

Touch the door lock sensor on the front door.

- ▶ Some exterior lights flash; the beeper sounds; all the doors and fuel fill door lock; and the security system sets.

▶ Locking/Unlocking the Doors from the Outside

If the interior light switch is in the door activated position, the interior light comes on when you unlock the doors.

No doors opened: The light fades out after 30 seconds.

Doors relocked: The light goes off immediately.

▶ **Interior Lights** P. 223

▶ Using the Keyless Access System *

If you do not open a door within 30 seconds of unlocking the vehicle with the keyless access system, the doors and trunk will automatically relock.

You can lock or unlock doors using the keyless access system only when the power mode is in VEHICLE OFF.

- Do not leave the keyless remote in the vehicle when you get out. Carry it with you.
- Even if you are not carrying the keyless remote, you can lock/unlock the doors while someone else with the keyless remote is within range.
- The door may be unlocked if the door handle is covered with water in heavy rain or in a car wash if the keyless remote is within range.
- If you grip a front door handle or touch a door lock sensor wearing gloves, the door sensor may be slow to respond or may not respond by unlocking or locking the doors.

■ Unlocking the doors and trunk

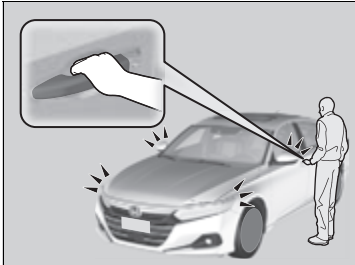

Grab the driver's door handle:

- ▶ The driver's door and fuel fill door unlocks.
- ▶ Some exterior lights flash twice and the beeper sounds twice.

Grab the front passenger's door handle:

- ▶ All the doors and fuel fill door unlock.
- ▶ Some exterior lights flash twice and the beeper sounds twice.

Press the trunk release button:

- ▶ The trunk unlocks and opens.
- ▶ A beeper will sound.

➤ **Using the Trunk Release Button*** P. 182

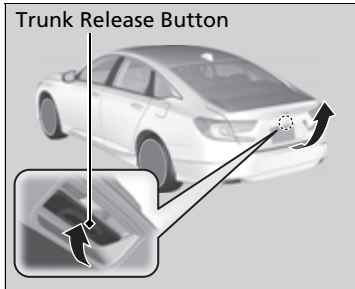

➤ Using the Keyless Access System*

- After locking the door, you have up to 2 seconds during which you can pull the door handle to confirm whether the door is locked. If you need to unlock the door immediately after locking it, wait at least 2 seconds before gripping the handle, otherwise the door will not unlock.
- The door might not open if you pull it immediately after gripping the door handle. Grip the handle again and confirm that the door is unlocked before pulling the handle.
- Even within the 32 inches (80 cm) radius, you may not be able to lock/unlock the doors with the keyless remote if it is above or below the outside handle.
- The keyless remote may not operate if it is too close to the door and door glass.

The light flash, beep and door unlock mode settings can be customized using the audio/information screen.

➤ **Customized Features** P. 351

* Not available on all models

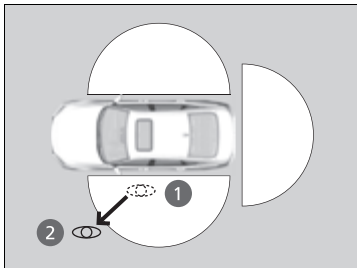
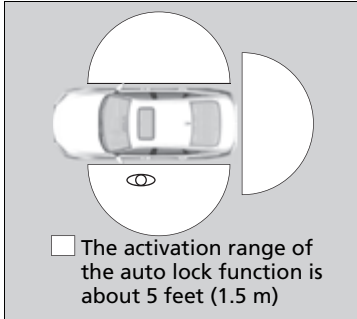

■ Locking the doors (Walk away auto lock®)

When you walk away from the vehicle with all doors closed while carrying the keyless remote, the doors will automatically lock. The auto lock function activates when all doors are closed, and the keyless remote is within about 5 feet (1.5 m) radius of the outside door handle.

Exit vehicle while carrying keyless remote and close door(s).

1. While within about 5 feet (1.5 m) radius of the vehicle.
 - ▶ The beeper sounds; the auto lock function will be activated.
2. Carry the keyless remote beyond about 5 feet (1.5 m) from the vehicle and remain outside this range for 2 or more seconds.
 - ▶ Some exterior lights flash; the beeper sounds; all doors will then lock.

▣ Locking the doors (Walk away auto lock®)

The auto lock function is set to OFF as the factory default setting. The auto lock function can be set to ON using the audio/information screen. If you set the auto lock function to ON using the audio/information screen, only the keyless remote that was used to unlock the driver's door prior to the setting change can activate auto lock.

▶ **Customized Features P. 351**

After the auto lock function has been activated, when you stay within the locking/unlocking operation range, the indicator on the keyless remote will continue to flash until the doors are locked.

When you stay beside the vehicle within the operation range, the doors will automatically lock approximately 30 seconds after the auto lock function activating beeper sounds.

When you open a door after the auto lock function activating beeper sounds, the auto lock function will be canceled.

Under the following circumstances, the auto lock function will not activate:

- The keyless remote is inside the vehicle.
 - ▶ The beeper will not sound.
- The keyless remote is taken out of its operational range before all the doors are closed.
 - ▶ The beeper will sound.

To temporarily deactivate the function:

1. Set the power mode to OFF.
2. Open the driver's door.
3. Using the master door lock switch, operate the lock as follows:
Lock → Unlock → Lock → Unlock.
▶ The beeper sounds and the function is deactivated.

To restore the function:

- Set the power mode to ON.
- Lock the vehicle without using the auto lock function.
- With the keyless remote on you, move out of the auto lock function operation range.
- Open any door.

⌘ Locking the doors (Walk away auto lock®)

The auto lock function does not operate when any of the following conditions are met.

- The keyless remote is inside the vehicle.
- A door or the hood is not closed.
- The power mode is set to any mode other than OFF.
- The keyless remote is not located within a radius of about 5 feet (1.5 m) from the vehicle when you get out of the vehicle and close the doors.

Auto lock function operation stop beeper

After the auto lock function has been activated, the auto lock operation stop beeper sounds for approximately two seconds in the following cases.

- The keyless remote is put inside the vehicle through a window.
- You are located too close to the vehicle.
- The keyless remote is put inside the trunk.

If the warning beeper sounds, check that you are carrying the keyless remote. Then, open/close a door and confirm the auto lock activation beeper sounds once.

■ Using the Remote Transmitter

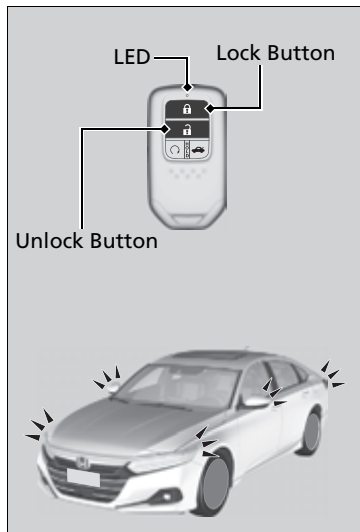

■ Locking the doors

Press the lock button.

Once:

- ▶ Some exterior lights flash, all the doors and fuel fill door lock, and the security system sets.

Twice (within five seconds after the first push):

- ▶ Some exterior lights flash, the beeper sounds and verifies the security system is set.

■ Unlocking the doors

Press the unlock button.

Once:

- ▶ Some exterior lights flash twice, and the driver's door and fuel fill door unlocks.

Twice:

- ▶ Some exterior lights flash twice, and the remaining doors unlock.

▶▶ Using the Remote Transmitter

If you do not open a door within 30 seconds of unlocking the vehicle with the remote transmitter, the doors will automatically relock.

You can change the relock timer setting.

▶ **Customized Features** P. 351

You can lock or unlock doors using the remote transmitter only when the power mode is in VEHICLE OFF.

The remote transmitter uses low-power signals, so the operating range may vary depending on the surroundings.

The remote transmitter will not lock the vehicle when a door is open.

If the distance at which the remote transmitter works varies, the battery is probably low.

If the LED does not come on when you press a button, the battery is dead.

▶ **Replacing the Remote Battery** P. 586

You can customize the door unlock mode setting.

▶ **Customized Features** P. 351

■ Locking/Unlocking the Doors Using a Key

If the lock or unlock button of the keyless remote does not work, use the key instead.

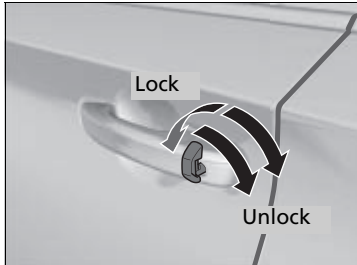

Fully insert the key and turn it.

☒ Locking/Unlocking the Doors Using a Key

When you lock the driver's door with a key, all the other doors and the fuel fill door lock at the same time. When unlocking, the driver's door unlocks first. Turn the key a second time within a few seconds to unlock the remaining doors.

You can customize the door unlock mode setting.

➤ **Customized Features** P. 351

■ Locking a Door Without Using a Key

If you do not have the key on you, or if for some reason you cannot lock a door using the key, you can lock the door without it.

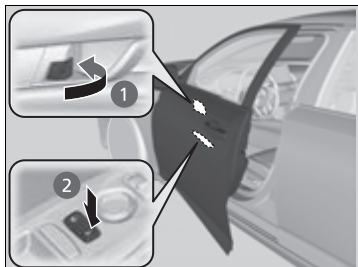

■ Locking the front doors

Push the lock tab forward ❶ or push the master door lock switch in the lock direction ❷, and close the door.

■ Locking the rear doors

Push the lock tab forward and close the door.

■ Lockout prevention system

The doors cannot be locked when the keyless remote is inside the vehicle.

▶▶ Locking a Door Without Using a Key

When you lock the driver's door or lock the passenger's door using the master door lock switch, all the other doors and the fuel fill door lock at the same time.

Before locking a door, make sure that the key is not inside the vehicle.

Locking/Unlocking the Doors from the Inside

■ Using the Lock Tab

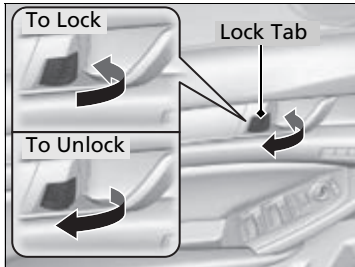

■ Locking a door

Push the lock tab forward.

■ Unlocking a door

Pull the lock tab rearward.

☒ Using the Lock Tab

When you lock the door using the lock tab on the driver's door, all of the other doors and the fuel fill door lock at the same time.

When you unlock the door using the lock tab on the driver's door, only the driver's door will unlock.

■ Unlocking Using the Front Door Inner Handle

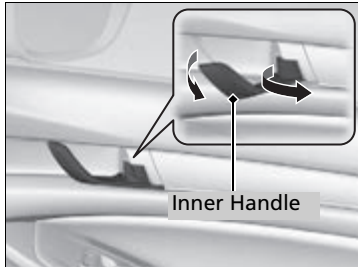

Pull the front door inner handle.

- ▶ The door unlocks and opens in one motion.

Unlocking and opening the driver's door from the inner handle unlocks all the other doors and the fuel fill door.

To avoid all the doors unlocking, use the lock tab on the driver's door to unlock, then lock again before opening the door.

- ▶ This setting works for one time only. If you do not want all the doors to unlock all the time, customize the **Auto Door Unlock** setting to **OFF** using the audio/information screen.

📖 **Customized Features** P. 351

📖 Unlocking Using the Front Door Inner Handle

The front door inner handles are designed to allow front seat occupants to open the door in one motion. However, this feature requires that front seat occupants never pull a front door inner handle while the vehicle is in motion.

Children should always ride in a rear seat where childproof door locks are provided.

📖 **Childproof Door Locks** P. 179

■ Using the Master Door Lock Switch

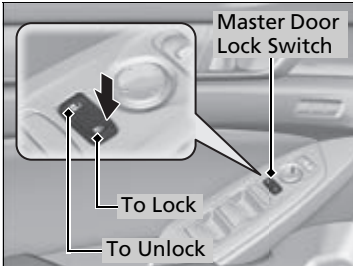

Press the master door lock switch in as shown to lock or unlock all the doors and the fuel fill door.

Childproof Door Locks

The childproof door locks prevent the rear doors from being opened from the inside regardless of the position of the lock tab.

■ Setting the Childproof Door Locks

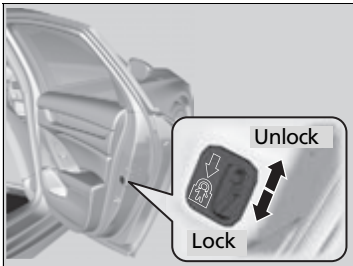

Slide the lever in the rear door to the lock position, and close the door.

■ When opening the door

Open the door using the outside door handle.

☒ Childproof Door Locks

To open the door from the inside when the childproof door lock is on, put the lock tab in the unlock position, lower the rear window, put your hand out of the window, and pull the outside door handle.

Auto Door Locking/Unlocking

Your vehicle locks or unlocks all doors automatically when a certain condition is met.

■ Auto Door Locking

■ Drive lock mode

All doors lock when the vehicle's speed reaches about 10 mph (15 km/h).

■ Auto Door Unlocking

■ Driver's door open mode

All doors unlock when the driver's door is opened.

▶▶ Auto Door Locking/Unlocking

You can turn off or change to another auto door locking/unlocking setting using the audio/information screen.

▶ **Customized Features** P. 351

Precautions for Opening/Closing the Trunk

■ Opening the trunk

Open the trunk all the way.

- ▶ If it is not fully opened, the trunk lid may begin to close under its own weight.

■ Closing the trunk

Keep the trunk lid closed while driving to:

- ▶ Avoid possible damage.
- ▶ Prevent exhaust gas from leaking into the vehicle.

🚨 **Exhaust Gas Hazard** P. 78

Using the Trunk Opener

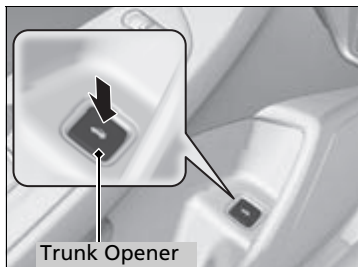

Press and hold the trunk opener on the driver's door to unlock and open the trunk.

🚨 **If You Cannot Open the Trunk** P. 628

Using the Trunk Release Button *

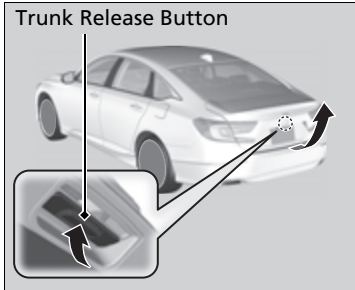

Push up the release button on the trunk lid after all the doors are unlocked.

▶ **If You Cannot Open the Trunk** P. 628

Even if the trunk is locked, you can open the trunk if you carry the keyless remote.

▶ Some exterior lights flash twice and the beeper sounds.

Using the Remote Transmitter

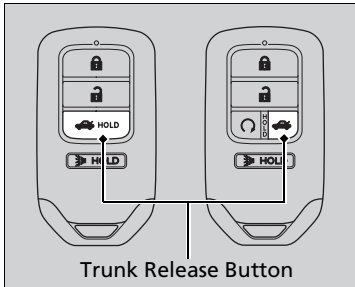

Press the trunk release button for approximately one second to unlock and open the trunk.

▶▶ Using the Trunk Release Button *

- If you forget the keyless remote inside, the beeper will sound and the trunk will not close.
- A person who is not carrying the keyless remote can unlock the trunk if a person who is carrying it is within range.
- If the beeper sounds after you close the trunk, move the keyless remote away from the trunk and close again.
- The keyless remote may not operate if it is too close to the trunk.

▶▶ Using the Remote Transmitter

If the driver's door is locked, the trunk will automatically lock when you close it. Otherwise, you will have to lock it manually.

Trunk Main Switch*

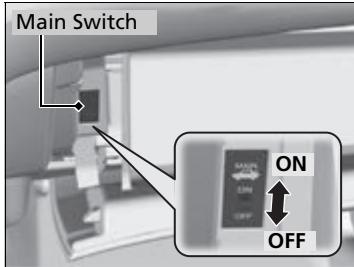

The trunk main switch disables the trunk release button on the remote transmitter and the trunk release button on the trunk lid and trunk opener on the driver's door to protect luggage in the trunk.

1. Make sure the rear seat-back is not folded down.
2. Turn off the trunk main switch in the glove box.
3. Lock the glove box.

Emergency Trunk Opener

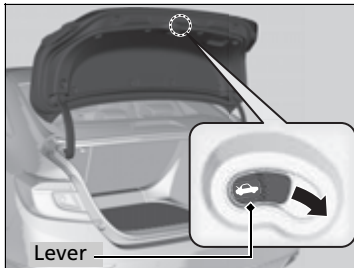

The trunk release lever allows you to open the trunk from inside for your safety.

Slide the release lever in the direction of the arrow.

Trunk Main Switch*

If you need to give the key to someone else, remove the built-in key from the keyless remote by sliding the release knob, and give the keyless remote as a valet key.

Emergency Trunk Opener

Parents should decide if their children should be shown how to use this feature.

* Not available on all models

Immobilizer System

This system prevents a key that has not been pre-registered from starting the engine.

Pay attention to the following when pressing the **ENGINE START/STOP** button:

- Do not allow objects that emit strong radio waves near the **ENGINE START/STOP** button.
- Make sure the key is not covered by or touching a metal object.
- Do not bring a key from another vehicle's immobilizer system near the **ENGINE START/STOP** button.

Do not put the key near magnetic items. Electronic device, such as televisions and audio systems emit strong magnetic fields. Note that even a key chain can become magnetic.

Immobilizer System

NOTICE

Leaving the key in the vehicle can result in theft or accidental movement of the vehicle. Always take the key with you whenever you leave the vehicle unattended.

Do not alter the system or add other devices to it. Doing so may damage the system and make your vehicle inoperable.

Canadian models

Apply and hold the brake pedal before turning the vehicle on the first time after the battery has been disconnected.

Security System Alarm

The security system alarm activates when the trunk, hood or doors are forcibly opened. The alarm does not activate if the trunk or doors are opened with the key, remote transmitter, or keyless access system*.

However, the alarm activates if a door is opened with the key and then the transmission is taken out of [P] (continuously variable transmission models) or the hood is opened before the power mode is in ON.

■ When the security system alarm activates

The horn sounds intermittently, and some exterior lights flash.

■ To deactivate the security system alarm

Unlock the vehicle using the key, remote transmitter or keyless access system*, or set the power mode to ON. The system, along with the horn and flashing lights, is deactivated.

■ Setting the security system alarm

The security system alarm automatically sets when the following conditions have been met:

- The power mode is set to VEHICLE OFF.
- The hood is closed.
- All doors and trunk are locked from outside with the key, remote transmitter, or keyless access system*.

■ When the security system alarm sets

The security system alarm indicator in the instrument panel blinks and the blinking interval changes after about 15 seconds.

■ To cancel the security system alarm

The security system alarm is canceled when the vehicle is unlocked using the key, remote transmitter or keyless access system*, or when the power mode is set to ON. The security system alarm indicator goes off at the same time.

* Not available on all models

Continued

⌘ Security System Alarm

Do not alter the system or add other devices to it. Doing so may damage the system and make your vehicle inoperable.

The security system alarm continues for a maximum of two minutes until the security system alarm deactivates.

Do not set the security system alarm when someone is in the vehicle or a window is open. The system can accidentally activate when:

- Unlocking the door with the lock tab.
- Opening the trunk with the trunk opener or the emergency trunk opener.
- Opening the hood with the hood release.

Continuously variable transmission models

- Taking the transmission out of [P].

If the battery goes dead after you have set the security system alarm, the security alarm may go off once the battery is recharged or replaced. If this occurs, deactivate the security system alarm by unlocking a door using the key, remote transmitter, or keyless access system*.

■ Panic Mode

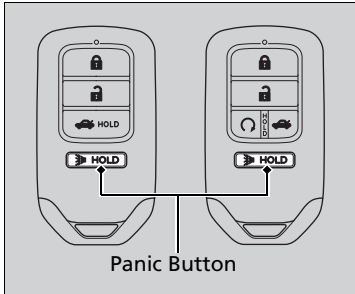

■ The panic button on the remote transmitter

If you press the panic button for approximately one second, the following will occur for about 30 seconds:

- The horn sounds.
- Some exterior lights flash.

■ Canceling panic mode

- Press any button on the remote transmitter.
- Set the power mode to ON.

Opening/Closing the Power Windows

The power windows can be opened and closed when the power mode is in ON, using the switches on the doors.

The driver's side switches can be used to open and close all the windows. The power window lock button on the driver's side must be switched off (indicator off) to open and close the windows from anywhere other than the driver's seat.

When the power window lock button is pressed, the indicator comes on and you can only operate the driver's window. Turn the power window lock button on (indicator on) if a child is in the vehicle.

Opening/Closing the Windows with Auto-Open/Close Function

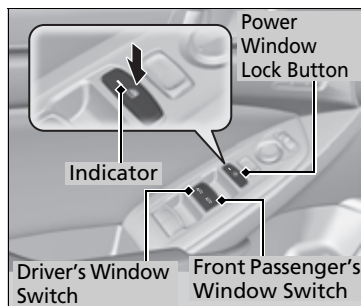

Manual operation

To open: Push the switch down lightly, and hold it until the desired position is reached.

To close: Pull the switch up lightly, and hold it until the desired position is reached.

Automatic operation

To open: Push the switch down firmly.

To close: Pull the switch up firmly.

The window opens or closes completely. To stop the window at any time, push or pull the switch briefly.

Windows

WARNING

Closing a power window on someone's hands or fingers can cause serious injury.

Make sure your passengers are away from the windows before closing them.

The power windows can be operated for up to 10 minutes after you set the power mode to VEHICLE OFF. Opening either front door cancels this function.

Auto Reverse

If a power window senses resistance when closing automatically, it will stop closing and reverse direction.

The driver's window auto reverse function is disabled when you continuously pull up the switch.

The auto reverse function stops sensing when the window is almost closed to ensure that it fully closes.

While driving with any of the windows open, you may hear a booming, throbbing, or helicopter-type noise or pressure. This is called wind buffeting. This is a normal occurrence that can be minimized.

If you hear a wind buffeting noise with any of the windows open, lower all of the other windows slightly or open the moonroof*.

* Not available on all models

■ Opening/Closing the Windows without Auto-Open/Close Function

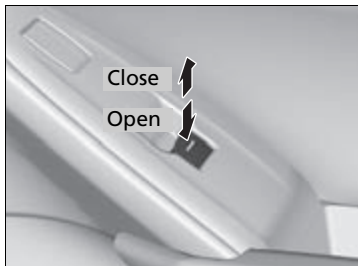

To open: Push the switch down.

To close: Pull the switch up.

Release the switch when the window reaches the desired position.

■ Opening the Windows with the Keyless Remote

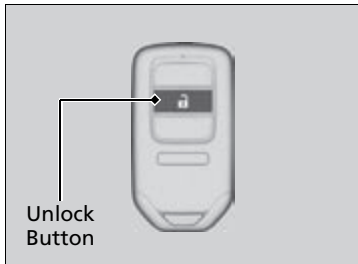

To open: Press the unlock button, and then within 10 seconds, press it again and hold it.

If the windows stop midway, repeat the procedure.

» Opening the Windows with the Keyless Remote

Models with moonroof

If you open the windows with the keyless remote, the moonroof will open automatically along with them.

■ Opening/Closing the Windows with the Key

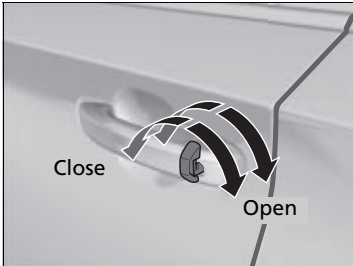

To open: Unlock the driver's door with the key. Within 10 seconds of returning the key to the central position, turn the key in the unlock direction and hold it there.

To close: Lock the driver's door with the key. Within 10 seconds of returning the key to the central position, turn the key in the lock direction and hold it there.

Release the key to stop the windows at the desired position. If you want further adjustment, repeat the same operation.

☒ Opening/Closing the Windows with the Key

Models with moonroof

If you open/close the windows with the key, the moonroof will open/close automatically along with them.

Opening/Closing the Moonroof

You can operate the moonroof when the power mode is in ON. Use the switch in the front of the ceiling to open and close the moonroof.

■ Using the Moonroof Switch

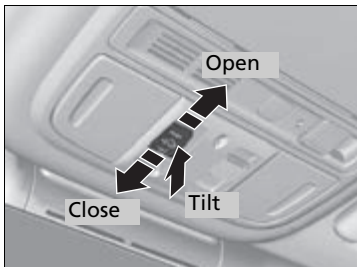

■ Automatic operation

To open: Pull the switch back firmly.

To close: Push the switch forward firmly.

The moonroof automatically opens or closes all the way. To stop the moonroof midway, pull or push the switch briefly.

■ Manual operation

To open: Pull the switch back lightly, and hold it until the desired position is reached.

To close: Push the switch forward lightly, and hold it until the desired position is reached.

■ Tilting the moonroof up

To tilt: Push on the center of the moonroof switch.

To close: Push the switch forward firmly, then release.

☒ Moonroof*

⚠ WARNING

Opening or closing the moonroof on someone's hands or fingers can cause serious injury.

Make sure all hands and fingers are clear of the moonroof before opening or closing it.

NOTICE

Opening the moonroof in below freezing temperature or when it is covered with snow or ice can damage the moonroof panel or motor.

The moonroof can be operated for up to 10 minutes after you set the power mode to OFF. Opening either front door cancels this function.

When resistance is detected, the auto reverse function causes the moonroof to change directions, then stop. Auto reverse stops sensing when the moonroof is almost closed to ensure that it fully closes. Make sure that all objects, including fingers, are clear of the moonroof.

You can use the remote transmitter or the key to operate the moonroof.

☒ **Opening the Windows with the Keyless Remote** P. 188

☒ **Opening/Closing the Windows with the Key** P. 189

ENGINE START/STOP Button

Changing the Power Mode

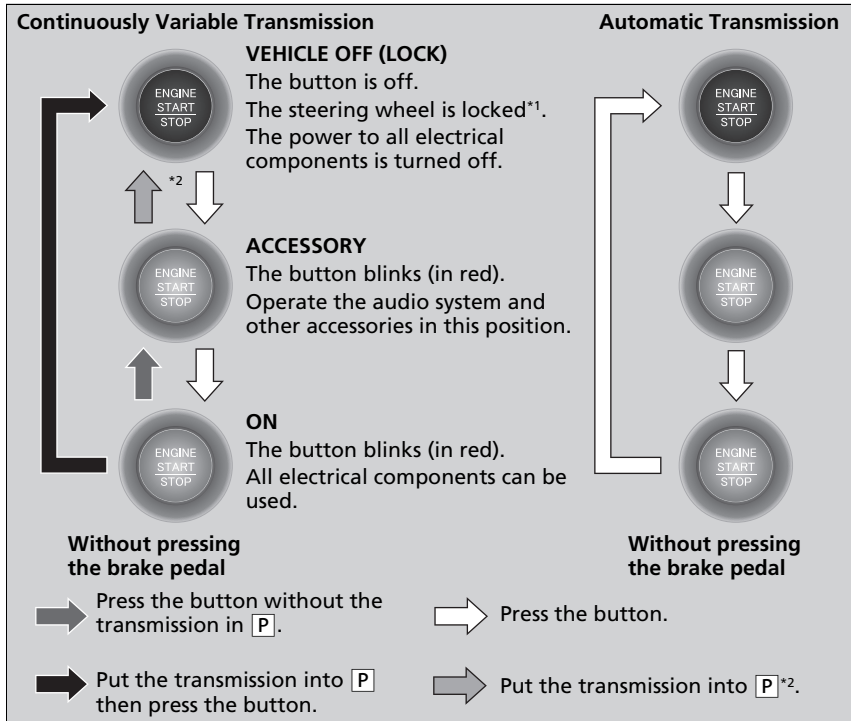

*1: Continuously variable transmission models for Canadian models

*2: U.S. models

ENGINE START/STOP Button

ENGINE START/STOP Button Operating Range

You can start the engine when the keyless remote is inside the vehicle.

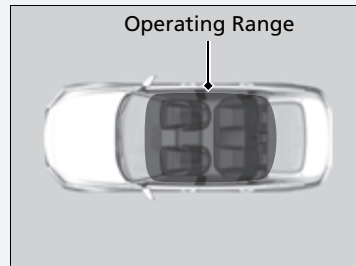

If the battery of the keyless remote is getting low, the engine may not start when you push the **ENGINE START/STOP** button. If the engine does not start, refer to the following link.

☒ If the Keyless Remote Battery is Weak

P. 604

The engine may also run if the keyless remote is close to the door or window, even if it is outside the vehicle.

ON mode:

The **ENGINE START/STOP** button is red when the engine is running.

Automatic Power Off

If you leave the vehicle for 30 to 60 minutes with the transmission in **P** and the power mode in ACCESSORY, the vehicle automatically goes into the mode similar to VEHICLE OFF (LOCK) to avoid draining the battery.

Continuously variable transmission models
for Canadian models

When in this mode:

The steering wheel does not lock.

You cannot lock or unlock doors with the remote transmitter or the keyless access system.

Press the **ENGINE START/STOP** button twice to switch the mode to VEHICLE OFF (LOCK).

Power Mode Reminder

If you open the driver's door when the power mode is set to ACCESSORY, a warning buzzer sounds.

Changing the Power Mode

Continuously variable transmission models
for Canadian models

If the power mode does not change from VEHICLE OFF to ACCESSORY, press the **ENGINE START/STOP** button while moving the steering wheel left and right. The steering wheel will unlock, allowing the mode to change.

Do not leave the power mode in ACCESSORY or ON when you get out.

■ Keyless Remote Reminder

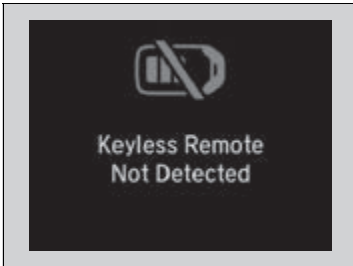

When the power mode is set to any mode other than OFF and you remove the keyless remote from the vehicle and shut the door, an alarm will sound. If the alarm continues to sound, place the keyless remote in another location.

■ When the power mode is in ACCESSORY

The alarm will sound from outside the vehicle.

■ When the power mode is in ON

An alarm will sound both inside and outside the vehicle. In addition, a warning indicator will appear on the instrument panel.

⊠ Keyless Remote Reminder

When the keyless remote is within the system's operational range, and the driver's door is closed, the warning function cancels.

If the keyless remote is taken out of the vehicle after the engine has been started, you can no longer change the **ENGINE START/STOP** button mode or restart the engine. Always make sure if the keyless remote is in your vehicle when you operate the **ENGINE START/STOP** button.

Removing the keyless remote from the vehicle through a window does not activate the warning buzzer.

Do not put the keyless remote on the dashboard or in the glove box. It may cause the warning buzzer to go off. Under some other conditions that can prevent the vehicle from locating the keyless remote, the warning buzzer may also go off even if the keyless remote is within the system's operational range.

Turn Signals

The turn signals can be used when the power mode is in ON.

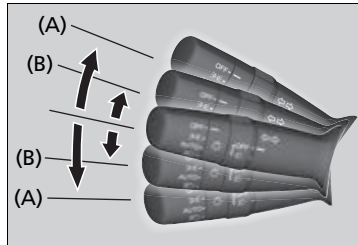

■ (A): Turn signal

Push the lever up or down based on the direction you want to turn, and the turn signal will blink.

■ (B): One-touch turn signal

When you lightly push the lever up or down and release it, the turn signal will blink 3 times.

▶▶ Turn Signals

The turn signal indicator on the instrument panel will blink when the external turn signal blinks.

▶▶ Indicators P. 82

Light Switches

Manual Operation

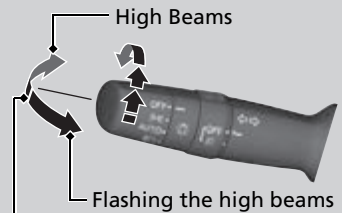

U.S. models



High Beams

Flashing the high beams

Low Beams

-  Turns on parking, side marker, tail, and rear license plate lights
-  Turns on headlights, parking, side marker, tail, and rear license plate lights

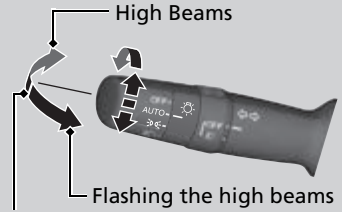

Canadian models



High Beams

Flashing the high beams

Low Beams

-  Turns on parking, side marker, tail, and rear license plate lights
-  Turns on headlights, parking, side marker, tail, and rear license plate lights

Rotating the light switch turns the lights on and off, regardless of the power mode setting.

High beams

Push the lever forward until you hear a click.

Low beams

When in high beams, pull the lever back to return to low beams.

Flashing the high beams

Pull the lever back, and release it.

Canadian models

Lights off

Turn the lever to OFF either when:

- The transmission is in **P**.
- The parking brake is applied.

To turn the lights on again, turn the lever to OFF to cancel the lights off mode. Even if you do not cancel the lights off mode, the lights come on automatically when:

- The transmission is taken out of **P** and the parking brake is released.
- The vehicle starts to move.

Light Switches

If you leave the power mode in VEHICLE OFF while the lights are on, a chime sounds when the driver's door is opened.

When the lights are on, the lights on indicator in the instrument panel will be on.

Lights On Indicator P. 97

Do not leave the lights on when the engine is off because it will cause the battery to discharge.

If you sense that the level of the headlights is abnormal, have the vehicle inspected by a dealer.

Automatic Operation (automatic lighting control)

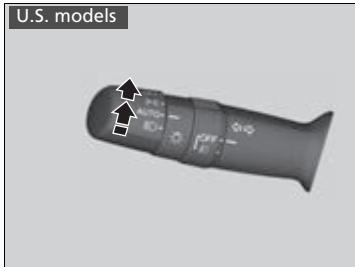

Automatic lighting control can be used when the power mode is in ON.

When the light switch is in **AUTO**, the headlights and other exterior lights will switch on and off automatically depending on the ambient brightness.

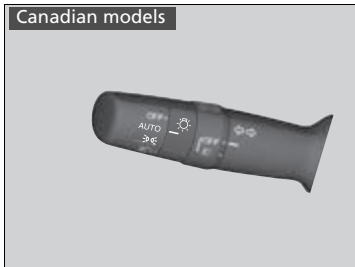

The headlights comes on when you unlock a door in dark areas with the headlight switch in **AUTO**.

- ▶ Once you lock the door, the headlights will go off.

Automatic Operation (automatic lighting control)

We recommend that you turn on the lights manually when driving at night, in a dense fog, or in dark areas such as long tunnels or parking facilities.

The light sensor is in the location shown below. Do not cover this light sensor with anything; otherwise, the automatic lighting system may not work properly.

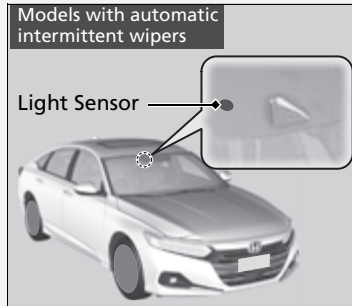
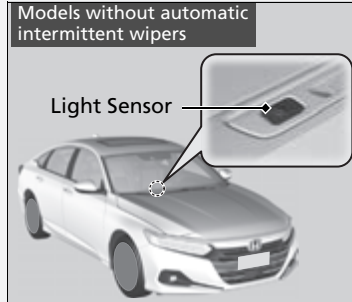

■ Headlight Integration with Wipers

The headlights automatically come on when the wipers are used several times within a certain number of intervals with the headlight switch in **AUTO**.
The headlights automatically go off a few minutes later if the wipers are stopped.

■ Automatic Lighting Off Feature

The headlights, all other exterior lights, and the instrument panel lights turn off 15 seconds after you set the power mode to VEHICLE OFF, take the keyless remote with you, and close the driver's door.

If you set the power mode to VEHICLE OFF with the headlight switch on, but do not open the door, the lights turn off after 10 minutes (three minutes, if the switch is in the **AUTO** position).

The lights turn on again when you unlock or open the driver's door. If you unlock the door, but do not open it within 15 seconds, the lights go off. If you open the driver's door, you will hear a reminder chime alerting you that the lights are on.

Fog Lights *

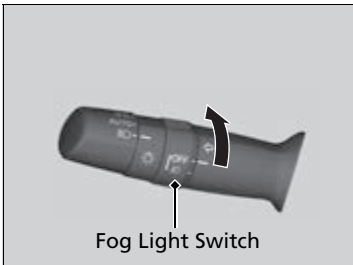

When the low beam headlights are on, turn the fog light switch on to use the fog lights.

* Not available on all models

⌘ Automatic Operation (automatic lighting control)

U.S. models

You can adjust the auto light sensitivity as follows:

Setting	The exterior lights come on when the ambient light is at
Max	
High	
Mid	
Low	
Min	

➤ **Customized Features** P. 351

⌘ Headlight Integration with Wipers

This feature activates while the headlights are off in **AUTO**.

The instrument panel brightness does not change when the headlights come on.

At dark ambient light levels, the automatic lighting control feature turns on the headlights, regardless of the number of wiper sweeps.

⌘ Automatic Lighting Off Feature

You can change the headlight auto off timer setting.

➤ **Customized Features** P. 351

Daytime Running Lights

The parking/daytime running lights come on when the following conditions have been met:

- The power mode is in ON.
- The headlight switch is off, or in .
- The parking brake is released.

The lights remain on even if you set the parking brake. Setting the power mode to VEHICLE OFF will turn off the daytime running lights.

The daytime running lights are off once the headlight switch is turned on, or when the head light switch is in **AUTO** and it is getting darker outside.

Auto High-Beam

The front sensor camera detects the light sources ahead of the vehicle such as the lights of a preceding or oncoming vehicle, or street lights. When you are driving at night, the system automatically switches the headlights between low beam and high beam depending on the situation.

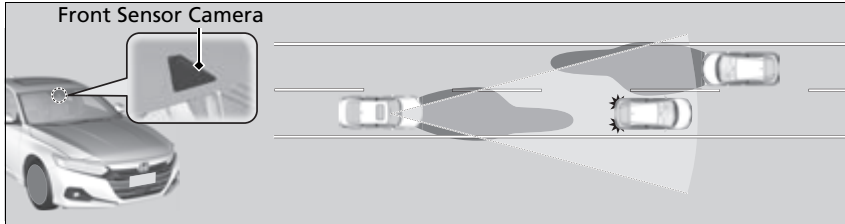

How to Use the Auto High-Beam

When all of the following conditions have been met, the auto high-beam indicator comes on and the auto high-beam is activated.

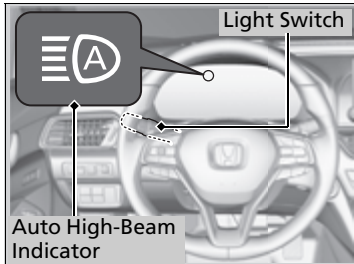

- The power mode is in ON.
- The light switch is in **AUTO**.
- The lever is in the low beam position.
- The headlights have been automatically activated.
- It is dark outside the vehicle.

If the auto high-beam indicator does not come on even when all the conditions have been met, carry out the following procedure and the indicator will come on.

- Pull the lever toward you for flashing the high beams then release it while driving.

Auto High-Beam

The auto high-beam system does not always operate in every situation. This system is just for assisting the driver. Always observe your surroundings and switch the headlights between high beam and low beam manually if necessary.

If you find the timing of beam changes inconvenient for driving, change the headlight beams manually.

The range and the distance at which the camera can recognize varies depending on conditions surrounding your vehicle.

Regarding the handling of the camera mounted to the inside of the windshield, refer to the following.

Front Sensor Camera P. 504

For the auto high-beam to work properly:

- Do not place an object that reflects light on the dashboard.
- Keep the windshield around the camera clean.
- When cleaning the windshield, be careful not to apply the windshield cleanser to the camera lens.
- Do not attach an object, sticker or film to the area around the camera.
- Do not touch the camera lens.

If the camera receives a strong impact, or repairing of the area near the camera is required, consult a dealer.

■ Automatic switching between high-beam and low-beam

When auto high-beam is active, the headlights switch between high beam and low beam based on the following conditions.

Switching to high beam:

All of the following conditions must be met before the high beams turn on.

- Your vehicle speed is 25 mph (40 km/h) or more.
- There are no preceding or oncoming vehicle with headlights or taillights turned on.
- There are few street lights on the road ahead.



Switching to low beam:

One of the following conditions must be met before the low beams turn on.

- Your vehicle speed is 15 mph (24 km/h) or less.
- There is a preceding or oncoming vehicle with headlights or taillights turned on.
- There are many street lights on the road ahead.

■ Manual switching between high-beam and low-beam

If you want to manually switch the headlights between high beam and low beam, follow either of the procedures below. Note that when you do this, the auto high-beam indicator will turn off and the auto high-beam will be deactivated.

Using the lever:

Pull the lever toward you for flashing the high beams then release it within about one second while driving.

- ▶ To reactivate the auto high-beam, pull the lever toward you for flashing the high beams then release it while driving. The auto high-beam indicator will come on.

Using the light switch:

Turn the light switch to .

- ▶ To reactivate the auto high-beam, turn the light switch to **AUTO** when the lever is in the low beam position, the auto high-beam indicator will come on.

⌘ How to Use the Auto High-Beam

In the following cases, the auto high-beam system may not switch the headlights properly or the switching timing may be changed. In case of the automatic switching operation does not fit for your driving habits, please switch the headlights manually.

- The brightness of the lights from the preceding or oncoming vehicle is intense or poor.
- Visibility is poor due to the weather (rain, snow, fog, windshield frost, etc.).
- Surrounding light sources, such as street lights, electric billboards and traffic lights are illuminating the road ahead.
- The brightness level of the road ahead constantly changes.
- The road is bumpy or has many curves.
- A vehicle suddenly appears in front of you, or a vehicle in front of you is not in the preceding or oncoming direction.
- Your vehicle is tilted with a heavy load in the rear.
- A traffic sign, mirror, or other reflective object ahead is reflecting strong light toward the vehicle.
- The oncoming vehicle frequently disappears under roadside trees or behind median barriers.
- The preceding or oncoming vehicle is a motorcycle, bicycle, mobility scooter, or other small vehicle.

The auto high-beam system keeps the headlight low beam when:

- Windshield wipers are operating at a high speed.
- The camera has detected a dense fog.

■ How to Turn Off the Auto High-Beam

You can turn the auto high-beam system off. If you want to turn the system off or on, set the power mode to ON, then carry out the following procedures while the vehicle is stationary.

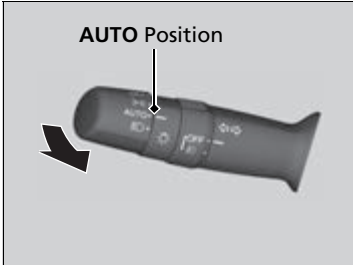

To turn the system off:

With the light switch is in **AUTO**, pull the lever toward you and hold it for at least 40 seconds. After the auto high-beam indicator light blinks twice, release the lever.

To turn the system on:

With the light switch is in **AUTO**, pull the lever toward you and hold it for at least 30 seconds. After the auto high-beam indicator light blinks once, release the lever.

☒ How to Use the Auto High-Beam

If the **Some Driver Assist Systems Cannot Operate: Camera Temperature Too High** message appears:

- Use the climate control system to cool down the interior and, if necessary, also use defroster mode with the airflow directed toward the camera.
- Start driving the vehicle to lower the windshield temperature, which cools down the area around the camera.

If the **Some Driver Assist Systems Cannot Operate: Clean Front Windshield** message appears:

- Park your vehicle in a safe place, and clean the windshield. If the message does not disappear after you have cleaned the windshield and driven for a while, have your vehicle checked by a dealer.

☒ How to Turn Off the Auto High-Beam

If you turn the auto high-beam system off, the system does not operate until you turn the system on.

Park in a safe place before turning the system off or on.

Wipers and Washers

■ Windshield Wiper/Washer

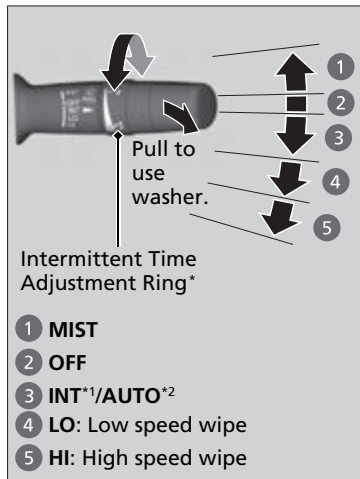

- 1 MIST
- 2 OFF
- 3 INT*¹/AUTO*²
- 4 LO: Low speed wipe
- 5 HI: High speed wipe

The windshield wipers and washers can be used when the power mode is in ON.

■ MIST

The wipers run at high speed until you release the lever.

■ Wiper switch (OFF, INT*¹/AUTO*², LO, HI)

Move the lever up or down to change the wiper settings.

■ Adjusting wiper operation*

Turn the adjustment ring to adjust the wiper operation.

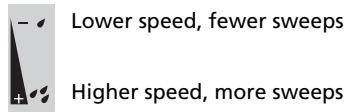

■ Washer

Sprays while you pull the lever toward you.

When you release the lever for more than one second, the spray stops, the wipers sweep two or three more times to clear the windshield, then stop.

*1: Models with manual intermittent operation
 *2: Models with automatic intermittent operation

* Not available on all models

» Wipers and Washers

NOTICE

Do not use the wipers when the windshield is dry. The windshield will get scratched, or the rubber blades will get damaged.

NOTICE

Turn the washers off if no washer fluid comes out. The pump may get damaged.

The wiper motor may stop motor operation temporarily to prevent an overload. Wiper operation will return to normal within a few minutes, once the circuit has returned to normal.

Models with intermittent time adjustment ring

If the vehicle speeds up while the wipers are operating intermittently, the length of the wipe interval shortens.

When the vehicle speeds up, the wiper operation's shortest delay setting (👉) and the LO setting become the same.

NOTICE

In cold weather, the blades may freeze to the windshield.

Operating the wipers in this condition may damage the wipers. Use the defogger or heated windshield* to warm the windshield, then turn the wipers on.

■ Automatic Intermittent Wipers *

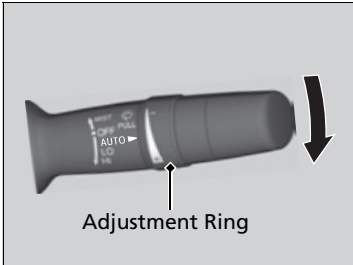

When you push the lever down to **AUTO**, the windshield wipers sweep once, and go into the automatic mode.

The wipers operate intermittently, at low speed, or at high speed and stop in accordance with the amount of rainfall the rainfall sensor detects.

■ AUTO sensitivity adjustment

When the wiper function is set to **AUTO**, you can adjust the sensitivity of the rainfall sensor (using the adjustment ring) so that wipers will operate in accordance with your preference.

Sensor sensitivity

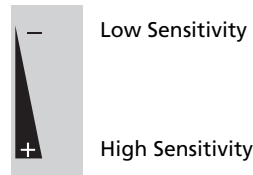

▶▶ Wipers and Washers

If the wipers stop operating due to an obstacle such as the buildup of snow, park the vehicle in a safe place.

Rotate the wiper switch to **OFF**, and set the power mode to ACCESSORY or VEHICLE OFF, then remove the obstacle.

▶▶ Automatic Intermittent Wipers *

The rainfall sensor is in the location shown below.

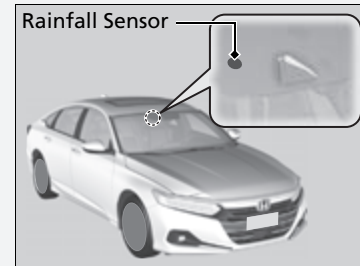

NOTICE
AUTO should always be turned **OFF** before the following situations in order to prevent severe damage to the wiper system:

- Cleaning the windshield
- Driving through a car wash
- No rain present

* Not available on all models

Rear Defogger/Heated Door Mirror* Button

Press the rear defogger and heated door mirror button to defog the rear window and mirrors when the power mode is in ON.

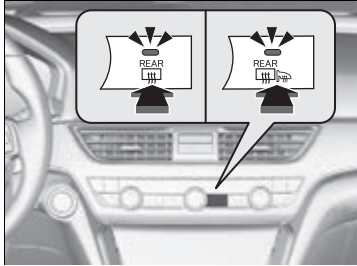

The rear defogger and heated door mirror automatically switch off after 10-30 minutes depending on the outside temperature. However, if the outside temperature is 32°F (0°C) or below, it does not automatically switch off.

▶▶ Rear Defogger/Heated Door Mirror* Button

This system consumes a lot of power, so turn it off when the window has been defogged. Also, do not use the system for a long time while the engine is idling. This may weaken the battery, making it difficult to start the engine.

Models with heated door mirror

When the power mode is set to ON and the outside temperature is below 41°F (5°C), the heated door mirror may automatically activate for 10 minutes.

Canadian models

Heated Windshield Button

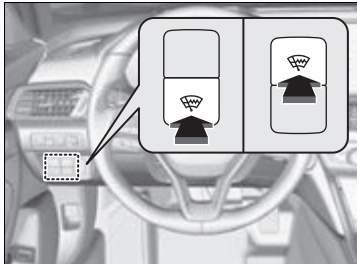

Press the heated windshield button to deice the windshield at the wiper park area and along the driver side edge of the windshield when the power mode is in ON. The heated windshield will automatically switch off after 15 minutes.

▶▶ Heated Windshield Button

This system consumes a lot of power, so turn it off when the window has been deiced. Also, do not use the system for a long period when the engine is idling. This may weaken the battery, making it difficult to start the engine.

Brightness Control

■ Adjusting the Instrument Panel Brightness

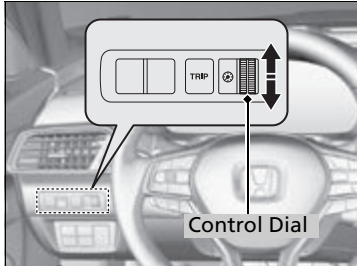

When the power mode is in ON, you can use the brightness control dial to adjust instrument panel brightness.

To brighten: Turn the dial up.

To dim: Turn the dial down.

You will hear a beep when the brightness reaches minimum or maximum. Several seconds after adjusting the brightness, you will be returned to the previous screen.

■ Brightness level indicator

The brightness level is shown on the driver information interface while you are adjusting it.

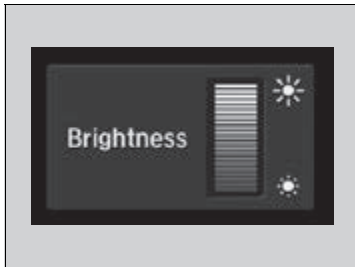

☒ Brightness Control

The brightness of the instrument panel will be reduced when the following conditions:

- The power mode is in ON.
- The light switch is in any position other than off and it is dark outside.

The brightness can be set differently for when the exterior lights are on, and when they are off.

■ Adjusting the Head-Up Display Brightness*

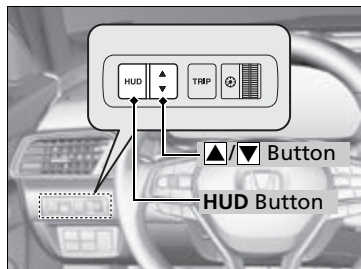

When the head-up display is on, press and hold the **HUD** button until its brightness level indicator on the driver information interface.

To brighten: Press the ▲ button.

To dim: Press the ▼ button.

The driver information interface will return to its original state several seconds after you adjust the brightness.



■ Brightness level indicator

The brightness level is shown on the driver information interface while you are adjusting it.

Driving Position Memory System*

You can store two driver's seat positions (except for power lumbar) with the driving position memory system.

When you unlock and open the driver's door with a remote transmitter or keyless access system, the seat adjust automatically to one of the two preset positions.

When you enter the vehicle, the driver information interface briefly shows you which remote transmitter you used to unlock the vehicle.

- **DRIVER 1** transmitter is linked to memory button 1.
- **DRIVER 2** transmitter is linked to memory button 2.



The driver's seat moves rearward depending on the set seating position once you

- Stop the vehicle.
- Put the transmission into **P**.
- Turn the engine off.
- Open the driver's door.

Once the power mode is in the ACCESSORY position, the driver's seat moves forward to the **DRIVER 1** or **2** preset position.

⌘ Driving Position Memory System*

Using the audio/information screen you can disable the automatic seat adjustment function.

➤ **Customized Features** P. 351

The driver's seat easy exit feature can be turned ON/OFF.

➤ **Customized Features** P. 351

System Operation

The system will not operate if:

- The vehicle speed is above 2 mph (3 km/h).
- Either memory position button is pressed while the seat is in motion.
- The seat position is adjusted while in operation.
- The memory 1 or 2 position is set fully to the rear.

The system may not recognize a key if:

- The key is in close proximity to a cell phone or other wireless device.
- Both keys are in the vehicle at the same time.
- The Driving Position Memory System is disabled in customized features.
- Opening driver's door without fully grabbing door handle.

■ Storing a Position in Memory

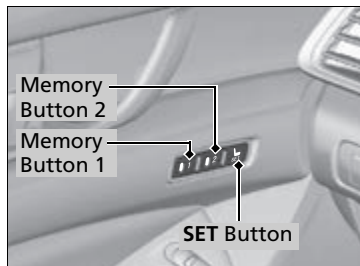

1. Set the power mode to ON. Adjust the driver's seat to the desired position.
2. Press the **SET** button.
 - ▶ You will hear the beeper, and the memory button indicator light will blink.
3. Press the memory button **[1]** or **[2]** within five seconds of pressing the **SET** button.
 - ▶ Once the seat position has been memorized, the indicator light on the button you pressed stays on and you will hear two beeps.

■ Recalling the Stored Position

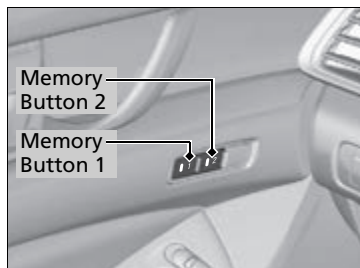

1. Put the transmission into **[P]**.
2. Apply the parking brake.
3. Press a memory button (**[1]** or **[2]**).
 - ▶ You will hear a beep, and the indicator light will blink.

The seat will automatically move to the memorized position. When it has finished moving, you will hear a beep, and the indicator light stays on.

⌘ Storing a Position in Memory

After you press the **SET** button, the storing operation will be canceled when:

- You do not press the memory button within five seconds.
- You readjust the seat position before the two beeps.
- You set the power mode to any position except ON.

⌘ Recalling the Stored Position

The seat will stop moving if you:

- Press the **SET** button or memory button **[1]** or **[2]**.
- Adjust the seat position.

Adjusting the Steering Wheel

The steering wheel height and distance from your body can be adjusted so that you can comfortably grip the steering wheel in an appropriate driving posture.

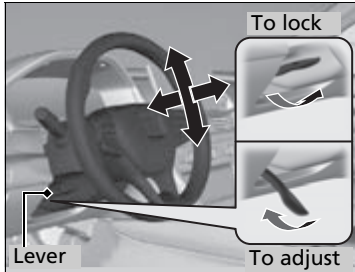

1. While the vehicle is stopped, push the steering wheel adjustment lever down.
 - ▶ The steering wheel adjustment lever is under the steering column.
2. Move the steering wheel up or down, and in or out.
 - ▶ Make sure you can see the instrument panel gauges and indicators.
3. Pull the steering wheel adjustment lever up to lock the steering wheel in position.
 - ▶ After adjusting the position, make sure you have securely locked the steering wheel in place by trying to move it up, down, in, and out.

Adjusting the Steering Wheel

⚠ WARNING

Adjusting the steering wheel position while driving may cause you to lose control of the vehicle and be seriously injured in a crash.

Adjust the steering wheel only when the vehicle is stopped.

Interior Rearview Mirror

Adjust the angle of the rearview mirror when you are sitting in the correct driving position.

Rearview Mirror with Day and Night Positions*

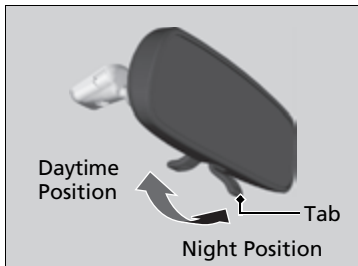

Flip the tab to switch the position. The night position will help to reduce the glare from headlights behind you when driving after dark.

Automatic Dimming Rearview Mirror*

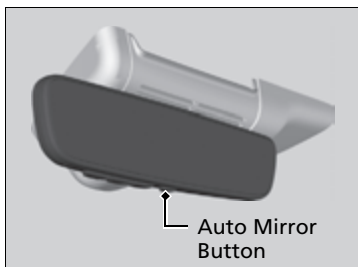

When you are driving after dark, the automatic dimming rearview mirror reduces the glare from headlights behind you. Press the auto mirror button to turn this function on and off. When activated, the auto indicator comes on.

Mirrors

Keep the inside and outside mirrors clean and adjusted for best visibility.

Adjust the mirrors before you start driving.

➤ **Seats** P. 212

Automatic Dimming Rearview Mirror*

The auto dimming function cancels when the transmission is in **R**.

Power Door Mirrors

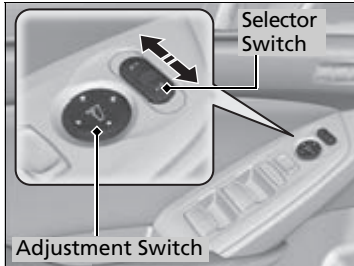

You can adjust the door mirrors when the power mode is in ON.

■ Mirror position adjustment

L/R selector switch: Select the left or right mirror. After adjusting the mirror, return the switch to the center position.

Mirror position adjustment switch: Press the switch left, right, up, or down to move the mirror.

■ Reverse Tilt Door Mirror*

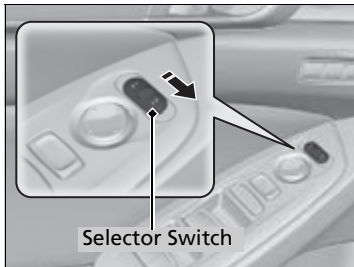

If activated, passenger side door mirror automatically tilts downward when you put the transmission into **[R]**; this improves close-in visibility on the passenger side of the vehicle when backing up. The mirror automatically returns to its original position when you take the transmission out of **[R]**.

To activate this feature, set the power mode to ON and slide the selector switch to the passenger side.

* Not available on all models

Front Seats

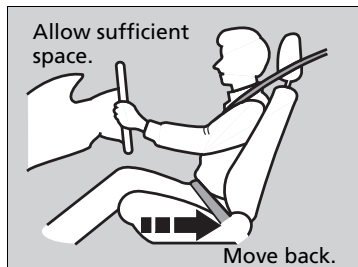

Adjust the driver's seat as far back as possible while allowing you to maintain full control of the vehicle. You should be able to sit upright, well back in the seat and be able to adequately press the pedals without leaning forward, and grip the steering wheel comfortably. The passenger's seat should be adjusted in a similar manner, so that it is as far back from the front airbag in the dashboard as possible.

Seats

Always make seat adjustments before driving.

Front Seats

⚠ WARNING

Sitting too close to a front airbag can result in serious injury or death if the front airbags inflate.

Always sit as far back from the front airbags as possible while maintaining control of the vehicle.

The National Highway Traffic Safety Administration and Transport Canada recommend that drivers allow at least 10 inches (25 cm) between the center of the steering wheel and the chest.

■ Adjusting the Seat Positions

■ Adjusting the front power seat(s)*

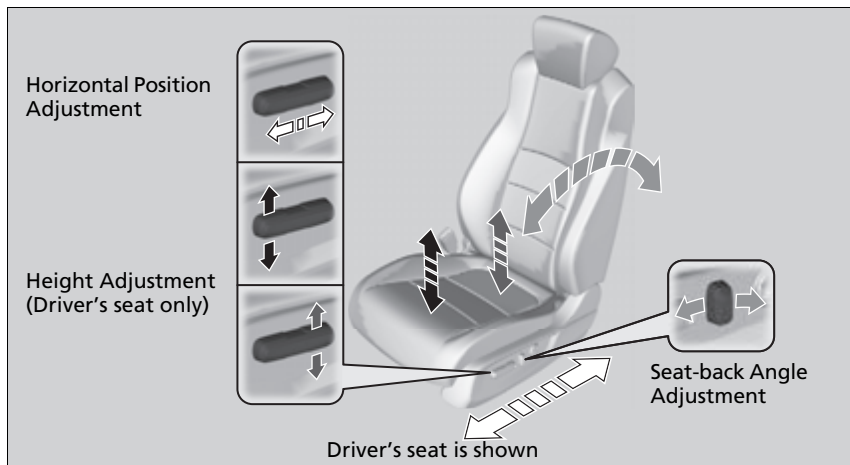

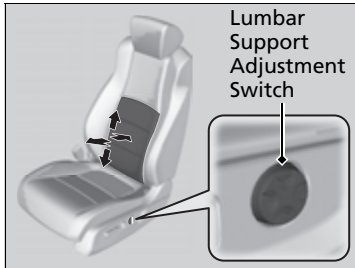

■ Lumbar Support Adjustment Switch*

Press the top: To move the lumbar support up.

Press the bottom: To move the lumbar support down.

Press the front: To increase the entire lumbar support.

Press the rear: To decrease the entire lumbar support.

* Not available on all models

■ Adjusting the front manual seat(s)*

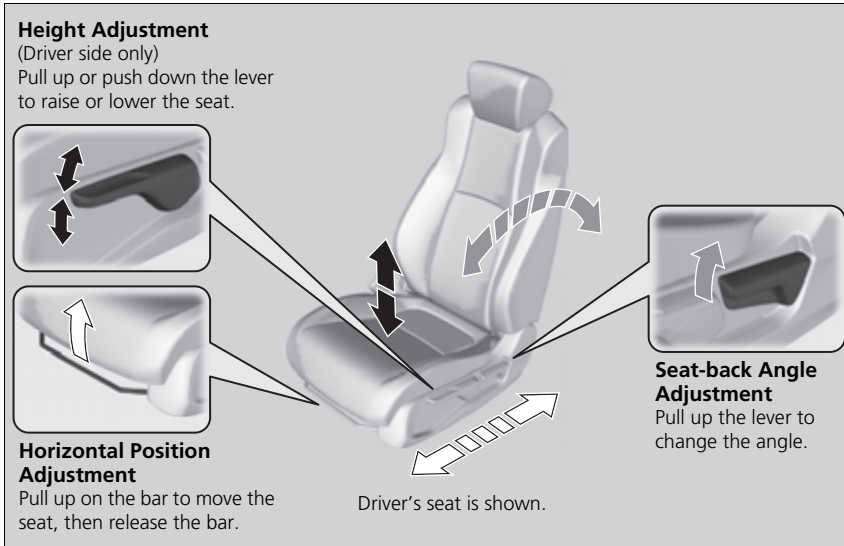

►► Adjusting the front manual seat(s)*

Once a seat is adjusted correctly, rock it back and forth to make sure it is locked in position.

■ Adjusting the Seat-Backs

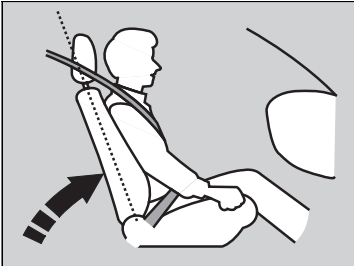

Adjust the driver's seat-back to a comfortable, upright position, leaving ample space between your chest and the airbag cover in the center of the steering wheel.

The front seat passenger should also adjust their seat-back to a comfortable, upright position.

Reclining a seat-back so that the shoulder part of the belt no longer rests against the occupant's chest reduces the protective capability of the belt. It also increases the chance of sliding under the belt in a crash and being seriously injured. The farther a seat-back is reclined, the greater the risk of injury.

▶▶ Adjusting the Seat-Backs

⚠ WARNING

Reclining the seat-back too far can result in serious injury or death in a crash.

Adjust the seat-back to an upright position, and sit well back in the seat.

Do not put a cushion, or other object, between the seat-back and your back.

Doing so may interfere with proper seat belt or airbag operation.

If you cannot get far enough away from the steering wheel and still reach the controls, we recommend that you investigate whether some type of adaptive equipment may help.

Rear Seats

Folding Down the Rear Seat(s)

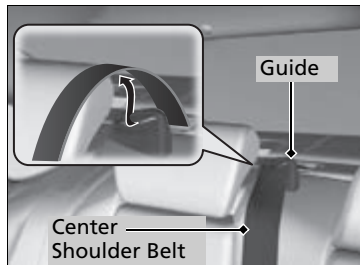

1. Remove the center shoulder belt from the guide.

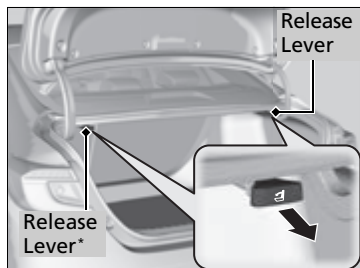

2. Pull the release lever in the trunk to release the lock.

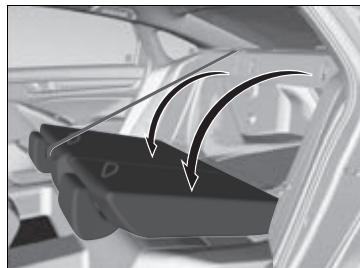

3. Fold the seat-back down.

Folding Down the Rear Seat(s)

The rear seat-back(s*) can be folded down to accommodate bulkier items in the trunk.

Never drive with the seat-back folded down and the trunk lid open.

Exhaust Gas Hazard P. 78

To lock a seat-back upright, push it backwards until it locks.

When returning the seat-back to its original position, push it firmly back. Also, make sure all rear shoulder belts are positioned in front of the seat-back, and the center shoulder belt is re-positioned in the guide.

Make sure that the folded seat-back does not press against the front passenger seat, as this can cause the weight sensors in the front passenger seat to work improperly.

Passenger Airbag Off Indicator P. 61

Make sure all items in the trunk or items extending through the opening into the rear seat is properly secured. Loose items can fly forward if you have to brake hard.

The front seat(s) must be far enough forward so they do not interfere with the rear seats as they fold down.

Rear Seat Reminder

This feature alerts you to the possible presence of passengers or items in the rear seats before you exit the vehicle. It activates when the vehicle is set to VEHICLE OFF if the rear doors were opened shortly before or after the vehicle was set to ON.

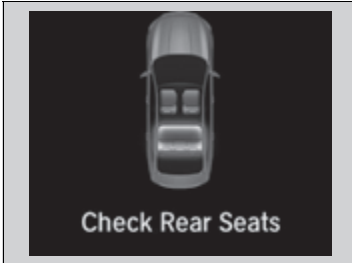

A reminder appears on the driver information interface and an alert will sound when the power mode is set to VEHICLE OFF.

⌘ Rear Seat Reminder

When the power mode is set to VEHICLE OFF, the reminder will go off and the function will terminate.

The reminder will not work if the power mode has not been set to ON within 10 minutes of operating the rear doors.

The system does not detect passengers in the rear seats. Instead, it can detect when a rear door is opened and closed, indicating that there may be something in the rear seats.

Models with wireless Apple CarPlay

You can turn off the notification setting.

➤ **Customized Features** P. 351

Maintain a Proper Sitting Position

After all occupants have adjusted their seats and head restraints, and put on their seat belts, it is very important that they continue to sit upright, well back in their seats, with their feet on the floor, until the vehicle is safely parked and the power mode is off.

Sitting improperly can increase the chance of injury during a crash. For example, if an occupant slouches, lies down, turns sideways, sits forward, leans forward or sideways, or puts one or both feet up, the chance of injury during a crash is greatly increased.

In addition, an occupant who is out of position in the front seat can be seriously or fatally injured in a crash by striking interior parts of the vehicle or being struck by an inflating front airbag.

►► Maintain a Proper Sitting Position

WARNING

Sitting improperly or out of position can result in serious injury or death in a crash.

Always sit upright, well back in the seat, with your feet on the floor.

Head Restraints

Your vehicle is equipped with head restraints in all seating positions.

■ Adjusting the Front and Rear Outer* Head Restraint Positions

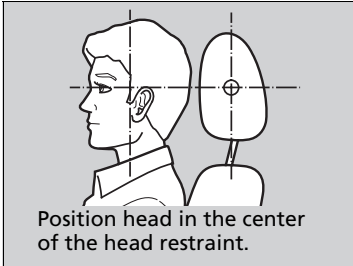

Head restraints are most effective for protection against whiplash and other rear-impact crash injuries when the center of the back of the occupant's head rests against the center of the restraint. The tops of the occupant's ears should be level with the center height of the restraint.

⊠ Head Restraints

⚠ WARNING

Improperly positioning head restraints reduces their effectiveness and increases the likelihood of serious injury in a crash.

Make sure head restraints are in place and positioned properly before driving.

In order for the head restraint system to work properly:

- Do not hang any items on the head restraints, or from the restraint legs.
- Do not place any objects between an occupant and the seat-back.
- Install each restraint in its proper location.

* Not available on all models

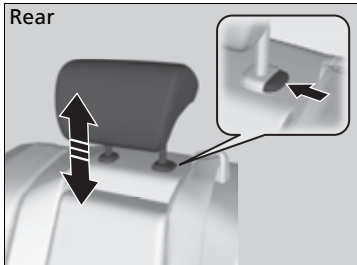
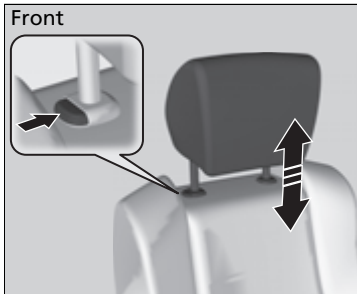

To raise the head restraint: Pull it upward.

To lower the head restraint: Push it down while pressing the release button.

■ Removing and Reinstalling the Head Restraints

Head restraints can be removed for cleaning or repair.

To remove a head restraint:

Pull the restraint up as far as it will go. Then, push the release button and pull the restraint up and out.

To reinstall a head restraint:

Insert the legs back in place, then adjust the head restraint to an appropriate height while pressing the release button. Pull up on the restraint to make sure it is locked in position.

⊠ Removing and Reinstalling the Head Restraints

⚠ WARNING

Failure to reinstall, or correctly reinstall, the head restraints can result in severe injury during a crash.

Always replace the head restraints before driving.

Armrest

■ Using the Front Seat Armrest



The console lid can be used as an armrest.

■ Using the Rear Seat Armrest

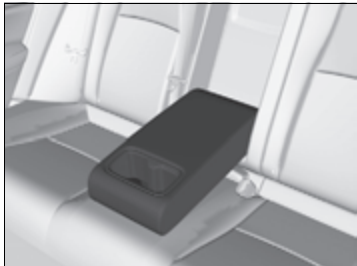

Pull down the armrest in the center backrest.

Interior Lights

Interior Light Switches

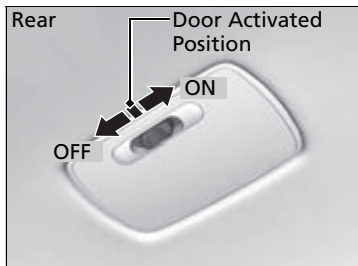
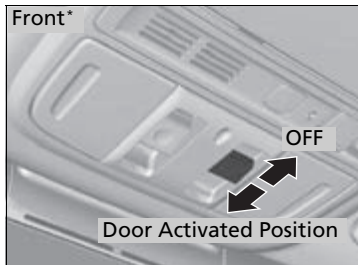

■ ON

The interior lights come on regardless of whether the doors are open or closed.

■ Door activated

The interior lights come on in the following situations:

- When any doors are opened.
- You unlock the driver's door.
- When the power mode is set to VEHICLE OFF.

■ OFF

The interior lights remain off regardless of whether the doors are open or closed.

Interior Light Switches

In the door activated position, the interior lights fade out and go off about 30 seconds after the doors are closed.

The lights go off after about 30 seconds in the following situations:

- When you unlock the driver's door but do not open it.
- When you set the power mode to VEHICLE OFF but do not open a door.

You can change the interior lights dimming time.

➤ **Customized Features** P. 351

The interior lights go off immediately in the following situations:

- When you lock the driver's door.
- When you close the driver's door in ACCESSORY mode.
- When you set the power mode to ON.

To avoid draining the battery, do not leave the interior lights on for an extended length of time when the engine is off.

If you leave any of the doors open in VEHICLE OFF mode, the interior lights go off after about 15 minutes.

■ Map Light Switches

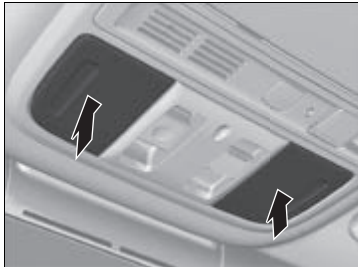

The map lights can be turned on and off by pressing the lenses.

»» Map Light Switches

Models with moonroof

When the interior light switch is in the door activated position and any door is open, the map light will not go off when you press the lens.

Storage Items

■ Glove Box

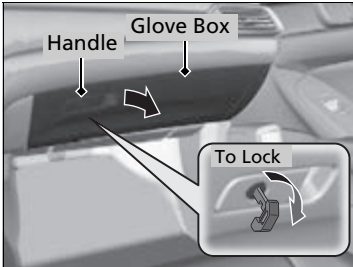

Pull the handle to open the glove box.

■ Models with trunk main switch

You can lock the glove box with the built-in key.

■ Center Pocket



Push the cover to open the pocket.

☒ Glove Box

⚠ WARNING

An open glove box can cause serious injury to your passenger in a crash, even if the passenger is wearing the seat belt.

Always keep the glove box closed while driving.

■ Console Compartment

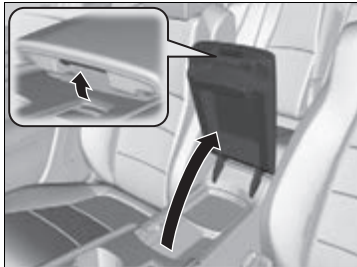

Pull the handle to open the console compartment.



■ Removable tray

The tray in the console compartment is detachable. To remove the tray, simply pull it up.

■ Beverage Holders



■ Front seat beverage holders

Are located in the console between the front seats.

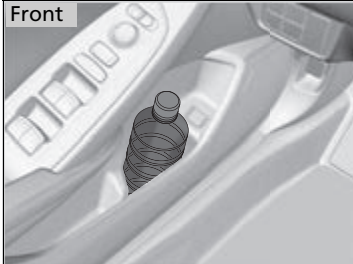

■ Door side beverage holders

Are located on the both of front and rear door side pockets.

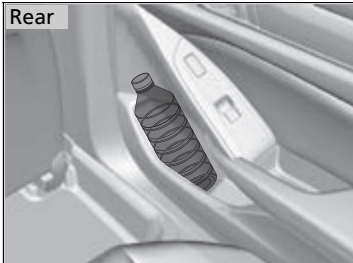

» Beverage Holders

NOTICE

Spilled liquids damage the upholstery, carpeting, and electrical components in the interior.

Be careful when you are using the beverage holders. Hot liquid can scald you.

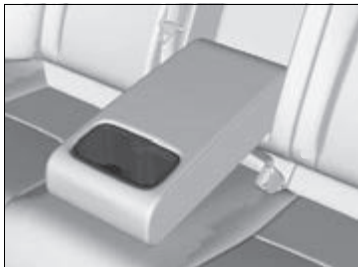

■ **Rear seat beverage holders**

Fold the armrest down to use the rear seat beverage holders.

■ Coat Hook



There is a coat hook on the rear left grab handle. Pull it down to use it.

■ Cargo Hooks

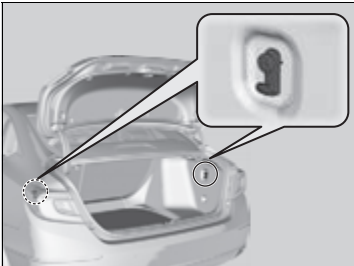

The cargo hooks in the trunk can be used to install a net for securing items.

☒ Coat Hook

The coat hook is not designed for large or heavy items.

☒ Cargo Hooks

Heavy objects may damage the hook. Make sure any items put on this hook weigh less than 6.6 lbs (3 kg).

Distribute cargo evenly on the floor of the trunk, placing the heaviest items on the bottom and as far forward as possible.

➤ **Maximum Load Limit** P. 405

■ Sunglasses Holder

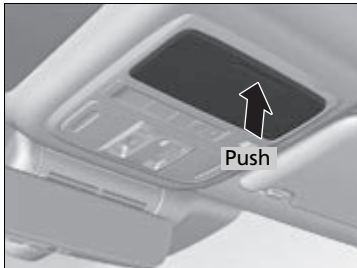

To open the sunglasses holder, push and release the indent. To close, push it again until it latches.

You can store eyeglasses and other small items in this holder.

►► Sunglasses Holder

Keep the holder closed while driving except when accessing stored items.

Other Interior Convenience Items

■ Accessory Power Sockets

The accessory power sockets can be used when the power mode is in ACCESSORY or ON.



■ Center pocket

Open the center pocket and the cover to use it.

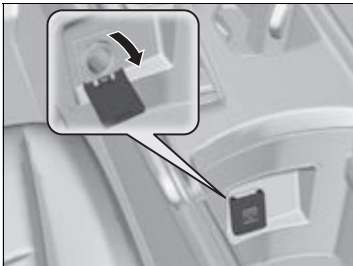

■ Console compartment

Open the console lid and the cover to use it.

⊠ Accessory Power Sockets

NOTICE

Do not insert an automotive type cigarette lighter element. This can overheat the power socket.

The accessory power socket is designed to supply power for 12-volt DC accessories that are rated 180 watts (15 amps) or less.

To prevent battery drain, use the power socket only when the engine is running.

When the accessory power socket is not in use, close the cover to prevent any small foreign objects from getting into the accessory power socket.

■ Wireless Charger*

To use the wireless charger, the power mode must be in ACCESSORY or ON. Charge any devices compatible with Qi wireless charging on the area indicated by the  mark as follows:

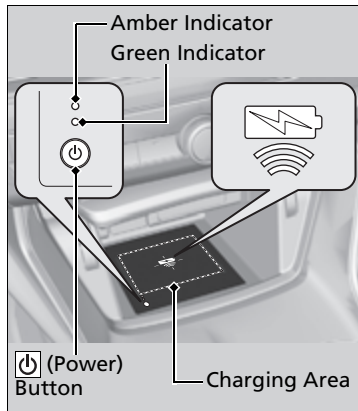

1. To turn the system on and off, press and hold the  (power) button.
 - When the system is activated, the green indicator light comes on.
2. Place the device you want to charge on the charging area.
 - The system will automatically start charging the device, and the amber indicator light will come on.
 - Make sure that the device is compatible with the system, and placed with the chargeable side in the center of the charging area.
3. When charging is completed, the green indicator light will come on.
 - Depending on the device, the amber indicator light will stay on.

▣ Wireless Charger*

RF Radiation Exposure Statement:

This equipment complies with FCC RF Radiation exposure limits set forth for an uncontrolled environment.

This device and its antenna must not be co-located or operating in conjunction with any other antenna or transmitter.

In order to use safely:

- Remove any metal objects from the charge pad before charging a device.
- Do not open the charger case.
- Do not use the charger if it malfunctions. Contact your dealer.

If the charger interferes with radio communications, attempt to correct the interference:

- Press and hold the switch on the charger for a few seconds to turn off the charger.

 appears on the audio/information screen when the device is being charged by the wireless charger.

■ When charging does not start

Perform one of the solutions in the following table.

Indicator		Cause	Solution
Green & Amber	Blinking simultaneously	There is an obstacle(s) between the charging area and the device.	Remove the obstacle(s).
		The device is not within the charging area.	Pick up and reset the device to the center of the charging area where  is located.
		The temperature of the wireless charger pad increases.	Temporarily suspend charging the device. Wait for temperature to drop and attempt to charge the device again.
Amber	Blinking	The wireless charger is faulty.	Contact a dealer for repairs.

Wireless Charger*

⚠ CAUTION

Metal objects between the charge pad and the device to be charged will get hot and can burn you.

- Always remove foreign objects from the charge pad before charging the device.
- Be sure the surface is clear of dust and other debris before charging.
- Do not spill liquids (i. e. water, drinks, etc.) on the charger and the device.
- Do not use oil, grease, alcohol, benzine or thinner for cleaning the charge pad.
- Do not cover the system with towels, clothing, or other objects while charging etc.
- Avoid spraying aerosols which may come in contact with the charge pad surface.

This system consumes a lot of power. Do not use the system for a long time when the engine is not running. This may weaken the battery, making it difficult to start the engine.

When using the wireless charger, check the user's manual that came with the compatible device you want to charge.

* Not available on all models

▶▶ Wireless Charger*

The wireless charger can support up to 15 W, but the charging rate varies based on the device and other conditions.

NOTICE

Do not place any magnetic recording media or precision machines within the charging area while charging. The data on your cards such as credit cards can be lost because of the magnetic effect. Also precision machines such as watches can go wrong.

“Qi” and  marks are the registered trademarks owned by Wireless Power Consortium (WPC).

In the following cases, charging may stop or not start:

- The device is already fully charged.
- The temperature of the device is extremely high while charging.
- You are at a place that emits strong electromagnetic waves or noises, such as a TV station, electric power plant, or gas station.
- The device has a cover, case or accessories which are not compatible with wireless charging.

A device may not charge if the size or shape of its chargeable side is not appropriate for use with the charging area.

Not all devices are compatible with the system.

During the charging phase, it is normal for the charging area and device to heat up.

🔌 Wireless Charger*

Charging may be briefly interrupted when:

- All the doors and the trunk are closed
 - to avoid interference with the proper functioning of the keyless access system.
- The position of the device is altered.

Do not charge more than one device at a time on a charging area.

If the device becomes too hot and its battery protection function activates, it may charge extremely slowly or no longer charge. The temperature at which the battery protection function activates depends on the device.

* Not available on all models

Continued

Canadian models

■ Heated Steering Wheel *



The power mode must be in ON to use the heated steering wheel.

Press the button on the lower side of the steering wheel.

When a comfortable temperature is reached, press the button again to turn it off.

The heated steering wheel is turned off every time you start the engine, even if you turned it on the last time you drove the vehicle.

▣ Heated Steering Wheel *

Do not use the heated steering wheel continuously when the engine is off. Under such conditions, the battery may be weakened, making the engine difficult to start.

■ Front Seat Heaters*



The power mode must be in ON to use the seat heaters.

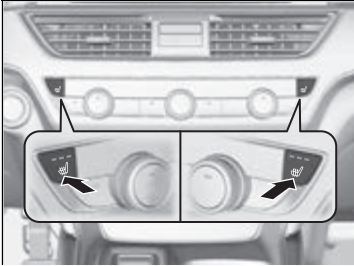

Press the seat heater button:

- Once - The HI setting (three indicators on)
- Twice - The MID setting (two indicators on)
- Three times - The LO setting (one indicator on)
- Four times - The OFF setting (no indicators on)

When the power mode is turned on after it is turned off, the previous setting of front seat heaters are maintained.

☒ Front Seat Heaters*

⚠ WARNING

Heat induced burns are possible when using seat heaters.

Persons with a diminished ability to sense temperature (e.g., persons with diabetes, lowerlimb nerve damage, or paralysis) or with sensitive skin should not use seat heaters.

Do not use the seat heaters even in LO when the engine is off. Under such conditions, the battery may be weakened, making the engine difficult to start.

After a certain period of time, the strength setting for the front seat heaters will automatically be reduced by one level at a time until the front seat heaters shut off. The elapsed time varies according to the interior environment.

* Not available on all models

■ Front Seat Heaters and Seat Ventilation*



The seat heaters or ventilators can be used when the power mode is in ON.

The seat heaters: Use them to warm up the seat.

The seat ventilators: Use them when you want to ventilate the surface of the seats.

When used with the air conditioning, the surface of the seats will become easier to cool.

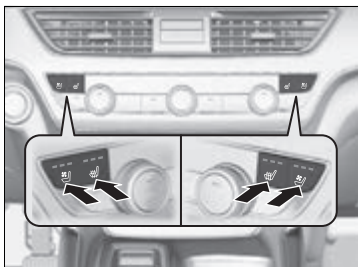

Press the seat heater or the seat ventilation button:

Once - The HI setting (three indicators on)

Twice - The MID setting (two indicators on)

Three times - The LO setting (one indicator on)

Four times - The OFF setting (no indicators on)

When the power mode is turned on after it is turned off, the previous setting of front seat heaters and ventilation are maintained.

▣ Front Seat Heaters and Seat Ventilation*

⚠ WARNING

Heat induced burns are possible when using seat heaters.

Persons with a diminished ability to sense temperature (e.g., persons with diabetes, lowerlimb nerve damage, or paralysis) or with sensitive skin should not use seat heaters.

Do not use the seat heaters and the seat ventilation even in LO when the engine is off. Under such conditions, the battery may be weakened, making the engine difficult to start.

After a certain period of time, the strength setting for the front seat heaters will automatically be reduced by one level at a time until the front seat heaters shut off. The elapsed time varies according to the interior environment.

■ Rear Seat Heaters*

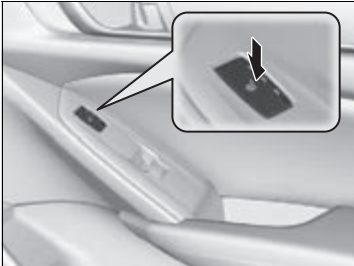

The power mode must be in ON to use the seat heaters.

There is no heater in the rear center seating position.

Press the seat heater button:

Once - The HI setting (three indicators on)

Twice - The MID setting (two indicators on)

Three times - The LO setting (one indicator on)

Four times - The OFF setting (no indicators on)

⊠ Rear Seat Heaters*

⚠ WARNING

Heat induced burns are possible when using seat heaters.

Persons with a diminished ability to sense temperature (e.g., persons with diabetes, lowerlimb nerve damage, or paralysis) or with sensitive skin should not use seat heaters.

Do not use the seat heaters even in LO when the engine is off. Under such conditions, the battery may be weakened, making the engine difficult to start.

After a certain period of time, the strength setting for the rear seat heaters will automatically be reduced by one level at a time until the rear seat heaters shut off. The elapsed time varies according to the interior environment.

* Not available on all models

Using Automatic Climate Control

The automatic climate control system maintains the interior temperature you select. The system also selects the proper mix of heated or cooled air that raises or lowers the interior temperature to your preference as quickly as possible.

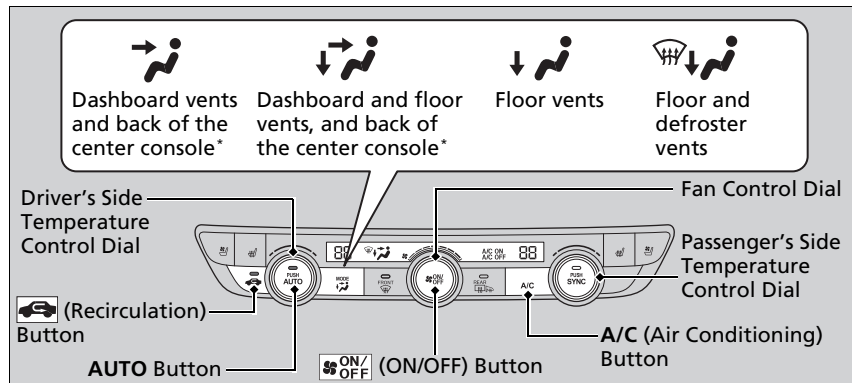

Use the system when the engine is running.

1. Press the **AUTO** button.
2. Adjust the interior temperature using the driver's side or passenger's side control dial.
3. Press the **ON/OFF** (ON/OFF) button to cancel.

Switching between the recirculation and fresh air modes

Press the **(Recirculation) Button** and switch the mode depending on environmental conditions.

Recirculation mode (indicator on): Recirculates air from the vehicle's interior through the system.

Fresh air mode (indicator off): Maintains outside ventilation. Keep the system in fresh air mode in normal situations.

* Not available on all models

Using Automatic Climate Control

If any buttons are pressed while using the climate control system in auto, the function of the button that was pressed will take priority. The **AUTO** indicator will go off, but functions unrelated to the button that was pressed will be controlled automatically.

Models with Auto Idle Stop

During idle-stops, air-conditioning is suspended, and only the blower remains active.

If you do not want air-conditioning suspended, press the Auto Idle Stop **OFF** button to cancel idle-stop.

All models

To prevent cold air from blowing in from outside, the fan may not start immediately when the **AUTO** button is pressed.

If the interior is very warm, you can cool it down more rapidly by partially opening the windows, turning the system on auto, and setting the temperature to low. Change the fresh air mode to recirculation mode until the temperature cools down.

When you set the temperature to the lower or upper limit, **Lo** or **Hi** is displayed.

Pressing the **ON/OFF** button switches the climate control system between on and off. When turned on, the system returns to your last selection.

While ECON mode is active, the climate control system may have reduced cooling performance.

Defrosting the Windshield and Windows

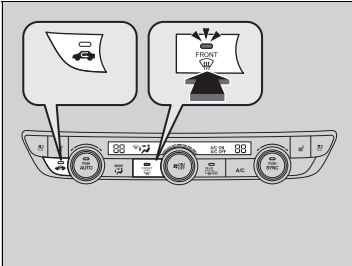

Pressing the  button turns the air conditioning system on and automatically switches the system to fresh air mode.

Press the  button again to turn off, the system returns to the previous settings.

To rapidly defrost the windows

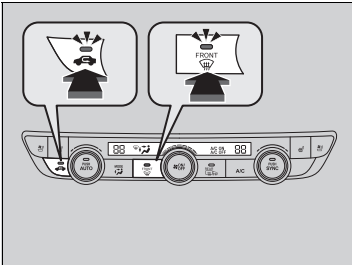

1. Press the  button.
2. Press the  button.

Defrosting the Windshield and Windows

For your safety, make sure you have a clear view through all the windows before driving.

Do not set the temperature near the upper or lower limit.

When cold air hits the windshield, the outside of the windshield may fog up.

Models with Auto Idle Stop

If you press the  button during Auto Idle Stop, the engine restarts automatically.

To rapidly defrost the windows

After defrosting the windows, switch over to fresh air mode. If you keep the system in recirculation mode, the windows may fog up from humidity. This impedes visibility.

■ Synchronization Mode

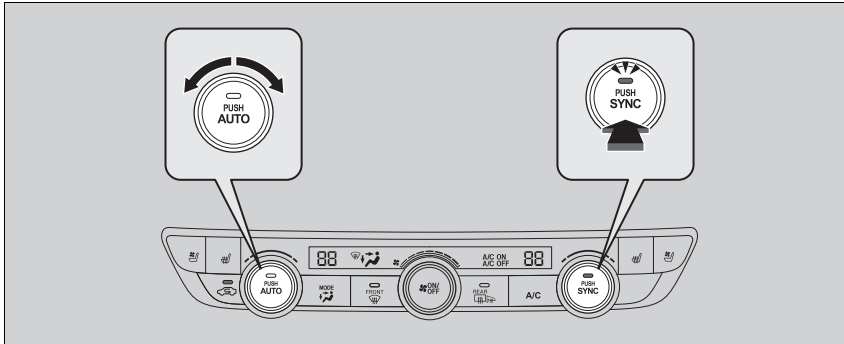

You can set the temperature synchronously for the driver side and the passenger side in synchronization mode.

1. Press the **SYNC** button.
 - The system will switch to the synchronization mode.
2. Adjust the temperature using driver's side temperature control dial.

Press the **SYNC** button or adjust the interior temperature using the passenger's side control dial to return to dual mode.

▣ Synchronization Mode

When you press the  button, the system changes to synchronization mode.

When the system is in dual mode, the driver side temperature and the passenger side temperature can be set separately.

Automatic Climate Control Sensors

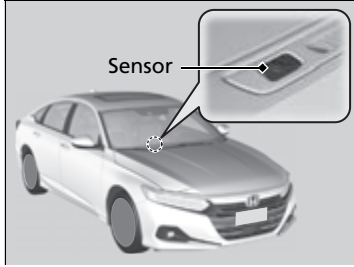

The automatic climate control system is equipped with sensors. Do not cover or spill any liquid on them.

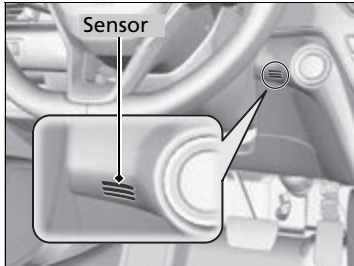

This page intentionally left blank.

Features

This chapter describes how to operate technology features.

Audio System

About Your Audio System	246
USB Ports	247
Audio System Theft Protection	249
Audio Remote Controls	250
Audio System Basic Operation	253
Audio/Information Screen	254
System Updates*	266
Adjusting the Sound	272
Display Setup	273
Voice Control Operation	275
Playing AM/FM Radio	278
Playing SiriusXM® Radio*	282
Playing an iPod	293

Playing a USB Flash Drive	296
Playing <i>Bluetooth</i> ® Audio	299
HondaLink®	301
HondaLink® Service*	305
Wi-Fi Connection	310
AT&T Hotspot*	311
Siri Eyes Free*	312
Apple CarPlay	313
Android Auto	320

Audio Error Messages	327
General Information on the Audio System	329
Customized Features	351
HomeLink® Universal Transceiver*	371

<i>Bluetooth</i>® HandsFreeLink®	374
Refuel Recommend	400

* Not available on all models

About Your Audio System

The audio system features AM/FM radio and SiriusXM® Radio* service. It can also play USB flash drives, iPod, iPhone, and *Bluetooth*® devices.

You can operate the audio system from the buttons and knobs on the panel, the remote controls on the steering wheel, or the icons on the touchscreen interface.

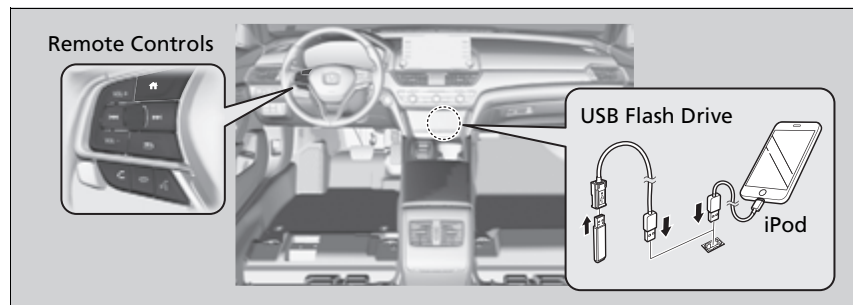

About Your Audio System

iPod®, iPhone® and iTunes® are trademarks of Apple Inc.

State or local laws may prohibit the operation of handheld electronic devices while operating a vehicle.

SiriusXM® Radio* is available on a subscription basis only. For more information on SiriusXM® Radio*, contact a dealer.

General Information on the Audio System P. 329

SiriusXM® Radio* is available in the United States and Canada, except Hawaii, Alaska, and Puerto Rico.

SiriusXM®* is a registered trademark of SiriusXM Radio, Inc.

USB Ports

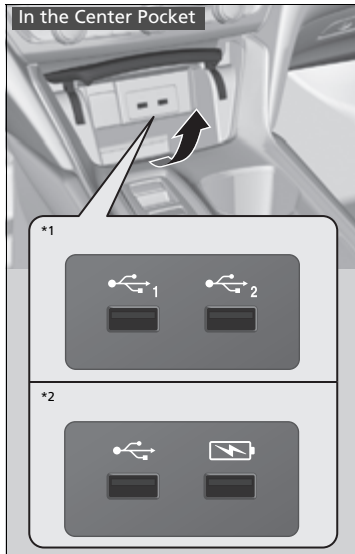

■ In the Center Pocket (🔌)

The USB port(s) (2.5A) is/are for charging devices, playing audio files and connecting compatible phones with Apple CarPlay or Android Auto.

- ▶ To prevent any potential issues, be sure to use an Apple MFi Certified Lightning Connector for Apple CarPlay, and for Android Auto, the USB cables should be certified by USB-IF to be compliant with USB 2.0 Standard.

■ In the Center Pocket (🔌)*

The USB port (2.5A) is only for charging devices.

- ▶ You cannot play music even if you have connected music players to it.

🔌 USB Ports

- Do not leave the iPod or USB flash drive in the vehicle. Direct sunlight and high temperatures may damage it.
- We recommend that you use a USB cable if you are attaching a USB flash drive to the USB port.
- Do not connect the iPod or USB flash drive using a hub.
- Do not use a device such as a card reader or hard disk drive, as the device or your files may be damaged.
- We recommend backing up your data before using the device in your vehicle.
- Displayed messages may vary depending on the device model and software version.

🔌 USB charge

The USB port can supply up to 2.5A of power. It does not output 2.5A unless the device requests. For amperage details, read the operating manual of the device that needs to be charged.

Under certain conditions, a device connected to the port may generate noise to the radio station you are listening to.

*1: Models without wireless Apple CarPlay and wireless Android Auto

*2: Models with wireless Apple CarPlay and wireless Android Auto

* Not available on all models



■ **Rear of the center console***

The USB ports (2.5A) are only for charging devices.

- ▶ You cannot play music even if you have connected music players to them.

Audio System Theft Protection

The audio system is disabled when it is disconnected from the power source, such as when the battery is disconnected or goes dead. In certain conditions, the system may display a code entry screen. If this occurs, reactivate the audio system.

■ Reactivating the audio system

1. Set the power mode to ON.
2. Turn on the audio system.
3. Press and hold the audio system power knob for more than two seconds.
 - ▶ The audio system is reactivated when the audio control unit establishes a connection with the vehicle control unit. If the control unit fails to recognize the audio unit, you must go to a dealer and have the audio unit checked.

Audio Remote Controls

Allow you to operate the audio system while driving. The information is shown on the driver information interface or head-up display*.

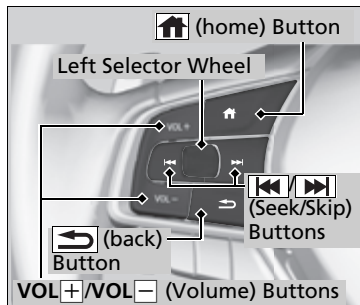

VOL+ /VOL- (Volume) Buttons

Press VOL+: To increase the volume.

Press VOL-: To decrease the volume.

Left Selector Wheel

- When selecting the audio mode
Press the (home) button, then roll up or down to select **Audio** on the driver information interface, and then press the left selector wheel.

Audio Remote Controls

Some modes appear only when an appropriate device or medium is used.

Depending on the *Bluetooth*® device you connect, some functions may not be available.

Press the (back) button for the driver information interface to go back to the previous screen or cancel a command.

Press the (home) button to go back to the home screen of the driver information interface.





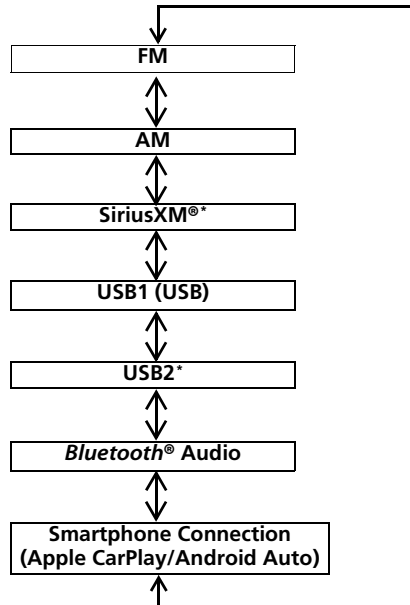



Roll up or down:

To cycle through the audio modes, roll up or down and then press the left selector wheel:



* Not available on all models

(Seek/Skip) Buttons

- When listening to the radio
 - Press** : To select the next preset radio station.
 - Press** : To select the previous preset radio station.
 - Press and hold** : To select the next strong station.
 - Press and hold** : To select the previous strong station.
- When listening to an iPod, USB flash drive, or *Bluetooth*[®] Audio, or Smartphone Connection
 - Press** : To skip to the next song.
 - Press** : To go back to the beginning of the current or previous song.
- When listening to a USB flash drive
 - Press and hold** : To skip to the next folder.
 - Press and hold** : To go back to the previous folder.

Audio System Basic Operation

To use the audio system function, the power mode must be in ACCESSORY or ON.

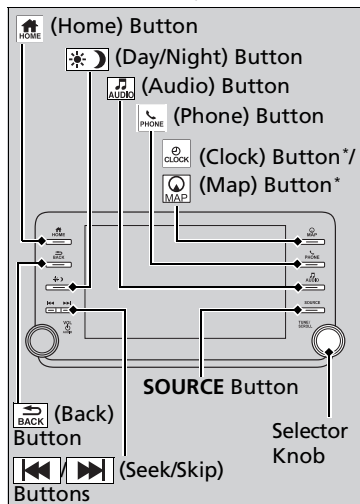

(Home) Button: Press to go to the home screen.

Switching the Display P. 254

(Back) Button: Press to go back to the previous display when it is displayed.

(Seek/Skip) Buttons: Press to change songs.

(Clock) Button*: Press to display the clock screen.

(Map) Button*: Press to display the map screen.

(Phone) Button: Press to display the phone screen.

(Audio) Button: Press to display the current audio information.

SOURCE Button: Press to display the source select screen.

Selector Knob: Rotate left or right to scroll through the available choices.

Press to set your selection.

(Day/Night) Button: Press to change the audio/information screen brightness.

Press once and select or to make an adjustment.

► Each time you press , the mode switches among the daytime mode, nighttime mode, and off mode.

Audio System Basic Operation

These indications are used to show how to operate the Selector Knob.

Rotate to select.

Press to enter.

Selector Knob

When the list is not displayed, songs, frequency, etc. can be changed.

While connected to Apple CarPlay, it changes as follows:

- Pressing the Phone Button, display the Apple CarPlay phone screen.
- Pressing the Audio Button, display the Apple CarPlay audio screen.

* Not available on all models

Audio/Information Screen

Displays the audio status and wallpaper. From this display, you can go to various setup options.

■ Switching the Display

■ Using the audio/information screen

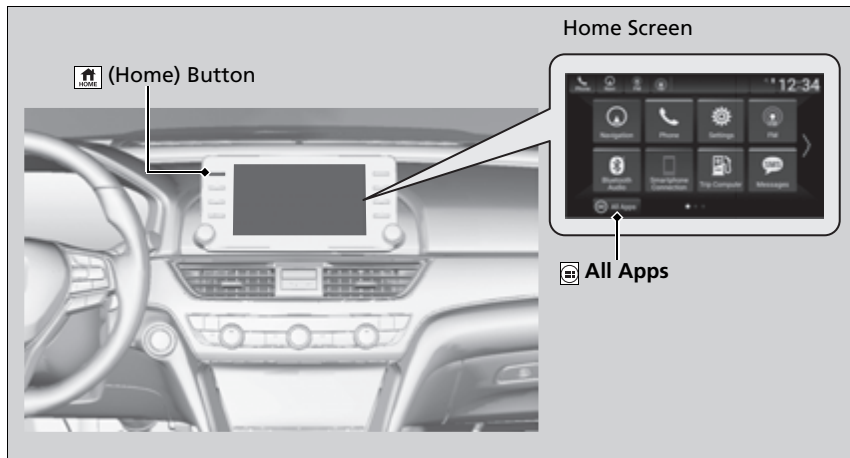

Press the  button to go to the home screen.

Select the following icons on the home screen or after selecting  **All Apps**.

■ Phone

Displays the HFL information.

▶ **Bluetooth® HandsFreeLink®** P. 374

▶▶ Audio/Information Screen

Touchscreen Operation

- Use simple gestures - including touching, swiping, and scrolling - to operate certain audio functions.
- Some items may be grayed out during driving to reduce the potential for distraction.
- You can select them when the vehicle is stopped or use voice commands.
- Wearing gloves may limit or prevent touchscreen response.

You can change the touchscreen sensitivity setting.

▶ **Customized Features** P. 351

■ Trip Computer

Displays the trip computer information.

- **Current Drive** tab: Displays the current trip information.
- **Trip A/Trip B** tab: Displays information for the current and three previous drives. The information is stored every time you reset Trip A/B. To reset the Trip A/B, select **Settings**, then select **Delete Trip History**. To change the setting of how to reset Trip A/B, select **Settings**, then select **“Trip A” Reset Timing** or **“Trip B” Reset Timing**.

■ Clock

Displays the clock.

■ System Updates*

Updates the software version of the audio system.

- ☒ **System Updates*** P. 266

■ FM/AM/SiriusXM*/USB1 (USB)/USB2*/Bluetooth Audio/Smartphone Connection

Displays information for each audio format.

■ Settings

Enters the customizing menu screen.

- ☒ **Customized Features** P. 351

■ Navigation*

Displays the navigation screen.

- ☒ **Refer to the Navigation System Manual**

* Not available on all models

■ **HondaLink**

Displays the HondaLink screen.

➤ **HondaLink**® P. 301

■ **Apple CarPlay/Android Auto**

Displays the **Apple CarPlay** or **Android Auto** screen.

➤ **Apple CarPlay** P. 313

➤ **Android Auto** P. 320

■ **Messages**

Displays the text message screen.

➤ **Bluetooth**® **HandsFreeLink**® P. 374

■ **AT&T Hotspot***

Displays the AT&T Hotspot screen.

➤ **AT&T Hotspot*** P. 311

■ **Compass***

Displays the compass screen.

Wallpaper Setup

You can change, store, and delete the wallpaper on the audio/information screen.

Import wallpaper

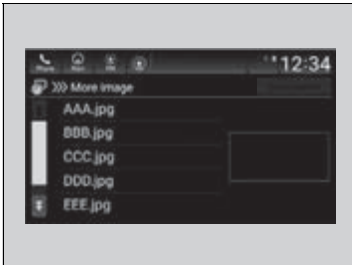
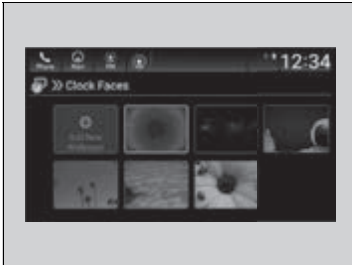

1. Connect the USB flash drive to the USB port in the center pocket.
▶ **USB Ports** P. 247
2. Select **Clock**.
3. Select **Settings**.
4. Select **Clock Faces**.
5. Select **Add New Wallpaper**.
▶ The **Searching...** screen is displayed.
6. Import a desired picture.
▶ Multiple pictures can be imported at the same time.
7. Select **Start Import**.
▶ The display will return to the **Clock Faces** screen.

Wallpaper Setup

The wallpaper you set up on **Clock Faces** cannot be displayed on the driver information interface.

- When importing wallpaper files, the image must be in the USB flash drive's root directory. Images in a folder cannot be imported.
- The file name must be fewer than 64 characters (64 bytes).
- The file format of the image that can be imported is BMP (bmp) or JPEG (jpg).
- If the USB flash drive does not have any pictures, the **No files detected** message appears.
- Up to five pictures can be imported.
- The individual file size limit is 2 MB.
- The maximum image size is 1,920 × 936 pixels. If the image size is less the image is displayed in the middle of the screen with the extra area appearing in black.

■ Select wallpaper

1. Select **Clock**.
2. Select **Settings**.
3. Select **Clock Faces**.
4. Select a desired wallpaper.
5. Select **Set**.
 - ▶ The display will return to the **Clock Faces** screen.

■ To view wallpaper once it is set

1. Press the  button.
2. Select **Clock**.

■ Delete wallpaper

1. Select **Clock**.
2. Select **Settings**.
3. Select **Clock Faces**.
4. Select a desired wallpaper.
5. Select **Delete**.
6. Select **Yes**.
 - ▶ The display will return to the **Clock Faces** screen.

▶▶ Wallpaper Setup

You cannot delete the initial imported wallpapers.

When the file size is large, it takes a while to be previewed.

■ Home Screen

■ To move to the next screen

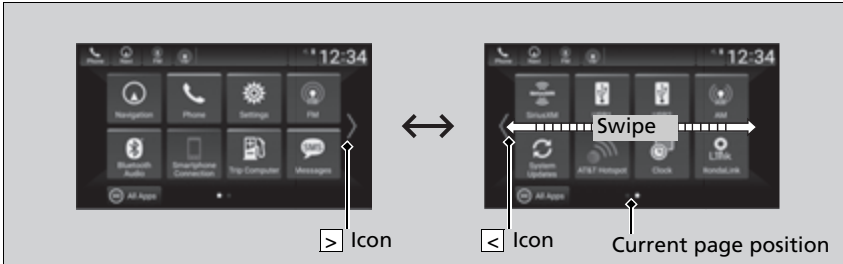

Selecting or , or swiping the screen left or right changes to the next screen.

▶▶ Home Screen

The home screen has 2 pages. You can add up to 7 pages.

Press the  button to go directly back to the first page of the home screen from any page.

■ To add app icons on the home screen

App icons can be added on the home screen.



1. Press the **HOME** button.
2. Select and hold the home screen.
3. Select **Add**.
4. Drag and drop the icon to where you want it to be.
5. Select **Done**.
 - ▶ The screen will return to the home screen.

▶▶ To add app icons on the home screen

You can add app icons by the following procedure.

1. Press the **HOME** button.
2. Select **All Apps**.
3. Select **Customize**.
4. Select **Add**.
5. Drag and drop the icon to where you want it to be.
6. Select **Done**.
 - ▶ The screen will return to the home screen.

Pre-installed apps may not start up normally. If this occurs, you need to reset the system.

▶ **Defaulting All the Settings** P. 370

If you perform **Factory Data Reset**, it may reset all the settings to their factory default.

▶ **Defaulting All the Settings** P. 370

In case those apps still do not startup normally even after **Factory Data Reset**, contact your dealer.

If a browser shuts down mid-use, the screen will return to the screen viewed prior to the browser startup.

■ To move icons on the home screen

You can change location on the home screen.

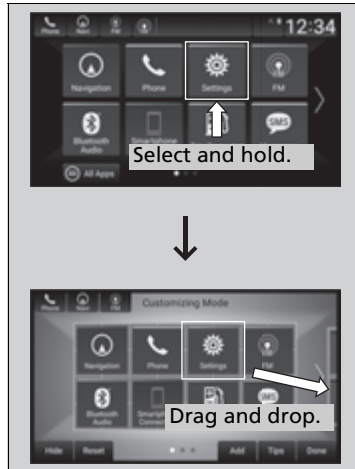

1. Select and hold an icon.
 - ▶ The screen switches to the customization screen.
2. Drag and drop the icon to where you want it to be.
3. Select **Done**.
 - ▶ The screen will return to the home screen.

☒ To move icons on the home screen

Select **Tips** to show tips. To hide them, select it again.

Continued

■ To remove icons on the home screen

You can delete the icons on the home screen.

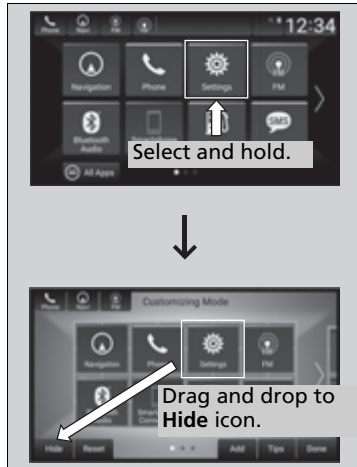

1. Select and hold an icon.
 - ▶ The screen switches to the customization screen.
2. Drag and drop the icon you want to remove to the **Hide** icon.
 - ▶ The icon is removed from the home screen.
3. Select **Done**.
 - ▶ The screen will return to the home screen.

▶▶ To remove icons on the home screen

Apps will not be deleted by deleting the icon on the home screen.

Select **Tips** to show tips. To hide them, select it again.

■ To shortcut icons on the home screen

You can store up to three icons on the upper left of the home screen.

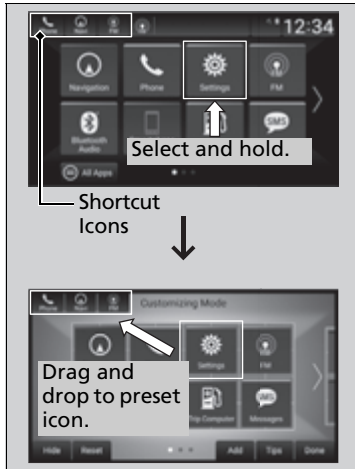



1. Select and hold an icon.
 - ▶ The screen switches to the customization screen.
2. Drag and drop the icon you want to store to the upper left of the home screen.
 - ▶ The icon is a shortcut.
3. Select **Done**.
 - ▶ The screen will return to the home screen.

☒ To shortcut icons on the home screen

Select **Tips** to show tips. To hide them, select it again.

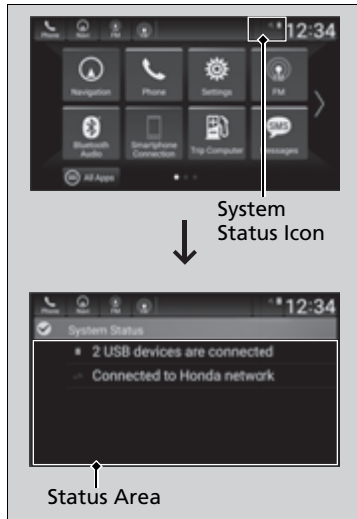
Status Area



1. Select the system status icon.
 - ▶ The status area appears.
2. Select an item to see the details.
3. Press the  button or select the system status icon to close the area.

■ Customizing the Meter

You can edit, show, or hide the meter contents on the driver information interface.

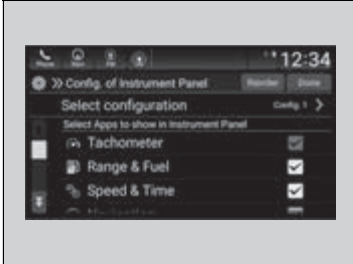

1. Press the  button.
2. Select **Settings**.
3. Select **System**.
4. Select **Config. of Instrument Panel**.
5. Select the content you wish to show or hide.
 - ▶ The checked items are displayed on the driver information interface.
6. Select **Done**.

■ Editing order

You can change the order of the contents on the driver information interface.

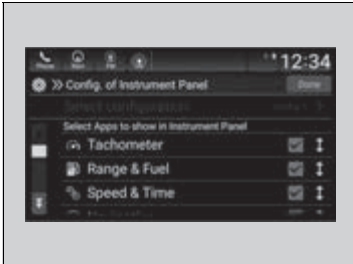

1. Press the  button.
2. Select **Settings**.
3. Select **System**.
4. Select **Config. of Instrument Panel**.
5. Select **Reorder**.
6. Select and hold the contents you want to move.
7. Drag and drop the contents to where you want them to be.
8. Select **Done**.

⌘ Customizing the Meter

You can store up to three customized configurations. To select or customize a configuration, select **Select configuration**.

System Updates*

The audio system's firmware can be updated with a Wi-Fi connection or with a USB device.

■ How to Update Wirelessly

■ Wireless connection mode setup

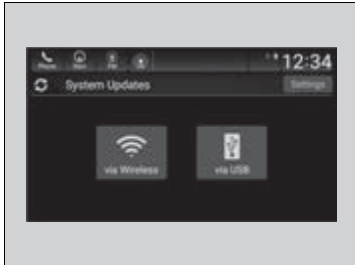

1. Press the  button.
2. Select **System Updates**.
3. Select **Settings**.
4. Select **Connection Setup**.
5. Select **Wi-Fi**.

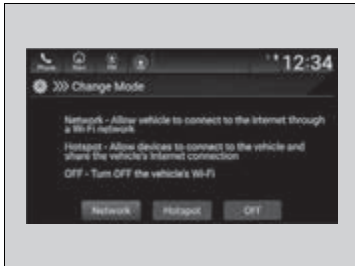

6. Select **Change Mode**.
7. Select **Network**, then **Confirm**.
 - ▶ The display returns to the network list.
8. Select an access point from the network list, then **Save**.
 - ▶ If the audio system requires a password, enter a password.

▶▶ Wireless connection mode setup

If your vehicle has a telematics control unit (TCU), you do not need the wireless connection mode setup.

■ How to update

When the audio system update is available, the notification is shown on the audio/information screen. Use the following procedure to update the system.

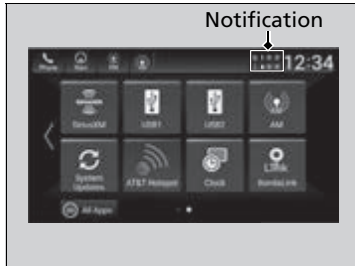

1. Press the  button.
2. Select **System Updates**.

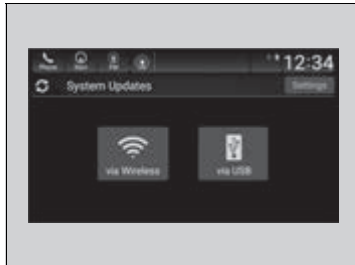

3. Select **via Wireless**.
 - ▶ If a notification is displayed on the screen, the screen of step 5 will be displayed.
4. Select **Download Now**.
 - ▶ A notification appears on the screen.

⌘ How to update

You can update the system via Wi-Fi, but cannot use the captive portal that require login or agreement the terms of use on the browser.

Your download will be canceled if:

- Your Wi-Fi connection is severed.
- You turn off the ignition when the battery is low on power.

Your download will recommence the next time a Wi-Fi connection is established.

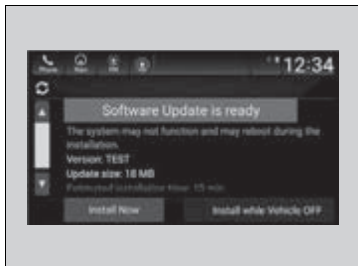

5. Select **Install Now** or **Install while Vehicle OFF**.

- ▶ A notification appears on the screen if the update is successful.

▶▶ How to update

For battery protection, **Install while Vehicle OFF** cannot be selected when the battery is low on power. If you want to install the updated data, recharge the battery or select **Install Now**.

■ Automatic download settings

Use the following procedure to change to the automatic download setting.

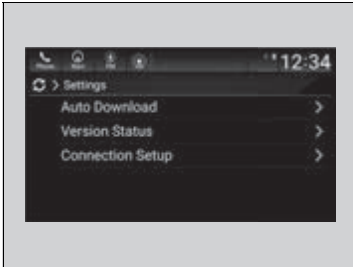

1. Press the  button.
2. Select **System Updates**.
3. Select **Settings**.
4. Select **Auto Download**.
5. Select the access point, then **Yes**.

■ View a version and update status



Use the following procedure to confirm the version and update status.

1. Press the  button.
2. Select **System Updates**.
3. Select **Settings**.
4. Select **Version Status**.

■ How to Update with a USB Device

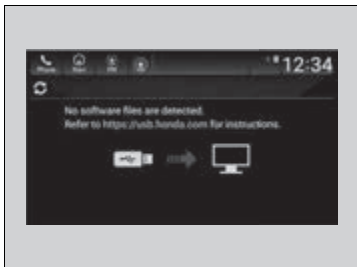
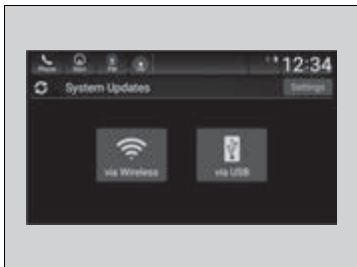
■ Download the update files from the server



1. Press the  button.
2. Select **System Updates**.
3. Select **via USB**.
 - ▶ A notification appears on the screen.
4. Connect a USB device into the USB port in the center pocket.
 - ▶ The inventory data is copied into the USB device.
 - ▶  **USB Ports** P. 247
5. Remove the USB device from the USB port.
6. Connect the USB device into your computer, and then download the update files.
 - ▶ Follow the link to download the required software update files. Refer to <https://usb.honda.com> for instructions.

▶▶ How to Update with a USB Device

A USB device with a minimum of 8 GB of free space or more is recommended.

Be sure to delete any previous inventory or update files from the USB before starting the USB update process.

■ Update the audio system

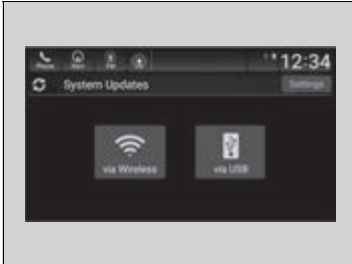

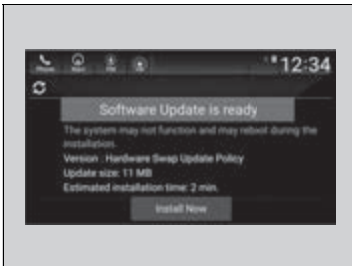

1. Press the  button.
2. Select **System Updates**.
3. Select **via USB**.
 - ▶ A notification appears on the screen.
4. Connect the USB device with the update files into the USB port.
 - ▶ A notification appears on the screen.
 - ▶ **USB Ports** P. 247

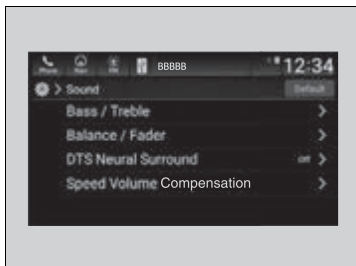
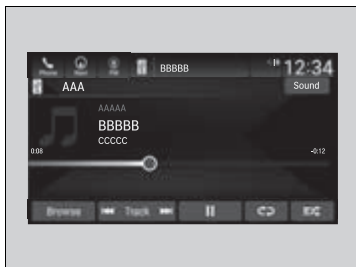

5. Select **Install Now**.
 - ▶ A notification appears on the screen if the update is successful.

Adjusting the Sound



1. Press the  button.
2. Select an audio source icon.
3. Select **Sound**.
4. Select the setting you want.
5. Select **Save**.

Select an item from the following choices:

- **Bass / Treble:** Treble, Midrange, Bass, Subwoofer*
- **Balance / Fader:** Balance, Fader
- **DTS Neural Surround*:** DTS Neural Surround™
- **Speed Volume Compensation:** Speed Volume Compensation (SVC)

▶▶ Adjusting the Sound

The SVC adjusts the volume level based on the vehicle speed. As you go faster, audio volume increases. As you slow down, audio volume decreases.

You can also adjust the sound by the following procedure.

1. Press the  button.
2. Select **Settings**.
3. Select **Sound**.

To reset each setting for **Bass / Treble**, **Balance / Fader**, **DTS Neural Surround*** and **Speed Volume Compensation** select **Default**.

Display Setup

You can change the brightness of the audio/information screen.

■ Changing the Screen Brightness



1. Press the  button.
2. Select **Settings**.
3. Select **Display**.
4. Select **Day Mode** or **Night Mode**.
5. Select the setting you want.
6. Select **Save**.

▣ Changing the Screen Brightness

You can change the **Contrast** and **Black Level** settings in the same manner.

To reset the settings, select **Default**.

■ Selecting an Audio Source

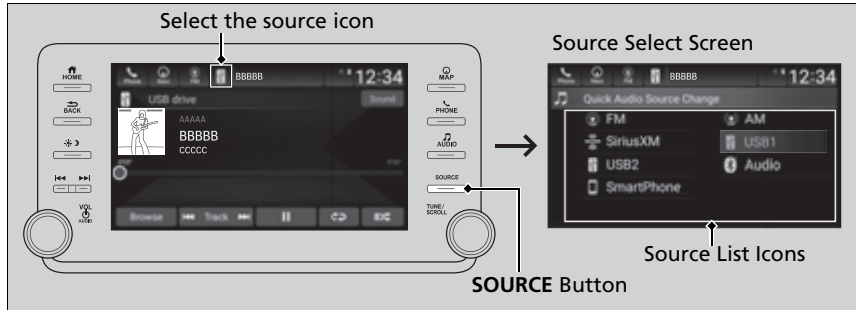



Select the current source icon or press the **SOURCE** button, then select an icon on the source list to switch the audio source.

■ Limitations for Manual Operation *

Certain manual functions are disabled or inoperable while the vehicle is in motion. You cannot select a grayed-out option until the vehicle is stopped.

Voice Control Operation

Your vehicle has a voice control system that allows hands-free operation.

The voice control system uses the  (talk) and  (back) buttons on the steering wheel and a microphone near the map lights on the ceiling.

Voice Recognition

To achieve optimum voice recognition when using the voice control system:

- Make sure the correct screen is displayed for the voice command that you are using.



The system recognizes only certain commands.

Available voice commands:

 **Voice Portal Screen** P. 276

- Close the windows and moonroof*.
- Adjust the dashboard and side vents so air does not blow onto the microphone on the ceiling.
- Speak clearly in a clear, natural speaking voice without pausing between words.
- Reduce any background noise if possible. The system may misinterpret your command if more than one person is speaking at the same time.

Voice Control Operation

When you press the  button, a helpful prompt asks what you would like to do. Press and release the  button again to bypass this prompt and give a command.

* Not available on all models

■ Voice Portal Screen

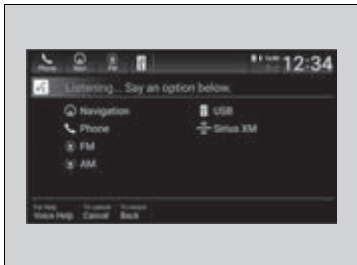

When the  (talk) button is pressed, available voice commands appear on the screen.

For a complete list of commands, say "Voice Help" after the beep.

The system only recognizes the commands on the following pages, at certain screens. Free-form voice commands are not recognized.

■ Phone Commands

These commands can only be used when a phone is connected. When the system recognizes a Phone command, the screen will change to the dedicated phone voice recognition screen.

■ Phone Commands

- *Phone*
- *Call <Your Contact Name>*
- *Call <Phone Number>*

The system only recognizes contact names stored in the phonebook of your phone. If a full name is registered in the first name field, the system will recognize the first name and last name as one contact name.

Phone commands are not available if using Apple CarPlay.

■ Audio Commands

When the system recognizes an Audio command, the screen will change to the dedicated audio voice recognition screen.

■ FM Commands

- *FM*
- *Tune to <87.7-107.9> FM*

■ AM Commands

- *AM*
- *Tune to <530-1710> AM*

■ Sirius XM Commands*

- *Sirius XM*
- *Channel <1-999>*
- *Channel <station name>*

■ USB Commands

- *USB*
- *Play genre <Genre name>*
- *Play Artist <Artist name>*
- *Play Album <Album name>*
- *Play Playlist <Playlist name>*
- *Play Song <Song name>*
- *Play Music*
- *List Genre <Genre name>*
- *List Artist <Artist name>*
- *List Album <Album name>*
- *List Playlist <Playlist name>*

■ Navigation Commands*1

The system will accept navigation voice commands when on the dedicated voice command screen for navigation.

📖 **Refer to the Navigation System Manual**

■ Standard Commands

- *Voice Help*
- *Cancel*
- *Back*

Voice Help provides guidance for the current screen.

*1: Models with navigation system

Playing AM/FM Radio

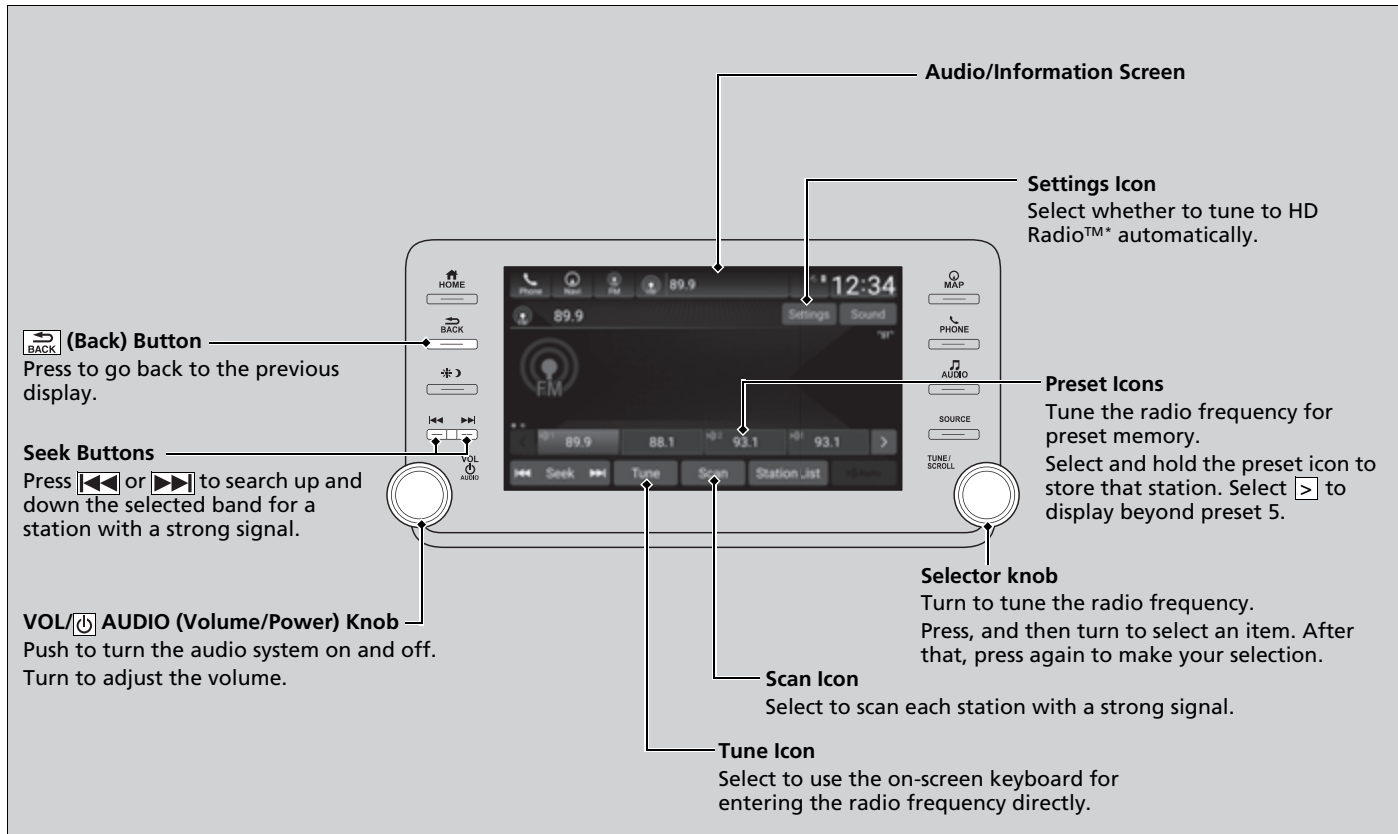

■ Preset Memory

To store a station:

1. Tune to the selected station.
2. Select and hold the preset icon for the station you want to store.

■ Station List

Lists the strongest stations on the selected band.

1. Select **Station List** to display a list.
2. Select the station.

■ Manual update

Updates your available station list at any time.

1. Select **Station List** to display a list.
2. Select **Refresh**.

▶▶ Preset Memory

The **ST** indicator appears on the display indicating stereo FM broadcasts. Stereo reproduction in AM is not available.

Switching the Audio Mode

Roll the left selector wheel or select the audio source icon on the screen.

▶▶ **Audio Remote Controls** P. 250

You can store 12 AM/FM stations into preset memory.

Models with HD Radio™ feature

HD Radio Technology manufactured under license from iBiquity Digital Corporation. U.S. and Foreign Patents. For patents see <http://dts.com/patents>. HD Radio, Artist Experience, and the HD, HD Radio, and "ARC" logos are registered trademarks or trademarks of iBiquity Digital Corporation in the United States and/or other countries.



■ Scan

Samples each of the strongest stations on the selected band for 10 seconds. To turn off scan, select **Stop** or .

■ Radio Data System (RDS)

Provides text data information related to your selected RDS-capable FM station.

■ To find an RDS station from Station List

1. Select **Station List** to display a list while listening to an FM station.
2. Select the station.

■ Manual update

Updates your available station list at any time.

1. Select **Station List** to display a list while listening to an FM station.
2. Select **Refresh**.

▶▶ Radio Data System (RDS)

When you select an RDS-capable FM station, the RDS automatically turns on, and the frequency display changes to the station name. However, when the signals of that station become weak, the display changes from the station name to the frequency.

Models with HD Radio™ feature

■ HD Subchannel

Displays the subchannel list when an HD Radio™ station is selected while listening to an FM station.

1. Select **HD Radio Channels**.
2. Select the channel number.

■ AM/FM Settings

Change the AM/FM settings.

1. Select **Settings**.
 2. Select an option.
- **HD Radio:** Automatically choose a digital or an analog channel, or listen to analog only.
 - **Artwork:** Turns the artwork display on and off.

Playing SiriusXM® Radio *

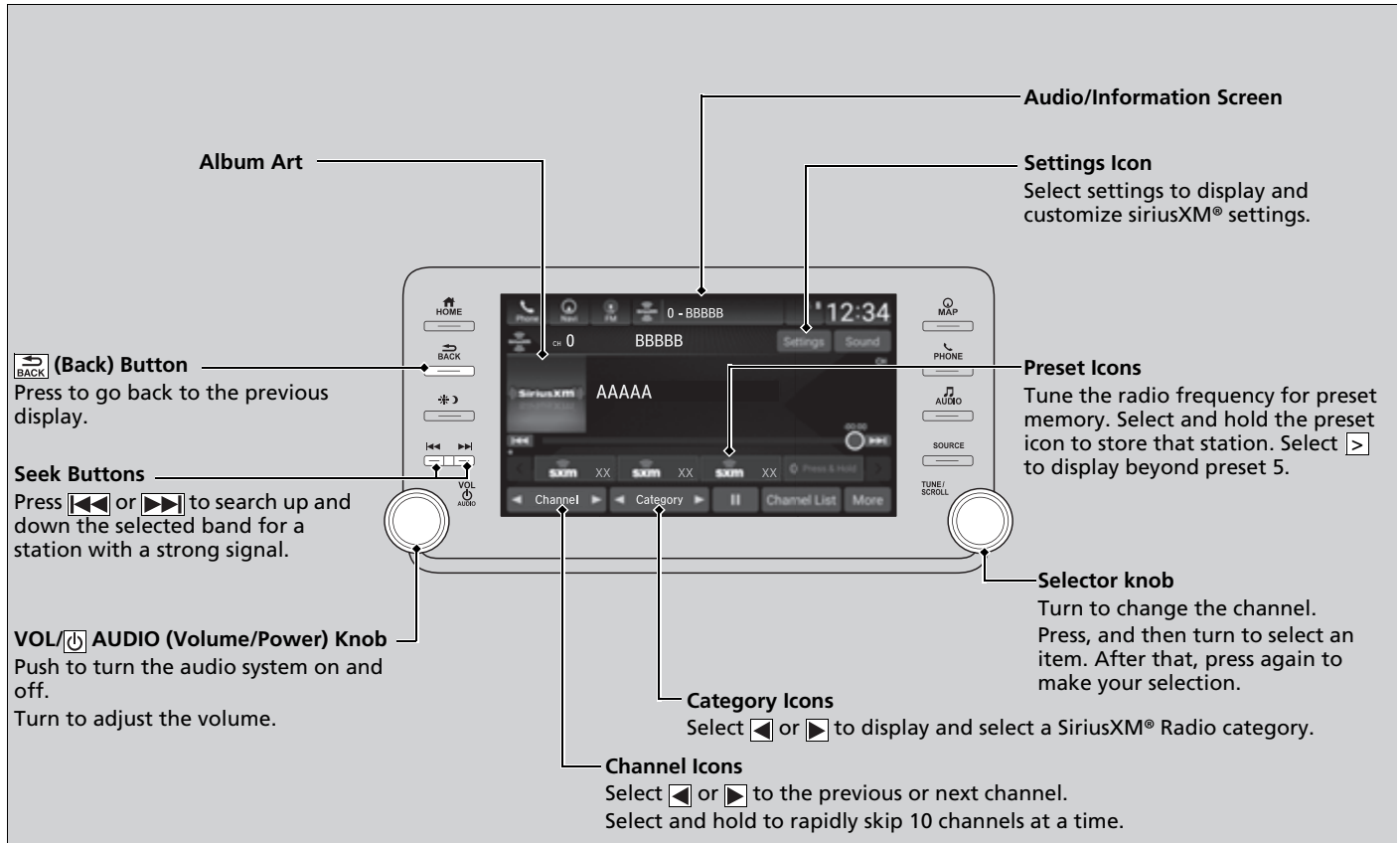

■ To Change the Tune Mode

1. Select **Settings**.
2. Select **Tune Mode**.
3. Select **Channel** or **Category**.

▶▶ Playing SiriusXM® Radio*

In the channel mode, all available channels are selectable. In the category mode, you can select a channel within a category (Jazz, Rock, Classical, etc.).

There may be instances when SiriusXM® Radio does not broadcast all the data fields (artist name, title). This does not indicate a problem with your audio system.

SiriusXM® Radio stations load in ascending order, which can take about a minute. Once they have loaded you will be able to scroll up or down to make your selections.

Switching the Audio Mode

Roll up or down the left selector wheel to select **Audio** or select the audio source icon on the screen.

▶▶ **Audio Remote Controls** P. 250

Tune Start:

When you change to a preset channel, a song being played on that channel restarts from the beginning with this function. This can be turned on or off by the following procedure.

1. Select **Settings**.
2. Select **Tune Start**.
3. Select **ON** or **OFF**.

To change a category, select **Category** icons, or select **More** and then select **Category List**.

■ Preset Memory

To store a channel:

1. Tune to the selected channel.
2. Select and hold the preset number for the station you want to store.

■ Multi-channel preset (for music channels only)

You can store up to 10 of your preferred music channels per preset.

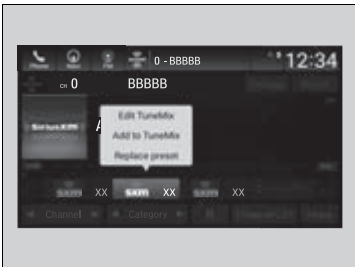

1. Tune a station.
2. Select and hold the preset number you want to add a music channel.
3. Select **Add to TuneMix** or **Create TuneMix**.
 - ▶ A message appears if there are no available presets.

▶▶ Preset Memory

You can store 12 SiriusXM® channels into the preset memory.

▶▶ Multi-channel preset (for music channels only)

TuneMix:

The multi-channel preset function can be turned on or off by the following procedure.

1. Select **Settings**.
2. Select **TuneMix**.
3. Select **ON** or **OFF**.

When you want to replace the channel, select

Replace preset.

If you want to delete a channel, select **Edit TuneMix**, and then select the channel you want to delete.

■ Listening to Featured Channels

Suggested channel listing received from SiriusXM® can be displayed and selected.

1. Select **Category List**.
2. Select **Featured Favorite**.

☒ Listening to Featured Channels

Up to ten featured channels by SiriusXM® can be displayed.



Featured channel lists are at the top of the channel list.

To switch the sorting method, select **Number** or **Name** on the upper right of the screen.

Select **Keypad** to use the on-screen keyboard for entering the channel number directly.

■ Replay Function

The system can record up to the last 60 minutes broadcast of your currently tuned channel as well as the last 30 minutes broadcast of preset channels, starting from the moment you turn the vehicle on. If you tuned to preset channel, the system records up to 60 minutes of a broadcast instead of up to 30 minutes. You can rewind and replay the last 30 or 60 minutes of a broadcast.

Move the position you want to replay by selecting  or .

To play or pause on playback mode, select the play/pause icon.

■ Returning to real-time broadcast

Select and hold .

▶▶ Replay Function

The system starts storing broadcast in memory when the power mode is turned ON. You can go back to the program from that point.

You can no longer replay any program once the power mode is turned off as it erases memory. You can check how long the program has been stored in memory from the audio/information screen.

After 30 or 60 minutes of recording the system will automatically start deleting the oldest data.

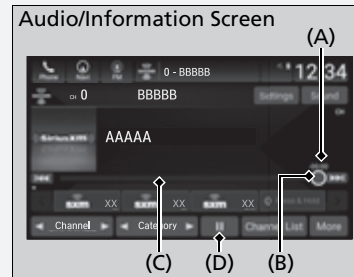

- (A): Shows how much time the replayed segment is behind the real-time broadcast
- (B): Replayed segment
- (C): Length stored in memory
- (D): Play/Pause icon

■ Live Sports Alert

While listening to other channel, you can receive sports alerts such as scores from your favorite teams.

■ To set up a favorite team

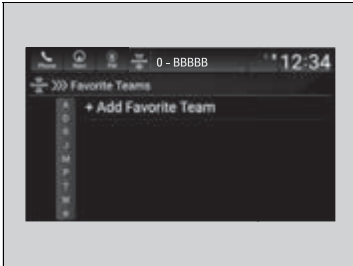

1. Select **Settings**.
2. Select **Sports Notifications Setup**.
3. Select **Favorite Teams**.
4. Select **+ Add Favorite Team**.
5. Select a team.

■ To set up an alert message

1. Select **Settings**.
2. Select **Sports Notifications Setup**.
3. Select **Notifications**.
4. Select **Game Notifications** or **SportsFlash Game Play Notifications**.
5. Select **Notifications**.
6. Select **ON**.
7. Select a favorite team.

☒ Live Sports Alert

The Pop-up appears and notifies you of a sports alert function.

☒ To set up a favorite team

Sports alerts cut in only when SiriusXM® mode is on.

■ Traffic and Weather Information

You can receive traffic and weather information.

1. Select **Settings**.
2. Select **Traffic & Weather Now Setup**.
3. Select **Selected City**.
4. Select the region.

☒ Traffic and Weather Information

When traffic and weather information is received, a notification is displayed in the header area.

☒ **Status Area** P. 264

Channel Schedule

You can view a channel schedule or receive an alert when your favorite program is about to start.

To view a channel schedule

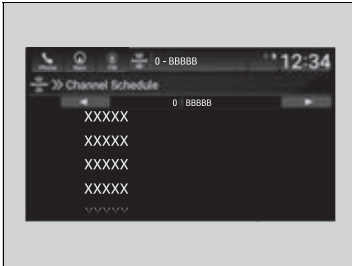

1. Select **More**.
2. Select **Channel Schedule**.

To set up an alert message

1. Select **More**.
2. Select **Channel Schedule**.
3. Select a program.
4. Select **Set Program Alert**.
5. Select **Just Once** or **Every Time**.

Channel Schedule

Select **Keypad** to use the on-screen keyboard for entering the channel number directly.

To set up an alert message

The Pop-up appears and notifies you of an alert function.

Selecting **Just Once** disables the alert feature next time you turn the power mode to ON.

If you want to delete the alert, select **Remove Alert**.

To enable an alert message, change settings for the alert function.

▶ **To enable the alert function** P. 290

■ Manage Program Alert

You can change settings for the alert function.

■ To enable the alert function

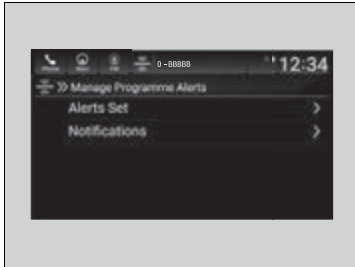

1. Select **Settings**.
2. Select **Manage Program Alerts**.
3. Select **Notifications**.
4. Select **ON** or **OFF**.

■ To remove an alert

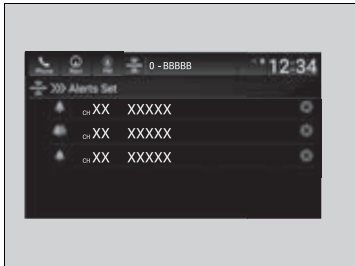

1. Select **Settings**.
2. Select **Manage Program Alerts**.
3. Select **Alerts Set**.
4. Select  on the alert you want to delete.
 - ▶ A confirmation message appears on the screen. Select **Yes**.

■ Scan

Sample each channel on the selected mode for 10 seconds.

1. Select **More**.
2. Select **Scan**.

You can change a scan mode by the following procedure.

1. Select **Settings**.
2. Select **Scan Mode**.
3. Select **Channel** or **Preset**.

To turn off scan, select **Stop**.

☒ Scan

The "Scan Songs in Presets" function is based on TuneScan™ technology of SiriusXM®.

The "Featured Channels" function is based on Featured Favorites™ technology of SiriusXM®.

TuneScan™ and Featured Favorites™ are registered trademarks of SiriusXM® Radio, Inc.

■ SiriusXM® Settings

Change the SiriusXM® settings.

1. Select **Settings**.
2. Select an option.

- **TuneMix:** Turns multiple channel mix preset on and off.
- **Tune Mode:** Choose whether to group by category or channel number when changing channels.
 - ▶ **To Change the Tune Mode** P. 283
- **Scan Mode:** Select the scan mode from all channels or presets.
 - ▶ **Scan** P. 291
- **Tune Start:** Start the currently playing song at the beginning when you switch to a music channel preset.
 - ▶ **Tune Start:** P. 283
- **Sports Notifications Setup:** Set to receive sports alerts such as scores from your favorite teams.
 - ▶ **Live Sports Alert** P. 287
- **Traffic & Weather Now Setup:** Set to receive traffic and weather information.
 - ▶ **Traffic and Weather Information** P. 288
- **Manage Program Alerts:** Change settings for the alert function.
 - ▶ **Manage Program Alert** P. 290

Playing an iPod

Using your USB connector, connect the iPod to the USB port(s), then select the iPod mode.

📖 **USB Ports** P. 247

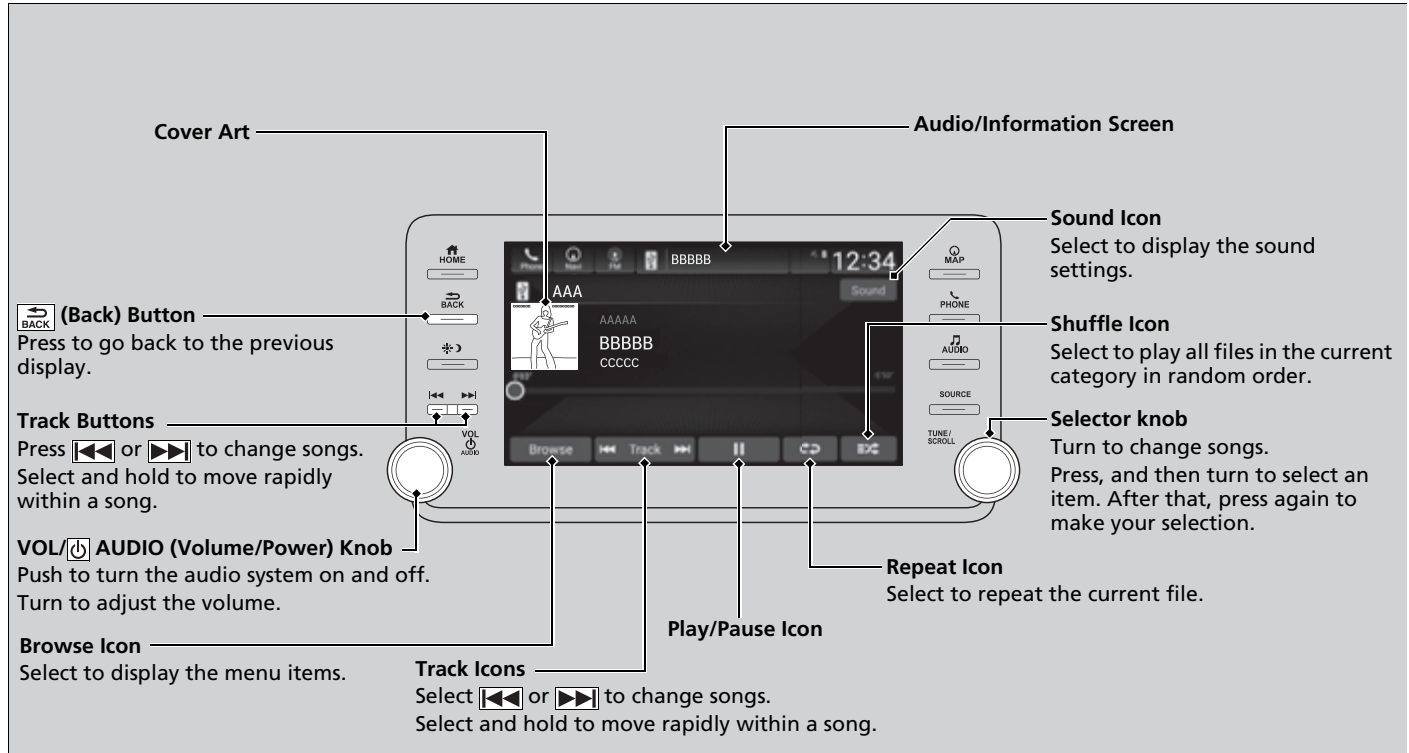

How to Select a Song from the Music Search List

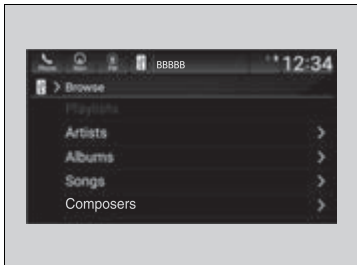

1. Select **Browse**.
2. Select a search category (e.g., Artists, Albums, etc.).
3. Continue making selections until you find the song of your choice.

▶▶ Playing an iPod

Available operating functions vary on models or versions. Some functions may not be available on the vehicle's audio system.

If there is a problem, you may see an error message on the audio/information screen.

▶▶ **iPod/USB Flash Drive** P. 327

If you operate the music app on your iPhone/iPod while the phone is connected to the audio system, you may no longer be able to operate the same app on the audio/information screen. Reconnect the device if necessary.

If an iPhone is connected via Apple CarPlay, the iPod/USB source will be unavailable and audio files on the phone will be playable only within Apple CarPlay.

How to Select a Play Mode

You can select shuffle and repeat modes when playing a file.

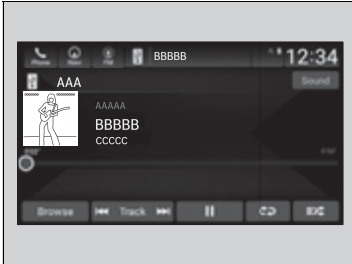

■ Shuffle/Repeat

Repeatedly select the shuffle or repeat icon until you find a play mode option of your preference.



■ To turn off a play mode

Select the mode you want to turn off.



How to Select a Play Mode

Play Mode Menu Items

Shuffle

-  **Shuffle off:** Shuffle mode to off.
-  **Shuffle All Songs:** Plays all available songs in a selected list in random order.

Repeat

-  **Repeat off:** Repeat mode to off.
-  **Repeat Song:** Repeats the current song.
-  **Repeat all:** Repeats the all songs.

Playing a USB Flash Drive

Your audio system reads and plays audio files on a USB flash drive in either MP3, WMA, AAC*1, FLAC, or WAV format.

Connect your USB flash drive to the USB port(s), then select the USB mode.

➤ **USB Ports** P. 247

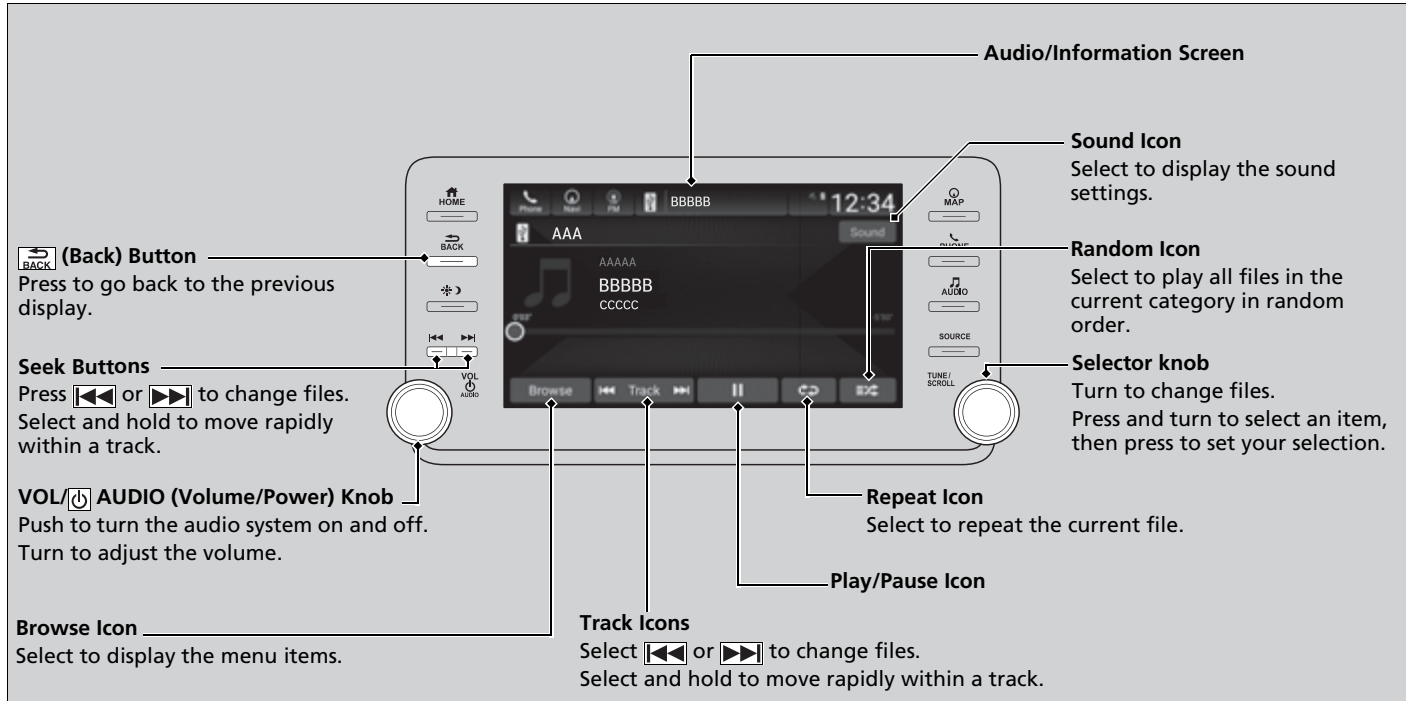

*1: Only AAC format files recorded with iTunes are playable on this unit.

How to Select a File from the Music Search List

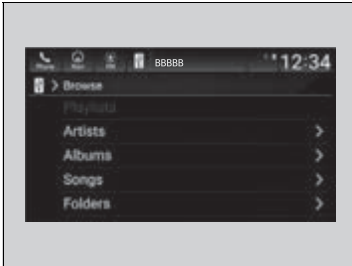

1. Select **Browse**.
2. Select a search category (e.g., Artists, Albums, etc.).
3. Continue making selections until you find the song of your choice.

▶▶ Playing a USB Flash Drive

Use the recommended USB flash drives.

▶ **General Information on the Audio System**
P. 329

WMA files protected by digital rights management (DRM) cannot be played.

The audio system displays **The selected file cannot be played**, then skips to the next file.

If there is a problem, you may see an error message on the audio/information screen.

▶ **iPod/USB Flash Drive** P. 327

■ How to Select a Play Mode

You can select repeat and random modes when playing a file.

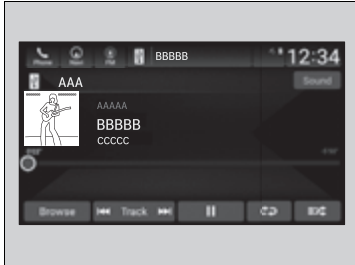

■ Random/Repeat

Select random or repeat icon repeatedly until a desired mode.

■ To turn off a play mode

Select the mode you want to turn off.

▶▶ How to Select a Play Mode

Play Mode Menu Items

Random



Random off: Random mode to off.



Random All Tracks: Plays all files in random order.



Random in Folder: Plays all files in the current folder in random order.

Repeat



Repeat off: Repeat mode to off.



Repeat track: Repeats the current folder.



Repeat all: Repeats the all songs.

Playing *Bluetooth*® Audio

Your audio system allows you to listen to music from your *Bluetooth*-compatible phone.

This function is available when the phone is paired and connected to the vehicle's *Bluetooth*® HandsFreeLink® (HFL) system.

📌 **Phone Setup** P. 379

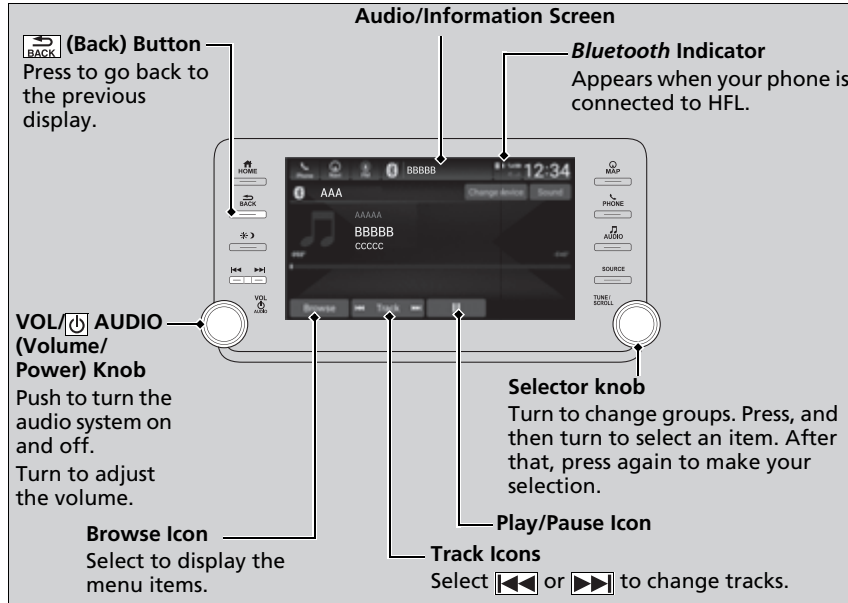

▶▶ Playing *Bluetooth*® Audio

Not all *Bluetooth*-enabled phones with streaming audio capabilities are compatible with the system. For a list of compatible phones:

- U.S.: Visit automobiles.honda.com/handsfreelink/, or call 1-888-528-7876.
- Canada: For more information on smartphone compatibility, call 1-855-490-7351.

It may be illegal to perform some data device functions while driving.

Only one phone can be used with HFL at a time. When there is more than one paired phone in the vehicle, the first paired phone the system finds is automatically connected.

The connected phone for *Bluetooth*® Audio can be different.

If more than one phone is paired to the HFL system, there may be a delay before the system begins to play.

In some cases, the name of the artist, album, or track may not appear correctly.

Some functions may not be available on some devices.

If a phone is currently connected via Apple CarPlay or Android Auto, *Bluetooth*® Audio from that phone will be unavailable. However, you can have a second previously paired phone stream *Bluetooth*® Audio by selecting  from the *Bluetooth*® device list.

📌 **Phone Setup** P. 379

Continued

■ To Play *Bluetooth*® Audio Files

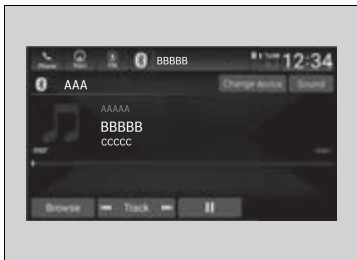

1. Make sure that your phone is paired and connected to the system.

▶ **Phone Setup** P. 379

2. Select the *Bluetooth*® Audio mode.

If the phone is not recognized, another HFL-compatible phone, which is not compatible for *Bluetooth*® Audio, may already be connected.

■ To play or pause a file

Select the play/pause icon.

■ Searching for Music

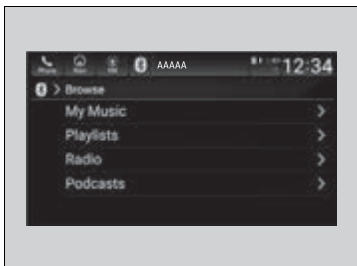

1. Select **Browse**.

2. Select a search category (e.g., Albums).

3. Select an item.

▶ The selection begins playing.

▶▶ To Play *Bluetooth*® Audio Files

To play the audio files, you may need to operate your phone. If so, follow the phone maker's operating instructions.

Switching to another mode pauses the music playing from your phone.

You can change the connected phone by selecting **Change device**.

▶ **Phone Setup** P. 379

▶▶ Searching for Music

Depending on the *Bluetooth*® device you connect, some or all of the lists may not be displayed.

HondaLink®

HondaLink® connects you to the latest information from Honda. You can connect your phone wirelessly through Wi-Fi or *Bluetooth®*.

📶 **Wi-Fi Connection** P. 310

📶 **Phone Setup** P. 379

■ To Connect to HondaLink®

Use the following procedure to connect to HondaLink®.

■ To enable the HondaLink®

You must consent to location sharing to enable the HondaLink®.



Disable: Does not allow this consent.

Enable Once: Allows only one time. (Shows again next time.)

Always Enable: Allows anytime. (Never show again.)

▶▶ HondaLink®

If your vehicle has a telematics control unit (TCU), you can use HondaLink® without connecting the phone.

The HondaLink® connect app is compatible with most iPhone and Android phones.

If the system is connected to the HondaLink® connect app through *Bluetooth®* and another *Bluetooth®* audio device is connected, the *Bluetooth®* connection to the HondaLink® connect app will be severed.

Some cell phone carriers charge for tethering and smartphone data use. Check your phone's data subscription package.

■ To link with HondaLink®

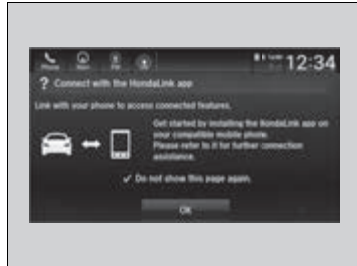

You may see the connection guide screen after launching HondaLink® when there is no connection available.

■ HondaLink® Menu



■ Connect

Displays instruction messages when the vehicle needs service.

■ Help & Support

Displays tips for vehicle usage, and get support via roadside or customer service center.

■ Message

Displays helpful and important information from Honda.

■ Vehicle Information and Message from Honda Tips

You can check the messages that are received quickly in the shortcut operation.



1. A notification appears and notifies you of a new message in the header area.

2. A notification is continuously displayed in the header area until the new message is read.



3. Select the system status icon to see the messages.

4. Select a new message to open.
▶ If you have selected the update option for HondaLink®, follow the directions on the screen to complete the process.

▶▶ Vehicle Information and Message from Honda Tips

When you update HondaLink®, you must keep the engine running and maintain a constant connection with HondaLink®.

If the update is interrupted, the system will automatically resume the process. If, however, a week has elapsed since the process was first interrupted, you must repeat the process from the beginning.

You can update HondaLink® by selecting **Message from Honda** on the HondaLink® menu.

HondaLink® Service*

Is a subscription-based service that provides convenient features such as voice communication in case of emergency, online security, and one-on-one operator assistance.

In Case of Emergency

Automatic collision notification



If your vehicle's airbags deploy or if the unit detects that the vehicle is severely impacted, your vehicle automatically will attempt to connect to the HondaLink® operator. If connected, information about your vehicle, its location, and its condition can be sent to the operator*¹; you also can speak to the operator when connected.

IMPORTANT: In a crash, HondaLink® will attempt to notify emergency services but NEITHER HONDA NOR ITS SERVICE PROVIDERS GUARANTEE THAT SUCH NOTIFICATION WILL OCCUR.

Honda reserves the right to terminate HondaLink® services at any time or for any reason, and in the future may not be able to provide services due to changes in, or obsolescence of, technology integral to the service or changes in governmental regulation.

*1: Depending on your phone and adequate cellular coverage, your vehicle's location may not be sent to the operator.

* Not available on all models

Continued

▶▶ HondaLink® Service*

HondaLink® also provides services you can operate from the Internet or your smartphone.

To subscribe to HondaLink®, or to get more information about all of its features, contact a Honda dealer, or visit hondalink.honda.com

▶▶ In Case of Emergency

Your vehicle may not be able to connect to the operator if the battery level is low, the line is disconnected, or you do not have adequate cellular coverage.

You cannot use this emergency services when:

- You travel outside the HondaLink® service coverage areas.
- There is a problem with the connecting devices, such as the microphones, speakers, or the unit itself.

You cannot operate other phone-related functions using the screen while talking to the operator. Only the operator can terminate the connection to your vehicle.

▶▶ Automatic collision notification

If the unit fails to connect to the operator, it repeatedly tries until it succeeds.

Manual operator connection

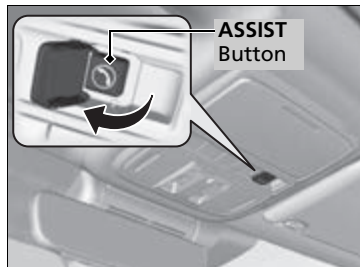

If you need to talk to the HondaLink® operator in a situation where no airbag has deployed, you can manually connect to them by pressing the **ASSIST** button with the power mode in ACCESSORY or ON.

1. Open the cover attached to the ceiling console.
2. Press the **ASSIST** button.
 - ▶ You are connected to the HondaLink® operator.

Manual operator connection

Do not press the button while driving. When you need to contact the operator, park the vehicle in a safe place.

If the unit fails to connect to the operator, it automatically cancels the action after three minutes.

If necessary, the cover can be broken to access the **ASSIST** button.

■ Security Features

Your subscribed telematics service provider can track your vehicle's location, remotely lock or unlock doors, and help you find your vehicle. To use these features, you need your user ID and personal identification number (PIN).

■ Stolen vehicle tracking

This feature searches and tracks down your vehicle position even if it is on the move. If you believe that your vehicle has been stolen, contact the police as well as the provider.

■ Remote door lock/unlock

The provider can remotely lock or unlock doors upon your request.

■ Vehicle finder

This feature is convenient to use when trying to locate your vehicle in large areas, such as a crowded parking lot. If you cannot locate your vehicle after using the remote transmitter's answerback function, you can contact the provider which can then flash your vehicle's exterior lights and sound the horn, and sends vehicle location via web/Smartphone.

■ Security alarm notification

If the security system in your vehicle detects an abnormal condition, such as someone tampering with the lock on your vehicle, the provider notifies you by email.

☒ Security Features

The contact information of your provider, your user ID and PIN will be given when you subscribe to HondaLink®. If you forget any of the above, contact a Honda dealer, or go to hondalink.honda.com.

You can also activate the remote door lock/unlock and vehicle finder features from the Internet or using your smartphone app. Ask a dealer, or visit hondalink.honda.com.

☒ Vehicle finder

The lights will stop flashing and horn will stop sounding under the following:

- When conditions 30 seconds have elapsed.
- You unlock the doors using the remote transmitter.
- You unlock the doors using the keyless access system.
- You unlock the doors using the built-in key.
- The power mode is set to ACCESSORY or ON.

■ Operator Assistance

Connect to the HondaLink® operator when trying to find a destination or for roadside assistance.

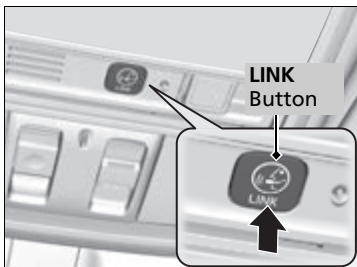

1. Press the **LINK** button.
 - ▶ Connection to the operator begins.
2. Talk to the operator.
 - ▶ To disconnect, select **Hang Up** on the audio/information screen or press the  button on the steering wheel.

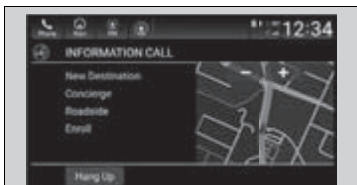

Audio/information screen when connected to the HondaLink® operator.

▶▶ Operator Assistance

Remain attentive to road conditions and driving during operator assistance.

If you want to add or renew a subscription, call the Operator Assistance.

1. Press the  button.
2. Select **HondaLink**.
3. Select **HondaLink Subscription Status**.

■ Convenient Features

Your subscribed telematics service provider can check your vehicle's condition.

■ Virtual Dashboard

You can remotely check the mileage, fuel range, and oil life in your app.

■ Remote Start and stop the engine

You can remotely start and stop engine using your app as same as the keyless remote.

■ Geofence Alert

You can receive a notification anytime your vehicle enters or leaves a region set by you.

■ Speed Alert

You can receive a notification when your vehicle has exceeded a speed limit set by you.

■ Personal Data Wipe

You can reset your audio and navigation system settings to factory defaults with the app.

■ Wi-Fi hotspot

Vehicle provides 4G LTE network environment as Wi-Fi router to use tablet or smartphone in your vehicle.

☒ Convenient Features

The contact information of your provider, your user ID and PIN will be given when you subscribe to HondaLink®. If you forget any of the above, contact a Honda dealer, or go to hondalink.honda.com.



You cannot use Wi-Fi hotspots when you are connected wirelessly to Apple CarPlay or Android Auto.

Wi-Fi Connection

This vehicle is equipped with Wi-Fi connectivity. You can connect to an external Wi-Fi hotspot or communication device.

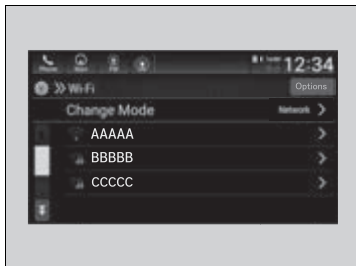
Connect the Vehicle to a Wi-Fi Hotspot



1. Press the  button.
2. Select **Settings**.
3. Select **Connections**.
4. Select **Wi-Fi**.
5. Select **Change Mode**.
6. Select **Network** or **Hotspot**, then **Confirm**.
 - ▶ To change the Wi-Fi settings, select **Options** or **Setup**.
 - ▶ Select the access point you want to connect to the system.
7. Select **Connect**.
 - ▶ Enter a password for the access point, and select **Done**.
 - ▶ When the connection is successful, the  icon is displayed on the list.
8. Press the  button to go back to the home screen.

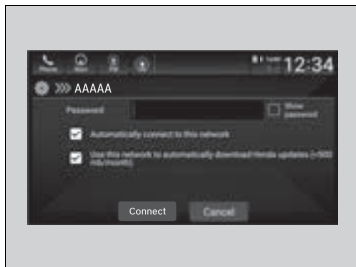

Wi-Fi Connection

Wi-Fi and Wi-Fi Direct are registered trademarks of Wi-Fi Alliance®.



Connect the Vehicle to a Wi-Fi Hotspot

You cannot go through the setting procedure while the vehicle is moving. Park in a safe place to set the audio system in Wi-Fi mode.

Some cell phone carriers charge for tethering and smartphone data use. Check your phone's data subscription package.

Check your phone manual to find out if the phone has Wi-Fi connectivity.

You can confirm whether Wi-Fi connection is on or off with the  icon on the Wi-Fi network list. Transmission speed and others will not be displayed on this screen.

In case of Wi-Fi connection with your phone, make sure your phone's Wi-Fi setting is in access point (tethering) mode.

AT&T Hotspot*

If you have subscribed to AT&T hotspot services, your vehicle will provide data to connect your mobile devices to the Internet. You can use the AT&T Hotspot app to turn on/off vehicle data and monitor data usage left on your subscription.

■ AT&T Hotspot Menu



1 Hotspot Enable

Turn on/off AT&T Hotspot.

2 Data Usage Bar

Check the current status of your data plan. This Usage Bar will show your current plan and how much data remains on your plan. Subscription plans for AT&T Hotspot can be added/modified at www.att.com/honda.

3 Plan Info

Shows your current AT&T subscription plan for the vehicle.

4 Settings

Shows the current username and password for vehicle Hotspot. **Settings** can be changed while the vehicle is not in motion.

5 Help

▶ AT&T Hotspot*

To use AT&T Hotspot services, your vehicle must be subscribed to a data plan. If your vehicle is not subscribed to a data plan, you can visit www.att.com/honda to add vehicle data services.

Hotspot username and password can be changed in the **Settings** of the AT&T Hotspot app. **Settings** cannot be accessed while driving. Park in a safe place to adjust Hotspot settings.

Alternatively, you can use your mobile hotspot to connect the vehicle and other mobile devices to the Internet.

▶ **Wi-Fi Connection** P. 310

* Not available on all models

Siri Eyes Free*

You can talk to Siri by pressing and holding the  (Talk) button on the steering wheel when your iPhone is paired to the *Bluetooth*® HandsFreeLink® (HFL) system.

➤ **Phone Setup** P. 379

▶▶ Siri Eyes Free*

Siri is a trademark of Apple Inc.

Check Apple Inc. website for features available for Siri.

We recommend against using Siri other than in Siri Eyes Free while operating a vehicle.

▶▶ Using Siri Eyes Free

Some commands work only on specific phone features or apps.

■ Using Siri Eyes Free

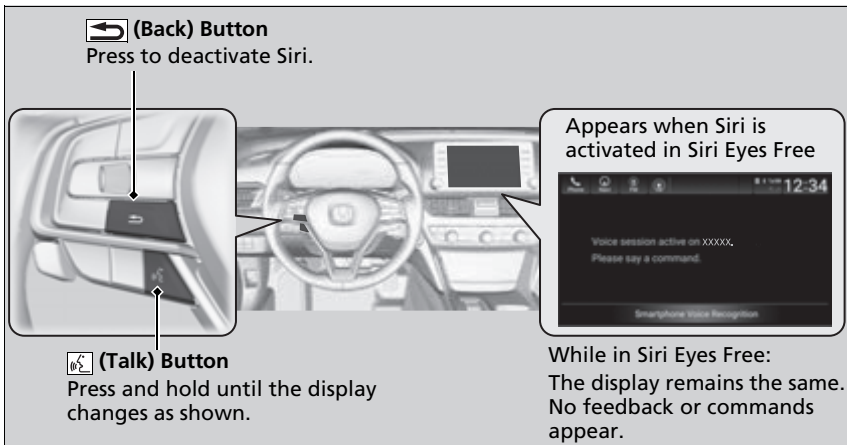

 **(Back) Button**
Press to deactivate Siri.

 **(Talk) Button**
Press and hold until the display changes as shown.

Appears when Siri is activated in Siri Eyes Free

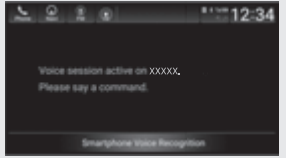

While in Siri Eyes Free:
The display remains the same. No feedback or commands appear.

Apple CarPlay

If you connect an Apple CarPlay-compatible iPhone to the system via the USB port in the center pocket or wirelessly*, you can use the audio/information screen, instead of the iPhone display, to make a phone call, listen to music, view maps (navigation), and access messages.

📄 **USB Ports** P. 247

■ Apple CarPlay Menu

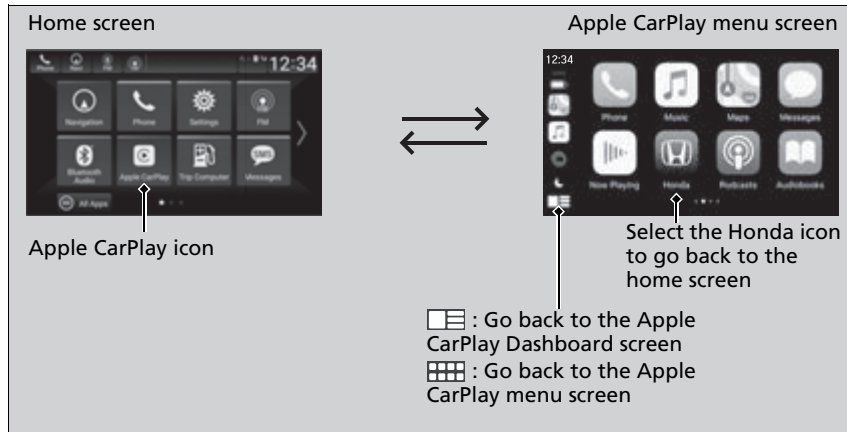

■ Phone

Access the contact list, make phone calls, or listen to voicemail.

■ Messages

Check and reply to text messages, or have messages read to you.

* Not available on all models

📄 Apple CarPlay

Only iPhone 5 or newer versions with iOS 8.4 or later are compatible with Apple CarPlay.

We recommend using the latest OS.

Park in a safe place before connecting your iPhone to Apple CarPlay and when launching any compatible apps.

While connected to Apple CarPlay, calls are only made through Apple CarPlay. If you want to make a call with HandsFreeLink®, turn Apple CarPlay OFF.

📄 **Setting Up Apple CarPlay** P. 315

When your iPhone is connected to Apple CarPlay, it is not possible to use the *Bluetooth*® Audio or *Bluetooth*® HandsFreeLink®. However, other previously paired phones can stream audio via *Bluetooth*® while Apple CarPlay is connected.

📄 **Phone Setup** P. 379

Apple CarPlay and Android Auto cannot run at the same time.

For details on countries and regions where Apple CarPlay is available, as well as information pertaining to function, refer to the Apple homepage.

Continued

■ Music

Play music stored on your iPhone.

■ Maps

Display Apple Maps and use the navigation function just as you would on your iPhone.

Models with navigation system

Only one navigation system (pre-installed navigation or Apple CarPlay) can give directions at a time. When you are using one system, directions to any prior destination set on the other system will be canceled, and the system you are currently using will direct you to your destination.

▶▶ Apple CarPlay

Apple CarPlay Operating Requirements & Limitations

Apple CarPlay requires a compatible iPhone with an active cellular connection and data plan. Your carrier's rate plans will apply.

Changes in operating systems, hardware, software, and other technology integral to providing Apple CarPlay functionality, as well as new or revised governmental regulations, may result in a decrease or cessation of Apple CarPlay functionality and services. Honda cannot and does not provide any warranty or guarantee of future Apple CarPlay performance or functionality.

It is possible to use 3rd party apps if they are compatible with Apple CarPlay. Refer to the Apple homepage for information on compatible apps.

■ Setting Up Apple CarPlay

After you have connected your iPhone to the system via the front USB port or wirelessly*, use the following procedure to set up Apple CarPlay. Use of Apple CarPlay will result in the transmission of certain user and vehicle information (such as vehicle location, speed, and status) to your iPhone to enhance the Apple CarPlay experience. You will need to consent to the sharing of this information on the audio/information screen.

* Not available on all models

▶▶ Setting Up Apple CarPlay

Only initialize Apple CarPlay when you are safely parked.
When Apple CarPlay first detects your iPhone, you will need to set up your iPhone. Refer to the instruction manual that came with your iPhone.

You can also use the method below to set up Apple CarPlay:

Models with wireless Apple CarPlay and wireless Android Auto

Select HOME → Settings → Smartphone Connection → Apple CarPlay → Select device

Models without wireless Apple CarPlay and wireless Android Auto

Select HOME → Settings → Connections → Smartphone Connection → Apple CarPlay → Select device

Use of user and vehicle information

The use and handling of user and vehicle information transmitted to/from your iPhone by Apple CarPlay is governed by the Apple iOS terms and conditions and Apple's Privacy Policy.

Continued

■ Connecting Apple CarPlay Using the USB Cable to the USB Port

1. Connect the iPhone to the USB port using the USB cable.

📄 **USB Ports** P. 247

▶ The confirmation screen will be displayed.

2. Select **Yes**.

▶ If you do not allow this consent, select **No**.

You may change the consent settings under the **Connections*1/Smartphone Connection*2** settings menu.

■ Connect Apple CarPlay Wirelessly*

■ **Connect Apple CarPlay wirelessly on the home screen**

1. Press the  button.

2. Select **Smartphone Connection**.

3. Select **+ Connect New Device**.

4. Pair the iPhone to the vehicle's *Bluetooth*® HandsFreeLink® (HFL) system.

📄 **Phone Setup** P. 379

5. Select **Yes**.

▶ If your iPhone asks for permission to accept an Apple CarPlay connection, accept to connect.

📄 Connect Apple CarPlay Wirelessly*

Wireless Apple CarPlay and AT&T Hotspot cannot be used at the same time. When using Apple CarPlay and AT&T Hotspot at the same time, connect to Apple CarPlay with a USB cable.

*1 : Models without wireless Apple CarPlay and wireless Android Auto

*2 : Models with wireless Apple CarPlay and wireless Android Auto

* Not available on all models

■ Connect Apple CarPlay wirelessly on the Apple CarPlay device list

1. Press the  button.
2. Select **Settings**.
3. Select **Smartphone Connection**.
4. Select **Apple CarPlay**.
5. Select **+ Connect New Device**.
6. Pair the iPhone to the vehicle's *Bluetooth*® HandsFreeLink® (HFL) system.
▶ **Phone Setup** P. 379
7. Select **Yes**.
 - ▶ If your iPhone asks for permission to accept an Apple CarPlay connection, accept to connect.

■ Connect Apple CarPlay wirelessly on the *Bluetooth*® device list

1. Press the  button.
2. Select **Settings**.
3. Select **Connections**.
4. Select **Bluetooth**.
5. Select **+ Connect New Device**.
6. Pair the iPhone to the vehicle's *Bluetooth*® HandsFreeLink® (HFL) system.
▶ **Phone Setup** P. 379
7. Check the box on **Apple CarPlay**.
 - ▶ If you select **Apple CarPlay**, you cannot select **Audio** and **Phone**.
8. Select **Connect**.
9. Select **Yes**.
 - ▶ If your iPhone asks for permission to accept an Apple CarPlay connection, accept to connect.

■ Connect Apple CarPlay wirelessly with the steering wheel

1. Press and hold the  (talk) button on the steering wheel.
2. Pair the iPhone to the vehicle's *Bluetooth*® HandsFreeLink® (HFL) system.
 - ❑ **Phone Setup** P. 379
3. Check the box on **Apple CarPlay**.
 - ▶ If you select **Apple CarPlay**, you cannot select **Audio** and **Phone**.
4. Select **Connect**.
5. Select **Yes**.
 - ▶ If your iPhone asks for permission to accept an Apple CarPlay connection, accept to connect.

■ Operating Apple CarPlay with Siri

Press and hold the talk button to activate Siri.

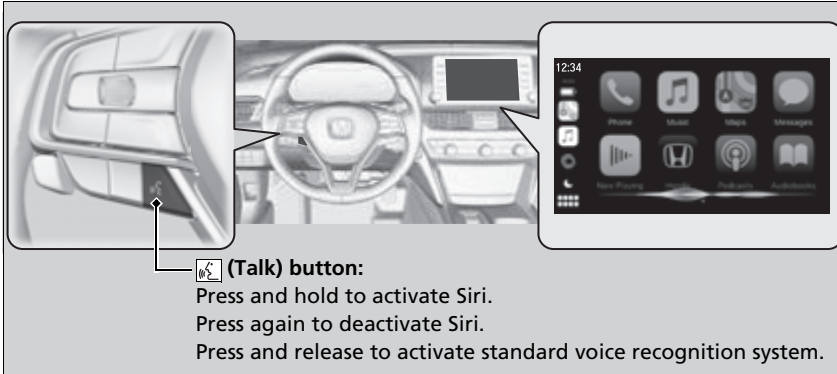

☒ Operating Apple CarPlay with Siri

Below are examples of questions and commands for Siri:

- What movies are playing today?
- Call dad at work.
- What song is this?
- How's the weather tomorrow?
- Read my latest email.
- Find a table for four tonight in Chicago.

For more information, please visit www.apple.com/ios/siri.

Android Auto

When you connect an Android phone to the audio system via the front USB port or wirelessly*, Android Auto is automatically initiated. When connected via Android Auto, you can use the audio/information screen to access the Phone, Google Maps (Navigation), Google Play Music, and Google Now functions. When you first use Android Auto, a tutorial will appear on the screen.

We recommend that you complete this tutorial while safely parked before using Android Auto.

📄 **USB Ports** P. 247

📄 **Auto Pairing Connection** P. 322

📄 Android Auto

To use Android Auto, you need to download the Android Auto app from Google Play to your smartphone.

Only Android 5.0 (Lollipop) or later versions are compatible with Android Auto. *Bluetooth* A2DP cannot be used while your phone is connected to Android Auto.

Park in a safe place before connecting your Android phone to Android Auto and when launching any compatible apps.

To directly access the Android Auto phone function, press **Phone** on the home screen.

📄 **Auto Pairing Connection** P. 322

When your Android phone is connected to Android Auto, it is not possible to use the *Bluetooth*® Audio. However, other previously paired phones can stream audio via *Bluetooth*® while Android Auto is connected.

📄 **Phone Setup** P. 379

Apple CarPlay and Android Auto cannot run at the same time.

Android Auto Menu

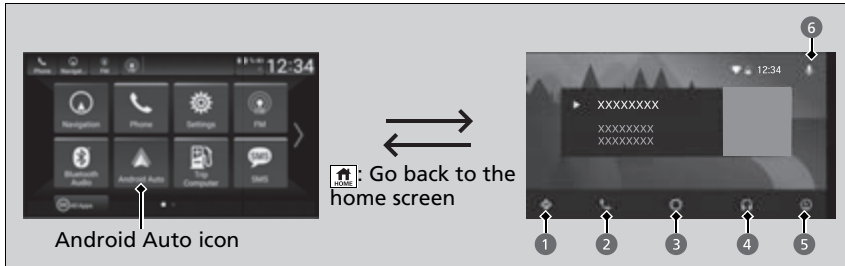

1 Maps (Navigation)

Display Google Maps and use the navigation function just as you would with your Android phone. When the vehicle is in motion, it is not possible to make keyboard entries. Stop the vehicle in a safe location to undertake a search or provide other inputs.

Models with navigation system

Only one navigation system (pre-installed navigation or Android Auto) can give directions at a time. When you are using one system, directions to any prior destination set on the other system will be canceled, and the system you are currently using will direct you to your destination.

The audio/Information screen shows you turn-by-turn driving directions to your destination.

2 Phone (Communication)

Make and receive phone calls as well as listen to voicemail.

3 Google Now (Home screen)

Display useful information organized by Android Auto into simple cards that appear just when they're needed.

Android Auto

For details on countries and regions where Android Auto is available, as well as information pertaining to function, refer to the Android Auto homepage.

Screens may differ depending on the version of the Android Auto app you are using.

Android Auto Operating Requirements & Limitations

Android Auto requires a compatible Android phone with an active cellular connection and data plan. Your carrier's rate plans will apply.

Changes in operating systems, hardware, software, and other technology integral to providing Android Auto functionality, as well as new or revised governmental regulations, may result in a decrease or cessation of Android Auto functionality and services. Honda cannot and does not provide any warranty or guarantee of future Android Auto performance or functionality.

It is possible to use 3rd party apps if they are compatible with Android Auto. Refer to the Android Auto homepage for information on compatible apps.

4 Music and audio

Play Google Play Music and music apps that are compatible with Android Auto.

To switch between music apps, press this icon.

5 Go back to the Home Screen.

6 Voice

Operate Android Auto with your voice.

Auto Pairing Connection

When you connect an Android phone to the unit via the front USB port or wirelessly*, Android Auto is automatically initiated.

■ Connecting Android Auto Using the USB Cable to the USB Port

1. Connect the Android phone to the USB port using the USB cable.

📌 **USB Ports** P. 247

▶ The confirmation screen will be displayed.

2. Select **Yes**.

▶ If you do not allow this consent, select **No**.

You may change the consent settings under the **Connections**^{*1}/**Smartphone Connection**^{*2} settings menu.

*1: Models without wireless Apple CarPlay and wireless Android Auto

*2: Models with wireless Apple CarPlay and wireless Android Auto

☒ Connecting Android Auto Using the USB Cable to the USB Port

Only initialize Android Auto when you are safely parked. When Android Auto first detects your phone, you will need to set up your phone so that auto pairing is possible. Refer to the instruction manual that came with your phone.

You can use the method below to change Android Auto settings after you have completed the initial setup:

Models with wireless Apple CarPlay and wireless Android Auto

Select HOME → Settings → Smartphone Connection → Android Auto → Select device

Models without wireless Apple CarPlay and wireless Android Auto



Select HOME → Settings → Connections → Smartphone Connection → Android Auto → Select device

Use of user and vehicle information



The use and handling of user and vehicle information transmitted to/from your phone by Android Auto is governed by the Google's Privacy Policy.

■ Connect Android Auto Wirelessly*

■ Connect Android Auto wirelessly on the home screen

1. Press the  button.
2. Select **Smartphone Connection**.
3. Select **+ Connect New Device**.
4. Pair the Android phone to the vehicle's *Bluetooth*® HandsFreeLink® (HFL) system.
 **Phone Setup** P. 379
5. Select **Yes**.
 - ▶ If your Android phone asks for permission to accept an Android Auto connection, accept to connect.



■ Connect Android Auto wirelessly on the Android Auto device list

1. Press the  button.
2. Select **Settings**.
3. Select **Smartphone Connection**.
4. Select **Android Auto**.
5. Select **+ Connect New Device**.
6. Pair the Android phone to the vehicle's *Bluetooth*® HandsFreeLink® (HFL) system.
 **Phone Setup** P. 379
7. Select **Yes**.
 - ▶ If your Android phone asks for permission to accept an Android Auto connection, accept to connect.



☒ Connect Android Auto Wirelessly*

Wireless Android Auto and AT&T Hotspot cannot be used at the same time. When using Android Auto and AT&T Hotspot at the same time, connect to Android Auto with a USB cable.

■ Connect Android Auto wirelessly on the *Bluetooth*® device list

1. Press the  button.
2. Select **Settings**.
3. Select **Connections**.
4. Select **Bluetooth**.
5. Select **+ Connect New Device**.
6. Pair the Android phone to the vehicle's *Bluetooth*® HandsFreeLink® (HFL) system.
▶  **Phone Setup** P. 379
7. Check the box on **Android Auto**.
▶ If you select **Android Auto**, you cannot select **Audio** and **Phone**.
8. Select **Connect**.
9. Select **Yes**.
▶ If your Android phone asks for permission to accept an Android Auto connection, accept to connect.

■ Connect Android Auto wirelessly with the steering wheel

1. Press and hold the  (talk) button on the steering wheel.
2. Pair the Android phone to the vehicle's *Bluetooth*® HandsFreeLink® (HFL) system.
▶  **Phone Setup** P. 379
3. Check the box on **Android Auto**.
▶ If you select **Android Auto**, you cannot select **Audio** and **Phone**.
4. Select **Connect**.
5. Select **Yes**.
▶ If your Android phone asks for permission to accept an Android Auto connection, accept to connect.

■ Operating Android Auto with Voice Recognition

Press and hold the talk button to operate Android Auto with your voice.



 **(Talk) button:**
Press and hold to operate Android Auto with your voice.
Press and release to activate standard voice recognition system.

🔊 Operating Android Auto with Voice Recognition

Below are examples of commands you can give with voice recognition:

- Reply to text.
- Call my wife.
- Navigate to Honda.
- Play my music.
- Send a text message to my wife.
- Call flower shop.

For more information, please refer to the Android Auto homepage.

You can also activate the voice recognition function by pressing the  icon in the upper-right corner of the screen.

iPod/USB Flash Drive

If an error occurs while playing an iPod or USB flash drive, you may see the following error messages. If you cannot clear the error message, contact a dealer.

Error Message	Solution
Connect Retry	Appears when the system does not acknowledge the iPod. Reconnect the iPod.
Unplayable File	Appears when the files in the USB flash drive are copyright protected or an unsupported format. This error message appears for about five seconds, then plays the next file.
No Data	iPod Appears when the iPod is empty. USB flash drive Appears when the USB flash drive is empty. iPod and USB flash drive Check that compatible files are stored on the device.
Unsupported	Appears when an unsupported device is connected. If it appears when a supported device is connected, reconnect the device. Appears when unsupported formats are in the device. Check that compatible files are stored on the device.
Device No Response	Appears when the system does not communicate with a connected device. If it appears when a device is connected, contact your place of device purchase.
USB hub not supported	Appears when only a HUB is connected. If it appears, connect a USB flash drive to the HUB.

Android/Apps

If an error occurs while using the audio system or apps, you may see the following error messages. If you cannot clear the error message, contact a dealer.

Error Message	Solution
Unfortunately, **** has stopped.* ¹	Error has occurred within app, select OK on the screen to close the app.
**** is not responding. Would you like to close it?*" ¹	App is not responding. Select Wait if you can wait for a response from app a little longer. If it does not respond even if you keep waiting, select OK to close the app and start it up. If the error message continues, perform Factory Data Reset .  Defaulting All the Settings P. 370

*1:****part is variable characters, and will change depending upon where an error occurs.

SiriusXM® Radio Service *

■ Subscribing to SiriusXM® Radio

1. You need your radio ID ready before registering for subscription. To see the ID in the screen, select **Channel** to 0.
2. Have your radio ID ready, and either call or visit the SiriusXM® website to subscribe.

■ Receiving SiriusXM® Radio

Switch to the SiriusXM® mode by using the audio remote controls on the steering wheel, or through the audio/information screen, and stay in this mode for about 30 minutes until the service is activated. Make sure your vehicle is in an open area with good reception.

■ SiriusXM® Radio Display Messages

Channel ** is not subscribed. Call SiriusXM to subscribe.*¹**

You are not subscribed to the channel selected.

Subscription updated:

SiriusXM® radio is receiving information update from the network.

Channel Not Available:

No such channel exists, or the artist or title information is unavailable.

No Signal:

The signal is too weak in the current location.

Check Tuner:

There is a problem with the SiriusXM® tuner. Contact a dealer.

Check Antenna:

There is a problem with the SiriusXM® antenna. Contact a dealer.

*1: ****part is variable characters, and will change depending upon where an subscribe.

* Not available on all models

☒ Subscribing to SiriusXM® Radio

Contact Information for SiriusXM® Radio:

- US: SiriusXM® Radio at www.siriusxm.com/subscribeNOW, or 1-866-635-2349
- Canada: SiriusXM® Canada at www.siriusxm.ca/subscribe-now, or 1-877-209-0079

☒ Receiving SiriusXM® Radio

The SiriusXM® satellites are in orbit over the equator; therefore, objects south of the vehicle may cause satellite reception interruptions. Satellite signals are more likely to be blocked by tall buildings and mountains the farther north you travel from the equator.

You may experience reception problems under the following circumstances:

- In a location with an obstruction to the south of your vehicle.
- In tunnels.
- On the lower level of a multi-tiered road.
- Large items carried on the roof rack.

Compatible iPod, iPhone, and USB Flash Drives

■ iPod, and iPhone Model Compatibility

Model
Made for iPod nano (7th generation) released in 2012
Made for iPod touch (5th to 7th generation) released between 2012 and 2019
Made for iPhone 5/iPhone 5s/iPhone 5c/iPhone 6/iPhone 6 Plus/iPhone 6S/ iPhone 6S Plus/iPhone SE/iPhone 7/iPhone 7 Plus/iPhone 8/iPhone 8 Plus/iPhone X/ iPhone XS/iPhone XS Max/iPhone XR/iPhone 11/iPhone 11 Pro/iPhone 11 Pro Max

▶▶ iPod, and iPhone Model Compatibility

This system may not work with all software versions of these devices.

The Lightning connector works with iPhone 5, iPhone 5s, iPhone 5c, iPhone 6, iPhone 6 Plus, iPhone 6S, iPhone 6S Plus, iPhone SE, iPhone 7, iPhone 7 Plus, iPhone 8, iPhone 8 Plus, iPhone X, iPhone XS, iPhone XS Max, iPhone XR, iPhone 11, iPhone 11 Pro, iPhone 11 Pro Max, iPod touch (5th to 7th generation), iPod nano (7th generation).

USB works with iPhone 5, iPhone 5s, iPhone 5c, iPhone 6, iPhone 6 Plus, iPhone 6S, iPhone 6S Plus, iPhone SE, iPhone 7, iPhone 7 Plus, iPhone 8, iPhone 8 Plus, iPhone X, iPhone XS, iPhone XS Max, iPhone XR, iPhone 11, iPhone 11 Pro, iPhone 11 Pro Max, iPod touch (5th to 7th generation), iPod nano (7th generation).

▶▶ USB Flash Drives

Files on the USB flash drive are played in their stored order. This order may be different from the order displayed on your PC or device.

■ USB Flash Drives

- A USB flash drive of 256 MB or higher is recommended.
- Some digital audio players may not be compatible.
- Some USB flash drives (e.g., a device with security lockout) may not work.
- Some software files may not allow for audio play or text data display.
- Some versions of MP3, WMA, AAC, FLAC, or WAV formats may be unsupported.

Honda App License Agreement

END USER LICENSE AGREEMENT

PLEASE CAREFULLY READ THIS END USER LICENSE AGREEMENT (THIS "AGREEMENT") WHICH GOVERNS YOUR USE OF THE SOFTWARE INSTALLED ON YOUR HONDA OR ACURA VEHICLE (YOUR "VEHICLE") AS WELL AS THE APPLICATIONS, SERVICES, FUNCTIONS, AND CONTENT PROVIDED THROUGH THE SOFTWARE (COLLECTIVELY, THE "SERVICES"). YOUR USE OF THE SOFTWARE OR SERVICES WILL SERVE AS YOUR CONSENT TO THE TERMS OF THIS AGREEMENT. THE SOFTWARE IS OWNED (OR LICENSED), PROVIDED, AND/OR OPERATED BY AMERICAN HONDA MOTOR CO. INC., ("HONDA," "US," "WE," OR "OUR"), WITH ITS BUSINESS ADDRESS AT 1919 TORRANCE BLVD., TORRANCE, CA 90501. REFERENCE TO "HONDA" IN THIS AGREEMENT INCLUDES HONDA'S PARENT COMPANY AND ITS AFFILIATES AND DESIGNATED AGENTS. THE SERVICES ARE OWNED (OR LICENSED), PROVIDED, AND/OR OPERATED BY HONDA OR A THIRD-PARTY SERVICE PROVIDER (A "PROVIDER"). REFERENCE TO A "PROVIDER" IN THIS AGREEMENT INCLUDES SUCH PROVIDER'S PARENT COMPANY, AFFILIATES, AND DESIGNATED AGENTS.

A. Description of the Software. The SOFTWARE includes the software, firmware and the like, installed and executing on your VEHICLE during manufacture, and thereafter updated from time to time by HONDA, you or an authorized HONDA dealer (a "DEALER"). The SOFTWARE allows you to access and use a variety of SERVICES, including but not limited to: (a) HONDA applications, services, and content provided through the SOFTWARE (together, "HONDA SERVICES"); and (b) PROVIDER applications, services, and content provided through the SOFTWARE (together, "PROVIDER SERVICES"), each of which may provide access to various information, media, content, and services.

B. SOFTWARE Licensing and Intellectual Property.

1. SOFTWARE. This AGREEMENT grants you a non-exclusive, limited, and revocable license to use the SOFTWARE and SERVICES solely (a) as installed on your VEHICLE by HONDA, (b) as updated on your Vehicle by HONDA, you (but only as and when directed by HONDA), or a DEALER and (c) as permitted under the terms of this AGREEMENT.

2. HONDA Services. The SOFTWARE may provide you with access to various HONDA SERVICES. Installation, activation, or use of HONDA SERVICES may require your consent to additional terms, conditions, and privacy policies applicable to those HONDA SERVICES (the "HONDA TERMS"). You acknowledge and agree that any collection, use, sharing of data generated by your VEHICLE or your use of your VEHICLE, and your use of the HONDA SERVICES shall be subject to this AGREEMENT and any additional HONDA TERMS that may be specifically applicable to such HONDA SERVICES or data generation. The HONDA SERVICES may collect, use, and share such data while you are using the SOFTWARE.

3. Open-Source Software. The SOFTWARE and SERVICES may incorporate software licensed to HONDA under free or open-source licenses which govern HONDA's distribution and your use of such software. HONDA and the third-party authors, licensors, and distributors of such software disclaim all warranties and all liability arising from any and all use or distribution of the software. To the extent such software is provided under terms that differ from the applicable free or open-source licenses, those terms are offered by HONDA alone. Additional information regarding free and open-source software incorporated in the SOFTWARE and SERVICES is available in this manual or within the SOFTWARE.

4. Provider Services. The SOFTWARE may provide you with access to various PROVIDER SERVICES. Installation or use of such PROVIDER SERVICES may require your consent to additional terms, conditions, and privacy policies of the applicable PROVIDER (the "PROVIDER TERMS"). This AGREEMENT restricts the manner in which you can install and use PROVIDER SERVICES but does not grant you a license or permission to use such PROVIDER SERVICES. Your permission to use PROVIDER SERVICES is limited and subject to any license grants, conditions, and limitations included in the PROVIDER TERMS. You acknowledge that any collection, use, sharing of your information, targeted advertising practices by PROVIDERS, and your use of the PROVIDER SERVICES shall be subject to both this AGREEMENT and any applicable PROVIDER TERMS. The PROVIDER SERVICES may collect, use, and share such information while you are using the SOFTWARE.

5. License Limitations and Restrictions on Use.

(a) Limited License. You understand and agree that the SOFTWARE and SERVICES are licensed, not sold, to you solely for use in accordance with this AGREEMENT and any applicable PROVIDER TERMS, and any documentation for the VEHICLE made available to you by HONDA (any "DOCUMENTATION"). HONDA and its licensors reserve all rights in the SOFTWARE and HONDA SERVICES not expressly granted to you under this AGREEMENT. PROVIDERS and their licensors reserve all rights in the PROVIDER SERVICES not expressly granted to you under the applicable PROVIDER TERMS.

(b) Restrictions on Use. The licenses granted under this AGREEMENT do not permit you to use the SOFTWARE or SERVICES on a device other than your VEHICLE. As a condition of using the SOFTWARE and SERVICES, you agree that you may not and will not:

- (1) copy, download, distribute, modify, publish, sell, rent, lease, lend, license, sublicense, reuse, or create derivative works of the SOFTWARE or SERVICES or any of the content or other material within the SOFTWARE or SERVICES, including without limitation, HONDA or PROVIDER names, logos, or any other trademarks of HONDA or PROVIDERS or used in association with the SOFTWARE or any SERVICES, except as required to use the SOFTWARE or SERVICES in accordance with this AGREEMENT, any applicable PROVIDER TERMS, and the DOCUMENTATION;
- (2) access or use the SOFTWARE or SERVICES in any manner intended to damage or impair the operation of the SOFTWARE or SERVICES or interfere with anyone else's use and enjoyment of the SOFTWARE or SERVICES;
- (3) access or attempt to access any system or server on which the SOFTWARE or SERVICES is hosted or modify or alter the SOFTWARE or SERVICES in any way;
- (4) use the SOFTWARE or SERVICES for any unlawful purpose, or in violation of any third party rights;
- (5) use the SOFTWARE or SERVICES in violation of any applicable traffic regulations, rules or laws, including but not limited to any driver distraction laws, rules or regulations;
- (6) violate the terms of this AGREEMENT, any HONDA TERMS, any PROVIDER TERMS or other applicable third-party terms, conditions, and privacy policies; or
- (7) reverse engineer, decompile, disassemble, attempt to derive the source code of, nor permit others to reverse engineer, decompile, or disassemble, or attempt to derive the source code of the SOFTWARE or SERVICES, except and only to the extent that such activity is expressly permitted (a) by applicable law notwithstanding this limitation or (b) the terms of applicable free or opensource software licenses.

6. Intellectual Property Rights. All title and intellectual property rights in and to the SOFTWARE and SERVICES, the accompanying DOCUMENTATION, and all copies of the SOFTWARE or SERVICES are owned by HONDA, PROVIDERS, or their suppliers or licensors. This AGREEMENT does not grant you any rights in connection with any trademarks or service marks of HONDA, PROVIDERS, or their licensors, affiliates, or suppliers.

7. Export Restrictions: You acknowledge that the SOFTWARE and SERVICES are subject to U.S., European Union, and other export jurisdictions. You agree to comply with all applicable international and national laws that apply to the SOFTWARE and SERVICES, including the U.S. Export Administration Regulations, as well as end-user, end-use, and destination restrictions issued by the U.S. and other governments.

C. SOFTWARE Operation

1. HONDA reserves the right to suspend or terminate your access to and use of the SOFTWARE or SERVICES if you are found to be in violation of this AGREEMENT or as reasonably deemed necessary by HONDA.

2. Eligibility/Registration/Activation. The SOFTWARE is intended for and available to individuals who (a) are of legal age of majority in their jurisdiction of residence (and at least 18 years of age), or are younger than 18 years of age and possess a valid driver's license issued by their jurisdiction of residence, and (b) own or have permissive access to a compatible VEHICLE. We do not knowingly collect any information, including personal information, from children under 13. If we learn or are notified that we have collected personal information of a child under 13, we will immediately take steps to delete such information.

3. Use of PROVIDER SERVICES through the SOFTWARE. Certain PROVIDER SERVICES made available through the SOFTWARE may require that you register or otherwise have an account with the PROVIDER and agree to PROVIDER TERMS. Any use of any of such PROVIDER SERVICES within the SOFTWARE is subject to this AGREEMENT and the applicable PROVIDER TERMS. HONDA does not exercise control over such PROVIDER SERVICES and is not responsible or liable for the availability, security, or content of such PROVIDER SERVICES, and the inclusion of any PROVIDER SERVICES does not imply a referral from, the approval of, or the endorsement by HONDA of such PROVIDER SERVICES. HONDA is not responsible or liable, directly or indirectly, for any damage relating to or resulting from your use of the PROVIDER SERVICES.

4. Links to Third Party Sites: The SOFTWARE may provide you with the ability to access third-party sites and content through the use of the SOFTWARE or SERVICES. The third-party sites and content are not under the control of HONDA. HONDA is not responsible or liable, directly or indirectly, for such third-party websites and their content or for any damage relating to or resulting from your access or use of such websites and content.

5. Unauthorized Use and Abuse. You are responsible for ensuring your (and any authorized third parties') use of the SOFTWARE and SERVICES remains in compliance with this AGREEMENT and all other applicable HONDA TERMS and PROVIDER TERMS. You acknowledge and agree that any use of the SOFTWARE or SERVICES occurring through your VEHICLE will be deemed your actions and that HONDA and PROVIDERS may rely upon such actions. You agree to immediately notify us if you suspect fraudulent or abusive activity involving the SOFTWARE or SERVICES. If you so notify us or if we otherwise suspect fraudulent or abusive activity, you agree to cooperate with us in any fraud investigation and to use any fraud prevention measures we prescribe. Your failure to immediately notify us or cooperate to use such measures will result in your liability for all fraudulent usage or abusive activity associated with your VEHICLE.

6. SOFTWARE Updates. The SOFTWARE and SERVICES may be updated when your VEHICLE is serviced by a DEALER or remotely, over-the-air, by HONDA from time to time; such updates may occur with or without further notice or your future consent. The SOFTWARE may be updated at HONDA's discretion and for any purpose including, without limitation, to patch or otherwise improve the SOFTWARE or SERVICES functionality, security, or stability. All updates to the SOFTWARE and SERVICES are subject to this AGREEMENT and any other applicable HONDA TERMS and PROVIDER TERMS.

7. Uninstalling, Removing, and Replacing the SOFTWARE. Replacing SOFTWARE or HONDA SERVICES with software or firmware not provided and installed by HONDA or a DEALER will render all representations and warranties for the SOFTWARE, HONDA SERVICES, and VEHICLE functionality reliant upon the SOFTWARE or HONDA SERVICES null and void.

D. SOFTWARE Operational Notices and Warnings

1. Vehicle Geolocation Information. You acknowledge that your VEHICLE may be equipped with certain traffic and map features. The traffic feature will automatically collect and transmit, through GPS technology, your Vehicle's current location (longitude and latitude), travel direction and speed ("VEHICLE GEOLOCATION INFORMATION") to HONDA and PROVIDERS. The VEHICLE GEOLOCATION INFORMATION is used by HONDA and PROVIDERS to provide traffic and navigation-related information to you, but may also be used to provide other SERVICES or offers to you. HONDA will not use such VEHICLE GEOLOCATION INFORMATION for its own marketing efforts, or provide such information to unaffiliated third parties for their own purposes, without your express consent.

2. Potential Map Inaccuracy and Route Safety. Maps used by this system may be inaccurate because of changes in roads, traffic controls, routing, or driving conditions. Always use good judgment and common sense when following suggested routes. Do not follow the route suggestions if doing so would result in an unsafe or illegal driving maneuver, if you would be placed in an unsafe situation, or if you would be directed into an area that you consider unsafe. Do not rely on any navigation features included in the system to route you to emergency services. Not all emergency services such as police, fire stations, hospitals, or clinics are likely to be contained in the map database for such navigation features. Ask local authorities or an emergency services operator for such locations and routes. The driver is ultimately responsible for the safe operation of the vehicle and therefore, must evaluate whether it is safe to follow the suggested directions. Any navigation features are provided only as an aid. Make your driving decisions based on your observations of local conditions and existing traffic regulations. Navigation features are not a substitute for your personal judgment. Any route suggestions made by the SOFTWARE or SERVICES should never replace any local traffic regulations or your personal judgment or knowledge of safe driving practices.

3. Speech Recognition: You acknowledge and understand that HONDA and PROVIDERS may record, retain, and use voices commands when you use the speech recognition components of the SOFTWARE or SERVICES. You and all VEHICLE operators and passengers (a) consent to the recording and retention of voice commands in support of providing speech recognition components and (b) release HONDA and PROVIDERS from all claims, liabilities, and losses that may result from any use of such recorded voice commands. Recognition errors are inherent in speech recognition. It is your responsibility to monitor any speech recognition functions included in the system and address any errors. Neither HONDA nor PROVIDERS will be liable for any damages arising out of errors in the speech recognition process.

4. Distraction Hazards. Navigation features may require manual (non-verbal) input or setup. Attempting to perform such set-up or insert data while driving can seriously distract your attention and could cause a crash or other serious consequences; the ability to undertake such interactions may also be limited by state or local law, which laws you are responsible to know and follow. Even occasional short scans of the screen may be hazardous if your attention has been diverted away from your driving at a critical time. Pull over and stop the vehicle in a safe and legal manner before attempting to access a function of the system requiring prolonged attention. Do not raise the volume excessively. Keep the volume at a level where you can still hear outside traffic and emergency signals while driving. Driving while unable to hear these sounds could result in a crash.

E. Information Collection and Storage

1. Information Collection, Use, Transmission and Storage of Data. Consent to Use of Data: You agree that HONDA and PROVIDERS may collect and use your information gathered in any manner as part of product support services related to the SOFTWARE or related services. HONDA may share such information with third parties, including, without limitation, PROVIDERS, third party software and services suppliers, their affiliates and/or their designated agents, solely to improve their products or to provide services or technologies to you. HONDA, third party software and systems suppliers, their affiliates and/or their designated agent may disclose this information to others, but not in a form that personally identifies you.

2. Information Storage. Depending on the type of multimedia system you have in your VEHICLE, certain information may be stored for ease of use of the SOFTWARE including, without limitation, search history, location history in certain applications, previous and saved destinations, map locations within certain applications, and device numbers and contact information.

(a) Vehicle Health Information. Your VEHICLE may remotely transmit information regarding the status and health of your VEHICLE (“VEHICLE INFORMATION”) to HONDA without notification to you. VEHICLE INFORMATION may contain VEHICLE maintenance and malfunction status that is derived from VEHICLE diagnostic data and includes, but is not limited to, status of powered doors and windows, battery life data, battery charging data, VEHICLE speed, coolant temperature, air compressor revolution, output power, warning codes, diagnostic trouble codes, fuel injection volume, and engine rotations per minute. VEHICLE HEALTH INFORMATION may be used by HONDA for research and development, to deliver HONDA SERVICES and information to you, and to contact you, and is retained only for a period of time necessary to fulfill these goals.

(b) VEHICLE Geolocation Data (non-navigation/map based). If you opt-in to geolocation-based SERVICES, your vehicle’s geolocation data (latitude and longitude) will be automatically sent from your VEHICLE to HONDA and PROVIDERS.

(c) You understand that the inputting or uploading of information to your VEHICLE’s multimedia system or the SOFTWARE or SERVICES is at your own risk and that HONDA is not responsible for unauthorized access to or use of any personal or other information. All information uploaded to the SOFTWARE and SERVICES may be stored on your VEHICLES’s multimedia system and you understand that the security and safety of your VEHICLE’s multimedia system is your sole responsibility.

F. NO WARRANTY. You understand and agree that your use of the SOFTWARE and SERVICES are solely at your own risk and that you will be solely responsible for any damage to your VEHICLE's multimedia system or any other equipment or any loss of data that may result from your use of the SOFTWARE or SERVICES. THE SOFTWARE AND SERVICES ARE PROVIDED ON AN "AS IS" AND "AS AVAILABLE" BASIS WITHOUT ANY WARRANTY OF ANY KIND, EXPRESSED, IMPLIED OR STATUTORY. WE SPECIFICALLY DISCLAIM ANY IMPLIED WARRANTIES OF MERCHANTABILITY, FITNESS FOR A PARTICULAR PURPOSE, AND NON-INFRINGEMENT. HONDA makes no warranties that the SOFTWARE or SERVICES will meet your requirements, or that the SOFTWARE or SERVICES will be uninterrupted, timely, secure, non-infringing or error free. You understand and agree that you are responsible for any and all charges, costs or expenses associated with your use of the SOFTWARE or SERVICES. Advice or information, whether oral or written, obtained by you from us or through the SOFTWARE or SERVICES are provided for informational purposes only and will not create any warranty not expressly made herein. You should not rely on any such information or advice. We assume no liability or responsibility for any errors or omissions in the SOFTWARE or SERVICES. We do not make any warranty or representation that your use of the material displayed on, or obtained through, the SOFTWARE or SERVICES is non-infringing of any rights of any third party. Any decision or action taken by you on the basis of information or content provided via the application is at your sole discretion and risk. HONDA and PROVIDERS are not responsible or liable for any such decision, or for the accuracy, completeness, usefulness, or availability of any content or information displayed, transmitted, or otherwise made available via the SOFTWARE or SERVICES. To the extent jurisdictions do not allow the exclusion of certain warranties, some of the above exclusions may not apply to you.

G. LIMITATIONS ON LIABILITY. You and HONDA are each waiving important rights.

1. Limitations on YOUR liability. HONDA cannot recover from you any consequential, indirect, incidental, or special damages, or attorney's fees in connection with your use of the SOFTWARE or HONDA SERVICES. HONDA WAIVES TO THE FULLEST EXTENT ALLOWED BY LAW ANY CLAIM FOR DAMAGES OTHER THAN DIRECT, COMPENSATORY DAMAGES AS LIMITED IN THIS AGREEMENT.

2. Limitation on HONDA and PROVIDER liability. Neither HONDA nor PROVIDERS will be liable to you or any other party for consequential, indirect, incidental, special, or punitive damages (including without limitation lost profits) in connection with your use of the SOFTWARE or SERVICES, even if HONDA or PROVIDERS are aware of the possibility of such damages. These limitations apply to all claims, including, without limitation, claims in contract and tort (such as negligence, product liability and strict liability). To the extent that a jurisdiction does not permit the exclusion or limitation of liability as set forth herein our liability is limited to the maximum extent permitted by law in such states. If HONDA or PROVIDERS are found liable to you for any reason, you agree that the aggregate liability of all these parties to you for any claim is limited to ten U.S. dollars (US \$10.00). Neither HONDA nor any PROVIDER would have agreed to provide the SOFTWARE or SERVICES to you if you did not agree to this limitation. This amount is the sole and exclusive liability of HONDA and PROVIDERS to you, and is payable as liquidated damages and not as a penalty. Except where prohibited by law, you may not bring any claim against HONDA or any third-party beneficiary more than two (2) years after the claim arises. We do not have any liability for SOFTWARE or SERVICES interruptions of any length.

(a) **Release of HONDA and PROVIDERS** For yourself and anyone else claiming under you, you agree to release and discharge HONDA, PROVIDERS, their respective officers, directors, and employees, and each third-party beneficiary from all claims, liabilities and losses in connection with the SOFTWARE or SERVICES, including, but not limited to claims for personal injury or property damage arising from the total or partial failure of performance of the SOFTWARE or SERVICES, even if caused by or based upon the negligence, gross negligence, strict products liability, Deceptive Trade Practices Act violations, bad faith, or breach of warranty of us or the malfunction of the SOFTWARE or SOFTWARE SERVICES. YOU AGREE TO WAIVE TO THE FULLEST EXTENT ALLOWED BY LAW, ANY CLAIM FOR DAMAGES OTHER THAN DIRECT, COMPENSATORY DAMAGES AS LIMITED IN THIS AGREEMENT. YOU HEREBY RELEASE AND DISCHARGE HONDA AND ITS LICENSORS AND CONTRACTORS (INCLUDING ANY THIRD PARTIES PROVIDING ALL OR PART OF THE SOFTWARE OR SERVICES) FROM AND AGAINST ANY CLAIMS, DAMAGES, EXPENSES AND LIABILITY ARISING FROM OR RELATED TO ANY INJURIES, DAMAGES, OR LOSSES TO ANY PERSON (INCLUDING DEATH) OR PROPERTY OF ANY KIND RESULTING IN WHOLE OR PART, DIRECTLY OR INDIRECTLY, FROM YOUR USE OF THE SOFTWARE OR SERVICES.

H. Survival. You agree that the limitations of liability and indemnities in this AGREEMENT will survive even after the AGREEMENT has ended. These limitations of liability apply not only to you, but to anyone using the SOFTWARE or SERVICES via your VEHICLE, to anyone making a claim on your behalf, and to any claims made by your family, employees, customers, or others arising out of or relating to your VEHICLE, the SOFTWARE, or SERVICES.

I. Availability/Interruption. The SOFTWARE and certain SERVICES are made available through your VEHICLE's compatible multimedia system when the VEHICLE is turned on. Certain SERVICES may be available only through your compatible mobile device when it is within the operating range of the VEHICLE and a wireless carrier. The availability of the SOFTWARE and SERVICES may be subject to transmission limitation or interruption, including but not limited to technical obsolescence or sunset of the hardware, software or firmware, inside of or external to the Vehicle, required for data transmission or receipt. HONDA does not guarantee that the SOFTWARE, SERVICES, or any portion thereof will be available at all times or in all areas. You acknowledge and agree that HONDA is not responsible for performance degradation, interruption or delays. You acknowledge that HONDA shall not be liable to you if the SOFTWARE or SERVICES in a given location are not available. If the SOFTWARE or SERVICES are not available within your intended location, you agree that your sole remedy shall be to cease using the SOFTWARE and SERVICES.

J. PRODUCT SUPPORT: Product support for the SOFTWARE is provided by HONDA. For product support, please refer to HONDA instructions provided in the DOCUMENTATION. Should you have any questions concerning this AGREEMENT, or if you desire to contact HONDA for any other reason, please refer to the HONDA contact information provided in the DOCUMENTATION.

K. Termination and Transfer.

1. Termination. This AGREEMENT is effective until terminated by you or US. WE may terminate this AGREEMENT for any or no reason, and with or without notice to you. Your rights under this AGREEMENT will terminate automatically without notice from US if you fail to comply with any term of this AGREEMENT. Upon termination of this AGREEMENT, you shall cease all use of the SOFTWARE and SERVICES.

2. Transfer: You may permanently transfer your rights under this AGREEMENT only as part of a sale or transfer of the VEHICLE, provided you retain no copies, you transfer all of the SOFTWARE and HONDA SERVICES (including all component parts, the media and printed materials, and any upgrades), and the recipient agrees to the terms of this AGREEMENT. You agree to notify HONDA upon the sale or transfer of the VEHICLE. To contact HONDA, please refer to the HONDA contact information provided in the DOCUMENTATION.

L. Changes to the SOFTWARE or SERVICES. WE may change, modify, or update the SOFTWARE or SERVICES from time to time. Unless explicitly stated otherwise, any new features or services that augment or enhance the SOFTWARE or SERVICES in the future shall respectively be considered part of the SOFTWARE or SERVICES and subject to this AGREEMENT. WE reserve the right at any time and from time to time to interrupt, restrict, modify, suspend, discontinue, temporarily or permanently, the SOFTWARE or SERVICES (or any portion thereof), with or without notice to you, and you agree that HONDA shall not be liable to you or to any third party for any modification, suspension or discontinuance of the SOFTWARE or SERVICES.

M. ARBITRATION:

PLEASE READ THIS ARBITRATION PROVISION CAREFULLY TO UNDERSTAND YOUR RIGHTS. YOU AGREE THAT ANY CLAIM THAT YOU MAY HAVE IN THE FUTURE MUST BE RESOLVED THROUGH BINDING ARBITRATION. YOU WAIVE THE RIGHT TO HAVE YOUR DISPUTE HEARD IN COURT AND WAIVE THE RIGHT TO BRING CLASS CLAIMS. YOU UNDERSTAND THAT DISCOVERY AND APPEAL RIGHTS ARE MORE LIMITED IN ARBITRATION.

Arbitration is a method of resolving a claim, dispute or controversy without filing a lawsuit. By agreeing to arbitrate, the right to go to court is waived and instead claims, disputes or controversies are submitted to binding arbitration. This provision sets forth the terms and conditions of our agreement. YOU and HONDA agree and acknowledge that this Agreement affects interstate commerce and the Federal Arbitration Act ("FAA") applies. By using the Software, Vehicle, or Services, YOU elect to have disputes resolved by arbitration. YOU, HONDA or any involved third party may pursue a Claim. "Claim" means any dispute between YOU, HONDA, or any involved third party relating to your use of the Software, the Vehicle, or the Services, this Agreement, or our relationship, including any representations, omissions or warranties. "Claim" does not include personal injury or wrongful death claims. YOU or HONDA may seek remedies in small claims court or provisional judicial remedies without arbitrating. In addition, notwithstanding anything herein to the contrary, YOU or HONDA may seek equitable relief in a court of competent jurisdiction.

YOU or HONDA may select arbitration with American Arbitration Association, JAMS or National Arbitration and Mediation. Contact these sponsors for their rules. The hearing will be in the federal district where YOU reside. If agreed, it may be by telephone or written submissions. Filing and arbitrator fees to be paid per the sponsor rules. You may contact the sponsor for a fee waiver. If no fee waivers, HONDA will pay filing and arbitrator fees up to \$5,000, unless law requires more. Each party is responsible for other fees. Arbitrator may award costs or fees to prevailing party, if permitted by law. HONDA will not seek fees, unless the claims are frivolous.

Arbitrator shall be an attorney or current or retired judge familiar with automotive or consumer software. The arbitrator shall follow substantive law, statute of limitations and decide all issues relating to the interpretation, construction, enforceability and applicability of this provision. The arbitrator may order relief permitted by law. This provision is governed and enforceable by the FAA. An award shall include a written opinion and be final, subject to appeal by the FAA.

This provision survives termination of this Agreement or relationship, bankruptcy, assignment or transfer. If part of this provision is unenforceable, the remainder remains in effect. If unenforceability allows arbitration as a class action, then this provision is entirely unenforceable. YOU may opt out within 30 days of your initial use of the Software by sending a signed, written notice to HONDA at Honda Financial Services, P.O. Box 165007, Irving, TX 75016. HONDA reserves the right to make changes to this provision after providing written notice and an opportunity to opt out.

N. Miscellaneous: You may not assign this AGREEMENT without HONDA's prior written consent. This AGREEMENT and any additional HONDA TERMS and PROVIDER TERMS represents the entire agreement between you and US. HONDA may amend the terms of this AGREEMENT by providing you with notices of such updated terms. If you do not consent to be bound by the updated terms, your sole remedy will be to cease using the SOFTWARE and SERVICES. If any part of this AGREEMENT is found invalid, void, or unenforceable, the balance of the AGREEMENT will remain valid and enforceable according to its terms. To the fullest extent permitted by law, and except as explicitly provided otherwise, this AGREEMENT and any disputes arising out of or relating to it will be governed by the laws of the State of California, except that California laws concerning choice of law or conflicts shall not apply if they would cause the substantive law of another jurisdiction to apply. Notwithstanding the foregoing, Section M shall be governed by the Federal Arbitration Act and the laws of the State of California, as applicable, as set forth therein. The failure to enforce any term of this AGREEMENT on one occasion shall not prevent enforcement on any other occasion or the enforcement of any other term. Headings and captions shall not be considered included for purposes of interpretation or application hereof, but are for convenience only.

Legal Information on Apple CarPlay/Android Auto

■ OWNER'S MANUAL LICENSE/LIABILITY STATEMENTS

USE OF APPLE CARPLAY IS SUBJECT TO YOUR AGREEMENT TO THE CARPLAY TERMS OF USE, WHICH ARE INCLUDED AS PART OF THE APPLE iOS TERMS OF USE. IN SUMMARY, THE CARPLAY TERMS OF USE DISCLAIM APPLE AND ITS SERVICE PROVIDERS' LIABILITY IF THE SERVICES FAIL TO PERFORM CORRECTLY OR ARE DISCONTINUED, STRICTLY LIMIT APPLE AND ITS SERVICE PROVIDERS' OTHER LIABILITIES, DESCRIBE THE KINDS OF USER INFORMATION (INCLUDING, FOR EXAMPLE, VEHICLE LOCATION, VEHICLE SPEED, AND VEHICLE STATUS) BEING GATHERED AND STORED BY APPLE AND ITS SERVICE PROVIDERS, AND DISCLOSE CERTAIN POSSIBLE RISKS ASSOCIATED WITH THE USE OF CARPLAY, INCLUDING THE POTENTIAL FOR DRIVER DISTRACTION. SEE APPLE'S PRIVACY POLICY FOR DETAILS REGARDING APPLE'S USE AND HANDLING OF DATA UPLOADED BY CARPLAY.

USE OF ANDROID AUTO IS SUBJECT TO YOUR AGREEMENT TO THE ANDROID AUTO TERMS OF USE WHICH MUST BE AGREED TO WHEN THE ANDROID AUTO APPLICATION IS DOWNLOADED TO YOUR ANDROID PHONE. IN SUMMARY, THE ANDROID AUTO TERMS OF USE DISCLAIM GOOGLE AND ITS SERVICE PROVIDERS' LIABILITY IF THE SERVICES FAIL TO PERFORM CORRECTLY OR ARE DISCONTINUED, STRICTLY LIMIT GOOGLE AND ITS SERVICE PROVIDERS' OTHER LIABILITIES, DESCRIBE THE KINDS OF USER INFORMATION (INCLUDING, FOR EXAMPLE, VEHICLE LOCATION, VEHICLE SPEED, AND VEHICLE STATUS) BEING GATHERED AND STORED BY GOOGLE AND ITS SERVICE PROVIDERS, AND DISCLOSE CERTAIN POSSIBLE RISKS ASSOCIATED WITH THE USE OF ANDROID AUTO, INCLUDING THE POTENTIAL FOR DRIVER DISTRACTION. SEE GOOGLE'S PRIVACY POLICY FOR DETAILS REGARDING GOOGLE'S USE AND HANDLING OF DATA UPLOADED BY ANDROID AUTO.

■ **DISCLAIMER OF WARRANTIES; LIMITATION ON LIABILITY**

YOU EXPRESSLY ACKNOWLEDGE AND AGREE THAT USE OF APPLE CARPLAY OR ANDROID AUTO (“THE APPLICATIONS”) IS AT YOUR SOLE RISK AND THAT THE ENTIRE RISK AS TO SATISFACTORY QUALITY, PERFORMANCE, ACCURACY AND EFFORT IS WITH YOU TO THE MAXIMUM EXTENT PERMITTED BY APPLICABLE LAW, AND THAT THE APPLICATIONS AND INFORMATION ON THE APPLICATIONS IS PROVIDED “AS IS” AND “AS AVAILABLE,” WITH ALL FAULTS AND WITHOUT WARRANTY OF ANY KIND, AND HONDA HEREBY DISCLAIMS ALL WARRANTIES AND CONDITIONS WITH RESPECT TO THE APPLICATIONS AND INFORMATION ON THE APPLICATIONS, EITHER EXPRESS, IMPLIED OR STATUTORY, INCLUDING, BUT NOT LIMITED TO, THE IMPLIED WARRANTIES AND/OR CONDITIONS OF MERCHANTABILITY, SATISFACTORY QUALITY, FITNESS FOR A PARTICULAR PURPOSE, ACCURACY, QUIET ENJOYMENT, AND NON-INFRINGEMENT OF THIRD PARTY RIGHTS. NO ORAL OR WRITTEN INFORMATION OR ADVICE GIVEN BY HONDA OR AN AUTHORIZED REPRESENTATIVE SHALL CREATE A WARRANTY. AS EXAMPLES, AND WITHOUT LIMITATION, HONDA DISCLAIMS ANY WARRANTY REGARDING THE ACCURACY OF DATA PROVIDED BY THE APPLICATIONS, SUCH AS THE ACCURACY OF DIRECTIONS, ESTIMATED TRAVEL TIME, SPEED LIMITS, ROAD CONDITIONS, NEWS, WEATHER, TRAFFIC, OR OTHER CONTENT PROVIDED BY APPLE, GOOGLE, THEIR AFFILIATES, OR THIRD PARTY PROVIDERS; HONDA DOES NOT GUARANTEE AGAINST LOSS OF APPLICATION DATA, WHICH MAY BE LOST AT ANY TIME; HONDA DOES NOT GUARANTEE THAT THE APPLICATIONS OR ANY SERVICES PROVIDED THROUGH THEM WILL BE PROVIDED AT ALL TIMES OR THAT ANY OR ALL SERVICES WILL BE AVAILABLE AT ANY PARTICULAR TIME OR LOCATION. FOR EXAMPLE, SERVICES MAY BE SUSPENDED OR INTERRUPTED WITHOUT NOTICE FOR REPAIR, MAINTENANCE, SECURITY FIXES, UPDATES, ETC., SERVICES MAY BE UNAVAILABLE IN YOUR AREA OR LOCATION, ETC. IN ADDITION, YOU UNDERSTAND THAT CHANGES IN THIRD PARTY TECHNOLOGY OR GOVERNMENT REGULATION MAY RENDER THE SERVICES AND/OR APPLICATIONS OBSOLETE AND/OR UNUSABLE.

TO THE EXTENT NOT PROHIBITED BY LAW, IN NO EVENT SHALL HONDA OR ITS AFFILIATES BE LIABLE FOR PERSONAL INJURY, OR ANY INCIDENTAL, SPECIAL, INDIRECT OR CONSEQUENTIAL DAMAGES WHATSOEVER, INCLUDING, WITHOUT LIMITATION, DAMAGES FOR LOSS OF PROFITS, CORRUPTION OR LOSS OF DATA, FAILURE TO TRANSMIT OR RECEIVE ANY DATA, BUSINESS INTERRUPTION OR ANY OTHER COMMERCIAL DAMAGES OR LOSSES, ARISING OUT OF OR RELATED TO THE APPLICATIONS OR YOUR USE OF OR INABILITY TO USE THE APPLICATIONS OR INFORMATION ON THE APPLICATIONS, HOWEVER CAUSED, REGARDLESS OF THE THEORY OF LIABILITY (CONTRACT, TORT OR OTHERWISE) AND EVEN IF HONDA WERE ADVISED OF THE POSSIBILITY OF SUCH DAMAGES. SOME STATES AND JURISDICTIONS DISALLOW THE EXCLUSION OR LIMITATION OF LIABILITY FOR DAMAGES, SO THESE LIMITATIONS AND EXCLUSIONS MAY NOT APPLY TO YOU. IN NO EVENT SHALL HONDA’S TOTAL LIABILITY TO YOU FOR ALL DAMAGES (OTHER THAN AS MAY BE REQUIRED BY APPLICABLE LAW IN CASES INVOLVING PERSONAL INJURY) EXCEED THE AMOUNT OF FIVE DOLLARS (\$5.00). THE FOREGOING LIMITATIONS WILL APPLY EVEN IF THE ABOVE STATED REMEDY FAILS OF ITS ESSENTIAL PURPOSE.

About Open Source Licenses

To see the open source license information, follow these steps.

1. Press the  button.
2. Select **Settings**.
3. Select **System**.
4. Select **About**.
5. Select **Legal Information**.
6. Select **License**.

▶▶ About Open Source Licenses

Models with Telematics Control Unit

Free/Open Source Software Information

This product contains Free/Open Source Software(FOSS).

The license information and/or the source code of such FOSS can be found at the following URL:

<https://www.denso.com/global/en/opensource/tcu/honda/>

License Information *

■ DOLBY DIGITAL

Manufactured under license from Dolby Laboratories. Dolby, Dolby Audio, Pro Logic, and the double-D symbol are trademarks of Dolby Laboratories.



■ DTS

For DTS patents, see <http://patents.dts.com>. Manufactured under license from DTS Licensing Limited. DTS, DTS-HD, the Symbol, & DTS and the Symbol together are registered trademarks of DTS, Inc. ©DTS, Inc. All Rights Reserved.



■ Bluetooth

The *Bluetooth*® word mark and logos are registered trademarks owned by Bluetooth SIG, Inc. and any use of such marks by PANASONIC CORPORATION is under license. Other trademarks and trade names are those of their respective owners.



■ Windows Media

This product is protected by certain intellectual property rights of Microsoft. Use or distribution of such technology outside of this product is prohibited without a license from Microsoft.

■ Apple

“Made for iPod,” and “Made for iPhone,” mean that an electronic accessory has been designed to connect specifically to iPod, or iPhone, respectively, and has been certified by the developer to meet Apple performance standards. Apple is not responsible for the operation of this device or its compliance with safety and regulatory standards. Please note that the use of this accessory with iPod, or iPhone, may affect wireless performance.

Apple, the Apple Logo, iPhone, iPod nano, iPod touch are trademarks of Apple Inc., registered in the U.S. and other countries. Apple CarPlay, and Lightning are trademarks of Apple Inc. App Store is a service mark of Apple Inc.



MPEG

Mpeg4 Visual

THIS PRODUCT IS LICENSED UNDER THE MPEG-4 VISUAL PATENT PORTFOLIO LICENSE FOR THE PERSONAL AND NON-COMMERCIAL USE OF A CONSUMER FOR (i) ENCODING VIDEO IN COMPLIANCE WITH THE MPEG-4 VISUAL STANDARD (“MPEG-4 VIDEO”) AND/OR (ii) DECODING MPEG-4 VIDEO THAT WAS ENCODED BY A CONSUMER ENGAGED IN A PERSONAL AND NONCOMMERCIAL ACTIVITY AND/OR WAS OBTAINED FROM A VIDEO PROVIDER LICENSED BY MPEG LA TO PROVIDE MPEG-4 VIDEO. NO LICENSE IS GRANTED OR SHALL BE IMPLIED FOR ANY OTHER USE. ADDITIONAL INFORMATION INCLUDING THAT RELATING TO PROMOTIONAL, INTERNAL AND COMMERCIAL USES AND LICENSING MAY BE OBTAINED FROM MPEG LA, LLC. SEE [HTTP://WWW.MPEGLA.COM](http://www.mpegla.com).

VC-1

THIS PRODUCT IS LICENSED UNDER THE VC-1 PATENT PORTFOLIO LICENSE FOR THE PERSONAL AND NON-COMMERCIAL USE OF A CONSUMER TO (i) ENCODE VIDEO IN COMPLIANCE WITH THE VC-1 STANDARD (“VC-1 VIDEO”) AND/OR (ii) DECODE VC-1 VIDEO THAT WAS ENCODED BY A CONSUMER ENGAGED IN A PERSONAL AND NON-COMMERCIAL ACTIVITY AND/OR WAS OBTAINED FROM A VIDEO PROVIDER LICENSED TO PROVIDE VC-1 VIDEO. NO LICENSE IS GRANTED OR SHALL BE IMPLIED FOR ANY OTHER USE. ADDITIONAL INFORMATION MAY BE OBTAINED FROM MPEG LA, L.L.C. SEE [HTTP://WWW.MPEGLA.COM](http://www.mpegla.com).

AVC/H.264

THIS PRODUCT IS LICENSED UNDER THE AVC PATENT PORTFOLIO LICENSE FOR THE PERSONAL AND NONCOMMERCIAL USE OF A CONSUMER TO (i) ENCODE VIDEO IN COMPLIANCE WITH THE AVC STANDARD ("AVC VIDEO") AND/OR (ii) DECODE AVC VIDEO THAT WAS ENCODED BY A CONSUMER ENGAGED IN A PERSONAL AND NON-COMMERCIAL ACTIVITY AND/OR WAS OBTAINED FROM A VIDEO PROVIDER LICENSED TO PROVIDE AVC VIDEO. NO LICENSE IS GRANTED OR SHALL BE IMPLIED FOR ANY OTHER USE.

ADDITIONAL INFORMATION MAY BE OBTAINED FROM MPEG LA, L.L.C. SEE [HTTP://WWW.MPEGLA.COM](http://www.mpegla.com).

■ SDHC Memory Card

microSDHC Logo is a trademark of SD-3C, LLC.

Use the audio/information screen to customize certain features.

■ How to customize

With the power mode in ON, select **Settings**, then select a setting item.

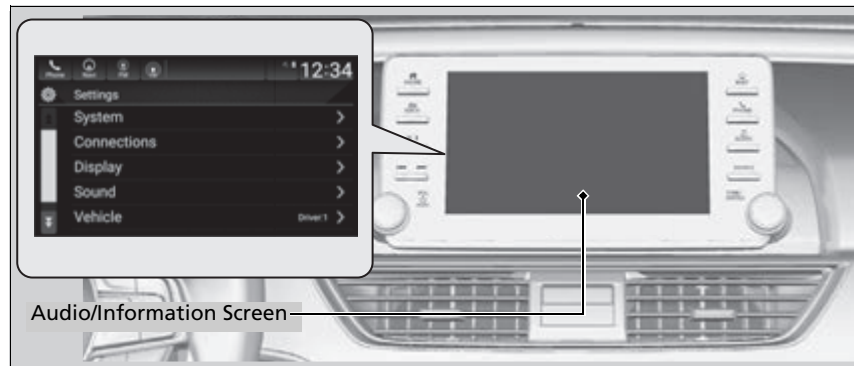

▣ Customized Features

When you customize settings:

- Make sure that the vehicle is at a complete stop.
- Shift to **[P]**.

To customize features detail, refer to the following.

- ▣ **Customization flow** P. 352
- ▣ **List of customizable options** P. 358

■ Customization flow

Press the  button.

Select **Settings**.

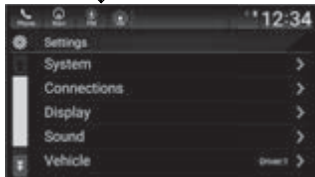

Features

System

Day & Time

Set Date & Time

Automatic Date & Time

Set Date

Set Time

Time Zone

Automatic Time Zone*

(Select time zone)

Auto Daylight Saving Time

Date Format

Time Format

Language

Touch Panel Sensitivity

System Volumes

System Volumes

Reading/Warning

Verbal Reminder

Config. of Instrument Panel

Select configuration

Security

Password

Unknown sources

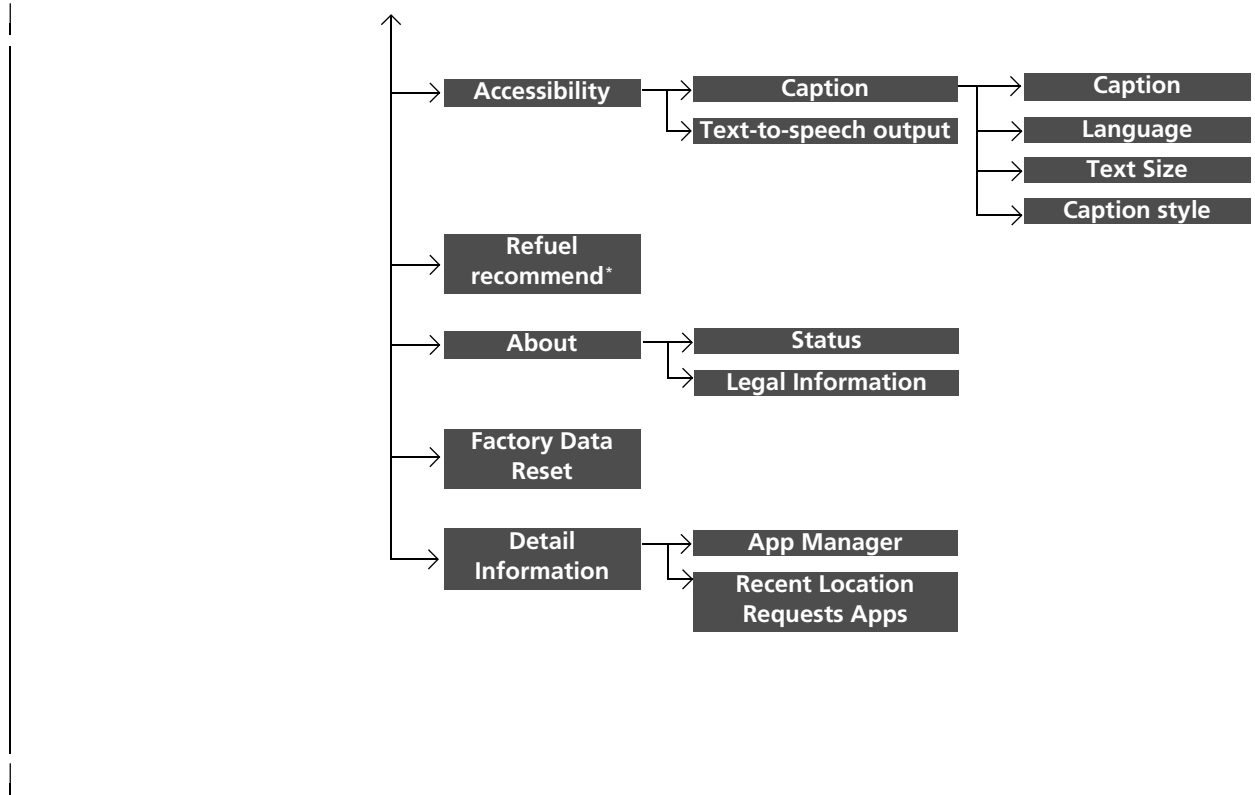

Features

* Not available on all models

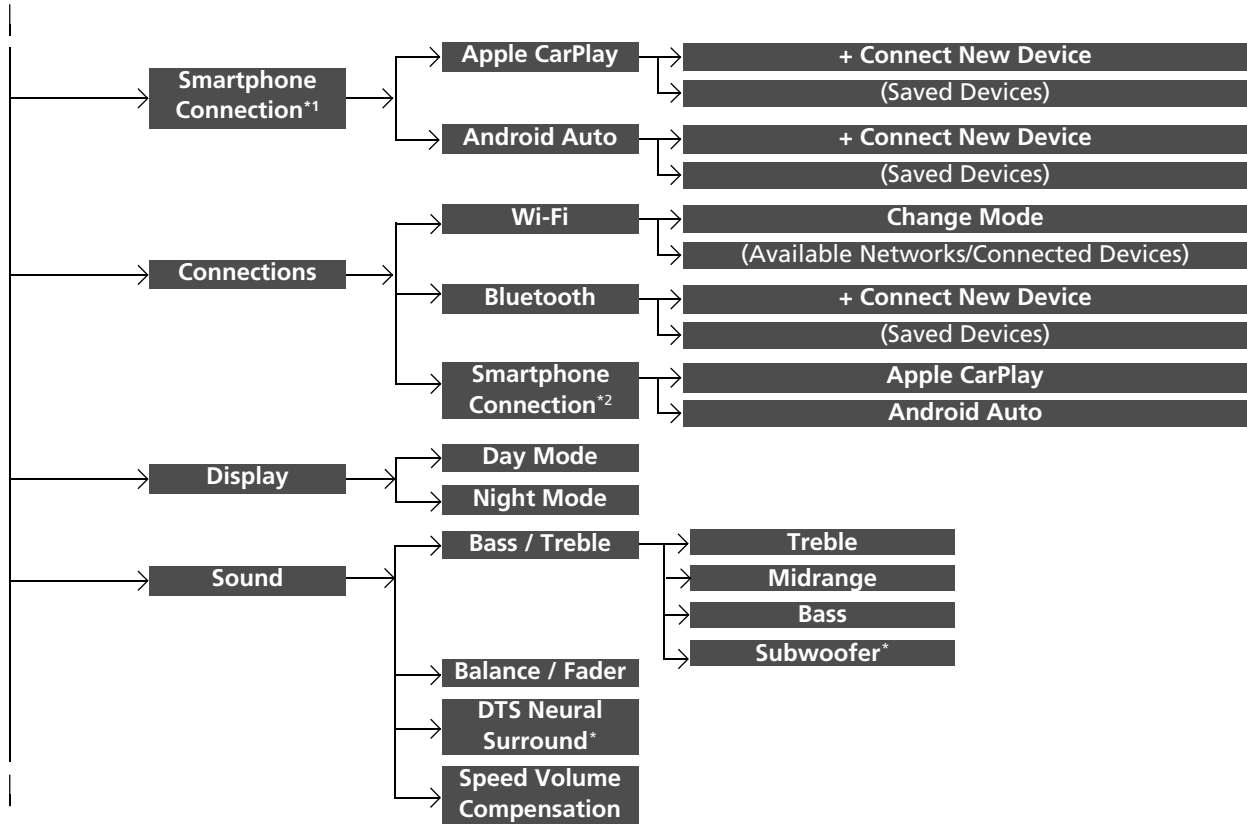

*1: Models with wireless Apple CarPlay and wireless Android Auto
 *2: Models without wireless Apple CarPlay and wireless Android Auto

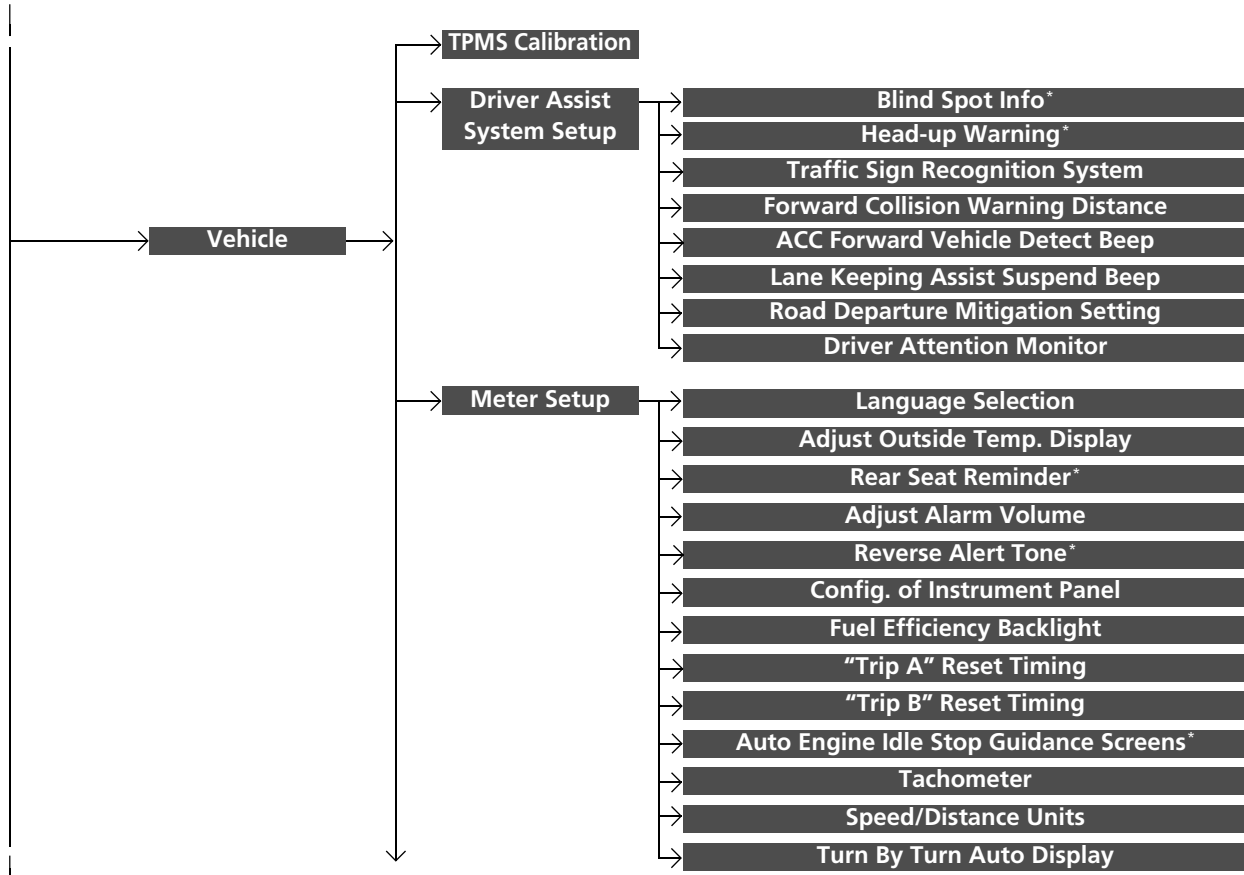

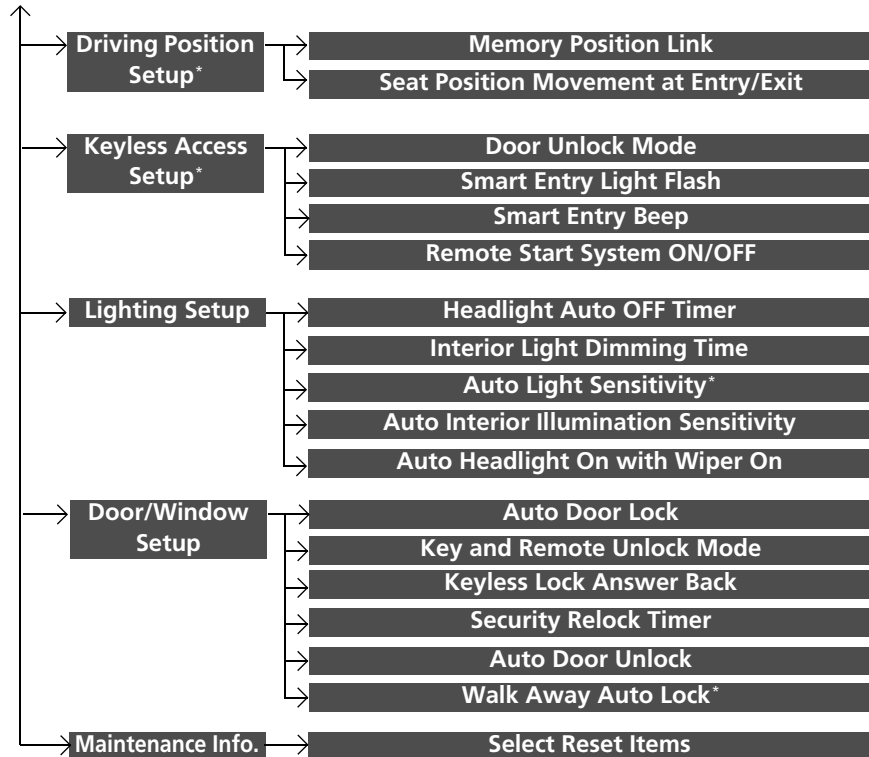

* Not available on all models

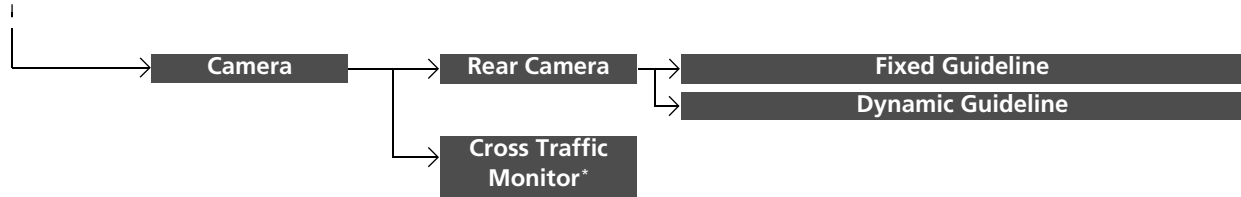



* Not available on all models

■ List of customizable options

Setup Group	Customizable Features	Description	Selectable Settings		
System	Day & Time	Automatic Date & Time	Selects ON to have the GPS automatically adjust the clock. Select OFF to cancel this function.	ON*¹/OFF	
		Set Date & Time	Set Date	Adjusts date.  Adjusting the Clock P. 166	—
		Set Time	Adjusts clock.  Adjusting the Clock P. 166	—	
	Time Zone	Automatic Time Zone*	Sets the navigation system to automatically adjust the clock when driving through different time zones.	ON*¹/OFF	
		(Select time zone)	Changes the time zone manually.	—	
	Auto Daylight Saving Time	Select ON to have the GPS automatically adjust the clock to daylight savings time. Select OFF to cancel this function.	ON*¹/OFF		
	Date Format	Sets the date format.	MM/DD/YYYY*¹/ DD/MM/YYYY/ YYYY/MM/DD		
	Time Format	Selects the digital clock display from 12H to 24H .	12H*¹/24H		

*1:Default Setting

* Not available on all models

Setup Group	Customizable Features	Description	Selectable Settings	
System	Language	Changes the display language.	English (United States)*¹/Español/ Français	
	Touch Panel Sensitivity	Sets the sensitivity of the touch panel screen.	High/Normal*¹	
	System Volumes	System Volumes	Changes the system sounds volume.	—
		Reading/Warning Verbal Reminder	Turns the verbal reminders on and off.	ON*¹/OFF
	Config. of Instrument Panel	Select configuration	Selects whether the apps display comes on or not on the driver information interface.	Config.1*¹/Config.2/ Config.3
	Security	Password	Set the value of password display.	ON*¹/OFF
Unknown sources		—	ON/OFF*¹	

*1:Default Setting

Setup Group	Customizable Features		Description	Selectable Settings
System	Accessibility	Caption	Turns the subtitles on and off.	ON/OFF^{*1}
		Language	Change the subtitle language.	Default^{*1}/English (United States)/Español/Français
		Text Size	Change the subtitle Text Size.	Very small/Small/Normal^{*1}/Large
		Caption style	Change the subtitle Caption style.	Use app defaults^{*1}/White on black/Black on white/Yellow on black/Yellow on blue/Custom
	Text-to-speech output	Current TTS engine TtsService	TtsService	—

*1: Default Setting

Setup Group	Customizable Features	Description	Selectable Settings	
System	Refuel recommend*	Turns the refuel recommend function on and off. ▶ Refuel Recommend P. 400	ON*1/OFF	
	About	Status	Displays the Android setting items.	—
		Legal Information		
	Factory Data Reset	Resets all the settings to their factory default. ▶ Defaulting All the Settings P. 370	Continue/Cancel	
	Detail Information	App Manager	Displays the Android system memory and apps information.	—
Recent Location Requests Apps		Displays the recent location requests from apps.	—	

*1:Default Setting

Setup Group	Customizable Features	Description	Selectable Settings	
Smartphone Connection* ²	+ Connect New Device	Pairs a new phone to Apple CarPlay. ➤ Phone Setup P. 379	—	
	(Saved Devices)	Connects, disconnects, or deletes a paired phone. ➤ Phone Setup P. 379	—	
	+ Connect New Device	Pairs a new phone to Android Auto. ➤ Phone Setup P. 379	—	
	(Saved Devices)	Connects, disconnects, or deletes a paired phone. ➤ Phone Setup P. 379	—	
Connections	Change Mode	Changes the Wi-Fi mode.	Network*¹/Hotspot/OFF	
	(Available Networks/Connected Devices)	Displays the available network(s) or current connected device(s).	—	
	+ Connect New Device	Pairs a new phone to HFL. ➤ Phone Setup P. 379	—	
	(Saved Devices)	Connects, disconnects, or deletes a paired phone. ➤ Phone Setup P. 379	—	
	Smartphone Connection*³	Apple CarPlay	Sets up the Apple CarPlay connection.	—
	Android Auto	Sets up the Android Auto connection.	—	

*1: Default Setting

*2: Models with wireless Apple CarPlay and wireless Android Auto

*3: Models without wireless Apple CarPlay and wireless Android Auto

Setup Group	Customizable Features	Description	Selectable Settings
Display	Day Mode	Adjusts the settings of the audio/information screen. ▶ Display Setup P. 273	—
	Night Mode		
Sound	Treble	Adjusts the settings of the audio speakers' sound. ▶ Adjusting the Sound P. 272	—
	Midrange		
	Bass		
	Subwoofer*		
	Balance / Fader		
	DTS Neural Surround*		
	Speed Volume Compensation		
	TPMS Calibration	Cancels/Calibrates the tire pressure monitoring system (TPMS).	Calibrate/Cancel
Vehicle	Blind Spot Info*	Changes the setting for the blind spot information.	Audible And Visual Alert*1/Visual Alert
	Driver Assist System Setup	Head-up Warning*	Turns the head-up warning on and off. ON*1/OFF
	Traffic Sign Recognition System	Select On/Off to indicate small displaying traffic sign icon on the driver information interface and the head-up display*.	Small Icons ON*1/ Small Icons OFF

*1:Default Setting

* Not available on all models

Setup Group	Customizable Features	Description	Selectable Settings
Vehicle	Driver Assist System Setup		
	Forward Collision Warning Distance	Changes Collision Mitigation Braking System™ (CMBS™) alert distance.	Normal*¹/Short/Long
	ACC Forward Vehicle Detect Beep	Causes the system to beep when the system detects a vehicle, or when the vehicle goes out of the ACC with Low Speed Follow range.	ON/OFF*¹
	Lane Keeping Assist Suspend Beep	Causes the system to beep when Lane Keeping Assist System (LKAS) is suspended.	ON/OFF*¹
	Road Departure Mitigation Setting	Changes the setting for the road departure mitigation system.	Normal*¹/Wide/Warning Only/Narrow
	Driver Attention Monitor	Changes the setting for the driver attention monitor.	OFF/Tactile Alert/Tactile And Audible Alert*¹
	Meter Setup		
	Language Selection	Changes the display language.	English*¹/Français/Español
	Adjust Outside Temp. Display	Adjusts the temperature reading by a few degrees.	-5°F ~ ±0°F*¹ ~ +5°F (U.S.) -3°C ~ ±0°C*¹ ~ +3°C (Canada)
	Rear Seat Reminder*	Turns the Rear Seat Reminder feature on and off.	ON*¹/OFF
	Adjust Alarm Volume	Changes the alarm volume, such as the buzzers, warnings, turn signal sound, and so on.	High/Mid*¹/Low

*1: Default Setting

* Not available on all models

Setup Group	Customizable Features	Description	Selectable Settings	
Vehicle	Meter Setup	Reverse Alert Tone*	Turns the reverse alert tone on and off.	ON^{*1}/OFF
		Config. of Instrument Panel	Selects whether the apps display comes on or not on the driver information interface.	Config.1^{*1}/Config.2/Config.3
		Fuel Efficiency Backlight	Turns the ambient meter feature on and off.	ON^{*1}/OFF
		"Trip A" Reset Timing	Changes the setting of how to reset trip meter A and average fuel economy A.	When Fully Refueled/Manually Reset^{*1}/IGN OFF
		"Trip B" Reset Timing	Changes the setting of how to reset trip meter B and average fuel economy B.	When Fully Refueled/Manually Reset^{*1}/IGN OFF
		Auto Engine Idle Stop Guidance Screens*	Selects whether the Auto Idle Stop display comes on or not.	ON^{*1}/OFF
		Tachometer	Selects whether the tachometer come on the driver information interface.	ON/OFF^{*1}
	Speed/Distance Units	Selects the trip computer units.	km/h · km/mph · miles^{*1} (U.S.) km/h · km^{*1}/mph · miles (Canada)	

*1:Default Setting

* Not available on all models

Setup Group	Customizable Features		Description	Selectable Settings
Vehicle	Meter Setup	Turn By Turn Auto Display	Selects whether the turn-by-turn display comes on during the route guidance.	ON*¹/OFF
	Driving Position Setup*	Memory Position Link	Turns the driving position memory system on and off.	ON*¹/OFF
		Seat Position Movement at Entry/Exit	Moves the seat rearward when you get in/get out of the vehicle. Changes the setting for this feature.	ON*¹/OFF
	Keyless Access Setup*	Door Unlock Mode	Changes which doors unlock when you grab the driver's door handle.	Driver Door Only*¹/ All Doors
		Smart Entry Light Flash	Causes some exterior lights to flash when you unlock/lock the doors.	ON*¹/OFF
		Smart Entry Beep	Causes the beeper to sound when you unlock/lock the doors.	ON*¹/OFF
		Remote Start System ON/OFF	Turns the remote engine start feature on and off.	ON*¹/OFF

*1:Default Setting

Setup Group	Customizable Features	Description	Selectable Settings	
Vehicle	Lighting Setup	Headlight Auto OFF Timer	Changes the length of time the exterior lights stay on after you close the driver's door.	0 sec/15 sec^{*1}/30 sec/60 sec
		Interior Light Dimming Time	Changes the length of time the interior lights stay on after you close the doors.	15 sec/30 sec^{*1}/60 sec
		Auto Light Sensitivity*	Changes the timing for the headlights to come on.	Min/Low/Mid^{*1}/High/Max
		Auto Interior Illumination Sensitivity	Changes the sensitivity of the brightness of the instrument panel when the headlight switch is in AUTO .	Min/Low/Mid^{*1}/High/Max
		Auto Headlight On with Wiper On	Used to automatically come on the headlights when the wipers are used several times within a certain number of intervals with the headlight switch is in AUTO .	ON^{*1}/OFF

*1:Default Setting

Setup Group	Customizable Features	Description	Selectable Settings
Vehicle	Door/Window Setup		
	Auto Door Lock	Changes the setting for the automatic locking feature.	OFF/With Vehicle Speed*¹/Shift From P
	Key and Remote Unlock Mode	Sets up either the driver's door or all doors to unlock on the first push of the keyless remote or built-in key.	Driver Door Only*¹/All Doors
	Keyless Lock Answer Back	LOCK/UNLOCK- The exterior lights flash. LOCK (2nd push)- The beeper sounds.	ON*¹/OFF
	Security Relock Timer	Changes the time it takes for the doors to relock and the security system to set after you unlock the vehicle without opening any door.	30sec*¹/60sec/90sec
	Auto Door Unlock	Changes the setting for when the doors unlock automatically.	OFF/All Doors When Driver's Door Opens*¹/All Doors When Shifted to Park/All Doors With IGN OFF
	Walk Away Auto Lock*	Changes the settings for the auto lock function when you walk away from the vehicle.	ON/OFF*¹
Maintenance Info.	Select Reset Items	Resets the engine oil life display when you have performed the maintenance service.	—

*1:Default Setting

Setup Group	Customizable Features	Description	Selectable Settings
Camera	Rear Camera	Fixed Guideline Selects whether the guidelines come on the rear camera monitor. 🗖 Multi-View Rear Camera P. 529	ON^{*1}/OFF
		Dynamic Guideline Selects whether the guidelines come on the rear camera monitor. 🗖 Multi-View Rear Camera P. 529	ON^{*1}/OFF
	Cross Traffic Monitor[*]	Turns the cross traffic monitor on and off.	ON^{*1}/OFF

*1:Default Setting

Defaulting All the Settings

Reset all the menu and customized settings as the factory defaults.

■ Defaulting System Settings

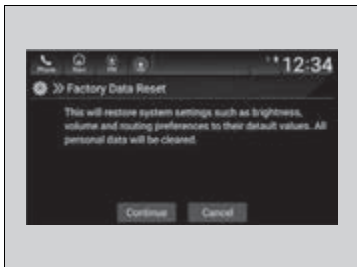

1. Press the  button.
2. Select **Settings**.
3. Select **System**.
4. Select **Factory Data Reset**.
 - A confirmation message appears on the screen.
5. Select **Continue** to reset the settings.
6. Select **Continue** again to reset the settings.
 - The system will reboot.

■ Defaulting Vehicle Settings

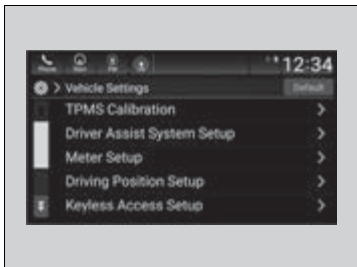

1. Press the  button.
2. Select **Settings**.
3. Select **Vehicle**.
4. Select **Default**.
5. Select **Yes**.

►► Defaulting All the Settings

When you transfer the vehicle to a third party, reset all settings to default and delete all personal data.

If you perform **Factory Data Reset**, it will reset the preinstalled apps to their factory default.

If you perform **Factory Data Reset**, you cannot use the HondaLink® because it goes offline.

► **HondaLink®** P. 301

The HomeLink® Universal Transceiver can be programmed to operate up to three remote controlled devices around your home, such as garage doors, lighting, or home security systems.

■ Important Safety Precautions

Refer to the safety information that came with your garage door opener to test that the safety features are functioning properly. If you do not have the safety information, contact the manufacturer.

Before programming HomeLink, make sure that people and objects are out of the way of the garage or gate to prevent potential injury or damage.

When programming a garage door opener, park just outside the garage door's path.

⌘ HomeLink® Universal Transceiver*

Before programming HomeLink to operate a garage door opener, confirm that the opener has an external entrapment protection system, such as an "electronic eye," or other safety and reverse stop features. If it does not, HomeLink may not be able to operate it.

NOTE:

Some LED lightbulbs installed in the garage door opener can interfere with the training and consistent operation of your HomeLink device. Please consider use of Low RF interference bulbs in your garage door opener.

* Not available on all models

Training HomeLink

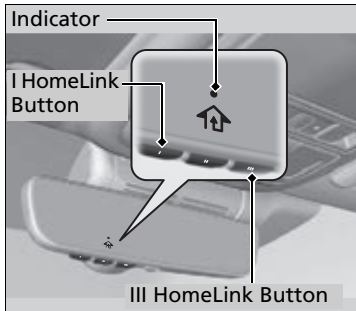

If it is necessary to erase a previously entered learned code:

- Press and hold the I and III HomeLink buttons for about 10 seconds, until the green indicator blinks. Release the buttons, and proceed to step 1.
- If you are training the second or third button, go directly to step 1.

The instructions on the next page should work for most gate or garage openers, but may not work for all. For detailed instructions about your specific remote opener, visit <http://www.homelink.com> or call (800) 355-3515.

Programming a Button

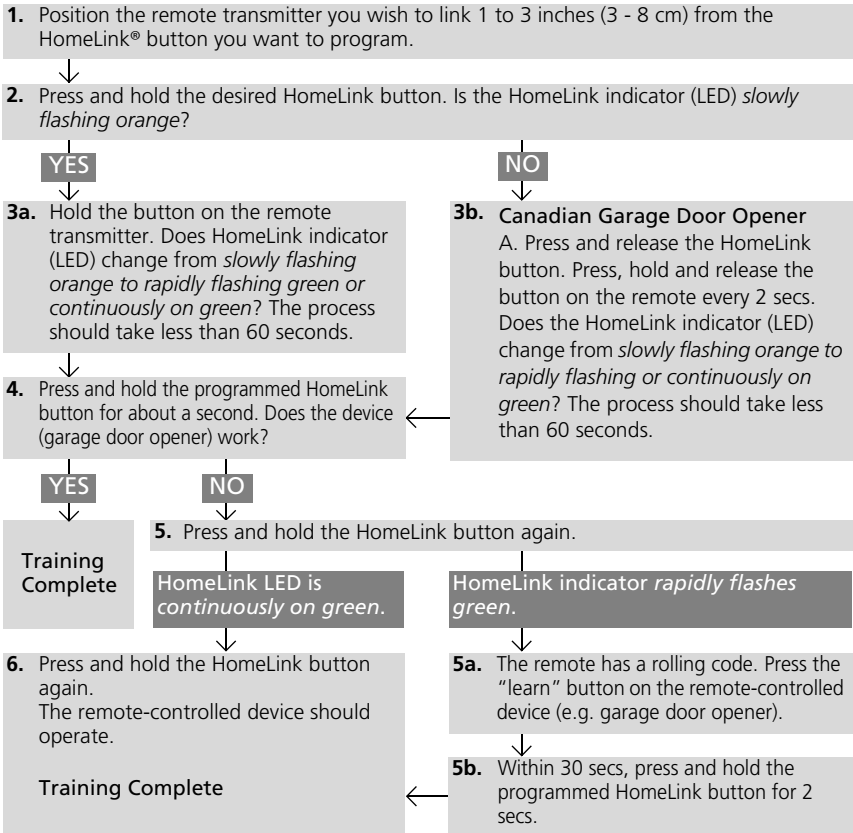

Training HomeLink

Reprogramming a Button
If you want to retrain a programmed button for a new device, you do not have to erase all button memory. You can replace the existing memory code using this procedure:

1. Press and hold the desired HomeLink button until the HomeLink indicator begins to *slowly flash orange*. This should take about 20 seconds.
2. Release the HomeLink button and position the remote transmitter you wish to link 1 - 3 inches (3 - 8 cm) from the HomeLink button you want to program, then follow steps 3 - 6 under "programming a button."

Erasing Button Memory
To erase programming from the buttons, press and hold the two outside HomeLink buttons until the HomeLink indicator changes from *orange to rapidly flashing green*. This should take about 10 seconds. You should erase all programming before selling the vehicle.

Operating
To operate, simply press and release the programmed HomeLink button. Activation will now occur for the trained device.

Questions
For questions or comments, visit www.HomeLink.com, www.youtube.com/HomeLinkGentex, or by calling the HomeLink Hotline (North America only) at (800) 355-3515.

HomeLink® is a registered trademark of Gentex Corporation.

Bluetooth® HandsFreeLink® (HFL) allows you to place and receive phone calls using your vehicle's audio system, without handling your cell phone.

Using HFL

HFL Buttons

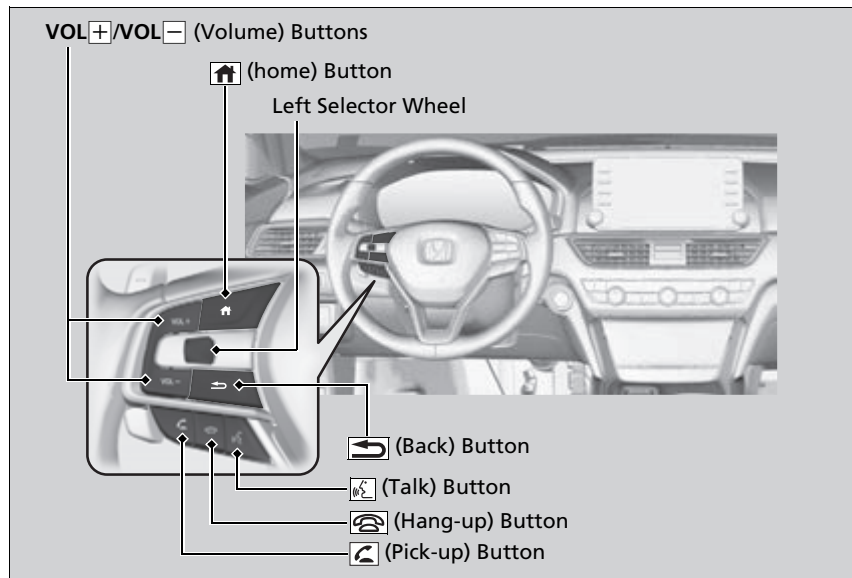

Bluetooth® HandsFreeLink®

Place your phone where you can get good reception.

To use HFL, you need a *Bluetooth*-compatible cell phone. For a list of compatible phones, pairing procedures, and special feature capabilities:

- U.S.: Visit automobiles.honda.com/handsfreelink/, or call 1-888-528-7876.
- Canada: For more information on smartphone compatibility, call 1-855-490-7351.

To use the system, the **Bluetooth** setting must be **ON**.

➤ **Phone Setup** P. 379

Voice control tips

- Aim the vents away from the ceiling and close the windows, as noise coming from them may interfere with the microphones.
- Press the  button when you want to call a number using a phonebook name or a number. Speak clearly and naturally after a beep.
- If the microphones pick up voices other than yours, the command may be misinterpreted.
- To change the volume level, select the audio system's **VOL** (Volume) or use the remote audio controls on the steering wheel.

If there is no Favorite Contact entry in the system, the pop-up notification appears on the screen.

➤ **Favorite Contacts** P. 385

 **(Pick-up) button:** Press to go directly to the phone menu on the driver information interface, or to answer an incoming call.

 **(Hang-up) button:** Press to end a call.

 **(Back) button:** Press to go back to the previous screen, or cancel a command.

 **(Talk) button:** Press to access Voice Portal.

Left Selector Wheel: Press the  (home) button, then roll up or down to select **Phone** on the driver information interface, and then press the left selector wheel.

 **(home) button:** Press to go back to the home screen of the driver information interface.

To go to the phone screen of the driver information interface:

1. Press the  (home) button on the steering wheel.
2. Roll up or down the left selector wheel to select **Phone**, then push the left selector wheel.
 - ▶ You can select **Favorite Contacts** or **Recent Calls**.

Bluetooth® HandsFreeLink®

Bluetooth® Wireless Technology

The *Bluetooth®* word mark and logos are registered trademarks owned by *Bluetooth SIG, Inc.*, and any use of such marks by Honda Motor Co., Ltd., is under license. Other trademarks and trade names are those of their respective owners.

HFL Limitations

An incoming call on HFL will interrupt the audio system when it is playing. It will resume when the call is ended.

■ HFL Status Display

The audio/information screen notifies you when there is an incoming call.



■ Limitations for Manual Operation *

Certain manual functions are disabled or inoperable while the vehicle is in motion. You cannot select a grayed-out option until the vehicle is stopped.

Only previously stored phonebook names or numbers can be called using voice commands while the vehicle is in motion.

▶ **Favorite Contacts** P. 385

▶▶ HFL Status Display

The information that appears on the audio/information screen varies between phone models.

HFL Menu

The power mode must be in ACCESSORY or ON to use the system.

■ Phone settings screen

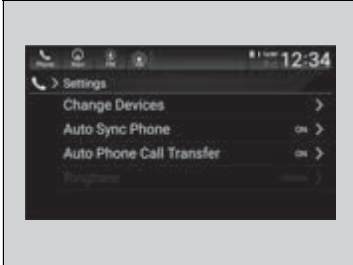

1. Press the  button.
2. Select **Phone**.
3. Select **Settings**.

☒ HFL Menu

To use HFL, you must first pair your *Bluetooth*-compatible cell phone to the system while the vehicle is parked.

Some functions are limited while driving.

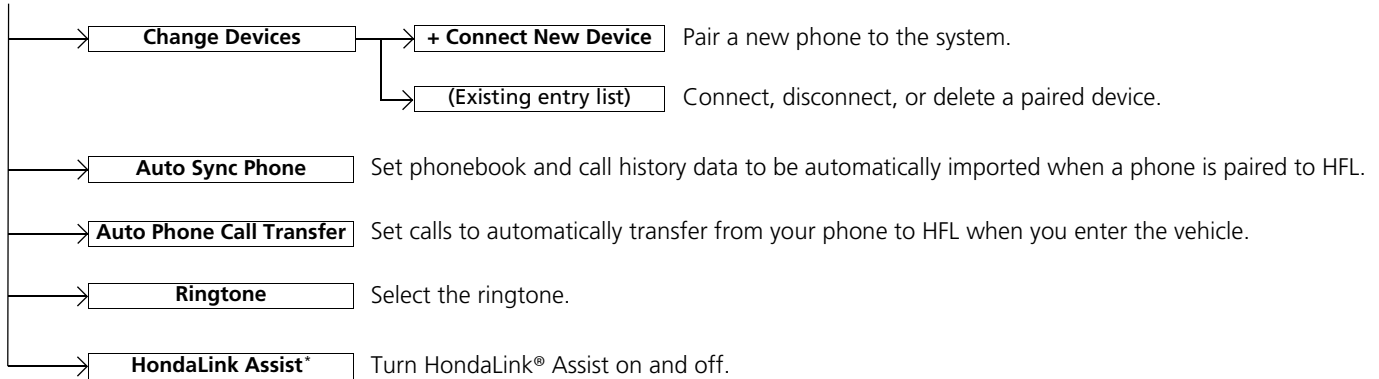

* Not available on all models

■ Phone menu screen

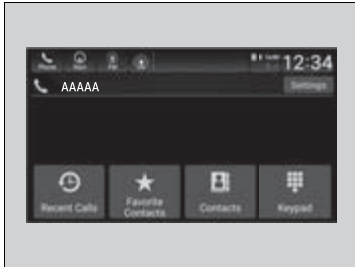

1. Press the  button.
2. Select **Phone**.

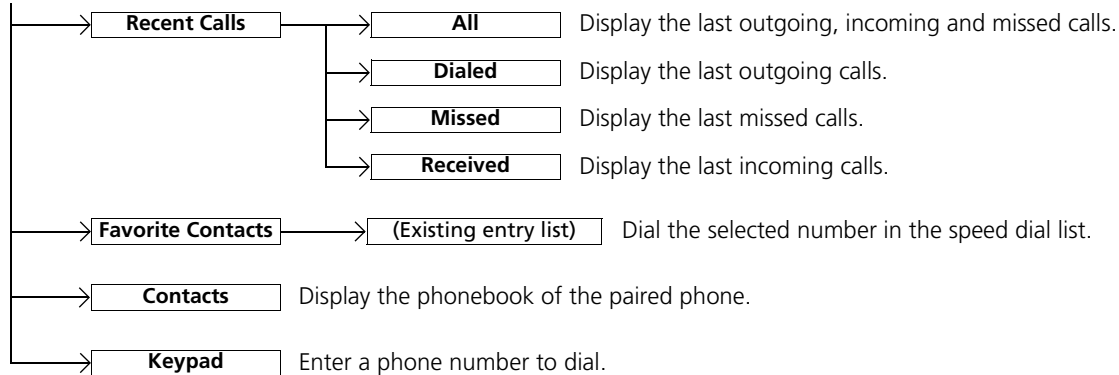

Phone Setup

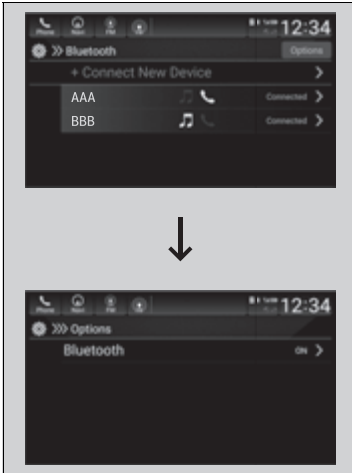

■ **Bluetooth® setup**

You can turn *Bluetooth*® function on and off.

1. Press the  button.
2. Select **Settings**.
3. Select **Connections**.
4. Select **Bluetooth**.
5. Select **Options**.
6. Select **Bluetooth**, then **ON**.



■ **To pair a cell phone (when there is no phone paired to the system)**

1. Press the  button.
2. Select **Phone**.
3. Select **Connect Phone**.
4. Make sure your phone is in search or discoverable mode, then select **+ Connect New Device**.
 - ▶ HFL automatically searches for a *Bluetooth*® device.
5. Select your phone when it appears on the list.
 - ▶ If your phone still does not appear, search for *Bluetooth*® devices using your phone. From your phone, search for **HandsFree Link**.
6. The system gives you a pairing code on the audio/information screen.
 - ▶ Confirm if the pairing code on the screen and your phone match. This may vary by phone.
7. Select desired functions and then select **Connect**.

☞ Phone Setup





Your *Bluetooth*-compatible phone must be paired to the system before you can make and receive hands-free calls.

Phone Pairing Tips:

- You cannot pair your phone while the vehicle is moving.
- Up to six phones can be paired.
- Your phone's battery may drain faster when it is paired to the system.

Once you have paired a phone, you can see it displayed on the screen with one or more icons on the right side.

These icons indicate the following:

- : The phone is compatible with *Bluetooth*® Audio.
- : The phone can be used with HFL.
- : The phone is compatible with Apple CarPlay.
- : The phone is compatible with Android Auto.

If there is an active connection to Apple CarPlay or Android Auto, pairing of additional *Bluetooth* compatible devices is unavailable.

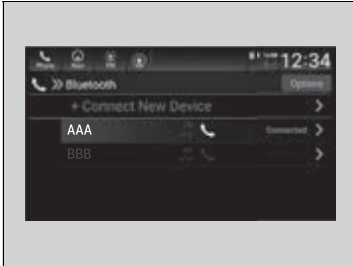

■ **To change the currently paired phone**

1. Go to the phone settings screen.
 - ▶ **Phone settings screen** P. 377
2. Select **Change Devices**.
3. Select a phone to connect.
 - ▶ HFL disconnects the connected phone and starts searching for another paired phone.
4. Select , , * or *.
 - ▶ and can be selected simultaneously, however, when * or * is selected, and cannot be selected.
5. Select **Apply**.

☒ **To change the currently paired phone**

If no other phones are found or paired when trying to switch to another phone, HFL will inform you that the original phone is connected again.

To pair other phones, select **+ Connect New Device** from the **Bluetooth** screen.

* Not available on all models

Continued



■ **To delete a paired phone**

1. Go to the phone settings screen.
 - ▶ **Phone settings screen** P. 377
2. Select **Change Devices**.
3. Select a phone you want to delete.

4. Select **Delete**.
5. A confirmation message appears on the screen. Select **Yes**.

Ringtone

You can change the ringtone setting.

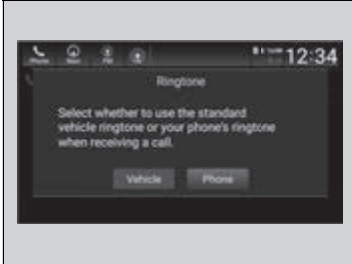

1. Go to the phone settings screen.
 Phone settings screen P. 377
2. Select **Ringtone**.
3. Select **Vehicle** or **Phone**.

Automatic Transferring

If you get into the vehicle while you are on the phone, the call can be automatically transferred to HFL.

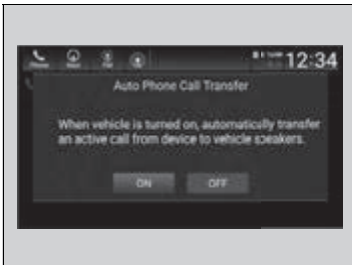

1. Go to the phone settings screen.
 Phone settings screen P. 377
2. Select **Auto Phone Call Transfer**.
3. Select **ON** or **OFF**.

Ringtone

Vehicle: The fixed ringtone sounds from the speakers.

Phone: Depending on the make and model of the mobile phone, the ringtone stored in the phone will sound if the phone is connected.

■ Automatic Import of Cellular Phonebook and Call History

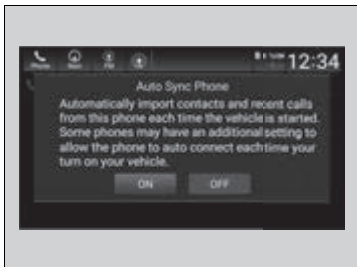
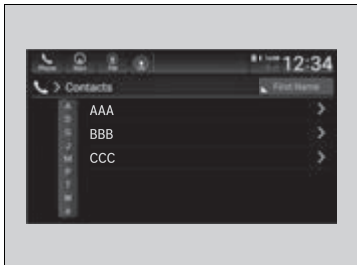

■ When Automatic Phone Sync is set to On:

When your phone is paired, the contents of its phonebook and call history are automatically imported to the system.

■ Changing the Automatic Phone Sync setting

1. Go to the phone settings screen.
 - ▶ Phone settings screen P. 377
2. Select **Auto Sync Phone**.
3. Select **ON** or **OFF**.

▶▶ Automatic Import of Cellular Phonebook and Call History

On some phones, you will be asked to allow your cellular phonebook to be imported.

When you select a name from the list in the cellular phonebook, you can see a category icon. The icons indicate what types of numbers are stored for that name.



On some phones, it may not be possible to import the category icons to the system.

The phonebook is updated after every connection. Call history is updated after every connection or call.

Favorite Contacts

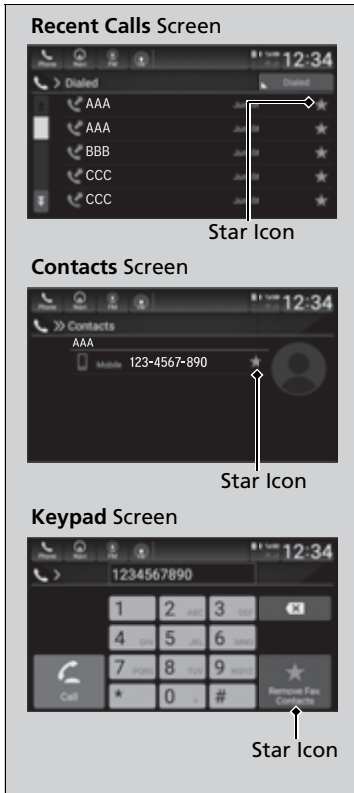

To store a number as a favorite contact:

1. Go to the phone menu screen.
 - ▶ **Phone menu screen** P. 378
2. Select the **Recent Calls, Contacts,** or **Keypad** screen.
3. Select the star icon.
 - ▶ A notification appears on the screen if the favorite contact is successfully stored.
 - ▶ To remove the favorite contact, select the star icon again.

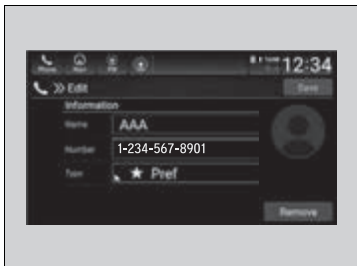

■ To edit a favorite contact

1. Go to the phone menu screen.
 - ▶ **Phone menu screen** P. 378
2. Select **Favorite Contacts**.
3. Select **Edit** on the favorite contact entry you want to edit.
4. Select a setting you want.
5. Select **Save**.

■ To delete a favorite contact

1. Go to the phone menu screen.
 - ▶ **Phone menu screen** P. 378
2. Select **Favorite Contacts**.
3. Select **Edit** on the favorite contact entry you want to delete.
4. Select **Remove**.
5. A confirmation message appears on the screen. Select **Yes**.

Making a Call

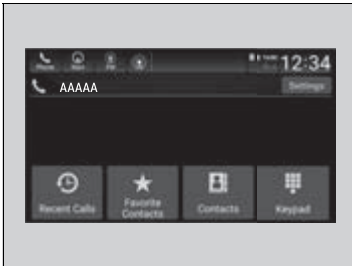

You can make calls by inputting any phone number, or by using the imported phonebook, call history, or favorite contact entries.

▶▶ Making a Call

Once a call is connected, you can hear the voice of the person you are calling through the audio speakers.

While there is an active connection with Apple CarPlay, phone calls cannot be made with HandsFreeLink® and are only made from Apple CarPlay.

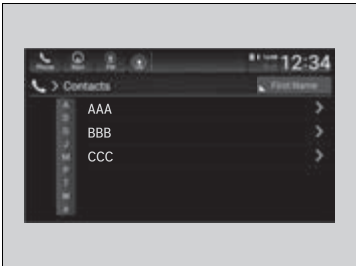

■ **To make a call using the imported phonebook**

1. Go to the phone menu screen.
 - ▶ **Phone menu screen** P. 378
2. Select **Contacts**.
3. Select a name.
 - ▶ You can sort by **First Name** or **Last Name**. Select the icon on the upper right of the screen.
4. Select a number.
 - ▶ Dialing starts automatically.



■ **To make a call using a phone number**

1. Go to the phone menu screen.
 - ▶ **Phone menu screen** P. 378
2. Select **Keypad**.
3. Select a number.
 - ▶ Use the keyboard on the touch screen for entering numbers.
4. Select **Call**.
 - ▶ Dialing starts automatically.

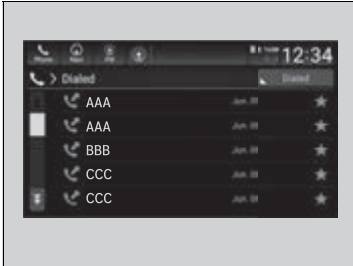

■ **To make a call using the call history**

Call history is stored by **All**, **Dialed**, **Missed**, and **Received**.

1. Go to the phone menu screen.

▶ **Phone menu screen** P. 378

2. Select **Recent Calls**.

▶ You can sort by **All**, **Dialed**, **Missed**, or **Received**. Select the icon on the upper right of the screen.

3. Select a number.

▶ Dialing starts automatically.

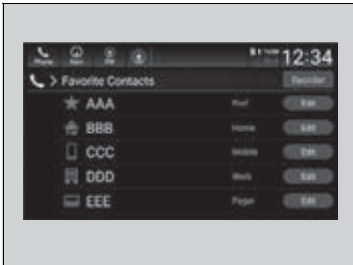

■ **To make a call using a favorite contact entry**

1. Go to the phone menu screen.

▶ **Phone menu screen** P. 378

2. Select **Favorite Contacts**.

▶ You can change the order of favorite contact entries by selecting **Reorder**.

3. Select a number.

▶ Dialing starts automatically.



☒ **To make a call using the call history**

The call history appears only when a phone is connected to the system.

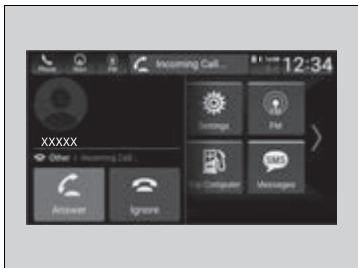
■ Receiving a Call



When there is an incoming call, an audible notification sounds (if activated) and the **Incoming Call...** screen appears.

Press the  button to answer the call.
Press the  button to decline or end the call.

■ Options During a Call

The following options are available during a call.

Mute: Mute your voice.

Use Handheld: Transfer a call from the system to your phone.

Keypad: Send numbers during a call. This is useful when you call a menu-driven phone system.



The available options are shown on the lower half of the screen.

Select the option.

- ▶ The mute icon appears when **Mute** is selected. Select **Mute** again to turn it off.

▣ Receiving a Call



Call Waiting

Press the  button to put the current call on hold to answer the incoming call.

Press the  button again to return to the current call.

Select **Ignore** to ignore the incoming call if you do not want to answer it.

Press the  button if you want to hang up the current call.

You can select the icons on the audio/information screen instead of the  and  buttons.

▣ Options During a Call

You can select the icons on the audio/information screen.

To Set Up Text Message Options

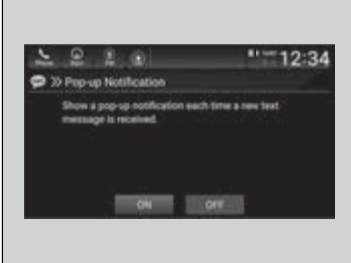

To turn on or off the text message notice

1. Press the  button.
2. Select **Messages**.
3. Select **Settings**.
4. Select **Pop-up Notification**.
5. Select **ON** or **OFF**.

To Set Up Text Message Options

To use the text message function, it may be necessary to set up on your phone.

To turn on or off the text message notice

ON: A pop-up notification comes on every time you receive a new message.

OFF: The message you receive is stored in the system without notification.

Continued

■ Receiving a Text Message

HFL can display newly received text messages as well as the last 20 messages received on a linked cell phone. Each received message can be read aloud and replied to using a fixed common phrase.

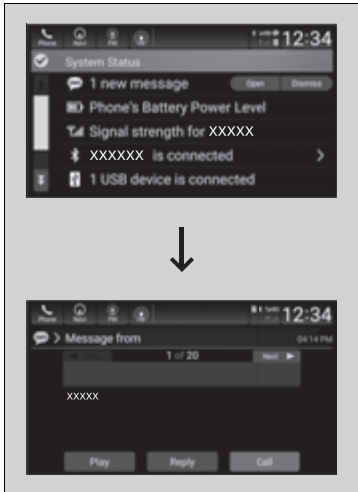

1. Select the system status icon.
 - ▶ The status area appears.
2. A pop-up appears and notifies you of a new text message.
3. Select **Open** to display the message.
 - ▶ The text message is displayed.
4. Select **Play** to listen to the message. To discontinue the message read-out, select **Stop**.

▶▶ Receiving a Text Message

Some mobile phones might not be able to read the transmission log of data sent and data received.

The system does not display any received messages while you are driving. You can only hear them read aloud.

The system can only receive messages that are sent as text (SMS) messages. The message sent using the data services will not be displayed in the list.

With some phones, you may be able to display up to 20 of the last text messages received.

State or local laws may limit your use of the HFL text message feature. Only use the text message feature when conditions allow you to do so safely.

Selecting a Phone

You can select one from the *Bluetooth*® device list to be active and receive notifications.

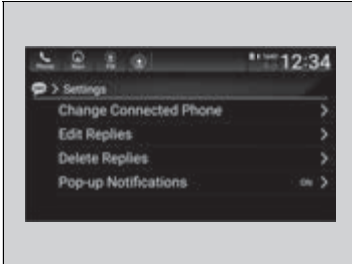

1. Press the  button.
2. Select **Messages**.
3. Select **Settings**.
4. Select **Change Connected Phone**.
5. Change a desired phone.
 - ▣ **To change the currently paired phone**

P. 381

Selecting a Phone

You can only receive notifications from one phone at a time.

Continued

■ Displaying Messages

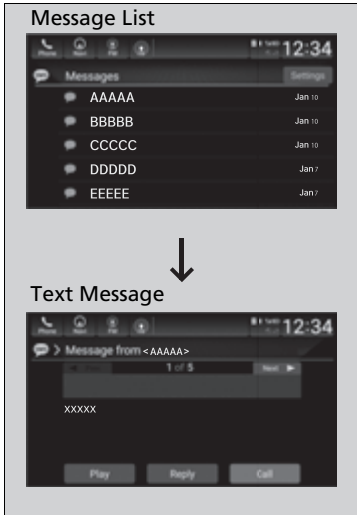



1. Press the  button.
2. Select **Messages**.
 - ▶ Select a phone if necessary.
3. Select a message.
 - ▶ The text message is displayed.

» Displaying Messages

The  (blue) icon appears next to an unread message.

If you delete a message on the phone, the message will also be deleted from the system. If you send a message from the system, the message goes to your phone's outbox.

To see the previous or next message, select  **Prev.** or **Next**  on the message screen.

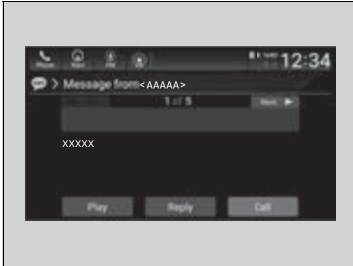

■ Read or Stop reading a message

1. Go to the text message screen.
2. Select **Play**.
 - ▶ The system starts reading the message aloud.
3. Select **Stop** to stop reading.
 - Select **Play** again to start reading the message.

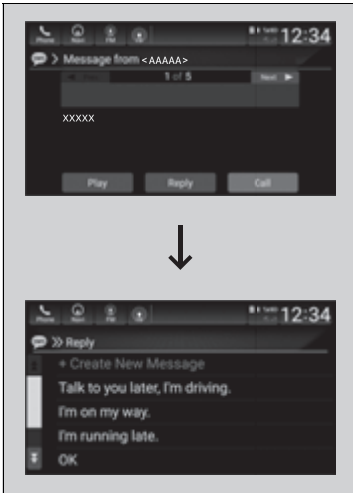

■ Reply to a message

1. Go to the text message screen.
2. Select **Reply**.
3. Select the reply message.
 - ▶ The pop-up menu appears on the screen.
4. Select **Send** to send the message.
 - ▶ **Message sent** appears on the screen when the reply message was successfully sent.

☒ Reply to a message

The available reply messages are as follows:

- **Talk to you later, I'm driving.**
- **I'm on my way.**
- **I'm running late.**
- **OK**
- **Yes**
- **No**

The default reply messages are displayed only in English. If you want to use reply messages in languages other than English, please edit them.

☒ **To edit a reply message** P. 396

You can add a reply message by selecting **+ Create New Message**.

☒ **To edit a reply message** P. 396

Only certain phones receive and send messages when paired and connected. For a list of compatible phones:

- U.S.: Visit automobiles.honda.com/handsfreelink/, or call 1-888-528-7876.
- Canada: For more information on smartphone compatibility, call 1-855-490-7351.

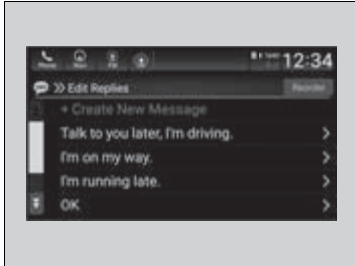

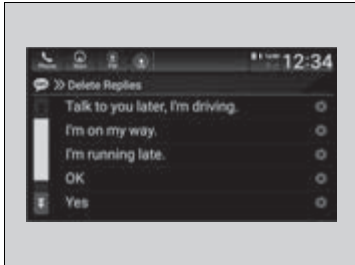

■ To edit a reply message

1. Press the  button.
2. Select **Messages**.
3. Select **Settings**.
4. Select **Edit Replies**.
5. Select the reply message you want to edit or **+ Create New Message**.
 - ▶ The on-screen keyboard screen is displayed.
6. Enter a reply message, and then select **Save**.



■ To delete a reply message

1. Press the  button.
2. Select **Messages**.
3. Select **Settings**.
4. Select **Delete Replies**.
5. Select  on the reply message you want to delete.
 - ▶ The pop-up menu appears on the screen.
6. Select **Yes**.

▶▶ To edit a reply message

You can change the order of reply messages by selecting **Reorder**.

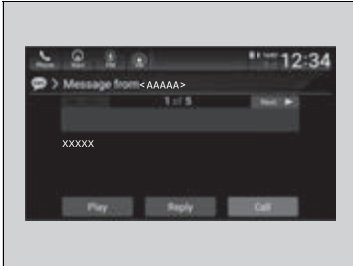

■ **Making a call to a sender**

1. Go to the text message screen.
2. Select **Call**.

HondaLink® Assist*

■ In Case of Emergency

■ Automatic collision notification



If your vehicle's airbags deploy or if the unit detects that the vehicle is severely impacted, your vehicle automatically will attempt to connect to the HondaLink® operator. If connected, information about your vehicle, its location, and its condition can be sent to the operator*¹; you also can speak to the operator when connected.

IMPORTANT: For vehicles equipped with HondaLink® Assist, owner activation constitutes authorization for Honda to collect information from your vehicle needed to provide the service, and agreement to the Terms of Use at www.hondalink.com/TermsAndConditions. In a crash, HondaLink® Assist will attempt to notify emergency services but NEITHER HONDA NOR ITS SERVICE PROVIDERS GUARANTEE THAT SUCH NOTIFICATION WILL OCCUR.

Honda reserves the right to terminate HondaLink® Assist services at any time or for any reason, and in the future may not be able to provide services due to changes in, or obsolescence of, technology integral to the service or changes in governmental regulation.

*1: Depending on your phone and adequate cellular coverage, your vehicle's location may not be sent to the operator.

▶▶ HondaLink® Assist*

HondaLink® Assist also provides services you can operate from the Internet or your smartphone.

To subscribe to HondaLink® Assist, or to get more information about all of its features, contact a Honda dealer, or visit hondalink.honda.com

▶▶ In Case of Emergency

Your vehicle may not be able to connect to the operator if the battery level is low, the line is disconnected, or you do not have adequate cellular coverage.

You cannot use this emergency services when:

- You travel outside the HondaLink® service coverage areas.
- There is a problem with the connecting devices, such as the microphones, speakers, or the unit itself.
- **HondaLink Assist** is not enabled.
▶▶ **To enable notification** P. 399

You cannot operate other phone-related functions using the screen while talking to the operator. Only the operator can terminate the connection to your vehicle.

▶▶ Automatic collision notification

If the unit fails to connect to the operator, it repeatedly tries until it succeeds.

■ To enable notification

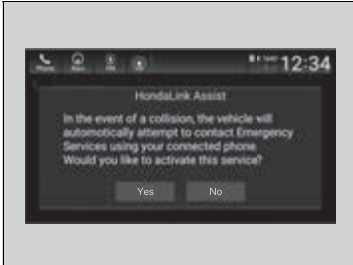

1. Go to the phone settings screen.
▶ **Phone settings screen** P. 377
2. Select **HondaLink Assist**.
3. Select **Yes** or **No**.

☒ To enable notification

Setting options:

- **Yes:** Notification is available.
- **No:** Disable the feature.

Refuel Recommend

Models with navigation system

Your vehicle is equipped with a feature that automatically calculates when to refuel. This feature will notify you when refueling is recommended as well as enable you to search for gas stations that are located in the vicinity of your vehicle.



1. When it is time to refuel the vehicle, a notification is displayed and a notification icon is displayed in the header.
2. Touch the box that contains the icon.

3. Select **Find Gas Station Now**.

4. Choose a gas station from the search screen of the navigation system.
 - ▶ For instructions on how to use the navigation system, refer to the navigation system manual.

Refuel Recommend

You can turn the **Refuel recommend** function on and off.

▶ **Customized Features** P. 351

When you turn off this feature, the refuel recommend notification will not display.

This feature can only be used when the gas tank fuel level is below 30 percent.

If you select **Find Gas Station Now** or put more than 5 liters of gasoline into the gas tank, the notification for refueling will disappear. If you prefer not to be notified, select OFF in the settings for **Refuel recommend**.

When you drive on a rough road or ascend or descend a hill for an extended period of time, the notification may disappear or may not be displayed at all.

Driving

This chapter discusses driving and refueling.



Before Driving	402
Towing a Trailer	407
When Driving	
Starting the Engine	412
Precautions While Driving.....	418
Transmission	419
Shifting	420, 427, 429
SPORT Mode*	433
ECON Mode	434
Auto Idle Stop*	435
Adaptive Damper System*	440
Vehicle Stability Assist™ (VSA®), aka Electronic Stability Control (ESC), System.....	441
Agile Handling Assist.....	443

Tire Pressure Monitoring System (TPMS)	444
Tire Pressure Monitoring System (TPMS) - Required Federal Explanation	448
Blind spot information System*	450
Honda Sensing®	453
Collision Mitigation Braking System™ (CMBS™)	456
Low Speed Braking Control*	465
Adaptive Cruise Control (ACC) with Low Speed Follow	470
Lane Keeping Assist System (LKAS)....	486
Road Departure Mitigation (RDM) System	494
Traffic Sign Recognition System	498

Front Sensor Camera	504
Radar Sensor	506
Sonar Sensors*	507
Braking	
Brake System	508
Anti-lock Brake System (ABS)	516
Brake Assist System	517
Parking Your Vehicle	518
Multi-View Rear Camera	529
Refueling	531
Fuel Economy and CO₂ Emissions	534
Turbo Engine Vehicle	535

* Not available on all models

Driving Preparation

Check the following items before you start driving.

Exterior Checks

- Make sure there are no obstructions on the windows, door mirrors, exterior lights, or other parts of the vehicle.
 - ▶ Remove any frost, snow, or ice.
 - ▶ Remove any snow on the roof, as this can slip down and obstruct your field of vision while driving. If frozen solid, remove ice once it has softened.
 - ▶ When removing ice from around the wheels, be sure not to damage the wheel or wheel components.
- Make sure the hood is securely closed.
 - ▶ If the hood opens while driving, your front view will be blocked.
- Make sure the tires are in good condition.
 - ▶ Check air pressure, and check for damage and excessive wear.
 - ▶ **Checking and Maintaining Tires** P. 575
- Make sure there are no people or objects behind or around the vehicle.
 - ▶ There are blind spots from the inside.

Exterior Checks

NOTICE

When doors are frozen shut, use warm water around the door edges to melt any ice. Do not try to force them open, as this can damage the rubber trim around the doors. When done, wipe dry to avoid further freezing.

Do not pour warm water into the key cylinder. You will be unable to insert the key if the water freezes in the hole.

Heat from the engine and exhaust can ignite flammable materials left under the hood, causing a fire. If you've parked your vehicle for an extended period, inspect and remove any debris that may have collected, such as dried grass and leaves that have fallen or have been carried in for use as a nest by a small animal. Also, check under the hood for leftover flammable materials after you or someone else has performed maintenance on your vehicle.

Interior Checks

- Store or secure all items on board properly.
 - ▶ Carrying too much cargo, or improperly storing it, can affect your vehicle's handling, stability, stopping distance, and tires, and make it unsafe.
 - ✦ **Maximum Load Limit** P. 405
- Do not pile items higher than the seat height.
 - ▶ They can block your view and may be thrown forward in the event of sudden braking.
- Do not place anything in the front seat footwells. Make sure to secure the floor mat.
 - ▶ An object or unsecured floor mat can interfere with your brake and accelerator pedal operation while driving.
- If you have any animals on board, do not let them move around in the vehicle.
 - ▶ They may interfere with driving and a crash could occur.
- Securely close and lock all doors and the trunk.
 - ✦ **Locking/Unlocking the Doors from the Inside** P. 177
- Adjust your seating position properly.
 - ▶ Adjust the head restraint, too.
 - ✦ **Seats** P. 212
 - ✦ **Adjusting the Front and Rear Outer* Head Restraint Positions** P. 219
- Adjust the mirrors and steering wheel properly.
 - ▶ Adjust them while sitting in the proper driving position.
 - ✦ **Mirrors** P. 210
 - ✦ **Adjusting the Steering Wheel** P. 209

Interior Checks

The headlight aim is set by the factory, and does not need to be adjusted. However, if you regularly carry heavy items in the trunk or tow a trailer*, have the aiming readjusted at a dealer or by a qualified technician.

* Not available on all models

- Be sure items placed on the floor behind the front seats cannot roll under the seats.
 - ▶ They can interfere with the driver's ability to operate the pedals, or the operation of the seats, or the operation of the sensors under the seats.
- Everyone in the vehicle must fasten their seat belt.
 - ▶ **Fastening a Seat Belt** P. 42
- Make sure that the indicators in the instrument panel come on when you start the vehicle, and go off soon after.
 - ▶ Always have a dealer check the vehicle if a problem is indicated.
 - ▶ **Indicators** P. 82

Maximum Load Limit

The maximum load for your vehicle is 850 lbs (385 kg). See the Tire and Loading Information label attached to the driver's doorjamb.

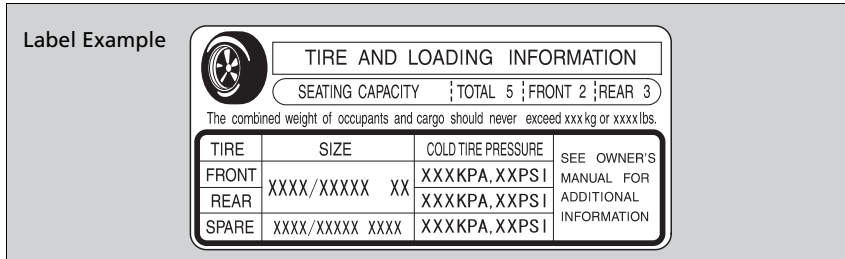

This figure includes the total weight of all occupants, cargo, and accessories, and the tongue load if you are towing a trailer*.

Steps for Determining Correct Load Limit -

- (1)** Locate the statement "The combined weight of occupants and cargo should never exceed XXX kg or XXX lbs." on your vehicle's placard.
- (2)** Determine the combined weight of the driver and passengers that will be riding in your vehicle.
- (3)** Subtract the combined weight of the driver and passengers from XXX kg or XXX lbs.
- (4)** The resulting figure equals the available amount of cargo and luggage load capacity. For example, if the "XXX" amount equals 1,400 lbs. and there will be five 150 lb. passengers in your vehicle, the amount of available cargo and luggage load capacity is 650 lbs. (1,400 - 750 (5 x 150) = 650 lbs.)

* Not available on all models

Continued

Maximum Load Limit

⚠ WARNING

Overloading or improper loading can affect handling and stability and cause a crash in which you can be hurt or killed.

Follow all load limits and other loading guidelines in this manual.

Gross Vehicle Weight Rating (GVWR):

The maximum allowable weight of the vehicle, all occupants, all accessories, all cargo, and the tongue load*.

📖 **Specifications** P. 632, 634

Gross Axle Weight Rating (GAWR):

The maximum allowable weight of the vehicle axle.

📖 **Specifications** P. 632, 634

- (5) Determine the combined weight of luggage and cargo being loaded on the vehicle. That weight may not safely exceed the available cargo and luggage load capacity calculated in step 4.
- (6) If your vehicle will be towing a trailer, load from your trailer will be transferred to your vehicle. Consult this manual to determine how this reduces the available cargo and luggage load capacity of your vehicle.

In addition, the total weight of the vehicle, all occupants, accessories, cargo, and trailer tongue load must not exceed the Gross Vehicle Weight Rating (GVWR) or the Gross Axle Weight Rating (GAWR). Both are on a label on the driver's doorjamb.

▶▶ Maximum Load Limit

Towing a Trailer:

See Towing a Trailer to determine whether your vehicle is designed to tow a trailer.

▶▶ **Towing a Trailer** P. 407

Load Limits Example

Example1



Max Load
850 lbs
(385 kg)



Passenger Weight
150 lbs x 2 = 300 lbs
(68 kg x 2 = 136 kg)



Cargo Weight
550 lbs
(249 kg)

Example2



Max Load
850 lbs
(385 kg)



Passenger Weight
150 lbs x 5 = 750 lbs
(68 kg x 5 = 340 kg)



Cargo Weight
100 lbs
(45 kg)

Towing a Trailer

1.5 L engine models

Your vehicle is not designed to tow a trailer. Attempting to do so can void your warranties.

2.0 L engine models

Towing Preparation

Towing Load Limits

Your vehicle can tow a trailer if you carefully observe the load limits, use the proper equipment, and follow the towing guidelines. Check the load limits before driving.

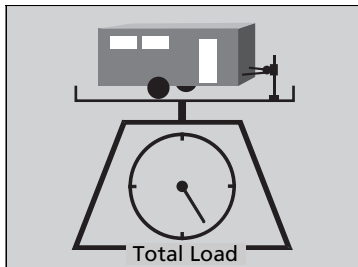

■ Total trailer weight

Maximum allowable weight of the trailer, cargo, and everything in or on it must not exceed 1,000 lbs (450 kg). Towing loads in excess of this can seriously affect vehicle handling and performance and can damage the engine and drivetrain.

⊠ Towing Load Limits

⚠ WARNING

Exceeding any load limit or improperly loading your vehicle and trailer can cause a crash in which you can be seriously hurt or killed.

Check the loading of your vehicle and trailer carefully before starting to drive.

Check if all loads are within limits at a public scale. If a public scale is not available, add the estimated weight of your cargo load to the weight of your trailer (as quoted by the manufacturer), and the tongue load.

Break-in Period.

Avoid towing a trailer during your vehicle's first 600 miles (1,000 km).

Never exceed the gross weight ratings.

Gross weight information

⊠ **Vehicle Specifications** P. 634

Continued

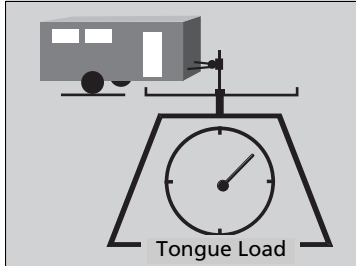

■ Tongue load

The weight of the tongue with a fully loaded trailer on the hitch should be approximately 10% of the total trailer weight.

- Excessive tongue load reduces front tire traction and steering control. Too little tongue load can make the trailer unstable and cause it to sway.
- To achieve a proper tongue load, start by loading 60% of the load toward the front of the trailer and 40% toward the rear. Readjust the load as needed.

■ Towing Equipment and Accessories

Towing equipment varies by the size of your trailer, how much load you are towing, and where you are towing.

■ Hitches

The hitch must be of an approved type and properly bolted to the underbody.

■ Safety chains

Always use safety chains when you tow a trailer. Leave enough slack to allow the trailer to turn corners easily, but do not allow the chains to drag on the ground.

■ Trailer brakes

There are two common types of trailer brakes: surge and electric. Surge brakes are common for boat trailers, since the brakes will get wet. If you choose electric brakes, be sure they are electronically actuated. Do not attempt to attach trailer brakes to your vehicle's hydraulic system, as it will lower braking effectiveness and create a potential hazard.

■ Additional towing equipment

Many states and provinces/territories require special outside mirrors when towing a trailer. Even if mirrors are not required in your locale, you should install special mirrors if visibility is restricted in any way.

■ Trailer light

Trailer lights and equipment must comply with federal, state, province/territory, and local regulations. Check with your local trailer sales or rental agency for the requirements in the area where you plan to tow.

☒ Towing Equipment and Accessories

Make sure that all equipment is properly installed and maintained, and that it meets federal, state, province/territory, and local regulations.

Consult your trailer maker for proper installation and setup of the equipment. Improper installation and setup can affect the handling, stability, and braking performance of your vehicle.

Consult your trailer sales or rental agency if any other items are recommended or required for your towing situation.

The lighting and wiring of trailers can vary by type and brand. If a connector is required, it should only be installed by a qualified technician.

2.0 L engine models

Driving Safely with a Trailer

■ Things You Need To Know Before Towing a Trailer

- Have the trailer properly serviced and keep it in good condition.
- Make sure that all the weights and load in the vehicle and trailer are within limits.
 - ❏ **Towing Load Limits** P. 407
- Securely attach the hitch, safety chains, and other necessary parts to the trailer.
- Securely store all the items in and on the trailer so that they do not shift while driving.
- Check if the lights and brakes on the trailer are working properly.
- Check the pressure of the trailer tires, including the spare.

■ Models with Low Speed Braking Control

- Turn off the Low Speed Braking Control system. It may activate if it detects the vehicle being towed as an obstacle.
 - ❏ **System On and Off** P. 467
- Turn off the rear parking sensor system.
 - ❏ **Turning off All Rear Sensors** P. 524

■ Towing Speeds and Gears

- Drive slower than normal.
- Obey posted speed limits for vehicles with trailers.
- Use the  position when towing a trailer on level roads.

■ Turning and Braking

- Turn more slowly and with a wider turning arc than normal.
- Allow more time and distance for braking.
- Do not brake or turn suddenly.

►► Driving Safely with a Trailer

Operating speed when towing a trailer must not exceed 62 mph (100 km/h).

Parking

In addition to the normal precautions, place wheel chocks at each of the trailer's tires.

►► Towing Speeds and Gears

When towing a fixed-sided trailer (e.g., camper), do not exceed 55 mph (88 km/h). At higher speeds, the trailer may sway or affect vehicle handling.

■ Driving in Hilly Terrain

- Monitor your temperature gauge. If it nears the red (Hot) mark, turn off the climate control system and reduce speed. Pull to the side of the road safely to cool down the engine if necessary.

Towing Behind a Motorhome

Your vehicle is not designed to be towed behind a motorhome. If your vehicle needs to be towed in an emergency, refer to the emergency towing information.

📄 **Emergency Towing** P. 626

Starting the Engine

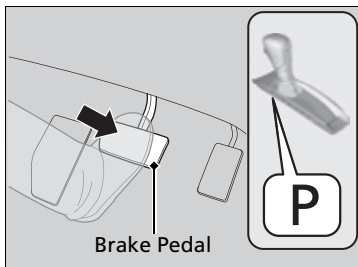
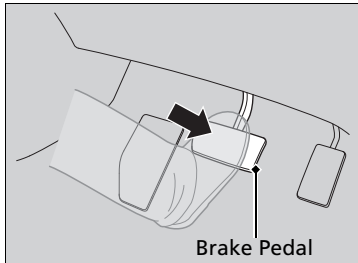

1. Make sure the parking brake is applied.
 - ▶ The parking brake and brake system indicator (red) comes on for 30 seconds when you pull up the electric parking brake switch.

Automatic transmission models

2. Depress the brake pedal.

Continuously variable transmission models

2. Check that the transmission is in **P**, then depress the brake pedal.
 - ▶ Although it is possible to start the vehicle in **N**, it is safer to start it in **P**.

Starting the Engine

Keep your foot firmly on the brake pedal when starting the engine.

The engine is harder to start in cold weather and in thinner air found at altitudes above 8,000 feet (2,400 meters).

When starting the engine in cold weather, turn off all electrical accessories such as the lights, climate control system and rear defogger in order to reduce battery drain.

If you live in a region where winter is extremely cold, an engine block heater will improve starting and warming of the engine. Consult a dealer for details.

If the exhaust system sounds abnormal or you can smell exhaust gas inside the vehicle, have your vehicle checked by a dealer. There may be a problem with the engine or exhaust system.

The immobilizer system protects your vehicle from theft.

If an improperly coded device is used, the engine's fuel system is disabled.

▶ **Immobilizer System** P. 184

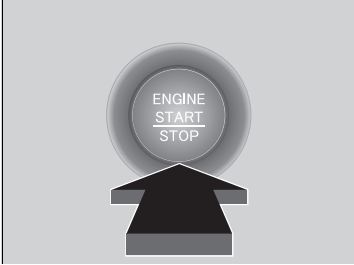

All models

3. Press the **ENGINE START/STOP** button without depressing the accelerator pedal.

▶▶ Starting the Engine

Bring the keyless remote close to the **ENGINE START/STOP** button if the battery in the keyless remote is weak.

▶ **If the Keyless Remote Battery is Weak**
P. 604

The engine may not start if the keyless remote is subjected to strong radio waves.

Do not hold the **ENGINE START/STOP** button to start the engine.

If the engine does not start, wait at least 30 seconds before starting the engine again.



■ Remote Engine Start*

You can remotely start the engine using the keyless remote.

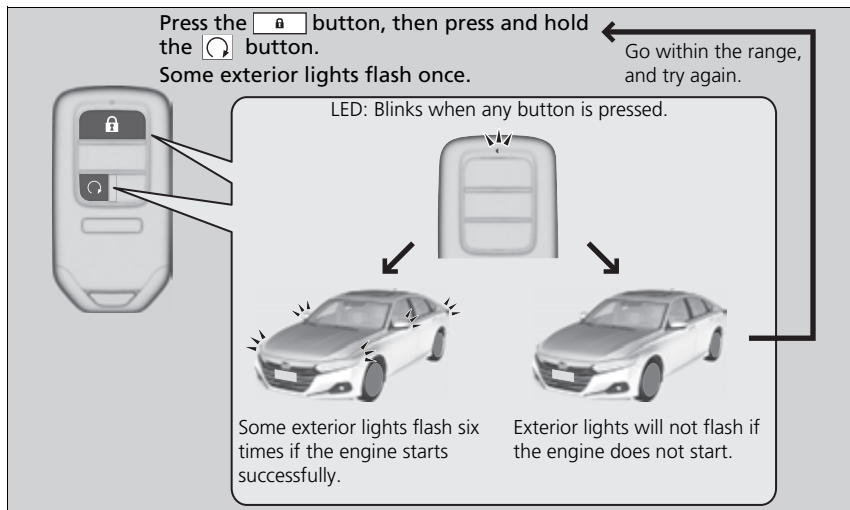
■ To start the engine



When started remotely, the engine automatically shuts off after 10 minutes of idling and/or the brake pedal and **ENGINE START/STOP** button have not been pressed simultaneously.

To extend the run time for another 10 minutes during the first run, press the  button, then press and hold the  button.

- ▶ Some exterior lights flash six times if a 10-minute extension request was transmitted successfully.

⚠ Remote Engine Start*

⚠ WARNING

Carbon monoxide gas is toxic and can rapidly accumulate in closed or even partly enclosed areas.

Breathing it can cause unconsciousness and even kill you.

Never use the remote engine starter with the vehicle parked in a garage or other areas with limited ventilation.

The remote engine start may violate local laws. Before using the remote engine start, check your local laws.

If there are buildings and obstacles between your vehicle and the keyless remote, the range will be reduced. This distance may vary by external electrical interference.

■ To stop the engine

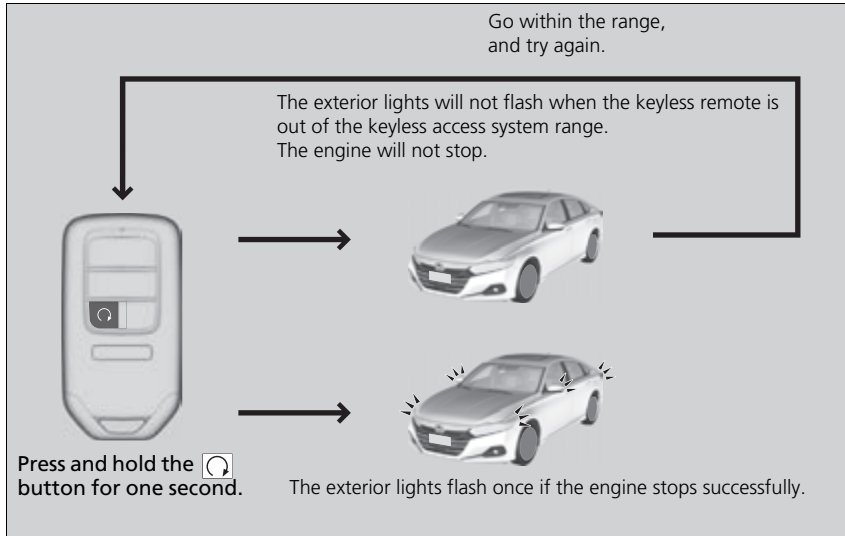

⊞ Remote Engine Start*

The engine may not start by the remote engine start if:

- You have disabled a remote engine start setting using the audio/information screen.
 - **Customized Features** P. 351
- The power mode is not in VEHICLE OFF.
- The transmission is in a position other than **P**.
- The hood is open, or any door or the trunk is unlocked.
- You have already used the keyless remote twice to start the engine.
- The battery charge is too low.
- Another registered keyless remote is in the vehicle.
- There is any antenna failure.
- The door is unlocked with the built-in key.
- The engine oil pressure is low.
- The engine coolant temperature is extremely high.
- The telematics unit* malfunctions.
- The security system alarm is not set.

* Not available on all models

▶▶ Remote Engine Start*

The engine may stop while it is running if:

- You do not start the vehicle within 10 minutes of starting the engine with the keyless remote.
- The engine is stopped by using the keyless remote.
- The security system alarm is activated.
- The door is unlocked with the built-in key.
- The hood is open.
- The engine coolant temperature is extremely high.
- The battery is low.
- The engine oil pressure is low.
- The malfunction indicator lamp comes on if there is a problem with the emissions control systems.
- You press the **ENGINE START/STOP** button without depressing the brake pedal.

Automatic transmission models

- The transmission is in a position other than **P**.

Continuously variable transmission models

- You press the shift lever release button.

While the engine is running, the vehicle will automatically precondition inside the vehicle.

When it is warm outside:

- The climate control system is activated in auto mode.

When it is cold outside:

- The defroster is activated at a moderately warm temperature.
- The rear defogger and door mirror heaters are activated.
- The seat heaters* and heated steering wheel* are activated.

▶▶ **Heated Steering Wheel*** P. 236

▶▶ **Front Seat Heaters*** P. 237

▶▶ **Front Seat Heaters and Seat Ventilation***
P. 238

Starting to Drive

When the engine was started using the  button on the keyless remote

1. Depress and hold the brake pedal, then press the **ENGINE START/STOP** button.

When the engine was started in any case

- Keeping your right foot on the brake pedal, put the transmission into **[D]**. Select **[R]** when reversing.
- With the parking brake applied, release the brake pedal and gently depress the accelerator pedal.
 - ▶ Make sure the parking brake and brake system indicator (red) goes off.
 - **Parking Brake** P. 508

Hill start assist system

Hill start assist keeps the brake engaged briefly to help prevent the vehicle from rolling on inclines as you move your foot from the brake pedal to the accelerator.

Put the transmission into **[D]**, **[S]*** or **[L]*** when facing uphill, or **[R]** when facing downhill, then release the brake pedal.

Stopping the Engine

You can turn the engine off when the vehicle is completely stopped.

- Put the transmission into **[P]**.
- Press the **ENGINE START/STOP** button.

* Not available on all models

Starting to Drive

When the engine was started using the  button on the keyless remote

The engine stops when the transmission is taken out of **[P]** before the **ENGINE START/STOP** button is pressed. Follow the step 1 when starting to drive.

You can also release the parking brake by pressing the electric parking brake switch while depressing the brake pedal.

When facing downhill, you can start your vehicle more smoothly by manually releasing it with the electric parking brake switch than by releasing it with the accelerator pedal.

Hill start assist system

Hill start assist may not prevent the vehicle from rolling downhill on a very steep or slippery slope, and will not operate on small inclines.

Hill start assist is not a replacement for the parking brake.

Hill start assist will operate even when VSA® is switched off.

Precautions While Driving

■ In Rain

Avoid driving in deep water and on flooded roads. This can damage the engine or driveline, or cause electrical component failure.

■ Other Precautions

If there is a strong impact with something under the vehicle, stop in a safe location. Check the underside of the vehicle for damage or any fluid leaks.

▶▶ Precautions While Driving

NOTICE

Do not change the transmission while pressing the accelerator pedal. You could damage the transmission.

NOTICE

If you repeatedly turn the steering wheel at an extremely low speed, or hold the steering wheel in the full left or right position for a while, the electric power steering (EPS) system heats up. The system goes into a protective mode, and limits its performance. The steering wheel becomes harder and harder to operate. Once the system cools down, the EPS system is restored.

Repeated operation under these conditions can eventually damage the system.

If the power mode is set to ACCESSORY while driving, the engine will shut down and all steering and brake power assist functions will stop, making it difficult to control the vehicle.

Do not select **[N]** while driving as you will lose engine braking (and acceleration) performance.

During the first 600 miles (1,000 km) of operation, avoid sudden acceleration or full throttle operation so as not to damage the engine or powertrain.

Avoid hard braking for the first 200 miles (300 km) after purchasing your new vehicle or replacing the brake pads or rotors, to allow for proper break-in.

Transmission

■ Creeping

When the engine runs at higher idle speeds, the creeping force increases. Keep the brake pedal firmly depressed when stopped.

■ Kickdown

Quickly depressing the accelerator pedal while driving uphill may cause the transmission to drop to a lower gear/ratio, unexpectedly increasing vehicle speed. Depress the accelerator pedal carefully, especially on slippery roads and curves.

Automatic transmission models

Shifting

Change the shift position in accordance with your driving needs.

■ Shift button positions



P	Park Used when parking or starting the engine Transmission is locked
R	Reverse Used when reversing
N	Neutral Transmission is not locked
D	Drive Used for: <ul style="list-style-type: none"> • Normal driving (gears change between 1st and 10th automatically) • Temporarily driving in the sequential mode • Driving in the sequential mode (when driving in SPORT mode)

■ **P** (parking) button

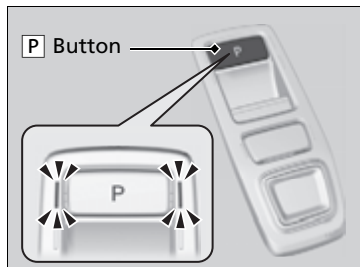

Park your vehicle in a safe place with the power mode in ON, then apply the brakes and press the **P** button to put the transmission in Park.

The indicators on the sides of the **P** button come on.

▶▶ Shifting

⚠ WARNING

The vehicle can roll away if left unattended without confirming that Park is engaged.

A vehicle that rolls away could cause a crash resulting in serious injury or death.

Always keep your foot on the brake pedal until you have confirmed that **P** is shown on the shift position indicator.

To prevent malfunction and unintended engagement:

- Do not spill any liquids on or around shift buttons.
- Do not place or drop any objects on or around shift buttons.
- Do not let passengers or children operate the shift buttons.

The beeper sounds and the message appears on the driver information interface when you depress the accelerator pedal with the transmission in **N**.

▶▶ **Driver Information Interface Warning and Information Messages** P. 109

Put the transmission into **D** or **R** with the brake pedal depressed.

When shifting gears in extremely low temperatures (–22°F/–30°C), there may be a short delay before the shift position is indicated in the display. Always confirm you are in the correct gear before driving.

Shift Operation

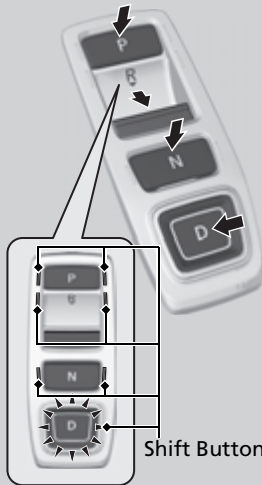
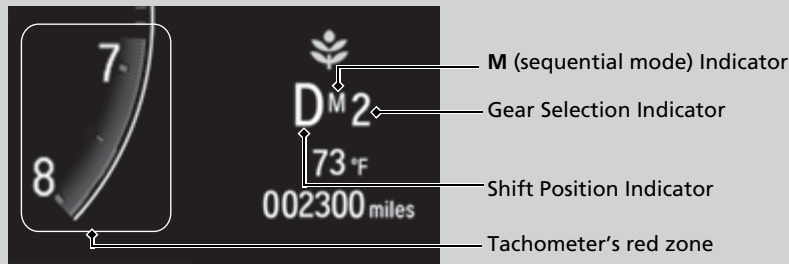

P Press the **P** button.

R Pull back the **R** button.

N Press the **N** button.

D Press the **D** button.

Shift Button Indicator

Shift Operation

NOTICE

When you change **D** to **R** and vice versa, depress the brake pedal to come to a complete stop, then select the intended shift position while maintaining brake pressure.

Use the shift position indicator and the shift button indicator to check the shift position before selecting a shift button.

If the indicator of the currently selected shift position, or all the shift position indicators are blinking simultaneously, there is a problem with the transmission.

Avoid sudden acceleration and have the transmission checked by a dealer as soon as possible.

The fuel supply may be cut off if you drive at engine speeds in or over the tachometer's red zone (engine speed limit). If this happens, you may experience a slight jolt.

When the engine speed is increased while the transmission is in **N**, **P** or **R**, the fuel supply may be cut off even without the engine speed entering the tachometer's red zone.

The beeper sounds once when you change to **R**.

▶ **Customized Features** P. 351

Continued

■ When opening the driver's door

If you open the driver's door under the following conditions, the transmission automatically puts into **P**;

- The vehicle is stationary with the engine running, or moving at 1 mph (2 km/h) or slower.
- The transmission is in other than **P**.
- You have unfastened the driver side seat belt.
 - ▶ If you manually put the transmission from **P** with the brake pedal depressed, the transmission will automatically return to **P** once you release the brake pedal.

■ When turning off the power mode

If you turn the engine off while the vehicle is stationary, and the transmission is in other than **P**, the transmission automatically puts into **P**.

ⓘ When opening the driver's door

While the system is designed to automatically put the transmission into **P** under the described conditions, in the interest of safety you should always select **P** before opening the driver's door.

Make sure to park the vehicle in a safe place.

📖 **When Stopped** P. 518

If you want to drive the vehicle after the transmission has automatically put into **P** under the described conditions, close the door, fasten the seat belt, depress the brake pedal, then change the shift position.

If you leave the vehicle, turn off the engine and lock the doors.

■ If you want to keep the transmission in **[N]** position [car wash mode]

With the engine running:

1. Press and hold the brake pedal.
2. Select **[N]**, then release the button to display **[N]** (Neutral) hold mode on the driver information interface.
3. Press and hold **[N]** again for two seconds.
 - ▶ This puts the vehicle in car wash mode which must be used when your vehicle is pulled through a conveyor type automatic car wash where you or an attendant do not remain in the vehicle.

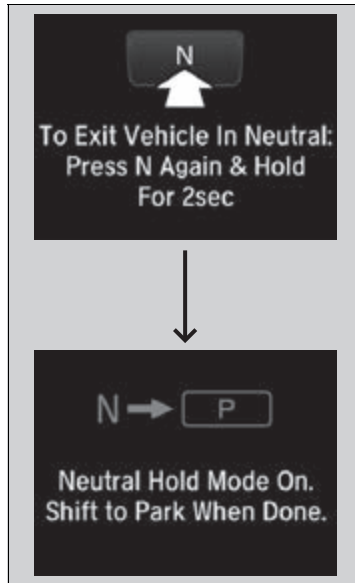

If the **ENGINE STOP/START** button is pressed after car wash mode has been activated, the power mode will change to ACCESSORY and a message will be displayed on the driver information interface.

- ▶ For 15 minutes the transmission remains in **[N]** with the power mode in ACCESSORY. After that, the transmission automatically changes to **[P]** and the power mode changes to OFF.
- ▶ Manually changing to **[P]** cancels ACCESSORY mode. The **[P]** indicator comes on and the power mode changes to OFF. You must always put the transmission into **[P]** when car wash mode is no longer needed.

ⓘ If you want to keep the transmission in **[N]** position [car wash mode]

Note that the transmission may not stay in **[N]** position while any of the following indicators is on:

- Transmission system indicator.
- Malfunction indicator lamp.
- Charging system indicator.

■ Restrictions on selecting a shift position

You cannot select a shift position under certain circumstances that may lead to a crash.

When the transmission is in:	1. Under these circumstances:	2. If you try to change to the following:	3. The shift position remains in/changes to:	How to change the shift position
P	The brake pedal is not depressed.	Other shift position	P	Release the accelerator pedal and depress the brake pedal.
	The accelerator pedal is depressed.			
N	The vehicle is moving at low speed without the brake pedal depressed.		N	
	The vehicle is moving at low speed with the accelerator pedal depressed.			
N or D	The vehicle is moving forward.	R	N	Stop your vehicle in a safe place, depress the brake pedal, and select the appropriate shift position.
R or N	The vehicle is moving backward.	D		
R , N or D	The vehicle is moving.	P		

■ Sequential Mode

Use the paddle shifters to change between 1st and 10th gears without removing your hands from the steering wheel. The transmission will switch to the sequential mode.

■ When the transmission is in **[D]**:

The vehicle will go into the sequential mode momentarily, and the gear selection indicator will come on.

When the vehicle goes into the sequential mode by **[−]** paddle shifter and the lower gear is available, the transmission properly selects single or double gear change.

Once you start traveling at a constant speed, the sequential mode will automatically switch off, and the gear selection indicator will go off.

Hold the **[+]** paddle shifter for two seconds to return to normal drive.

■ When the transmission is in **[D]** with **SPORT** mode:

The vehicle will go into the sequential mode, and the **M** (sequential mode) indicator and gear selection indicator will come on.

If the vehicle speed increases and the engine speed reaches near the tachometer's red zone, the transmission automatically shifts up to the next gear.

You can cancel this mode by holding the **[+]** paddle shifter for two seconds. When the sequential mode is canceled, the sequential mode indicator and gear selection indicator go off.

Sequential Mode Operation

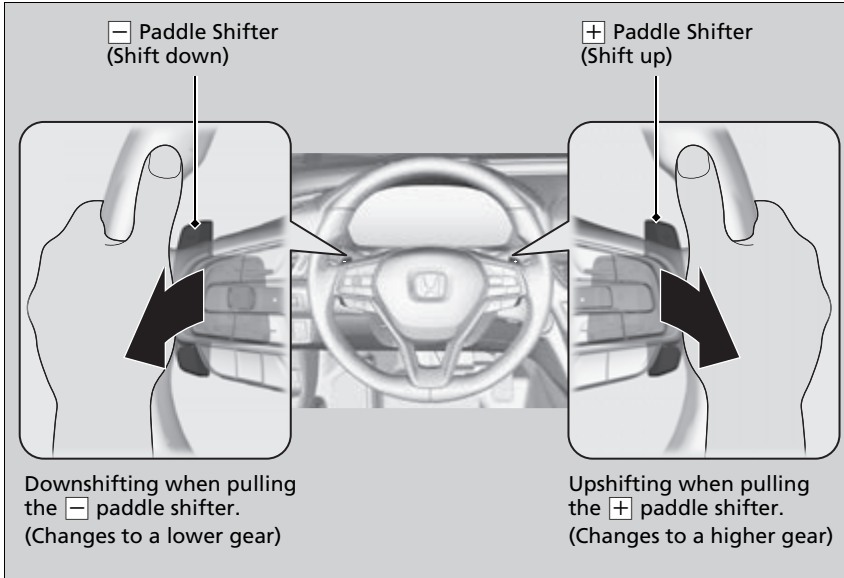

Sequential Mode Operation

Each paddle shift operation makes a single or double gear change.
To change gears continuously, release the paddle shifter before pulling it again for the next gear.

If the gear selection indicator blinks when you try to shift up or down, this means your vehicle speed is not in its allowable gear range or the protection of transmission system is necessary.
Slightly accelerate to shift up and decelerate to shift down while the indicator is blinking.

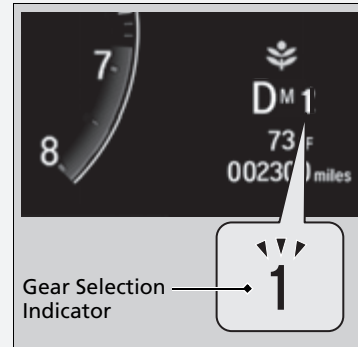

Continuously variable transmission models without paddle shifters

Shifting

Change the shift position in accordance with your driving needs.

■ Shift lever positions

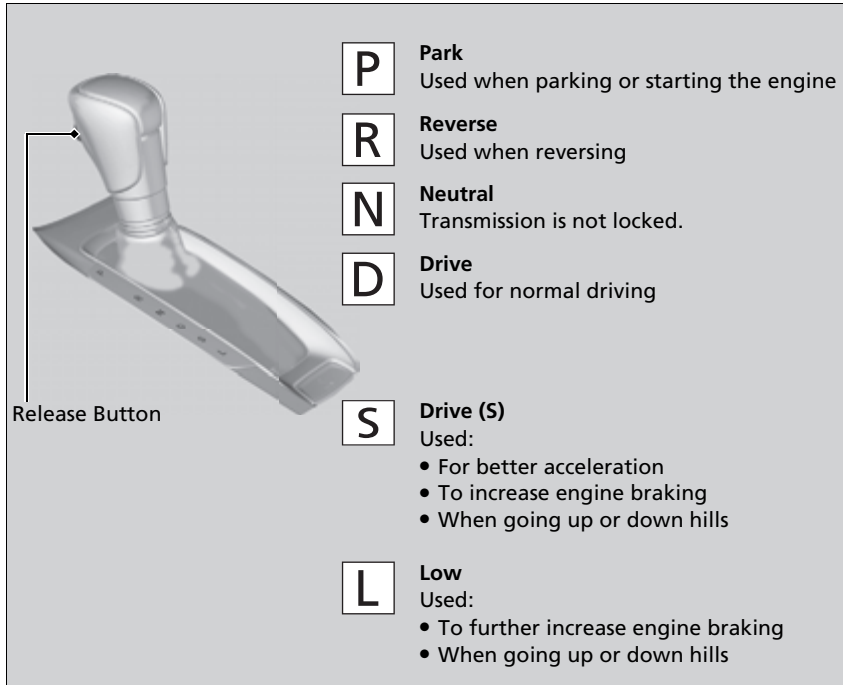

▶ Shifting

You cannot change the power mode from ON to VEHICLE OFF unless the shift position is in **P**.

The vehicle may move very slightly even in **N** while the engine is cold.

Depress the brake pedal firmly and, when necessary, apply the parking brake.

■ Shift Lever Operation

Shift Position Indicator (Transmission System Indicator)

Tachometer's red zone

Depress the brake pedal and press the shift lever release button to shift.

Shift without pressing the shift lever release button.

Press the shift lever release button and shift.

▶▶ Shift Lever Operation

NOTICE

When you change the shift position from **D** to **R** and vice versa, come to a complete stop and keep the brake pedal depressed. Operating the shift lever before the vehicle has come to a complete standstill can damage the transmission.

Use the shift position indicator to check the lever position before pulling away.

If the transmission system indicator blinks when driving, in any shift position, there is a problem with the transmission. Avoid sudden acceleration and have the transmission checked by a dealer as soon as possible.

The fuel supply may be cut off if you drive at engine speeds in or over the tachometer's red zone (engine speed limit). If this happens, you may experience a slight jolt.

It may not be possible to operate the shift lever if the brake pedal is applied while the shift lever release button is held down. Depress the brake pedal first.

When shifting positions in extremely low temperatures (-22°F/-30°C), there may be a short delay before the shift position is displayed. Always confirm you are in the correct shift position before driving.

Continuously variable transmission models with paddle shifters

Shifting

Change the shift position in accordance with your driving needs.

■ Shift lever positions

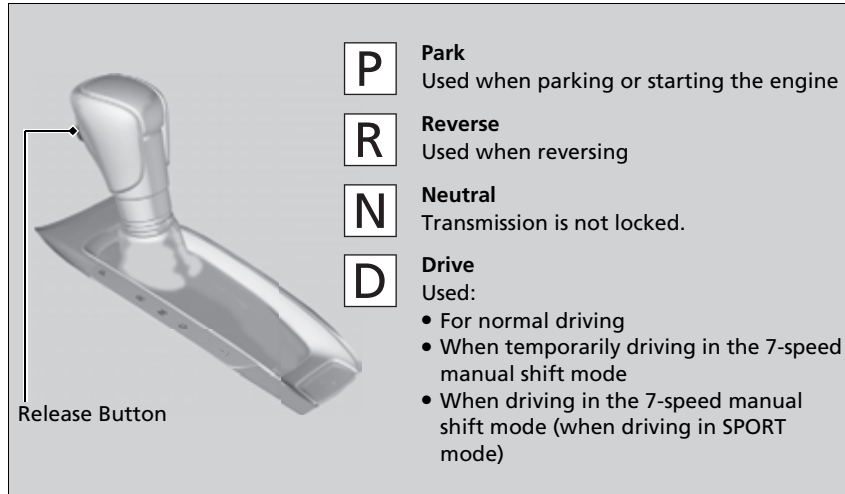

▶▶ Shifting

You cannot change the power mode from ON to VEHICLE OFF unless the shift position is in **P**.

The vehicle may move very slightly even in **N** while the engine is cold.

Depress the brake pedal firmly and, when necessary, apply the parking brake.

Shift Lever Operation

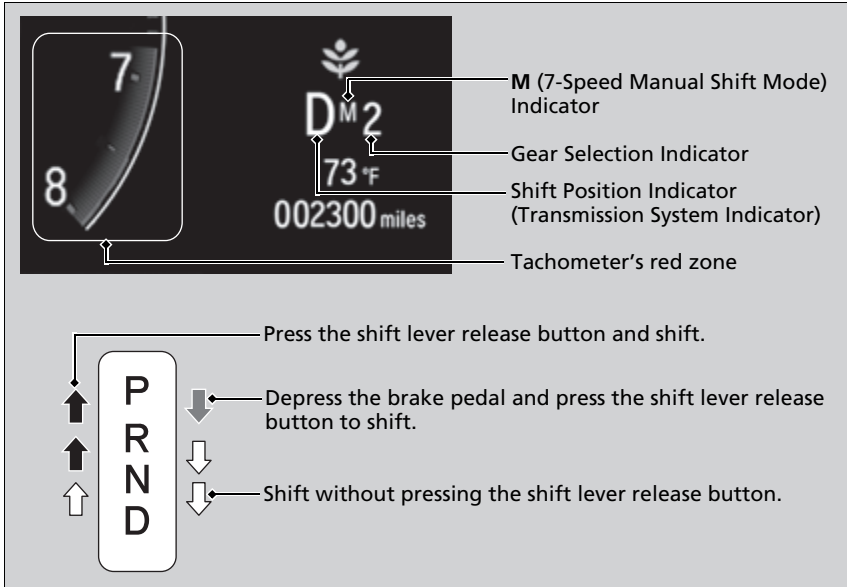

Shift Lever Operation

NOTICE

When you change the shift position from **D** to **R** and vice versa, come to a complete stop and keep the brake pedal depressed. Operating the shift lever before the vehicle has come to a complete standstill can damage the transmission.

Use the shift position indicator to check the lever position before pulling away.

If the transmission system indicator blinks when driving, in any shift position, there is a problem with the transmission. Avoid sudden acceleration and have the transmission checked by a dealer as soon as possible.

The fuel supply may be cut off if you drive at engine speeds in or over the tachometer's red zone (engine speed limit). If this happens, you may experience a slight jolt.

It may not be possible to operate the shift lever if the brake pedal is applied while the shift lever release button is held down. Depress the brake pedal first.

When shifting positions in extremely low temperatures (-22°F/-30°C), there may be a short delay before the shift position is displayed. Always confirm you are in the correct shift position before driving.

■ 7-Speed Manual Shift Mode

Use the paddle shifters to change between 1st and 7th speeds without releasing your hands from the steering wheel. The transmission switches to the 7-speed manual shift mode when you pull a paddle shifter while driving. This mode is useful when engine braking is needed.

■ When the transmission is in **D**:

The shift mode goes into the 7-speed manual shift mode temporarily, and the number is displayed in the gear selection indicator.

The 7-speed manual shift mode is canceled automatically if you drive at constant speed or accelerate, and the number in the gear selection indicator goes off.

You can cancel this mode by pulling the **+** paddle shifter for a few seconds.

The 7-speed manual shift mode is especially useful when reducing the vehicle speed temporarily before making a turn.

■ When the transmission is in **D** with **SPORT** mode:

The shift mode goes into the 7-speed manual shift mode. The **M** indicator and the speed number are displayed in the gear selection indicator. As the vehicle speed slows down, the transmission automatically shifts down accordingly. When the vehicle comes to a stop, it automatically shifts down into 1st.

If the vehicle speed increases and the engine speed reaches near the tachometer's red zone, the transmission automatically shifts up.

You can only pull away in 1st speed.

When canceling the 7-speed manual shift mode, pressing the **SPORT** button. When the 7-speed manual shift mode is canceled, the **M** indicator and gear selection indicator go off.

⊠ 7-Speed Manual Shift Mode

In the 7-speed manual shift mode, the transmission shifts up or down by operating either paddle shifter under the following conditions:

Shift Up: The engine speed reaches the lowest threshold of the higher speed position.

Shift Down: The engine speed reaches the highest threshold of the lower speed position.

When the engine speed reaches near the tachometer's red zone, the transmission shifts up automatically.

When the engine speed reaches the lowest threshold of the selected speed position, the transmission shifts down automatically.

Operating the paddle shifters on slippery surfaces may cause the tires to lock up. In this case, the 7-speed manual shift mode is canceled and goes back to the normal **D** driving mode.

7-Speed Manual Shift Mode Operation

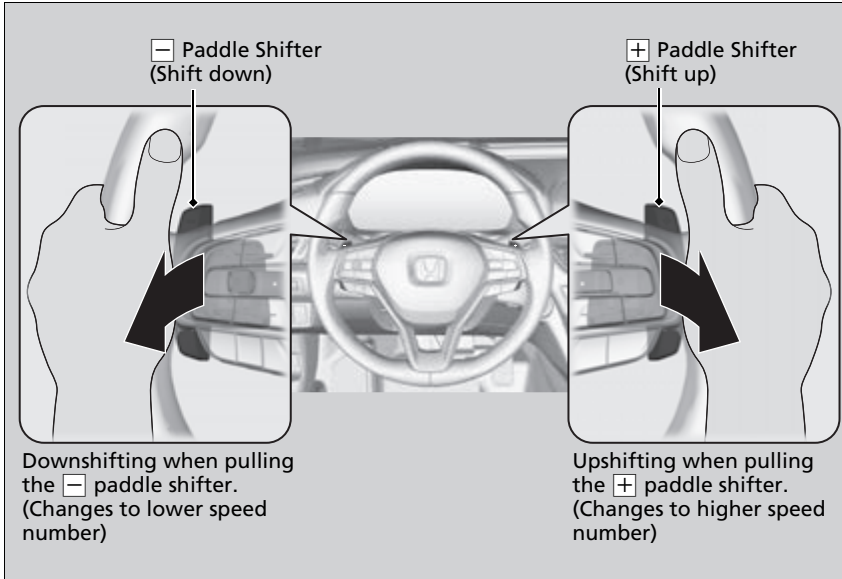

7-Speed Manual Shift Mode Operation

Each paddle shift operation makes a single speed change.

To change continuously, release the paddle shifter before pulling it again for the next speed.

The gear selection indicator blinks when you cannot shift up or down. It indicates that your vehicle speed is not in its allowable shifting range.

Slightly accelerate to shift up and decelerate to shift down while the indicator is blinking.

SPORT Mode*

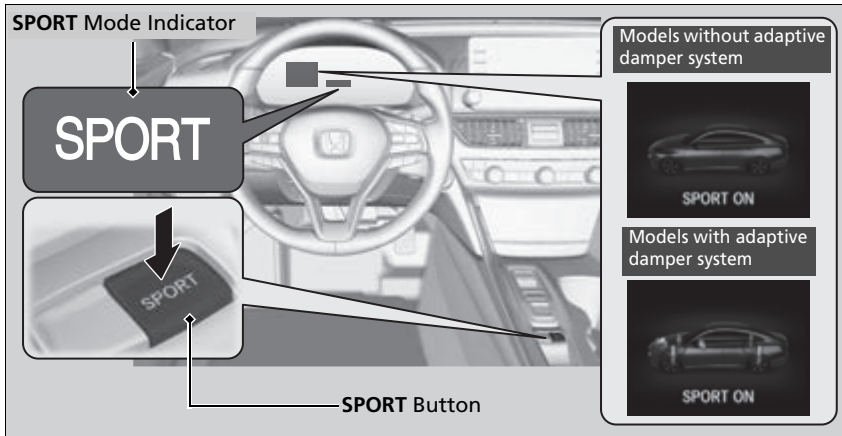

To turn the SPORT mode on and off, press the **SPORT** button.

The SPORT mode increases engine performance, transmission and handling*. This mode is suitable for driving on hills or through curves on mountain roads.

The SPORT mode is turned off every time you start the engine, even if you turned it on the last time you drove the vehicle.

The ambient meter color changes to a constant red and the turbo meter appears on the driver information interface.

* Not available on all models

ECON Mode

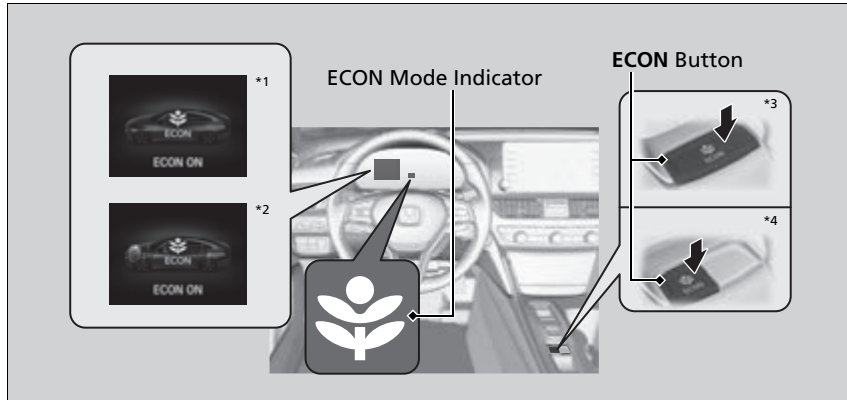

The **ECON** button turns the ECON mode on and off. The ECON mode helps you improve your fuel economy by adjusting the performance of the engine, transmission and climate control system.

▶▶ ECON Mode

While in ECON mode, the climate control system has greater temperature fluctuation.

*1 : Models without the adaptive damper system
*2 : Models with the adaptive damper system
*3 : Models without SPORT mode
*4 : Models with SPORT mode

Auto Idle Stop*

To help maximize fuel economy, the engine automatically stops when the vehicle comes to a stop, depending on environmental and vehicle operating conditions. The indicator (green) comes on at this time.

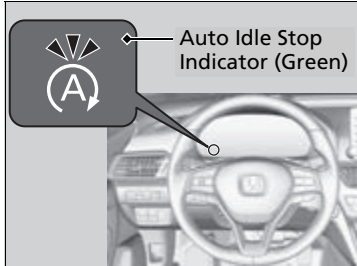

The environmental and vehicle conditions that impact Auto Idle Stop system operation are varied.

▶ **Auto Idle Stop Activates When:** P. 437

The engine then restarts once the vehicle is about to move again, and the indicator (green) goes off.

▶ **The Engine Automatically Restarts When:**
P. 439

If the driver's door is opened while the indicator (green) comes on, a buzzer sounds to notify you that the Auto Idle Stop function is in operation.

▶▶ Auto Idle Stop*

The 12-volt battery installed in this vehicle is specifically designed for a model with Auto Idle Stop. Using a 12-volt battery other than this specified type may shorten the 12-volt battery life, and prevent Auto Idle Stop from activating. If you need to replace the 12-volt battery, make sure to select the specified type. Ask a dealer for more details.

The duration of the Auto Idle Stop operation:

- Increase in the ECON mode, compared to when the ECON mode is off, with climate control in use.

▶ **ECON Mode** P. 434

■ Auto Idle Stop System ON/OFF



To turn the Auto Idle Stop system off, press this button. The Auto Idle Stop system stops.

- ▶ Auto Idle Stop system will stop and the indicator (amber) will come on.

The Auto Idle Stop system is turned on every time you start the engine, even if you turned it off the last time you drove the vehicle.

▶▶ Auto Idle Stop System ON/OFF

If you turn off the Auto Idle Stop system while it is activated, the engine will restart.

Auto Idle Stop Activates When:

The vehicle stops with the shift position in **[D]** and the brake pedal depressed. When you shift into **[P]** quickly with depressing the brake pedal, the Auto Idle Stop continues to operate, even if the brake pedal is released.

▶ If you move the shift lever slowly, the engine may automatically restart.

Auto Idle Stop does not activate when:

- The Auto Idle Stop **OFF** button is pressed.
- The driver's seat belt is not fastened.
- The engine is not adequately warmed up or coolant temperature is high.
- The engine is started with the hood open.
 - ▶ Turn off the engine. Close the hood before you restart the engine to activate Auto Idle Stop.
- The battery charge is low.
- The internal temperature of the battery is 41°F (5°C) or less.
- The transmission fluid temperature is low or high.
- The transmission is in a position other than **[D]**.
- The vehicle comes to a stop again before the vehicle speed reaches 3 mph (5 km/h) after the engine starts.
- The vehicle is stopped on a steep incline.
- **[FRONT AIR BAG]** is on (indicator on).
- The climate control system is in use, and the temperature is set to **Hi** or **Lo**.
- The climate control system is in use, and the outside temperature is below -4°F (-20°C) or over 104°F (40°C).

Models with SPORT mode

- The SPORT mode is on.

Auto Idle Stop Activates When:

Do not open the hood while the Auto Idle Stop function is activated. If the hood is opened, the engine will not restart automatically.

In this case, restart the engine with the **ENGINE START/STOP** button.

➤ **Starting the Engine** P. 412

When ACC with Low Speed Follow is in operation, the vehicle stops without depressing the brake pedal and Auto Idle Stop may activate. In such cases, the engine may restart if you change the shift position other than **[D]**.

Pressing the **ENGINE START/STOP** button causes the engine to no longer restarts automatically. Follow the standard procedure to start the engine.

➤ **Starting the Engine** P. 412

■ **Auto Idle Stop may not activate when:**

- The steering wheel is operated.
- Altitude is high.
- The vehicle is stopped by braking suddenly.
- The vehicle is repeatedly accelerated and decelerated at a low speed.
- The fan speed is high.
- The climate control system is in use, and there is a significant difference between the set temperature and the actual interior temperature.
- The climate control system is in use, and humidity in the interior is high.

■ The Engine Automatically Restarts When:

- The brake pedal is released (without the automatic brake hold system activated).
- The accelerator pedal is depressed (with the automatic brake hold system activated).
 **Automatic Brake Hold** P. 513

■ The engine restarts even if the brake pedal is depressed*1 when:

- The Auto Idle Stop **OFF** button is pressed.
- A steering wheel is operated.
- The transmission is put into **R**, **S***, and **L***, or when it is set from **N** to **D**.
 ▶ If you put the transmission into **P** after the Auto Idle Stop activates, the Auto Idle Stop continues to operate. In this case, the engine restarts when you move the shift lever other than **P**. When operating the shift lever, the brake pedal must be firmly depressed.
- The pressure on the brake pedal is reduced and the vehicle starts moving while stopped on an incline.
- The brake pedal is released slightly during a stop.
- The battery charge becomes low.
- The accelerator pedal is depressed.
- The driver's seat belt is unlatched.
-  is on (indicator on).
- The climate control system is in use, and the difference between the set temperature and actual interior temperature becomes significant.
- The climate control system is being used to dehumidify the interior.
- The vehicle ahead of you starts again when your vehicle stops automatically with ACC with Low Speed Follow.

Models with SPORT mode

- The SPORT mode is changed to on.

■ Starting Assist Brake Function

Briefly keeps the brake applied after releasing the brake pedal to restart the engine. This can keep your vehicle from unexpectedly moving while on an incline.

* Not available on all models

☒ The Engine Automatically Restarts When:

If you are using an electronic device during Auto Idle Stop, the device may temporarily be turned off when the engine restarts.

☒ The engine restarts even if the brake pedal is depressed*1 when:

*1: With the automatic brake hold system activated, you can release the brake pedal while Auto Idle Stop is in operation.

If the automatic brake hold system has been turned off, or if there is a problem with the system, the engine will restart automatically when you release the brake pedal.

 **Automatic Brake Hold** P. 513

Adaptive Damper System*

Constantly controls your vehicle's front and rear dampers according to current road conditions, vehicle speed and steering operation.

You can change handling response by turning the SPORT mode on.

➤ **SPORT Mode*** P. 433

Vehicle Stability Assist™ (VSA®), aka Electronic Stability Control (ESC), System

VSA® helps stabilize the vehicle during cornering if the vehicle turns more or less than what was intended. It also assists in maintaining traction on slippery surfaces. It does so by regulating engine output and selectively applying the brakes.

■ VSA® Operation

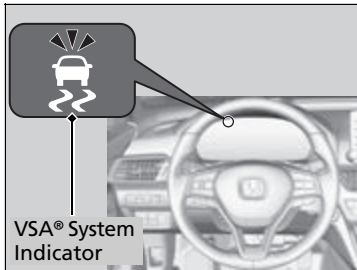

When VSA® activates, you may notice that the engine does not respond to the accelerator. You may also notice some noise from the hydraulic brake system. You will also see the indicator blink.

▣ Vehicle Stability Assist™ (VSA®), aka Electronic Stability Control (ESC), System

The VSA® may not function properly if tire type and size are mixed. Make sure to use the same size and type of tire, and the air pressures as specified.

When the VSA® system indicator comes on and stays on while driving, there may be a problem with the system. While this may not interfere with normal driving, have your vehicle checked by a dealer immediately.

VSA® cannot enhance stability in all driving situations and does not control the entire braking system. You still need to drive and corner at speeds appropriate for the conditions and always leave a sufficient margin of safety.

The main function of the VSA® system is generally known as Electronic Stability Control (ESC). The system also includes a traction control function.

The Vehicle Stability Assist™ (VSA®) system, Vehicle Stability Assist™ (VSA®) **OFF**, adaptive cruise control (ACC) with Low Speed Follow, safety support and low tire pressure/TPMS indicators may come on in amber along with a message in the driver information interface when you set the power mode to ON after reconnecting the battery.

Drive a short distance at more than 12 mph (20 km/h). Each indicator should go off. If any do not, have your vehicle checked by a dealer.

■ VSA® On and Off

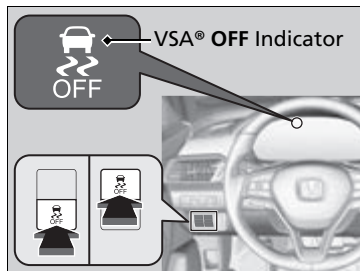

This button is on the driver side control panel. To partially disable VSA® functionality/features, press and hold it until you hear a beep.

Your vehicle will have normal braking and cornering ability, but traction control function will be less effective.

To restore VSA® functionality/features, press the  (VSA® **OFF**) button until you hear a beep.

VSA® is turned on every time you start the engine, even if you turned it off the last time you drove the vehicle.

▶▶ Vehicle Stability Assist™ (VSA®), aka Electronic Stability Control (ESC), System

In certain unusual conditions when your vehicle gets stuck in shallow mud or fresh snow, it may be easier to free it with the VSA® temporarily switched off.

When the  button is pressed, the traction control function becomes less effective. This allows for the wheels to spin more freely at low speed. You should only attempt to free your vehicle with the VSA® off if you are not able to free it when the VSA® is on.

Immediately after freeing your vehicle, be sure to switch VSA® on again. We do not recommend driving your vehicle with the VSA® system switched off.

You may hear a motor sound coming from the engine compartment while system checks are being performed immediately after starting the engine or while driving. This is normal.

Agile Handling Assist

Lightly brakes the front wheels, as needed, when you turn the steering wheel, and helps support the vehicle's stability and performance during cornering.

ⓘ Agile Handling Assist

The agile handling assist cannot enhance stability in all driving situations. You still need to drive and corner at speeds appropriate for the conditions and always leave a sufficient margin of safety.

When the VSA® system indicator comes on and stays on while driving, the agile handling assist does not activate.

You may hear a sound coming from the engine compartment while the agile handling assist is activated. This is normal.

Tire Pressure Monitoring System (TPMS)

Instead of directly measuring the pressure in each tire, the TPMS on this vehicle monitors and compares the rolling radius and rotational characteristics of each wheel and tire while you are driving to determine if one or more tires are significantly under-inflated.

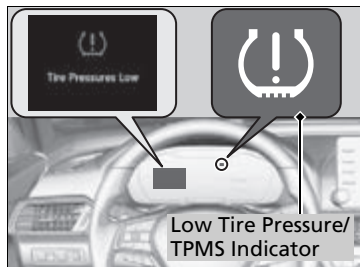

This will cause the low tire pressure/TPMS indicator to come on and a message to appear on the driver information interface.

▶▶ Tire Pressure Monitoring System (TPMS)

The system does not monitor the tires when driving at low speed.

Conditions such as low ambient temperature and altitude change directly affect tire pressure and can trigger the low tire pressure/TPMS indicator to come on.

Tire pressure checked and inflated in:

- Warm weather can become under-inflated in colder weather.
- Cold weather can become overinflated in warmer weather.

The low tire pressure/TPMS indicator will not come on as a result of overinflation.

The TPMS may not function properly if tire type and size are mixed. Make sure to use the same size and type of tire.

▶▶ **Checking and Maintaining Tires** P. 575

The low tire pressure/TPMS indicator may come on with a delay or may not come on at all when:

- You rapidly accelerate, decelerate, or turn the steering wheel.
- You drive on snowy or slippery roads.
- Tire chains* are used.

▶▶ Tire Pressure Monitoring System (TPMS)

The low tire pressure/TPMS indicator may come on under the following conditions:

- A compact spare tire is used.
- There is a heavier and uneven load on the tires, such as when towing a trailer*, than the condition at calibration.
- Tire chains* are used.

The Vehicle Stability Assist™ (VSA®) system, Vehicle Stability Assist™ (VSA®) **OFF**, adaptive cruise control (ACC) with Low Speed Follow, safety support and low tire pressure/TPMS indicators may come on in amber along with a message in the driver information interface when you set the power mode to ON after reconnecting the battery.

Drive a short distance at more than 12 mph (20 km/h). Each indicator should go off. If any do not, have your vehicle checked by a dealer.

* Not available on all models

■ TPMS Calibration

You must start TPMS calibration every time you:

- Adjust the pressure in one or more tires.
- Rotate the tires.
- Replace one or more tires.

Before calibrating the TPMS:

- Set the cold tire pressure in all four tires.
 - ▣ **Checking Tires** P. 575

Make sure:

- The vehicle is at a complete stop.
- The transmission is in **P**.
- The power mode is in ON.

▣ TPMS Calibration

TPMS cannot be calibrated if a compact spare tire is installed.

The calibration process requires approximately 30 minutes of cumulative driving at speeds between 30-60 mph (48-97 km/h).

During this period, if the power mode is set to ON and the vehicle is not moved within 45 seconds, you may notice the low tire pressure/TPMS indicator comes on briefly. This is normal and indicates that the calibration process is not yet complete.

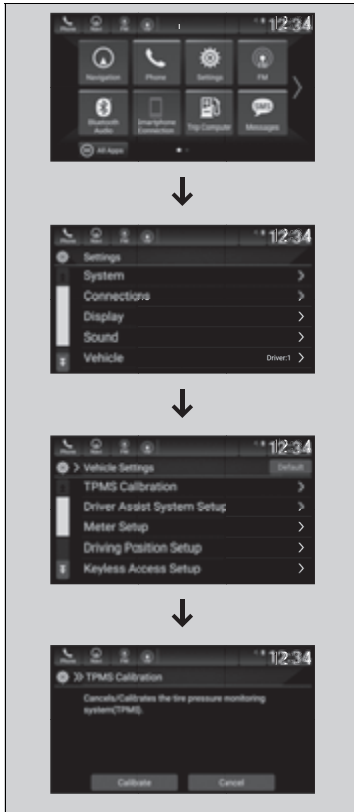

You can calibrate the system from the customized feature on the audio/information screen.

1. Set the power mode to ON.
2. Press the  button.
3. Select **Settings**.
4. Select **Vehicle**.
5. Select **TPMS Calibration**.
6. Select **Calibrate**.

- If the **Calibration Failed To Start** message appears, repeat steps 5-6.
- The calibration process finishes automatically.

▶ TPMS Calibration

If the tire chains* are installed, remove them before calibrating the TPMS.

If the low tire pressure/TPMS indicator comes on even when the properly inflated specified regular tires are installed, have your vehicle checked by a dealer.

We recommend that the tires be replaced with the same brand, model, and size as the originals. Ask a dealer for details.

* Not available on all models

U.S. models

Tire Pressure Monitoring System (TPMS) - Required Federal Explanation

Each tire, including the spare (if provided), should be checked monthly when cold and inflated to the inflation pressure recommended by the vehicle manufacturer on the vehicle placard or tire inflation pressure label.

(If your vehicle has tires of a different size than the size indicated on the vehicle placard or tire inflation pressure label, you should determine the proper tire inflation pressure for those tires.)

As an added safety feature, your vehicle has been equipped with a tire pressure monitoring system (TPMS) that illuminates a low tire pressure telltale



when one or more of your tires is significantly under-inflated.

Accordingly, when the low tire pressure telltale illuminates, you should stop and check your tires as soon as possible, and inflate them to the proper pressure.

Driving on a significantly under-inflated tire causes the tire to overheat and can lead to tire failure. Under-inflation also reduces fuel efficiency and tire tread life, and may affect the vehicle's handling and stopping ability.

Please note that the TPMS is not a substitute for proper tire maintenance, and it is the driver's responsibility to maintain correct tire pressure, even if under-inflation has not reached the level to trigger illumination of the TPMS low tire pressure telltale.

Your vehicle has also been equipped with a TPMS malfunction indicator to indicate when the system is not operating properly. The TPMS malfunction indicator is combined with the low tire pressure telltale. When the system detects a malfunction, the telltale will flash for approximately one minute and then remain continuously illuminated. This sequence will continue upon subsequent vehicle start-ups as long as the malfunction exists.

When the malfunction indicator is illuminated, the system may not be able to detect or signal low tire pressure as intended.

TPMS malfunctions may occur for a variety of reasons, including the installation of replacement or alternate tires or wheels on the vehicle that prevent the TPMS from functioning properly.

Always check the TPMS malfunction telltale after replacing one or more tires or wheels on your vehicle to ensure that the replacement or alternate tires and wheels allow the TPMS to continue to function properly.

Blind spot information System*

Is designed to detect vehicles in specified alert zones adjacent to your vehicle, particularly in harder to see areas commonly known as "blind spots."

When the system detects vehicles approaching from behind in adjacent lanes, the appropriate indicator comes on for a few seconds, providing assistance when you change lanes.

■ How the system works

- The transmission is in **D**.
- Your vehicle speed is between 20 mph (32 km/h) and 100 mph (160 km/h).

Alert zone range

- A: Approx. 1.6 ft. (0.5 m)
- B: Approx. 10 ft. (3 m)
- C: Approx. 10 ft. (3 m)

Radar Sensors:
underneath the
rear bumper
corners

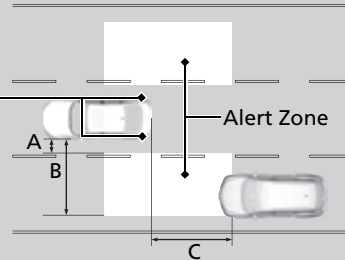

▶▶ Blind spot information System*

⚠ WARNING

Failure to visually confirm that it is safe to change lanes before doing so may result in a crash and serious injury or death. Do not rely only on the blind spot information system when changing lanes.

Always look in your mirrors, to either side of your vehicle, and behind you for other vehicles before changing lanes.

Important Safety Reminder

Like all assistance systems, the blind spot information system has limitations. Overreliance on the blind spot information system may result in a collision.

The blind spot information system alert indicator may not come on under the following conditions:

- A vehicle does not stay in the alert zone for more than two seconds.
- A vehicle is parked in a side lane.
- The speed difference between your vehicle and the vehicle you are passing is greater than 6 mph (10 km/h).
- An object not detected by the radar sensors approaches or passes your vehicle.
- A vehicle running in the adjacent lane is a motorcycle or other small vehicle.

■ When the system detects a vehicle

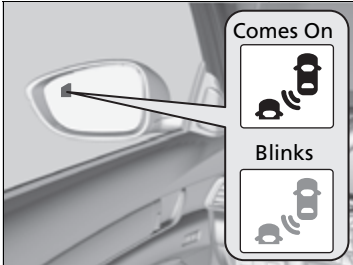

Blind spot information System Alert Indicator:
Located on the outside rearview mirror on both sides.

Comes on when:

- A vehicle enters the alert zone from behind to overtake you with a speed difference of no more than 31 mph (50 km/h) from your vehicle.
- You pass a vehicle with a speed difference of no more than 12 mph (20 km/h).

Blinks and a beeper sounds when:

You move the turn signal lever in the direction of the detected vehicle. The beeper sounds three times.

⊗ Blind spot information System*

The system is for your convenience only. Even if an object is within the alert zone, the following situations may occur.

- The blind spot information system alert indicator may not come on due to obstruction (splashes, etc.) even without the **Blind Spot Information System Not Available** driver information interface appearing.
- The blind spot information system alert indicator may come on even with the message appearing.

You can change the setting for the blind spot information system.

➤ **Customized Features** P. 351

The system does not operate when in **[R]**.

2.0 L engine models

Turn the system off when towing a trailer.

The system may not work properly for the following reasons:

- The added mass tilts the vehicle and changes the radar coverage.
- The trailer itself can be detected by the radar sensors, causing the blind spot information system alert indicators to come on.

* Not available on all models

■ Blind spot information System On and Off

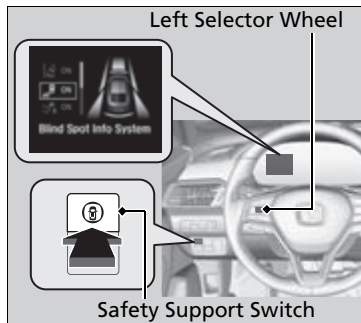

When you turn the blind spot information system on and off, do the following.

1. Press the safety support switch.
2. Roll the left selector wheel to the  symbol and push it.

The blind spot information system is in the previously selected **ON** or **OFF** setting each time you start the engine.

▶▶ Blind spot information System*

The blind spot information system may be adversely affected when:

- Objects (guard rails, poles, trees, etc.) are detected.
- An object that does not reflect radio waves well, such as a motorcycle, is in the alert zone.
- Driving on a curved road.
- A vehicle is moving from a far lane to the adjacent lane.
- The system picks up external electrical interference.
- The rear bumper or the sensors have been improperly repaired or the rear bumper has been deformed.
- The orientation of the sensors has been changed.
- In bad weather (Heavy rain, snow, and fog).
- Making a turn at an intersection.
- Driving on a bumpy road.
- Making a short turn that slightly tilts the vehicle.

For a proper blind spot information system operation:

- Always keep the rear bumper corner area clean.
- Do not cover the rear bumper corner area with labels or stickers of any kind.
- Take your vehicle to a dealer if you need the rear bumper corner area or the radar sensors to be repaired, or the rear bumper corner area is strongly impacted.

Models with Low Speed Braking Control

Honda Sensing® is a driver support system which employs the use of three distinctly different kinds of sensors: a radar sensor located at the lower part of the front bumper, a front sensor camera mounted to the interior side of the windshield, behind the rearview mirror, and the sonar sensors located in the front and rear bumpers.

Models without Low Speed Braking Control

Honda Sensing® is a driver support system which employs the use of two distinctly different kinds of sensors: a radar sensor located at the lower part of the front bumper and a front sensor camera mounted to the interior side of the windshield, behind the rearview mirror.

Honda Sensing® has following functions:

■ The functions which do not require switch operations to activate

- Collision Mitigation Braking System™ (CMBS™) 📄 P. 456
- Low Speed Braking Control* 📄 P. 465
- Road Departure Mitigation (RDM) System 📄 P. 494
- Traffic Sign Recognition System 📄 P. 498

■ The functions which require switch operations to activate

- Adaptive Cruise Control (ACC) with Low Speed Follow 📄 P. 470
- Lane Keeping Assist System (LKAS) 📄 P. 486

* Not available on all models

■ Operation Switches for the ACC with Low Speed Follow/ LKAS

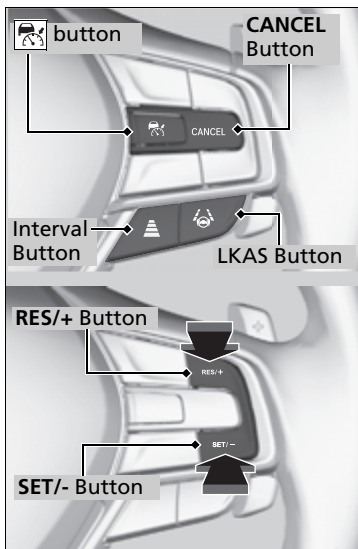

■ Button

Press to activate standby mode for ACC with Low Speed Follow. Or press to cancel the system.

■ LKAS Button

Press to activate standby mode for LKAS. Or press to cancel the system.

■ RES/+ and SET/- Buttons

Press **RES/+** button to resume the ACC with Low Speed Follow or increase the vehicle speed.

Press **SET/-** button to set the ACC with Low Speed Follow or decrease the vehicle speed.

■ Interval Button

Press to change the ACC with Low Speed Follow following-interval.

■ CANCEL Button

Press to cancel ACC with Low Speed Follow.

Driver Information Interface Content

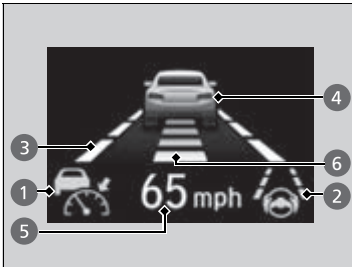

You can see the current state of ACC with Low Speed Follow and LKAS.

- ① Indicates that ACC with Low Speed Follow is ready to be activated.
 - White: The system is standby.
 - Green: The system is on.
 - Amber: There is a problem with the system.
- ② Indicates that LKAS is ready to be activated.
 - White: The system is standby.
 - Green: The system is on.
 - Amber: There is a problem with the system.
- ③ Indicates that LKAS is activated and whether or not traffic lane lines are detected.
 - Solid lane outlines: The system is on.
 - Lane outlines: The system is in standby.
- ④ Indicates whether or not ACC with Low Speed Follow detects the vehicle ahead.
- ⑤ Shows vehicle set speed in ACC with Low Speed Follow.
- ⑥ Shows set vehicle interval in ACC with Low Speed Follow.

Driver Information Interface Content

Models with head-up display

You can have the head-up display show you the current state of each function.

▶ **Head-Up Display*** P. 159

* Not available on all models

Collision Mitigation Braking System™ (CMBS™)

The system can assist you when it determines there is a possibility of your vehicle colliding with a vehicle or a pedestrian detected in front of your vehicle. The CMBS™ is designed to alert you when the potential for a collision is determined, as well as to reduce your vehicle speed to help minimize collision severity when a collision is deemed unavoidable.

■ How the system works

When to use

The camera is located behind the rearview mirror.

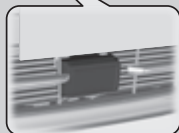
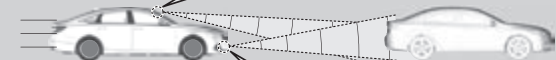

The radar sensor is at the lower part of the front bumper.

The system starts monitoring the roadway ahead when your vehicle speed is about 3 mph (5 km/h) or above and will search for a vehicle in front of you.

The CMBS™ activates when:

- The speed difference between your vehicle and a vehicle or pedestrian detected in front of you becomes about 3 mph (5 km/h) and over with a chance of a collision.
- Your vehicle speed is about 62 mph (100 km/h) or less and the system determines there is a chance of a collision with:
 - Vehicles detected in front of you that are stationary, oncoming, or traveling in your same direction.
 - A pedestrian who is detected in front of you.
- Your vehicle speed is above 62 mph (100 km/h), and the system determines there is a chance of a collision with a vehicle detected in front of you traveling in your same direction.

▶ Collision Mitigation Braking System™ (CMBS™)

Important Safety Reminder

The CMBS™ is designed to reduce the severity of an unavoidable collision. It does not prevent collisions nor stop the vehicle automatically. It is still your responsibility to operate the brake pedal and steering wheel appropriately according to the driving conditions.

The CMBS™ may not activate or may not detect a vehicle in front of your vehicle under certain conditions:

▶ **CMBS™ Conditions and Limitations** P. 460

For directions on the proper handling of the radar sensor, refer to the following page.

▶ **Radar Sensor** P. 506

You can read about handling information for the camera equipped with this system.

▶ **Front Sensor Camera** P. 504

When the CMBS™ activates, it may automatically apply the brake. It will be canceled when your vehicle stops or a potential collision is not determined.

■ When the system activates

The system provides visual and audible alerts of a possible collision, and stops if the collision is avoided.

- ▶ Take appropriate action to prevent a collision (apply the brakes, change lanes, etc.).

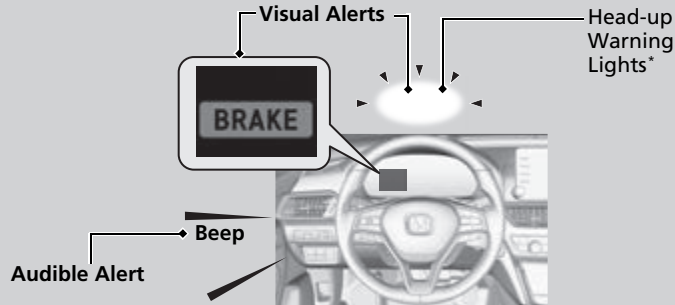

You can change the distance (**Long/Normal/Short**) between vehicles at which the system's earliest collision alert will come on through audio/information screen setting options.

- ▶ **Customized Features** P. 351

▶▶ When the system activates

The camera in the CMBS™ is also designed to detect pedestrians.

However, this pedestrian detection feature may not activate or may not detect a pedestrian in front of your vehicle under certain conditions. Refer to the ones indicating the pedestrian detection limitations from the list.

- ▶ **CMBS™ Conditions and Limitations** P. 460

Models with head-up display

The head-up warning uses a lens located at the front end of the dashboard.

Do not cover the lens or spill any liquid on it.

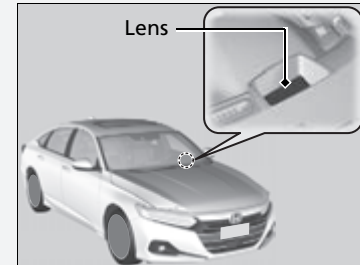

* Not available on all models

■ Collision Alert Stages

The system has three alert stages for a possible collision. However, depending on circumstances, the CMBS™ may not go through all of the stages before initiating the last stage.

Distance between vehicles		CMBS™		
		The radar sensor detects a vehicle	Audible & Visual WARNINGS	Braking
Stage one	<p>Normal Long Short Your Vehicle Vehicle Ahead</p>	There is a risk of a collision with the vehicle ahead of you.	When in Long , visual and audible alerts come on at a longer distance from a vehicle ahead than in Normal setting, and in Short , at a shorter distance than in Normal .	—
Stage two	<p>Your Vehicle Vehicle Ahead</p>	The risk of a collision has increased, time to respond is reduced.	Visual and audible alerts.	Lightly applied
Stage three	<p>Your Vehicle Vehicle Ahead</p>	The CMBS™ determines that a collision is unavoidable.		Forcefully applied

■ CMBS™ On and Off

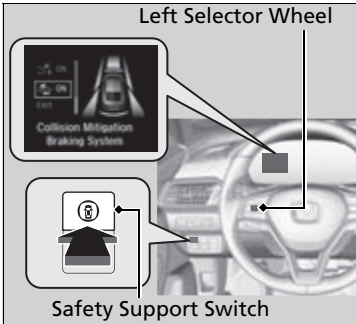

When you turn the CMBS™ on and off, do the following.

1. Press the safety support switch.
2. Roll the left selector wheel to the  symbol and push it.
 - ▶ A message appears on the driver information interface when the system turns on or off.

The CMBS™ is turned on every time you start the engine, even if you turned it off the last time you drove the vehicle.

☒ CMBS™ On and Off

The CMBS™ may automatically shut off, and the safety support indicator (amber) will come and stay on under certain conditions:

☒ **CMBS™ Conditions and Limitations** P. 460

When the CMBS™ is activated, it will continue to operate even if the accelerator pedal is partially depressed. However, it will be canceled if the accelerator pedal is fully depressed.

The Vehicle Stability Assist™ (VSA®) system, Vehicle Stability Assist™ (VSA®) **OFF**, adaptive cruise control (ACC) with Low Speed Follow, safety support and low tire pressure/TPMS indicators may come on in amber along with a message in the driver information interface when you set the power mode to ON after reconnecting the battery.

Drive a short distance at more than 12 mph (20 km/h). Each indicator should go off. If any do not, have your vehicle checked by a dealer.

■ CMBS™ Conditions and Limitations

The system may automatically shut off and the safety support indicator (amber) will come on under certain conditions. Some examples of these conditions are listed below. Other conditions may reduce some of the CMBS™ functions.

➤ **Front Sensor Camera** P. 504

➤ **Radar Sensor** P. 506

■ Environmental conditions

- Driving in bad weather (rain, fog, snow, etc.).
- Sudden changes between light and dark, such as an entrance or exit of a tunnel.
- There is little contrast between objects and the background.
- Driving into low sunlight (e.g., at dawn or dusk).
- Strong light is reflected onto the roadway.
- Driving in the shadows of trees, buildings, etc.
- Roadway objects or structures are misinterpreted as vehicles and pedestrians.
- Reflections on the interior of the windshield.
- Driving at night or in a dark place such as a tunnel (due to low-light conditions, pedestrians or other vehicles may not be detected).

■ Roadway conditions

- Driving on a snowy or wet roadway (obscured lane marking, vehicle tracks, reflected lights, road spray, high contrast).
- Driving on curvy, winding, or undulating roads.
- The road is hilly or the vehicle is approaching the crest of a hill.

⚠ Collision Mitigation Braking System™ (CMBS™)

Have your vehicle checked by a dealer if you find any unusual behavior of the system (e.g., the warning message appears too frequently).

■ Vehicle conditions

- Headlight lenses are dirty or the headlights are not properly adjusted.
- The outside of the windshield is blocked by dirt, mud, leaves, wet snow, etc.
- The inside of the windshield is fogged.
- An abnormal tire or wheel condition (incorrect sizes, varied sizes or construction, improperly inflated, compact spare tire, etc.).
- When tire chains* are installed.
- The vehicle is tilted due to a heavy load or suspension modifications.
- The camera temperature gets too high.
- Driving with the parking brake applied.
- When the radar sensor at the lower part of the front bumper gets dirty.
- The vehicle is towing a trailer*.
- Driving at night or in a dark place (e.g., a tunnel) with the headlights off.

■ Detection limitations

- A vehicle or pedestrian suddenly crosses in front of you.
- The distance between your vehicle and the vehicle or pedestrian ahead of you is too short.
- A vehicle cuts in front of you at a slow speed, and it brakes suddenly.
- When you accelerate rapidly and approach the vehicle or pedestrian ahead of you at high speed.
- The vehicle ahead of you is a motorcycle, bicycle, mobility scooter or other small vehicle.
- When there are animals in front of your vehicle.
- When you drive on a curved, winding or undulating road that makes it difficult for the sensor to properly detect a vehicle in front of you.
- The speed difference between your vehicle and a vehicle or pedestrian in front of you is significantly large.
- An oncoming vehicle suddenly comes in front of you.
- Another vehicle suddenly comes in front of you at an intersection, etc.
- Your vehicle abruptly crosses over in front of an oncoming vehicle.
- When driving through a narrow iron bridge.
- When the lead vehicle suddenly slows down.

* Not available on all models

Continued

Limitations applicable to pedestrian detection only

- When there is a group of people in front of your vehicle walking together side by side.
- Surrounding conditions or belongings of the pedestrian alter the pedestrian's shape, preventing the system from recognizing that the person is a pedestrian.
- When the pedestrian is shorter than about 3.3 feet (1 meter) or taller than about 6.6 feet (2 meters) in height.
- When a pedestrian blends in with the background.
- When a pedestrian is bent over or squatting, or when their hands are raised or they are running.
- When several pedestrians are walking ahead in a group.
- When the camera cannot correctly identify that a pedestrian is present due to an unusual shape (holding luggage, body position, size).

■ Automatic shutoff

The CMBS™ may automatically shut itself off and the safety support indicator (amber) comes and stays on when:

- The temperature inside the system is high.
- You drive off-road or on a mountain road, or curved and winding road for an extended period.
- An abnormal tire condition is detected (incorrect tire size, flat tire, etc.).
- The camera behind the rearview mirror, or the area around the camera, including the windshield, gets dirty.

Once the conditions that caused the CMBS™ to shut off improve or are addressed (e.g., cleaning), the system comes back on.

■ With Little Chance of a Collision

The CMBS™ may activate even when you are aware of a vehicle ahead of you, or when there is no vehicle ahead. Some examples of this are:

■ When Passing

Your vehicle approaches another vehicle ahead of you and you change lanes to pass.

■ At an intersection

Your vehicle approaches or passes another vehicle that is making a left or right turn.

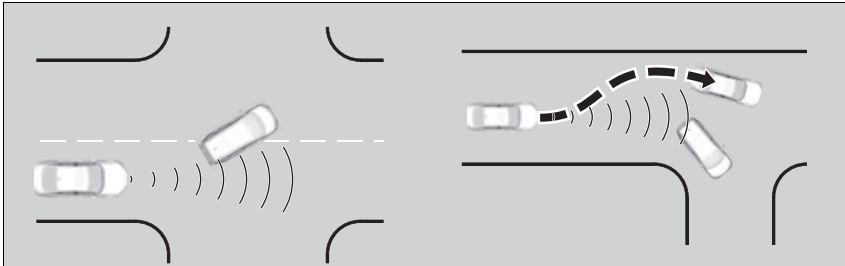

■ **On a curve**

When driving through curves, your vehicle comes to a point where an oncoming vehicle is right in front of you.

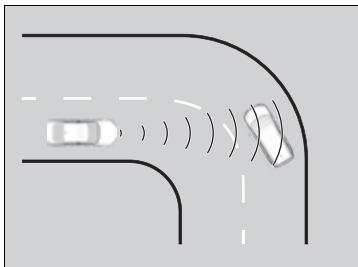

■ **Through a low bridge at high speed**

You drive under a low or narrow bridge at high speed.

■ **Speed bumps, road work sites, train tracks, roadside objects, etc.**

You drive over speed bumps, steel road plates, etc., or your vehicle approaches train tracks or roadside objects (such as a traffic sign and guard rail) on a curve or, when parking, stationary vehicles and walls.

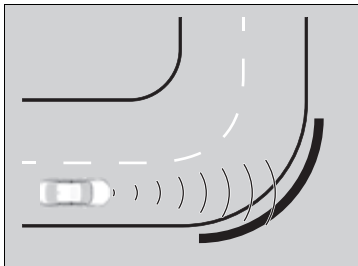

Low Speed Braking Control*

Using sonar sensors located on the front and rear bumpers, the vehicle detects if there is danger of a potential collision with a wall or other obstacle. The system is designed to alert you when a potential collision is determined, as well as assist in reducing speed, avoiding collisions, and reducing collision severity.

Low Speed Braking Control*

⚠ WARNING

The Low Speed Braking Control System cannot avoid all collisions and may not reduce damage in each situation where the accelerator is mistakenly or aggressively pressed. Overreliance on the system may result in a collision with serious injury or death. Always check your surroundings, your shift position, and your pedal use. Driver remains responsible for safely operating the vehicle.

If the Low Speed Braking Control activates in a situation where you do not want automatic brake application (such as when the vehicle is between two railroad crossing gates), simply press the brake pedal to deactivate the system and then continue to drive as intended.

* Not available on all models

■ How the System Works

The Low Speed Braking Control provides a visual and audible alert when the vehicle is moving between approximately 1 and 6 mph (2 and 10 km/h) and there is the possibility of a collision with a detected wall or other obstacle, as well as providing assistance with braking.

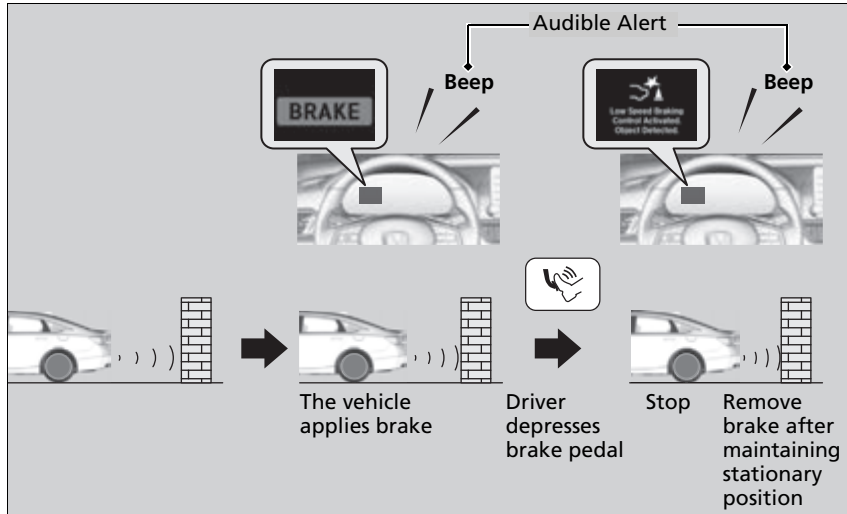

If the only rear sensors are turned off using the parking sensor system, the assistive braking is not working when reversing.

▶ **Turning off All Rear Sensors** P. 524

▶▶ Low Speed Braking Control*

For directions on the proper handling of the sonar sensors, please refer to the following page.

▶ **Sonar Sensors*** P. 507

The vehicle will release the brake and start moving a few seconds after the system is activated. To keep the vehicle stopped, keep the brake pedal depressed or put the transmission into **P**.

In order to prevent the system from activating when not needed, always turn it off during vehicle maintenance, when loading on ships, trucks, and so on, when using a chassis dynamometer or free rollers for inspection or when putting your vehicle through a conveyor type car wash.

Do not make any modifications to the suspension or the system may not operate correctly.

Always use the size and type of tires recommended, make, and amount of wear. If these differ, the system may not operate correctly.

System On and Off

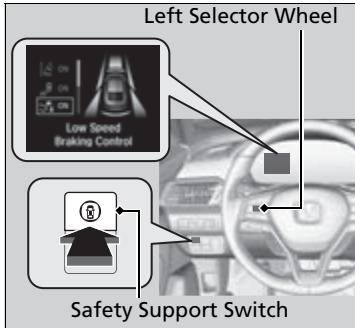

When you turn the system on and off, do the following.

1. Press the safety support switch.
2. Roll the left selector wheel to the  symbol and push it.

▶ A message appears on the driver information interface when the system turns on or off.

The system is turned on every time you start the engine, even if you turned it off the last time you drove the vehicle.

System On and Off

If the battery is disconnected and reconnected, the Low Speed Braking Control may not turn on right away when you start the engine.

The system will automatically turn ON after the vehicle has been moving at over 12mph (20km/h) for some time.

If the system does not turn on, have your vehicle checked by a dealer.

■ Conditions for Cancellation

A certain amount of time has passed since activation.

■ Low Speed Braking Control System Conditions and Limitations

The system may not operate correctly under the following conditions:

■ Examples of obstacles the sonar sensors cannot detect

- Obstacles that do not reflect sound waves well, such as people, snow, cloth, sponges, etc.
- Thin obstacles such as fences, bicycles, sign posts, etc.
- Short or small obstacles.
- Obstacles immediately in front of the bumper.
- Moving objects or obstacles that suddenly enter the road.
- Obstacles that are not perpendicular to the ground, such as a wall.

☒ Conditions for Cancellation

After Low Speed Braking Control has activated once, it will not activate again for the same obstacle. The system can be activated again after driving for some time after the last activation.

Low Speed Braking Control activates separately when moving forward and reversing. (For example, if it activates when moving forward, it can be activated again immediately if reversing.)

■ Examples of situations where the sonar sensors cannot detect obstacles

- The sonar sensors are dirty (covered by snow, water, mud, etc.).
- The vehicle is too hot or cold.
- The steering wheel is turned sharply when approaching the obstacle at an angle.

■ Examples of other cases where the system may not work correctly

- The vehicle is tilted due to heavy load in the trunk or rear seats.
- Bad weather conditions such as heavy rain, fog, snow, sandstorms, etc.
- The ambient temperature/humidity is too high or low.
- When going down a very steep slope.
- When close to other vehicles with sonar sensors or other objects that emit ultrasonic waves.

■ Situations where the system may activate even without risk of a collision

- When passing through short or narrow gates.
- When driving on uneven surfaces, grassy areas, or places with steps.
- When a sloped pillar or wall is protruding from a high position.
- When there are obstacles next to the road.
- When driving toward flags, curtains, tree branches, railroad crossing bars, etc.
- When driving on flooded roads.

Adaptive Cruise Control (ACC) with Low Speed Follow

Helps maintain a constant vehicle speed and a set following-interval behind a vehicle detected ahead of yours and, if the detected vehicle comes to a stop, can decelerate and stop your vehicle, without you having to keep your foot on the brake or the accelerator.

When ACC with Low Speed Follow slows your vehicle by applying the brakes, your vehicle's brake lights will illuminate.

▶ Adaptive Cruise Control (ACC) with Low Speed Follow

⚠ WARNING

Improper use of ACC with Low Speed Follow can lead to a crash.

Use ACC with Low Speed Follow only when driving on expressways or freeways and in good road and weather conditions.

⚠ WARNING

ACC with Low Speed Follow has limited braking capability and may not stop your vehicle in time to avoid a collision with a vehicle that quickly stops in front of you.

Always be prepared to apply the brake pedal if the conditions require.

Important Reminder

As with any system, there are limits to ACC with Low Speed Follow. Use the brake pedal whenever necessary, and always keep a safe interval between your vehicle and other vehicles.

When to use

The camera is located behind the rearview mirror.

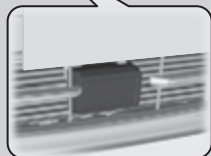

The radar sensor is at the lower part of the front bumper.

- Vehicle speed for ACC with Low Speed Follow: **A vehicle is detected ahead within ACC with Low Speed Follow range** – ACC with Low Speed Follow operates at speeds up to 90 mph (145 km/h).
No vehicle is detected within ACC with Low Speed Follow range – ACC with Low Speed Follow operates at the speed of 25 mph (40 km/h) or above.
- Shift position for ACC with Low Speed Follow: In **D** or **S***.

■ How to activate the system

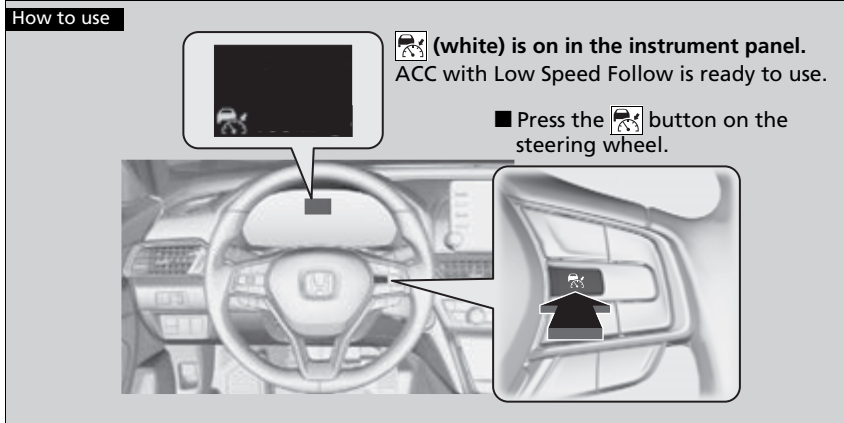

▣ Adaptive Cruise Control (ACC) with Low Speed Follow

For directions on the proper handling of the radar sensor, refer to the following page.

▣ **Radar Sensor** P. 506

You can read about handling information for the camera equipped with this system.

▣ **Front Sensor Camera** P. 504

ACC with Low Speed Follow may not work properly under certain conditions.

▣ **ACC with Low Speed Follow Conditions and Limitations** P. 476

When not using ACC with Low Speed Follow: Turn off adaptive cruise by pressing the  button.

Do not use ACC with Low Speed Follow under the following conditions:

- On roads with heavy traffic or while driving in continuous stop and go traffic.
- On roads with sharp turns.
- On roads with steep downhill sections, as the set vehicle speed can be exceeded by coasting. In such cases, ACC with Low Speed Follow will not apply the brakes to maintain the set speed.
- On roads with toll collection facilities or other objects between lanes of traffic, or in parking areas, or facilities with drive through access.

■ To Set the Vehicle Speed

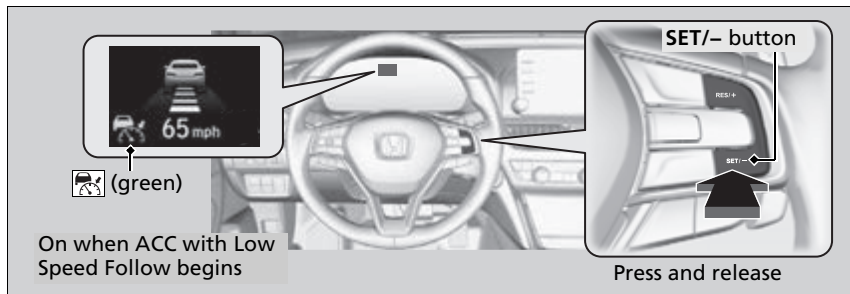

When driving at about 25 mph (40 km/h) or above: Take your foot off the pedal and press the **SET/-** button when you reach the desired speed. The moment you release the button, the set speed is fixed, and ACC with Low Speed Follow begins.

When driving slower than about 25 mph (40 km/h): If the vehicle is moving and the brake pedal is not depressed, pressing the button fixes the set speed to about 25 mph (40 km/h) regardless of current vehicle speed. If the vehicle is stationary, you can set the vehicle speed even with the brake pedal depressed.

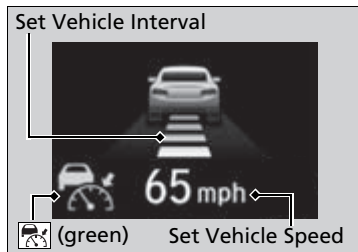

When ACC with Low Speed Follow starts operating, the vehicle icon, interval bars and set speed appear on the driver information interface.

When you use ACC with Low Speed Follow, Straight Driving Assist (a feature of the Electric Power Steering system) is activated. By enabling the steering system to automatically compensate for natural steering pull, Straight Driving Assist makes it easier for you to keep your vehicle in a straight line.

▶▶ To Set the Vehicle Speed

You can switch the displayed set speed measurements on the driver information interface or audio/information screen between mph and km/h.

- ▶ **Speed/Distance Units** P. 151
- ▶ **Customized Features** P. 351

The Vehicle Stability Assist™ (VSA®) system, Vehicle Stability Assist™ (VSA®) **OFF**, adaptive cruise control (ACC) with Low Speed Follow, safety support and low tire pressure/TPMS indicators may come on in amber along with a message in the driver information interface when you set the power mode to ON after reconnecting the battery.

Drive a short distance at more than 12 mph (20 km/h). Each indicator should go off. If any do not, have your vehicle checked by a dealer.

■ When in Operation

■ There is a vehicle ahead

ACC with Low Speed Follow monitors if a vehicle ahead of you enters the ACC with Low Speed Follow range. If a vehicle is detected doing so, the ACC with Low Speed Follow system maintains or decelerates your vehicle's set speed in order to keep the vehicle's set following interval from the vehicle ahead.

📄 **To Set or Change Following-interval** P. 480

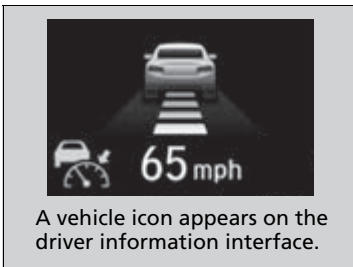
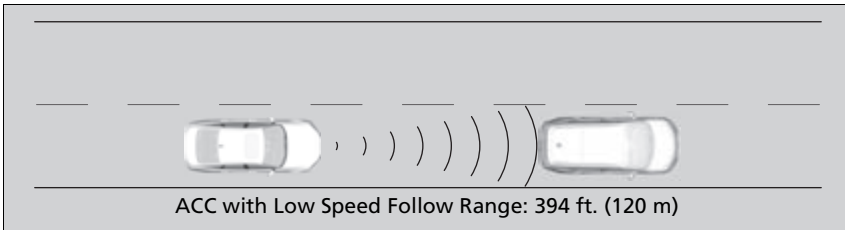

When a vehicle whose speed is slower than your set speed is detected in front of you, your vehicle starts to slow down.

📄 When in Operation

If the vehicle ahead of you slows down abruptly, or if another vehicle cuts in front of you, the beeper sounds, a message appears on the driver information interface, and the head-up warning lights* flash.

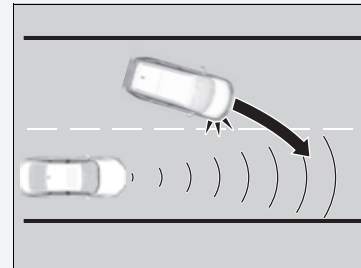

Depress the brake pedal, and keep an appropriate interval from the vehicle ahead.

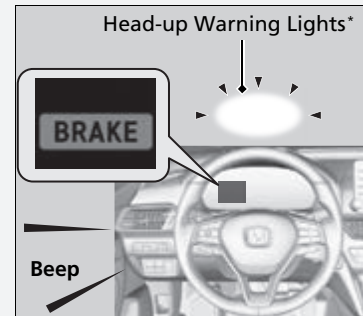

* Not available on all models

■ There is no vehicle ahead



A vehicle icon with dotted-line contour appears on the driver information interface.

Your vehicle maintains the set speed without having to keep your foot on the brake or accelerator pedal.

If there previously was a vehicle detected ahead that kept your vehicle from traveling at the set speed, ACC with Low Speed Follow accelerates your vehicle to the set speed, and then maintains it.

■ When you depress the accelerator pedal

You can temporarily increase the vehicle speed. In this case, there is no audible or visual alert even if a vehicle is in the ACC with Low Speed Follow range.

ACC with Low Speed Follow stays on unless you cancel it. Once you release the accelerator pedal, the system resumes an appropriate speed for keeping the following interval while a vehicle ahead is within the ACC with Low Speed Follow range.

🔍 When in Operation

Even if the interval between your vehicle and the vehicle detected ahead is short, ACC with Low Speed Follow may start accelerating your vehicle under the following circumstances:

- The vehicle ahead of you is going at almost the same speed as, or faster than, your vehicle.
- A vehicle that cuts in front of you is going faster than your vehicle, gradually increasing the interval between the vehicles.

You can also set the system to beep when a vehicle in front of you comes in and goes out of the ACC with Low Speed Follow detecting range. A vehicle detect beep on and off can be selected.

🔍 **Customized Features** P. 351

Limitations

You may need to use the brake to maintain a safe interval when using ACC with Low Speed Follow. Additionally, ACC with Low Speed Follow may not work properly under certain conditions.

🔍 **ACC with Low Speed Follow Conditions and Limitations** P. 476

■ **A vehicle detected ahead is within ACC with Low Speed Follow range and slows to a stop**



Your vehicle also stops, automatically. The **Stopped** message appears on the driver information interface. When the vehicle ahead of you starts again, the vehicle icon on the driver information interface blinks. If you press the **RES/+** or **SET/-** button, or depress the accelerator pedal, ACC with Low Speed Follow operates again within the prior set speed.

If no vehicle is ahead of you before you resume driving, depressing the accelerator pedal will resume operation of ACC with Low Speed Follow within the prior set speed.

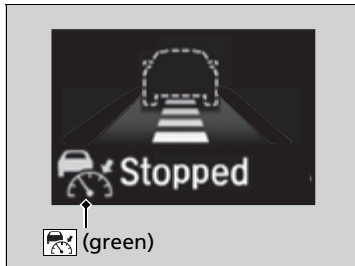

▶▶ A vehicle detected ahead is within ACC with Low Speed Follow range and slows to a stop

⚠ WARNING

Exiting a vehicle that has been stopped while the ACC with Low Speed Follow system is operating can result in the vehicle moving without operator control.

A vehicle that moves without operator control can cause a crash, resulting in serious injury or death.

Never exit a vehicle when the vehicle is stopped by ACC with Low Speed Follow.

■ ACC with Low Speed Follow Conditions and Limitations

The system may automatically shut off under certain conditions. Some examples of these conditions are listed below. Other conditions may reduce some of the ACC with Low Speed Follow functions.

➤ **Front Sensor Camera** P. 504

➤ **Radar Sensor** P. 506

■ Environmental conditions

- Driving in bad weather (rain, fog, snow, etc.).

■ Roadway conditions

- Driving on a snowy or wet roadway (obscured lane marking, vehicle tracks, reflected lights, road spray, high contrast).

■ Vehicle conditions

- The outside of the windshield is blocked by dirt, mud, leaves, wet snow, etc.
- An abnormal tire or wheel condition (incorrect sizes, varied sizes or construction, improperly inflated, compact spare tire, etc.).
- The camera temperature gets too high.
- The parking brake is applied.
- When the radar sensor cover is dirty.
- The vehicle is tilted due to a heavy load or suspension modifications.
- When tire chains* are installed.

⚠ ACC with Low Speed Follow Conditions and Limitations

If you need the radar sensor to be repaired, or removed, or the radar sensor cover is strongly impacted, turn off the system by pressing the  button and take your vehicle to a dealer.

Have your vehicle checked by a dealer if you find any unusual behavior of the system (e.g., the warning message appears too frequently).

■ Detection limitations

- A vehicle suddenly crosses in front of you.
- The interval between your vehicle and the vehicle ahead of you is too short.
- A vehicle cuts in front of you at a slow speed, and it brakes suddenly.
- You accelerate rapidly and approach the vehicle ahead of you at high speed.
- The vehicle ahead of you is a motorcycle, bicycle, mobility scooter, or other small vehicle.
- There are animals in front of your vehicle.
- You drive on a curved or winding or undulating road that makes it difficult for the sensor to properly detect a vehicle in front of you.

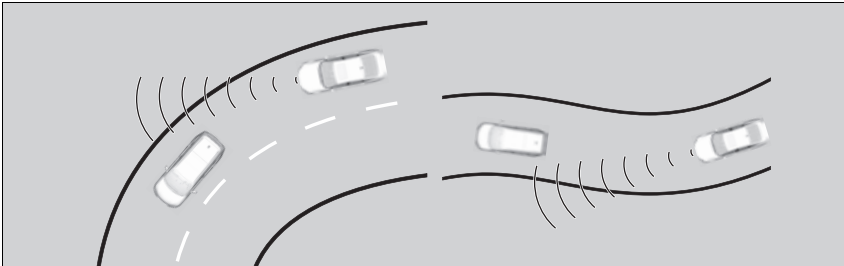

- The speed difference between your vehicle and a vehicle in front of you is significantly large.
- An oncoming vehicle suddenly comes in front of you.
- Your vehicle abruptly crosses over in front of an oncoming vehicle.

- Driving through a narrow metal bridge.



- The vehicle ahead of you brakes suddenly.
- The vehicle ahead of you has a unique shape.

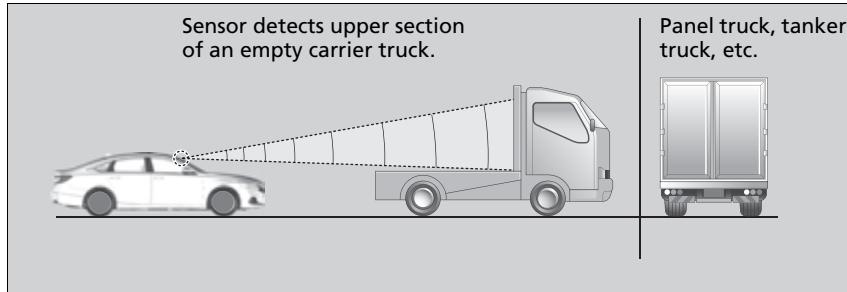

- Your vehicle or the vehicle ahead of you is driving on one edge of the lane.

■ To Adjust the Vehicle Speed

Increase or decrease the vehicle speed using the **RES/+** or **SET/-** button on the steering wheel.

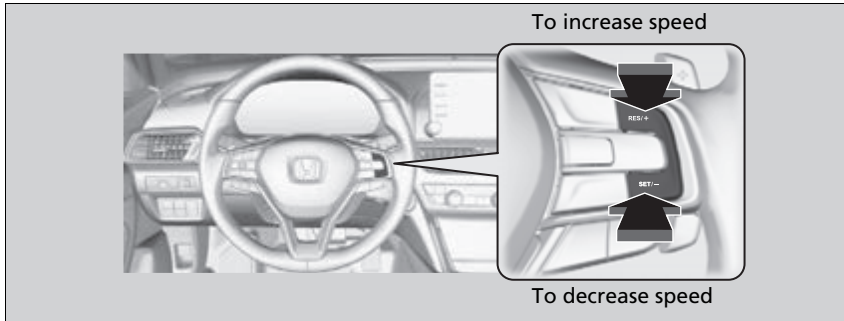

- Each time you press the **RES/+** or **SET/-** button, the vehicle speed is increased or decreased by about 1 mph or 1 km/h accordingly.
- If you keep the **RES/+** or **SET/-** button pressed, the vehicle speed increases or decreases by about 5 mph or 5 km/h accordingly.

☒ To Adjust the Vehicle Speed

If a vehicle detected ahead is going at a speed slower than your increased set speed, ACC with Low Speed Follow may not accelerate your vehicle. This is to maintain the set interval between your vehicle and the vehicle ahead.

You can switch the displayed set speed measurements on the driver information interface or audio/information screen between mph and km/h.

- ☒ **Speed/Distance Units** P. 151
- ☒ **Customized Features** P. 351

When you depress the accelerator pedal and then push and release the **SET/-** button, the current speed of the vehicle is set.



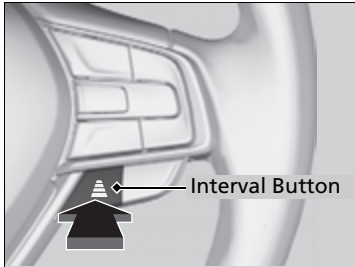

■ To Set or Change Following-interval



Press the Interval button to change the ACC with Low Speed Follow following-interval. Each time you press the button, the following-interval (the interval behind a vehicle detected ahead of you) setting cycles through extra long, long, middle, and short following-intervals.

Determine the most appropriate following-interval setting based on your specific driving conditions. Be sure to adhere to any following-interval requirements set by local regulation.

The higher your vehicle's following-speed is, the longer the short, middle, long or extra long following-interval becomes. See the following examples for your reference.





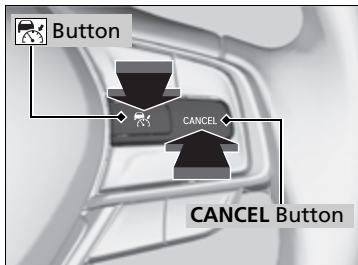

Following Interval		When the Set Speed is:	
		50 mph (80 km/h)	65 mph (104 km/h)
Short		83 feet 25 meters 1.1 sec	100 feet 31 meters 1.1 sec
Middle		110 feet 33 meters 1.5 sec	137 feet 42 meters 1.5 sec
Long		154 feet 47 meters 2.1 sec	200 feet 61 meters 2.1 sec
Extra Long		207 feet 63 meters 2.9 sec	272 feet 83 meters 2.9 sec

When your vehicle stops automatically because a vehicle detected ahead of you has stopped, the interval between the two vehicles will vary based on the ACC with Low Speed Follow interval setting.

■ To Cancel





To cancel ACC with Low Speed Follow, do any of the following:

- Press the **CANCEL** button.
 - ▶ The  indicator (green) on the driver information interface change to the  indicator (white).
- Press the  button.
 - ▶  indicator (green) goes off.
- Depress the brake pedal while the vehicle is moving forward.
 - ▶ The  indicator (green) on the driver information interface change to the  indicator (white).

▶▶ To Cancel

Resuming the prior set speed: After you have canceled ACC with Low Speed Follow, you can resume the prior set speed while it is still displayed. Press the **RES/+** button.

The set speed cannot be set or resumed when ACC with Low Speed Follow has been turned off using the  button. Press the  button to activate the system, then set the desired speed.

■ Automatic cancellation

The beeper sounds and a message appears on the driver information interface when ACC with Low Speed Follow is automatically canceled. Any of these conditions may cause the ACC with Low Speed Follow to automatically cancel:

- Bad weather (rain, fog, snow, etc.)
- When the radar sensor at the lower part of the front bumper gets dirty.
- The vehicle ahead of you cannot be detected.
- An abnormal tire condition is detected, or the tires are skidding.
- Driving on a mountainous road, or driving off road for extended periods.
- Abrupt steering wheel movement.
- When the ABS, VSA®, CMBS™, or Low Speed Braking Control system* is activated.
- When the ABS or VSA® system indicator comes on.
- When the vehicle is stopped on a very steep slope.
- When you manually apply the parking brake.
- When the detected vehicle within the ACC with Low Speed Follow range is too close to your vehicle.
- The camera behind the rearview mirror, or the area around the camera, including the windshield, gets dirty.
- When the Maximum Load Limit is exceeded.
- When passing through an enclosed space, such as tunnel.
- The vehicle has repeatedly applied the brakes to maintain the set speed (for example, you are descending a long slope).

The ACC with Low Speed Follow automatic cancellation can be also triggered by the following causes. In these cases, the parking brake will be automatically applied.

- The driver's seat belt is unfastened when the vehicle is stationary.
- The vehicle stops for more than 10 minutes.
- The engine is turned off.

* Not available on all models

Continued

⌘ Automatic cancellation

Even though ACC with Low Speed Follow has been automatically canceled, you can still resume the prior set speed. Wait until the condition that caused ACC with Low Speed Follow to cancel improves, then press the **SET/−** button.

■ To Switch ACC with Low Speed Follow to Cruise Control

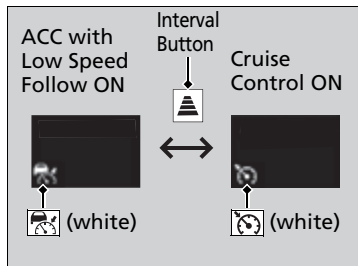

Press and hold the interval button for one second. **Cruise Mode Selected** appears on the driver information interface for two seconds, and then the mode switches to Cruise.

The  indicator comes on.

- White: The system is standby.
- Green: The system is on.

To switch back to ACC with Low Speed Follow, press and hold the interval button again for one second.

■ When to use

Desired speed in a range above roughly 25 mph (40 km/h).

■ To Set the Vehicle Speed

Take your foot off the pedal and press the **SET/-** button when you reach the desired speed.

The moment you release the **SET/-** button, the set speed is fixed, and cruise control begins. The color of  indicator changes from white to green.

When you use cruise control, Straight Driving Assist (a feature of the Electric Power Steering system) is activated.

By enabling the steering system to automatically compensate for natural steering pull, Straight Driving Assist makes it easier for you to keep your vehicle in a straight line.

▶▶ To Switch ACC with Low Speed Follow to Cruise Control

Always be aware which mode you are in. When you are driving in Cruise mode, the system will not assist you to maintain a following interval from a vehicle ahead of you.

You can switch the displayed set speed measurements on the driver information interface or audio/information screen between mph and km/h.

- ▶ **Speed/Distance Units** P. 151
- ▶ **Customized Features** P. 351







■ To Adjust the Vehicle Speed

Each time you press the **RES/+** or **SET/-** button, the vehicle speed is increased or decreased by about 1 mph or 1 km/h.

If you keep the **RES/+** or **SET/-** button pressed, the vehicle speed increases or decreases by about 5 mph or 5 km/h.

■ To Cancel

To cancel cruise control, do any of the following:

- Press the **CANCEL** button.
 - ▶ The  indicator (green) on the driver information interface changes to the  indicator (white).
- Press the  button.
 - ▶ The  indicator (green) goes off.
- Depress the brake pedal.
 - ▶ The  indicator (green) on the driver information interface changes to the  indicator (white).

▶▶ To Cancel

Resuming the prior set speed:

After cruise control has been canceled, you can still resume the prior set speed by pressing the **RES/+** button while driving at a speed of at least 25 mph (40 km/h) or more.

You cannot set or resume in the following situations:

- When vehicle speed is less than 25 mph (40 km/h).
- When the  button is turned off.

At vehicle speeds of 22 mph (35 km/h) or less, cruise control is canceled automatically.

Lane Keeping Assist System (LKAS)

Provides steering input to help keep the vehicle in the middle of a detected lane and provides tactile and visual alerts if the vehicle is detected drifting out of its lane.

■ Steering input assist

The system applies torque to the steering to keep the vehicle between the left and right lane lines. The applied torque becomes stronger as the vehicle gets closer to either of the lane lines.

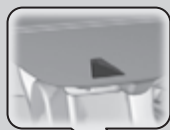

■ Front Sensor Camera
Monitors the lane lines.

■ Tactile and visual alerts

Rapid vibrations on the steering wheel and a warning display alert you that the vehicle is drifting out of a detected lane.

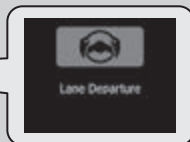

When you operate the turn signals to change lanes, the system is suspended, and resumes after the signals are off.

If you make a lane change without operating the turn signals, the LKAS alerts activate, and torque is applied to the steering.

▶ Lane Keeping Assist System (LKAS)

Important Safety Reminders

The LKAS is for your convenience only. It is not an autonomous driving system and always requires driver attention and control. The system does not work if you take your hands off the steering wheel or fail to steer the vehicle.

▶ Driver Information Interface Warning and Information Messages P. 109

The LKAS is convenient when it is used on freeways.

Do not place objects on the instrument panel. Objects may reflect on the windshield and prevent correct detection of the traffic lanes.

The LKAS only alerts you when lane drift is detected without a turn signal in use. The LKAS may not detect all lane markings or lane departures; accuracy will vary based on weather, speed, and lane marker condition.

It is always your responsibility to safely operate the vehicle and avoid collisions.

The LKAS may not work properly or may work improperly under the certain conditions:

▶ LKAS Conditions and Limitations P. 491

You can read about handling information for the camera equipped with this system.

▶ Front Sensor Camera P. 504

■ Lane Keep Support Function

Provides assistance to keep the vehicle in the center of the lane. When the vehicle nears a white or yellow line, steering force of the electric power steering will become stronger.

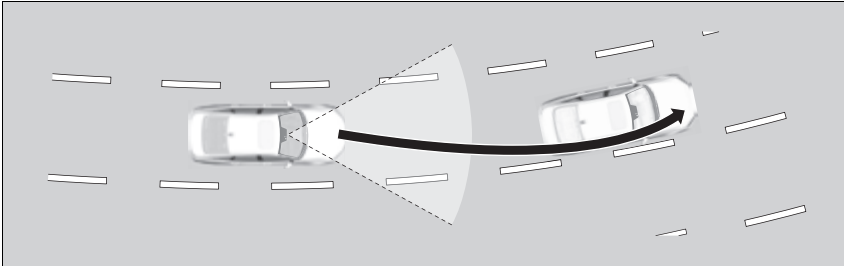

■ Lane Departure Warning Function

When the vehicle enters the warning area, the LKAS alerts you with slight steering wheel vibration as well as a warning display.

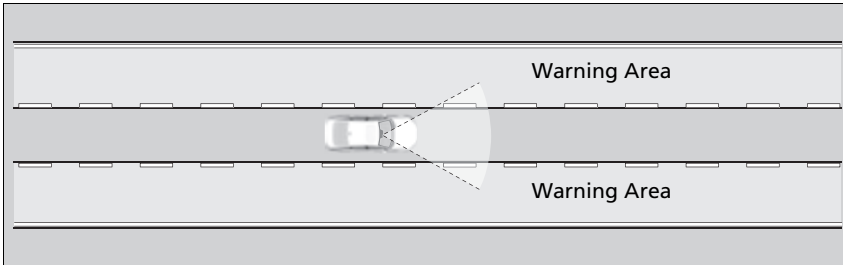

☒ Lane Keeping Assist System (LKAS)

The LKAS may not function as designed while driving in frequent stop and go traffic, or on roads with sharp curves.

When it fails to detect lanes, the system will temporarily be canceled. When a lane is detected, the system will recover automatically.

■ When the System can be Used

The system can be used when the following conditions are met.

- The lane in which you are driving has detectable lane markers on both sides, and your vehicle is in the center of the lane.
- The vehicle is traveling between about 45 and 90 mph (72 and 145 km/h).
- You are driving on a straight or slightly curved road.
- The turn signals are off.
- The brake pedal is not depressed.
- The wipers are not in high speed operation.

■ How to activate the system

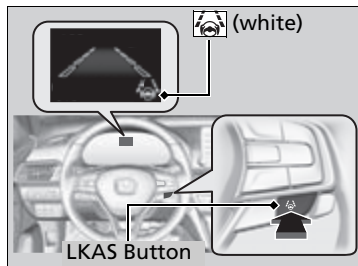

1. Press the LKAS button.

- ▶ The  indicator (white) and lane outlines appear on the driver information interface.

The system is activated.

▶▶ When the System can be Used

If the vehicle drifts toward either left or right lane line due to the system applying torque, turn off the LKAS and have your vehicle checked by a dealer.

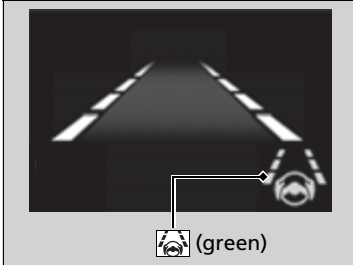

2. Keep your vehicle near the center of the lane while driving.
 - ▶ The  indicator changes from white to green and the lane outlines change to solid ones once the system starts operating after detecting the left and right lane markings.

■ To cancel

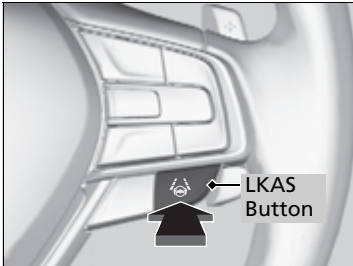

Press the LKAS button.

The LKAS is turned off every time you stop the engine, even if you turned it on the last time you drove the vehicle.



When the LKAS is suspended, the lane lines on the driver information interface change to lane outlines, and the beeper sounds (if activated).

■ **The system operation is suspended if you:**

- Set the wipers to high speed.
 - ▶ Turning the wipers off, setting it to **LO**, or the wipers are operating intermittently resumes the LKAS.
- Decrease the vehicle speed to about 40 mph (64 km/h) or less.
 - ▶ Increasing the vehicle speed to about 45 mph (72 km/h) or more resumes the LKAS.
- Depress the brake pedal.
 - ▶ The LKAS resumes and starts detecting the lane lines again once you release the brake pedal.
- Your vehicle is driving to the right or the left of the lane.

■ **The LKAS may be automatically suspended when:**

- The system fails to detect lane lines.
 - The steering wheel is quickly turned.
 - You fail to steer the vehicle.
 - Driving through a sharp curve.
 - Driving at a speed in excess of approximately 90 mph (145 km/h).
- Once these conditions no longer exist, the LKAS automatically resumes.

▶▶ The system operation is suspended if you:

You can change the setting for the LKAS. LKAS suspended beep ON and OFF can be selected.
▶ **Customized Features** P. 351

■ The LKAS may be automatically canceled when:

- The camera temperature gets extremely high or low.
- The camera behind the rearview mirror, or the area around the camera, including the windshield, gets dirty.
- The ABS or VSA® system engages.

The beeper sounds if the LKAS is automatically canceled.

■ LKAS Conditions and Limitations

The system may not detect lane markings and therefore may not keep the vehicle in the middle of the lane under certain conditions, including the following:

■ Environmental conditions

- Driving in bad weather (rain, fog, snow, etc.).
- Sudden changes between light and dark, such as an entrance or exit of a tunnel.
- There is little contrast between lane lines and the roadway surface.
- Driving into low sunlight (e.g., at dawn or dusk).
- Strong light is reflected onto the roadway.
- Driving in the shadows of trees, buildings, etc.
- Shadows of adjacent objects are parallel to lane markings.
- Roadway objects or structures are misinterpreted as lane markers.
- Reflections on the interior of the windshield.
- Driving at night or in a dark condition such as a tunnel.

■ Roadway conditions

- Driving on a snowy or wet roadway (obscured lane marking, vehicle tracks, reflected lights, road spray, high contrast).
- Driving on a road with temporary lane markings.
- Faint, multiple, or varied lane markings are visible on the roadway due to road repairs or old lane markings.

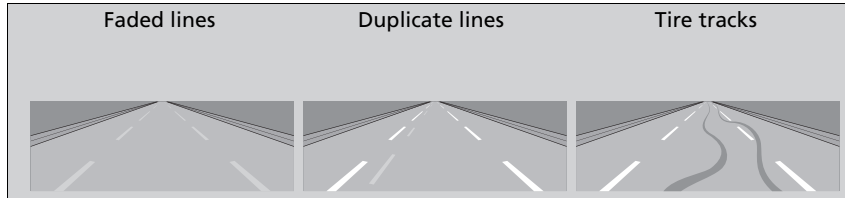

- The roadway has merging, split, or crossing lines (e.g., such as at an intersection or crosswalk).
- The lane markings are extremely narrow, wide, or changing.

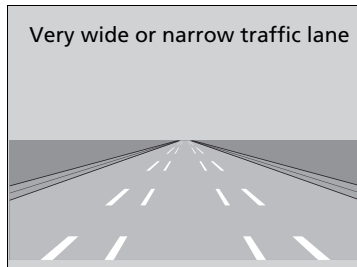

- The vehicle in front of you is driving near the lane lines.
- The road is hilly or the vehicle is approaching the crest of a hill.
- Driving on rough or unpaved roads, or over bumpy surfaces.

- When objects on the road (curb, guard rail, pylons, etc.) are recognized as white lines (or yellow lines).
- Driving on roads with double lines.

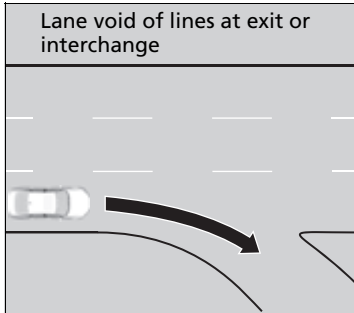

■ Vehicle conditions

- Headlight lenses are dirty or the headlights are not properly adjusted.
- The outside of the windshield is streaked or blocked by dirt, mud, leaves, wet snow, etc.
- The inside of the windshield is fogged.
- The camera temperature gets too high.
- An abnormal tire or wheel condition (incorrect sizes, varied sizes or construction, improperly inflated, compact spare tire, etc.).
- The vehicle is tilted due to a heavy load or suspension modifications.
- The vehicle is towing a trailer*.

* Not available on all models

Road Departure Mitigation (RDM) System

Alerts and helps to assist you when the system detects a possibility of your vehicle unintentionally crossing over detected lane markings and/or leaving the roadway altogether.

■ How the System Works

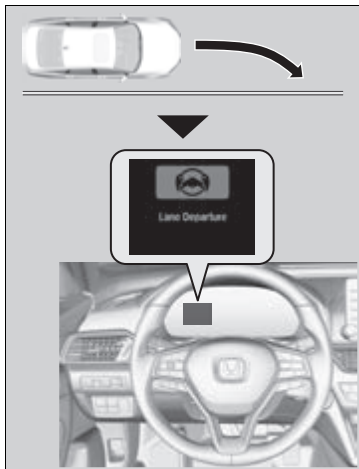

The front camera behind the rearview mirror monitors left and right lane markings (in white or yellow). If your vehicle is getting too close to detected lane markings without a turn signal activated, the system, in addition to a visual alert, applies steering torque and alerts you with rapid vibrations on the steering wheel, to help you remain within the detected lane.

▶ **Customized Features** P. 351

As a visual alert, the **Lane Departure** message appears on the driver information interface.

If the system determines that its steering input is insufficient to keep your vehicle on the roadway, it may apply braking.

▶ Braking is applied only when the lane markings are solid continuous lines.

The system cancels assisting operations when you turn the steering wheel to avoid crossing over detected lane markings.

If the system operates several times without detecting driver response, the system beeps to alert you.

▶▶ Road Departure Mitigation (RDM) System

Important Safety Reminder

Like all assistance systems, the RDM system has limitations.

Overreliance on the RDM system may result in a collision. It is always your responsibility to keep the vehicle within your driving lane.

The RDM system only alerts you when lane drift is detected without a turn signal in use. The RDM system may not detect all lane markings or lane or roadway departures; accuracy will vary based on weather, speed and lane marker condition. It is always your responsibility to safely operate the vehicle and avoid collisions.

You can read about handling information for the camera equipped with this system.

▶ **Front Sensor Camera** P. 504

The RDM system may not work properly or may work improperly under the certain conditions:

▶ **RDM Conditions and Limitations** P. 496

There are times when you may not notice RDM functions due to your operation of the vehicle, or road surface conditions.

In the following case, a beeper sounds, a message related to the ACC with Low Speed Follow appears on the driver information interface, and the braking function controlled by the RDM system is canceled.

- The vehicle has repeatedly applied the brakes to maintain the set speed (for example, you are descending a long slope).

How the System Activates

The system activates when all the following conditions are met:

- The vehicle is traveling between about 45 and 90 mph (72 and 145 km/h).
- The vehicle is on a straight or slightly curved road.
- The turn signals are off.
- The brake pedal is not depressed.
- The wipers are not in high speed operation.
- The system makes a determination that the driver is not actively accelerating, braking, or steering.

⌘ Road Departure Mitigation (RDM) System

If LKAS is off and you have selected **Narrow** from the customized options using the audio/information screen, the message below will appear in case the system determines a possibility of your vehicle crossing over detected lane markings.

➤ **Customized Features** P. 351



⌘ How the System Activates

The RDM system may automatically shut off and the safety support indicator (amber) comes and stays on.

➤ **Indicators** P. 82

RDM system function can be impacted when the vehicle is:

- Not driven within a traffic lane.
- Driven on the inside edge of a curve, or outside of a lane.
- Driven in a narrow lane.

RDM On and Off

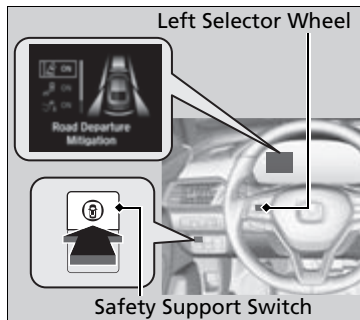

When you turn the RDM on and off, do the following.

1. Press the safety support switch.
2. Roll the left selector wheel to the  symbol and push it.

▶ A message appears on the driver information interface when the system turns on or off.

The RDM is in the previously selected **ON** or **OFF** setting each time you start the engine.

RDM Conditions and Limitations

The system may not properly detect lane markings and the position of your vehicle under certain conditions. Some examples of these conditions are listed below.

Environmental conditions

- Driving in bad weather (rain, fog, snow, etc.).
- Sudden changes between light and dark, such as an entrance or exit of a tunnel.
- There is little contrast between lane lines and the roadway surface.
- Driving into low sunlight (e.g., at dawn or dusk).
- Strong light is reflected onto the roadway.
- Driving in the shadows of trees, buildings, etc.
- Shadows of adjacent objects are parallel to lane markings.
- Roadway objects or structures are misinterpreted as lane markers.
- Reflections on the interior of the windshield.
- Driving at night or in a dark condition such as a tunnel.

RDM On and Off

When you have selected **Warning Only** from the customized options using the audio/information screen, the system does not operate the steering wheel and braking.

▶ **Customized Features** P. 351

The Vehicle Stability Assist™ (VSA®) system, Vehicle Stability Assist™ (VSA®) **OFF**, adaptive cruise control (ACC) with Low Speed Follow, safety support and low tire pressure/TPMS indicators may come on in amber along with a message in the driver information interface when you set the power mode to ON after reconnecting the battery. Drive a short distance at more than 12 mph (20 km/h). Each indicator should go off. If any do not, have your vehicle checked by a dealer.

■ Roadway conditions

- Driving on a snowy or wet roadway (obscured lane marking, vehicle tracks, reflected lights, road spray, high contrast).
- Driving on a road with temporary lane markings.
- Faint, multiple, or varied lane markings are visible on the roadway due to road repairs or old lane markings.
- The roadway has merging, split, or crossing lines (e.g., such as at an intersection or crosswalk).
- The lane markings are extremely narrow, wide, or changing.
- The vehicle in front of you is driving near the lane lines.
- The road is hilly or the vehicle is approaching the crest of a hill.
- Driving on rough or unpaved roads, or over bumpy surfaces.
- When objects on the road (curb, guard rail, pylons, etc.) are recognized as white (or yellow) lines.
- Driving on roads with double lines.

■ Vehicle conditions

- Headlight lenses are dirty or the headlights are not properly adjusted.
- The outside of the windshield is streaked or blocked by dirt, mud, leaves, wet snow, etc.
- The inside of the windshield is fogged.
- The camera temperature gets too high.
- An abnormal tire or wheel condition (incorrect sizes, varied sizes or construction, improperly inflated, compact spare tire, etc.).
- The vehicle is tilted due to a heavy load or suspension modifications.
- When tire chains* are installed.
- The vehicle is towing a trailer*.

* Not available on all models

Traffic Sign Recognition System

Reminds you of road sign information, such as the current speed limit, your vehicle has just passed through, showing it on the driver information interface and the head-up display*.

■ How the System Works

When the camera located behind the rearview mirror captures traffic signs while driving, the system displays the ones that are recognized as designated for your vehicle. The sign icon will be displayed until the vehicle reaches a predetermined time and distance.

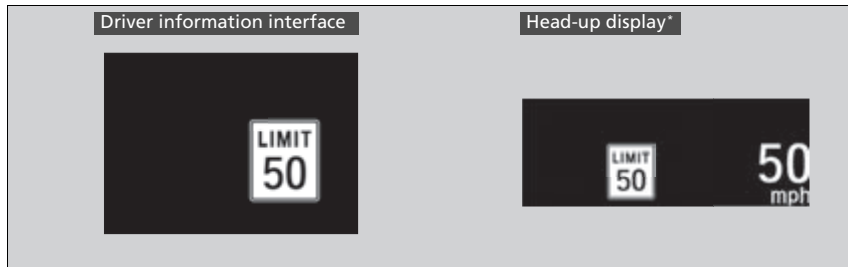

The sign icon also may switch to another one or disappear when:

- The other designated limit is detected.
- You make a turn with a turn signal at an intersection.

⚠ Traffic Sign Recognition System

Not all signs may be displayed, but any signs posted on roadsides should not be ignored. The system does not work on the designated traffic signs of all the countries you travel, nor in all situations. Do not rely too much on the system. Always drive at speeds appropriate for the road conditions.

Never apply a film or attach any objects to the windshield that could obstruct the camera's field of vision and cause the system to operate abnormally. Scratches, nicks, and other damage to the windshield within the camera's field of vision can cause the system to operate abnormally. If this occurs, we recommend that you replace the windshield with a genuine Honda replacement windshield. Making even minor repairs within the camera's field of vision or installing an aftermarket replacement windshield may also cause the system to operate abnormally. After replacing the windshield, have a dealer recalibrate the camera. Proper calibration of the camera is necessary for the system to operate properly.

If the system does not detect any traffic signs while you are driving, the image below may appear.

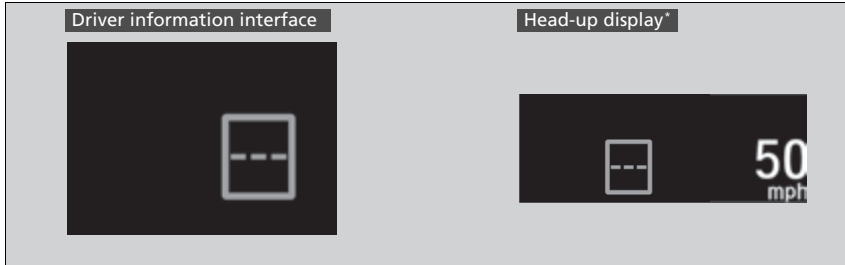

⌘ Traffic Sign Recognition System

To help reduce the likelihood that high interior temperatures will cause the camera's sensing system to shut off, when parking, find a shady area or face the front of the vehicle away from the sun. If you use a reflective sun shade, do not allow it to cover the camera housing.

Covering the camera can concentrate heat on it.

You can read about handling information for the camera equipped with this system.

➔ **Front Sensor Camera** P. 504

* Not available on all models

Continued

■ Traffic Sign Recognition System Conditions and Limitations

The traffic sign recognition system may not be able to recognize a traffic sign in the following cases.

■ Vehicle conditions

- Headlight lenses are dirty or the headlights are not properly adjusted.
- The outside of the windshield is blocked by dirt, mud, leaves, wet snow, etc.
- The inside of the windshield is fogged.
- There are portions remaining to be wiped.
- An abnormal tire or wheel condition (wrong sized, varied size or construction, improperly inflated, compact spare tire, etc.).
- The vehicle is tilted due to a heavy load or suspension modifications.

■ Environmental conditions

- Driving into low sunlight (e.g., at dawn or dusk).
- Strong light is reflected onto the roadway.
- Sudden changes between light and dark, such as an entrance or exit of a tunnel.
- When you drive in the shadows of trees, buildings, etc.
- Driving at night, in dark areas such as long tunnels.
- Driving in bad weather (rain, fog, snow, etc.).
- A vehicle in front of you is kicking up spray or snow.

▶▶ Traffic Sign Recognition System Conditions and Limitations

When the traffic sign recognition system malfunctions,  appears on the driver information interface. If this message does not disappear, have your vehicle checked by a dealer.

Driver information interface



Head-up display*



■ The position or the condition of the traffic sign

- A sign is hard to be found since it is in a complicated area.
- A sign is located far away from your vehicle.
- A sign is located where the beam of the headlight is hard to reach.
- A sign is on a corner or bend in the road.
- Faded or bent signs.
- Rotated or damaged signs.
- A sign is covered with mud, snow, or frost.
- A part of the sign is hidden by the trees, or the sign itself is hidden by a vehicle and others.
- Light (a streetlight) or a shadow is reflected on the surface of the sign.
- A sign is too bright or too dark (an electric sign).
- A sign of a small size.

■ Other conditions

- When you are driving at a high speed.

The traffic sign recognition system may not operate correctly, such as displaying a sign that does not follow the actual regulation for the roadway or does not exist at all in the following cases.

- ▶ A speed limit sign may display at a higher or lower speed than the actual speed limit.
- There is a supplementary sign with further information such as weather, time, vehicle type, school zone, etc.
- Figures on the sign are hard to read (electric signs, numbers on the sign are blurred etc.).
- A sign is in the vicinity of the lane you are driving in, even though it is not for the lane (speed limit sign situated at the junction between the side road and the main road, etc.).
- There are things that look similar to the color or shape of the recognition object (similar sign, electric sign, signboard, structure, etc.).
- A truck or another large vehicle with a sticker of the speed limit sign on the back is traveling in front of you.

■ Signs Displayed on the Driver information interface and Head-Up Display*

The speed limit sign icon is displayed on the right half of the screen.

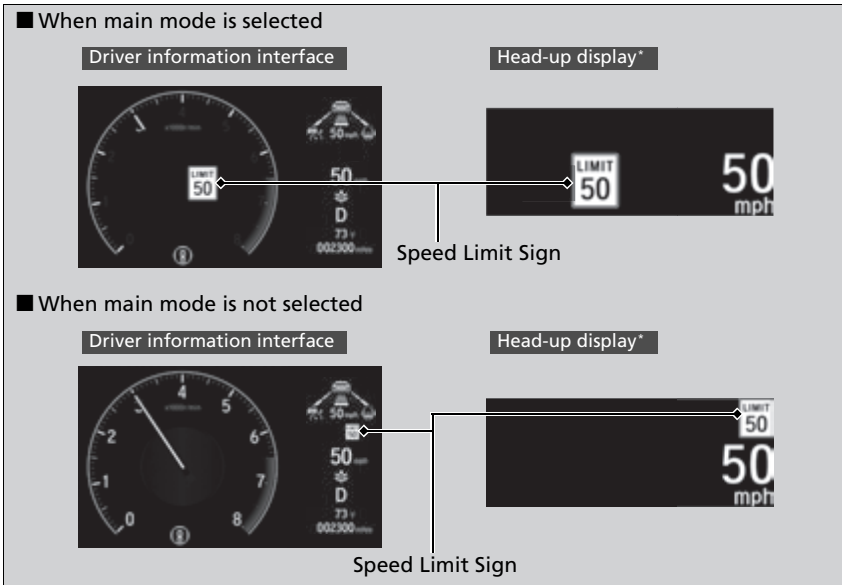

■ Selecting to display traffic signs when main mode is off

You can continue displaying a reduced-size traffic sign icon on the driver information interface and head-up display* even while the main mode is not selected.

🔧 **Customized Features** P. 351

* Not available on all models

Front Sensor Camera

The camera, used in systems such as Lane Keeping Assist System, Road Departure Mitigation system, Adaptive Cruise Control with Low Speed Follow, Collision Mitigation Braking System™ and traffic sign recognition system, is designed to detect an object that triggers any of the systems to operate their functions.

Camera Location and Handling Tips

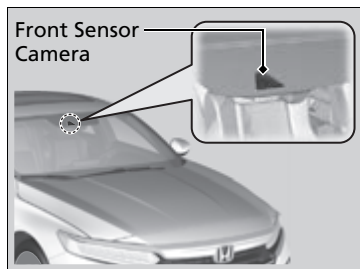

This camera is located behind the rearview mirror.

To help reduce the likelihood that high interior temperatures will cause the camera's sensing system to shut off, when parking, find a shady area or face the front of the vehicle away from the sun. If you use a reflective sun shade, do not allow it to cover the camera housing.

Covering the camera can concentrate heat on it.

Front Sensor Camera

Never apply a film or attach any objects to the windshield, the hood, or the front grille that could obstruct the camera's field of vision and cause the system to operate abnormally.

Scratches, nicks, and other damage to the windshield within the camera's field of vision can cause the system to operate abnormally. If this occurs, we recommend that you replace the windshield with a genuine Honda replacement windshield. Making even minor repairs within the camera's field of vision or installing an aftermarket replacement windshield may also cause the system to operate abnormally. After replacing the windshield, have a dealer recalibrate the camera. Proper calibration of the camera is necessary for the system to operate properly.

Do not place an object on the top of the instrument panel. It may reflect onto the windshield and prevent the system from detecting lane lines properly.

Front Sensor Camera

If the **Some Driver Assist Systems Cannot Operate: Camera Temperature Too High** message appears:

- Use the climate control system to cool down the interior and, if necessary, also use defroster mode with the airflow directed towards the camera.
- Start driving the vehicle to lower the windshield temperature, which cools down the area around the camera.

If the **Some Driver Assist Systems Cannot Operate: Clean Front Windshield** message appears:

- Park your vehicle in a safe place, and clean the windshield. If the message does not disappear after you have cleaned the windshield and driven for a while, have your vehicle checked by a dealer.

Radar Sensor

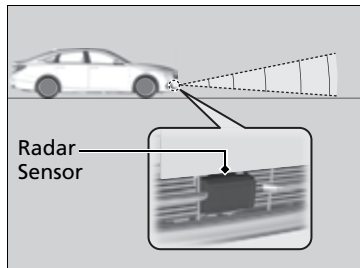

The radar sensor is at the lower part of the front bumper.

- Do not change the position of the radar sensor or any of the surrounding parts.
- Do not apply paint, stickers, or attach non-genuine accessories to the front part of the radar sensor or the surrounding area. Be particularly careful that any custom license plate frame or other accessory does not block any part of the radar beam path (see adjacent illustration).

▶▶ Radar Sensor

Avoid strong impacts to the radar sensor cover.

For the CMBS™ to work properly:

- Always keep the radar sensor cover clean.
- Never use chemical solvents or polishing powder for cleaning the sensor cover. Clean it with water or a mild detergent.
- Do not put a sticker on the radar sensor cover or replace the radar sensor cover.

If you need the radar sensor to be repaired, or removed, or the radar sensor cover is strongly impacted, turn off the system by using the safety support switch and take your vehicle to a dealer.

▶▶ **CMBS™ On and Off** P. 459

If the vehicle is involved in any of the following situations, the radar sensor may not work properly. Have your vehicle checked by a dealer:

- Your vehicle is involved in a frontal collision.
- Your vehicle drives through deep water or is submerged in deep water.
- Your vehicle strongly strikes a bump, curb, chock, or embankment that could jar the radar sensor.

Sonar Sensors*

■ Location and range of sensors

The sonar sensors are situated in the front and rear bumpers.

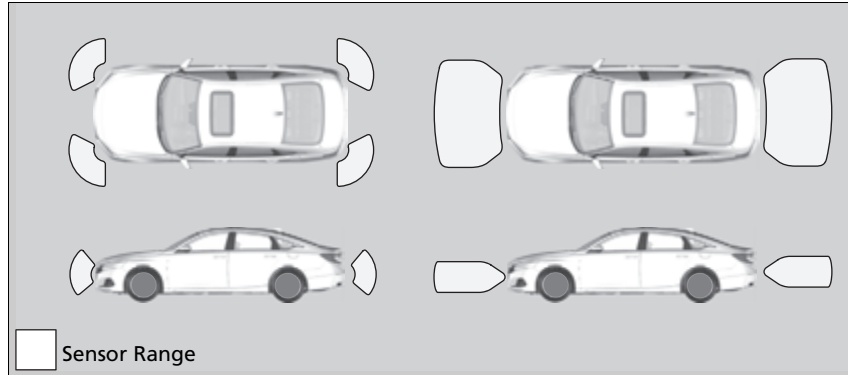
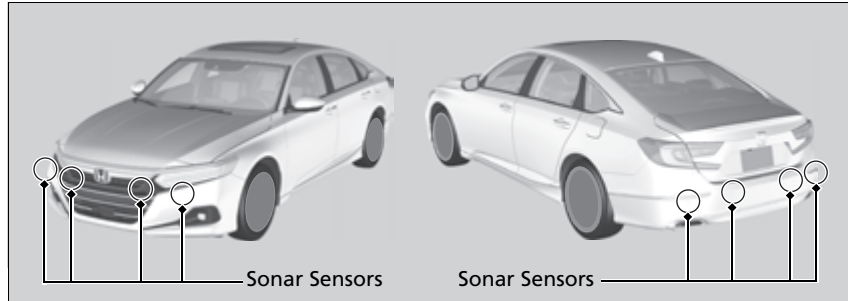

⊠ Sonar Sensors*

For the sonar sensors to work properly, do not:

- Place stickers or other objects on or around the sensors.
- Hit the area around the sensors.
- Attempt to take apart any sensor.
- Put any accessories on or around the sensors.

Consult with a dealer if:

- A sensor has been subjected to shock.
- Work needs to be done to the area around a sensor.

In the following cases, the sonar sensors may not work properly. Have your vehicle checked by a dealer.

- The front or rear bumper has made contact with a hill, parking block, curb, embankment, etc.
- The vehicle has been involved in frontal or rear collision.
- The vehicle has been driven through a deep puddle.

* Not available on all models

Brake System

■ Parking Brake

Use the parking brake to keep the vehicle stationary when parked. When the parking brake is applied, you can manually or automatically release it.



■ To apply

The electric parking brake can be applied any time the vehicle has battery, no matter which position the power mode is in.

Pull the electric parking brake switch up gently and securely.

- ▶ The indicator in the switch comes on.
- ▶ The parking brake and brake system indicator (red) comes on.

■ To release

The power mode must be in ON in order to release the electric parking brake.

1. Depress the brake pedal.
2. Press the electric parking brake switch.
 - ▶ The indicator in the switch goes off.
 - ▶ The parking brake and brake system indicator (red) goes off.

Manually releasing the parking brake using the switch helps your vehicle start slowly and smoothly when facing downhill on steep hills.

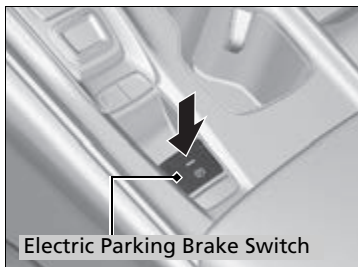

» Braking

When you depress the brake pedal, you may hear a whirring sound from the engine compartment. This is because the brake system is in operation, and it is normal.

» Parking Brake

You may hear the electric parking brake system motor operating from the rear wheel area when you apply or release the parking brake. This is normal.

The brake pedal may slightly move due to the electric parking brake system operation when you apply or release the parking brake. This is normal.

You cannot apply or release the parking brake if the battery goes dead.

▶ **If the Battery Is Dead** P. 606

If you pull up and hold the electric parking brake switch while driving, the brakes on all four wheels are applied by the VSA® system until the vehicle comes to a stop. The electric parking brake then applies, and the switch should be released.

▶▶ Parking Brake

In the following situations, the parking brake automatically operates.

- When the vehicle stops more than 10 minutes while ACC with Low Speed Follow is activated.
- When the driver's seat belt is unfastened while your vehicle is stopped automatically by ACC with Low Speed Follow.
- When the engine is turned off while ACC with Low Speed Follow is activated.
- When the vehicle stops with the automatic brake hold system activated for more than 10 minutes.
- When the driver's seat belt is unfastened while your vehicle is stopped and brake hold is applied.
- When the engine is turned off while brake hold is applied.
- When there is a problem with the automatic brake hold system while brake hold is applied.

1.5 L engine models

- When the engine is turned off, except by Auto Idle Stop system, while ACC with Low Speed Follow is activated.
- When the engine is turned off, except by Auto Idle Stop system, while brake hold system is applied.

■ Automatic parking brake feature operation

If the automatic parking brake feature has been activated:

- The parking brake is applied automatically when you set the power mode to VEHICLE OFF.
- To confirm that the parking brake is applied, check if the parking brake and brake system indicator (red) is on.

▶ **Activating and deactivating the automatic parking brake feature** P. 511

■ To release automatically

Depressing the accelerator pedal releases the parking brake.

Use the accelerator pedal to release the brake when you are starting the vehicle facing uphill, or in a traffic jam.

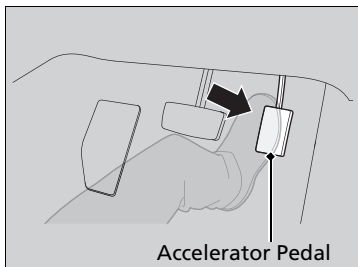

Gently depress the accelerator pedal.

When on a hill, it may require more accelerator input to release.

- ▶ The parking brake and brake system indicator (red) goes off.

You can release the parking brake automatically when:

- You are wearing the driver's seat belt.
- The engine is running.
- The transmission is not in **P** or **N**.

▶ Parking Brake

If the parking brake cannot be released automatically, release it manually.

When the vehicle is traveling uphill, the accelerator pedal may need to be pressed farther to automatically release the electric parking brake.

The parking brake cannot be released automatically while the following indicators are on:

- Malfunction indicator lamp
- Transmission system indicator

The parking brake may not be released automatically while the following indicators are on:

- Parking brake and brake system indicator
- VSA® system indicator
- **ABS** indicator
- Supplemental restraint system indicator

■ Activating and deactivating the automatic parking brake feature

With the power mode is in ON, carry out the following steps to either activate or deactivate the automatic parking brake feature.

1. Put the transmission into **P**.
2. Without depressing the brake pedal, pull up and release the electric parking brake switch.
 - ▶ Check that the parking brake and brake system indicator (red) has come on.
3. Pull up and hold the electric parking brake switch. When you hear a beeping sound, release the switch and within 3 seconds pull up and hold the switch again.
4. When you hear a sound indicating that the procedure is completed, release the switch.
 - ▶ Two beeps indicates that the feature has been activated.
 - ▶ One beep indicates that the feature has been deactivated.
 - ▶ When you have completed activating the feature, the parking brake will remain applied after you turn off the engine.
 - ▶ To confirm that the parking brake is applied, check if the parking brake and brake system indicator (red) is on.

Automatic transmission models

If you need to temporarily deactivate the feature while putting your vehicle through a conveyor type car wash, you can follow the procedure explained below.

1. Depress the brake pedal and bring the vehicle to a stop.
2. Set the power mode to VEHICLE OFF and then within 2 seconds push down the electric parking brake switch.
 - ▶ Activation and deactivation settings for the feature will not be affected.
 - ▶ Before temporarily deactivating the feature, make sure to first turn off both ACC with Low Speed Follow and the automatic brake hold system.
 - ▶ To confirm that the parking brake is applied, check if the parking brake and brake system indicator (red) is on.

☒ Parking Brake

In cold climates, the parking brake may freeze in place if applied.

When parking the vehicle, chock the wheels and make sure the automatic parking brake feature is deactivated.

Also, when putting your vehicle through a conveyor-type car wash or when having your vehicle towed, deactivate the automatic parking brake feature and leave the parking brake released.

■ Foot Brake

Your vehicle is equipped with disc brakes at all four wheels. The brake assist system increases the stopping force when you depress the brake pedal hard in an emergency situation. The anti-lock brake system (ABS) helps you retain steering control when braking very hard.

➤ **Brake Assist System** P. 517

➤ **Anti-lock Brake System (ABS)** P. 516

☒ Foot Brake

Check the brakes after driving through deep water, or if there is a buildup of road surface water. If necessary, dry the brakes by lightly depressing the pedal several times.

If you hear a continuous metallic friction sound when applying the brakes, this is caused by the brake wear indicator rubbing on the brake rotor and indicates that the brake pads need to be replaced. Have the vehicle checked by a dealer. If you hear only an occasional squeak or squeal when you initially apply the brake pedal, this may be normal and caused by high frequency vibration of the brake pads against the rotating brake disc.

Constantly using the brake pedal while going down a long hill builds up heat, which reduces the brake effectiveness. Apply engine braking by taking your foot off the accelerator pedal and downshifting to a lower gear/speed position.

Do not rest your foot on the brake pedal while driving, as it will lightly apply the brakes and cause them to lose effectiveness over time and reduce pad life. It will also confuse drivers behind you.

Whenever the brakes are activated by CMBS™ or another system that automatically controls braking, the brake pedal is depressed and released in accordance with braking function.

Automatic Brake Hold

Keeps the brake applied after releasing the brake pedal until the accelerator pedal is pressed. You can use this system while the vehicle is temporarily stopped, like at traffic lights and in heavy traffic.

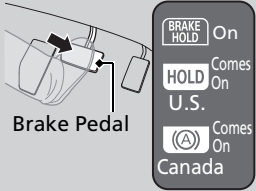
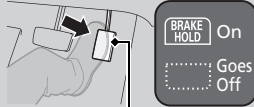
<p>■ Turning on the system</p>  <p>Automatic Brake Hold Button</p> <p>Fasten your seat belt properly, then start the engine. Press the automatic brake hold button.</p> <ul style="list-style-type: none"> • The automatic brake hold system indicator comes on. The system is turned on. 	<p>■ Activating the system</p>  <p>Brake Pedal</p> <p>Depress the brake pedal to come to a complete stop. The transmission must not be in P or R.</p> <ul style="list-style-type: none"> • The automatic brake hold indicator comes on. Braking is kept for up to 10 minutes. • Release the brake pedal after the automatic brake hold indicator comes on. 	<p>■ Canceling the system</p>  <p>Accelerator Pedal</p> <p>Depress the accelerator pedal while the transmission is in a position other than P or N. The system is canceled and the vehicle starts to move.</p> <ul style="list-style-type: none"> • The automatic brake hold indicator goes off. The system continues to be on.
---	---	---

Automatic Brake Hold

⚠ WARNING

Activating the automatic brake hold system on steep hills or slippery roads may still allow the vehicle to move if you remove your foot from the brake pedal.

If a vehicle unexpectedly moves, it may cause a crash resulting in serious injury or death.

Never activate the automatic brake hold system or rely on it to keep a vehicle from moving when stopped on a steep hill or slippery roads.

⚠ WARNING

Using the automatic brake hold system to park the vehicle may result in the vehicle unexpectedly moving.

If a vehicle moves unexpectedly, it may cause a crash, resulting in serious injury or death.

Never leave the vehicle when braking is temporarily kept by automatic brake hold and always park the vehicle by putting the transmission in **P** and applying the parking brake.

Continued

■ **The system automatically cancels when:**

- You engage the parking brake.
- You depress the brake pedal and put the transmission into **P** or **R**.

■ **The system automatically cancels and the parking brake is applied when:**

- Braking is kept for more than 10 minutes.
- The driver's seat belt is unfastened.
- The engine is turned off.
- There is a problem with automatic brake hold system.

►► Automatic Brake Hold

While the system is activated, you can turn off the engine or park the vehicle through the same procedure as you normally do.

► **When Stopped** P. 518

Whether the system is on, or the system is activated, the automatic brake hold turns off once the engine is off.

■ Turning off the automatic brake hold system

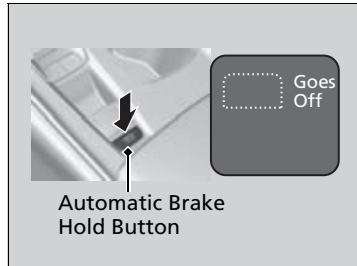

While the system is on, press the automatic brake hold button again.

- ▶ The automatic brake hold system indicator goes off.

If you want to turn off automatic brake hold while the system is in operation, press the automatic brake hold button with the brake pedal depressed.

☒ Turning on the system

Make sure to turn off the automatic brake hold system before using an automated car wash.

You may hear an operating noise if the vehicle moves while the automatic brake hold system is in operation.

Anti-lock Brake System (ABS)

■ ABS

Helps prevent the wheels from locking up, and helps you retain steering control by pumping the brakes rapidly, much faster than you can.

The electronic brake distribution (EBD) system, which is part of the ABS, also balances the front-to-rear braking distribution according to vehicle loading.

You should never pump the brake pedal. Let the ABS work for you by always keeping firm, steady pressure on the brake pedal. This is sometimes referred to as “stomp and steer.”

■ ABS operation

The brake pedal may pulsate slightly when the ABS is working. Depress the brake pedal and keep holding the pedal firmly down. On dry pavement, you will need to press on the brake pedal very hard before the ABS activates. However, you may feel the ABS activate immediately if you are trying to stop on snow or ice.

ABS may activate when you depress the brake pedal when driving on:

- Wet or snow covered roads.
- Roads paved with stone.
- Roads with uneven surfaces, such as potholes, cracks, manholes, etc.

When the vehicle speed goes under 6 mph (10 km/h), the ABS stops.

►► Anti-lock Brake System (ABS)

NOTICE

The ABS may not function correctly if you use a tire of the incorrect size or type.

If the ABS indicator comes on while driving, there may be a problem with the system. While normal braking will not be affected, there is a possibility that the ABS will not be operating. Have your vehicle checked by a dealer immediately.

The ABS is not designed for the purpose of reducing the time or distance it takes for a vehicle to stop: It is designed to limit brake lockup which can lead to skidding and loss of steering control.

In the following cases, your vehicle may need more distance to stop than a vehicle without the ABS:

- You are driving on rough or uneven road surfaces, such as gravel or snow.
- The tires are equipped with tire chains*.

The following may be observed with the ABS system:

- Motor sounds coming from the engine compartment when the brakes are applied, or when system checks are being performed after the engine has been started and while the vehicle accelerates.
- Brake pedal and/or the vehicle body vibration when ABS activates.

These vibrations and sounds are normal to ABS systems and are no cause for concern.

Brake Assist System

Designed to assist the driver by generating greater braking force when you depress the brake pedal hard during emergency braking.

■ Brake assist system operation

Press the brake pedal firmly for more powerful braking.

When brake assist operates, the pedal may wiggle slightly and an operating noise may be heard. This is normal. Keep holding the brake pedal firmly down.

When Stopped

1. Depress the brake pedal firmly.
2. With the brake pedal depressed, pull up the electric parking brake switch slowly, but fully.
3. Put the transmission into **P**.
4. Turn off the engine.
 - ▶ The parking brake and brake system indicator (red) goes off in about 30 seconds.

Always set the parking brake, in particular if you are parked on an incline.

▶ Parking Your Vehicle

WARNING

The vehicle can roll away if left unattended without confirming that Park is engaged.

A vehicle that rolls away could cause a crash resulting in serious injury or death.

Always keep your foot on the brake pedal until you have confirmed that **P** is shown on the shift position indicator.

Do not park your vehicle near flammable objects, such as dry grass, oil, or timber. Heat from the exhaust can cause a fire.

▶▶ When Stopped

NOTICE

The following can damage the transmission:

- Depressing the accelerator and brake pedals simultaneously.
- Holding the vehicle in place when facing uphill by depressing the accelerator pedal.
- Putting the transmission into **P** before the vehicle stops completely.

In extremely cold temperatures, the parking brake may freeze up if applied. If such temperatures are expected, do not apply the parking brake but, if parking on a slope, either turn the front wheels so they will contact the curb if the vehicle rolls down the slope or block the wheels to keep the vehicle from moving. If you do not take either precaution, the vehicle may roll unexpectedly, leading to a crash.

Parking Sensor System*

The corner and center sensors monitor obstacles around your vehicle, and the beeper, driver information interface and audio/information screen let you know the approximate distance between your vehicle and the obstacle.

■ The sensor location and range

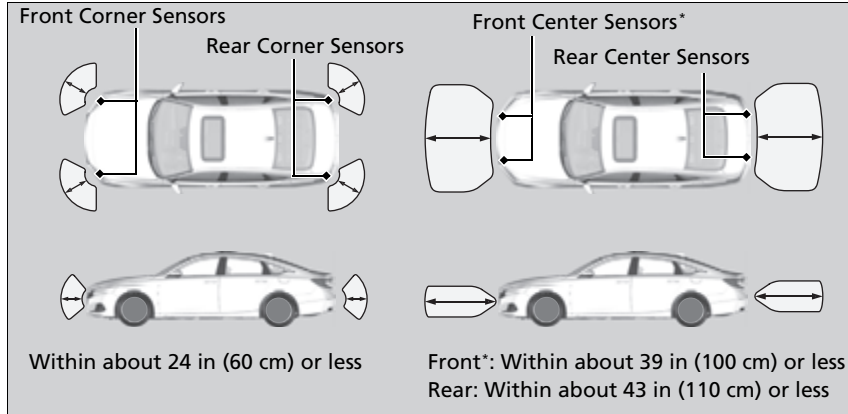

▶▶ Parking Sensor System*

Even when the system is on, always confirm if there is no obstacle near your vehicle before parking.

The system may not work properly when:

- The sensors are covered with snow, ice, mud, or dirt.
- The vehicle is on uneven surface, such as grass, bumps, or a hill.
- The vehicle has been out in hot or cold weather.
- The system is affected by devices that emit ultrasonic waves.
- Driving in bad weather.

The system may not sense:

- Thin or low objects.
- Sonic-absorptive materials, such as snow, cotton, or sponge.
- Objects directly under the bumper.

Do not put any accessories on or around the sensors.

■ Parking sensor system on and off

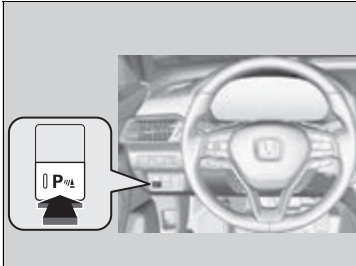

With the power mode in ON, press the parking sensor system button to turn on or off the system. The indicator in the button comes on when the system is on.

The front corner, rear corner and rear center sensors start to detect an obstacle when the transmission is in **[R]**, and the vehicle speed is less than 5 mph (8 km/h).

The front corner and front center* sensors start to detect an obstacle when the transmission is in any position other than **[P]** or **[R]**, and the vehicle speed is less than 5 mph (8 km/h).

⊠ Parking Sensor System*

When you set the power mode to ON, the system will be in the previously selected condition.

* Not available on all models

■ Screen Operation

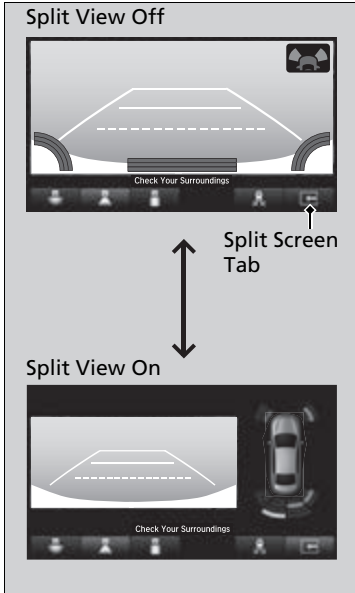



You can switch between split view off and split view on by touching the split screen tab.

▶▶ Screen Operation

The split screen tab disappears, and the split view returns to the last camera view mode under the following conditions:

- If the parking sensor system is turned off.
- If there is a malfunction in the system.

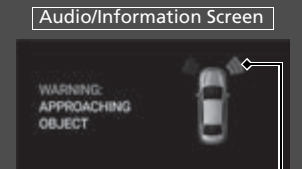
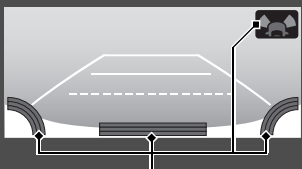
■ When the distance between your vehicle and detected obstacles becomes shorter

Interval between beeps	Distance between the Bumper and Obstacle		Indicator	Driver information interface/ Audio/Information Screen
	Corner Sensors	Center Sensors		
Moderate	—	Front*: About 39-24 in (100-60 cm) Rear: About 43-24 in (110-60 cm)	Comes on in Yellow* ¹	 <p>Audio/Information Screen</p> <p>WARNING: APPROACHING OBJECT</p> <p>Indicators light up where the sensor detects an obstacle.</p>  <p>Indicators light up where the sensor detects an obstacle.</p> <p>Driver information interface</p>  <p>WARNING: Approaching Object</p>
Short	About 24-18 in (60-45 cm)	About 24-18 in (60-45 cm)	Comes on in Amber	
Very short	About 18-14 in (45-35 cm)	About 18-14 in (45-35 cm)		
Continuous	About 14 in (35 cm) or less	About 14 in (35 cm) or less	Comes on in Red	

*1: At this stage, only the center sensors detect obstacles.

* Not available on all models

■ Turning off All Rear Sensors

1. Make sure that the parking sensor system is not activated. Set the power mode to VEHICLE OFF.
2. Press and hold the parking sensor system button, and set the power mode to ON.
3. Keep pressing the button for 10 seconds. Release the button when the indicator in the button flashes.
 - ▶ The beeper sounds once.
4. Press the button again. The indicator in the button goes off.
 - ▶ The beeper sounds twice. The rear sensors are now turned off.

To turn the rear sensors on again, follow the above procedure. The beeper sounds three times when the rear sensors come back on.

▶▶ Turning off All Rear Sensors

When you put the transmission into **[R]**, the indicator in the parking sensor system button blinks as a reminder that the rear sensors have been turned off.

Cross Traffic Monitor*

Monitors the rear corner areas using the radar sensors when reversing, and alerts you if a vehicle approaching from a rear corner is detected.

The system is convenient when you are backing out of a parking space.

ⓘ Cross Traffic Monitor*

⚠ CAUTION

Cross Traffic Monitor cannot detect all approaching vehicles and may not detect an approaching vehicle at all.

Failure to visually confirm that it is safe to back up the vehicle before doing so may result in a collision.

Do not solely rely on the system when reversing; always also use your mirrors, and look behind and to the sides of your vehicle before reversing.

Models with parking sensor system

The parking sensor system's alerting buzzer overrides the Cross Traffic Monitor buzzer when the sensors are detecting obstacles at the closest range.

* Not available on all models

■ How the System Works

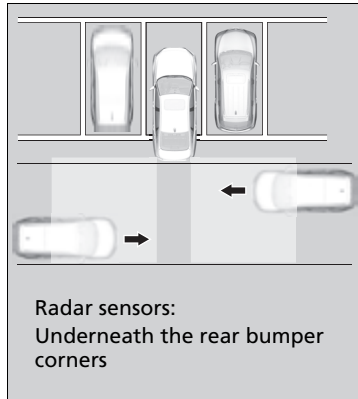

The system activates when:

- The power mode is in ON.
- The Cross Traffic Monitor is turned on.
 - ▶ **Cross Traffic Monitor On and Off** P. 528
- The transmission is in **R**.
- Your vehicle is moving at 3 mph (5 km/h) or lower.

When a vehicle is detected approaching from a rear corner, Cross Traffic Monitor alerts you with a buzzer and a displayed warning.

The system will not detect a vehicle that approaches from directly behind your vehicle, nor will it provide alerts about a detected vehicle when it moves directly behind your vehicle.

The system does not provide alerts for a vehicle that is moving away from your vehicle, and it may alert for pedestrians, bicycles, or stationary objects.

⊠ Cross Traffic Monitor*

Cross Traffic Monitor may not detect or may delay alerting an approaching vehicle, or may alert without an approaching vehicle under the following conditions:

- An obstacle, such as another vehicle and a wall, near your vehicle's rear bumper, is blocking the radar sensor's scope.
- Your vehicle is moving at the speed of about 3 mph (5 km/h) or higher.
- A vehicle is approaching at the speed other than between about 6 mph (10 km/h) and 16 mph (25 km/h).
- The system picks up external interference such as other radar sensors from another vehicle or strong radio wave transmitted from a facility nearby.
- Either corner of the rear bumper is covered with snow, ice, mud or dirt.
- When there is bad weather.
- Your vehicle is on an incline.
- Your vehicle is tilted due to a heavy load in the rear.
- Your vehicle is reversing towards a wall, a pole, a vehicle, and so on.

The rear bumper or the sensors have been improperly repaired or the rear bumper has been deformed. Have your vehicle checked by a dealer.

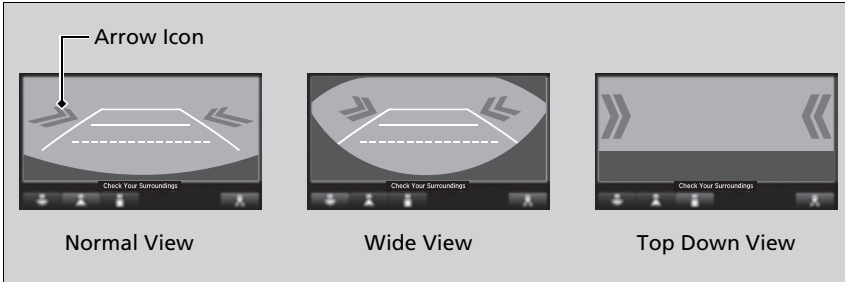

For proper operation, always keep the rear bumper corner area clean. Do not cover the rear bumper corner area with labels or stickers of any kind.

■ When the System Detects a Vehicle



An arrow icon appears on the side a vehicle is approaching on the audio/information screen.

▶▶ When the System Detects a Vehicle

If the  on the lower right changes to  in amber when the transmission is in **R**, mud, snow or ice, etc. may have accumulated in the vicinity of the sensor. The system is temporarily canceled. Check the bumper corners for any obstructions, and thoroughly clean the area if necessary.

If the  comes on when the transmission is in **R**, there may be a problem with the Cross Traffic Monitor system. Do not use the system and have your vehicle checked by a dealer.

If the display remains the same with the transmission in **R**, there may be a problem with the rear camera system and the Cross Traffic Monitor system. Do not use the system and have your vehicle checked by a dealer.

■ Cross Traffic Monitor On and Off

You can switch the system on and off using the audio/information screen.

➤ **Customized Features** P. 351

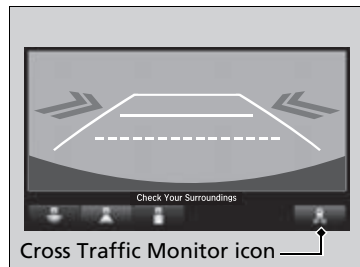

The system can also be turned on and off on the audio/information screen by pressing the Cross Traffic Monitor icon.

About Your Multi-View Rear Camera

The audio/information screen can display your vehicle's rear view. The display automatically changes to the rear view when the transmission is put into **R**.

Multi-View Rear Camera Display Area

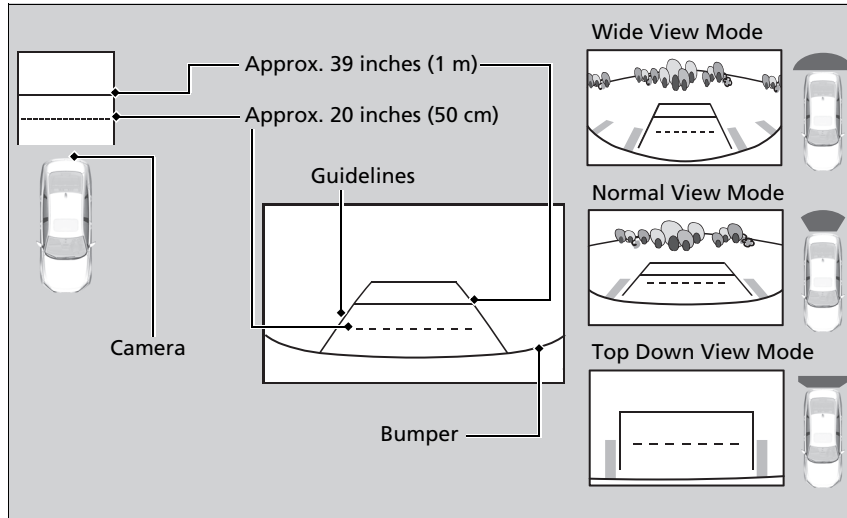

About Your Multi-View Rear Camera

The rear camera view is restricted. You cannot see the corner ends of the bumper or what is underneath the bumper. Its unique lens also makes objects appear closer or farther than they actually are.

Visually confirm that it is safe to drive before backing up. Certain conditions (such as weather, lighting, and high temperatures) may also restrict the rear view. Do not rely on the rearview display which does not give you all information about conditions at the back of your vehicle.

If the camera lens is covered with dirt or moisture, use a soft, moist cloth to keep the lens clean and free of debris.

You can change the **Fixed Guideline** and **Dynamic Guideline** settings.

➤ **Customized Features** P. 351

Fixed Guideline

ON: Guidelines appear when you put the transmission into **R**.

OFF: Guidelines do not appear.

Dynamic Guideline

ON: Guidelines move according to the steering wheel direction.

OFF: Guidelines do not move.

You can view three different camera modes on the audio/information screen.

Touch the appropriate icon to switch the mode.



: Wide view mode



: Normal view mode



: Top down view mode

- If you were last using Wide view mode or Normal view mode, the same view mode will be activated the next time you put the transmission into **[R]**.
- If you were using Top down view mode before turning off the engine, the next time you set the power mode to ON and put the transmission into **[R]**, the view mode you were using just before using Top down view mode (Wide view mode or Normal view mode) will be activated.
- If you were using Top down view mode and 10 seconds elapsed after you took the transmission out of **[R]**, the view mode you were using just before selecting Top down view mode (Wide view mode or Normal view mode) will be activated the next time you put the transmission into **[R]**.

Fuel Information

■ Fuel recommendation

Unleaded gasoline, pump octane number 87 or higher

Use of a lower octane gasoline can cause a persistent, heavy metallic knocking noise that can lead to engine damage.

■ Top tier detergent gasoline

Because the level of detergency and additives in gasoline vary in the market, Honda endorses the use of “TOP TIER Detergent Gasoline” where available to help maintain the performance and reliability of your vehicle. TOP TIER Detergent Gasoline meets a new gasoline standard jointly established by leading automotive manufacturers to meet the needs of today’s advanced engines.

Qualifying gasoline retailers will, in most cases, identify their gasoline as having met “TOP TIER Detergent Gasoline” standards at the retail location. This fuel is guaranteed to contain the proper level of detergent additives and be free of metallic additives. The proper level of detergent additives, and absence of harmful metallic additives in gasoline, help avoid buildup of deposits in your engine and emission control system.

For further important fuel-related information for your vehicle, or on information on gasoline that does not contain MMT, visit www.hondacars.com. In Canada, visit www.honda.ca for additional information on gasoline. For more information on top tier gasoline, visit www.toptiergas.com.

■ Fuel tank capacity: 14.8 US gal (56 L)

⌘ Fuel Information

NOTICE

We recommend quality gasoline containing detergent additives that help prevent fuel system and engine deposits. In addition, in order to maintain good performance, fuel economy, and emissions control, we strongly recommend the use of gasoline that does NOT contain harmful manganese-based fuel additives such as MMT, if such gasoline is available.

Use of gasoline with these additives may adversely affect performance, and cause the malfunction indicator lamp on your instrument panel to come on. If this happens, contact a dealer for service. Some gasoline today is blended with oxygenates such as ethanol. Your vehicle is designed to operate on oxygenated gasoline containing up to 15% ethanol by volume. Do not use gasoline containing methanol. If you notice any undesirable operating symptoms, try another service station or switch to another brand of gasoline.

How to Refuel

Your fuel tank is not equipped with a fuel filler cap. You can insert the filler nozzle directly into the filler neck. The tank seals itself again when you pull out the filler nozzle.

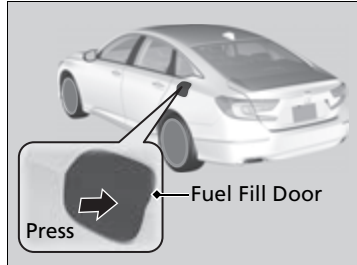

1. Stop your vehicle with the service station pump on the left side of the vehicle in the rear.
2. Turn off the engine.
3. Unlock the driver's door.
 - ▶ The fuel fill door on the outer side of the vehicle will unlock.
4. Press and release the area indicated by the arrow to release the fuel fill door. You will here a click and the lid will open slightly.
5. Manually pull the fuel fill door to a fully open position.

▶▶ How to Refuel

⚠ WARNING

Gasoline is highly flammable and explosive. You can be burned or seriously injured when handling fuel.

- Stop the engine, and keep heat, sparks, and flames away.
- Handle fuel only outdoors.
- Wipe up spills immediately.

The fuel filler opening is designed to accept only service station filler nozzles for refueling. Use of smaller diameter tubes (e.g., those used to siphon fuel for other uses) or other non-service station devices can damage the area in and around the filler opening.

Use the master door lock switch to unlock the fuel fill door.

The vehicle doors and fuel fill door automatically relock if the keyless remote unlock function is used. This can be deactivated by briefly opening then closing the driver's door.

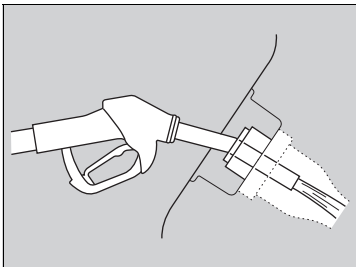

6. Place the end of the filler nozzle on the lower part of filler opening, then insert it slowly and fully.
 - ▶ Make sure that the end of the filler nozzle goes down along with the filler pipe.
 - ▶ Keep the filler nozzle level.
 - ▶ When the tank is full, the filler nozzle will click off automatically.
- 1.5 L engine models**
- ▶ If you do not fill up the tank to full, always add a minimum of 1.3 US gal (5 L) of fuel.
- All models**
- ▶ After filling, wait about five seconds before removing the filler nozzle.
7. Shut the fuel fill door by hand.

▶ How to Refuel

If the filler nozzle keeps turning off when the tank is not full, there may be a problem with the pump's fuel vapor recovery system. Try filling at another pump. If this does not fix the problem, consult a dealer.

The filler nozzle automatically stops to leave space in the fuel tank so that fuel does not overflow as a result of changes in air temperature.

Do not continue to add fuel after the filler nozzle has automatically stopped. Additional fuel can exceed the full tank capacity.

If you have to refuel your vehicle from a portable container, use the funnel provided with your vehicle.

▶ Refueling From a Portable Fuel Container P. 630

1.5 L engine models

If you repeatedly fill the tank with less than the specified minimum amount of fuel, the malfunction indicator lamp may come on. If this happens, have your vehicle checked by a dealer.

Improving Fuel Economy and Reducing CO₂ Emissions

Achieving fuel economy and reducing CO₂ emissions is dependent on several factors, including driving conditions, load weight, idling time, driving habits, and vehicle condition. Depending on these and other factors, you may not achieve the rated fuel economy of this vehicle.

Maintenance and Fuel Economy

You can optimize your fuel economy with proper maintenance of your vehicle. Always maintain your vehicle in accordance with the messages displayed on the driver information interface.

- Use engine oil with the viscosity recommended.
 - ▣ **Recommended Engine Oil** P. 551
- Maintain the specified tire pressure.
- Do not load the vehicle with excess cargo.
- Keep your vehicle clean. A buildup of snow or mud on your vehicle's underside adds weight and increases wind resistance.

Improving Fuel Economy and Reducing CO₂ Emissions

Direct calculation is the recommended method to determine actual fuel consumed while driving.

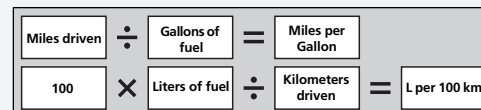

In Canada, posted fuel economy numbers are established following a simulated test. For more information on how this test is performed, please visit <https://www.nrcan.gc.ca> and search for “fuel consumption testing” in the search field at the top of the page.

Handling Precautions

The turbocharger is a high-precision device to obtain greater horsepower by delivering a large volume of compressed air into the engine using a turbine driven by the engine's exhaust gas pressure.

- When the engine is cold just after starting, avoid revving the engine or sudden acceleration.
- Always replace the engine oil and engine oil filter according to the Maintenance Minder™. The turbine rotates at very high speeds over 100,000 rpm and its temperature reaches over 1,292°F (700°C). It is lubricated and cooled by engine oil. If you fail to replace the engine oil and filter at the scheduled distance or interval, deteriorated engine oil may cause failure such as sticking and abnormal noise of the turbine bearing.

☒ Turbo Engine Vehicle

The scheduled maintenance intervals for replacing the filter is indicated on the driver information interface. Follow the information on replacement timing.

☒ **Maintenance Minder™** P. 541

The temperature gauge pointer is at the **H** mark when you restart the engine after driving under high load conditions such as at high speed or in hilly terrain. This is normal. The gauge goes down after you idle or drive the vehicle for about one minute.

This page intentionally left blank.

Maintenance

This chapter discusses basic maintenance.



Before Performing Maintenance

Inspection and Maintenance	538
Safety When Performing Maintenance.....	539
Parts and Fluids Used in Maintenance	
Service	540

Maintenance Minder™

.....	541
-------	-----

Maintenance Under the Hood

Maintenance Items Under the Hood.....	548
Opening the Hood	550
Recommended Engine Oil	551
Oil Check	552
Adding Engine Oil	554
Changing the Engine Oil and Oil Filter	555

Engine Coolant	559
Transmission Fluid	561
Brake Fluid	562
Refilling Window Washer Fluid.....	563

Replacing Light Bulbs

Checking and Maintaining Wiper

Blades

Checking and Maintaining Tires

Checking Tires	575
Tire and Loading Information Label.....	576
Tire Labeling	576
DOT Tire Quality Grading (U.S. Vehicles).....	578
Wear Indicators.....	580

Tire Service Life	580
Tire and Wheel Replacement	581
Tire Rotation	582
Winter Tires	583
Battery	584

Remote Transmitter Care

Replacing the Remote Battery	586
------------------------------------	-----

Climate Control System Maintenance

Cleaning

Interior Care	588
Exterior Care.....	590

Accessories and Modifications

Inspection and Maintenance

For your safety, perform all listed inspections and maintenance to keep your vehicle in good condition. If you become aware of any abnormality (noise, smell, insufficient brake fluid, oil residue on the ground, etc.), have your vehicle inspected by a dealer. (Note, however, that service at a dealer is not mandatory to keep your warranties in effect.)

Types of Inspection and Maintenance

■ Routine inspections

Perform inspections before long distance trips, when washing the vehicle, or when refueling.

➤ **Maintenance** P. 28

■ Periodic inspections

- Check the brake fluid level monthly.
 - **Brake Fluid** P. 562
- Check the tire pressure monthly. Examine the tread for wear and foreign objects.
 - **Checking and Maintaining Tires** P. 575
- Check the operation of the exterior lights monthly.
 - **Replacing Light Bulbs** P. 564
- Check the condition of the wiper blades at least every six months.
 - **Checking and Maintaining Wiper Blades** P. 572

» Inspection and Maintenance

U.S. models

Maintenance, replacement, or repair of emissions control devices and systems may be done by any automotive repair establishment or individuals using parts that are “certified” to EPA standards.

According to state and federal regulations, failure to perform maintenance on the maintenance main items marked with # will not void your emissions warranties. However, all maintenance services should be performed in accordance with the intervals indicated by the driver information interface.

➤ **Maintenance Service Items** P. 545

If you want to perform complex maintenance tasks that require more skills and tools, you can purchase a subscription to the Service Express website at www.techinfo.honda.com.

➤ **Authorized Manuals** P. 644

If you want to perform maintenance yourself, make sure that you have the necessary tools and skills first. After performing maintenance, update the records in the separate maintenance booklet.

Safety When Performing Maintenance

Some of the most important safety precautions are given here. However, we cannot warn you of every conceivable hazard that can arise in performing maintenance. Only you can decide whether you should perform a given task.

Maintenance Safety

- To reduce the possibility of fire or explosion, keep cigarettes, sparks, and flames away from the battery and all fuel related parts.
- Never leave rags, towels, or other flammable objects under the hood.
 - ▶ Heat from the engine and exhaust can ignite them, causing a fire.
- To clean parts, use a commercially available degreaser or parts cleaner, not gasoline.
- Wear eye protection and protective clothing when working with the battery or compressed air.
- Engine exhaust contains carbon monoxide, which is poisonous and can kill you.
 - ▶ Only operate the engine if there is sufficient ventilation.

Vehicle Safety

- The vehicle must be in a stationary condition.
 - ▶ Make sure your vehicle is parked on level ground, the parking brake is set, and the engine is off.
- Be aware that hot parts can burn you.
 - ▶ Make sure to let the engine and exhaust system cool thoroughly before touching vehicle parts.
- Be aware that moving parts can injure you.
 - ▶ Do not start the engine unless instructed, and keep your hands and limbs away from moving parts.

Models with Auto Idle Stop

- ▶ Do not open the hood while the Auto Idle Stop function is activated.

⚠ Safety When Performing Maintenance

⚠ WARNING

Improperly maintaining this vehicle or failing to correct a problem before driving can cause a crash in which you can be seriously hurt or killed.

Always follow the inspection and maintenance recommendations according to the schedules in this owner's manual.

⚠ WARNING

Failure to properly follow maintenance instructions and precautions can cause you to be seriously hurt or killed.

Always follow the procedures and precautions in this owner's manual.

Parts and Fluids Used in Maintenance Service

The use of Honda genuine parts and fluids is recommended when maintaining and servicing your vehicle. Honda genuine parts are manufactured according to the same high quality standards used in Honda vehicles.

▶▶ Parts and Fluids Used in Maintenance Service

2.0 L engine models

Do not press the engine cover forcibly. This may damage the engine cover and component parts.



If the engine oil life is less than 15%, you will see the Maintenance Minder messages appear on the driver information interface every time you set the power mode to ON. The messages notify you when to change the engine oil, or when to bring your vehicle to a dealer for indicated maintenance services.

To Use Maintenance Minder™

■ Displaying the Maintenance Minder Information

Maintenance items, which should be serviced at the same time that you replace the engine oil, appear on the driver information interface.

You can view them on the engine oil life screen at any time.

1. Set the power mode to ON.
2. Press the  (home) button.
3. Roll the left selector wheel until  is displayed.
4. Press the left selector wheel to go to the **Maintenance Minder** screen. The engine oil life appears on the driver information interface along with maintenance items due soon.

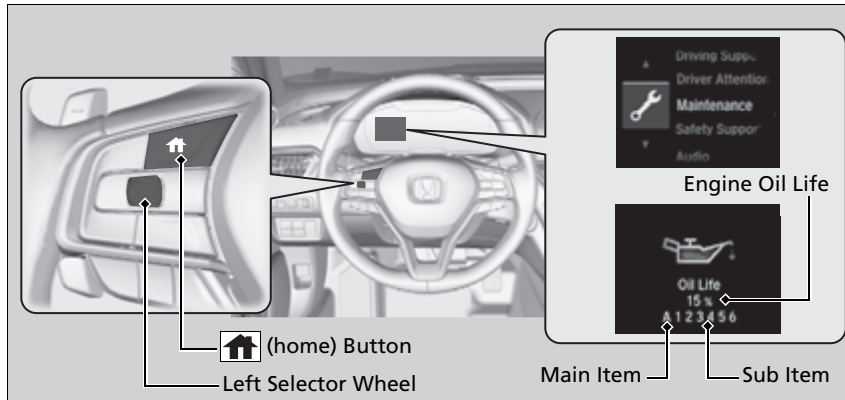

►► Displaying the Maintenance Minder Information



Based on the engine operating conditions, the remaining engine oil life is calculated and displayed as a percentage.



Displayed Engine Oil Life (%)	Calculated Engine Oil Life (%)
100	100 to 91
90	90 to 81
80	80 to 71
70	70 to 61
60	60 to 51
50	50 to 41
40	40 to 31
30	30 to 21
20	20 to 16
15	15 to 11
10	10 to 6
5	5 to 1
0	0

There is a list of maintenance main and sub items you can view on the driver information interface.

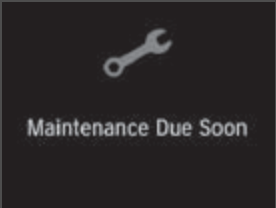
► **Maintenance Service Items** P. 545

Maintenance Minder Messages on the Driver Information Interface

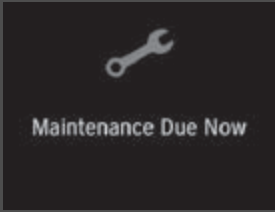
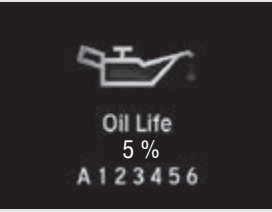
Maintenance Message	Oil Life Display	Explanation	Information
-	 <p>Oil Life 100 % A 1 2 3 4 5 6</p>	When you select the Maintenance Minder screen, it displays codes for maintenance items due at the next engine oil change, along with the percentage of engine oil life remaining.	-
 <p>Maintenance Due Soon</p>	<p>15 %</p>  <p>Oil Life 15 % A 1 2 3 4 5 6</p>	The engine oil life indicator starts to appear along with other due-soon maintenance item codes when the remaining oil life drops to 15 percent.	The engine oil is approaching the end of its service life.

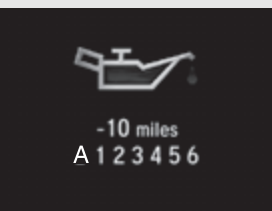
Maintenance Message	Oil Life Display	Explanation	Information
<p>Maintenance Due Now</p> 	<p>5 %</p> 	<p>The remaining engine oil life is 5 to 1 percent. Press the  (home) button to switch to another display.</p>	<p>The engine oil has almost reached the end of its service life, and the maintenance items should be inspected and serviced as soon as possible.</p>
<p>Maintenance Past Due</p> 	<p>Negative Distance</p> 	<p>The engine oil has passed its service life, and a negative distance appears after driving over 10 miles (U.S. models) or 10 km (Canadian models). The negative distance on the display blinks.</p>	<p>The engine oil life has passed. The maintenance items must be inspected and serviced immediately.</p>

The system message indicator (④) comes on along with the Maintenance Minder message.

Maintenance Service Items

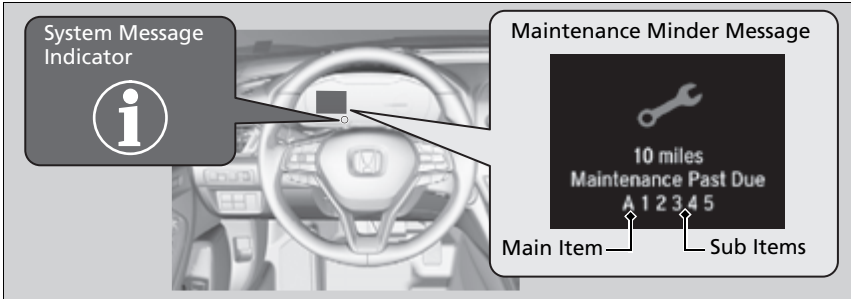

✕ Maintenance Service Items

- Adjust the valves during services A, B, 1, 2, or 3 if they are noisy.

U.S. models

CODE	Maintenance Main Items
A	<ul style="list-style-type: none"> • Replace engine oil*1
B	<ul style="list-style-type: none"> • Replace engine oil*1 and oil filter • Inspect front and rear brakes • Inspect tie rod ends, steering gearbox, and boots • Inspect suspension components • Inspect driveshaft boots • Inspect brake hoses and lines (Including ABS/VSA®) • Inspect all fluid levels and condition of fluids • Inspect exhaust system# • Inspect fuel lines and connections#

*1: If a Maintenance Minder message does not appear more than 12 months after the display is reset, change the engine oil every year.

#: See information on maintenance and emissions warranty in the first column on page 641.

*2: If you drive in dusty conditions, replace the air cleaner element every 15,000 miles (24,000 km).

*3: If you drive primarily in urban areas that have high concentrations of soot in the air from industry and from diesel-powered vehicles, replace the dust and pollen filter every 15,000 miles (24,000 km).

CODE	Maintenance Sub Items
1	<ul style="list-style-type: none"> • Rotate tires
2	<ul style="list-style-type: none"> • Replace air cleaner element*2 • Replace dust and pollen filter*3 • Inspect drive belt
3	<ul style="list-style-type: none"> • Replace transmission fluid*4
4	<ul style="list-style-type: none"> • Replace spark plugs • Inspect valve clearance
5	<ul style="list-style-type: none"> • Replace engine coolant
7	<ul style="list-style-type: none"> • Replace brake fluid*5

*4: Continuously variable transmission models

Driving in mountainous areas at very low vehicle speeds results in higher transmission temperatures. This requires transmission fluid changes more frequently than recommended by the Maintenance Minder. If you regularly drive your vehicle under these conditions, have the transmission fluid changed every 25,000 miles (40,000 km).

*5: If a Maintenance Minder message does not appear more than 36 months after the display for item 7 is reset, change the brake fluid every 3 years.

Continued

►► Maintenance Service Items

- Adjust the valves during services A, 0, 9, 1, 2, or 3 if they are noisy.

Canadian models

CODE	Maintenance Main Items
A	• Replace engine oil* ¹
0	• Replace engine oil* ¹ and oil filter



- *1: If a Maintenance Minder Message does not appear more than 12 months after the display is reset, change the engine oil every year.
- *2: If you drive in dusty conditions, replace the air cleaner element every 15,000 miles (24,000 km).
- *3: If you drive primarily in urban areas that have high concentrations of soot in the air from industry and from diesel-powered vehicles, replace the dust and pollen filter every 15,000 miles (24,000 km).
- *4: **Continuously variable transmission models**
Driving in mountainous areas at very low vehicle speeds results in higher transmission temperatures. This requires transmission fluid changes more frequently than recommended by the Maintenance Minder. If you regularly drive your vehicle under these conditions, have the transmission fluid changed every 25,000 miles (40,000 km).
- *5: If a Maintenance Minder Message does not appear more than 36 months after the display for item 7 is reset, change the brake fluid every 3 years.
- #: See information on maintenance and emissions warranty in the first column on page 641.

CODE	Maintenance Sub Items
1	• Rotate tires
2	• Replace air cleaner element* ² • Replace dust and pollen filter* ³ • Inspect drive belt
3	• Replace transmission fluid* ⁴
4	• Replace spark plugs • Inspect valve clearance
5	• Replace engine coolant
7	• Replace brake fluid* ⁵
9	• Service front and rear brakes • Inspect tie rod ends, steering gearbox, and boots • Inspect suspension components • Inspect driveshaft boots • Inspect brake hoses and lines (including ABS/VSA®) • Inspect all fluid levels and condition of fluids • Inspect exhaust system # • Inspect fuel lines and connections #

■ Resetting the Display

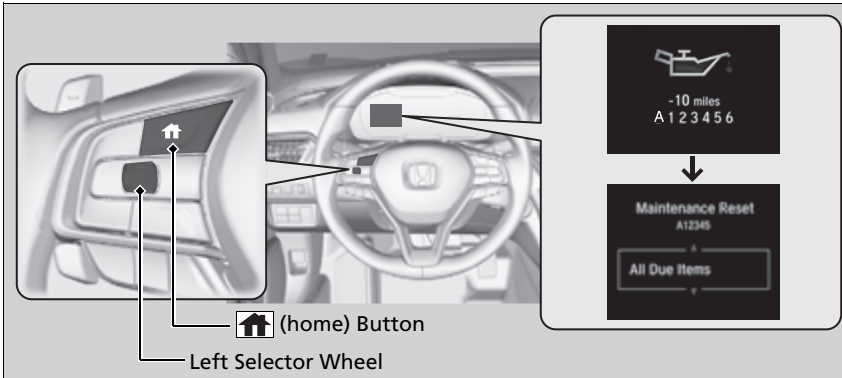
Reset the maintenance minder information display if you have performed the maintenance service.



1. Set the power mode to ON.
2. Press the  (home) button.
3. Roll the left selector wheel until  is displayed.
4. Press the left selector wheel to go to the **Maintenance Minder** screen.
5. Press the left selector wheel to enter the reset mode.
6. Roll the left selector wheel select a maintenance item to reset, or to select **All Due Items** (You can also select **Cancel** to end the process).
7. Press the left selector wheel to reset the selected item.
8. Repeat from step 5 for other items you wish to reset.

⌘ Resetting the Display

NOTICE

Failure to reset the Maintenance Minder™ display after a maintenance service results in the system showing incorrect maintenance intervals, which can lead to serious mechanical problems.

The dealer will reset the Maintenance Minder™ display after completing the required maintenance service. If someone other than a dealer performs maintenance service, reset the Maintenance Minder™ display yourself.

You can also reset the Maintenance Minder™ display using the audio/information screen.

► **Customized Features** P. 351

Maintenance Items Under the Hood

1.5 L engine models

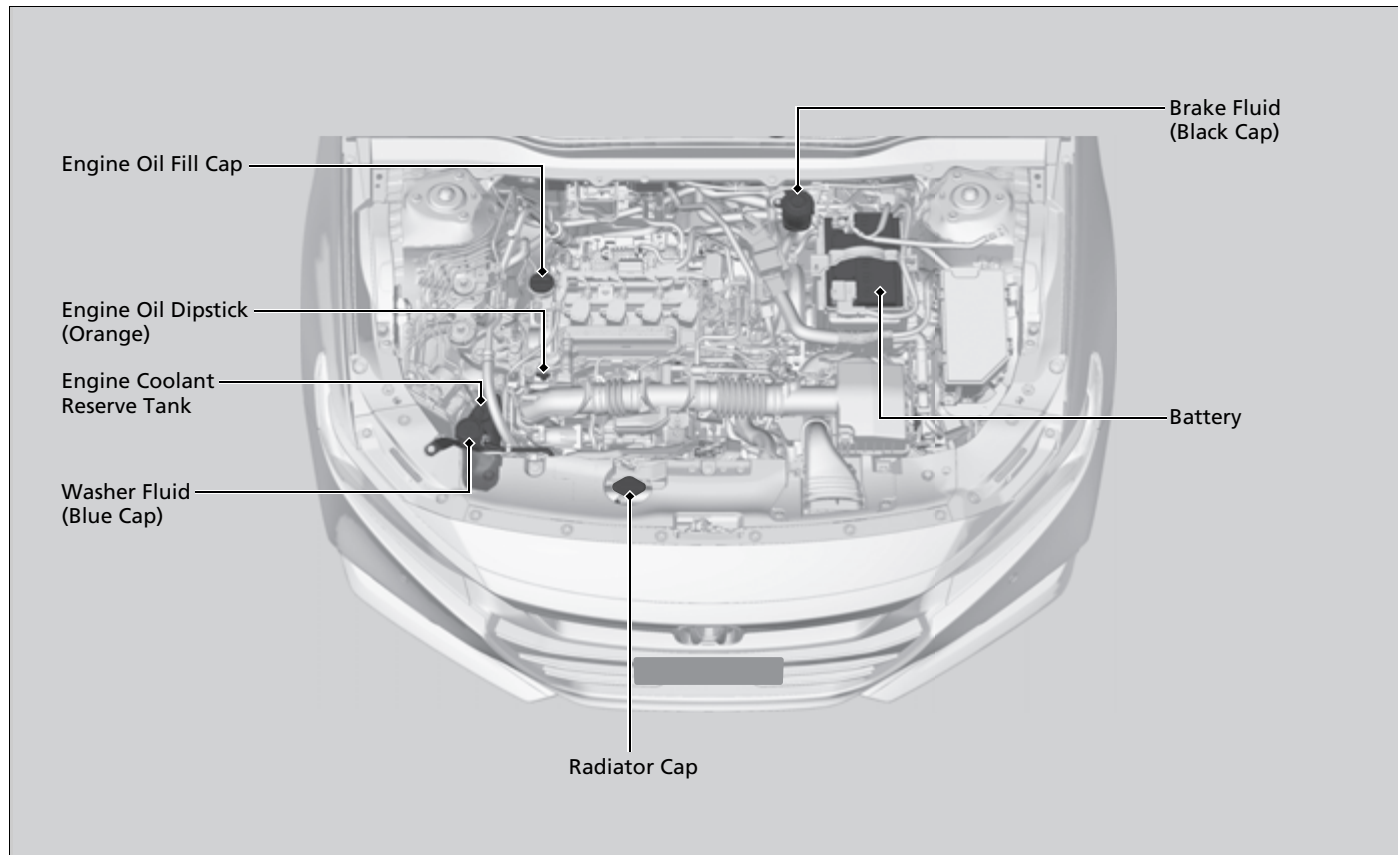

2.0 L engine models

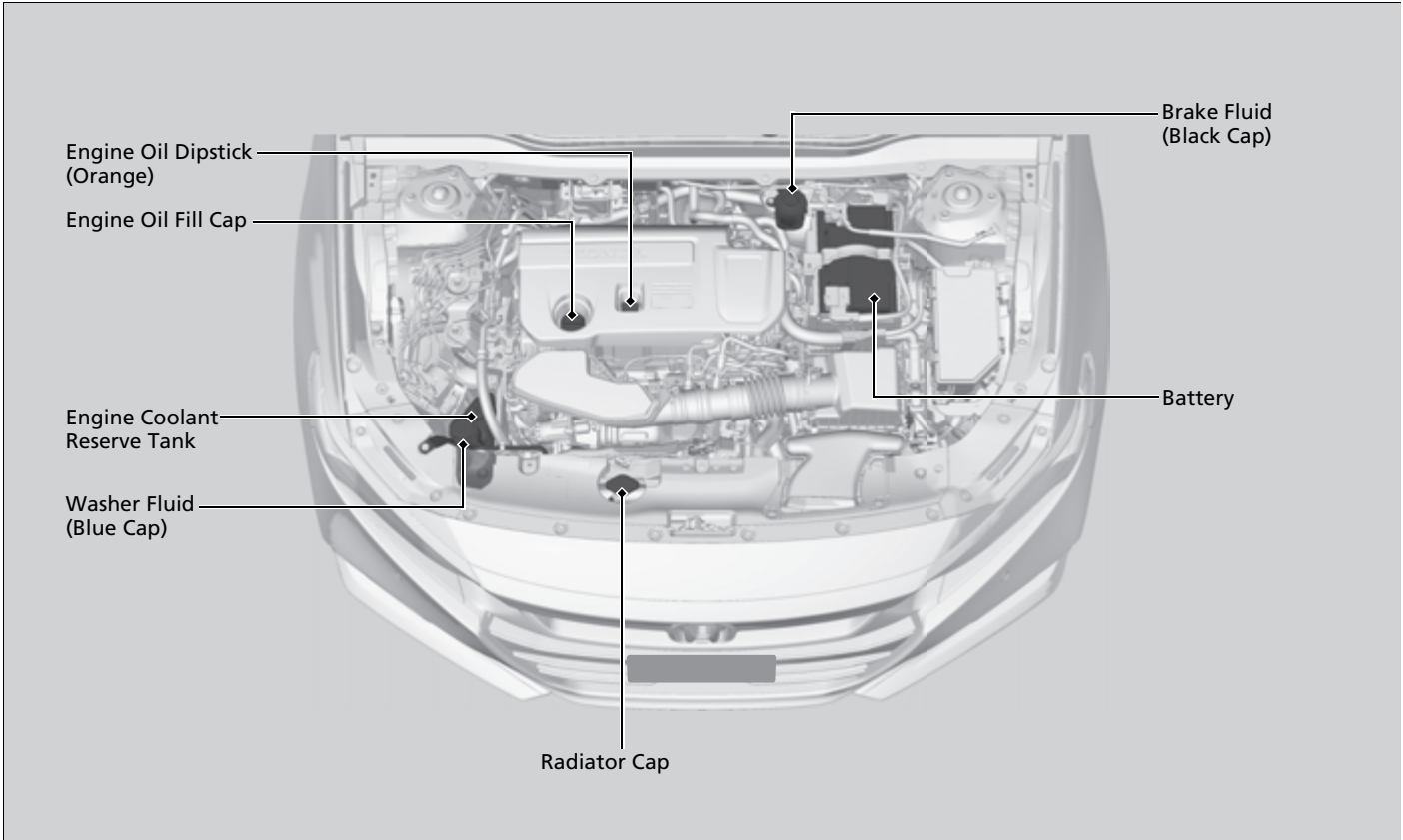

Opening the Hood

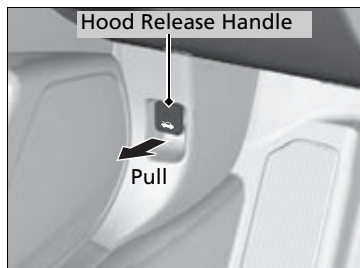

1. Park the vehicle on a level surface, and set the parking brake.
2. Pull the hood release handle under the driver's side lower corner of the dashboard.
 - The hood will pop up slightly.

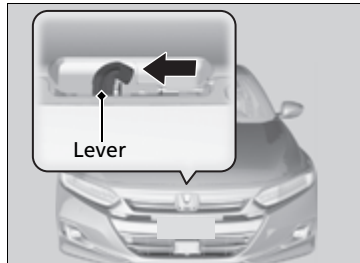

3. Push the hood latch lever (located under the front edge of the hood to the center) to the side and raise the hood. Once you have raised the hood slightly, you can release the lever.

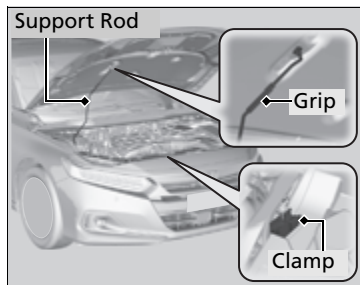

4. Remove the support rod from the clamp using the grip. Mount the support rod in the hood.

When closing, remove the support rod, and stow it in the clamp, then gently lower the hood. Remove your hand at a height of approximately 12 inches (30 cm) and let the hood close.

►► Opening the Hood

⚠ WARNING

The hood support rod can become very hot due to heat from the engine.

To ensure against possible burns, do not handle the metal section of the rod: Use the foam grip instead.

NOTICE

Do not open the hood when the wiper arms are raised.

The hood will strike the wipers, resulting in possible damage to the hood and/or the wipers.

2.0 L engine models

Do not press the engine cover forcibly. This may damage the engine cover and component parts.

When closing the hood, check that the hood is securely latched.

If the hood latch lever moves stiffly, or if you can open the hood without lifting the lever, the latch mechanism should be cleaned and lubricated.

Models with Auto Idle Stop

Do not open the hood while the Auto Idle Stop function is activated.

Recommended Engine Oil

- **Honda Genuine Motor Oil**
- **Premium-grade 0W-20 detergent oil with an API Certification Seal on the container.**



Oil is a major contributor to your engine's performance and longevity. If you drive the vehicle with insufficient or deteriorated oil, the engine may fail or be damaged.

This seal indicates the oil is energy conserving and that it meets the American Petroleum Institute's latest requirements.

Use Honda Genuine Motor Oil or another commercial engine oil of suitable viscosity for the ambient temperature as shown.

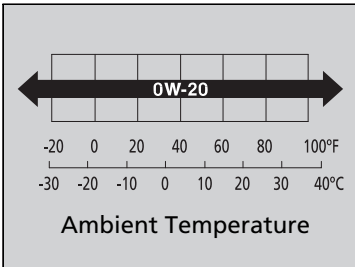

■ Synthetic oil

You may also use synthetic motor oil if it is labeled with the API Certification Seal and is the specified viscosity grade.

►► Recommended Engine Oil

Engine Oil Additives

Your vehicle does not require oil additives. In fact, they may adversely affect the engine performance and durability.

Oil Check

We recommend that you check the engine oil level every time you refuel.

Park the vehicle on level ground.

Wait approximately three minutes after turning the engine off before you check the oil.

1.5 L engine models

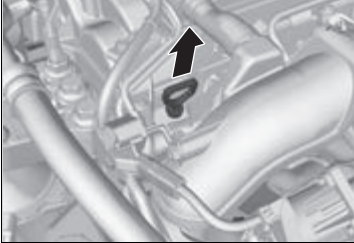

2.0 L engine models



1. Remove the dipstick (orange).
2. Wipe the dipstick with a clean cloth or paper towel.
3. Insert the dipstick back all the way into its hole.

Oil Check

If the oil level is near or below the lower mark, slowly add oil, being careful not to overfill.

1.5 L engine models

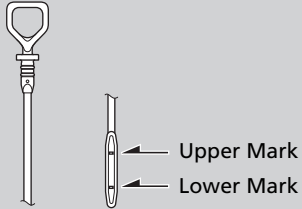

2.0 L engine models

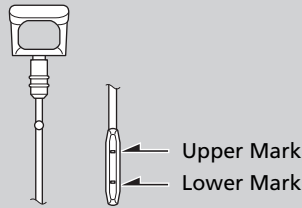

4. Remove the dipstick again, and check the level. It should be between the upper and lower marks. Add oil if necessary.

Oil Check

NOTICE

Under certain driving conditions, it is normal for the engine oil level to rise above the upper mark. If you have a concern, consult a dealer for details.

Adding Engine Oil

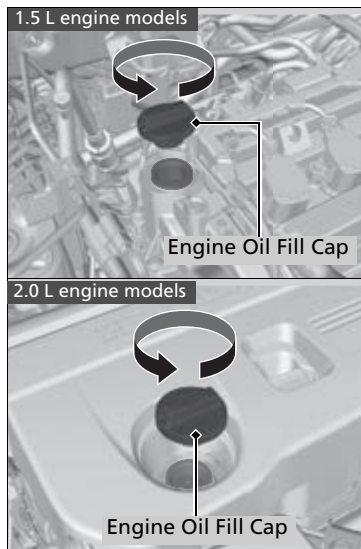

1. Unscrew and remove the engine oil fill cap.
2. Add oil slowly.
3. Reinstall the engine oil fill cap, and tighten it securely.
4. Wait for three minutes and recheck the engine oil dipstick.

►► Adding Engine Oil

NOTICE

Do not fill the engine oil above the upper mark. Overfilling the engine oil may result in leaks and engine damage.

If any oil spills, wipe it away immediately. Spilled oil may damage the engine compartment components.

Changing the Engine Oil and Oil Filter

You must change the engine oil and oil filter regularly in order to maintain the engine's lubrication. The engine may be damaged if they are not changed regularly.

Change the oil and filter in accordance with the maintenance message on the driver information interface.

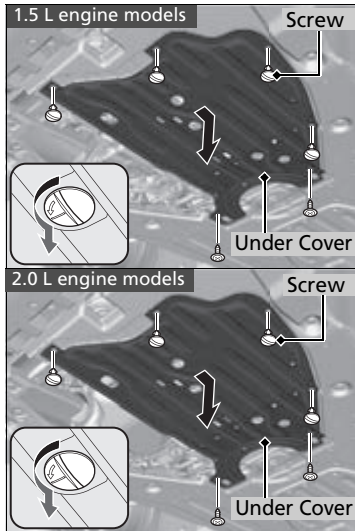

1. Run the engine until it reaches normal operating temperature, and then turn the engine off.
2. Open the hood and remove the engine oil fill cap.
3. Remove the Phillips-head and slotted head screws by turning 90° counter-clockwise on the undercarriage and remove the under cover.

Changing the Engine Oil and Oil Filter

NOTICE

You may damage the environment if you do not dispose of the oil in a suitable way. If you are changing the oil by yourself, appropriately dispose of the used oil. Put the oil in a sealed container and take it to a recycling center. Do not throw the oil away into a garbage can or onto the ground.

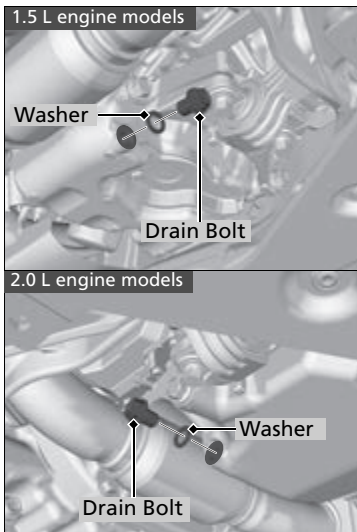

4. Remove the drain bolt and washer from the bottom of the engine, and drain the oil into a suitable container.

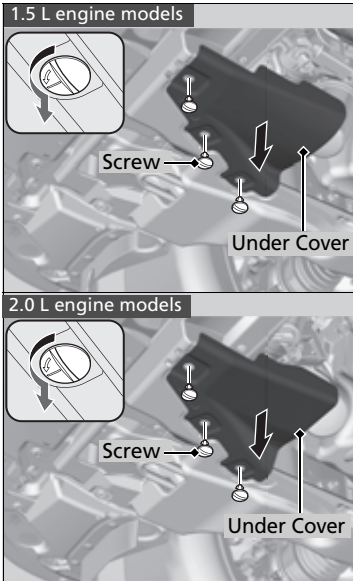

5. Remove the slotted head screws by turning 90° counter-clockwise on the undercarriage and remove the under cover.

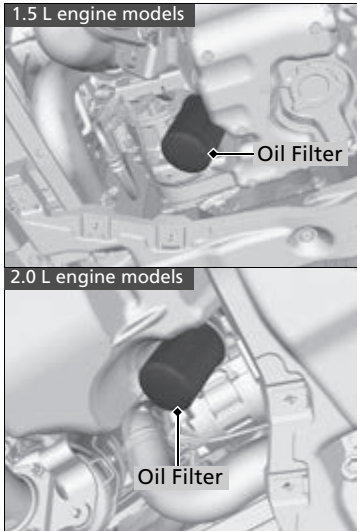

6. Remove the oil filter and dispose of the remaining oil.
7. Check that the filter gasket is not stuck to the engine contact surface.
 - If it is stuck, you must detach it.
8. Wipe away dirt and dust adhering to the contact surface of the engine block, and install a new oil filter.
 - Apply a light coat of new engine oil to the filter gasket.
9. Put a new washer on the drain bolt, then reinstall the drain bolt.
 - Tightening torque:
30 lbf·ft (40 N·m, 4.0 kgf·m)
10. Pour the recommended engine oil into the engine.
 - Engine oil change capacity (including filter):
 - 1.5 L engine models**
3.7 US qt (3.5 L)
 - 2.0 L engine models**
5.0 US qt (4.8 L)
11. Reinstall the engine oil fill cap securely and start the engine.
12. Run the engine for a few minutes, and then check that there is no leak from the drain bolt or oil filter.
13. Stop the engine, wait for three minutes, and then check the oil level on the dipstick.
 - If necessary, add more engine oil.

► Changing the Engine Oil and Oil Filter

You will need a special wrench to replace the oil filter. You can buy this wrench from a dealer.

When installing the new oil filter, follow the instructions supplied with the oil filter.

Reinstall the engine oil fill cap. Start the engine. If the low oil pressure warning appears, turn off the engine, and check your work.

Engine Coolant

Specified coolant: Honda Long Life Antifreeze/Coolant Type 2

This coolant is premixed with 50% antifreeze and 50% water. Do not add any straight antifreeze or water.

We recommend you check the engine coolant level every time you refuel. Check the reserve tank first. If it is completely empty, also check the coolant level in the radiator. Add the engine coolant accordingly.

Reserve Tank

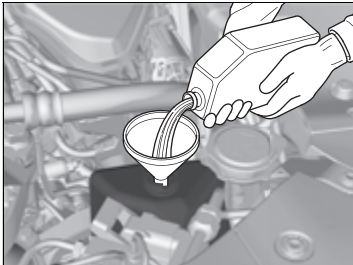
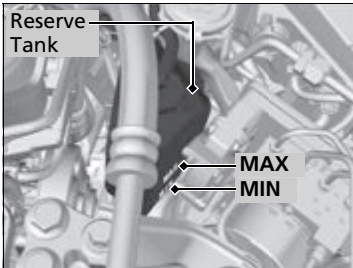

1. **Make sure the engine and radiator are cool.**
2. Check the amount of coolant in the reserve tank.
 - If the coolant level is below the **MIN** mark, add the specified coolant until it reaches the **MAX** mark.
3. Inspect the cooling system for leaks.

Engine Coolant

⚠ WARNING

Removing the radiator cap while the engine is hot can cause the coolant to spray out, seriously scalding you.

Always let the engine and radiator cool down before removing the radiator cap.

NOTICE

Genuine Honda engine coolant is a 50/50 mixture of antifreeze and water that can withstand freezing at temperatures as low as about -31°F (-35°C). If your vehicle is consistently subjected to temperatures below this, the concentration of antifreeze in the coolant should be increased. Consult a dealer for details.

If Honda antifreeze/coolant is not available, you may use another major brand of non-silicate coolant as a temporary replacement. Check that it is a high quality coolant recommended for aluminum engines. Continued use of any non-Honda coolant can result in corrosion, causing the cooling system to malfunction or fail. Have the cooling system flushed and refilled with Honda antifreeze/coolant as soon as possible.

Do not add rust inhibitors or other additives to your vehicle's cooling system. They may not be compatible with the coolant or with the engine components.

Continued

■ Radiator

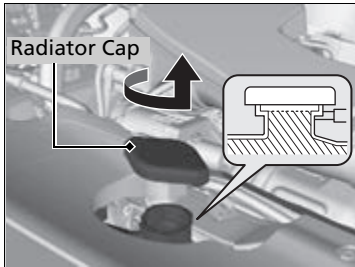

- 1. Make sure the engine and radiator are cool.**
- 2. Turn the radiator cap 1/8 turn counter-clockwise and relieve any pressure in the cooling system.**
- 3. Push down and turn the radiator cap counter-clockwise to remove it.**
- 4. The coolant level should be up to the base of the filler neck. Add coolant if it is low.**
- 5. Put the radiator cap back on, and tighten it fully.**

►► Radiator

NOTICE

Pour the fluid slowly and carefully so you do not spill any. Clean up any spills immediately; they can damage components in the engine compartment.

Transmission Fluid

■ Continuously Variable Transmission (CVT) Fluid *

Specified fluid: Honda HCF-2

Have a dealer check the fluid level and replace if necessary.

Do not attempt to check or change the continuously variable transmission fluid yourself.

■ Automatic Transmission Fluid *

Specified fluid: Honda Automatic Transmission Fluid ATF-Type 2.0

Have a dealer check the fluid level and replace if necessary.

Do not attempt to check or change the automatic transmission fluid yourself.

⌘ Continuously Variable Transmission (CVT) Fluid *

NOTICE

Do not mix Honda HCF-2 with other transmission fluids.

Using a transmission fluid other than Honda HCF-2 may adversely affect the operation and durability of your vehicle's transmission, and damage the transmission.

Any damage caused by using a transmission fluid that is not equivalent to Honda HCF-2 is not covered by Honda's new vehicle limited warranty.

⌘ Automatic Transmission Fluid *

NOTICE

Do not mix Honda ATF-Type 2.0 with other transmission fluids.

Using a transmission fluid other than Honda ATF-Type 2.0 may adversely affect the operation and durability of your vehicle's transmission, and damage the transmission.

Any damage caused by using a transmission fluid that is not equivalent to Honda ATF-Type 2.0 is not covered by Honda's new vehicle limited warranty.

* Not available on all models

Brake Fluid

Specified fluid: Honda Heavy Duty Brake Fluid DOT 3

■ Checking the Brake Fluid

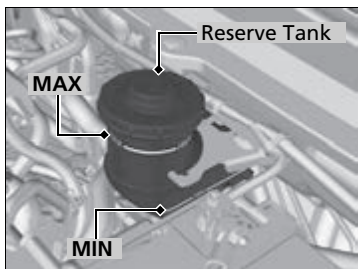

The fluid level should be between the **MIN** and **MAX** marks on the side of the reserve tank.

►► Brake Fluid

NOTICE

Brake fluid marked DOT 5 is not compatible with your vehicle's braking system and can cause extensive damage.

If the specified brake fluid is not available, you should use only DOT 3 or DOT 4 fluid from a sealed container as a temporary replacement.

Using any non-Honda brake fluid can cause corrosion and decrease the longevity of the system. Have the brake system flushed and refilled with Honda Heavy Duty Brake Fluid DOT 3 as soon as possible.

If the brake fluid level is at or below the **MIN** mark, have a dealer inspect the vehicle for leaks or worn brake pads as soon as possible.

Refilling Window Washer Fluid

Check the amount of window washer fluid.



If the level is low, fill the washer reservoir.

Canadian models

If the washer fluid is low, a message appears on the driver information interface.

All models

Pour the washer fluid carefully. Do not overflow the reservoir.

ⓘ Refilling Window Washer Fluid

NOTICE

Do not use engine antifreeze or a vinegar/water solution in the windshield washer reservoir. Antifreeze can damage your vehicle's paint. A vinegar/water solution can damage the windshield washer pump. Use only commercially available windshield washer fluid. Avoid prolonged use of hard water to prevent lime scale buildup.

Headlight Bulbs

When replacing, use the following bulbs.

High beam headlight: LED*

High beam headlight: 60 W (HB3 for halogen bulb type)*

Low beam headlight: LED

» Headlight Bulbs

Models with halogen high beam headlights

NOTICE

Halogen bulbs get very hot when lit. Oil, perspiration, or a scratch on the glass can cause the bulb to overheat and shatter.

All models

The headlight aim is set by the factory, and does not need to be adjusted. However, if you regularly carry heavy items in the trunk or tow a trailer*, have the aiming readjusted at a dealer or by a qualified technician.

Models with halogen high beam headlights

When replacing a halogen bulb, handle it by its base, and protect the glass from contact with your skin or hard objects. If you touch the glass, clean it with denatured alcohol and a clean cloth.

High Beam Headlights

Models with halogen high beam headlights

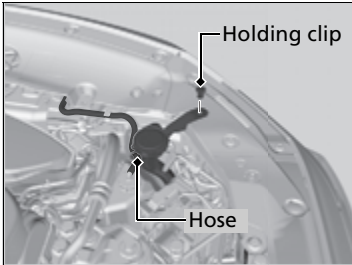

Passenger side

1. Remove the hose and the holding clip using a flat-tip screwdriver, then remove the upper part of the window washer reserve tank.
 - ▶ Check the amount of window washer fluid is below the upper part of the window washer reserve tank and remove it.

Both sides

2. Push the tab to remove the coupler.
3. Rotate the old bulb counter-clockwise to remove.
4. Insert a new bulb into the headlight assembly and turn it clockwise.
5. Insert the coupler into the connector of the bulb.

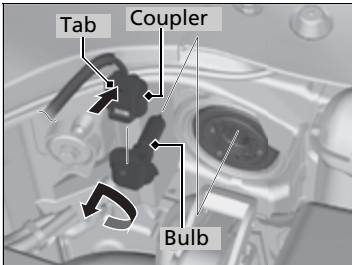

Low Beam Headlights

Low beam headlights are LED type. Have an authorized Honda dealer inspect and replace the light assembly.

High Beam Headlights

Models with LED high beam headlights

High beam headlights are LED type. Have an authorized Honda dealer inspect and replace the light assembly.

When removing the clip, insert a flat-tip screwdriver, then lift and remove the clip.

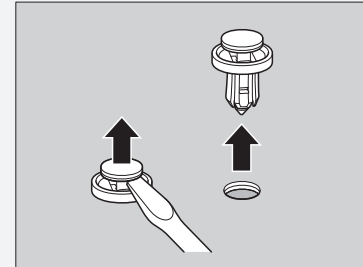

Insert the clip with the pin raised, and push until it is flat.

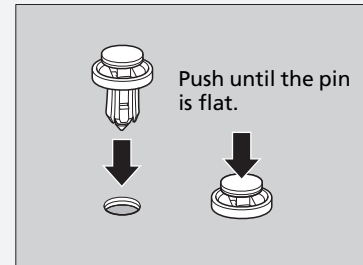

Fog Lights*

Fog lights are LED type. Have an authorized Honda dealer inspect and replace the light assembly.

Parking/Daytime Running Lights

Parking/daytime running lights are LED type. Have an authorized Honda dealer inspect and replace the light assembly.

Front Turn Signal Lights

Front turn signal lights are LED type. Have an authorized Honda dealer inspect and replace the light assembly.

Front Side Marker Lights

Front side marker lights are LED type. Have an authorized Honda dealer inspect and replace the light assembly.

Side Turn Signal/Emergency Indicator Lights*

Door mirror side turn lights are LED type. Have an authorized Honda dealer inspect and replace the light assembly.

Brake Lights, Taillights, Rear Side Marker Lights and Rear Turn Signal Light Bulbs

When replacing, use the following bulbs.

Brake Light: LED

Taillight: LED

Rear Side Marker Light: LED

Rear Turn Signal Light: 21 W (Amber)

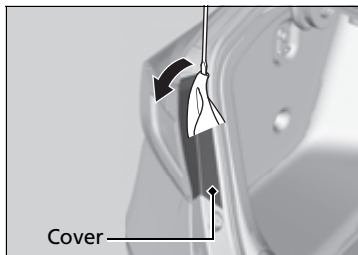

1. Pry on the edge of the cover using a flat-tip screwdriver to remove the cover.
 - ▶ Wrap the flat-tip screwdriver with a cloth to prevent scratches.
2. Remove the bolts.
3. Pull the light assembly out of the rear pillar.

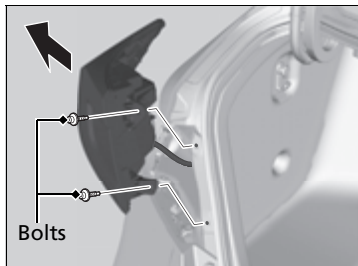

☒ Brake Lights, Taillights, Rear Side Marker Lights and Rear Turn Signal Light Bulbs

Brake and rear side marker/taillights are LED type. Have an authorized Honda dealer inspect and replace the light assembly.

Continued

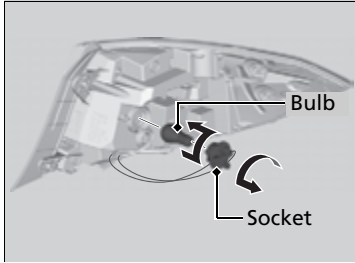

4. Turn the socket counter-clockwise and remove it.
5. Push and turn the old bulb clockwise and remove it, and insert a new bulb.

Taillight, Brake Light* and Back-Up Light Bulbs

When replacing, use the following bulbs.

Taillight: LED
Brake Light*: LED
Back-Up Light: 16 W

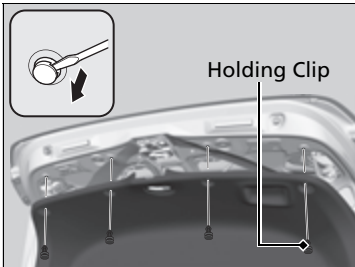

1. Remove the holding clips using a flat-tip screwdriver, then pull the lining back.

Driver side

2. Turn the socket counter-clockwise and remove it.
3. Remove the old bulb and insert a new bulb.

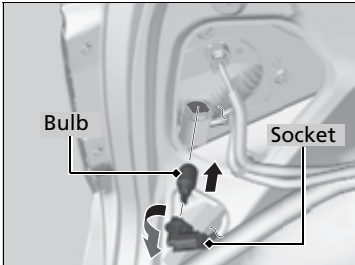

⊠ Taillight, Brake Light* and Back-Up Light Bulbs

Taillights and brake lights* are LED type. Have an authorized Honda dealer inspect and replace the light assembly.

When removing the clip, insert a flat-tip screwdriver, then lift and remove the clip.

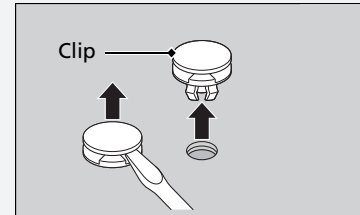

Insert the clip with the pin raised, and push until it is flat.

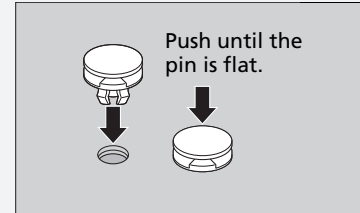

* Not available on all models

Continued

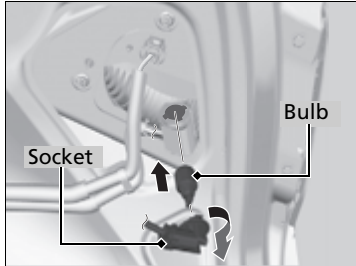

Passenger side

2. Turn the socket clockwise and remove it.
3. Remove the old bulb and insert a new bulb.

Rear License Plate Light

Rear license plate light is LED type. Have an authorized Honda dealer inspect and replace the light assembly.

High-Mount Brake Light

High-mount brake light is LED type. Have an authorized Honda dealer inspect and replace the light assembly.

Checking Wiper Blades

If the wiper blade rubber has deteriorated, it will leave streaks, become noisy, and the hard surfaces of the blade may scratch the window glass.

Changing the Wiper Blade Rubber

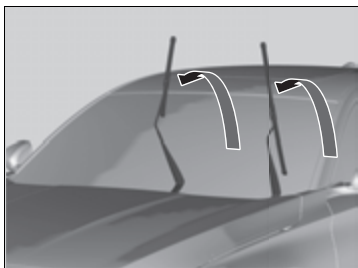
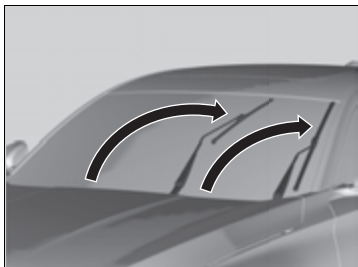

1. Set the power mode to VEHICLE OFF.
2. While holding the wiper switch in the **MIST** position, set the power mode to ON, then to VEHICLE OFF.
 - ▶ Both wiper arms are set to the maintenance position as shown in the image.
3. Lift the driver side wiper arm first, then the passenger side.

✎ Changing the Wiper Blade Rubber

NOTICE

Avoid dropping the wiper arm onto the windshield, it may damage the wiper arm and/or the windshield.

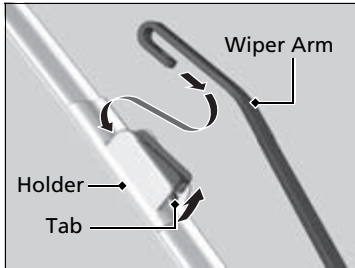

4. Press up on and hold the tab, then slide the holder off the wiper arm.

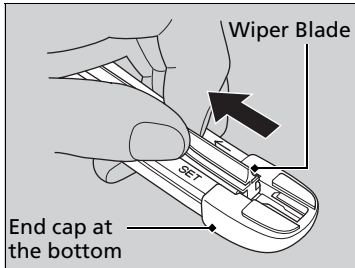

5. Pull the end of the wiper blade in the direction of the arrow in the image until it is out of the holder's end cap.

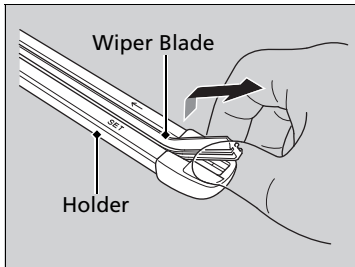

6. Pull the wiper blade in the opposite direction to slide it out of the holder.

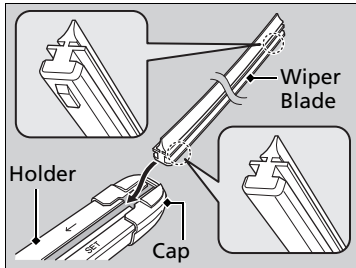

7. Insert the flat side of the new wiper blade onto the bottom part of the holder. Insert the blade all the way.
8. Install the end of the wiper blade into the cap.
9. Slide the holder onto the wiper arm until it locks.
10. Lower the passenger side wiper arm first, then the driver side.
11. Set the power mode to ON and hold the wiper switch in the **MIST** position until both wiper arms return to the standard position.

Checking Tires

To safely operate your vehicle, your tires must be of the proper type and size, in good condition with adequate tread, and properly inflated.

■ Inflation guidelines

Properly inflated tires provide the best combination of handling, tread life, and comfort. Refer to the driver's doorjamb label or specifications page for the specified pressure.

Under inflated tires wear unevenly, adversely affect handling and fuel economy, and are more likely to fail from overheating.

Overinflated tires make your vehicle ride harshly, are more prone to road hazards, and wear unevenly.

Every day before you drive, look at each of the tires. If one looks lower than the others, check the pressure with a tire gauge.

At least once a month or before long trips, use a gauge to measure the pressure in all tires, including the spare. Even tires in good condition can lose 1–2 psi (10–20 kPa, 0.1–0.2 kgf/cm²) per month.

■ Inspection guidelines

Every time you check inflation, also examine the tires and valve stems. Look for:

- Bumps or bulges on the side or in the tread. Replace the tire if you find any cuts, splits, or cracks in the side of the tire. Replace it if you see fabric or cord.
- Remove any foreign objects and inspect for air leaks.
- Uneven tread wear. Have a dealer check the wheel alignment.
- Excessive tread wear.
 - **Wear Indicators** P. 580
- Cracks or other damage around valve stem.

☒ Checking Tires

⚠ WARNING

Using tires that are excessively worn or improperly inflated can cause a crash in which you can be seriously hurt or killed.

Follow all instructions in this owner's manual regarding tire inflation and maintenance.

Measure the air pressure when tires are cold. This means the vehicle has been parked for at least three hours, or driven less than 1 mile (1.6 km). If necessary, add or release air until the specified pressure is reached.

If checked when hot, tire pressure can be as much as 4–6 psi (30–40 kPa, 0.3–0.4 kgf/cm²) higher than if checked when cold.

Whenever tire pressure is adjusted, you must calibrate the TPMS.

➤ **TPMS Calibration** P. 446

Have a dealer check the tires if you feel a consistent vibration while driving. New tires and any that have been removed and reinstalled should be properly balanced.

Check the spare tire pressure once a month or before long trips.

Tire and Loading Information Label

The label attached to the driver’s doorjamb provides necessary tire and loading information.

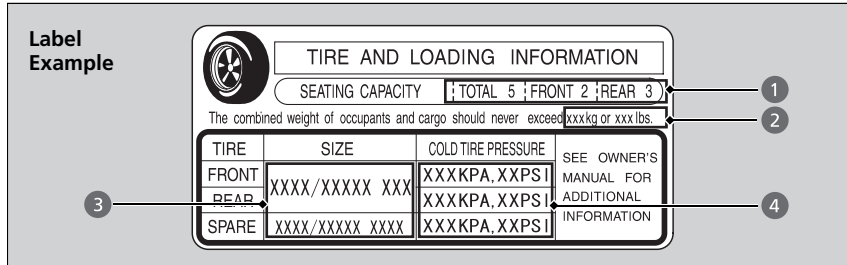

▶▶ Tire and Loading Information Label

The tire and loading information label attached to the driver’s doorjamb contains:

- ❶ The number of people your vehicle can carry.
- ❷ The total weight your vehicle can carry. Do not exceed this weight.
- ❸ The original tire sizes for front, rear, and spare.
- ❹ The proper cold tire pressure for front, rear, and spare.

Tire Labeling

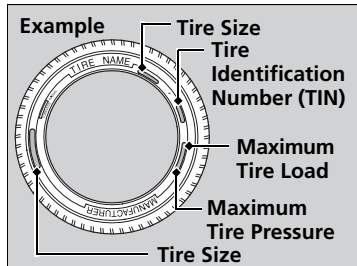

The tires that came on your vehicle have a number of markings. Those you should be aware of are described as shown.

▶▶ Tire Sizes

Following is an example of tire size with an explanation of what each component means.

P235/60 R18 102T

P: Vehicle type (P indicates passenger vehicle).

235: Tire width in millimeters.

60: Aspect ratio (the tire’s section height as a percentage of its width).

R: Tire construction code (R indicates radial).

18: Rim diameter in inches.

102: Load index (a numerical code associated with the maximum load the tire can carry).

T: Speed symbol (an alphabetical code indicating the maximum speed rating).

■ Tire Sizes

Whenever tires are replaced, they should be replaced with tires of the same size.

■ Tire Identification Number (TIN)

The tire identification number (TIN) is a group of numbers and letters that look like the example in the side column. TIN is located on the sidewall of the tire.

■ Glossary of Tire Terminology

Cold Tire Pressure – The tire air pressure when the vehicle has been parked for at least three hours or driven less than 1 mile (1.6 km).

Load Rating – Means the maximum load that a tire is rated to carry for a given inflation pressure.

Maximum Inflation Pressure – The maximum tire air pressure that the tire can hold.

Maximum Load Rating – Means the load rating for a tire at the maximum permissible inflation pressure for that tire.

Recommended Inflation Pressure – The cold tire inflation pressure recommended by the manufacturer.

Treadwear Indicators (TWI) – Means the projections within the principal grooves designed to give a visual indication of the degrees of wear of the tread.

☒ Tire Identification Number (TIN)

DOT B97R FW6X 2209

DOT: This indicates that the tire meets all requirements of the U.S. Department of Transportation.

B97R: Manufacturer's identification mark.

FW6X: Tire type code.

22 09: Date of manufacture.

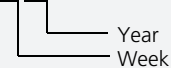

DOT Tire Quality Grading (U.S. Vehicles)

The tires on your vehicle meet all U.S. Federal Safety Requirements. All tires are also graded for treadwear, traction, and temperature performance according to Department of Transportation (DOT) standards. The following explains these gradings.

■ Uniform Tire Quality Grading

Quality grades can be found where applicable on the tire sidewall between tread shoulder and maximum section width.

■ Treadwear

The treadwear grade is a comparative rating based on the wear rate of the tire when tested under controlled conditions on a specified government test course. For example, a tire graded 150 would wear one and one-half (1 1/2) times as well on the government course as a tire graded 100. The relative performance of tires depends upon the actual conditions of their use, however, and may depart significantly from the norm due to variations in driving habits, service practices and differences in road characteristics and climate.

» Uniform Tire Quality Grading

For example:
Treadwear 200
Traction AA
Temperature A

All passenger car tires must conform to Federal Safety Requirements in addition to these grades.

■ Traction

The traction grades, from highest to lowest, are AA, A, B, and C. Those grades represent the tire's ability to stop on wet pavement as measured under controlled conditions on specified government test surfaces of asphalt and concrete. A tire marked C may have poor traction performance.

■ Temperature

The temperature grades are A (the highest), B, and C, representing the tire's resistance to the generation of heat and its ability to dissipate heat when tested under controlled conditions on a specified indoor laboratory test wheel. Sustained high temperature can cause the material of the tire to degenerate and reduce tire life, and excessive temperature can lead to sudden tire failure. The grade C corresponds to a level of performance which all passenger car tires must meet under the Federal Motor Vehicle Safety Standard No. 109. Grades B and A represent higher levels of performance on the laboratory test wheel than the minimum required by law.

⌘ Traction

Warning: The traction grade assigned to this tire is based on straight-ahead braking traction tests, and does not include acceleration, cornering, hydroplaning, or peak traction characteristics.

⌘ Temperature

Warning: The temperature grade for this tire is established for a tire that is properly inflated and not overloaded. Excessive speed, underinflation, or excessive loading, either separately or in combination, can cause heat buildup and possible tire failure.

Wear Indicators

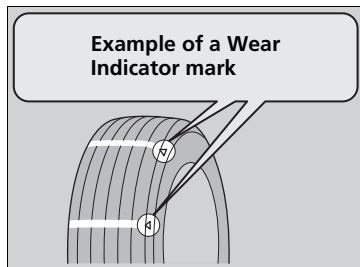

The groove where the wear indicator is located is about 1/16 inch (about 1.6 mm) shallower than elsewhere on the tire. If the tread has worn so that the indicator is exposed, replace the tire. **Worn out tires have poor traction on wet roads.**

Tire Service Life

The life of your tires is dependent on many factors, including driving habits, road conditions, vehicle loading, inflation pressure, maintenance history, speed, and environmental conditions (even when the tires are not in use).

In addition to regular inspections and inflation pressure maintenance, it is recommended that you have annual inspections performed once the tires reach five years old. All tires, including the spare, should be removed from service after 10 years from the date of manufacture, regardless of their condition or state of wear.

▶▶ Checking Tires

High speed driving

We recommend that you do not drive faster than the posted speed limits and conditions allow. If you drive at sustained high speeds (over 99 mph or 160 km/h), adjust the cold tire pressures as shown below to avoid excessive heat buildup and sudden tire failure.

Models with 225/50R17 tires

Tire Size	225/50R17 94V
Pressure	Front: 35 psi (240 kPa, 2.4 kgf/cm ²) Rear: 33 psi (230 kPa, 2.3 kgf/cm ²)

Models with 235/40R19 tires

Tire Size	235/40R19 96V
Pressure	Front: 36 psi (250 kPa, 2.5 kgf/cm ²) Rear: 36 psi (250 kPa, 2.5 kgf/cm ²)

Tire and Wheel Replacement

Replace your tires with radials of the same size, load range, speed rating, and maximum cold tire pressure rating (as shown on the tire's sidewall). Using tires of a different size or construction can cause certain vehicle systems such as the ABS and Vehicle Stability Assist™ (VSA®) system to work incorrectly.

It is best to replace all four tires at the same time. If that isn't possible, replace the front or rear tires in pairs.

Make sure that the wheel's specifications match those of the original wheels.

ⓘ Tire and Wheel Replacement

⚠ WARNING

Installing improper tires on your vehicle can affect handling and stability. This can cause a crash in which you can be seriously hurt or killed.

Always use the size and type of tires recommended in this owner's manual.

Tire Rotation

Rotating tires according to the maintenance messages on the driver information interface helps to distribute wear more evenly and increase tire life.

■ Tires without rotation marks

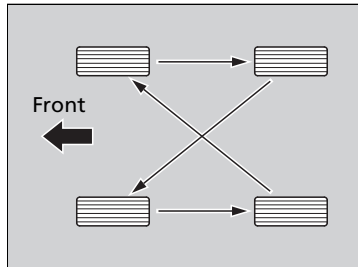

Rotate the tires as shown here.

■ Tires with rotation marks

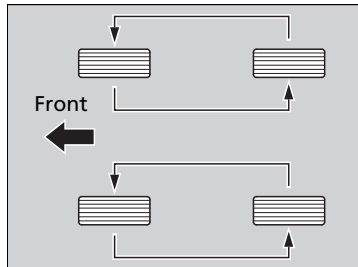

Rotate the tires as shown here.

►► Tire Rotation

Tires with directional tread patterns should only be rotated front to back (not from one side to the other). Directional tires should be mounted with the rotation indication mark facing forward, as shown below.

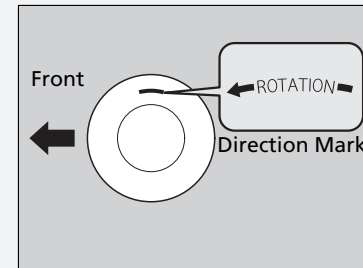

Whenever tires are rotated, you must calibrate the TPMS.

►► **TPMS Calibration** P. 446

Winter Tires

If driving on snowy or frozen roads, mount all season marked **M+S** tires, snow tires, or tire chains; reduce speed; and maintain sufficient distance between vehicles when driving.

Be particularly careful when operating the steering wheel or brakes to prevent skidding.

Use tire chains, snow tires, or all season tires when necessary or according to the law.

When mounting, refer to the following points.

For winter tires:

- Select the size and load ranges that are the same as the original tires.
- Mount the tires to all four wheels.

For tire chains:

- Install them on the front tires only.
- Because your vehicle has limited tire clearance, we strongly recommend using the chains listed below:

Models with 225/50R17 tires

Cable-type: SCC Radial Chain SC1036

Models with 235/40R19 tires

Not recommended to use any type of chains

- Follow the chain manufacturer's instruction when installing. Mount them as tightly as you can.
- Check that the chains do not touch the brake lines or suspension.
- Drive slowly.

❗ Winter Tires

⚠ WARNING

Using the wrong chains, or not properly installing chains, can damage the brake lines and cause a crash in which you can be seriously injured or killed.

Follow all instructions in this owner's manual regarding the selection and use of tire chains.

NOTICE

Traction devices that are the wrong size or improperly installed can damage your vehicle's brake lines, suspension, body, and wheels. Stop driving if they are hitting any part of the vehicle.

When tire chains are mounted, follow the chain manufacturer's instructions regarding vehicle operational limits.

If your vehicle is equipped with summer tires, be aware that these tires are not designed for winter driving conditions. For more information, contact a dealer.

Checking the Battery

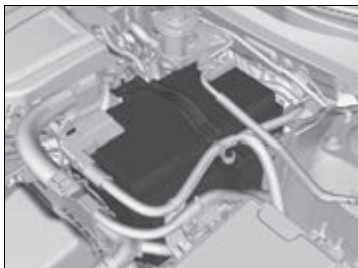

The condition of the battery is monitored by a sensor located on the negative terminal of the battery. If there is a problem with this sensor, the driver information interface will display a warning message. If this happens, have your vehicle inspected by a dealer.

Check the battery terminals for corrosion monthly.

If your vehicle's battery is disconnected or goes dead:

- The audio system is disabled.
➔ **Reactivating the audio system** P. 249

Models without navigation system

- The clock resets.
➔ **Clock** P. 166

Canadian models

- The immobilizer system needs to be reset.
➔ **Immobilizer System Indicator** P. 98

Battery

⚠ WARNING

The battery gives off explosive hydrogen gas during normal operation.

A spark or flame can cause the battery to explode with enough force to kill or seriously hurt you.

When conducting any battery maintenance, wear protective clothing and a face shield, or have a skilled technician do it.

WARNING: Battery post, terminals, and related accessories contain lead and lead compounds.

Wash your hands after handling.

When you find corrosion, clean the battery terminals by applying a baking powder and water solution. Clean the terminals with a damp towel. Cloth/towel dry the battery. Coat the terminals with grease to help prevent future corrosion.

Charging the Battery

Disconnect both battery cables to prevent damaging your vehicle's electrical system. Always disconnect the negative (-) cable first, and reconnect it last.

⌘ Charging the Battery

When replacing the battery, the replacement must be of the same specifications. Consult a dealer for more information.

The Vehicle Stability Assist™ (VSA®) system, Vehicle Stability Assist™ (VSA®) **OFF**, adaptive cruise control (ACC) with Low Speed Follow, safety support and low tire pressure/TPMS indicators may come on in amber along with a message in the driver information interface when you set the power mode to ON after reconnecting the battery.

Drive a short distance at more than 12 mph (20 km/h). Each indicator should go off. If any do not, have your vehicle checked by a dealer.

Models with Auto Idle Stop

The battery installed in this vehicle is specifically designed for a model with Auto Idle Stop.

Using a battery other than this specified type may shorten the battery life, and prevent Auto Idle Stop from activating. If you need to replace the battery, make sure to select the specified type and size. Ask a dealer for more details.

Replacing the Remote Battery

If the indicator does not come on when the button is pressed, replace the battery.



Battery type: CR2032

1. Remove the built-in key.
2. Remove the upper half of the cover by carefully prying on the edge with a coin.
 - ▶ Wrap a coin with a cloth to prevent scratching the keyless remote.
 - ▶ Remove carefully to avoid losing the buttons.
3. Make sure to replace the battery with the correct polarity.

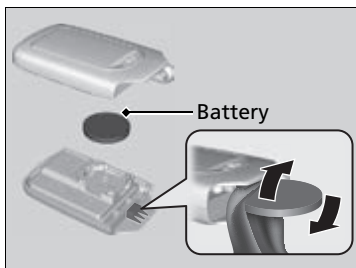

Replacing the Remote Battery

WARNING

CHEMICAL BURN HAZARD

The battery that powers the remote transmitter can cause severe internal burns and can even lead to death if swallowed. Keep new and used batteries away from children.

If you suspect that a child has swallowed the battery, seek medical attention immediately.

NOTICE

An improperly disposed of battery can damage the environment. Always confirm local regulations for battery disposal.

Replacement batteries are commercially available or at a dealer.

Air Conditioning

To ensure proper and safe operation, the Society of Automotive Engineers (SAE J2845) recommends that the refrigerant system only be serviced by trained and certified technicians.

Never repair or replace the air conditioning evaporator (cooling coil) with one removed from a used or salvaged vehicle.

New replacement mobile air conditioning evaporators must be certified (and labeled) as meeting SAE Standard J2842.

Dust and Pollen Filter

The climate control system is equipped with a dust and pollen filter that collects pollen, dust, and other debris in the air. The Maintenance Minder™ messages will let you know when to replace the filter.

We recommend that you replace the dust and pollen filter sooner when using your vehicle in areas with high concentrations of dust.

Air Conditioning

NOTICE

Vented refrigerant is harmful to the environment. To avoid refrigerant from venting, never replace the evaporator with one removed from a used or salvaged vehicle.

Refrigerant in your vehicle's air conditioning system is flammable and can be ignited during servicing if proper procedures are not followed.

The air conditioner label is found under the hood:

➤ **Safety Labels** P. 79

➤ **Specifications** P. 632, 634

Canadian models



 : Caution

 : Flammable Refrigerant

 : Requires Registered Technician to Service

 : Air Conditioning System

Dust and Pollen Filter

If the airflow from the climate control system deteriorates noticeably, and the windows fog up easily, the filter may need to be replaced. Please contact a dealer for replacement.

Interior Care

Use a damp cloth with a mixture of mild detergent and warm water to remove dirt. Use a clean cloth to remove detergent residue.

Cleaning Seat Belts

Use a soft brush with a mixture of mild soap and warm water to clean the seat belts. Let the belts air dry. Wipe the openings of the seat belt anchors using a clean cloth.

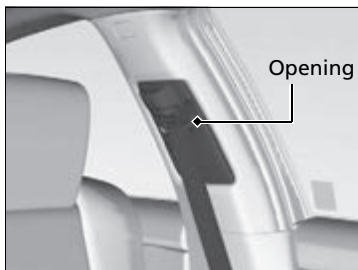

Cleaning the Window

Wipe using a glass cleaner.

Interior Care

Do not spill liquids inside the vehicle. Electrical devices and systems may malfunction if liquids are splashed on them.

Do not use silicone based sprays on electrical devices such as audio devices and switches. Doing so may cause the items to malfunction or cause a fire inside the vehicle. If a silicone based spray is inadvertently used on electrical devices, consult a dealer.

Depending on their composition, chemicals and liquid aromatics may cause discoloration, wrinkles, and cracking to resin-based parts and textiles. Do not use alkali solvents or organic solvents such as benzene or gasoline.

After using chemicals, make sure to gently wipe them away using a dry cloth. Do not place used cloths on top of resin based parts or textiles for long periods of time without washing.

Cleaning the Window

Wires are mounted to the inside of the rear window. Wipe along the same direction as the wires with a soft cloth so as not to damage them.

Be careful not to spill fluids, such as water or glass cleaner, on or around the cover of both the front sensor camera and the rainfall/light sensor*.

■ Floor Mats

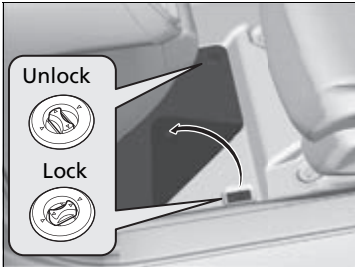

The driver's floor mat hooks over floor anchors, which keep them from sliding forward. To remove a mat for cleaning, turn the anchor knobs to the unlock position. When reinstalling the mat after cleaning, turn the knobs to the lock position.

Do not put additional floor mats on top of the anchored mat.

■ Maintaining Genuine Leather

To properly clean leather:

1. Use a vacuum or soft dry cloth first to remove any dirt or dust.
2. Clean the leather with a soft cloth dampened with a solution comprised of 90% water and 10% neutral soap.
3. Wipe away any soap residue with a clean damp cloth.
4. Wipe away residual water and allow leather to air dry in the shade.

▣ Floor Mats

If you use any floor mats that were not originally provided with your vehicle, make sure they are designed for your specific vehicle, fit correctly, and are securely anchored by the floor anchors. Position the rear seat floor mats properly. If not properly positioned, the floor mats can interfere with the front seat functions.

▣ Maintaining Genuine Leather

It is important to clean or wipe away dirt or dust as soon as possible. Spills can soak into leather resulting in stains. Dirt or dust can cause abrasions in the leather. In addition, please note that some dark colored clothing can rub onto the leather seats resulting in discoloration or stains.

Exterior Care

Dust off the vehicle body after you drive.

Regularly inspect your vehicle for scratches on painted surfaces. A scratch on a painted surface can result in body rust. If you find a scratch, promptly repair it.

■ Washing the Vehicle

Wash the vehicle regularly. Wash more frequently when driving in the following conditions:

- If driving on roads with road salt.
- If driving in coastal areas.
- If tar, soot, bird droppings, insects, or tree sap are stuck to painted surfaces.

■ Using an Automated Car Wash

- Make sure to follow the instructions indicated on the automated car wash.
- Fold in the door mirrors.
- For models equipped with automatic intermittent wipers, turn the wipers off.

■ Using High Pressure Cleaners

- Keep sufficient distance between the cleaning nozzle and the vehicle body.
- Take particular care around the windows. Standing too close may cause water to enter the vehicle interior.
- Do not spray high pressure water directly into the engine compartment. Instead, use low pressure water and a mild detergent.

►► Washing the Vehicle

Do not spray water into the air intake vents. It can cause a malfunction.

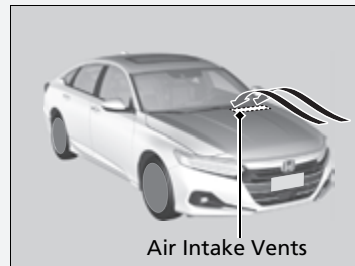

Air Intake Vents

Do not spray water onto the fuel fill door directly. A high-pressure spray may cause it to open.

Do not spray water onto the capless unit when the fuel fill door is open. It can cause damage to the fuel system or engine.

If you need to lift the wiper arms away from the windshield, first set the wiper arms to the maintenance position.

► **Changing the Wiper Blade Rubber** P. 572

►► Using an Automated Car Wash

Automatic transmission models

When using an automated car wash that pulls the vehicle through with a conveyor, make sure the transmission is in **N** position.

► **If you want to keep the transmission in **N** position [car wash mode]** P. 423

■ Applying Wax

A good coat of automotive body wax helps protect your vehicle's paint from the elements. Wax will wear off over time and expose your vehicle's paint to the elements, so reapply as necessary.

■ Maintaining the Bumpers and Other Resin Coated Parts

If you get gasoline, oil, engine coolant, or battery fluid on resin coated parts, they may be stained or the coating may peel. Promptly wipe it away using a soft cloth and clean water.

■ Cleaning the Window

Wipe using a glass cleaner.

■ Maintaining Aluminum Wheels

Aluminum is susceptible to deterioration caused by salt and other road contaminants. When necessary, as early as possible use a sponge and mild detergent to wipe away these contaminants. Do not use a stiff brush or harsh chemicals (including some commercial wheel cleaners). These can damage the protective finish on aluminum alloy wheels, resulting in corrosion. Depending on the type of finish, the wheels also may lose their luster or appear burnished. To avoid water stains, wipe the wheels dry with a cloth while they are still wet.

▶▶ Applying Wax

NOTICE

Chemical solvents and strong cleaners can damage the paint, metal, and plastic on your vehicle. Wipe away spills immediately.

▶▶ Maintaining the Bumpers and Other Resin Coated Parts

Ask a dealer about the correct coating material when you want to repair the painted surface of the parts made of resin.

■ Fogged Exterior Light Lenses

The inside lenses of exterior lights (headlights, brake lights, etc.) may fog temporarily if you have driven in the rain, or after the vehicle has been run through a car wash. Dew condensation also may build up inside the lenses when there is a significant enough difference between the ambient and inside lens temperatures (similar to vehicle windows fogging up in rainy conditions). These conditions are natural processes, not structural design problems in the exterior lights.

Lens design characteristics may result in moisture developing on the light lens frame surfaces. This also is not a malfunction.

However, if you see large amounts of water accumulation, or large water drops building up inside the lenses, have your vehicle inspected by a dealer.

Accessories

When installing accessories, check the following:

- Do not install accessories on the windshield. They can obstruct your view and delay your reaction to driving conditions.
- Do not install any accessories over areas marked **SRS AIRBAG**, on the sides or backs of the front seats, on front or side pillars, or near the side windows. Accessories installed in these areas may interfere with proper operation of the vehicle's airbags or may be propelled into you or another occupant if the airbags deploy.
- Be sure electronic accessories do not overload electrical circuits or interfere with proper operation of your vehicle.
 - **Fuses** P. 620
- Before installing any electronic accessory, have the installer contact a dealer for assistance. If possible, have a dealer inspect the final installation.

Accessories and Modifications

WARNING

Improper accessories or modifications can affect your vehicle's handling, stability, and performance, and cause a crash in which you can be seriously hurt or killed.

Follow all instructions in this owner's manual regarding accessories and modifications.

Honda Genuine accessories are recommended to ensure proper operation on your vehicle.

Modifications

Do not modify your vehicle in a manner that may affect its handling, stability, or reliability, or install non-genuine Honda parts or accessories that may have a similar effect.

Even minor modifications to vehicle systems can affect overall vehicle performance. Always make sure all equipment is properly installed and maintained, and do not make any modification to your vehicle or its systems that might cause your vehicle to no longer meet federal, state, province, territory, and local regulations.

The on-board diagnostic port (OBD-II/SAE J1962 connector) installed on this vehicle is intended to be used with automobile system diagnostic devices or with other devices that Honda has approved. Use of any other type of device may adversely affect the vehicle's electronic systems or allow them to be compromised, possibly resulting in a system malfunction, drained battery, or other unexpected problems.

Do not modify or attempt to repair any of the electrical components.

Handling the Unexpected

This chapter explains how to handle unexpected troubles.

Tools

Types of Tools 596

If a Tire Goes Flat

Changing a Flat Tire 597

Engine Does Not Start

Checking the Engine 603

If the Keyless Remote Battery is Weak 604

Emergency Engine Stop 605

If the Battery Is Dead 606

Shift Lever Does Not Move 609

Overheating

How to Handle Overheating 611

Indicator, Coming On/Blinking

If the Low Oil Pressure Warning Appears ... 613

If the Charging System Indicator Comes On 613

If the Malfunction Indicator Lamp Comes On or Blinks 614

If the Brake System Indicator (Red) Comes On or Blinks 615

If the Brake System Indicator (Red) Comes On or Blinks at the Same Time When the Brake System Indicator (Amber) Comes On.... 616

If the Electric Power Steering (EPS) System Indicator Comes On 617

If the Low Tire Pressure/TPMS Indicator Comes On or Blinks 618

If the Transmission System Indicator Blinks along with the Warning Message... 619

Fuses

Fuse Locations 620

Inspecting and Changing Fuses 625

Emergency Towing 626

If You Cannot Unlock the Fuel Fill Door 627

If You Cannot Open the Trunk 628

Refueling 630

Types of Tools

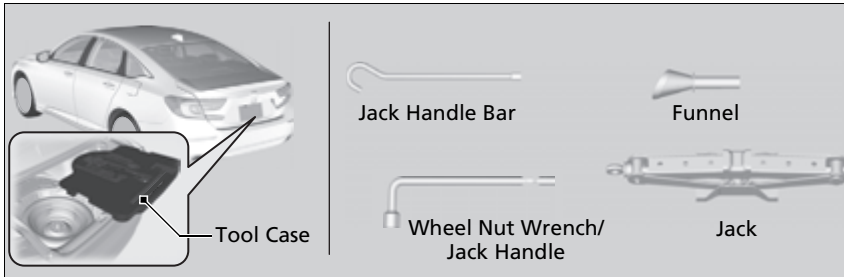

Types of Tools

The tools are stored in the trunk.

Changing a Flat Tire

If a tire goes flat while driving, grasp the steering wheel firmly, and brake gradually to reduce speed. Then, stop in a safe place. Replace the flat tire with a compact spare tire. Go to a dealer as soon as possible to have the full-size tire repaired or replaced.

1. Park the vehicle on a firm, level, and non-slippery surface, and apply the parking brake.
2. Put the transmission into **P**.
3. Turn on the hazard warning lights and set the power mode to VEHICLE OFF.

Changing a Flat Tire

Follow these compact spare precautions:
Periodically check the tire pressure of the compact spare. It should be set to the specified pressure.
Specified Pressure: 60 psi (420 kPa, 4.2 kgf/cm²)

When driving with the compact spare tire, keep the vehicle speed under 50 mph (80 km/h). Replace with a full-size tire as soon as possible.

The compact spare tire and wheel in your vehicle are specifically for this model. Do not use them with another vehicle. Do not use another type of compact spare tire or wheel with your vehicle.

Do not mount tire chains on a compact spare tire. If a chain-mounted front tire goes flat, remove one of the full-size rear tires and replace it with the compact spare tire. Remove the flat front tire and replace it with the full-size tire that was removed from the rear. Mount the tire chains on the front tire.

NOTICE

Do not use the jack if it doesn't work properly. Call your dealer or a professional towing service.

Do not mount the compact spare on the front. If either front tire goes flat, remove the rear tire on the same side, and mount the compact spare on the rear and the rear tire on the front.

■ Getting Ready to Replace the Flat Tire

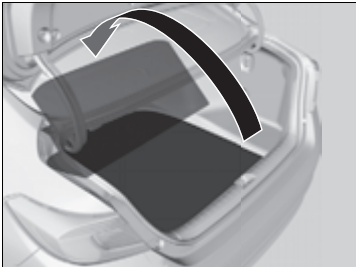

1. Open the trunk floor lid.

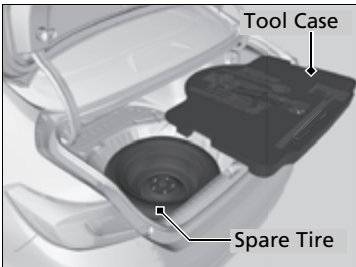

- 2. Take the tool case out of the trunk.
- 3. Take the jack, wheel nut wrench and jack handle bar out of the tool case.
- 4. Unscrew the wing bolt, and remove the spacer cone. Then, remove the spare tire.

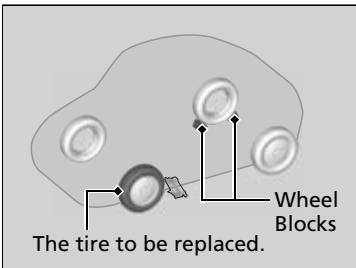

5. Place a wheel block or rock in the front and rear of the wheel diagonal to the flat tire.



6. Place the compact spare tire (wheel side up) under the vehicle body, near the tire that needs to be replaced.



7. Loosen each wheel nut about one turn using the wheel nut wrench.

■ How to Set Up the Jack

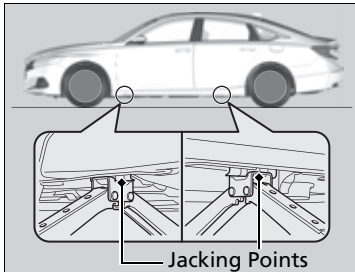

1. Place the jack under the jacking point closest to the tire to be changed.

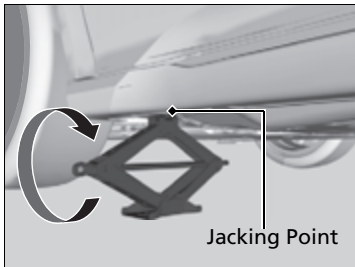

2. Turn the end bracket clockwise (as shown in the image) until the top of the jack contacts the jacking point.
▶ Make sure that the jacking point tab is resting in the jack notch.

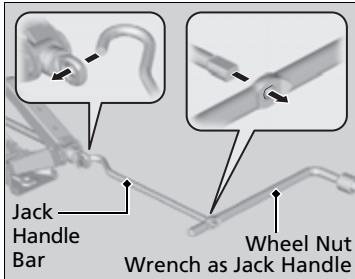

3. Raise the vehicle, using the jack handle bar and the jack handle, until the tire is off the ground.

▶▶ How to Set Up the Jack

⚠ WARNING

The vehicle can easily roll off the jack, seriously injuring anyone underneath.

Follow the directions for changing a tire exactly, and never get under the vehicle when it is supported only by the jack.

Do not use the jack with people or luggage in the vehicle.

Use the jack provided in your vehicle. Other jacks may not support the weight ("load") or may not fit the jacking point.

The following instructions must be followed to use the jack safely:

- Do not use while the engine is running.
- Use only where the ground is firm and level.
- Use only at the jacking points.
- Do not get in the vehicle while using the jack.
- Do not put anything on top of or underneath the jack.

■ Replacing the Flat Tire

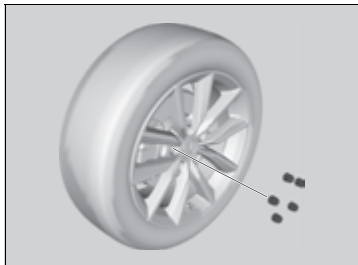

1. Remove the wheel nuts and flat tire.

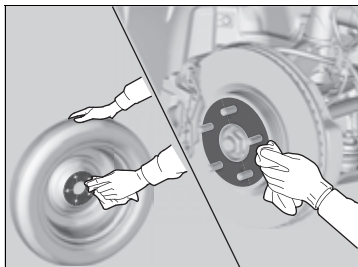

2. Wipe the mounting surfaces of the wheel with a clean cloth.

3. Mount the compact spare tire.

4. Screw the wheel nuts until they touch the lips around the mounting holes, then stop rotating.

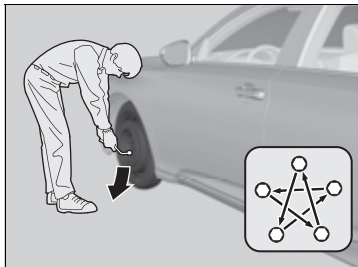

5. Lower the vehicle and remove the jack. Tighten the wheel nuts in the order indicated in the image. Go around, tightening the nuts, two to three times in this order.

Wheel nut torque:

80 lbf-ft (108 N-m, 11 kgf-m)

▣ Replacing the Flat Tire

Do not over tighten the wheel nuts by applying extra torque using your foot or a pipe.

■ Storing the Flat Tire

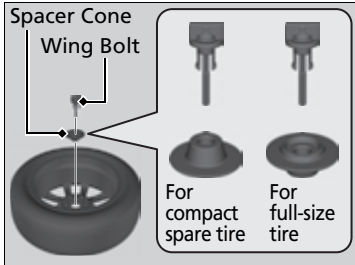
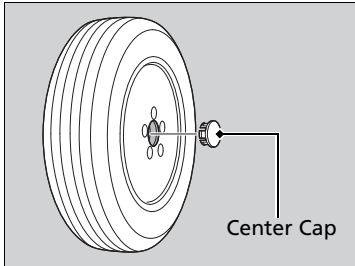

1. Remove the center cap.

2. Place the flat tire face down in the spare tire well.

3. Remove the spacer cone from the wing bolt, flip it over, and insert it back on the bolt. Secure the flat tire with the wing bolt.

4. Securely put the jack and wheel nut wrench back in the tool case. Store the case in the trunk.

■ TPMS and the Compact Spare Tire

If you replace a flat tire with the spare tire, the low tire pressure/TPMS indicator comes on while you are driving. After driving for a few miles (kilometers), **Tire Pressure Monitor System Problem. Check Tire Pressure. See Your Dealer.** will appear on the driver information interface and the indicator will start blinking for a short time and then stay on; however, this is normal and is no cause for concern.

Calibrate the TPMS when you replace the tire with a specified regular tire.

▶ **TPMS Calibration** P. 446

▶▶ Storing the Flat Tire

⚠ WARNING

Loose items can fly around the interior in a crash and can seriously injure the occupants.

Store the wheel, jack, and tools securely before driving.

Checking the Engine

If the engine does not start, check the starter.

☒ Checking the Engine

If you must start the vehicle immediately, use an assisting vehicle or booster battery to jump start it.

☒ **If the Battery Is Dead** P. 606

Starter condition	Checklist
<p>Starter doesn't turn or turns over slowly.</p> <p>The battery may be dead. Check each of the items on the right and respond accordingly.</p>	<p>Check for a message on the driver information interface.</p> <ul style="list-style-type: none">• If the To Start, Hold Remote Near Start Button message appears<ul style="list-style-type: none">☒ If the Keyless Remote Battery is Weak P. 604▶ Make sure the keyless remote is in its operating range.<ul style="list-style-type: none">☒ ENGINE START/STOP Button Operating Range P. 191
<p>The starter turns over normally but the engine doesn't start.</p> <p>There may be a problem with a fuse. Check each of the items on the right and respond accordingly.</p>	<p>Check brightness of the interior lights.</p> <p>Turn on the interior lights and check the brightness.</p> <ul style="list-style-type: none">• If the interior lights are dim or do not come on at all<ul style="list-style-type: none">☒ Battery P. 584• If the interior lights come on normally<ul style="list-style-type: none">☒ Inspecting and Changing Fuses P. 625
<p>The starter turns over normally but the engine doesn't start.</p> <p>There may be a problem with a fuse. Check each of the items on the right and respond accordingly.</p>	<p>Review the engine start procedure.</p> <p>Follow its instructions, and try to start the engine again. ☒ Starting the Engine P. 412</p> <p>Check the immobilizer system indicator.</p> <p>When the immobilizer system indicator is blinking, the engine cannot be started.<ul style="list-style-type: none">☒ Immobilizer System P. 184</p>
<p>The starter turns over normally but the engine doesn't start.</p> <p>There may be a problem with a fuse. Check each of the items on the right and respond accordingly.</p>	<p>Check the fuel level.</p> <p>There should be enough fuel in the tank. ☒ Fuel Gauge P. 139</p>
<p>The starter turns over normally but the engine doesn't start.</p> <p>There may be a problem with a fuse. Check each of the items on the right and respond accordingly.</p>	<p>Check the fuses.</p> <p>Check all fuses, or have the vehicle checked by a dealer.<ul style="list-style-type: none">☒ Inspecting and Changing Fuses P. 625</p>
<p>The starter turns over normally but the engine doesn't start.</p> <p>There may be a problem with a fuse. Check each of the items on the right and respond accordingly.</p>	<p>If the problem continues:</p> <ul style="list-style-type: none">☒ Emergency Towing P. 626

If the Keyless Remote Battery is Weak

If the beeper sounds, the **To Start, Hold Remote Near Start Button** message appears on the driver information interface, and the **ENGINE START/STOP** button flashes, and the engine won't start, start the engine as follows:

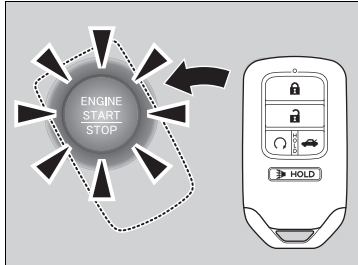

1. Touch the center of the **ENGINE START/STOP** button with the **H** logo on the keyless remote while the **ENGINE START/STOP** button is flashing. The buttons on the keyless remote should be facing you.
 - ▶ The **ENGINE START/STOP** button flashes for about 30 seconds.

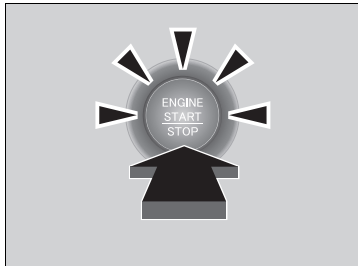

2. Depress the brake pedal and press the **ENGINE START/STOP** button within 10 seconds after the beeper sounds and the **ENGINE START/STOP** button changes from flashing to on.
 - ▶ If you don't depress the pedal, the mode will change to ACCESSORY.

Emergency Engine Stop

The **ENGINE START/STOP** button may be used to stop the engine due to an emergency situation even while driving. If you must stop the engine, do either of the following operations:

- Press and hold the **ENGINE START/STOP** button for about two seconds.
- Firmly press the **ENGINE START/STOP** button three times.

The steering wheel will not lock. However, because turning off the engine disables the power assist the engine provides to the steering and braking systems, it will require significantly more physical effort and time to steer and slow the vehicle. Use both feet on the brake pedal to slow down the vehicle and stop immediately in a safe place.

Automatic transmission models

The transmission automatically changes to **P** after the vehicle comes to a complete stop. Then, the power mode changes to VEHICLE OFF.

Continuously variable transmission models

The power mode is in ACCESSORY when the engine is stopped. To change the mode to VEHICLE OFF, put the transmission into **P** after the vehicle comes to a complete stop.

Continuously variable transmission models for Canadian models

Then, press the **ENGINE START/STOP** button twice without depressing the brake pedal.

Emergency Engine Stop

Do not press the **ENGINE START/STOP** button while driving unless it is absolutely necessary for the engine to be turned off. If you press the **ENGINE START/STOP** button while driving, the beeper sounds.

If the Battery Is Dead

Jump Starting Procedure

Turn off the power to electric devices, such as audio and lights. Turn off the engine, then open the hood.

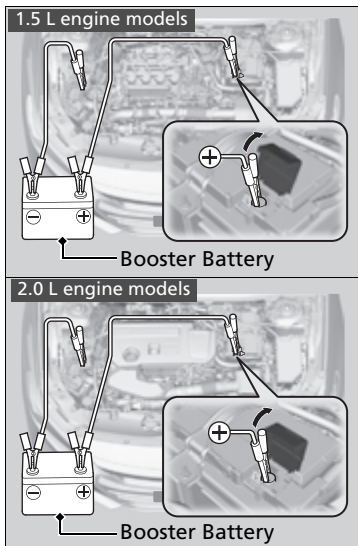

1. Open the cover on the positive \oplus terminal.
2. Connect the first jumper cable to your vehicle's battery \oplus terminal.
3. Connect the other end of the first jumper cable to the booster battery \oplus terminal.
 - ▶ Use a 12-volt booster battery only.
 - ▶ When using an automotive battery charger to boost your 12-volt battery, select a lower charging voltage than 15-volt. Check the charger manual for the proper setting.
4. Connect the second jumper cable to the booster battery \ominus terminal.

ⓘ If the Battery Is Dead

⚠ WARNING

A battery can explode if you do not follow the correct procedure, seriously injuring anyone nearby.

Keep all sparks, open flames, and smoking materials away from the battery.

Securely attach the jumper cables clips so that they do not come off when the engine vibrates. Be careful not to tangle the jumper cables or allow the cable ends to touch each other while attaching or detaching the jumper cables.

1.5 L engine models

Engine Mounting Bolt

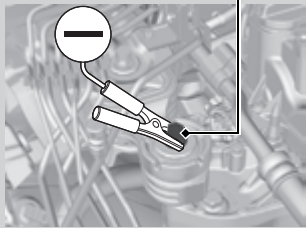

2.0 L engine models

Engine Mounting Bolt

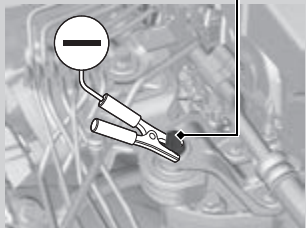

5. Connect the other end of the second jumper cable to the engine mounting bolt as shown. Do not connect this jumper cable to any other part.
6. If your vehicle is connected to another vehicle, start the assisting vehicle's engine and increase its rpm slightly.
7. Attempt to start your vehicle's engine. If it turns over slowly, check that the jumper cables have good metal-to-metal contact.

⚠ If the Battery Is Dead

Battery performance degrades in cold conditions and may prevent the engine from starting.

Continued

■ What to Do After the Engine Starts

Once your vehicle's engine has started, remove the jumper cables in the following order.

1. Disconnect the jumper cable from your vehicle's ground.
2. Disconnect the other end of the jumper cable from the booster battery ⊖ terminal.
3. Disconnect the jumper cable from your vehicle's battery ⊕ terminal.
4. Disconnect the other end of the jumper cable from the booster battery ⊕ terminal.

Have your vehicle inspected by a nearby service station or a dealer.

⌘ What to Do After the Engine Starts

The Vehicle Stability Assist™ (VSA®) system, Vehicle Stability Assist™ (VSA®) **OFF**, adaptive cruise control (ACC) with Low Speed Follow, safety support and low tire pressure/TPMS indicators may come on in amber along with a message in the driver information interface when you set the power mode to ON after reconnecting the battery.

Drive a short distance at more than 12 mph (20 km/h). Each indicator should go off. If any do not, have your vehicle checked by a dealer.

Shift Lever Does Not Move

Continuously variable transmission models

Follow the procedure below if you cannot move the shift lever out of the **P** position.

Releasing the Lock

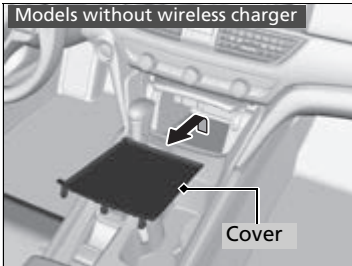

1. Set the parking brake.
2. Remove the built-in key from the keyless remote.
3. Open the center pocket.
➤ **Center Pocket** P. 225

Models without wireless charger

4. Remove the cover in the center pocket.

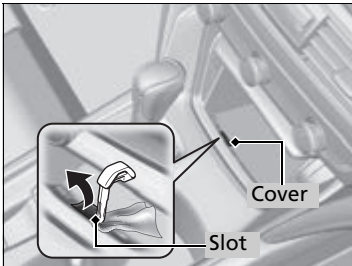

All models

5. Wrap a cloth around the tip of the built-in key. Put it into the shift lock release slot (as shown in the image) and remove the cover.

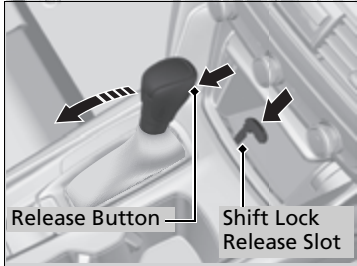

6. Insert the key into the shift lock release slot.
7. While pushing the key down, press the shift lever release button, and place the shift lever into **N**.
 - ▶ The lock is now released. Have the shift lever checked by a dealer as soon as possible.

How to Handle Overheating

Overheating symptoms are as follows:

- The temperature gauge pointer is at the **H** mark or the engine suddenly loses power.
- The **Engine Temperature Too Hot. Do Not Drive. Allow Engine To Cool.** message appears on the driver information interface.
- Steam or spray comes out of the engine compartment.

■ First thing to do

1. Immediately park the vehicle in a safe place.
2. Turn off all accessories and turn on the hazard warning lights.
 - ▶ **No steam or spray present:** Keep the engine running and open the hood.
 - ▶ **Steam or spray is present:** Turn off the engine and wait until it subsides. Then, open the hood.

🔧 How to Handle Overheating

⚠️ WARNING

Steam and spray from an overheated engine can seriously scald you.

Do not open the hood if steam is coming out.

NOTICE

Continuing to drive with the temperature gauge pointer at the **H** mark may damage the engine.

Continuing to drive with the **Engine Temperature Too Hot. Do Not Drive. Allow Engine To Cool.** message on the driver information interface may damage the engine.

■ Next thing to do

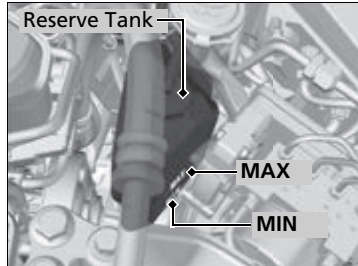

1. Check that the cooling fan is operating and stop the engine once the temperature gauge pointer comes down.
 - If the cooling fan is not operating, immediately stop the engine.
2. Once the engine has cooled down, inspect the coolant level and check the cooling system components for leaks.
 - If the coolant level in the reserve tank is low, add coolant until it reaches the **MAX** mark.
 - If there is no coolant in the reserve tank, check that the radiator is cool. Cover the radiator cap with a heavy cloth and open the cap. If necessary, add coolant up to the base of the filler neck, and put the cap back on.

■ Last thing to do

Once the engine has cooled sufficiently, restart it and check the temperature gauge. If the temperature gauge pointer has come down, resume driving. If it has not come down, contact a dealer for repairs.

► How to Handle Overheating

⚠ WARNING

Removing the radiator cap while the engine is hot can cause the coolant to spray out, seriously scalding you.

Always let the engine and radiator cool down before removing the radiator cap.

If the coolant is leaking, contact a dealer for repairs.

Use water as an emergency/temporary measure only. Have a dealer flush the system with proper antifreeze as soon as possible.

If the Low Oil Pressure Warning Appears

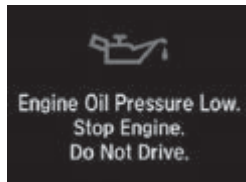

■ Reasons for the warning to appear

Appears when the engine oil pressure is low.

■ What to do as soon as the warning appears

1. Immediately park the vehicle on level ground in a safe place.
2. If necessary, turn the hazard warning lights on.

■ What to do after parking the vehicle

1. Stop the engine and let it sit for approximately three minutes.
2. Open the hood and check the oil level.
 - ▶ Add oil as necessary.
 - ▶ **Oil Check** P. 552
3. Start the engine and check the low oil pressure warning.
 - ▶ The warning disappears: Start driving again.
 - ▶ The warning does not disappear within 10 seconds: Immediately stop the engine and contact a dealer for repairs.

⌘ If the Low Oil Pressure Warning Appears

NOTICE

Running the engine with low oil pressure can cause serious mechanical damage almost immediately.

If the Charging System Indicator Comes On



■ Reasons for the indicator to come on

Comes on when there is a problem with the charging system.

■ What to do when the indicator comes on

Stop in a safe place and have your vehicle checked by a dealer immediately.

⌘ If the Charging System Indicator Comes On

If you need to stop temporarily, do not turn off the engine. Restarting the engine may rapidly discharge the battery.

If the Malfunction Indicator Lamp Comes On or Blinks



■ Reasons for the indicator lamp to come on or blink

- Comes on when there is a problem with the engine emissions control system.
- Blinks when engine misfiring is detected.

■ What to do when the indicator lamp comes on

Avoid high speeds and immediately get your vehicle inspected at a dealer.

■ What to do when the indicator lamp blinks

Park the vehicle in a safe place with no flammable items and wait at least 10 minutes or more with the engine stopped until it cools.

▶▶ If the Malfunction Indicator Lamp Comes On or Blinks

NOTICE

If you drive with the malfunction indicator lamp on, the emissions control system and the engine could be damaged.

If the malfunction indicator lamp blinks again when restarting the engine, drive to the nearest dealer at 31 mph (50 km/h) or less. Have your vehicle inspected.

If the Brake System Indicator (Red) Comes On or Blinks



■ Reasons for the indicator to come on

- The brake fluid is low.
- There is a malfunction in the brake system.

■ What to do when the indicator comes on while driving

Depress the brake pedal lightly to check pedal pressure.

- If normal, check the brake fluid level the next time you stop.
- If abnormal, take immediate action. If necessary, downshift the transmission to slow the vehicle using engine braking.

■ Reasons for the indicator to blink

There is a problem with the electric parking brake system.

■ What to do when the indicator blinks

Avoid using the parking brake and have your vehicle checked by a dealer immediately.

▶▶ If the Brake System Indicator (Red) Comes On or Blinks

Have your vehicle repaired immediately.

It is dangerous to drive with low brake fluid. If there is no resistance from the brake pedal, stop immediately in a safe place. If necessary, downshift the gears.

If the brake system indicator (red) and **ABS** indicator come on simultaneously, the electronic brake distribution system is not working. This can result in vehicle instability under sudden braking. Have your vehicle inspected by a dealer immediately.

If the brake system indicator (red) blinks at the same time when the brake system indicator (amber) comes on, the parking brake may not work. Avoid using the parking brake and have your vehicle checked by a dealer immediately.

▶▶ **If the Brake System Indicator (Red) Comes On or Blinks at the Same Time When the Brake System Indicator (Amber) Comes On**
P. 616

If the Brake System Indicator (Red) Comes On or Blinks at the Same Time When the Brake System Indicator (Amber) Comes On



■ **If the brake system indicator (red) comes on or blinks at the same time when the brake system indicator (amber) comes on, release the parking brake manually or automatically.**

▶ **Parking Brake** P. 508

- If the brake system indicator (red) continuously comes on or blinks at the same time when the brake system indicator (amber) comes on, stop the vehicle in a safe place and have it inspected by a dealer immediately.

▶ Preventing the vehicle from moving, put the transmission into **P**.

- If only the brake system indicator (red) is turned off, avoid using the parking brake and have your vehicle checked by a dealer immediately.



▶ If the Brake System Indicator (Red) Comes On or Blinks at the Same Time When the Brake System Indicator (Amber) Comes On

If you apply the parking brake, you may not be able to release it.

If the brake system indicator (red) and the brake system indicator (amber) come on at the same time, the parking brake is working.

If the brake system indicator (red) blinks at the same time when the brake system indicator (amber) comes on, the parking brake may not work because it is checking the system.

If you repeatedly operate the electric parking brake in a short period of time, the brake stops operating to prevent heating of the system and the indicator blinks. It returns to its original state in approximately 1 minute.

If the Electric Power Steering (EPS) System Indicator Comes On



■ Reasons for the indicator to come on

Comes on when there is a problem with the EPS system.

■ What to do when the indicator comes on

Stop the vehicle in a safe place and restart the engine.

If the indicator comes on and stays on, immediately have your vehicle inspected by a dealer.

If the Low Tire Pressure/TPMS Indicator Comes On or Blinks



■ Reasons for the indicator to come on or blink

A tire pressure is significantly low, or the TPMS has not been calibrated. If there is a problem with the TPMS, the indicator blinks for about one minute, and then stays on.

If the compact spare tire is installed, the indicator will either come on or it will first blink for about one minute, then stay on.

■ What to do when the indicator comes on

Drive carefully and avoid abrupt cornering and hard braking.

Stop your vehicle in a safe place. Check the tire pressure and adjust the pressure to the specified level. The specified tire pressure is on a label on the driver side doorjamb.

▶ Calibrate the TPMS after the tire pressure is adjusted.

➤ **TPMS Calibration** P. 446

If the compact spare tire causes the indicator to come on, change the tire to a full-size tire. The indicator goes off after calibrating the TPMS.

■ What to do when the indicator blinks, then remains on

Have the tire inspected by a dealer as soon as possible. If the compact spare tire causes the indicator to first blink, and then stay on, change the tire to a full-size tire. The indicator goes off after calibrating the TPMS.

➤ **TPMS Calibration** P. 446

▶▶ If the Low Tire Pressure/TPMS Indicator Comes On or Blinks

NOTICE

Driving on an extremely underinflated tire can cause it to overheat. An overheated tire can fail. Always inflate your tires to the prescribed level.

Automatic transmission models

If the Transmission System Indicator Blinks along with the Warning Message

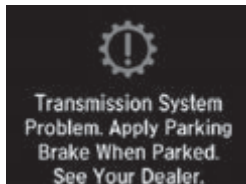

■ Reasons for the indicator to blink

The transmission is malfunctioning.

■ What to do when the indicator blinks

- Immediately have your vehicle inspected by a dealer.
- Put the transmission into **N** after starting the engine.
 - ▶ Check if the **N** position on the driver information interface and the indicator on the **N** button light/blink.
 - **Starting the Engine** P. 412

☒ If the Transmission System Indicator Blinks along with the Warning Message

You may not be able to start the engine.

Make sure to set the parking brake when parking your vehicle.

Call a professional towing service if you need to tow your vehicle.

➤ **Emergency Towing** P. 626

Fuse Locations

If any electrical devices are not working, set the power mode to VEHICLE OFF and check to see if any applicable fuse is blown.

■ Engine Compartment Fuse Box

Located near the battery. Push the tabs to open the box.

Fuse locations are shown on the fuse box cover. Locate the fuse in question by the fuse number and box cover number.

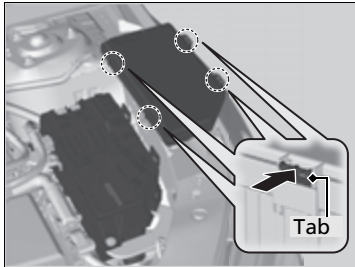

■ Circuit protected and fuse rating

	Circuit Protected	Amps
1	BATTERY	125 A
	–	(70 A)
	EPS	70 A
2	–	(30 A)
	FUSE BOX MAIN 2	60 A
	EBB	40 A
	ABS/VSA FSR	40 A
	–	(30 A)
3	IG MAIN1	30 A
	REAR DEFROSTER	40 A
	FUSE BOX MAIN 1	60 A
	–	(30 A)
	HEATER MOTOR	40 A
	–	(40 A)
	ST MG	30 A
	SUB FAN MOTOR	30 A
	VST1*	(30 A)
	VST2*	(30 A)
4	FUSE BOX OP 2*	(70 A)
	–	(40 A)
	FUSE BOX OP 1	60 A

	Circuit Protected	Amps
5	–	(40 A)
	MAIN FAN MOTOR	30 A
	SPM2	30 A
	ABS/VSA MOTOR	40 A
	IG MAIN2	30 A
	WIPER MOTOR	30 A
6	SRM1	30 A
7	–	–
8	–	–
9	STOP LIGHT	10 A
10	TCU	(15 A)
11	INJ	20 A
12	TCU2*	(10 A)
13	IGP	15 A
14	TCU3*	(10 A)
15	FI ECU	10 A
16	BATT SNSR	7.5 A
17	DBW	15 A
18	IG COIL	15 A
19	HAZARD	15 A
20	–	–
21	–	–
22	H/STRG*	(10 A)
23	–	–
24	AUDIO	15 A
25	REAR H/SEAT*	(20 A)
26	FR WIPER DEICER*	(15 A)

	Circuit Protected	Amps
27	BACK UP	10 A
28	HORN	10 A
29	FR FOG LIGHT*	(10 A)
30	SHUTTER GRILLE*	(7.5 A)
31	MG CLUTCH	10 A
32	WASHER MOTOR	15 A
33	–	–
34	ACL	(10 A)
35	AUDIO SUB*	(7.5 A)
36	IGPS	7.5 A
37	IGPS (LAF)	7.5 A
38	VB ACT	7.5 A
39	IG1 TCU	(10 A)
40	IG1 FUEL PUMP	20 A
41	IG1 ABS/VSA	7.5 A
42	IG1 ACG	10 A
43	IG1 ST MOTOR	10 A
44	IG1 MONITOR	7.5 A
45	BACK UP2	(30 A)

* Not available on all models

■ Interior Main Fuse Box

Located under the dashboard.

Fuse locations are shown on the label on the side panel.

Locate the fuse in question by the fuse number and label number.

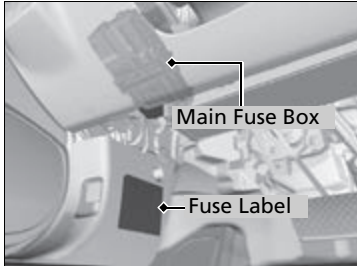

■ **Circuit protected and fuse rating**

	Circuit Protected	Amps
1	–	–
2	L SIDE DOOR UNLOCK	10 A
3	R SIDE DOOR UNLOCK	10 A
4	ACC	10 A
5	ACC KEY LOCK	7.5 A
6	SRS	10 A
7	–	–
8	IG HOLD2*	(10 A)
9	SMART	10 A
10	–	–
11	L SIDE DOOR LOCK	10 A
12	DR DOOR LOCK	(10 A)
13	R SIDE DOOR LOCK	10 A
14	OPTION	10 A
15	DRL	10 A
16	CTR ACC SOCKET	(20 A)
17	MOON ROOF*	(20 A)
18	–	–
19	–	–
20	SBW ECU*	(10 A)
21	DR DOOR UNLOCK	(10 A)
22	–	–
23	–	–
24	PREMIUM AMP*	(20 A)
25	–	–

	Circuit Protected	Amps
26	–	–
27	–	–
28	–	–
29	–	–
30	–	–
31	–	–
32	IG HOLD3*	(15 A)
33	DR P/SEAT SLI*	(20 A)
34	AS P/SEAT SLI*	(20 A)
35	OPTION2	10 A
36	METER	10 A
37	OPTION1	10 A
38	DR P/SEAT REC *	(20 A)
39	AS P/SEAT REC *	(20 A)
40	DR P/LUMBAR*	(10 A)
41	–	–
42	AVS*	(20 A)
43	OPTION	10 A
44	ADS*	(20 A)
45	–	–
46	SRS	10 A
47	–	–
48	HUD*	(10 A)
49	DOOR LOCK	20 A
50	FR ACC SOCKET	20 A
51	RR R P/W	20 A
52	RR L P/W	20 A

	Circuit Protected	Amps
53	AS P/W	20 A
54	DR P/W	20 A
55	–	–

* Not available on all models

Models with Auto Idle Stop

Interior Sub Fuse Box

Located under the dashboard.
 Fuse locations are shown on the label on the side panel.
 Locate the fuse in question by the fuse number and label number.

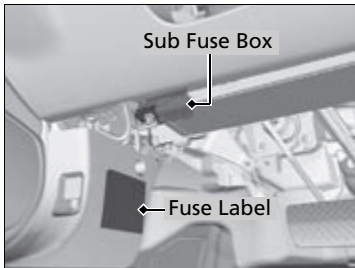

■ Circuit protected and fuse rating

	Circuit Protected	Amps
1	VST ACC 1	7.5 A
2	BACKUP2 MAIN	15 A
3	EOP	7.5 A
4	BACKUP3	7.5 A
5	EBB	7.5 A
6	METER VST	7.5 A
7	VSA/ABS	7.5 A

Inspecting and Changing Fuses

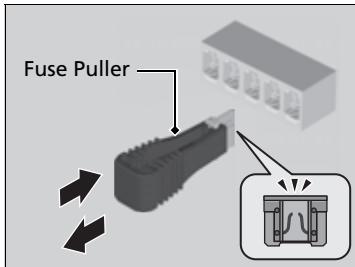
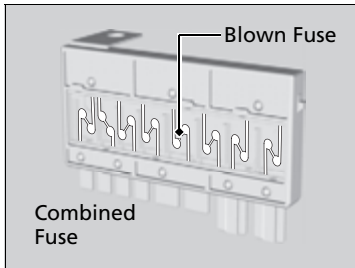

1. Set the power mode to VEHICLE OFF. Turn headlights and all accessories off.
2. Open the fuse box cover in the engine compartment.
3. Check the large fuse in the engine compartment.
 - ▶ If the fuse is blown, use a Phillips-head screwdriver to remove the screw and replace it with a new one.
4. Inspect the small fuses in the engine compartment and the vehicle interior.
 - ▶ If there is a blown fuse, remove it with the fuse puller and replace it with a new one.

Inspecting and Changing Fuses

NOTICE

Replacing a fuse with one that has a higher rating greatly increases the chances of damaging the electrical system.

Use the charts to locate the fuse in question and confirm the specified amperage on the fuse label.

▶ Fuse Locations P. 620

Replace fuse with a spare fuse of the same specified amperage.

There is a fuse puller on the back of the engine compartment fuse box cover.

Call a professional towing service if you need to tow your vehicle.

■ Flatbed equipment

The operator loads your vehicle on the back of a truck.

This is the best way to transport your vehicle.

■ Wheel lift equipment

The tow truck uses two pivoting arms that go under the front tires and lift them off the ground. The rear tires remain on the ground. **This is an acceptable way to**

tow your vehicle.

» Emergency Towing

NOTICE

Trying to lift or tow your vehicle by the bumpers will cause serious damage. The bumpers are not designed to support the vehicle's weight.

Make sure the parking brake is released. If you cannot release the parking brake, your vehicle must be transported by the flatbed equipment.

➤ **Parking Brake** P. 508

NOTICE

Improper towing such as towing behind a motorhome or other motor vehicle can damage the transmission.

Never tow your vehicle with just a rope or chain. It is very dangerous, since ropes or chains may shift from side to side or break.

If You Cannot Unlock the Fuel Fill Door

■ What to Do If Unable to Unlock the Fuel Fill Door

If you cannot unlock the fuel fill door, use the following procedure.

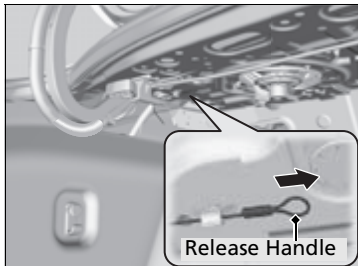

1. Open the trunk.
2. Pull the release handle toward you.
 - ▶ The release handle unlocks the fuel fill door when it is pulled.
3. Open the fuel fill door.

➤ **How to Refuel** P. 532

☒ If You Cannot Unlock the Fuel Fill Door

After taking these steps, contact a dealer to have the vehicle checked.

If You Cannot Open the Trunk

What to Do If Unable to Open the Trunk

If you cannot open the trunk, use the following procedure.

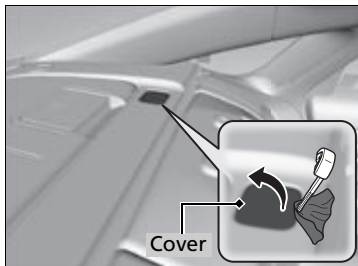

Models with adjustable headrest

1. Remove the driver side rear outer head restraint.

➤ Removing and Reinstalling the Head Restraints P. 221

All models

2. Remove the built-in key from the keyless remote.
3. Wrap a cloth around the tip of the built-in key. Put it into the cover (as shown in the image) and remove the cover.

Models with the cylinder in the cover

4. Insert the key into the cylinder and turn it clockwise.
▶ The trunk unlocks and opens.

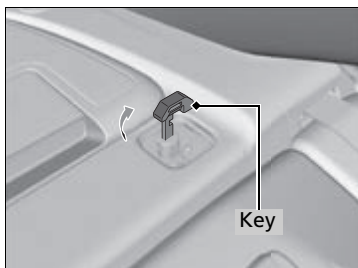

➤ If You Cannot Open the Trunk

Following up:

After taking these steps, contact a dealer to have the vehicle checked.

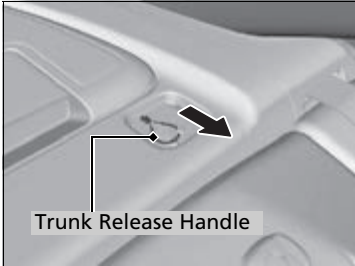

Models without the cylinder in the cover

- 4.** Pull the trunk release handle up in the direction of the arrow in the image.
 - ▶ The trunk unlocks and opens.

Refueling From a Portable Fuel Container

If you have run out of fuel and need to refuel your vehicle from a portable fuel container, use the funnel provided with your vehicle.

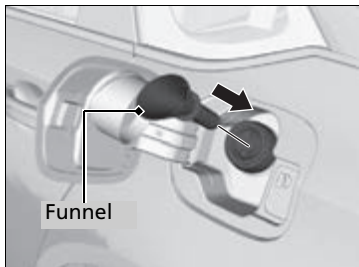

1. Turn off the engine.
2. Press on the edge of the fuel fill door until you hear a click when the driver's door is unlocked.
 - ▶ The fuel fill door opens.
3. Take the funnel out of the tool case in the trunk.
 - ▶ **Types of Tools** P. 596
4. Place the end of the funnel on the lower part of filler opening, then insert it slowly and fully.
 - ▶ Make sure that the end of the funnel goes down along with the filler pipe.
5. Fill the tank with fuel from the portable fuel container.
 - ▶ Pour fuel carefully so you do not spill any.
6. Remove the funnel from the filler neck.
 - ▶ Wipe up any fuel from the funnel before storing it.
7. Shut the fuel fill door by hand.

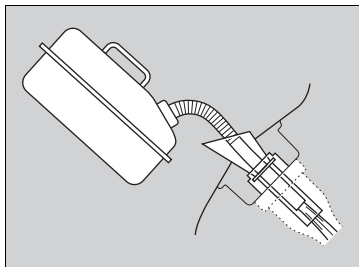

▶▶ Refueling From a Portable Fuel Container

⚠ WARNING

Gasoline is highly flammable and explosive. You can be burned or seriously injured when handling fuel.

- Stop the engine, and keep heat, sparks, and flames away.
- Handle fuel only outdoors.
- Wipe up spills immediately.

NOTICE

Do not insert the nozzle of a portable fuel container or any funnel other than the one provided with your vehicle. Doing so can damage the fuel system. Do not try to pry open or push open the sealed fuel tank with foreign objects. This can damage the fuel system and its seal.

Make sure the fuel in the portable fuel container is gasoline before you refuel.

Information

This chapter includes your vehicle's specifications, locations of identification numbers, and other information required by regulation.

Specifications	632
Identification Numbers	
Vehicle Identification Number (VIN), Engine Number, and Transmission Number	636
Devices that Emit Radio Waves	637
Reporting Safety Defects	638
Emissions Testing	
Testing of Readiness Codes.....	639
Warranty Coverages	641
Authorized Manuals	644
Customer Service Information	645

1.5 L engine models

Vehicle Specifications

Model	ACCORD
No. of Passengers:	
Front	2
Rear	3
Total	5
Weights:	
Gross Vehicle Weight Rating	See the certification label on the driver's doorjamb
Gross Axle Weight Rating (Front)	See the certification label on the driver's doorjamb
Gross Axle Weight Rating (Rear)	See the certification label on the driver's doorjamb

Air Conditioning

Refrigerant Type	HFO-1234yf (R-1234yf)
Charge Quantity	13.9 – 15.7 oz (395 – 445 g)
Lubricant Type	ND-OIL 14
Quantity	5.6 – 6.5 cu-in (92 – 107 cm ³)

Engine Specifications

Displacement	91 cu-in (1,498 cm ³)
Spark Plugs	NGK DILKAR8P8SY

Fuel

Type	Unleaded gasoline, Pump octane number of 87 or higher
Fuel Tank Capacity	14.8 US gal (56 L)

Washer Fluid

Tank Capacity	U.S.: 2.6 US qt (2.5 L) Canada: 4.8 US qt (4.5 L)
---------------	--

Light Bulbs

Headlights (Low Beam)	LED
Headlights (High Beam)	60W (HB3)* ¹ LED* ²
Fog Lights*	LED
Parking/Daytime Running Lights	LED
Front Turn Signal Lights	LED
Front Side Marker Lights	LED
Side Turn Signal Lights (on Door Mirrors)*	LED
Brake Lights	LED
Rear Turn Signal Lights	21W (Amber)
Rear Side Marker Lights	LED
Taillights	LED
Back-Up Lights	16W
High-Mount Brake Light	LED
Rear License Plate Light	LED
Interior Lights	
Map Lights	8W
Ceiling Light	8W
Ambient Lights	LED
Vanity Mirror Lights	1.4W
Center Pocket Light	LED
Door Courtesy Lights*	2CP (3.8W)
Door Inner Handle Lights*	LED
Trunk Light	5W

*1: Models with halogen high beam headlights

*2: Models with LED high beam headlights

■ Brake Fluid

Specified	Honda Heavy Duty Brake Fluid DOT 3
-----------	------------------------------------

■ Continuously Variable Transmission Fluid

Specified	Honda HCF-2
Capacity	Change 3.9 US qt (3.7 L)

■ Engine Oil

Recommended	·Honda Genuine Motor Oil 0W-20	
	·API Premium-grade 0W-20 detergent oil	
Capacity	Change	3.4 US qt (3.2 L)
	Change including filter	3.7 US qt (3.5 L)

■ Engine Coolant

Specified	Honda Long-Life Antifreeze/Coolant Type2
Ratio	50/50 with distilled water
Capacity	1.59 US gal (6.03 L)
	(change including the remaining 0.17 US gal (0.66 L) in the reserve tank)

■ Tire

Regular	Size	225/50R17 94V ^{*1}
		235/40R19 96V ^{*2}
Pressure psi (kPa [kgf/cm ²])	Front	32 (220 [2.2]) ^{*1}
	Rear	33 (225 [2.25]) ^{*2}
Compact Spare	Size	T135/90D16 102M ^{*1}
		T135/80D17 103M ^{*2}
Wheel Size	Regular	17 x 7 1/2J ^{*1}
	Compact Spare	16 x 4T ^{*1}
		17 x 4T ^{*2}

*1: Models with 17 inch wheel

*2: Models with 19 inch wheel

2.0 L engine models

Vehicle Specifications

Model	ACCORD
No. of Passengers:	
Front	2
Rear	3
Total	5
Weights:	
Gross Vehicle Weight Rating	See the certification label on the driver's doorjamb
Gross Axle Weight Rating (Front)	See the certification label on the driver's doorjamb
Gross Axle Weight Rating (Rear)	See the certification label on the driver's doorjamb

Air Conditioning

Refrigerant Type	HFO-1234yf (R-1234yf)
Charge Quantity	13.9 – 15.7 oz (395 – 445 g)
Lubricant Type	ND-OIL 14
Quantity	5.6 – 6.5 cu-in (92 – 107 cm ³)

Engine Specifications

Displacement	122 cu-in (1,996 cm ³)
Spark Plugs	NGK DILKAR8P8SY

Fuel

Type	Unleaded gasoline, Pump octane number of 87 or higher
Fuel Tank Capacity	14.8 US gal (56 L)

Washer Fluid

Tank Capacity	U.S.: 2.6 US qt (2.5 L) Canada: 4.8 US qt (4.5 L)
---------------	--

Light Bulbs

Headlights (Low Beam)	LED
Headlights (High Beam)	LED
Fog Lights	LED
Parking/Daytime Running Lights	LED
Front Turn Signal Lights	LED
Front Side Marker Lights	LED
Side Turn Signal Lights (on Door Mirrors)*	LED
Brake Lights	LED
Rear Turn Signal Lights	21W (Amber)
Rear Side Marker Lights	LED
Taillights	LED
Back-Up Lights	16W
High-Mount Brake Light	LED
Rear License Plate Light	LED
Interior Lights	
Map Lights	8W
Ceiling Light	8W
Ambient Lights	LED
Vanity Mirror Lights	1.4W
Center Pocket Light	LED
Door Courtesy Lights*	2CP (3.8W)
Door Inner Handle Lights*	LED
Trunk Light	5W

■ Brake Fluid

Specified	Honda Heavy Duty Brake Fluid DOT 3
-----------	------------------------------------

■ Automatic Transmission Fluid

Specified	Honda Automatic Transmission Fluid ATF-type 2.0	
Capacity	Change	4.5 US qt (4.3 L)

■ Engine Oil

Recommended	·Honda Genuine Motor Oil 0W-20	
	·API Premium-grade 0W-20 detergent oil	
Capacity	Change	4.6 US qt (4.4 L)
	Change including filter	5.0 US qt (4.8 L)

■ Engine Coolant

Specified	Honda Long-Life Antifreeze/Coolant Type2	
Ratio	50/50 with distilled water	
Capacity	1.34 US gal (5.06 L)	
	(change including the remaining 0.17 US gal (0.66 L) in the reserve tank)	

■ Tire

Regular	Size	235/40R19 96V	
	Pressure psi (kPa [kgf/cm ²])	Front	33 (225 [2.25])
Rear		33 (225 [2.25])	
Compact Spare	Size	T135/80D17 103M	
	Pressure psi (kPa [kgf/cm ²])	60 (420 [4.2])	
Wheel Size		Regular	19 x 8 1/2J
	Compact Spare	17 x 4T	

Vehicle Identification Number (VIN), Engine Number, and Transmission Number

Your vehicle has a 17-digit vehicle identification number (VIN) used to register your vehicle for warranty purposes, and for licensing and insuring your vehicle.

The locations of your vehicle's VIN, engine number, and transmission number are shown as follows.

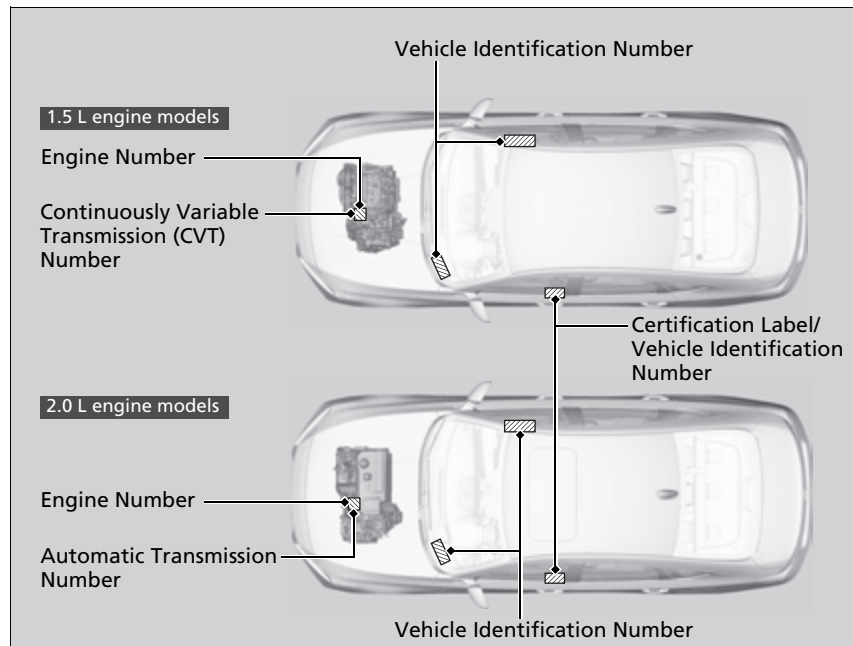

Vehicle Identification Number (VIN), Engine Number, and Transmission Number

The interior vehicle identification number (VIN) is located under the cover.

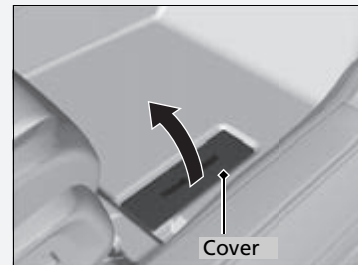

Each radio frequency device installed in the vehicle conforms to the requirements and standards of the regulation listed below:

As required by the FCC:

This device complies with Part 15 of the FCC rules. Operation is subject to the following two conditions: (1) This device may not cause harmful interference, and (2) this device must accept any interference received, including interference that may cause undesired operation.

Changes or modifications not expressly approved by the party responsible for compliance could void the user's authority to operate the equipment.

This device complies with Industry Canada licence-exempt RSS standard(s).

Operation is subject to the following two conditions: (1) this device may not cause interference, and (2) this device must accept any interference, including interference that may cause undesired operation of the device.

In the U.S.

If you believe that your vehicle has a defect which could cause a crash or could cause injury or death, you should immediately inform the National Highway Traffic Safety Administration (NHTSA) in addition to notifying American Honda Motor Co., Inc.

If NHTSA receives similar complaints, it may open an investigation, and if it finds that a safety defect exists in a group of vehicles, it may order a recall and remedy campaign. However, NHTSA cannot become involved in individual problems between you, your dealer, or American Honda Motor Co., Inc.

To contact NHTSA, you may call the Vehicle Safety Hotline toll-free at 1-888-327-4236 (TTY: 1-800-424-9153); go to <http://www.safercar.gov>; or write to: Administrator, NHTSA, 1200 New Jersey Avenue, SE., Washington, DC 20590. You can also obtain other information about motor vehicle safety from <http://www.safercar.gov>.

In Canada

If you believe that your vehicle has a defect which could cause a crash or could cause injury or death, you should immediately inform Honda Canada Inc. and you may also inform Transport Canada.

If Transport Canada receives similar complaints, it may open an investigation, and if it finds that a safety defect exists in a group of vehicles, it may lead to a recall and remedy campaign. However, Transport Canada cannot become involved in individual problems between you, your dealer, or Honda Canada Inc.

To contact Transport Canada's Defect Investigations and Recalls Division, you may call 1-800-333-0510. For more information on reporting safety defects or about motor vehicle safety, go to <http://www.tc.gc.ca/roadsafety>.

Testing of Readiness Codes

Your vehicle has readiness code as part of the onboard self diagnostic system. Some states use these codes for testing to verify whether your vehicle's emissions components are working properly.

The codes may not be read properly if testing is performed just after the battery has gone dead or been disconnected.

To check if they are set, set the power mode to ON, without starting the engine. The malfunction indicator lamp will come on for several seconds. If it then goes off, the readiness codes are set. If it blinks five times, the readiness codes are not set.

If you are required to have your vehicle tested before the readiness codes are ready, prepare the vehicle for retesting by doing the following:

1. Fill the gas tank to approximately 3/4 full.
2. Park the vehicle and leave the engine off for 6 hours or more.
3. Make sure the ambient temperature is between 40°F and 95°F (4°C and 35°C).
4. Start the engine without touching the accelerator pedal, and let it idle for 20 seconds.
5. Keep the vehicle in **P**. Increase the engine speed to 2,000 rpm, and hold it there for about 3 minutes.
6. Let the engine idle with your foot off the accelerator for 20 seconds.

Testing of Readiness Codes

The readiness codes are erased when the battery is disconnected, and set again only after several days of driving under a variety of conditions.

If a testing facility determines that the readiness codes are not set, you may be requested to return at a later date to complete the test.

If the testing facility determines the readiness codes are still not set, see a dealer.

7. Select a nearby, lightly traveled major highway where you can maintain a speed of 50 to 60 mph (80 to 97 km/h) for at least 20 minutes. Drive on the highway in **D**. Do not use cruise control. When traffic allows, drive for 90 seconds without moving the accelerator pedal. (Vehicle speed may vary slightly; this is okay.) If you cannot do this for a continuous 90 seconds because of traffic conditions, drive for at least 30 seconds, then repeat it two more times (for a total of 90 seconds).
8. Drive in city or suburban traffic for at least 10 minutes. When traffic conditions allow, let the vehicle coast for several seconds without using the accelerator pedal or the brake pedal.
9. Park the vehicle and leave the engine off for 30 minutes.

■ U.S. Owners

Your new vehicle is covered by these warranties:

New Vehicle Limited Warranty – covers your new vehicle, except for the emissions control systems and accessories, against defects in materials and workmanship.

Emissions Control Systems Defects Warranty and Emissions Performance Warranty – these two warranties cover your vehicle's emissions control systems. Time, mileage, and coverage are conditional. Please read your warranty booklet for exact information.

Seat Belt Limited Warranty – a seat belt that fails to function properly is covered by a limited warranty. Please read your warranty booklet for details.

Rust Perforation Limited Warranty – all exterior body panels are covered against rusting from the inside out for the specified time period, regardless of mileage.

Accessory Limited Warranty – Honda accessories are covered under this warranty. Time and mileage limits depend on the type of accessory and other factors. Please read your warranty booklet for details.

Replacement Parts Limited Warranty – covers all Honda replacement parts against defects in materials and workmanship.

Replacement Battery Limited Warranty – provides prorated coverage for a replacement battery purchased from your dealer.

Replacement Muffler Lifetime Limited Warranty – provides coverage for as long as the purchaser of the muffler owns the vehicle.

Restrictions and exclusions apply to all these warranties. Please read the Honda warranty information booklet that came with your vehicle for precise information on warranty coverages. Your vehicle's original tires are covered by their manufacturer. Tire warranty information is in a separate booklet.

■ **Statement on Warranty Coverage for Aftermarket and Recycled Parts**

The Magnuson-Moss Warranty Act, 15 U.S.C. s.2301 et seq., makes it illegal for motor vehicle manufacturers to void a motor vehicle warranty or deny warranty coverage solely because an aftermarket or recycled part has been used to repair the vehicle or someone other than the authorized service provider performed service on the vehicle. This provision does not apply to a new motor vehicle purchased solely for commercial or industrial use.

Under federal law, a manufacturer may deny warranty coverage and charge for repairs to a vehicle if it is discovered that an aftermarket or recycled part installed on the vehicle is defective or was installed incorrectly and caused damage to another part of the vehicle otherwise covered under warranty. The Federal Trade Commission requires that a manufacturer demonstrate that an aftermarket or recycled part or service performed by a person other than an authorized service provider caused damage to another part of the vehicle otherwise covered under warranty before denying warranty coverage. Additionally, federal law allows a manufacturer to void a motor vehicle warranty or deny warranty coverage if the manufacturer provides the article or service to consumers free of charge under the warranty or the manufacturer has secured a waiver from the Federal Trade Commission.

■ **Canadian Owners**

Please refer to the warranty manual that came with your vehicle.

■ **EPA Contact Information**

An owner may obtain further information concerning emission warranties or report violations of the terms of the emission warranties by contacting:

Director,
Light-Duty Vehicle Center,
U.S. Environmental Protection Agency,
Attention: Warranty Claim
2000 Traverwood Drive,
Ann Arbor, MI 48105;
complianceinfo@epa.gov

■ Service Express

For electronic copies of service publications, you can purchase a subscription to Service Express. Visit www.techinfo.honda.com for pricing and options.

■ For U.S. Owners

Manuals can be purchased from Helm Incorporated. You can order a manual by phone at 1(800) 782-4356 (credit card orders only), or online at www.helminc.com.

■ For Canadian Owners

Please contact a dealer to order any manuals that you may require.

Honda dealership personnel are trained professionals who should be able to deal with any problems you may encounter with your vehicle. If, however, you are faced with a problem that they cannot resolve to your satisfaction, contact Honda Customer Services.

U.S. Owners

American Honda Motor Co., Inc.
Honda Automobile Customer Service
Mail Stop CHI-5
1919 Torrance Blvd.
Torrance, CA 90501-2746
Tel: 1 (800) 999-1009

Canadian Owners

Honda Canada Inc.
Customer Relations
180 Honda Boulevard
Markham, ON
L6C 0H9
Tel: 1-888-9-HONDA-9
Fax: 1-877-939-0909
E-mail: Honda_cr@ch.honda.com

In Puerto Rico and the U.S. Virgin Islands

Bella International
P.O. Box 190816
San Juan, PR 00919-0816
Tel: 1 (787) 620-7546

Customer Service Information

When you call or write, please give us the following information:

- Vehicle Identification Number
 - ▣ **Vehicle Identification Number (VIN), Engine Number, and Transmission Number P. 636**
- Date of purchase
- Odometer reading of your vehicle
- Your name, address, and telephone number
- A detailed description of the problem
- Name of the dealer who sold the vehicle to you

Numbers

7-Speed Manual Shift Mode	431
Operation	432

A

ABS (Anti-lock Brake System).....	516
Accessories and Modifications	593
Accessory Power Sockets	231
Adaptive Cruise Control (ACC) with Low Speed Follow	103, 104, 470
Adaptive Damper System	440
Additives	
Coolant	559
Engine Oil	551
Washer	563
Additives, Engine Oil	551
Adjusting	
Armrest	222
Front Seats	212
Head Restraints	219
Mirrors	210
Rear Seats	216
Steering Wheel	209
Agile Handling Assist	443
Air Conditioning System (Climate Control System)	240
Changing the Mode	240
Defrosting the Windshield and Windows	241
Dust and Pollen Filter	587

Recirculation/Fresh Air Mode	240
Sensors	243
Synchronized Mode	242
Using Automatic Climate Control	240
Air Pressure	576, 633, 635
Airbags	46
Advanced Airbags	52
After a Collision	49
Airbag Care	63
Event Data Recorder	0
Front Airbags (SRS)	49
Indicator	60, 93
Knee Airbags	54
Passenger Airbag Off Indicator	61
Sensors	46
Side Airbags	57
Side Curtain Airbags	59
AM/FM Radio	278
Android Auto	320
Anti-lock Brake System (ABS)	516
Indicator	93
Apple CarPlay	313
Armrest	222
AT&T Hotspot	311
Audio Remote Controls	250
Audio System	246
Adjusting the Sound	272
Audio/Information Screen	254
Display Setup	273
Error Messages	327
General Information	329

Home Screen	259
How to Update Wirelessly	266
How to Update with a USB Device	270
How to use Siri Eyes Free	312
iPod	293
Limitations for Manual Operation	274
MP3/WMA/AAC	296
Reactivating	249
Remote Controls	250
Security Code	249
Selecting an Audio Source	274
Status Area	264
System Updates	266
Theft Protection	249
USB Flash Drives	296, 330
USB Ports	247
Wallpaper Setup	257
Audio/Information Screen	254
Authorized Manuals	644
Auto Door Locking/Unlocking	180
Customize	368
Auto High-Beam	199
Indicator	94
Auto Idle Stop	435
Auto Idle Stop OFF Button	436
Automatic Brake Hold	513
Indicator	86, 513
Automatic Brake Hold System	
Indicator	86, 513
Automatic Intermittent Wipers	203
Automatic Lighting	196

Shift Lever Does Not Move.....	609
Shifting.....	427, 429
Controls	165
Coolant (Engine)	559
Adding to the Engine Coolant Reserve Tank.....	559
Adding to the Radiator.....	560
Overheating.....	611
Creeping (Automatic Transmission/ Continuously Variable Transmission)	419
Cross Traffic Monitor	525
Cup Holders	227
Customer Service Information	645
Customized Features	351

D

Daytime Running Lights	198
Dead Battery	606
Defaulting All the Settings	370
Defrosting the Windshield and Windows	241
Devices that Emit Radio Waves	637
Dimming	
Headlights.....	195
Rearview Mirror.....	210
Dipstick (Engine Oil)	552
Directional Signals (Turn Signal)	194
Door Mirrors	211

Doors	167
Auto Door Locking.....	180
Auto Door Unlocking.....	180
Door and Trunk Open Message.....	37
Keys.....	167
Locking/Unlocking the Doors from the Inside.....	177
Locking/Unlocking the Doors from the Outside.....	170
Lockout Prevention System.....	176
DOT Tire Quality Grading	578
Driver Attention Monitor	154
Driver Information Interface	140
Switching the Display.....	140
Warning and Information Messages.....	109
Driving	401
Automatic Transmission/Continuously Variable Transmission.....	419
Braking.....	508
Shifting Position.....	420, 427, 429
Starting the Engine.....	412
Driving Position Memory System	207
Driving Support Information	157
Dust and Pollen Filter	587

E

Eco Assist® System	12
ECON Button	434
Econ Mode	
Indicator.....	100

Elapsed Time	147
Electric Power Steering (EPS) System	
Indicator.....	95, 617
Electronic Stability Control (ESC)	441
Emergency	626
Emergency Engine Stop	605
Emergency Trunk Opener	183
Emissions Testing (Readiness Codes)	639
Engine	636
Coolant.....	559
Jump Starting.....	606
Oil.....	551
Starting.....	412
Engine Coolant	559
Adding to the Engine Coolant Reserve Tank.....	559
Adding to the Radiator.....	560
Overheating.....	611
Temperature Gauge.....	139
Engine Oil	551
Adding.....	554
Checking.....	552
Displaying Oil Life.....	542
Low Oil Pressure Warning.....	613
Recommended Engine Oil.....	551
ENGINE START/STOP Button	191
EPS (Electric Power Steering) System	617
Exhaust Gas Hazard	
(Carbon Monoxide).....	78
Exterior Care (Cleaning)	590
Exterior Mirrors	211

F

Features	245
Filters	
Dust and Pollen.....	587
Oil.....	555
Flat Tire	597
Floor Mats	589
Fluids	
Automatic Transmission.....	561
Brake.....	562
Continuously Variable Transmission.....	561
Engine Coolant.....	559
Windshield Washer.....	563
FM/AM Radio	278
Fog Lights	197
Indicator.....	97
Folding Down the Rear Seat	216
Foot Brake	512
Front Airbags (SRS)	49
Front Seat Heaters	237
Front Seat Heaters and Seat Ventilation	238
Front Seats	
Adjusting.....	212
Front Sensor Camera	504
Fuel	25, 531
Economy.....	534
Gauge.....	139
Instant Fuel Economy.....	145
Low Fuel Indicator.....	93
Range.....	145

Recommendation.....	531
Refueling.....	531
Fuel Economy and CO₂ Emissions	534
Fuel Fill Door	25, 532
Unable to Unlock.....	627
Fuses	620
Inspecting and Changing.....	625
Locations.....	620, 622, 624

G

Gasoline (Fuel)

Economy.....	534
Gauge.....	139
Information.....	531
Instant Fuel Economy.....	145
Low Fuel Indicator.....	93
Refueling.....	531

Gauges	139
Glass (care)	588, 591
Glove Box	225

H

Halogen Bulbs	564
Handling the Unexpected	595
HandsFreeLink® (HFL)	374
Automatic Import of Cellular Phonebook and Call History.....	384
Automatic Transferring.....	383
Displaying Messages.....	394

Favorite Contacts.....	385
HFL Buttons.....	374
HFL Menus.....	377
HFL Status Display.....	376
In Case of Emergency.....	305, 398
Limitations for Manual Operation.....	376
Making a Call.....	387
Options During a Call.....	390
Phone Setup.....	379
Receiving a Call.....	390
Receiving a Text Message.....	392
Ringtone.....	383
Selecting a Phone.....	393
To Set Up a Text Message Options.....	391
Hazard Warning Button	6
HD Radio™	281
Head Restraints	219
Headlights	195
Aiming.....	564
Auto High-Beam.....	199
Automatic Operation.....	196
Dimming.....	195, 198
Operating.....	195
Head-Up Display	159
Heated Steering Wheel	236
Heated Windshield Button	204
Heaters (Seat)	237, 238, 239
HFL (HandsFreeLink®)	374
High Beam Indicator	97
Hill Start Assist System	417
HomeLink® Universal Transceiver	371

Honda App License Agreement.....	331
Honda Sensing®	26, 453
HondaLink®	301

I

Identification Numbers

Engine and Transmission.....	636
Vehicle Identification	636

Illumination Control

Dial.....	205
-----------	-----

Immobilizer System

Indicator.....	98
----------------	----

Indicators.....

Adaptive Cruise Control (ACC) with Low Speed Follow (Amber).....	103
Adaptive Cruise Control (ACC) with Low Speed Follow (White/Green).....	104, 471
Anti-lock Brake System (ABS).....	93
Auto High-Beam.....	94
Auto Idle Stop (Green).....	102
Auto Idle Stop System (Amber).....	102
Automatic Brake Hold.....	86, 513
Automatic Brake Hold System.....	86, 513
Charging System	88, 613
Cruise Mode (White/Green)	104
ECON Mode	100, 434
Electric Power Steering (EPS) System.....	95, 617
Fog Light.....	97
High Beam.....	97

Immobilizer System	98
Lane Keeping Assist System (LKAS) (Amber).....	104
Lane Keeping Assist System (LKAS) (White/Green).....	104
Lights On	97
Low Fuel	93
Low Tire Pressure/TPMS.....	96, 444, 448
M (sequential mode/7-speed manual shift mode) Indicator/Gear Selection Indicator	88
Malfunction Indicator Lamp.....	87, 614
Parking Brake and Brake System (Amber).....	84, 616
Parking Brake and Brake System (Red)	83, 615, 616
Safety Support (Amber).....	105
Safety Support (Green/Gray).....	108
Seat Belt Reminder.....	39, 92
Security System Alarm	99
Shift Position	88
SPORT Mode.....	101, 433
Supplemental Restraint System.....	60, 93
System Message.....	99
Transmission System.....	89, 91
Turn Signal and Hazard Warning	97
Vehicle Stability Assist™ (VSA®) OFF	95, 442
Vehicle Stability Assist™ (VSA®) System.....	94, 441
Information	631

Instant Fuel Economy	145
Instrument Panel.....	81
Brightness Control	205
Interior Lights.....	223
Interior Rearview Mirror	210
iPhone.....	330
iPod.....	293, 330

J

Jack (Wheel Nut Wrench).....	600
Jump Starting.....	606

K

Key Number Tag	168
Keyless Access System with Push Button Start System.....	170
Keyless Lockout Prevention.....	176
Keys.....	167
Lockout Prevention	176
Number Tag.....	168
Rear Door Won't Open	179
Remote Transmitter	174
Types and Functions.....	167
Valet Key	183
Kickdown (Automatic Transmission/Continuously Variable Transmission)....	419
Knee Airbags.....	54

L

Lane Keeping Assist System (LKAS)	486
Language (HFL)	376
LATCH (Child Seats)	69
Lights	195, 564
Auto High-Beam	199
Automatic	196
Bulb Replacement	564
Daytime Running Lights	198
Fog Lights	197
High Beam Indicator	97
Interior	223
Light Switches	195
Lights On Indicator	97
Turn Signals	194
Load Limits	405
Locking/Unlocking	167
Auto Door Locking/Unlocking	180
Childproof Door Locks	179
From Inside	177
From Outside	170
Keys	167
Using a Key	175
Lockout Prevention System	176
Low Battery Charge	613
Low Fuel Indicator	93
Low Keyless Remote Signal Strength	169
Low Oil Pressure Warning	613
Low Speed Braking Control	465
Lower Anchors	69
Lubricant Specifications Chart	632, 634

Luggage (Maximum Load Limit)	405
Lumbar Support Adjustment Switch	213

M

Maintenance	149, 537
Battery	584
Brake Fluid	562
Cleaning	588
Climate Control System	587
Coolant	559
Maintenance Minder™	541
Oil	552
Precautions	538
Radiator	560
Remote Transmitter	586
Replacing Light Bulbs	564
Safety	539
Service Items	545
Tires	575
Transmission Fluid	561
Under the Hood	548
Malfunction Indicator Lamp	87, 614
Map Lights	224
Maximum Load Limit	405
Meters, Gauges	139
Mirrors	210
Adjusting	210
Door	211
Exterior	211
Interior Rearview	210

Modifications (and Accessories)	593
Moonroof	190
MP3	296
MP3/WMA/AAC	296
Multi-View Rear Camera	529

N

Navigation	148, 163
Numbers (Identification)	636

O

Odometer	142
Oil (Engine)	551
Adding	554
Checking	552
Displaying Oil Life	542
Low Oil Pressure Warning	613
Recommended Engine Oil	551
Viscosity	551
Open Source Licenses	345
Opening	
Trunk	628
Opening/Closing	
Hood	550
Moonroof	190
Power Windows	187
Trunk	181
Outside Temperature	143
Overheating	611

P

Paddle Shifters.....	425, 431
Panic Mode	186
Parking	518
Parking Brake.....	508
Parking Brake and Brake System Indicator (Amber)	84, 616
Parking Brake and Brake System Indicator (Red)	83, 615, 616
Parking Sensor System.....	520
Passenger Airbag Off Indicator	61
Passing Indicators	195
Phone	150
Playing <i>Bluetooth</i> ® Audio	299
Power Windows.....	187
Precautions While Driving.....	418
Rain.....	418
Pregnant Women	44
Puncture (Tire)	597

R

Radiator.....	560
Radio (AM/FM).....	278
Radio (SiriusXM®).....	282
Radio Data System (RDS).....	280
Range	145
RDS (Radio Data System).....	280
Readiness Codes (Emissions Testing)	639
Rear Defogger/Heated Door Mirror Button.....	204

Rear Seat (Folding Down).....	216
Rear Seat Heaters.....	239
Rear Seat Reminder.....	217
Rearview Mirror	210
Refueling	531
Fuel Gauge.....	139
Gasoline.....	531, 632, 634
Low Fuel Indicator	93
Regulations.....	448, 578, 637
Remote Engine Start	414
Remote Transmitter	174
Replacement	
Battery	586
Bulbs.....	564
Fuses.....	620, 622, 624, 625
Tires.....	581
Wiper Blade Rubber	572
Reporting Safety Defects.....	638
Resetting a Trip Meter.....	143, 145
Road Departure Mitigation (RDM)	494
On and Off.....	496

S

Safe Driving	33
Safety Check	37
Safety Labels.....	79
Safety Message.....	3
Safety Support.....	158

Seat Belts	38
Adjusting the Shoulder Anchor	43
Automatic Seat Belt Tensioners	41
Checking	45
Fastening.....	42
Installing a Child Seat with a Lap/Shoulder Seat Belt	72
Pregnant Women.....	44
Reminder	39
Warning Indicator	39, 92
Seat Heaters	237, 238, 239
Seat Ventilation	238
Seats.....	212
Adjusting.....	212
Front Seats.....	212
Rear Seats.....	216
Seat Heaters	237, 238, 239
Seat Ventilation	238
Security System	184
Immobilizer System Indicator.....	98
Security System Alarm Indicator	99
Selecting a Child Seat	68
Sequential Mode.....	425
Operation	426
Shift Buttons	21, 420
Operation	421
Shift Lever	24, 427, 429
Operation	24, 428, 430
Releasing	609
Won't Move	609
Shift Position Indicator	88

Shifting (Transmission)	420, 427, 429
Shoulder Anchor	43
Side Airbags	57
Side Curtain Airbags	59
Siri Eyes Free	312
SiriusXM® Radio	282
Snow Tires	583
Spare Tire	597, 633, 635
Spark Plugs	632, 634
Specifications	632
Specified Fuel	531, 632, 634
Speedometer	139
SPORT Mode	433
Indicator	101
SRS Airbags (Airbags)	49
Starting Assist Brake Function	439
Starting the Engine	412
Does Not Start	603
Jump Starting	606
Steering Wheel	
Adjusting	209
Stopping	518
Summer Tires	583
Sunglasses Holder	230
Supplemental Restraint System (SRS)	49
Switches	
(Around the Steering Wheel)	6, 7, 191
System Message Indicator	99
System Updates	266

T

Tachometer	151, 162
Temperature	
Gauge	139
Outside Temperature	143
Temperature Sensor	143, 243
Time (Adjusting)	166
Tire Pressure Monitoring System	
(TPMS)	444
Indicator	96, 618
Tires	575
Air Pressure	576, 633, 635
Checking and Maintaining	575
Inspection	575
Labeling	576
Puncture (Flat Tire)	597
Regulations	578
Rotation	582
Spare Tire	597, 633, 635
Summer	583
Tire Chains	583
Wear Indicators	580
Winter	583
Tools	596
Towing a Trailer	407
Equipment and Accessories	409
Load Limits	407
Towing Your Vehicle	411
Emergency	626

TPMS

(Tire Pressure Monitoring System)	444
Indicator	96, 618
Traffic Sign Recognition System	498
Transmission	419, 420, 427, 429
Automatic	420
Continuously Variable	427, 429
Fluid	561
Number	636
Shift Position Indicator	88
Transmission System	
Indicator	89, 91
TRIP Button	142
Trip Computer	144, 146
Trip Meter	143, 145, 147
Troubleshooting	595
Blown Fuse	620, 622, 624
Brake Pedal Vibrates	30
Buzzer Sounds When Opening Door	31
Emergency Towing	626
Engine Won't Start	603
Noise When Braking	32
Overheating	611
Puncture/Flat Tire	597
Rear Door Won't Open	31, 179
Shift Lever Won't Move	609
Warning Indicators	82
Trunk	181
Lid	181
Light Bulb	632, 634
Main Switch	183

Unable to Open.....	628
Turbo Engine Vehicle.....	535
Turn Signals.....	194
Indicators (Instrument Panel).....	97
Turn-by-Turn Directions.....	148, 163

U

Unlocking the Doors.....	170
Unlocking the Front Doors	
from the Inside.....	178
USB Flash Drives.....	296, 330
USB Ports.....	247
Using the Keyless Access System with Push	
Button Start System.....	170

V

Vanity Mirrors.....	9
Vehicle Identification Number.....	636
Vehicle Speed.....	162
Vehicle Stability Assist™ (VSA®).....	441
Off Button.....	442
Off Indicator.....	95
System Indicator.....	94
Ventilation.....	238, 240
Viscosity (Oil).....	551, 633, 635
Voice Control Operation.....	275
Voice Portal Screen.....	276
Voice Recognition.....	275
VSA® (Vehicle Stability Assist™).....	441

W

Wallpaper.....	257
Warning and Information Messages.....	109
Warning Indicator On/Blinking.....	613
Warning Labels.....	79
Warnings.....	149
Warranties (Warranty Manual provided	
separately).....	641
Watts.....	632, 634
Wear Indicators (Tire).....	580
Wheel Nut Wrench (Jack Handle) ...	596, 600
Wi-Fi Connection.....	310
Window Washers.....	202
Adding/Refilling Fluid.....	563
Switch.....	202
Windows (Opening and Closing).....	187
Windshield	
Cleaning.....	588, 591
Defrosting/Defogging.....	241
Washer Fluid.....	563
Wiper Blades.....	572
Wipers and Washers.....	202
Winter Tires	
Snow Tires.....	583
Tire Chains.....	583
Wipers and Washers.....	202
Automatic Intermittent Wipers.....	203
Checking and Replacing Wiper Blades.....	572
Wireless Charger.....	232
WMA.....	296
Worn Tires.....	575



owners.honda.com (U.S.)
honda.ca (Canada)

31TVA640
OM-17269
00X31-TVA-6400

2022 Honda Accord Owner's Manual
© 2021 Honda Motor Co., Ltd. — All Rights Reserved

Printed in U.S.A.