

Owner's Manual

2020 RLX
Sport Hybrid



WARNING

California Proposition 65 Warning

Operating, servicing and maintaining a passenger vehicle or off-highway motor vehicle can expose you to chemicals including engine exhaust, carbon monoxide, phthalates, and lead, which are known to the State of California to cause cancer and birth defects or other reproductive harm. To minimize exposure, avoid breathing exhaust, do not idle the engine except as necessary, service your vehicle in a well-ventilated area and wear gloves or wash your hands frequently when servicing your vehicle. For more information go to www.P65Warnings.ca.gov/passenger-vehicle.

Event Data Recorders

This vehicle is equipped with an event data recorder (EDR).

The main purpose of an EDR is to record, in certain crash or near crash-like situations, such as an air bag deployment or hitting a road obstacle, data that will assist in understanding how a vehicle's systems performed. **The EDR is designed to record data related to vehicle dynamics and safety systems for a short period of time, typically 30 seconds or less. The EDR in this vehicle is designed to record such data as:**

- **How various systems in your vehicle were operating;**
- **Whether or not the driver and passenger safety belts were buckled/fastened;**

- **How far (if at all) the driver was depressing the accelerator and/or brake pedal; and,**
- **How fast the vehicle was traveling.**

These data can help provide a better understanding of the circumstances in which crashes and injuries occur. NOTE: EDR data are recorded by your vehicle only if a non-trivial crash situation occurs; no data are recorded by the EDR under normal driving conditions and no personal data (e.g., name, gender, age, and crash location) are recorded. However, other parties, such as law enforcement, could combine the EDR data with the type of personally identifying data routinely acquired during a crash investigation.

To read data recorded by an EDR, special equipment is required, and access to the vehicle or the EDR is needed. In addition to the vehicle manufacturer, other parties, such as law enforcement, that have the special equipment, can read the information if they have access to the vehicle or the EDR.

The data belongs to the vehicle owner and may not be accessed by anyone else except as legally required or with the permission of the vehicle owner.

Service Diagnostic Recorders

This vehicle is equipped with service-related devices that record information about powertrain performance. The data can be used to verify emissions law requirements and/or help technicians diagnose and solve service problems. It may also be combined with data from other sources for research purposes, but it remains confidential. Some diagnostic and maintenance information is uploaded to Acura upon vehicle start up.

California Perchlorate Contamination Prevention Act

The airbags, seat belt tensioners, and CR type batteries in this vehicle may contain perchlorate materials - special handling may apply. See www.dtsc.ca.gov/hazardouswaste/perchlorate/

As you read this manual, you will find information that is preceded by a **NOTICE** symbol. This information is intended to help you avoid damage to your vehicle, other property, or the environment.

Software End User License Agreement

Your vehicle comes equipped with software, which is governed by the End User License Agreement in Owner's Manual, and which contains a binding arbitration clause. Please refer to the End User License Agreement for the terms and conditions governing your use of the installed software, as well as the applications, services, functions, and content provided through the software. Your use of the installed software will serve as your consent to the terms and conditions of the End User License Agreement.

You may opt out within 30 days of your initial use of the Software by sending a signed, written notice to Acura at American Honda Motor Co., Inc. Acura Client Relations Mail Stop 100-5E-8F, 1919 Torrance Blvd. Torrance, CA 90501-2746.

Privacy Notice

This vehicle may share location and usage information. To manage this setting, visit www.acuralink.com/vehicle-data-choices.

A Few Words About Safety

Your safety, and the safety of others, is very important. And operating this vehicle safely is an important responsibility.

To help you make informed decisions about safety, we have provided operating procedures and other information on labels and in this manual. This information alerts you to potential hazards that could hurt you or others.

Of course, it is not practical or possible to warn you about all the hazards associated with operating or maintaining your vehicle. You must use your own good judgment.

You will find this important safety information in a variety of forms, including:

- **Safety Labels** - on the vehicle.
- **Safety Messages** - preceded by a safety alert symbol  and one of three signal words: **DANGER**, **WARNING**, or **CAUTION**. These signal words mean:

DANGER

You **WILL** be **KILLED** or **SERIOUSLY HURT** if you don't follow instructions.

WARNING

You **CAN** be **KILLED** or **SERIOUSLY HURT** if you don't follow instructions.

CAUTION

You **CAN** be **HURT** if you don't follow instructions.

- **Safety Headings** - such as Important Safety Precautions.
- **Safety Section** - such as Safe Driving.
- **Instructions** - how to use this vehicle correctly and safely.

This entire book is filled with important safety information - please read it carefully.

This owner's manual should be considered a permanent part of the vehicle and should remain with the vehicle when it is sold.

This owner's manual covers all models of your vehicle. You may find descriptions of equipment and features that are not on your particular model.

Images throughout this owner's manual (including the front cover) represent features and equipment that are available on some, but not all, models. Your particular model may not have some of these features.

This owner's manual is for vehicles sold in the United States and Canada.

The information and specifications included in this publication were in effect at the time of approval for printing. Honda Motor Co., Ltd. reserves the right, however, to discontinue or change specifications or design at any time without notice and without incurring any obligation.

➤ Safe Driving P. 33

For Safe Driving P. 34 Seat Belts P. 38 Airbags P. 45

➤ Instrument Panel P. 75

Indicators P. 76 Gauges and Displays P. 112

➤ Controls P. 127

Clock P. 128 Locking and Unlocking the Doors P. 129
Moonroof P. 151
Adjusting the Seats P. 175

➤ Features P. 211

Audio System P. 212 Audio System Basic Operation P. 216
Customized Features P. 295 HomeLink® Universal Transceiver P. 321

➤ Driving P. 371

Before Driving P. 372 Towing a Trailer P. 377
Multi-View Rear Camera* P. 476 Surround View Camera System* P. 478

➤ Maintenance P. 491

Before Performing Maintenance P. 492 Maintenance Minder™ P. 495
Checking and Maintaining Wiper Blades P. 517
Climate Control System Maintenance P. 531

➤ Handling the Unexpected P. 539

Tools P. 540 If a Tire Goes Flat P. 541
Overheating P. 565 Indicator, Coming On/Blinking P. 567
When You Cannot Open the Trunk P. 582

➤ Information P. 585

Specifications P. 586 Identification Numbers P. 588
Emissions Testing P. 591 Warranty Coverages P. 593

Contents

Child Safety P. 60

Exhaust Gas Hazard P. 72

Safety Labels P. 73

Opening and Closing the Trunk P. 143

Security System P. 146

Opening and Closing the Windows P. 149

Operating the Switches Around the Steering Wheel P. 152

Adjusting the Mirrors P. 172

Interior Lights/Interior Convenience Items P. 182

Climate Control System P. 200

Audio Error Messages P. 273

General Information on the Audio System P. 277

Bluetooth® HandsFreeLink® P. 324

AcuraLink® P. 363

When Driving P. 378

Braking P. 450

Parking Your Vehicle P. 466

Refueling P. 488

Fuel Economy and CO₂ Emissions P. 490

Maintenance Under the Hood P. 501

Replacing Light Bulbs P. 514

Checking and Maintaining Tires P. 520

12-Volt Battery P. 529

Remote Transmitter Care P. 530

Cleaning P. 532

Accessories and Modifications P. 537

Power System Won't Start P. 559

Jump Starting P. 562

Fuses P. 572

Emergency Towing P. 580 When You Cannot Unlock the Fuel Fill Door P. 581

Refueling P. 583

Devices that Emit Radio Waves P. 589

Reporting Safety Defects P. 590

Authorized Manuals P. 595

Client Service Information P. 596

Quick Reference Guide P. 4

Safe Driving P. 33

Instrument Panel P. 75

Controls P. 127

Features P. 211

Driving P. 371

Maintenance P. 491

Handling the Unexpected P. 539

Information P. 585

Index P. 600

Visual Index

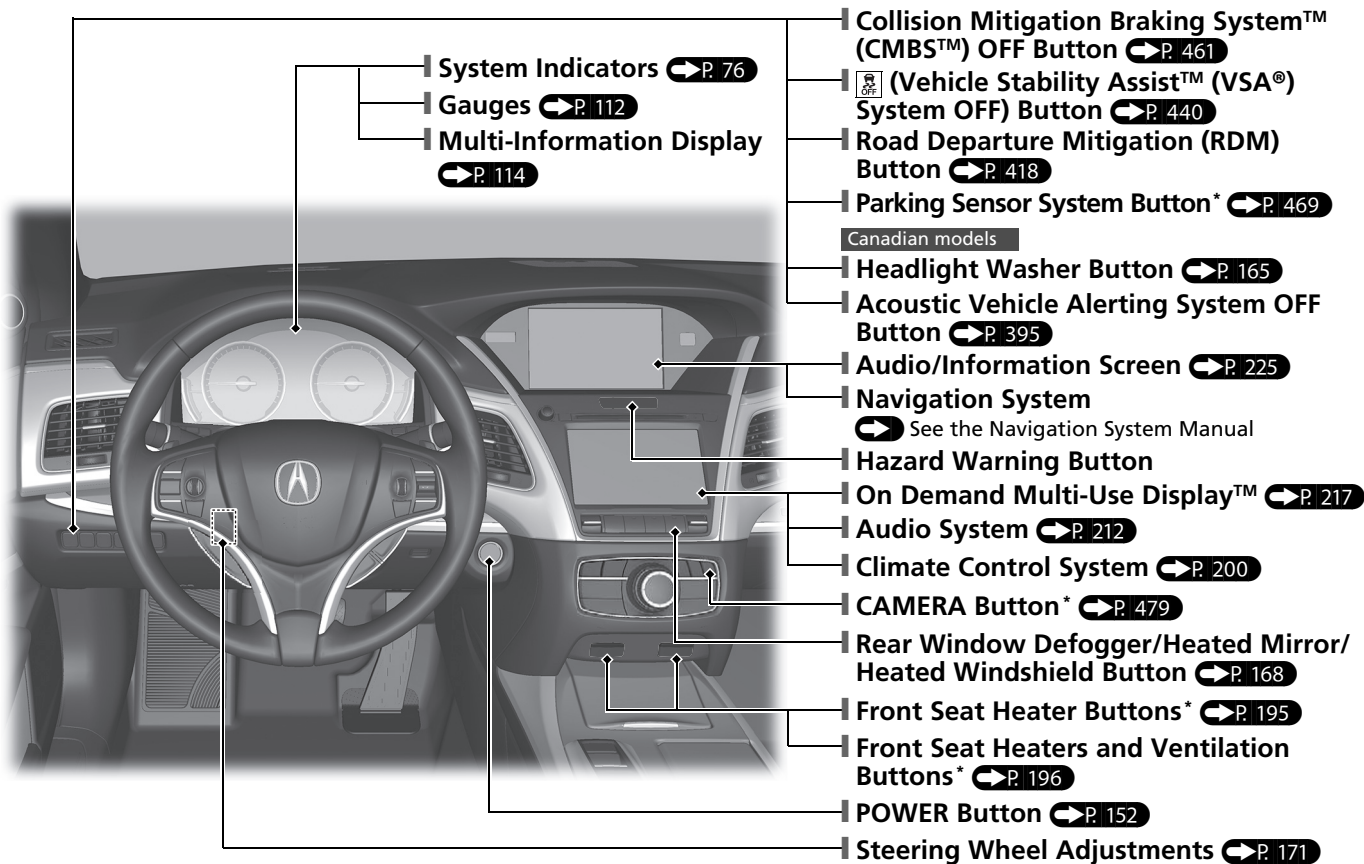

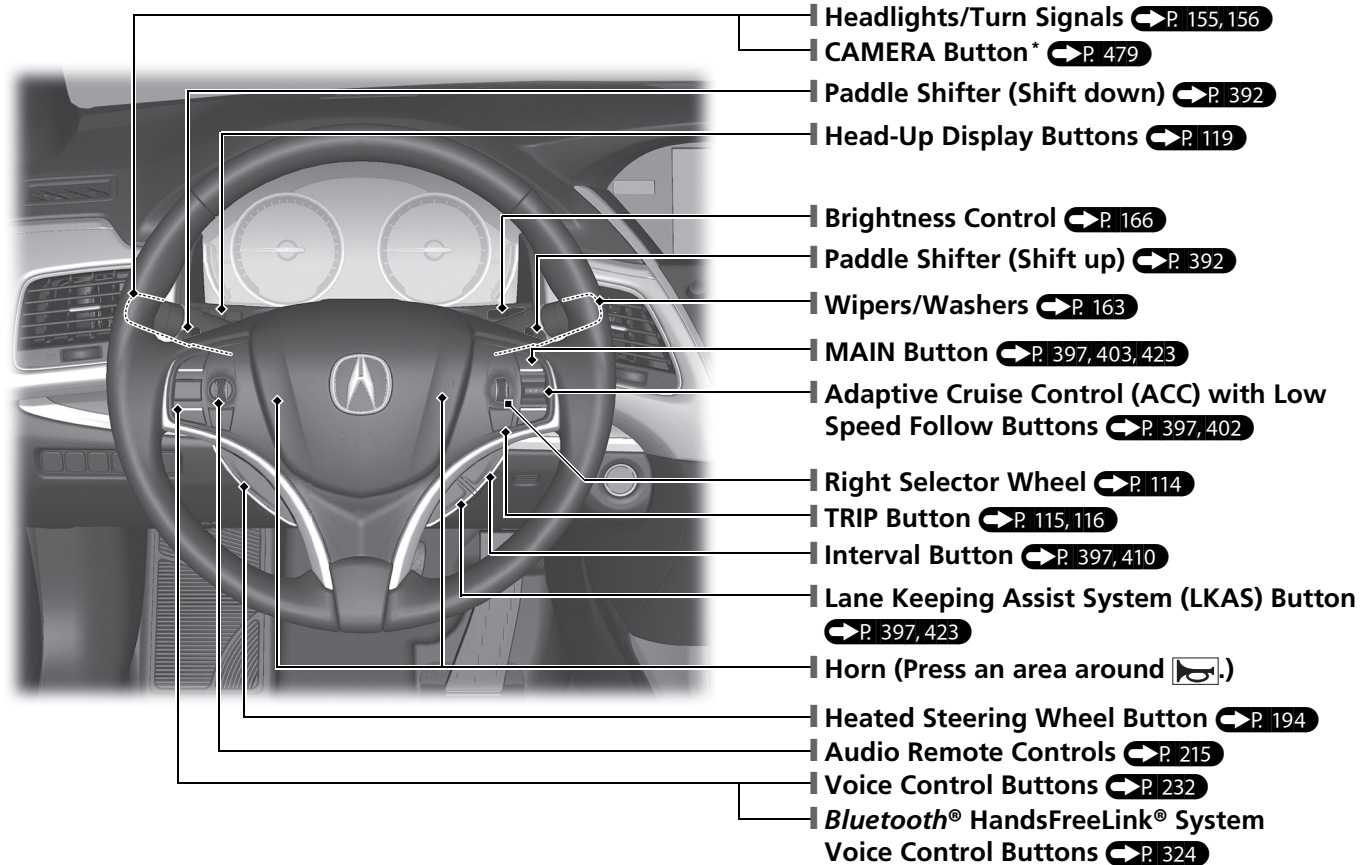

Visual Index

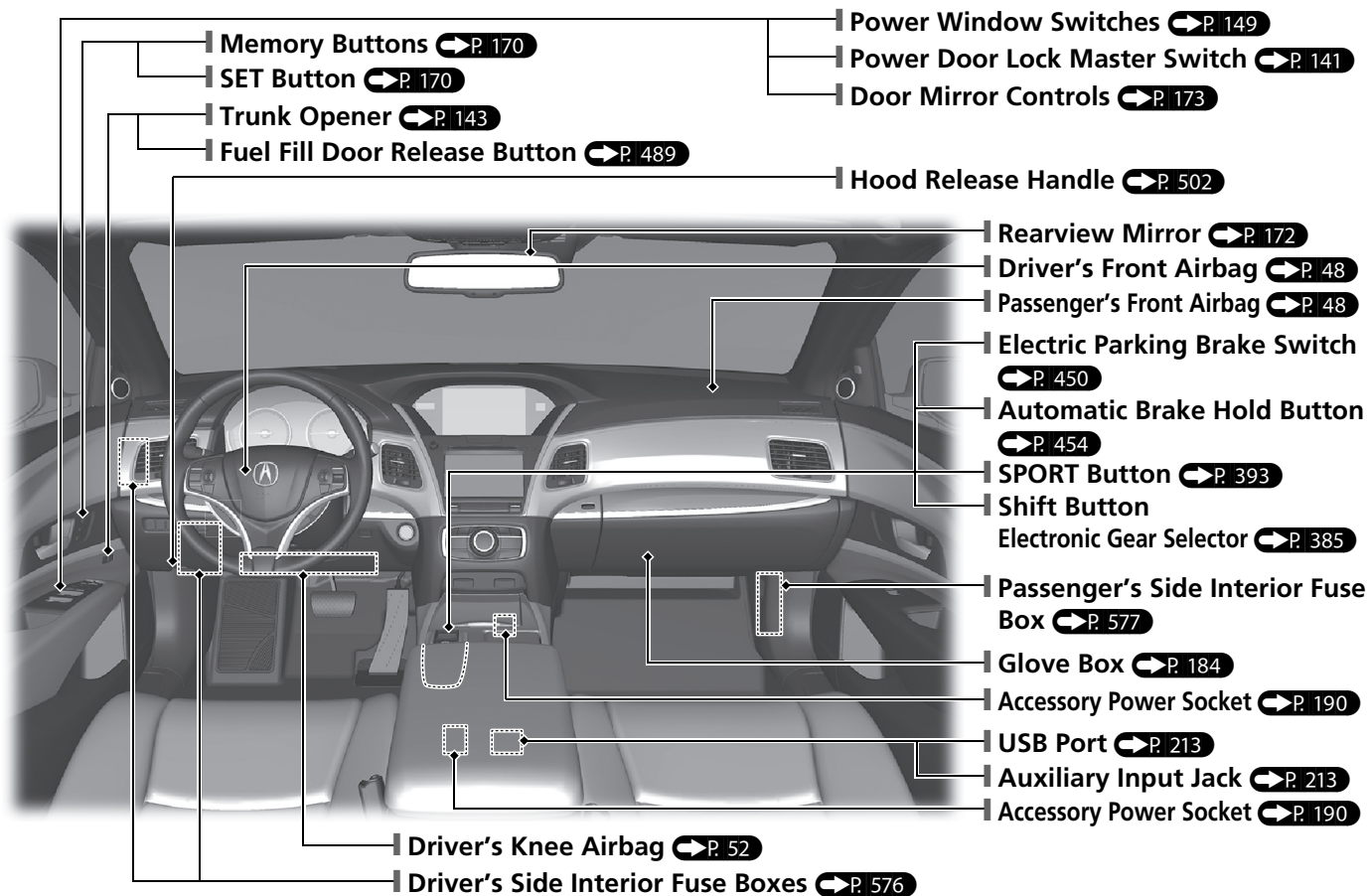

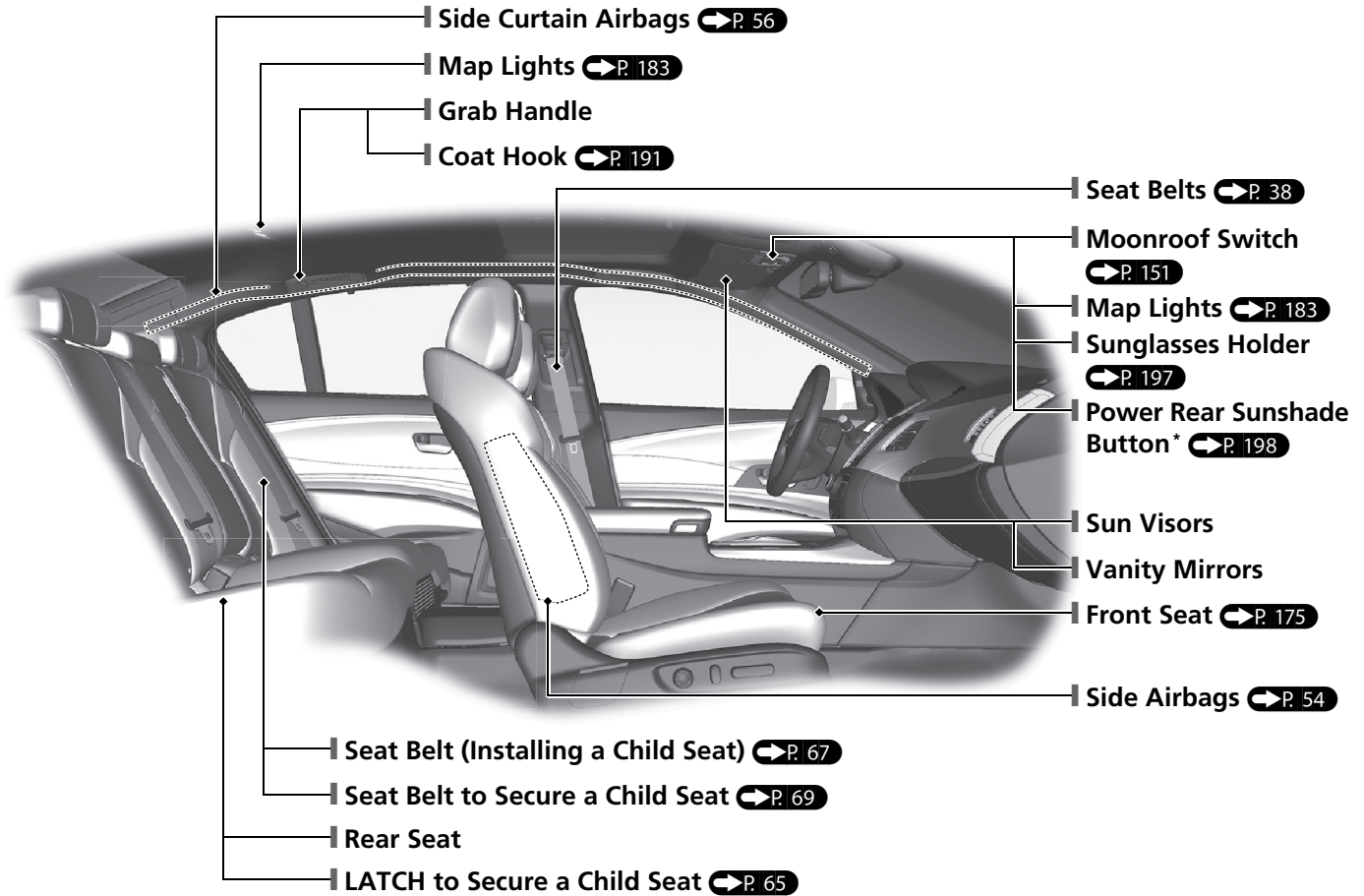

Visual Index

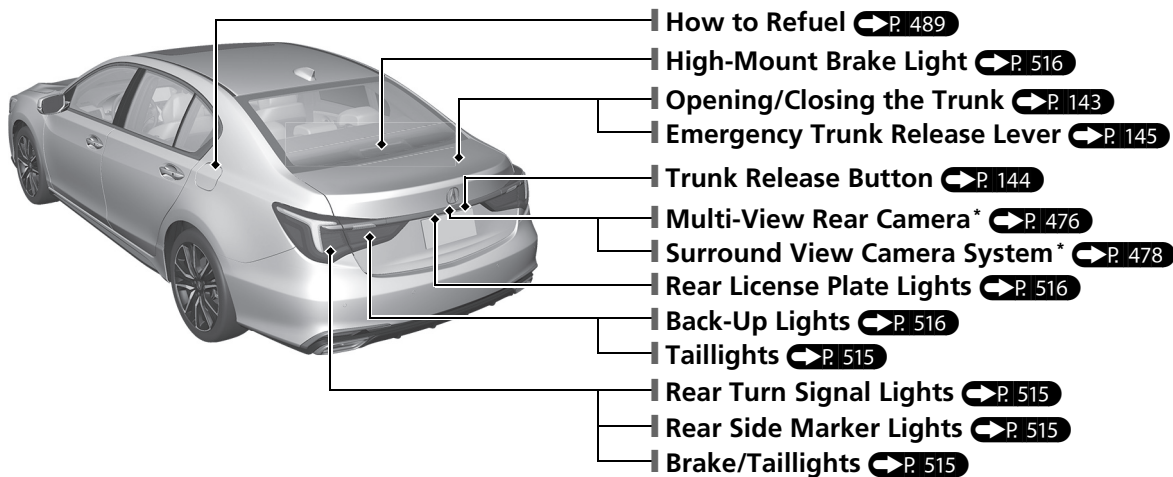
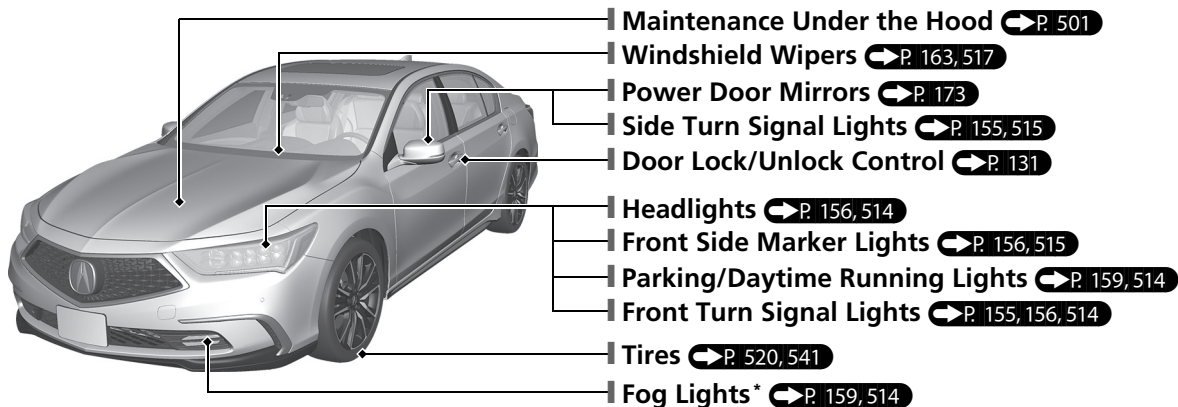

SPORT HYBRID Super Handling-All Wheel Drive™ (SPORT HYBRID SH-AWD®)

Your SPORT HYBRID SH-AWD® vehicle uses both an electric motor and a gasoline engine as propulsion sources, with electric motors receiving electricity from an internal High Voltage battery.

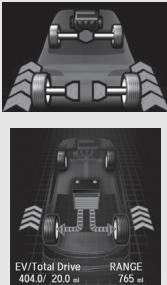
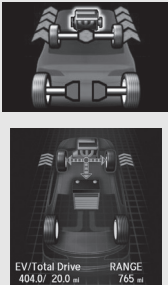
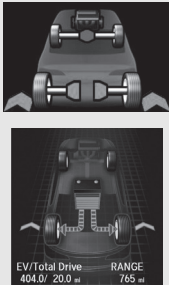
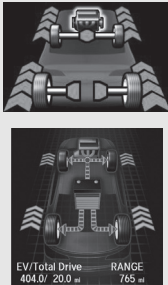
Operating mode	EV Launch	Engine Drive	EV Cruising	Power Acceleration
Vehicle Speed	Launch Acceleration: <ul style="list-style-type: none"> • Rear Motor Drive 	Gentle Acceleration: <ul style="list-style-type: none"> • Engine Drive 	Low Speed Cruise: <ul style="list-style-type: none"> • Rear Motor Drive 	Aggressive Acceleration: <ul style="list-style-type: none"> • Engine Drive • Motor Assist
Power Flow Monitor*1				
Electric motors	Drive	- / Drive	Drive	Drive
Generators	-	Generate / -	-	-
Engine	Stopped	Running	Stopped	Running
High Voltage battery	Discharges	Charges/Discharges	Discharges	Discharges

*1:Upper: Head-up display, Lower: Audio/Information screen

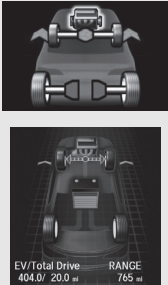
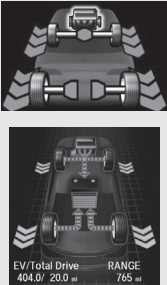
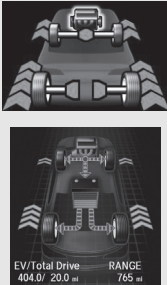
Operating mode	Engine Cruising	Regeneration	AWD Mode
Vehicle Speed	High Speed Cruise: <ul style="list-style-type: none"> • Engine Drive 	Deceleration: <ul style="list-style-type: none"> • Front & Rear Regeneration 	Slippery Condition: <ul style="list-style-type: none"> • Engine Drive • Front Generation • Rear Motor Drive
Power Flow Monitor*1			
Electric motors	Drive	Regenerate	Drive
Generators	Generate	Regenerate	Generate
Engine	Running	Stopped	Running
High Voltage battery	Charges/Discharges	Charges	Charges/Discharges

*1:Upper: Head-up display, Lower: Audio/information screen

Energy Efficiency

As with a gasoline-powered vehicle, hybrid vehicle fuel efficiency and driving range is most impacted by your driving style. Aggressive acceleration and high-speed driving can easily trigger the system to switch the propulsion source to the gasoline-powered engine. In addition, heavy climate control system use negatively affects vehicle range and efficiency. Either of these use patterns will more quickly reduce the High Voltage battery's state of charge.

Battery Types

There are two types of batteries used in this vehicle; a standard 12-volt battery that powers the airbags, the interior and exterior lights, and other standard 12-volt systems; and a high voltage battery that is used to power the propulsion motors and recharge the 12-volt battery.

Regenerative Energy and Regenerative Braking

When decelerating without the accelerator being depressed or the brake pedal being applied, or while driving downhill, the electric motors act as generators that recovers a portion of the electrical energy that was used to accelerate the vehicle. This regenerative braking slows the vehicle in a manner similar to engine braking in a gasoline-powered vehicle.

When the high voltage battery is fully charged or its condition is affected by extreme temperatures or other factors, regenerative braking may not work.

Auto Engine Stop/Start

Your vehicle's gasoline engine will automatically stop and start during vehicle operation as needed to meet driving and battery conditions. These are some examples that could cause the gasoline engine to automatically start.

In the following cases, however, Auto Engine Stop may not activate.

- The vehicle momentarily needs additional power for aggressive acceleration, or driving uphill or at high speed.
- The climate control system is in heavy use.
- The High Voltage battery temperature is high or low.
- The High Voltage battery state of charge is low.

When in SPORT mode, Auto Engine Stop does not activate.

Sounds Unique to the SPORT HYBRID SH-AWD® System

When you first start driving this vehicle, you will likely hear some unfamiliar sounds, particularly when you turn on the power system, or while you are driving or accelerating from a stop. Some of these sounds are unique to this vehicle's powertrain, fuel, and climate control systems; others are similar to sounds generated by conventional automobiles that typically are masked by louder noises absent from a vehicle of this design.

These sounds are not a cause for concern, and you will soon recognize them as normal and thus be able to detect any new or unusual noise should one develop.

Safety Precautions

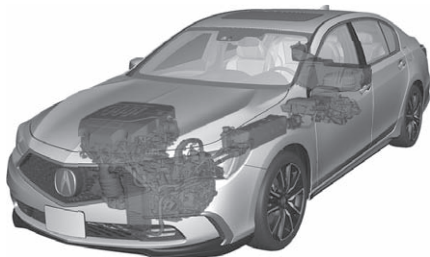

Do not cover the air intake.

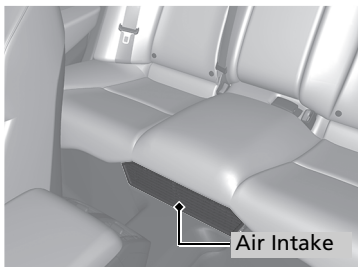

If the air intake is obstructed during vehicle operation, the High Voltage battery can become too hot. To protect the battery, the system may limit the battery's output and cause the power system and 12-volt battery charging system indicators to come on.

Do not touch the High Voltage system

Attempting to take a High Voltage system component apart or disconnect one of its wires can cause severe electrical shock. Make sure that any maintenance or repairs to the High Voltage system is performed by a Acura dealer.

If a crash occurs

●Be careful of electric shock hazard.

▶If a severe crash damages your vehicle's High Voltage system, there is a possibility of electrical shock due to exposed High Voltage components or wires. If this happens, do not touch any of the High Voltage system components or any of its orange wires.

●Avoid contact with High Voltage battery fluid.

▶The High Voltage battery contains a flammable electrolyte that could leak as a result of a severe crash. Avoid skin or eye contact with the electrolyte as it is corrosive. If you accidentally come into contact with the electrolyte, rinse the exposed skin or flush your eyes with copious amounts of water for at least five minutes, and seek medical attention immediately.

●Use a fire extinguisher for an electrical fire.

▶Attempting to extinguish an electrical fire with a small quantity of water, from a garden hose for instance, can be dangerous.

●Anytime the vehicle is damaged in a crash, have it repaired by an Acura dealer.

Emergency Shutdown System for the High Voltage System

If the vehicle is involved in a crash, the emergency shutdown system will activate depending on the severity of the impact. When the system activates, the High Voltage system automatically shuts down, and the vehicle can no longer move under its own power. To return the High Voltage system back to normal operation, consult an Acura dealer.

Acura collects and recycles High Voltage batteries used in its vehicles – consult an Acura dealer for more information.

Safe Driving P. 33

Airbags P. 45

- Your vehicle is fitted with airbags to help protect you and your passengers during a moderate-to-severe collision.

Child Safety P. 60

- All children 12 and younger should be seated in the rear seat.
- Smaller children should be properly restrained in a forward-facing child seat.
- Infants must be properly restrained in a rear-facing child seat.

Exhaust Gas Hazard P. 72

- Your vehicle emits dangerous exhaust gases that contain carbon monoxide. Do not run the engine in confined spaces where carbon monoxide gas can accumulate.

Seat Belts P. 38

- Fasten your seat belt and sit upright well back in the seat.
- Check that your passengers are wearing their seat belts correctly.



Fasten your lap belt as low as possible.

Before Driving Checklist P. 37



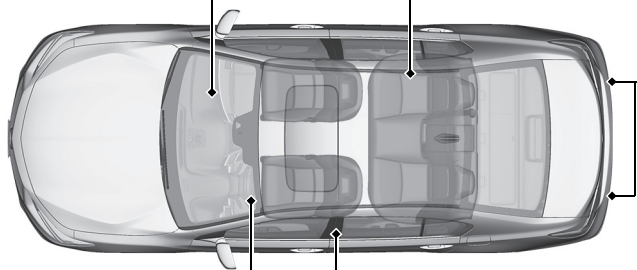











- Before driving, check that the front seats, head restraints, steering wheel, and mirrors have been properly adjusted.



Instrument Panel ↔ P. 75



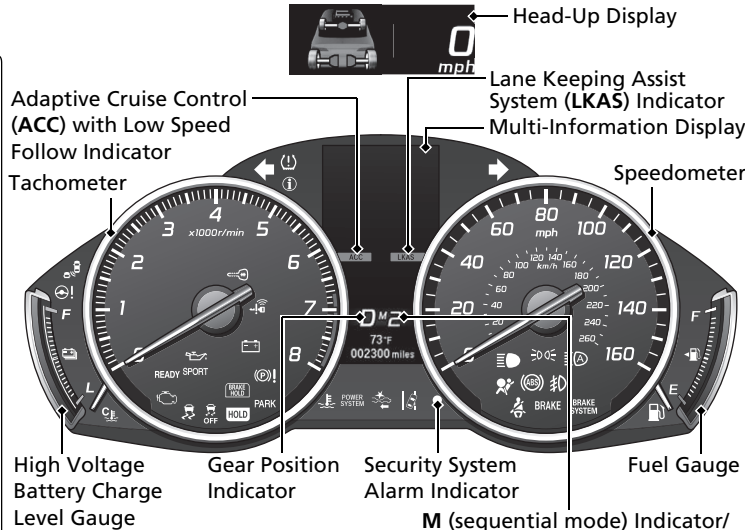

Gauges ↔ P. 112 / Multi-Information Display ↔ P. 114 /
 Head-Up Display ↔ P. 119 / System Indicators ↔ P. 76

System Indicators

-  Blind spot information System Indicator
-  Electric Power Steering (EPS) System Indicator
-  Malfunction Indicator Lamp
-  Low Oil Pressure Indicator
-  **SPORT** Mode Indicator
-  Immobilizer System Indicator
-  Keyless Access System Indicator
-  12-Volt Battery Charging System Indicator
-  **BRAKE HOLD** System Indicator
-  **HOLD** U.S. Automatic Brake Hold Indicator
-  **(A)** Canada Automatic Brake Hold Indicator
-  **(P)** Electric Parking Brake System Indicator
-  **PARK** U.S. Electric Parking Brake Indicator
-  **(P)** Canada Electric Parking Brake Indicator















System Indicators

-  Vehicle Stability Assist™ (VSA®) System Indicator
-  **OFF** VSA® OFF Indicator
-  **(!** Low Tire Pressure/TPMS Indicator
-  **(i)** System Message Indicator

Lights Indicators

-  **(!)** Lights On Indicator
-  **(H)** High Beam Indicator
-  **(F)** Fog Light Indicator*
-  **(A)** Auto High-Beam Indicator

System Indicators

-  **(L/R)** Turn Signal and Hazard Warning Indicators
-  **(S)** Supplemental Restraint System Indicator
-  **(ABS)** Anti-lock Brake System (ABS) Indicator
-  **(!)** U.S. Brake System Indicator (Red)
-  **(!)** Canada Brake System Indicator (Amber)
-  **(R)** Road Departure Mitigation (RDM) Indicator
-  **(C)** Collision Mitigation Brake System™ (CMBS™) Indicator
-  **(F)** Low Fuel Indicator
-  **(H)** High Temperature Indicator
-  **(L)** Low Temperature Indicator
-  **(S)** Seat Belt Reminder Indicator
-  **READY** READY Indicator
-  **(P)** POWER SYSTEM Indicator





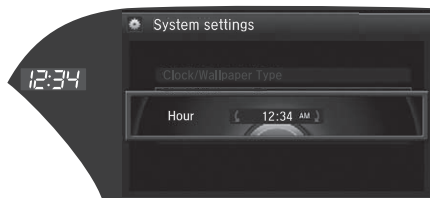

Controls P. 127

Clock P. 128

The navigation system receives signals from GPS satellites, updating the clock automatically.

You can also adjust the time manually.



- 1 Enter the **Clock Adjustment** screen.
 **Clock**  P. 128
- 2 Rotate  to change hour, then press .
- 3 Rotate  to change minute, then press .

POWER Button P. 152

Press the button to changes the vehicle's power mode.

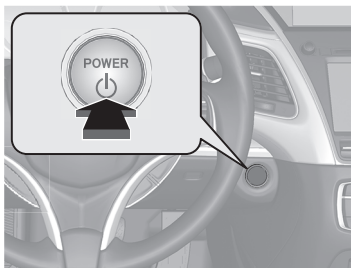

Turn Signals P. 155

Turn Signal Control Lever

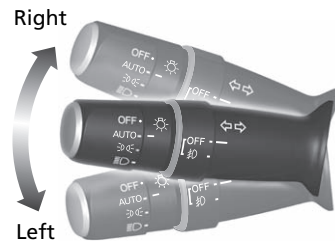

Lights P. 156

Light Control Switches

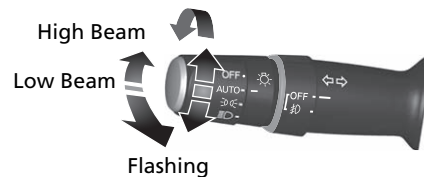

Wipers and Washers

➔ P. 163

Wiper/Washer Control Lever

Adjustment Ring

[-]: Low Sensitivity

[+]: High Sensitivity

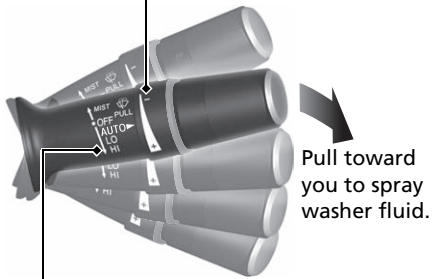

MIST
OFF

AUTO: Wiper speed varies automatically

LO: Low speed wipe

HI: High speed wipe

AUTO should always be turned **OFF** before the following situation in order to prevent severe damage to the wiper system:

- Cleaning the windshield
- Driving through a car wash
- No rain present

Steering Wheel ➔ P. 171

- To adjust, push and hold the adjustment switch to move the steering wheel to the desired position.

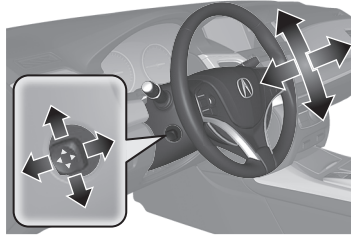

Unlocking the Front Doors from the Inside

➔ P. 140

- Pull either front door inner handle to unlock and open it in one motion.

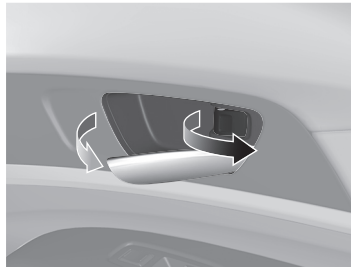

- Unlocking and opening the driver's door from the inner handle unlocks all the other doors.

Trunk ➔ P. 143

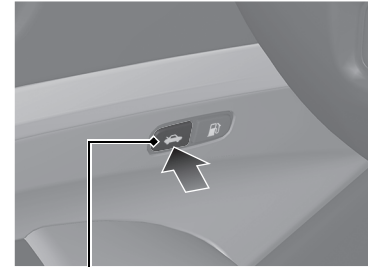

Trunk Opener

- To unlock and open the trunk:
 - Press the trunk opener on the driver's door.
 - Press the trunk release button on the keyless access remote.
 - Press the trunk release button on the trunk lid.

Power Door Mirrors

➔ P. 173

- With the power mode in ON, move the selector switch to L or R.
- Push the appropriate edge of the adjustment switch to adjust the mirror.
- Press the folding button to fold in and out the door mirrors.

Folding Button Selector Switch



Adjustment Switch

Power Windows ➔ P. 149

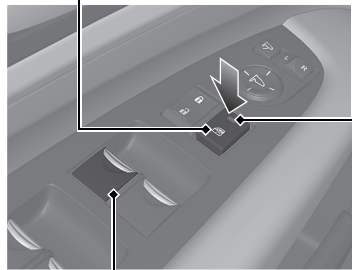

- With the power mode in ON, open and close the power windows.
- If the power window lock button is in the off position, each passenger's window can be opened and closed with its own switch.
- If the power window lock button is in the on position (indicator on), each passenger's window switch is disabled.

Power Window Lock Button Indicator





Window Switch





Climate Control System P. 200

- Press the **AUTO** button to activate the climate control system.
- Press the  button to turn the system on or off.
- Press the  button to defrost the windshield.

The climate control system is voice operable.  P. 236



-  (On/off) Button
- AUTO** Button
-  (Windshield Defroster) Button

-  Air flows from dashboard vents and back of the center console.
-  Air flows from floor and dashboard vents, and back of the center console.
-  Air flows from floor vents.
-  Air flows from floor and windshield defroster vents. (driver's side only)

Features P. 211

Audio system P. 216

For navigation system operation  See the Navigation System Manual

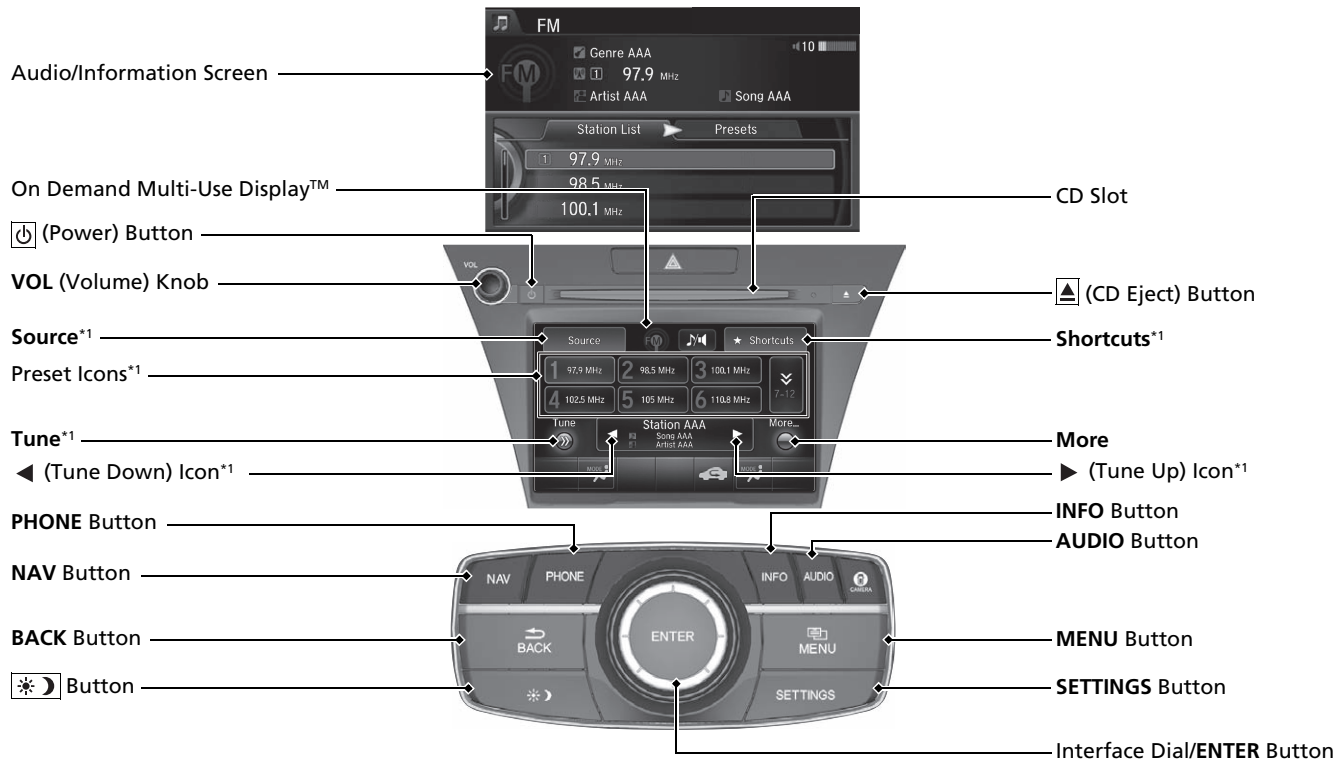

*1: Icons that appear on the screen vary by the source selected.

Audio Remote Controls

➔ P. 215

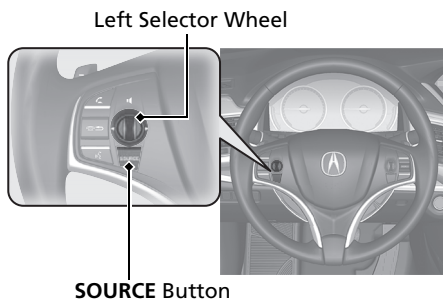

- **SOURCE Button**
Press to change the audio mode: FM/AM/
SiriusXM®/CD/HDD/USB/iPod/*Bluetooth*®
Audio/Pandora®/AUX.
- **Left Selector Wheel**
Roll to adjust the volume up/down.
Radio: Shift to change the preset station.
Shift and hold to select the next or
previous strong station.
CD/HDD/USB device:
Shift to skip to the beginning of
the next song or return to the
beginning of the current song.
Shift and hold to change a folder.

Driving P. 371

Electronic Gear Selector P. 385

- Always depress the brake pedal before selecting **P** or changing the gear position from **P**.
- Select **P** and depress the brake pedal when turning on the power.
- Gear selection

Gear Position Indicator

The gear position indicator and the shift button indicator indicate the current gear selection.



Gear Position Indicator

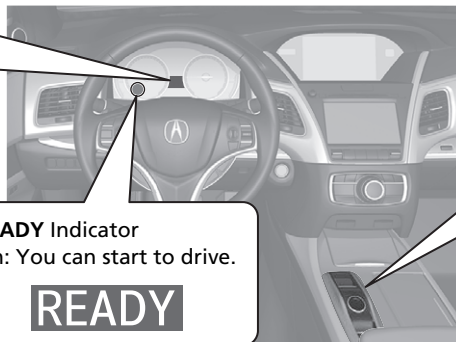

READY Indicator

On: You can start to drive.

READY



Shift Button Indicator



- P** **Park**
Press the **P** button.
Used when parking or before turning the power on or off.
Transmission is locked.
- R** **Reverse**
Press back the **R** button.
Used when reversing.
- N** **Neutral**
Press the **N** button.
Transmission is not locked.
- D** **Drive**
Press the **D** button.
Used for normal driving.
The sequential shift mode can be used.

Paddle Shifters P. 392

- Paddle shifters allow you to shift gears much like a manual transmission (1st through 7th). This is useful for regenerative braking.

Gear Position Indicator

M (sequential mode) Indicator



Sequential Mode Gear Selection Indicator

- D-paddle shift mode: The transmission will shift back to automatic mode once the system detects that the vehicle is cruising.
- Sequential mode gear selection: Holds the selected gear, and the M (sequential mode) indicator comes on, when the SPORT mode is on.
- The sequential mode gear selection is shown in the instrument panel.

Shift Down  Paddle Shifter

Shift Up  Paddle Shifter

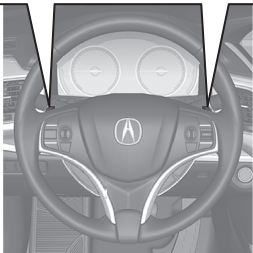

VSA® On and Off P. 440

- The Vehicle Stability Assist™ (VSA®) system helps stabilize the vehicle during cornering, and helps maintain traction while accelerating on loose or slippery road surfaces.
- VSA® comes on automatically every time you turn on the power system.
- To partially disable or fully restore VSA® function, press and hold the button until you hear a beep.

CMBS™ On and Off

 P. 461

- When a possible collision is likely unavoidable, the CMBS™ can help you to reduce the vehicle speed and the severity of the collision.
- To turn the CMBS™ on or off, press and hold the button until you hear a beep.
- The CMBS™ is turned on every time you turn the power system on.

Tire Pressure Monitoring System (TPMS) P. 445

- The TPMS monitors tire pressure.
- The TPMS is turned on automatically every time you turn on the power system.

Refueling P. 488

Fuel recommendation: Unleaded premium gasoline, pump octane number 91 or higher

Fuel tank capacity: 15.1 US gal (57 L)

- 1** Press the fuel fill door release button.



- 2** After refueling, wait for about five seconds before removing the filler nozzle.

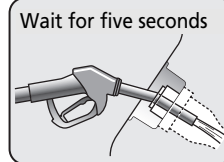

AcuraWatch™

➔ P. 396

AcuraWatch™ is a driver support system which employs the use of two distinctly different kinds of sensors, a radar sensor located in the front grille and a front sensor camera mounted to the interior side of the windshield, behind the rearview mirror.

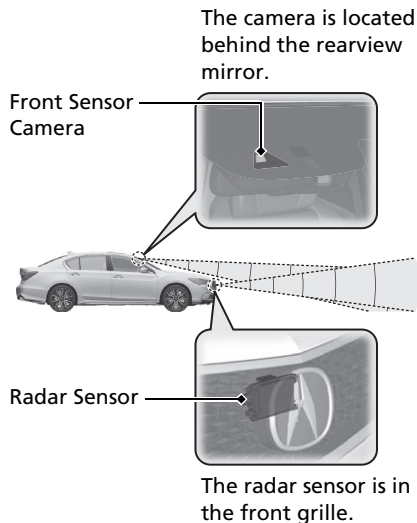

Adaptive Cruise Control (ACC) with Low Speed Follow

➔ P. 402

Helps maintain a constant vehicle speed and a set following interval behind a vehicle detected ahead of yours and, if the detected vehicle comes to a stop, can decelerate and stop your vehicle, without you having to keep your foot on the brake or the accelerator.

Lane Keeping Assist System (LKAS)

➔ P. 421

Provides steering input to help keep the vehicle in the middle of a detected lane and provides tactile and visual alerts if the vehicle is detected drifting out of its lane.

Road Departure Mitigation (RDM) System

➔ P. 416

Alerts and helps to assist you when the system detects a possibility of your vehicle unintentionally crossing over detected lane markings and/or leaving the roadway altogether.

Collision Mitigation Braking System™ (CMBS™)

➔ P. 458

Can assist you when there is a possibility of your vehicle colliding with a vehicle or a pedestrian detected in front of yours. The CMBS™ is designed to alert you when a potential collision is determined, as well as to reduce your vehicle speed to help minimize collision severity when a collision is deemed unavoidable.

Traffic Jam Assist

➔ P. 428

The traffic jam assist system uses a radar sensor mounted inside the front grille and a camera mounted to the upper portion of the windshield to detect and monitor left and right white (yellow) traffic lane lines as well as any vehicle ahead. Based on inputs from the radar sensor and camera, the system adjusts the speed of your vehicle to maintain a set interval between your vehicle and the one detected ahead. It also applies steering torque to keep your vehicle in the center of the detected lane when you are driving in heavy traffic.

Maintenance ↔ P. 491

Under the Hood ↔ P. 501

- Check engine oil, engine coolant, and inverter coolant. Add when necessary.
- Check brake fluid.
- Check the 12-volt battery condition monthly.

- 1** Pull the hood release handle under the corner of the dashboard.

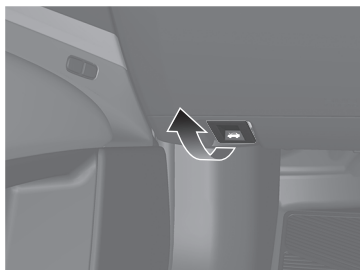

- 2** Locate the hood latch lever, push it to the side, and then raise the hood. Once you have raised the hood slightly, you can release the lever.



- 3** When finished, close the hood and make sure it is firmly locked in place.

Wiper Blades ↔ P. 517

- Replace blades if they leave streaks across the windshield.

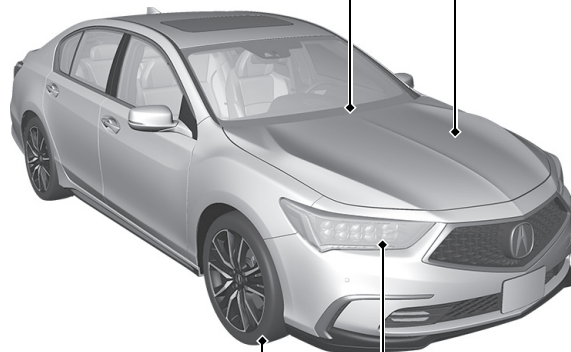

Tires ↔ P. 520

- Inspect tires and wheels regularly.
- Check tire pressures regularly.
- Install snow tires for winter driving.

Lights ↔ P. 514

- Inspect all lights regularly.

Handling the Unexpected ➔ P. 539

Flat Tire ➔ P. 541, 553

- Park in a safe location and repair the flat tire using the tire repair kit, or replace the flat tire with the compact spare tire*1.



Power System Won't Start ➔ P. 559

- If the 12-volt battery is dead, jump start using a booster battery.

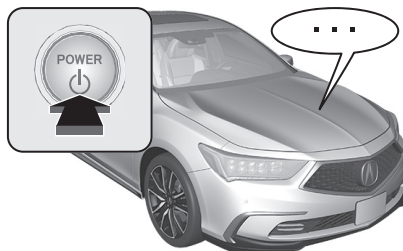

Overheating ➔ P. 565

- Park in a safe location. If you do not see steam under the hood, open the hood, and let the power system and the engine cool down.



Indicators Come On ➔ P. 567

- Identify the indicator and consult the owner's manual.

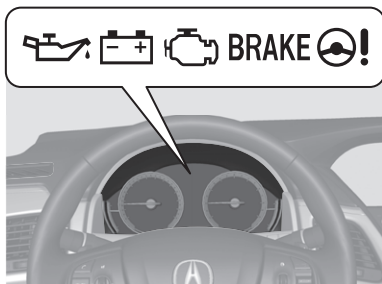

Blown Fuse ➔ P. 572

- Check for a blown fuse if an electrical device does not operate.

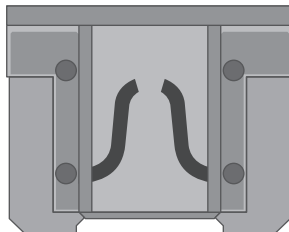

Emergency Towing ➔ P. 580

- Call a professional towing service if you need to tow your vehicle.



*1: Vehicles with optional spare tire kit

What to Do If

Q Why does the brake pedal pulsate slightly when applying the brakes?

A This can occur when the ABS activates and does not indicate a problem. Apply firm, steady pressure on the brake pedal. Never pump the brake pedal.

➤ Anti-lock Brake System (ABS) ➔ P. 456

Q The rear door cannot be opened from inside the vehicle. Why?

A Check if the childproof lock is in the LOCK position. If so, open the rear door with the outside door handle.

To cancel this function, slide the lever to the UNLOCK position.

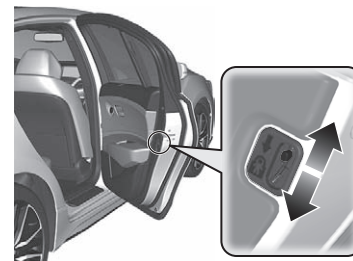

Q Why do the doors lock after I unlocked the doors?

A If you do not open the doors within 30 seconds, the doors are relocked automatically for security.

Q Why does the beeper sound when I open the driver's door?

A The beeper sounds when:

- The power mode is in ACCESSORY.
- The exterior lights are left on.

Q Why does a buzzer sound when I walk away from the vehicle after I close the door?

A The buzzer sounds if you move outside the walk away auto door lock operating range before the door completely closes.
➤ To lock (Walk Away Auto Door Lock) ➔ P. 133

Q Why does the beeper sound when I start driving?

A The beeper sounds when the driver and/or front passenger are not wearing their seat belts.

Q Why do I hear a screeching sound when I apply the brake pedal?

A The brake pads may need to be replaced. Have your vehicle inspected by a dealer.

Q I'm seeing an amber indicator of a tire with an exclamation point. What is that?

A The Tire Pressure Monitoring System (TPMS) needs attention. Check tire pressure.
➤ If the Low Tire Pressure/TPMS Indicator Comes On or Blinks ➔ P. 570

Q Pressing the electric parking brake switch does not release the parking brake. Why?

A Press the electric parking brake switch with the brake pedal depressed.

Q Depressing the accelerator pedal does not release the parking brake automatically. Why?

A

- Fasten the driver's seat belt.
- Check if the transmission is in **P** or **N**. If so, select any other position.

Q Why does the gear position automatically change to **P** when I open the driver's door to check for parking space lines when reversing?

A

- Fasten the driver's seat belt.
- Close the driver's door and manually change the gear position.
➤ When opening the driver's door 

Q Unleaded gasoline with a Pump Octane Number (PON) of 91 or higher is recommended. Is it possible to use unleaded gasoline with a Pump Octane Number (PON) of 87 or lower on this vehicle?

A

Unleaded gasoline with a Pump Octane Number (PON) of 91 or higher is recommended.

Use of lower octane gasoline can cause occasional metallic knocking noise in the engine and will result in decreased engine performance.

Use of gasoline with a pump octane less than 87 can lead to engine damage.

Safe Driving

You can find many safety recommendations throughout this chapter, and throughout this manual.

For Safe Driving

Important Safety Precautions.....	34
Your Vehicle's Safety Features.....	36
Safety Checklist	37

Seat Belts

About Your Seat Belts.....	38
Fastening a Seat Belt.....	41
Seat Belt Inspection.....	44

Airbags

Airbag System Components.....	45
Types of Airbags.....	48
Front Airbags (SRS)	48

Driver's Knee Airbag.....	52
Side Airbags.....	54
Side Curtain Airbags.....	56
Airbag System Indicators.....	57
Airbag Care	59

Child Safety

Protecting Child Passengers	60
Safety of Infants and Small Children...	62
Safety of Larger Children	70

Exhaust Gas Hazard

Carbon Monoxide Gas.....	72
--------------------------	----

Safety Labels

Label Locations	73
-----------------------	----

The following pages explain your vehicle's safety features and how to use them properly. The safety precautions below are ones that we consider to be among the most important.

Important Safety Precautions

■ Always wear your seat belt

A seat belt is your best protection in all types of collisions. Airbags are designed to supplement seat belts, not replace them. So even though your vehicle is equipped with airbags, make sure you and your passengers always wear your seat belts, and wear them properly.

■ Restrain all children

Children ages 12 and under should ride properly restrained in a back seat, not the front seat. Infants and small children should be restrained in a child seat. Larger children should use a booster seat and a lap/shoulder seat belt until they can use the belt properly without a booster seat.

■ Be aware of airbag hazards

While airbags can save lives, they can cause serious or fatal injuries to occupants who sit too close to them, or are not properly restrained. Infants, young children, and short adults are at the greatest risk. Be sure to follow all instructions and warnings in this manual.

■ Don't drink and drive

Alcohol and driving don't mix. Even one drink can reduce your ability to respond to changing conditions, and your reaction time gets worse with every additional drink. So don't drink and drive, and don't let your friends drink and drive, either.

⌘ Important Safety Precautions

Some states, provinces and territories prohibit the use of cell phones other than hands-free devices by the driver while driving.

■ Pay appropriate attention to the task of driving safely

Engaging in cell phone conversation or other activities that keep you from paying close attention to the road, other vehicles, and pedestrians could lead to a crash. Remember, situations can change quickly, and only you can decide when it is safe to divert some attention away from driving.

■ Control your speed

Excessive speed is a major factor in crash injuries and deaths. Generally, the higher the speed, the greater the risk, but serious injuries can also occur at lower speeds. Never drive faster than is safe for current conditions, regardless of the maximum speed posted.

■ Keep your vehicle in safe condition

Having a tire blowout or a mechanical failure can be extremely hazardous. To reduce the possibility of such problems, check your tire pressures and condition frequently, and perform all regularly scheduled maintenance.

■ Do not leave children unattended in the vehicle

Children, pets and people needing assistance left unattended in the vehicle may be injured if they activate one or more of the vehicle controls. They may also cause the vehicle to move, resulting in a crash in which they and/or another person(s) can be injured or killed. Also, depending on the ambient temperature, the temperature of the interior may reach extreme levels, which can result in harm or death. Even if the climate control system is on, never leave them in the vehicle unattended as the climate control system can shut off at any time.

Your Vehicle's Safety Features

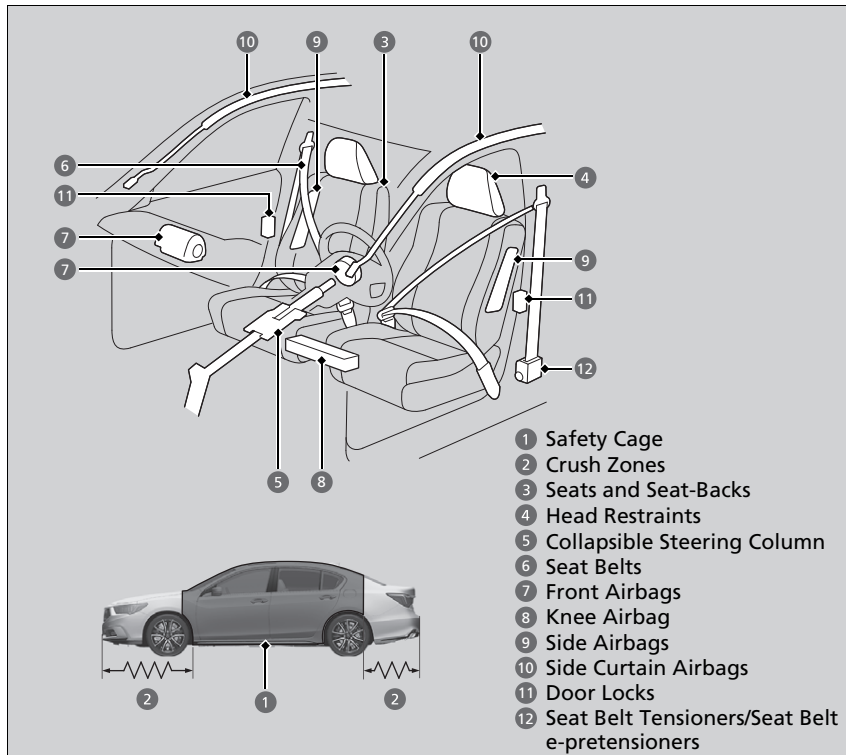

The following checklist will help you take an active role in protecting yourself and your passengers.

► Your Vehicle's Safety Features

Your vehicle is equipped with many features that work together to help protect you and your passengers during a crash.

Some features do not require any action on your part. These include a strong steel framework that forms a safety cage around the passenger compartment, front and rear crush zones, a collapsible steering column, and tensioners that tighten the front seat belts in a sufficient crash.

However, you and your passengers cannot take full advantage of these features unless you remain seated in the correct position and always wear your seat belts. In fact, some safety features can contribute to injuries if they are not used properly.

Safety Checklist

For the safety of you and your passengers, make a habit of checking these items each time before you drive.

- After everyone has entered the vehicle, be sure all doors are closed and locked. Locking the doors helps prevent an occupant from being ejected and an outsider from unexpectedly opening a door.
 - **Locking/Unlocking the Doors from the Inside** P. 139
- Adjust your seat to a position suitable for driving. Be sure the front seats are adjusted as far to the rear as possible while allowing the driver to control the vehicle. Sitting too close to a front airbag can result in serious or fatal injury in a crash.
 - **Adjusting the Seats** P. 175
- Adjust head restraints to the proper position. Head restraints are most effective when the center of the head restraint aligns with the center of your head. Taller persons should adjust their head restraint to the highest position.
 - **Adjusting the Front and Rear Outer Head Restraint Positions** P. 178
- Always wear your seat belt, and make sure you wear it properly. Confirm that any passengers are properly belted as well.
 - **Fastening a Seat Belt** P. 41
- Protect children by using seat belts or child seats according to a child's age, height and weight.
 - **Child Safety** P. 60

☒ Safety Checklist

If the door and/or trunk open message appears on the multi-information display, a door and/or the trunk is not completely closed. Close all doors and the trunk tightly until the message disappears.

➤ **Multi-Information Display Warning and Information Messages** P. 100



About Your Seat Belts

Seat belts are the single most effective safety device because they keep you connected to the vehicle so that you can take advantage of many built-in safety features. They also help keep you from being thrown against the inside of the vehicle, against any passengers, or out of the vehicle. When worn properly, seat belts also keep your body properly positioned in a crash so that you can take full advantage of the additional protection provided by the airbags.

In addition, seat belts help protect you in almost every type of crash, including:

- frontal impacts
- side impacts
- rear impacts
- rollovers

■ Lap/shoulder seat belts

All five seating positions are equipped with lap/shoulder seat belts with emergency locking retractors. In normal driving the retractor lets you move freely while keeping some tension on the belt. During a collision or sudden stop the retractor locks to restrain your body.

The front passenger's and rear seat belts also have a lockable retractor for use with child seats.

➤ **Installing a Child Seat with a Lap/Shoulder Seat Belt** P. 67

➤ About Your Seat Belts

WARNING

Not wearing a seat belt properly increases the chance of serious injury or death in a crash, even though your vehicle has airbags.

Be sure you and your passengers always wear seat belts and wear them properly.

Seat belts cannot completely protect you in every crash. But in most cases, seat belts can reduce your risk of serious injury.

Most states and all Canadian provinces and territories require you to wear seat belts.

If you extend the seat belt too quickly, it will lock in place. If this happens, slightly retract the seat belt, then extend it slowly.

■ Proper use of seat belts

Follow these guidelines for proper use:

- All occupants should sit upright, well back in the seat, and remain in that position for the duration of the trip. Slouching and leaning reduce the effectiveness of the belt and can increase the chance of serious injury in a crash.
- Never place the shoulder part of a lap/shoulder seat belt under your arm or behind your back. This could cause very serious injuries in a crash.
- Two people should never use the same seat belt. If they do, they could be very seriously injured in a crash.
- Do not put any accessories on the seat belts. Devices intended to improve comfort or reposition the shoulder part of a seat belt can reduce the protective capability and increase the chance of serious injury in a crash.

■ Seat Belt Reminder



The seat belt system includes an indicator on the instrument panel to remind the driver or a front passenger or both to fasten their seat belts.

If you set the power mode to ON and a seat belt is not fastened, a beeper will sound and the indicator will blink. After a few seconds, the beeper will stop and the indicator will come on and remain illuminated until the seat belt is fastened.

The beeper will periodically sound and the indicator will blink while the vehicle is moving until the seat belt is fastened.

▶▶ About Your Seat Belts

If a rear seat passenger moves around and extends the seat belt, the lockable retractor may activate. If this happens, release the retractor by unfastening the seat belt and allow the belt to retract completely. Then refasten the belt.

▶▶ Seat Belt Reminder

The indicator will also come on if a front passenger does not fasten their seat belt within six seconds after the power mode is set to ON.

When no one is sitting in the front passenger's seat, the indicator will not come on and the beeper will not sound.

The indicator also may not come on and the beeper may not sound when the occupant is not heavy enough to trigger the weight sensor. Such occupants (e.g., infants and smaller children) should be moved to the rear seat as a deploying front airbag likely will injure or kill them.

➤ **Protecting Child Passengers** P. 60

Automatic Seat Belt Tensioners

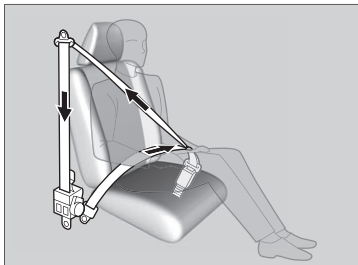

The front seats are equipped with automatic seat belt tensioners to enhance safety.

The tensioners automatically tighten the front seat belts during a moderate-to-severe frontal collision, sometimes even if the collision is not severe enough to inflate the front airbags or the driver's knee airbag.

Seat Belt e-pretensioners

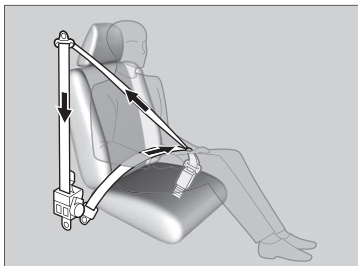

Are the motor-powered pretensioners that start to retract the front seat belts when the CMBS™, brake assist system, or VSA® system is in operation. They may also activate when you steer the vehicle hard, or the vehicle is impacted. After being retracted, the seat belts are slackened to their original positions. As convenience features, the e-pretensioners slightly retract the seat belts when you latch the seat belt buckle, depress the brake pedal more aggressively than you normally do, or make a sharp turn, and fully retract when you release the seat belt buckle.

Automatic Seat Belt Tensioners

The seat belt tensioners can only operate once. If a tensioner is activated, the SRS indicator will come on. Have a dealer replace the tensioner and thoroughly inspect the seat belt system as it may not offer protection in a subsequent crash.

During a moderate-to-severe side impact, the tensioner on that side of the vehicle also activates.

Seat Belt e-pretensioners

If only the e-pretensioners were activated, no components need to be replaced.

The e-pretensioners may not work if:

- Supplemental Restraint System Indicator is on.
- Vehicle Stability Assist™ (VSA®) System Indicator is on.
- A warning message for e-pretensioners appears on the multi-information display.

Fastening a Seat Belt

After adjusting a front seat to the proper position, and while sitting upright and well back in the seat:

➤ **Adjusting the Seats** P. 175

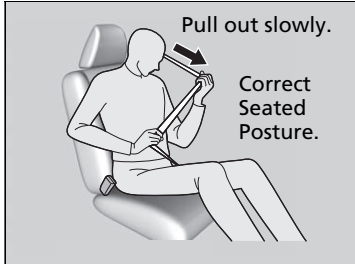

1. Pull the seat belt out slowly.

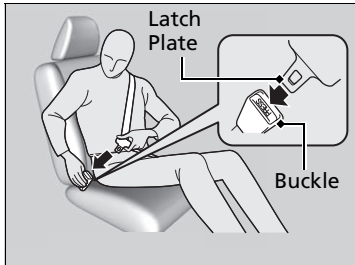

2. Insert the latch plate into the buckle, then tug on the belt to make sure the buckle is secure.

▶ Make sure that the belt is not twisted or caught on anything.

When you or the front passenger insert the latch plate into the buckle, the front seat belt retracts automatically.

➤ **Seat Belt e-pretensioners** P. 40

Fastening a Seat Belt

No one should sit in a seat with an inoperative seat belt or one that does not appear to be working correctly. Using a seat belt that is not working properly may not protect the occupant in a crash. Have a dealer check the belt as soon as possible.

Never insert any foreign objects into the buckle or retractor mechanism.



3. Position the lap part of the belt as low as possible across your hips, then pull up on the shoulder part of the belt so the lap part fits snugly. This lets your strong pelvic bones take the force of a crash and reduces the chance of internal injuries.
4. If necessary, pull up on the belt again to remove any slack, then check that the belt rests across the center of your chest and over your shoulder. This spreads the forces of a crash over the strongest bones in your upper body.

■ Adjusting the Shoulder Anchor

The front seats have adjustable shoulder anchors to accommodate taller and shorter occupants.

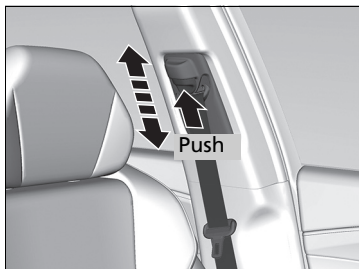

1. Move the anchor up and down while holding the release button.
2. Position the anchor so that the belt rests across the center of your chest and over your shoulder.

⌘ Fastening a Seat Belt

⚠ WARNING

Improperly positioning the seat belts can cause serious injury or death in a crash.

Make sure all seat belts are properly positioned before driving.

To release the belt, push the red **PRESS** button and then guide the belt by hand until it has retracted completely.

When exiting the vehicle, be sure the belt is properly stowed so that it will not get caught in the closing door.

⌘ Adjusting the Shoulder Anchor

The shoulder anchor height can be adjusted to four levels. If the belt contacts your neck, lower the height one level at a time.

After an adjustment, make sure that the shoulder anchor position is secure.

Advice for Pregnant Women

If you are pregnant, the best way to protect yourself and your unborn child when driving or riding in a vehicle is to always wear a seat belt and keep the lap part of the belt as low as possible across the hips.

Wear the shoulder belt across the chest avoiding the abdomen.



Wear the lap part of the belt as low as possible across the hips.

Advice for Pregnant Women

Each time you have a checkup, ask your doctor if it is okay for you to drive.

To reduce the risk of injuries to both you and your unborn child that can be caused by an inflating front airbag:

- When driving, sit upright and adjust the seat as far back as possible while allowing full control of the vehicle.
- When sitting in the front passenger's seat, adjust the seat as far back as possible.

Seat Belt Inspection

Regularly check the condition of your seat belts as follows:

- Pull each belt out fully, and look for frays, cuts, burns, and wear.
- Check that the latch plates and buckles work smoothly and the belts retract easily.
 - ▶ If a belt does not retract easily, cleaning the belt may correct the problem. Only use a mild soap and warm water. Do not use bleach or cleaning solvents. Make sure the belt is completely dry before allowing it to retract.

Any belt that is not in good condition or working properly will not provide proper protection and should be replaced as soon as possible.

A belt that has been worn during a crash may not provide the same level of protection in a subsequent crash. Have your seat belts inspected by a dealer after any collision.

▶▶ Seat Belt Inspection

WARNING

Not checking or maintaining seat belts can result in serious injury or death if the seat belts do not work properly when needed.

Check your seat belts regularly and have any problem corrected as soon as possible.

Airbag System Components

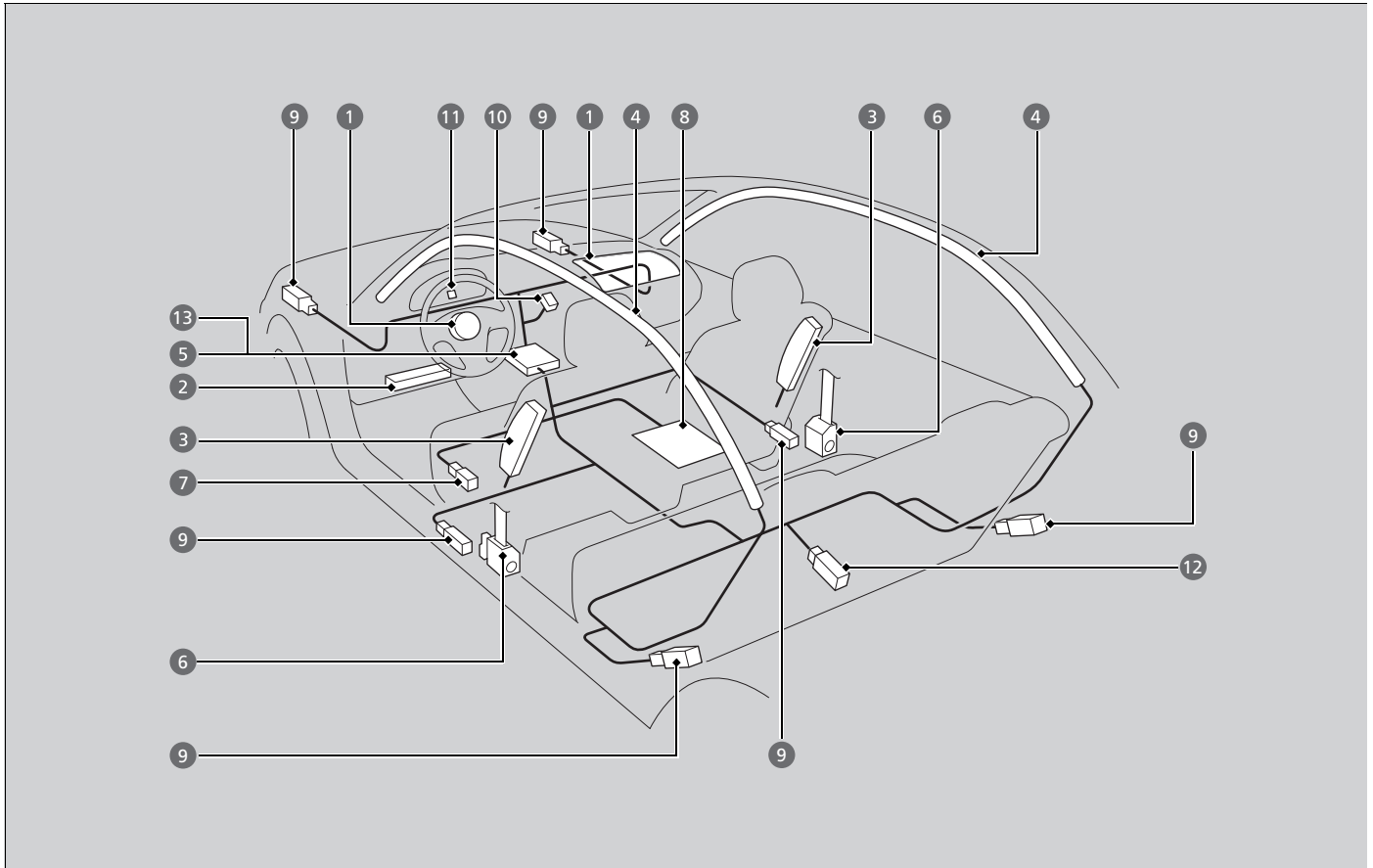

Continued

The front, driver's knee, front side, and side curtain airbags are deployed according to the direction and severity of impact. Both side curtain airbags are deployed in a rollover. The airbag system includes:

- 1 Two SRS (Supplemental Restraint System) front airbags. The driver's airbag is stored in the center of the steering wheel; the front passenger's airbag is stored in the dashboard. Both are marked **SRS AIRBAG**.
- 2 Driver's knee airbag. The knee airbag is stored under the steering column. It is marked **SRS AIRBAG**.
- 3 Two side airbags, one for the driver and one for a front passenger. The airbags are stored in the outer edges of the seat-backs. Both are marked **SIDE AIRBAG**.
- 4 Two side curtain airbags, one for each side of the vehicle. The airbags are stored in the ceiling, above the side windows. The front and rear pillars are marked **SIDE CURTAIN AIRBAG**.
- 5 An electronic control unit that, when the power mode is in ON, continually monitors information about the various impact sensors, seat and buckle sensors, rollover sensor, airbag activators, seat belt tensioners, and other vehicle information. During a crash event the unit can record such information.
- 6 Automatic front seat belt tensioners. In addition, the driver's and front passenger's seat belt buckles incorporate sensors that detect whether or not the belts are fastened. The front seat belt tensioners also include the e-pretensioners.
- 7 A driver's seat position sensor. This sensor determines the optimal force at which the airbag will deploy in a crash.
- 8 Weight sensors in the front passenger's seat. The front passenger's airbag will be turned off if the weight on the seat is approximately 65 lbs (29 kg) or less (the weight of an infant or small child).
- 9 Impact sensors that can detect a moderate-to-severe front or side impact.
- 10 An indicator on the dashboard that alerts you that the front passenger's front airbag has been turned off.
- 11 An indicator on the instrument panel that alerts you to a possible problem with your airbag system or seat belt tensioners.
- 12 Safing Sensor
- 13 A rollover sensor that can detect if your vehicle is about to roll over and signal the control unit to deploy both side curtain airbags.

Important Facts About Your Airbags

Airbags can pose serious hazards. To do their job, airbags must inflate with tremendous force. So, while airbags help save lives, they can cause burns, bruises, and other minor injuries, sometimes even fatal ones if occupants are not wearing their seat belts properly and sitting correctly.

What you should do: Always wear your seat belt properly, and sit upright and as far back from the steering wheel as possible while allowing full control of the vehicle. A front passenger should move their seat as far back from the dashboard as possible.

Remember, however, that no safety system can prevent all injuries or deaths that can occur in a severe crash, even when seat belts are properly worn and the airbags deploy.

Do not place hard or sharp objects between yourself and a front airbag.

Carrying hard or sharp objects on your lap, or driving with a pipe or other sharp object in your mouth, can result in injuries if your front airbag inflates.

Do not attach or place objects on the front and driver's knee airbag covers.

Objects on the covers marked **SRS AIRBAG** could interfere with the proper operation of the airbags or be propelled inside the vehicle and hurt someone if the airbags inflate.

Important Facts About Your Airbags

Do not attempt to deactivate your airbags. Together, airbags and seat belts provide the best protection.

When driving, keep hands and arms out of the deployment path of the front airbag by holding each side of the steering wheel. Do not cross an arm over the airbag cover.

Types of Airbags

Your vehicle is equipped with four types of airbags:

- **Front airbags:** Airbags in front of the driver's and front passenger's seats.
- **Driver's knee airbag:** Airbag under the steering column.
- **Side airbags:** Airbags in the driver's and front passenger's seat-backs.
- **Side curtain airbags:** Airbags above the side windows.

Each is discussed in the following pages.

Front Airbags (SRS)

The front SRS airbags inflate in a moderate-to-severe frontal collision to help protect the head and chest of the driver and/or front passenger.

SRS (Supplemental Restraint System) indicates that the airbags are designed to supplement seat belts, not replace them. Seat belts are the occupant's primary restraint system.

Housing Locations

The front airbags are housed in the center of the steering wheel for the driver, and in the dashboard for the front passenger. Both airbags are marked **SRS AIRBAG**.

Types of Airbags

The airbags can inflate whenever the power mode is in ON.

After an airbag inflates in a crash, you may see a small amount of smoke. This is from the combustion process of the inflator material and is not harmful. People with respiratory problems may experience some temporary discomfort. If this occurs, get out of the vehicle as soon as it is safe to do so.

Front Airbags (SRS)

During a frontal crash severe enough to cause one or both front airbags to deploy, the airbags can inflate at different rates, depending on the severity of the crash, whether or not the seat belts are latched, and/or other factors. Frontal airbags are designed to supplement the seat belts to help reduce the likelihood of head and chest injuries in frontal crashes.

■ Operation

Front airbags are designed to inflate during moderate-to-severe frontal collisions. When the vehicle decelerates suddenly, the sensors send information to the control unit which signals one or both front airbags to inflate.

A frontal collision can be either head-on or angled between two vehicles, or when a vehicle crashes into a stationary object, such as a concrete wall.

■ How the Front Airbags Work

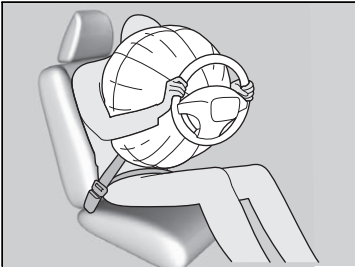

While your seat belt restrains your torso, the front airbag provides supplemental protection for your head and chest.

The front airbags deflate immediately so that they won't interfere with the driver's visibility or the ability to steer or operate other controls.

The total time for inflation and deflation is so fast that most occupants are not aware that the airbags deployed until they see them lying in front of them.

▣ How the Front Airbags Work

Although the driver's and front passenger's airbags normally inflate within a split second of each other, it is possible for only one airbag to deploy. This can happen if the severity of a collision is at the margin, or threshold that determines whether or not the airbags will deploy. In such cases, the seat belt will provide sufficient protection, and the supplemental protection offered by the airbag would be minimal.

■ When front airbags should not deploy

Minor frontal crashes: Front airbags were designed to supplement seat belts and help to save lives, not to prevent minor scrapes, or even broken bones that might occur during a less than moderate-to-severe frontal crash.

Side impacts: Front airbags can provide protection when a sudden deceleration causes a driver or front passenger to move towards the front of the vehicle. Side airbags and side curtain airbags have been specifically designed to help to reduce the severity of injuries that can occur during a moderate-to-severe side impact which can cause the driver or passenger to move towards the side of the vehicle.

Rear impacts: Head restraints and seat belts are your best protection during a rear impact. Front airbags cannot provide any significant protection and are not designed to deploy in such collisions.

Rollovers: In a rollover, your best form of protection is a seat belt or, if your vehicle is equipped with a rollover sensor, both a seat belt and a side curtain airbag. Front airbags, however, are not designed to deploy in a rollover as they would provide little if any protection.

■ When front airbags deploy with little or no visible damage

Because the airbag system senses sudden deceleration, a strong impact to the vehicle framework or suspension might cause one or more of the airbags to deploy. Examples include running into a curb, the edge of a hole, or other low fixed object that causes a sudden deceleration in the vehicle chassis. Since the impact is underneath the vehicle, damage may not be readily apparent.

■ When front airbags may not deploy, even though exterior damage appears severe

Since crushable body parts absorb crash energy during an impact, the amount of visible damage does not always indicate proper airbag operation. In fact, some collisions can result in severe damage but no airbag deployment because the airbags would not have been needed or would not have provided protection even if they had deployed.

Advanced Airbags

The airbags have advanced features to help reduce the likelihood of airbag related injuries to smaller occupants.

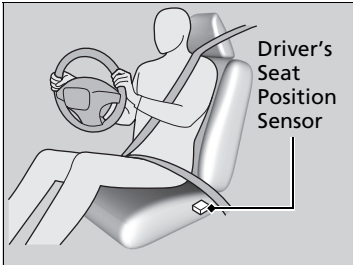

The driver's advanced airbag system includes a seat position sensor.

Based on information from this sensor and the severity of the impact, the advanced airbag system determines the optimal deployment of the driver's airbag.

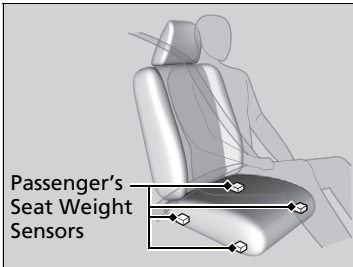

The front passenger's advanced airbag system has weight sensors.

We advise against allowing a child age 12 or under to ride in the front passenger's seat.

However, **if you do allow a child age 12 or under to ride in the front passenger's seat**, note that the system will automatically turn off the front passenger's airbag if the sensors detect that the child is approximately 65 lbs (29 kg) or less.

Advanced Airbags

If there is a problem with the driver's seat position sensor, the SRS indicator will come on, and in the event of a crash, the airbag will deploy (regardless of the driver's seating position) with a force corresponding to the severity of the impact.

For the advanced airbags to work properly:

- Do not spill any liquid on or under the seats.
- Do not put any object under the passenger's seat.
- Make sure any objects are positioned properly on the floor. Improperly positioned objects can interfere with the advanced airbag sensors.
- All occupants should sit upright and wear their seat belts properly.
- Do not cover the passenger's side dashboard with a cloth, towel, cover, etc.

Passenger Front Airbag Off Indicator

P. 58

Make sure the floor mat behind the front passenger's seat is hooked to the floor mat anchor. An improperly placed mat can interfere with the advanced airbag sensors.

Floor Mats P. 533

Driver's Knee Airbag

The driver's knee SRS airbag inflates in a moderate-to-severe frontal collision to help keep the driver in the proper position and to help maximize the benefit provided by the vehicle's other safety features.

SRS (Supplemental Restraint System) indicates that the airbag is designed to supplement seat belts, not replace them. Seat belts are the occupant's primary restraint system.

Housing Locations

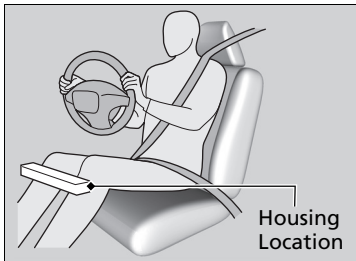

The driver's knee airbag is housed under the steering column.

The airbag is marked **SRS AIRBAG**.

Operation

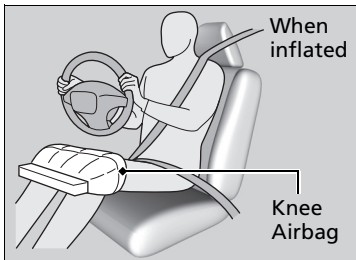

When the driver's front airbag inflates, the driver's knee airbag also inflates.

Even if the collision is not severe enough to deploy the front airbag, the knee airbag may inflate alone.

Driver's Knee Airbag

Do not attach accessories on or near the driver's knee airbag. They can interfere with the proper operation of the airbag, or hurt someone if an airbag inflates.

■ When driver's knee airbag deploys with little or no visible damage

Because the airbag system senses sudden deceleration, a strong impact to the vehicle framework or suspension might cause one or more of the airbags to deploy. Examples include running into a curb, the edge of a hole, or other low fixed object that causes a sudden deceleration in the vehicle chassis. Since the impact is underneath the vehicle, damage may not be readily apparent.

■ When driver's knee airbag may not deploy, even though exterior damage appears severe

Since crushable body parts absorb crash energy during an impact, the amount of visible damage does not always indicate proper airbag operation. In fact, some collisions can result in severe damage but no airbag deployment because the airbags would not have been needed or would not have provided protection even if they had deployed.

Side Airbags

The side airbags help protect the torso and pelvis of the driver or a front passenger during a moderate-to-severe side impact.

Housing Locations

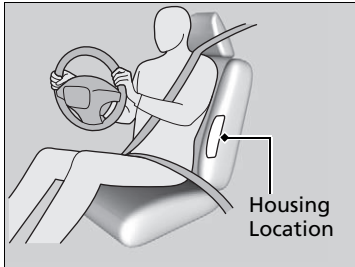

The side airbags are housed in the outside edge of the driver's and passenger's seat-backs.

Both are marked **SIDE AIRBAG**.

Operation

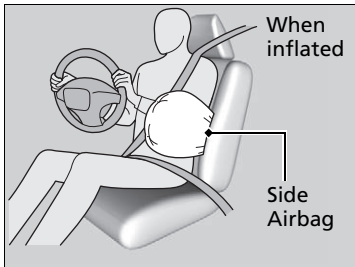

When the sensors detect a moderate-to-severe side impact, the control unit signals the side airbag on the impact side to immediately inflate.

Side Airbags

Make sure you and your front seat passenger always sit upright. Leaning into the path of a side airbag can prevent the airbag from deploying properly and increases your risk of serious injury.

Do not attach accessories on or near the side airbags. They can interfere with the proper operation of the airbags, or hurt someone if an airbag inflates.

Do not cover or replace the front seat-back covers without consulting a dealer. Improperly replacing or covering front seat-back covers can prevent your side airbags from properly deploying during a side impact.

■ When a side airbag deploys with little or no visible damage

Because the airbag system senses sudden acceleration, a strong impact to the side of the vehicle's framework can cause a side airbag to deploy. In such cases, there may be little or no damage, but the side impact sensors detected a severe enough impact to deploy the airbag.

■ When a side airbag may not deploy, even though visible damage appears severe

It is possible for a side airbag to not deploy during an impact that results in apparently severe damage. This can occur when the point of impact was toward the far front or rear of the vehicle, or when the vehicle's crushable body parts absorbed most of the crash energy. In either case, the side airbag would not have been needed nor provided protection even if it had deployed.

Side Curtain Airbags

The side curtain airbags help protect the heads of the driver and passengers in the outer seating positions during a moderate-to-severe side impact. The side curtain airbags equipped in this vehicle are also designed to help reduce the likelihood of partial and complete ejection of vehicle occupants through side windows in crashes, particularly rollover crashes.

Housing Locations

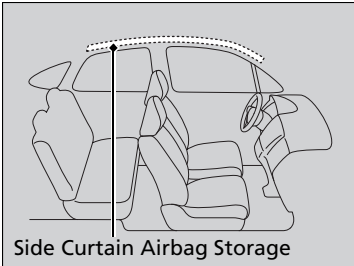

The side curtain airbags are located in the ceiling above the side windows on both sides of the vehicle.

Operation

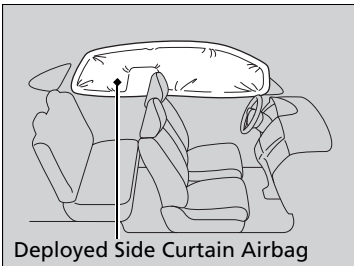

The side curtain airbag is designed to deploy in a rollover or a moderate-to-severe side impact.

Side Curtain Airbags

If the SRS control unit senses that your vehicle is about to rollover, it immediately deploys both side curtain airbags and activates both front seat belt tensioners.

If the impact is on the passenger's side, the passenger's side curtain airbag deploys even if there are no occupants on that side of the vehicle.

To get the best protection from the side curtain airbags, occupants should wear their seat belts properly and sit upright and well back in their seats.

Do not attach any objects to the side windows or roof pillars as they can interfere with the proper operation of the side curtain airbags.

■ When side curtain airbags deploy in a frontal collision

One or both side curtain airbags may also inflate in a moderate-to-severe angled frontal collision.

Airbag System Indicators

If a problem occurs in the airbag system, the SRS indicator will come on and a message appears on the multi-information display.

■ Supplemental Restraint System (SRS) Indicator



■ When the power mode is set to ON

The indicator comes on for a few seconds, then goes off. This tells you the system is working properly.

If the indicator comes on at any other time, or does not come on at all, have the system checked by a dealer as soon as possible. If you don't, your airbags and seat belt tensioners may not work properly when they are needed.

⊠ Supplemental Restraint System (SRS) Indicator

⚠ WARNING

Ignoring the SRS indicator can result in serious injury or death if the airbag systems or tensioners do not work properly.

Have your vehicle checked by a dealer as soon as possible if the SRS indicator alerts you to a possible problem.

Continued

■ Passenger Front Airbag Off Indicator

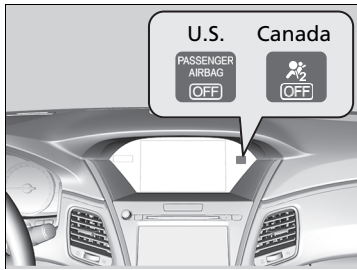

■ When the passenger front airbag off indicator comes on

The indicator comes on to alert you that the passenger's front airbag has been turned off. This occurs when the weight sensors detect about 65 lbs (29 kg) or less, the weight of an infant or small child, on the seat.

Children age 12 or under should always ride properly restrained in a back seat.

➤ **Child Safety** P. 60

Objects placed on the seat can also cause the indicator to come on.

If the front passenger seat is empty, the passenger's front airbag will not deploy and the indicator will not come on.

☒ Passenger Front Airbag Off Indicator

If the indicator comes on with no front passenger and no objects on the passenger's seat, or with an adult riding there, something may be interfering with the weight sensors, such as:

- An object hanging on the seat or in the seat-back pocket.
- A child seat or other object pressing against the rear of the seat-back.
- A rear passenger pushing or pulling on the back of the front passenger's seat.
- The front seat or seat-back is forced back against an object on the seat or floor behind it.
- An object placed under the front passenger's seat.

If none of these conditions exist, have your vehicle checked by a dealer as soon as possible.

The passenger front airbag off indicator may come on and go off repeatedly if the total weight on the seat is near the airbag cutoff threshold.

Airbag Care

You do not need to, and should not, perform any maintenance on or replace any airbag system components yourself. However, you should have your vehicle inspected by a dealer in the following situations:

■ When the airbags have deployed

If an airbag has inflated, the control unit and other related parts must be replaced. Similarly, once an automatic seat belt tensioner has been activated, it must be replaced.

■ When the vehicle has been in a moderate-to-severe collision

Even if the airbags did not inflate, have your dealer inspect the following: the driver's seat position sensor, weight sensors in the passenger's seat, front seat belt tensioners, and each seat belt that was worn during the crash.

■ Do not remove or modify a front seat without consulting a dealer

This would likely disable or affect the proper operation of the driver's seat position sensor or the weight sensors in the passenger's seat. If it is necessary to remove or modify a front seat to accommodate a person with disabilities, contact an Acura dealer, or for U.S. vehicles, Acura Client Relations at 1-800-382-2238 and for Canadian vehicles, Acura Client Services at 1-866-78-ACURA.

✘ Airbag Care

We recommend against the use of salvaged airbag system components, including the airbag, tensioners, sensors, and control unit.

Protecting Child Passengers

Each year, many children are injured or killed in vehicle crashes because they are either unrestrained or not properly restrained. In fact, vehicle crashes are the number one cause of death of children ages 12 and under.

To reduce the number of child deaths and injuries, every state, Canadian province and territory requires that infants and children be properly restrained when they ride in a vehicle.

Children should sit properly restrained in a rear seat. This is because:

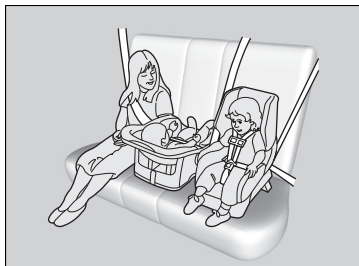

- An inflating front or side airbag can injure or kill a child sitting in the front seat.
- A child in the front seat is more likely to interfere with the driver's ability to safely control the vehicle.
- Statistics show that children of all sizes and ages are safer when they are properly restrained in a rear seat.

Protecting Child Passengers

⚠ WARNING

Children who are unrestrained or improperly restrained can be seriously injured or killed in a crash.

Any child too small for a seat belt should be properly restrained in a child seat. A larger child should be properly restrained with a seat belt, using a booster seat if necessary.

The National Highway Traffic Safety Administration and Transport Canada recommend that all children ages 12 and under be properly restrained in a rear seat. Some states or provinces/territories have laws restricting where children may ride.

- Any child who is too small to wear a seat belt correctly must be restrained in an approved child seat that is properly secured to the vehicle using either the seat belt or the lower anchors of the LATCH system.
- Never hold a child on your lap because it is impossible to protect them in the event of a collision.
- Never put a seat belt over yourself and a child. During a crash, the belt would likely press deep into the child and cause serious or fatal injuries.
- Never let two children use the same seat belt. Both children could be very seriously injured in a crash.
- Do not allow children to operate the doors, windows or seat adjustments.
- Do not leave children in the vehicle unattended, especially in hot weather when the inside of the vehicle can get hot enough to kill them. They could also activate vehicle controls causing it to move unexpectedly.

▶▶ Protecting Child Passengers

⚠ WARNING

Allowing a child to play with a seat belt or wrap one around their neck can result in serious injury or death.

Instruct children not to play with any seat belt and make sure any unused seat belt a child can reach is buckled, fully retracted, and locked.

To deactivate a lockable retractor, release the buckle and allow the seat belt to wind up all the way.

To remind you of the passenger's front airbag hazards and child safety, your vehicle has warning labels on the dashboard (U.S. models) and on the front visors. Please read and follow the instructions on these labels.

▶▶ **Safety Labels** P. 73

Safety of Infants and Small Children

■ Protecting Infants

An infant must be properly restrained in a rear-facing, reclining child seat until the infant reaches the seat manufacturer's weight or height limit for the seat, and the infant is at least one year old.

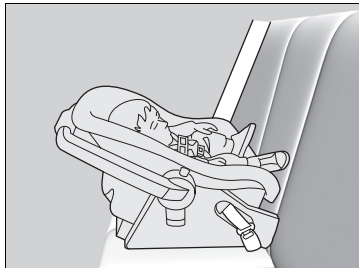

■ Positioning a rear-facing child seat

Child seats must be placed and secured in a rear seating position.

When properly installed, a rear-facing child seat may prevent the driver or a front passenger from moving their seat all the way back, or from locking their seat-back in the desired position. Make sure that there is no contact between the child seat and the seat in front of it.

It can also interfere with proper operation of the passenger's advanced front airbag system.

➤ **Airbags** P. 45

If this occurs, we recommend that you install the child seat directly behind the front passenger's seat, move the seat as far forward as needed, and leave it unoccupied. Or, you may wish to get a smaller rear-facing child seat.

▶▶ Protecting Infants

⚠ WARNING

Placing a rear-facing child seat in the front seat can result in serious injury or death during a crash.

Always place a rear-facing child seat in the rear seat, not the front.

Many experts recommend use of a rear-facing seat for a child up to two years old if the child's height and weight are appropriate for a rear-facing seat.

Rear-facing child seats should never be installed in a forward facing position.

Always refer to the child seat manufacturer's instructions before installation.

Do not allow a front seat to rest against a child seat installed in a rear seating position: The weight sensor in the front seat may not correctly detect the actual weight of the occupant.

Protecting Smaller Children

If a child is at least one year old and has exceeded the weight and height limitations of a rearward facing child seat, the child should be properly restrained in a firmly secured forward-facing child seat until they exceed the weight and height limitations for the forward-facing child seat.

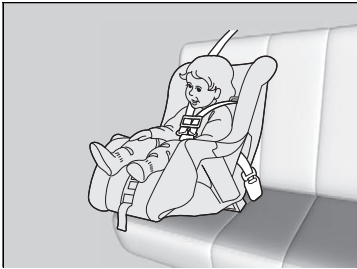

Forward-facing child seat placement

We strongly recommend placing a forward-facing child seat in a rear seating position.

Placing a forward-facing child seat in the front seat can be hazardous, even with advanced front airbags that automatically turn the passenger's front airbag off. A rear seat is the safest place for a child.

Protecting Smaller Children

WARNING

Placing a forward-facing child seat in the front seat can result in serious injury or death if the front airbag inflates.

If you must place a forward-facing child seat in front, move the vehicle seat as far back as possible, and properly restrain the child.

Educate yourself about the laws and regulations regarding child seat use where you are driving, and follow the child seat manufacturer's instructions.

■ Selecting a Child Seat

Most child seats are LATCH-compatible (Lower Anchors and Tethers for Children). Some have a rigid-type connector while others have a flexible-type connector. Both are equally easy to use. Some existing and previously owned child seats can only be installed using the seat belt. Whichever type you choose, follow the child seat manufacturer's use and care instructions including recommended expiration dates as well as the instructions in this manual. Proper installation is key to maximizing your child's safety.

In seating positions and vehicles not equipped with LATCH, a LATCH-compatible child seat can be installed using the seat belt and a top tether for added security. This is because all child seats are required to be designed so that they can be secured with a lap belt or the lap part of a lap/shoulder belt. In addition, the child seat manufacturer may advise that a seat belt be used to attach a LATCH-compatible seat once a child reaches a specified weight. Please read the child seat owner's manual for proper installation instructions.

■ Important consideration when selecting a child seat

Make sure the child seat meets the following three requirements:

- The child seat is the correct type and size for the child.
- The child seat is the correct type for the seating position.
- The child seat is compliant with Federal Motor Vehicle Safety Standard 213 or Canadian Motor Vehicle Safety Standard 213.

▶▶ Selecting a Child Seat

Installation of a LATCH-compatible child seat is simple.

LATCH-compatible child seats have been developed to simplify the installation process and reduce the likelihood of injuries caused by incorrect installation.

■ Installing a LATCH-Compatible Child Seat

A LATCH-compatible child seat can be installed in either of the two outer rear seats. A child seat is attached to the lower anchors with either the rigid or flexible type of connectors.

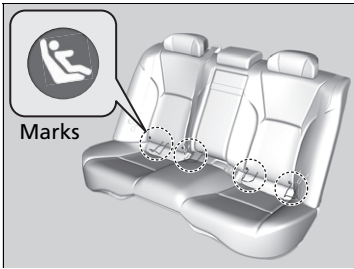

1. Locate the lower anchors under the marks.

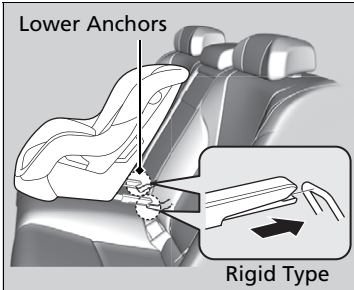

2. Place the child seat on the vehicle seat, then attach the child seat to the lower anchors according to the instructions that came with the child seat.

- ▶ When installing the child seat, make sure that the lower anchors are not obstructed by the seat belt or any other object.

▶▶ Installing a LATCH-Compatible Child Seat

⚠ WARNING

Never attach two child seats to the same anchor. In a collision, one anchor may not be strong enough to hold two child seat attachments and may break, causing serious injury or death.

For your child's safety, when using a child seat installed using the LATCH system, make sure that the child seat is properly secured to the vehicle. A child seat that is not properly secured will not adequately protect a child in a crash and may cause injury to the child or other vehicle occupants.

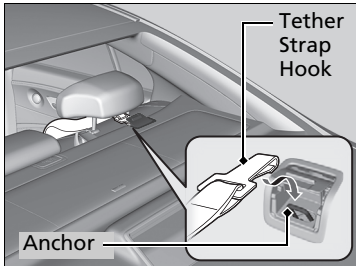
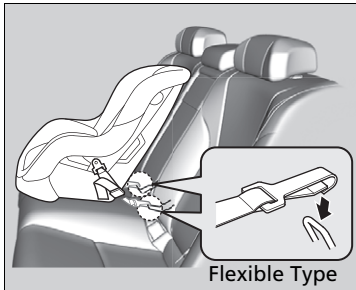

3. Open the tether anchor cover behind the head restraint.
4. Raise the head restraint to its highest position, then route the tether strap between the head restraint legs, and secure the tether strap hook to the anchor.
5. Tighten the tether strap as instructed by the child seat manufacturer.
6. Make sure the child seat is firmly secured by rocking it forward and back and side to side; little movement should be felt.
7. Make sure any unused seat belt that a child can reach is buckled, the lockable retractor is activated, and the belt is fully retracted and locked.

►► Installing a LATCH-Compatible Child Seat

⚠ WARNING

Do not use the lower inner anchors of the outer rear seats to secure a LATCH-compatible child seat to the rear center seat, unless the manufacturer's instructions for that system permit the use of inner anchors with the stated spacing.

Installing a LATCH-compatible child seat in the rear center seat

Each outer rear seat is equipped with a pair of lower anchors which are used to secure a LATCH-compatible child seat. The rear center seat, however, is not equipped with anchors of any kind. The inner and outer anchors are spaced apart at a standard distance of 11 inches (280 mm). The distance between the two inner anchors is 16.9 inches (430 mm).

LATCH-compatible restraint systems that are fitted with rigid-type attachments cannot be installed in the rear center seat. However, a system fitted with flexible-type attachments can be installed in the center seat, provided that the manufacturer's instructions for that system permit the use of the inner anchors with the stated spacing. Before seating a child, make sure that the system is properly attached to both the lower anchors and tether anchors.

■ Installing a Child Seat with a Lap/Shoulder Seat Belt

A child seat can be installed with a lap/shoulder belt in any rear seat or, if absolutely necessary, the front passenger seat.

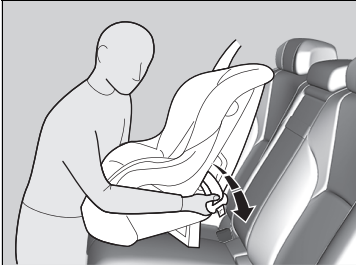

1. Place the child seat on the vehicle seat.
2. Route the seat belt through the child seat according to the seat manufacturer's instructions, and insert the latch plate into the buckle.
 - ▶ Insert the latch plate fully until it clicks.

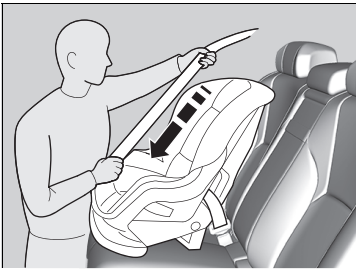

3. Slowly pull the shoulder part of the belt all the way out until it stops. This activates the lockable retractor.
4. Let the seat belt retract a few inches and check that the retractor has switched modes by pulling on the webbing. It should not pull out again until it is reset by removing the latch plate from the buckle.
 - ▶ If you are able to pull the shoulder belt out, the lockable retractor is not activated. Slowly pull the seat belt all the way out, and repeat steps 3 – 4.

⊠ Installing a Child Seat with a Lap/Shoulder Seat Belt

A child seat that is not properly secured will not adequately protect a child in a crash and may cause injury to the child or other vehicle occupants.

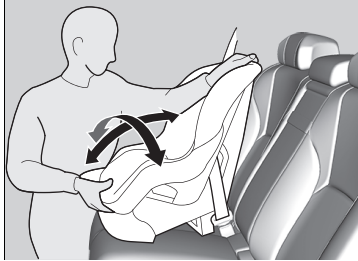

5. Grab the shoulder part of the seat belt near the buckle, and pull up to remove any slack from the lap part of the belt.

▶ When doing this, place your weight on the child seat and push it into the vehicle seat.

6. Make sure the child seat is firmly secured by rocking it forward and back and side to side; less than one inch of movement should occur near the seat belt.

7. Make sure any unused seat belt that a child can reach is buckled, the lockable retractor is activated, and the belt is fully retracted and locked.

▶▶ Installing a Child Seat with a Lap/Shoulder Seat Belt

To deactivate a lockable retractor, release the buckle and allow the seat belt to wind up all the way.

■ Adding Security with a Tether

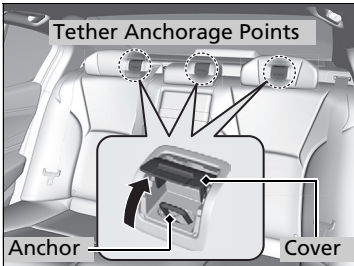

A tether anchorage point is provided behind each rear seating position. If you have a child restraint system that comes with a tether but can be installed with a seat belt, the tether may be used for additional security.

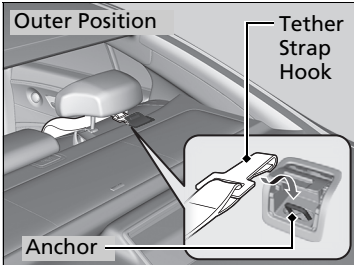

1. Locate the appropriate tether anchorage point and lift the cover.
2. Raise the head restraint to its highest position, then route the tether strap through the head restraint legs. Make sure the strap is not twisted.

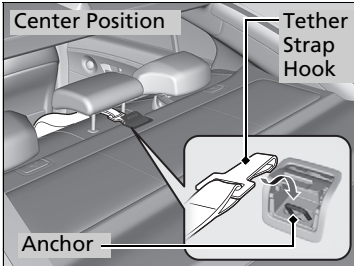

3. Secure the tether strap hook to the anchor.
4. Tighten the tether strap as instructed by the child seat manufacturer.

▣ Adding Security with a Tether

Always use a tether for forward-facing child seats when using the seat belt or lower anchors.

Safety of Larger Children

■ Protecting Larger Children

The following pages give instructions on how to check proper seat belt fit, what kind of booster seat to use if one is needed, and important precautions for a child who must sit in front.

■ Checking Seat Belt Fit

When a child is too big for a child seat, secure the child in a rear seat using the lap/shoulder seat belt. Have the child sit upright and all the way back, then answer the following questions.



■ Checklist

- Do the child's knees bend comfortably over the edge of the seat?
- Does the shoulder belt cross between the child's neck and arm?
- Is the lap part of the seat belt as low as possible, touching the child's thighs?
- Will the child be able to stay seated like this for the whole trip?

If you answer yes to all these questions, the child is ready to wear the lap/shoulder seat belt correctly. If you answer no to any question, the child needs to ride on a booster seat until the seat belt fits properly without a booster seat.

▶ Safety of Larger Children

⚠ WARNING

Allowing a child age 12 or under to sit in front can result in injury or death if the passenger's front airbag inflates.

If a larger child must ride in front, move the vehicle seat as far to the rear as possible, have the child sit up properly and wear the seat belt properly, using a booster seat if needed.

Booster Seats



If a lap/shoulder seat belt cannot be used properly, position the child in a booster seat in the rear seat. For the child's safety, check that the child meets the booster seat manufacturer's recommendations.

Protecting Larger Children-Final Checks

Your vehicle has a rear seat where children can be properly restrained. If you ever have to carry a group of children, and a child must ride in front:

- Make sure you read and fully understand the instructions and safety information in this manual.
- Move the front passenger seat as far back as possible.
- Have the child sit upright and well back in the seat.
- Check that the seat belt is properly positioned so that the child is secure in the seat.

Monitoring child passengers

We strongly recommend that you keep an eye on child passengers. Even older, more mature children sometimes need to be reminded to fasten their seat belts and sit up properly.

Booster Seats

When installing a booster seat, make sure to read the instructions that came with it, and install the seat accordingly.

There are high- and low-type booster seats. Choose a booster seat that allows the child to wear the seat belt correctly.

Some U.S. states, and Canadian provinces and territories require children to use a booster seat until they reach a given age or weight (e.g. six years or 60 lbs). Be sure to check current laws in the state or province, or territory where you intend to drive.

Carbon Monoxide Gas

The engine exhaust from this vehicle contains carbon monoxide, a colorless, odorless, and highly toxic gas. As long as you properly maintain your vehicle, carbon monoxide gas will not get into the interior.

■ Have the exhaust system inspected for leaks whenever

- The exhaust system is making an unusual noise.
- The exhaust system may have been damaged.
- The vehicle is raised for an oil change.

When you operate a vehicle with the trunk open, airflow can pull exhaust gas into the interior and create a hazardous condition. If you must drive with the trunk open, open all the windows and set the climate control system as shown below.

1. Select the fresh air mode.
2. Select the  mode.
3. Set the fan speed to high.
4. Set the temperature control to a comfortable setting.

Adjust the climate control system in the same manner if you sit in your parked vehicle with the engine running.

Carbon Monoxide Gas

WARNING

Carbon monoxide gas is toxic.

Breathing it can cause unconsciousness and even kill you.

Avoid any enclosed areas or activities that expose you to carbon monoxide.

An enclosed area such as a garage can quickly fill up with carbon monoxide gas.

Do not turn the power system on with the garage door closed. Even when the garage door is open, drive out of the garage immediately after turning the power system on.

Label Locations

These labels are in the locations shown. They warn you of potential hazards that can cause serious injury or death. Read these labels carefully.

If a label comes off or becomes hard to read (except for the U.S. dashboard label which may be removed by the owner), contact a dealer for a replacement.

Sun Visors

U.S. models

⚠ WARNING

EVEN WITH ADVANCED AIR BAGS

- Children can be killed or seriously injured by the air bag.
- The back seat is the safest place for children.
- Never put a rear-facing child seat in the front.
- Always use seat belts and child restraints.
- See owner's manual for more information about air bags.

Canadian models

⚠ WARNING	⚠ ATTENTION
<p>To avoid serious injury</p> <ul style="list-style-type: none"> For maximum safety protection in all types of crashes, you must always wear your safety belt. Do not install rearward-facing child seats in any front passenger seat position. Do not sit or lean unnecessarily close to the air bag. Do not place any objects over the air bag or between the air bag and yourself. See the owner's manual for further information and explanations. 	<p>Pour éviter des blessures graves</p> <ul style="list-style-type: none"> Pour profiter d'une protection maximale lors d'une collision, bouclez toujours votre ceinture de sécurité. N'installez jamais un siège pour enfants faisant face à l'arrière sur le siège du passager avant. Ne vous appuyez pas et ne vous assoyez pas près du coussin gonflable. Ne déposez aucun objet sur le coussin gonflable ou entre le coussin gonflable et vous. Lisez le guide utilisateur pour de plus amples renseignements.

High Voltage System Components

U.S. models

⚠ WARNING

HIGH VOLTAGE

- You can be killed or hurt.
- Do not remove this cover.
- No customer serviced parts inside.

Canadian models

⚠ WARNING

HIGH VOLTAGE

- You can be killed or hurt.
- Do not remove this cover.
- No customer serviced parts inside.

⚠ ATTENTION

HAUTE TENSION

- Vous pouvez être blessé ou tué.
- Ne pas enlever ce couvercle.
- Aucune pièce à l'intérieur que le client peut réparer.

Dashboard

U.S. models only

This Vehicle is Equipped with Advanced Air Bags

Even with Advanced Air Bags
Children can be killed or seriously injured by the air bag.
The back seat is the safest place for children.
Never put a rear-facing child seat in the front.
Always use seat belts and child restraints.
See owner's manual for more information about air bags.

Radiator Cap

DANGER
WARNING
危険
危険

NEVER OPEN WHEN HOT.
Hot coolant will scald you.
N'OUVREZ PAS QUAND CHAUD.
HOT COOLANT WILL SCALD YOU.
NEVER OPEN WHEN HOT.
熱い液体あけなくてください。
高温時、請勿打开。

108KPF

Radiator Cap

DANGER
WARNING
危険
危険

NEVER OPEN WHEN HOT.
Hot coolant will scald you.
N'OUVREZ PAS QUAND CHAUD.
HOT COOLANT WILL SCALD YOU.
NEVER OPEN WHEN HOT.
熱い液体あけなくてはいけません。
高温時、請勿打开。

0.5



Instrument Panel





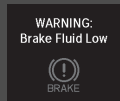
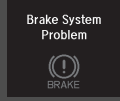

This chapter describes the buttons, indicators, and gauges that are used while driving.

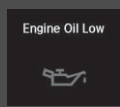





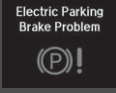

Indicators	76
Multi-Information Display Warning and Information Messages.....	94
Gauges and Displays	
Gauges.....	112
Multi-Information Display	114
Head-Up Display.....	119

Indicators



Indicator	Name	On/Blinking	Explanation	Message
	Brake System Indicator (Red)	<ul style="list-style-type: none"> Comes on for a few seconds when you set the power mode to ON, then goes off. Comes on when the brake fluid level is low. Comes on if there is a problem with the brake system. 	<ul style="list-style-type: none"> Comes on while driving - Check the brake fluid level. <ul style="list-style-type: none"> ➤ What to do when the indicator comes on while driving P. 568 Comes on along with the brake system indicator (amber) - Immediately stop in a safe place. Contact a dealer for repair. The brake pedal becomes harder to operate. Depress the pedal further than you normally do. Comes on along with the ABS indicator - Have your vehicle checked by a dealer. <ul style="list-style-type: none"> ➤ If the Brake System Indicator (Red) Comes On P. 568 	 
	Low Oil Pressure Indicator	<ul style="list-style-type: none"> Comes on when you set the power mode to ON, and goes off when the power system starts. Comes on when the engine oil pressure is low. 	<ul style="list-style-type: none"> Comes on while driving - Immediately stop in a safe place. <ul style="list-style-type: none"> ➤ If the Low Oil Pressure Indicator Comes On P. 567 	



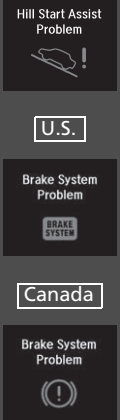
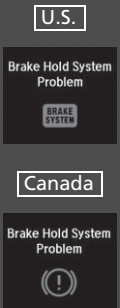



Indicator	Name	On/Blinking	Explanation	Message
	Electric Parking Brake Indicator	<ul style="list-style-type: none"> • Comes on for a few seconds when you set the power mode to ON, then goes off if the parking brake has been released. • Comes on when the parking brake is applied, and goes off when it is released. • Comes on for about 15 seconds then goes off when you pull the electric parking brake switch with the power mode in OFF. • Comes on for about 15 seconds then goes off when you set the power mode to OFF with the parking brake applied. 	<ul style="list-style-type: none"> • Blinks and the electric parking brake system indicator comes on at the same time - There is a problem with the electric parking brake system. The parking brake may not be set. 	
	Electric Parking Brake System Indicator	<ul style="list-style-type: none"> • Comes on when you press the electric parking brake switch without depressing the brake pedal. 	<ul style="list-style-type: none"> • Depress the brake pedal to release the parking brake.  Parking Brake P. 450 	
		<ul style="list-style-type: none"> • Comes on for a few seconds when you set the power mode to ON, then goes off. • Comes on if there is a problem with the electric parking brake system. 	<ul style="list-style-type: none"> • Comes on while driving - Avoid using the parking brake and have your vehicle checked by a dealer immediately.  If the Electric Parking Brake System Indicator Comes On P. 569 	





Indicator	Name	On/Blinking	Explanation	Message
	Automatic Brake Hold System Indicator	<ul style="list-style-type: none"> • Comes on for a few seconds when you set the power mode to ON, then goes off. • Comes on when the automatic brake hold system is on. 	 Automatic Brake Hold P. 454	
	Automatic Brake Hold Indicator	<ul style="list-style-type: none"> • Comes on for a few seconds when you set the power mode to ON, then goes off. • Comes on when the automatic brake hold is activated. 	 Automatic Brake Hold P. 454	







Indicator	Name	On/Blinking	Explanation	Message
	Brake System Indicator (Amber)	<ul style="list-style-type: none"> • Comes on for a few seconds when you set the power mode to ON, then goes off. • Comes on if there is a problem with a system related to braking other than the conventional brake system. • Comes on if there is a problem with the cooperative control with regenerative braking, the electric servo brake system, or the hill start assist system. 	<ul style="list-style-type: none"> • Comes on while driving - Have your vehicle checked by a dealer. • Stays on constantly - Avoid high speeds and sudden braking. Take the vehicle to a dealer immediately. • With this indicator on, your vehicle still has normal braking ability. 	
		<ul style="list-style-type: none"> • Comes on if there is a problem with the automatic brake hold system. 	<p>➔ Automatic Brake Hold P. 454</p>	





Instrument Panel





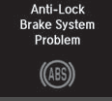

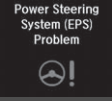

Indicator	Name	On/Blinking	Explanation	Message
POWER SYSTEM	POWER SYSTEM Indicator	<ul style="list-style-type: none"> Comes on for a few seconds when you set the power mode to ON, then goes off. Comes on if there is a problem with the electric vehicle system. 	<ul style="list-style-type: none"> Comes on while driving - Have your vehicle checked by a dealer immediately. 	
READY	READY Indicator	<ul style="list-style-type: none"> Comes on when the vehicle is ready to drive. 	<p>➤ Turning on the Power P. 378</p>	



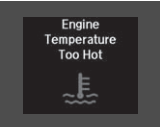

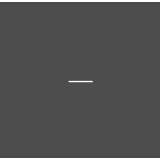

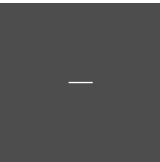

Indicator	Name	On/Blinking	Explanation	Message
	Malfunction Indicator Lamp	<ul style="list-style-type: none"> • Comes on when you set the power mode to ON, and goes off either when the power system is on or after several seconds if the power system did not turn on. If “readiness codes” have not been set, it blinks five times before it goes off. • Comes on if there is a problem with the emissions control system. • Blinks when a misfire in the engine’s cylinders is detected. 	<ul style="list-style-type: none"> • Readiness codes are part of the on board diagnostics for the emissions control systems. <ul style="list-style-type: none"> ► Testing of Readiness Codes P. 591 • Comes on while driving - Have your vehicle checked by a dealer. • Blinks while driving - Stop in a safe place where there are no flammable objects. Stop the power system for 10 minutes or more, and wait for it to cool down. Then, take the vehicle to a dealer. <ul style="list-style-type: none"> ► If the Malfunction Indicator Lamp Comes On or Blinks P. 568 	
	12-Volt Battery Charging System Indicator	<ul style="list-style-type: none"> • Comes on when you set the power mode to ON, and goes off when the power system is on. • Comes on when the 12-volt battery is not charging. 	<ul style="list-style-type: none"> • Comes on while driving - Turn off the climate control system and rear defogger in order to reduce electricity consumption. <ul style="list-style-type: none"> ► If the 12-Volt Battery Charging System Indicator Comes On P. 567 	
	Gear Position Indicator	<ul style="list-style-type: none"> • Indicates the current gear position. 	<ul style="list-style-type: none"> ► Shifting P. 385 	







Indicator	Name	On/Blinking	Explanation	Message
	Transmission System Indicator	<ul style="list-style-type: none"> All the gear positions may light for several seconds, and go off. 	<ul style="list-style-type: none"> When all the gear positions light, immediately stop your vehicle in a safe place. Indicators go off if there is no problem. However, even if they go off, take your vehicle to a dealer for inspection. 	
		<ul style="list-style-type: none"> The current gear position blinks if the transmission system has a problem. 	<ul style="list-style-type: none"> Blinks while driving - Avoid sudden starts and acceleration and have your vehicle checked by a dealer immediately. 	
		<ul style="list-style-type: none"> The current gear position or all the gear positions blink if there is a problem with the transmission and the vehicle is no longer able to run. 	<ul style="list-style-type: none"> Immediately park your car in a safe place. <ul style="list-style-type: none"> 🚚 Emergency Towing P. 580 Have your vehicle checked by a dealer. 	
		<ul style="list-style-type: none"> The current gear position or all the gear positions blink if there is a problem with the transmission and it is not possible to select P. 	<ul style="list-style-type: none"> Depending on the circumstances, you can set the power system to ON as an emergency measure. <ul style="list-style-type: none"> 🚚 If the Transmission System Indicator Blinks along with the Warning Message P. 571 While the vehicle is stopped, apply the parking brake. Have your vehicle checked by a dealer immediately. 	

Indicator	Name	On/Blinking	Explanation	Message
	M (sequential mode) Indicator/ Sequential Mode Gear Selection Indicator	<ul style="list-style-type: none"> Comes on when the manual sequential mode is applied. 	<p>► Sequential Mode P. 391</p>	<p>—</p>
	Seat Belt Reminder Indicator	<ul style="list-style-type: none"> Comes on and the beeper sounds if you are not wearing a seat belt when you set the power mode to ON. If the front passenger is not wearing a seat belt, the indicator comes on a few seconds later. Blinks while driving if either you and/or the front passenger has not fastened a seat belt. The beeper sounds and the indicator blinks at regular intervals. 	<ul style="list-style-type: none"> The beeper stops and the indicator goes off when you and the front passenger fasten their seat belts. Stays on after you and/or the front passenger has fastened the seat belt(s) - A detection error may have occurred in the sensor. Have your vehicle checked by a dealer. <p>► Seat Belt Reminder P. 39</p>	<p>Fasten Seat Belt</p>  <p>Fasten Passenger's Seat Belt</p> 
	Low Fuel Indicator	<ul style="list-style-type: none"> Comes on when the fuel reserve is running low (approximately 1.8 U.S. gal/7.0 Liter left). Blinks if there is a problem with the fuel gauge. 	<ul style="list-style-type: none"> Comes on - Refuel your vehicle as soon as possible. Blinks - Have your vehicle checked by a dealer. 	<p>Fuel Low</p>  <p>Fuel Gauge System Problem</p> 









Indicator	Name	On/Blinking	Explanation	Message
	Anti-lock Brake System (ABS) Indicator	<ul style="list-style-type: none"> Comes on for a few seconds when you set the power mode to ON, then goes off. If it comes on at any other time, there is a problem with the ABS. 	<ul style="list-style-type: none"> Stays on constantly - Have your vehicle checked by a dealer. With this indicator on, your vehicle still has normal braking ability but no anti-lock function. ➤ Anti-lock Brake System (ABS) P. 456 	
	Supplemental Restraint System Indicator	<ul style="list-style-type: none"> Comes on for a few seconds when you set the power mode to ON, then goes off. Comes on if a problem with any of the following is detected: <ul style="list-style-type: none"> - Supplemental restraint system - Driver's knee airbag - Side airbag system - Side curtain airbag system 	<ul style="list-style-type: none"> Stays on constantly or does not come on at all - Have your vehicle checked by a dealer. 	
	Electric Power Steering (EPS) System Indicator	<ul style="list-style-type: none"> Comes on when you set the power mode to ON, and goes off when the power system is on. Comes on if there is a problem with the EPS system. 	<ul style="list-style-type: none"> Stays on constantly - Have your vehicle checked by a dealer. ➤ If the Electric Power Steering (EPS) System Indicator Comes On P. 569 	







Indicator	Name	On/Blinking	Explanation	Message
	High Temperature Indicator	<ul style="list-style-type: none"> Comes on for a few seconds when you set the power mode to ON, then goes off. Blinks when the engine coolant temperature goes up, and stays on if the temperature continues to rise. 	<ul style="list-style-type: none"> Blinks while driving - Drive slowly to prevent overheating. 	
			<ul style="list-style-type: none"> Stays on while driving - Immediately stop in a safe place and allow the engine to cool. <ul style="list-style-type: none"> ➤ Overheating P. 565 	
	Low Temperature Indicator	<ul style="list-style-type: none"> Comes on for a few seconds when you set the power mode to ON, then goes off. Comes on when the engine coolant temperature is low. 	<ul style="list-style-type: none"> If the indicator stays on after the engine has reached normal operating temperature, there may be problem with the temperature sensors. Have your vehicle inspected by a dealer. 	
	Vehicle Stability Assist™ (VSA®) System Indicator	<ul style="list-style-type: none"> Comes on for a few seconds when you set the power mode to ON, then goes off. Blinks when VSA® is active. Comes on if there is a problem with the VSA® system. 	<ul style="list-style-type: none"> Stays on constantly - Have your vehicle checked by a dealer. <ul style="list-style-type: none"> ➤ Vehicle Stability Assist™ (VSA®), aka Electronic Stability Control (ESC), System P. 439 	
	Vehicle Stability Assist™ (VSA®) OFF Indicator	<ul style="list-style-type: none"> Comes on for a few seconds when you set the power mode to ON, then goes off. Comes on when you partially disable VSA®. 	<ul style="list-style-type: none"> ➤ VSA® On and Off P. 440 	





Indicator	Name	On/Blinking	Explanation	Message
	Low Tire Pressure/TPMS Indicator	<ul style="list-style-type: none"> • Comes on for a few seconds when you set the power mode to ON, then goes off. • Comes on if the tire pressure of any of the tires becomes significantly low. 	<ul style="list-style-type: none"> • Comes on while driving - Stop in a safe place, check tire pressures, and inflate the tire(s) if necessary. 	
		<ul style="list-style-type: none"> • Blinks for about one minute, and then stays on if there is a problem with the TPMS, or when a compact spare tire* is temporarily installed. 	<ul style="list-style-type: none"> • Blinks and remains on - Have your vehicle checked by a dealer. If the vehicle is fitted with a compact spare*, get your regular tire repaired or replaced and put back on your vehicle as soon as you can. 	
	System Message Indicator	<ul style="list-style-type: none"> • Comes on for a few seconds when you set the power mode to ON, then goes off. • Comes on along with a beep when a problem is detected. A system message on the multi-information display appears at the same time. 	<ul style="list-style-type: none"> • While the indicator is on, roll the right selector wheel to see the message again. • Refer to the Indicators information in this chapter when a system message appears on the multi-information display. Take the appropriate action for the message. • The multi-information display does not return to the normal screen unless the warning is canceled, or the right selector wheel is rolled. 	
	Turn Signal and Hazard Warning Indicators	<ul style="list-style-type: none"> • Blinks when you operate the turn signal lever. • Blink along with all turn signals when you press the hazard warning button. 	<ul style="list-style-type: none"> • Does not blink or blinks rapidly  Replacing Light Bulbs P. 514, 515 	



Indicator	Name	On/Blinking	Explanation	Message
	High Beam Indicator	<ul style="list-style-type: none"> Comes on when the high beam headlights are on. 	—	—
	Lights On Indicator	<ul style="list-style-type: none"> Comes on whenever the light switch is on, or in AUTO when the exterior lights are on. 	<ul style="list-style-type: none"> If you set the power mode to ACCESSORY or VEHICLE OFF while the exterior lights are on, a chime sounds when the driver's door is opened. 	—
	Auto High-Beam Indicator	<ul style="list-style-type: none"> Comes on for a few seconds when you set the power mode to ON, then goes off. Comes on when all the operating conditions of the auto high-beam are met. 	<ul style="list-style-type: none">  Auto High-Beam P. 160 	—
	Fog Light Indicator*	<ul style="list-style-type: none"> Comes on when the fog lights are on. 	<ul style="list-style-type: none">  Fog Lights* P. 159 	—
	Immobilizer System Indicator	<ul style="list-style-type: none"> Comes on briefly when you set the power mode to ON, then goes off. Blinks if the immobilizer system cannot recognize the key information. 	<ul style="list-style-type: none"> Blinks - You cannot start the power system. Set the power mode to VEHICLE OFF, then select the ON mode again. Repeatedly blinks - The system may be malfunctioning. Have your vehicle checked by a dealer. Do not attempt to alter this system or add other devices to it. Electrical problems can occur. 	—







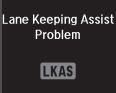

* Not available on all models





Indicator	Name	On/Blinking	Explanation	Message
 <p>Indicator</p>	Security System Alarm Indicator	<ul style="list-style-type: none"> Blinks when the security system alarm has been set. 	 Security System Alarm P. 146	—
	Keyless Access System Indicator	<ul style="list-style-type: none"> Comes on for a few seconds when you set the power mode to ON, then goes off. Comes on as soon as a problem is detected in the keyless access system or keyless starting system. 	<ul style="list-style-type: none"> Have your vehicle checked by a dealer. 	 <p>Keyless Access System Problem</p>  <p>Keyless Start System Problem</p>
	SPORT Mode Indicator	<ul style="list-style-type: none"> Comes on for a few seconds when you set the power mode to ON, then goes off. Comes on when you press the SPORT button. 	 SPORT Mode P. 393	 <p>SPORT On</p>

Indicator	Name	On/Blinking	Explanation	Message
	Road Departure Mitigation (RDM) Indicator	<ul style="list-style-type: none"> • Comes on for a few seconds when you change the power mode to ON, then goes off. • Comes on if there is a problem with the RDM system. 	<ul style="list-style-type: none"> • Stays on constantly - Have your vehicle checked by a dealer. 	
		<ul style="list-style-type: none"> • Comes on when the RDM system shuts itself off. 	<ul style="list-style-type: none"> • Stays on - The temperature inside the camera is too high. Use the climate control system to cool down the camera. The system activates when the temperature inside the camera cools down.  Front Sensor Camera P. 400 	
			<ul style="list-style-type: none"> • Stays on - The area around the camera is blocked by dirt, mud, etc. Stop your vehicle in a safe place, and wipe it off with a soft cloth. • Have your vehicle checked by a dealer if the indicator and message come back on after you cleaned the area around the camera.  Front Sensor Camera P. 400 	

Indicator	Name	On/Blinking	Explanation	Message
	Adaptive Cruise Control (ACC) with Low Speed Follow Indicator (Amber)	<ul style="list-style-type: none"> • Comes on for a few seconds when you set the power mode to ON, then goes off. • Comes on if there is a problem with ACC with Low Speed Follow. • Comes on if anything covers the radar sensor cover and prevents the sensor from detecting a vehicle in front. • May come on when driving in bad weather (rain, snow, fog, etc.) • ACC with Low Speed Follow has been automatically canceled. 	<ul style="list-style-type: none"> • Comes on while driving - Have your vehicle checked by a dealer. • When the radar sensor gets dirty, stop your vehicle in a safe place, and wipe off dirt using a soft cloth. • Have your vehicle checked by a dealer if the indicator does not go off even after you clean the sensor cover. 	 
	Adaptive Cruise Control (ACC) with Low Speed Follow Indicator (Green)	<ul style="list-style-type: none"> • Comes on when you press the MAIN button. 	<p>➤ Adaptive Cruise Control (ACC) with Low Speed Follow P. 402</p>	



Indicator	Name	On/Blinking	Explanation	Message
	Lane Keeping Assist System (LKAS) Indicator (Amber)	<ul style="list-style-type: none"> • Comes on for a few seconds when you change the power mode to ON, then goes off. • Comes on if there is a problem with the LKAS. 	<ul style="list-style-type: none"> • Stays on constantly - Have your vehicle checked by a dealer. 	
	Lane Keeping Assist System (LKAS) Indicator (Green)	<ul style="list-style-type: none"> • Comes on when you press the MAIN button. 	<ul style="list-style-type: none"> ➤ Lane Keeping Assist System (LKAS) P. 421 ➤ Traffic Jam Assist P. 428 	

Indicator	Name	On/Blinking	Explanation	Message
	Blind spot information System Indicator	<ul style="list-style-type: none"> • Comes on for a few seconds when you change the power mode to ON, then goes off. • Stays on while the blind spot information system is turned off. 	—	
		<ul style="list-style-type: none"> • Comes on when mud, snow, or ice accumulates in the vicinity of sensor. 	<ul style="list-style-type: none"> • Comes on while driving - Remove the obstacle in the vicinity of sensor.  Blind spot information System P. 443 	
		<ul style="list-style-type: none"> • Comes on if there is a problem with the system. 	<ul style="list-style-type: none"> • Comes on while driving - Have your vehicle checked by a dealer. 	
	Collision Mitigation Braking System™ (CMBS™) Indicator	<ul style="list-style-type: none"> • Comes on for a few seconds when you change the power mode to ON, then goes off. • Comes on when you deactivate the CMBS™. A multi-information display message appears for five seconds. • Comes on if there is a problem with the CMBS™. 	<ul style="list-style-type: none"> • Stays on constantly without the CMBS™ off - Have your vehicle checked by a dealer.  Collision Mitigation Braking System™ (CMBS™) P. 458 	 





Indicator	Name	On/Blinking	Explanation	Message
	Collision Mitigation Braking System™ (CMBS™) Indicator	<ul style="list-style-type: none"> Comes on when the CMBS™ shuts itself off. 	<ul style="list-style-type: none"> Stays on - The area around the camera is blocked by dirt, mud, etc. Stop your vehicle in a safe place, and wipe it off with a soft cloth. <ul style="list-style-type: none"> ➤ Front Sensor Camera P. 400 	
			<ul style="list-style-type: none"> When the radar sensor gets dirty, stop your vehicle in a safe place, and wipe off dirt using a soft cloth. Have your vehicle checked by a dealer if the indicator does not go off even after you clean the sensor cover. <ul style="list-style-type: none"> ➤ Collision Mitigation Braking System™ (CMBS™) P. 458 	
			<ul style="list-style-type: none"> Stays on - The temperature inside the camera is too high. Use the climate control system to cool down the camera. The system activates when the temperature inside the camera cools down. <ul style="list-style-type: none"> ➤ Front Sensor Camera P. 400 	

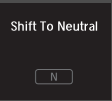
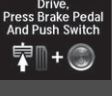

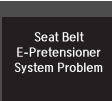
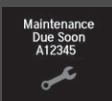
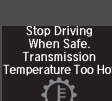
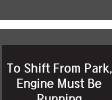

Multi-Information Display Warning and Information Messages

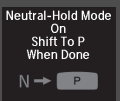



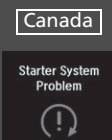

The following messages appear only on the multi-information display. Roll the right selector wheel to see the message again with the system message indicator on.



Message	Condition	Explanation
	<ul style="list-style-type: none"> Appears when the vehicle is no longer able to run due to its malfunction. 	<ul style="list-style-type: none"> Immediately stop in a safe place. Have your vehicle checked by a dealer immediately.
	<ul style="list-style-type: none"> Appears if you cannot select P due to a malfunction. 	<ul style="list-style-type: none"> While the vehicle is stopped, apply the parking brake. Depending on the circumstances, you can set the power system to ON as an emergency measure. <ul style="list-style-type: none"> ➤ If the Transmission System Indicator Blinks along with the Warning Message P. 571 Have your vehicle checked by a dealer.
	<ul style="list-style-type: none"> Appears if the transmission is in a position other than N and a malfunction is preventing the system from starting. 	<ul style="list-style-type: none"> Depending on the circumstances, you can set the power system to ON as an emergency measure. <ul style="list-style-type: none"> ➤ If the Transmission System Indicator Blinks along with the Warning Message P. 571 Have your vehicle checked by a dealer.
	<ul style="list-style-type: none"> Appears when you set the power mode to ON again and the vehicle is able to run. 	<ul style="list-style-type: none"> ➤ Turning on the Power P. 378



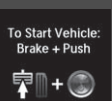

Message	Condition	Explanation
 <p>Washer Fluid Low</p>	<ul style="list-style-type: none"> Appears when the washer fluid is low. 	<ul style="list-style-type: none"> Refill the washer fluid. <ul style="list-style-type: none"> ► Refilling Window Washer Fluid P. 513
 <p>Seat Belt E-Pre-tensioner System Problem</p>	<ul style="list-style-type: none"> Appears if there is a problem with e-pretensioner system. 	<ul style="list-style-type: none"> Have your vehicle checked by a dealer.
 <p>Maintenance Due Soon A12345</p>	<ul style="list-style-type: none"> Appears when the scheduled maintenance is due soon. Consequently, Maintenance Due Now and Maintenance Past Due follow. 	<ul style="list-style-type: none"> ► Maintenance Minder Messages on the Multi-Information Display P. 497
 <p>Stop Driving When Safe. Transmission Temperature Too Hot</p>	<ul style="list-style-type: none"> Appears if the temperature of the transmission is too high and the vehicle cannot drive normally. 	<ul style="list-style-type: none"> It may be difficult to accelerate or start uphill. Immediately stop in a safe place. Until the message goes off, allow the engine to idle so that the transmission can cool down. Immediately after the message goes off, have your vehicle checked by a dealer.
 <p>To Shift From Park, Engine Must Be Running</p>	<ul style="list-style-type: none"> Appears when you attempt to change to another gear position with the transmission in [P] and the power system OFF. 	<ul style="list-style-type: none"> To select another gear position while in [P], the power system must be ON.

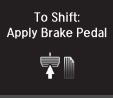

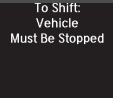

Message	Condition	Explanation
 <p>Transmission System Problem. Reverse Gear Not Available. See Your Dealer.</p>	<ul style="list-style-type: none"> Appears if there is a problem with transmission and it is not possible to select R. 	<ul style="list-style-type: none"> Have your vehicle checked by a dealer.
 <p>Gear Position is N. Release Accelerator Pedal</p>	<ul style="list-style-type: none"> Appears if you depress the accelerator pedal when the transmission is in N. 	<ul style="list-style-type: none"> Release the accelerator pedal. After that, depress the brake pedal and change the transmission position.
 <p>Neutral-Hold Mode On Shift To P When Done</p>	<ul style="list-style-type: none"> Appears when you press and hold the N button for more than two seconds. 	<ul style="list-style-type: none"> Disappears when you set the gear position to other than N. <ul style="list-style-type: none"> ➤ If you want to keep the transmission in N position (car wash mode) P. 389
 <p>To Exit Vehicle In Neutral: Press N Again & Hold For 2sec</p>	<ul style="list-style-type: none"> Appears when you change to N, then release the N button. 	<ul style="list-style-type: none"> ➤ If you want to keep the transmission in N position (car wash mode) P. 389
 <p>Transmission Recalibrating... Power Reduced.</p>	<ul style="list-style-type: none"> All gear positions come on when the transmission is operated. 	<ul style="list-style-type: none"> Acceleration is not possible while the indicator is on. Goes off a few seconds later if there is no problem. After the indicator goes off, you can drive normally.



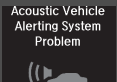

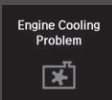
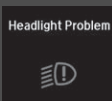
Message	Condition	Explanation
 <p>Charging System Problem</p>	<ul style="list-style-type: none"> Appears when there is a problem with the sensor on the 12-volt battery. 	<ul style="list-style-type: none"> Have your vehicle checked by a dealer. <ul style="list-style-type: none"> ▶ Checking the 12-Volt Battery P. 529
 	<ul style="list-style-type: none"> Appears when the starter system has a problem. 	<ul style="list-style-type: none"> As a temporary measure, press and hold the POWER button for up to 15 seconds while depressing the brake pedal and manually turn on the power system. Have your vehicle checked by a dealer.
 <p>To Switch Vehicle Off: Push Twice</p>	<ul style="list-style-type: none"> Appears after the driver's door is opened when the power mode is in ACCESSORY. 	<ul style="list-style-type: none"> Change the power mode to VEHICLE OFF. <ul style="list-style-type: none"> ▶ POWER Button P. 152
 <p>Accessory Mode</p>	<ul style="list-style-type: none"> Appears when the power mode is in ACCESSORY. 	<p>—</p>

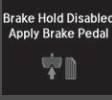
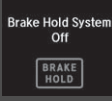

Message	Condition	Explanation
 <p>Keyless Remote Not Detected</p>	<ul style="list-style-type: none"> Appears when you close the door with the power mode in ON without the keyless access remote inside the vehicle. 	<ul style="list-style-type: none"> Disappears when you bring the keyless access remote back inside the vehicle and close the door. <ul style="list-style-type: none"> ➤ Keyless Access Remote Reminder P. 154
 <p>Keyless Remote Battery Low</p>	<ul style="list-style-type: none"> Appears when the keyless access remote battery becomes weak. 	<ul style="list-style-type: none"> Replace the battery as soon as possible. <ul style="list-style-type: none"> ➤ Replacing the Button Battery P. 530
 <p>To Start, Hold Remote Near Start Button</p>	<ul style="list-style-type: none"> Appears if the keyless access remote battery is too weak to turn on the power system or the key is not within operating range to turn on the power system. A beeper sounds six times. 	<ul style="list-style-type: none"> Bring the keyless access remote in front of the POWER button to be touched with. <ul style="list-style-type: none"> ➤ If the Keyless Access Remote Battery is Weak P. 560
 <p>To Switch Accessory On: Push</p>	<ul style="list-style-type: none"> Appears three seconds after you bring the keyless access remote in front of the POWER button when To Start, Hold Remote Near Start Button appears. To Start Vehicle: Brake + Push appears sequentially. 	<ul style="list-style-type: none"> Unless you bring the keyless access remote in front of the POWER button, this message does not appear. <ul style="list-style-type: none"> ➤ If the Keyless Access Remote Battery is Weak P. 560
 <p>To Start Vehicle: Brake + Push</p>	<ul style="list-style-type: none"> Appears when you set the power mode to ACCESSORY or ON. 	<ul style="list-style-type: none"> ➤ Turning on the Power P. 378
 <p>Pressing Button Again 2x Or Holding Will Cause Ignition Off & Power Loss</p>	<ul style="list-style-type: none"> Appears if you press the POWER button while the vehicle is moving. 	<ul style="list-style-type: none"> ➤ Emergency Power System Off P. 561

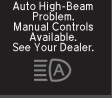

Message	Condition	Explanation
 <p>Fasten Seat Belt</p>	<ul style="list-style-type: none"> • Appears when you set the power mode to ON without fastening the driver's seat belt. • Appears when you change the gear position after [P] has been automatically selected with the driver's door open, the driver's seat belt unfastened, then the brake pedal is released. 	<ul style="list-style-type: none"> • Fasten the seat belt properly before you start to drive. <ul style="list-style-type: none"> ► Shift Operation P. 387
 <p>To Shift: Apply Brake Pedal</p>	<ul style="list-style-type: none"> • Appears when you try to change the gear position without depressing the brake pedal. 	<ul style="list-style-type: none"> • Depress the brake pedal, then select a shift button.
 <p>To Shift: Release Accelerator Pedal</p>	<ul style="list-style-type: none"> • Appears when you try to change the gear position without releasing your foot off the accelerator pedal. 	<ul style="list-style-type: none"> • Release your foot off the accelerator pedal, then select a shift button.
 <p>To Shift: Vehicle Must Be Stopped</p>	<ul style="list-style-type: none"> • Appears when the parking button is pressed while the vehicle is moving. • Appears if you change the gear position to [R] while the vehicle is moving forward, or to [D] while the vehicle is reversing. 	<ul style="list-style-type: none"> • Make sure that the vehicle comes to a stop before operating the select button.

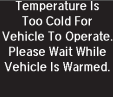
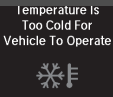

Message	Condition	Explanation
	<ul style="list-style-type: none"> • Appears if there is a problem with the electric system. • Appears when you set the power mode to OFF while driving. 	<ul style="list-style-type: none"> • Immediately stop in a safe place and set the parking brake. • Continue driving if the message goes off soon after. • If there is a problem with the transmission system, the transmission system indicator comes on. ➤ Transmission System Indicator P. 82
	<ul style="list-style-type: none"> • Appears if you press the POWER button within five seconds of putting the transmission into N. 	<ul style="list-style-type: none"> • The transmission remains in N for 15 minutes, then automatically switches to P. ➤ If you want to keep the transmission in N position (car wash mode) P. 389
	<ul style="list-style-type: none"> • Appears if the vehicle is stopped and the driver's seat belt is unfastened, as there is a possibility that the vehicle may roll. 	<ul style="list-style-type: none"> • When the vehicle is idling or when you are parking or exiting the vehicle, put the transmission into P before releasing the brake pedal. ➤ Shift Operation P. 387
	<ul style="list-style-type: none"> • Appears if any door or the trunk is not completely closed. • Appears if any door or the trunk is opened while driving. The beeper sounds. 	<ul style="list-style-type: none"> • Goes off when all doors and the trunk are closed.
	<ul style="list-style-type: none"> • Appears if there is a problem with the acoustic vehicle alerting system. 	<ul style="list-style-type: none"> • Have your vehicle checked by a dealer immediately.

Message	Condition	Explanation
 <p>Engine Cooling Problem</p>	<ul style="list-style-type: none"> Appears if there is a problem with the radiator system. 	<ul style="list-style-type: none"> Drive slowly to prevent overheating and have your vehicle checked by a dealer as soon as possible.
 <p>Headlight Problem</p>	<ul style="list-style-type: none"> Appears when there is a problem with the headlights. 	<ul style="list-style-type: none"> Appears while driving - The low beam headlights may not be on. When conditions allow you to drive safely, have your vehicle checked by a dealer as soon as possible.
<p>Models with parking sensor system</p>  <p>Parking Sensor System Problem</p>	<ul style="list-style-type: none"> Appears if there is a problem with the parking sensor system. 	<ul style="list-style-type: none"> Check if the area around the sensor(s) is covered with mud, ice, snow, etc. If the indicator(s) stays on even after you clean the area, have the system checked by a dealer.
 <p>Brake Hold Disabled Apply Brake Pedal</p>	<ul style="list-style-type: none"> Appears if the automatic brake hold is automatically canceled while it is in operation. 	<ul style="list-style-type: none"> Immediately depress the brake pedal.
 <p>Brake Hold System Off</p>	<ul style="list-style-type: none"> Appears when the automatic brake hold system is turned off. 	<p> Automatic Brake Hold P. 454</p>

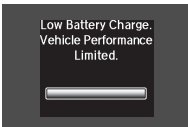

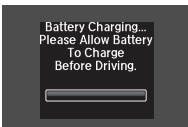

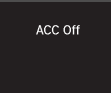
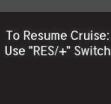
Message	Condition	Explanation
 <p>To Enable Brake Hold: Seat Belt + Push</p>	<ul style="list-style-type: none"> Appears when the automatic brake hold button is pressed without wearing the driver's seat belt. 	<ul style="list-style-type: none"> Fasten the driver's seat belt. <ul style="list-style-type: none"> ➤ Automatic Brake Hold P. 454
 <p>To Disable Brake Hold: Brake + Push</p>	<ul style="list-style-type: none"> Appears when the automatic brake hold button is pressed without depressing the brake pedal while the automatic brake hold is in operation. 	<ul style="list-style-type: none"> Press the automatic brake hold button with the brake pedal depressed. <ul style="list-style-type: none"> ➤ Automatic Brake Hold P. 454
 <p>Parking Brake Engaged</p>	<ul style="list-style-type: none"> Appears when the parking brake is applied automatically while it is in operation. 	<ul style="list-style-type: none"> ➤ Automatic Brake Hold P. 454 ➤ Parking Brake P. 450
 <p>Auto High-Beam Problem. Manual Controls Available. See Your Dealer.</p>	<ul style="list-style-type: none"> Appears if there is a problem with the auto high-beam. 	<ul style="list-style-type: none"> Manually operate the headlight switch. If you are driving with the high-beam headlights when this happens, the headlights are changed to low beams.
 <p>Auto High-Beam Cannot Operate: Clean Windshield</p>	<ul style="list-style-type: none"> Appears when the area around the camera on the windshield is blocked by dirt, mud, etc. 	<ul style="list-style-type: none"> Stop your vehicle in a safe place, and wipe it off with a soft cloth. If the message does not disappear after cleaning the lens, have your vehicle checked by a dealer.

Message	Condition	Explanation
 <p>12 Volt Battery Charging System Problem. Power Reduced.</p>	<ul style="list-style-type: none"> • Appears after the 12-volt battery charging system indicator comes on. 	<ul style="list-style-type: none"> • Your vehicle has less ability to accelerate and may be harder to start on an incline. • Contact a dealer immediately.
 <p>Temperature Is Too Cold For Vehicle To Operate. Please Wait While Vehicle Is Warmed.</p>	<ul style="list-style-type: none"> • Appears when the High Voltage battery temperature is too low to operate (approx. -22°F [-30°C] or below). 	<ul style="list-style-type: none"> • You can start the engine and use the climate control system to warm up the interior, which will also warm the High Voltage battery enough for you to drive the vehicle. • The engine speed does not increase even if you fully depress the accelerator pedal.
 <p>Temperature Is Too Cold For Vehicle To Operate</p>	<ul style="list-style-type: none"> • Appears when the High Voltage battery and other system control temperatures are too low to operate (approx. -40°F [-40°C] or below). 	<ul style="list-style-type: none"> • You must wait for an increase in the ambient temperature or move the vehicle to a warmer location. • Contact a dealer if necessary.
 <p>Extreme Hybrid System Temperature. Vehicle Speed Temporary Limited.</p>	<ul style="list-style-type: none"> • Appears when the rear motor fluid temperature is extremely low. 	<ul style="list-style-type: none"> • The vehicle speed is temporarily limited up to 74 mph (120 km/h). This is canceled after the fluid temperature rises.

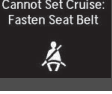
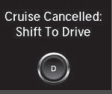
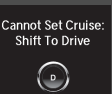



Message	Condition	Explanation
 <p>All Wheel Drive System Problem</p> <p>POWER SYSTEM</p>	<ul style="list-style-type: none"> Appears if the AWD system has a problem due to a hybrid system or power distribution control failure. 	<ul style="list-style-type: none"> Set the power mode to OFF, then set it back to ON. Have your vehicle checked by a dealer if the message appears again.
 <p>Low Battery Charge. Vehicle Performance Limited.</p>	<ul style="list-style-type: none"> Appears when the High Voltage battery is running extremely low due to continuous slow driving. 	<ul style="list-style-type: none"> Driving at low speed for a long time decreases the amount of electricity generated, leading to High Voltage battery drain.
 <p>Battery Output Low. Stop Driving When Safe And Shift To Park.</p>	<ul style="list-style-type: none"> Appears when the High Voltage battery is drained even further and a stop is needed to charge the battery. 	<ul style="list-style-type: none"> Stop in a safe place in P, then charge the High Voltage battery by letting the engine idle. <ul style="list-style-type: none"> ➤ If the 12-Volt Battery Charging System Indicator Comes On P. 567
 <p>Battery Charging... Please Allow Battery To Charge Before Driving.</p>	<ul style="list-style-type: none"> Appears when the High Voltage battery is being charged, after it has lost most of its charge. In this case, the vehicle is parked and the engine is running to supply power to the charging system. 	<ul style="list-style-type: none"> Do not drive the vehicle until READY indicator comes on. Apply the parking brake. <ul style="list-style-type: none"> ➤ READY Indicator P. 80



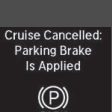
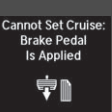
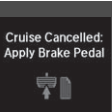

Message	Condition	Explanation
	<ul style="list-style-type: none"> Flashes when the system senses a likely collision with a vehicle in front of you. 	<ul style="list-style-type: none"> Take the appropriate means to prevent a collision (apply the brakes, change lanes, etc.) <ul style="list-style-type: none"> ▣ Collision Mitigation Braking System™ (CMBS™) P. 458 ▣ Adaptive Cruise Control (ACC) with Low Speed Follow P. 402
	<ul style="list-style-type: none"> Appears when ACC with Low Speed Follow has been automatically canceled. 	<ul style="list-style-type: none"> You can resume the set speed after the condition that caused ACC with Low Speed Follow to cancel improves. Press the RES/+SET/- switch up. <ul style="list-style-type: none"> ▣ Adaptive Cruise Control (ACC) with Low Speed Follow P. 402
	<ul style="list-style-type: none"> Appears when the vehicle in front of you starts moving while your vehicle is stopped automatically by ACC with Low Speed Follow. 	<ul style="list-style-type: none"> Either press the RES/+SET/- switch, or depress the accelerator pedal. <ul style="list-style-type: none"> ▣ Adaptive Cruise Control (ACC) with Low Speed Follow P. 402
	<ul style="list-style-type: none"> Appears when the distance between your vehicle and the vehicle ahead of you is too close while ACC with Low Speed Follow is in operation. 	<ul style="list-style-type: none"> ACC with Low Speed Follow has been automatically canceled. <ul style="list-style-type: none"> ▣ Adaptive Cruise Control (ACC) with Low Speed Follow P. 402
	<ul style="list-style-type: none"> Appears when pressing the RES/+SET/- switch down while the distance between your vehicle and the vehicle ahead of you is too close. 	<ul style="list-style-type: none"> ACC with Low Speed Follow cannot be set. <ul style="list-style-type: none"> ▣ Adaptive Cruise Control (ACC) with Low Speed Follow P. 402

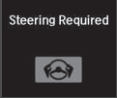

Message	Condition	Explanation
 <p>Cruise Cancelled: Fasten Seatbelt</p>	<ul style="list-style-type: none"> Appears when the driver's seat belt is unfastened while your vehicle is automatically stopped by ACC with Low Speed Follow. 	<ul style="list-style-type: none"> ACC with Low Speed Follow has been automatically canceled. <ul style="list-style-type: none"> ➤ Adaptive Cruise Control (ACC) with Low Speed Follow P. 402
 <p>Cannot Set Cruise: Fasten Seat Belt</p>	<ul style="list-style-type: none"> Appears when pressing the RES/+ / SET/- switch down while the driver's seat belt is unfastened. 	<ul style="list-style-type: none"> ACC with Low Speed Follow cannot be set. <ul style="list-style-type: none"> ➤ Adaptive Cruise Control (ACC) with Low Speed Follow P. 402
 <p>Cruise Cancelled: Shift To Drive</p>	<ul style="list-style-type: none"> Appears when the transmission is put into any position other than D while ACC with Low Speed Follow is in operation. 	<ul style="list-style-type: none"> ACC with Low Speed Follow has been automatically canceled. <ul style="list-style-type: none"> ➤ Adaptive Cruise Control (ACC) with Low Speed Follow P. 402
 <p>Cannot Set Cruise: Shift To Drive</p>	<ul style="list-style-type: none"> Appears when pressing the RES/+ / SET/- switch down while the transmission is not in D. 	<ul style="list-style-type: none"> ACC with Low Speed Follow cannot be set. <ul style="list-style-type: none"> ➤ Adaptive Cruise Control (ACC) with Low Speed Follow P. 402

Message	Condition	Explanation
 	<ul style="list-style-type: none"> Appears when the vehicle is stopped on a very steep slope while ACC with Low Speed Follow is in operation. 	<ul style="list-style-type: none"> ACC with Low Speed Follow has been automatically canceled. <ul style="list-style-type: none"> ► Adaptive Cruise Control (ACC) with Low Speed Follow P. 402
 	<ul style="list-style-type: none"> Appears when pressing the RES/+ / SET/- switch down while the vehicle is stopped on a very steep slope. 	<ul style="list-style-type: none"> ACC with Low Speed Follow cannot be set. <ul style="list-style-type: none"> ► Adaptive Cruise Control (ACC) with Low Speed Follow P. 402
	<ul style="list-style-type: none"> Appears when the vehicle speed slows down to 25 mph (40 km/h) and the vehicle ahead of you goes out of the ACC with Low Speed Follow range while ACC with Low Speed Follow is in operation. 	<ul style="list-style-type: none"> ACC with Low Speed Follow has been automatically canceled. <ul style="list-style-type: none"> ► Adaptive Cruise Control (ACC) with Low Speed Follow P. 402

Message	Condition	Explanation
	<ul style="list-style-type: none"> Appears when pressing the RES/+ / SET/- switch down while the parking brake is applied. 	<ul style="list-style-type: none"> ACC with Low Speed Follow cannot be set. <ul style="list-style-type: none"> ➤ Adaptive Cruise Control (ACC) with Low Speed Follow P. 402 ➤ Parking Brake P. 450
	<ul style="list-style-type: none"> Appears when the parking brake is applied automatically while ACC with Low Speed Follow is in operation. 	<ul style="list-style-type: none"> ACC with Low Speed Follow has been automatically canceled. <ul style="list-style-type: none"> ➤ Adaptive Cruise Control (ACC) with Low Speed Follow P. 402 ➤ Parking Brake P. 450
	<ul style="list-style-type: none"> Appears when pressing the RES/+ / SET/- switch down while the vehicle is moving and the brake pedal is depressed. 	<ul style="list-style-type: none"> ACC with Low Speed Follow cannot be set. <ul style="list-style-type: none"> ➤ Adaptive Cruise Control (ACC) with Low Speed Follow P. 402
	<ul style="list-style-type: none"> Appears if ACC with Low Speed Follow is canceled while your vehicle is automatically stopped by ACC with Low Speed Follow. 	<ul style="list-style-type: none"> Immediately depress the brake pedal.

Message	Condition	Explanation
 	<p>Lane Keeping Assist System (LKAS)</p> <ul style="list-style-type: none"> • Appears when the vehicle is driving out of a detected line. The steering wheel vibrates rapidly. <p>Road Departure Mitigation (RDM) System</p> <ul style="list-style-type: none"> • Appears when the vehicle is driving out of a detected line. <p>When you selected Warning Only</p> <ul style="list-style-type: none"> - The steering wheel vibrates rapidly when the vehicle is drifting out of a detected line. <p>When you selected Narrow, Normal, or Wide</p> <ul style="list-style-type: none"> - The steering wheel vibrates rapidly when the vehicle is drifting out of a detected line. The system also steers the vehicle to help you remain within your driving lane. 	<ul style="list-style-type: none"> • Keep the vehicle within the lane you are driving. <ul style="list-style-type: none"> ► Lane Keeping Assist System (LKAS) P. 421 • Keep the vehicle within the lane you are driving. <ul style="list-style-type: none"> ► Road Departure Mitigation (RDM) System P. 416 • You can change the setting for the road departure mitigation system. Narrow, Normal, Wide, and Warning Only can be selected. <ul style="list-style-type: none"> ► Customized Features P. 295
 	<p>Road Departure Mitigation (RDM) System</p> <p>When you selected Narrow</p> <ul style="list-style-type: none"> • Appears when the vehicle is likely to drive out of a detected line. - The system steers the vehicle to help you remain within your driving lane. 	<p>—</p>

Message	Condition	Explanation
	<ul style="list-style-type: none"> If you are providing little or no steering input, the indicator blinks and a beeper sounds. 	<ul style="list-style-type: none"> Operate the steering wheel to resume the LKAS.
	<ul style="list-style-type: none"> Appears when the LKAS is in operation, or the LKAS button is pressed, but there is a problem with a system related to the LKAS. The LKAS cancels automatically and a beeper sounds. <ul style="list-style-type: none"> ► Traffic jam assist also cancels if it is experiencing a problem. 	<ul style="list-style-type: none"> If any other system indicators come on, such as the VSA®, ABS and brake system, take appropriate action. <ul style="list-style-type: none"> ► Indicators P. 76
 	<ul style="list-style-type: none"> Appears when you unlock and open the driver's door while the power system is on by two-way keyless access remote. 	<p>► Remote Engine Start with Vehicle Feedback P. 380</p>

Message	Condition	Explanation
	<ul style="list-style-type: none"> • Appears if anything covers the radar sensor cover and prevents the sensor from detecting a vehicle in front. • May appear when driving in bad weather (rain, snow, fog, etc.) 	<ul style="list-style-type: none"> • When the radar sensor gets dirty, stop your vehicle in a safe place, and wipe off dirt using a soft cloth. <ul style="list-style-type: none"> ➤ Collision Mitigation Braking System™ (CMBS™) P. 458 ➤ Adaptive Cruise Control (ACC) with Low Speed Follow P. 402 ➤ Road Departure Mitigation (RDM) System P. 416 ➤ Traffic Jam Assist P. 428
	<ul style="list-style-type: none"> • Appears if the temperature inside the camera is too high. 	<ul style="list-style-type: none"> • Use the climate control system to cool down the camera. <ul style="list-style-type: none"> ➤ Front Sensor Camera P. 400 ➤ Collision Mitigation Braking System™ (CMBS™) P. 458 ➤ Adaptive Cruise Control (ACC) with Low Speed Follow P. 402 ➤ Lane Keeping Assist System (LKAS) P. 421 ➤ Road Departure Mitigation (RDM) System P. 416 ➤ Traffic Jam Assist P. 428
	<ul style="list-style-type: none"> • Appears when the area around the camera is blocked by dirt, mud, etc. • May appear when driving in bad weather (rain, snow, fog, etc.) 	<ul style="list-style-type: none"> • Stop your vehicle in a safe place, and wipe it off with a soft cloth. <ul style="list-style-type: none"> ➤ Front Sensor Camera P. 400 ➤ Collision Mitigation Braking System™ (CMBS™) P. 458 ➤ Adaptive Cruise Control (ACC) with Low Speed Follow P. 402 ➤ Lane Keeping Assist System (LKAS) P. 421 ➤ Road Departure Mitigation (RDM) System P. 416 ➤ Traffic Jam Assist P. 428

Gauges

Gauges include the speedometer, tachometer, fuel gauge, High Voltage battery charge level gauge, and related indicators. They are displayed when the power mode is set to ON.

■ Speedometer

Displays your driving speed in mph or km/h.

■ Tachometer

Shows the number of engine revolutions per minute.

■ Fuel Gauge

Displays the amount of fuel left in the fuel tank.

☞ Fuel Gauge

NOTICE

You should refuel when the needle approaches **E**. Running out of fuel can cause the engine to misfire, damaging the catalytic converter.

The actual amount of remaining fuel may differ from the fuel gauge reading.

■ High Voltage Battery Charge Level Gauge

Shows the remaining High Voltage battery charge level.

⌘ High Voltage Battery Charge Level Gauge

The High Voltage battery charge level may decrease under the following conditions:

- When the 12-volt battery has been replaced.
- When the 12-volt battery has been disconnected.
- When the High Voltage battery control system corrects its reading.

The charge level reading will be corrected automatically while driving.

Changes in the temperature of the High Voltage battery can increase or decrease the battery's charging capacity. If temperature changes cause the battery's capacity to change, the number of indicators in the battery charge level gauge may also change, even if the amount of charging remains the same.

Multi-Information Display

The multi-information display displays the odometer, trip meter, outside temperature, and other gauges. It also displays important messages such as warnings and other helpful information.

Switching the Display

■ Main displays

Roll the right selector wheel to change the display.

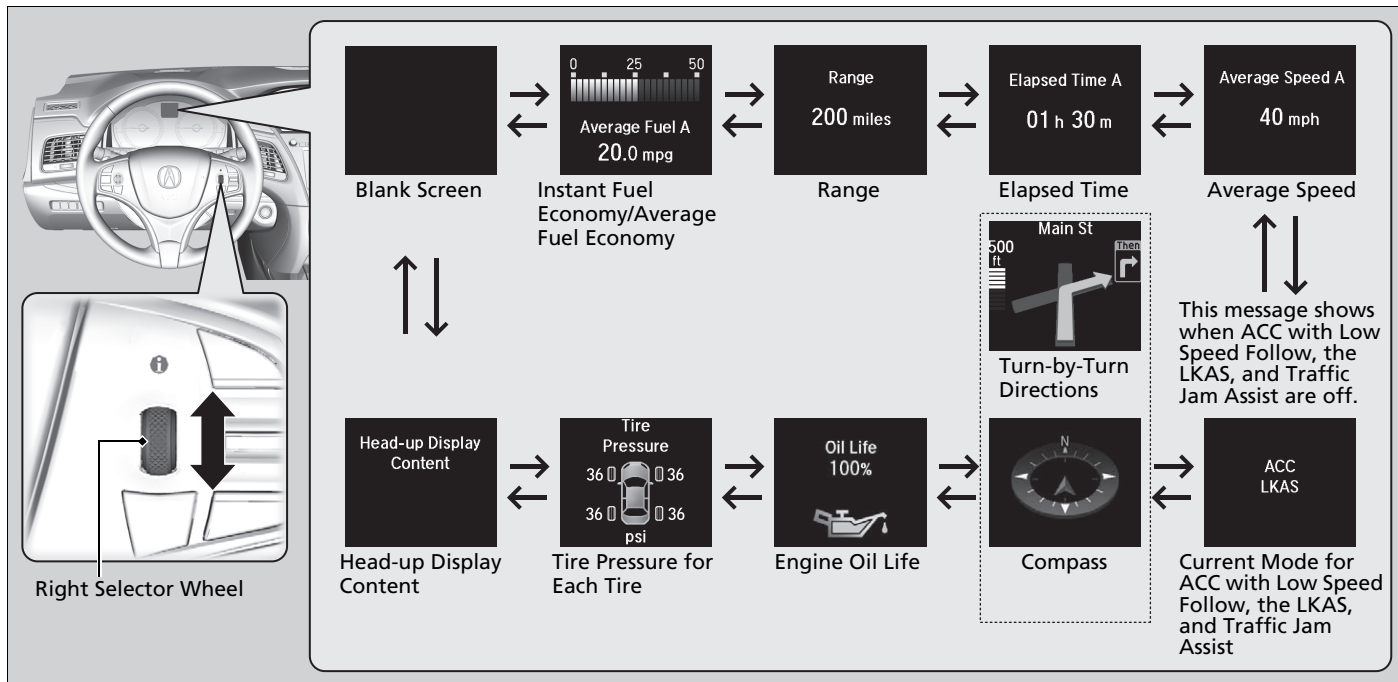

■ Lower displays

Press the **TRIP** button to change the display.

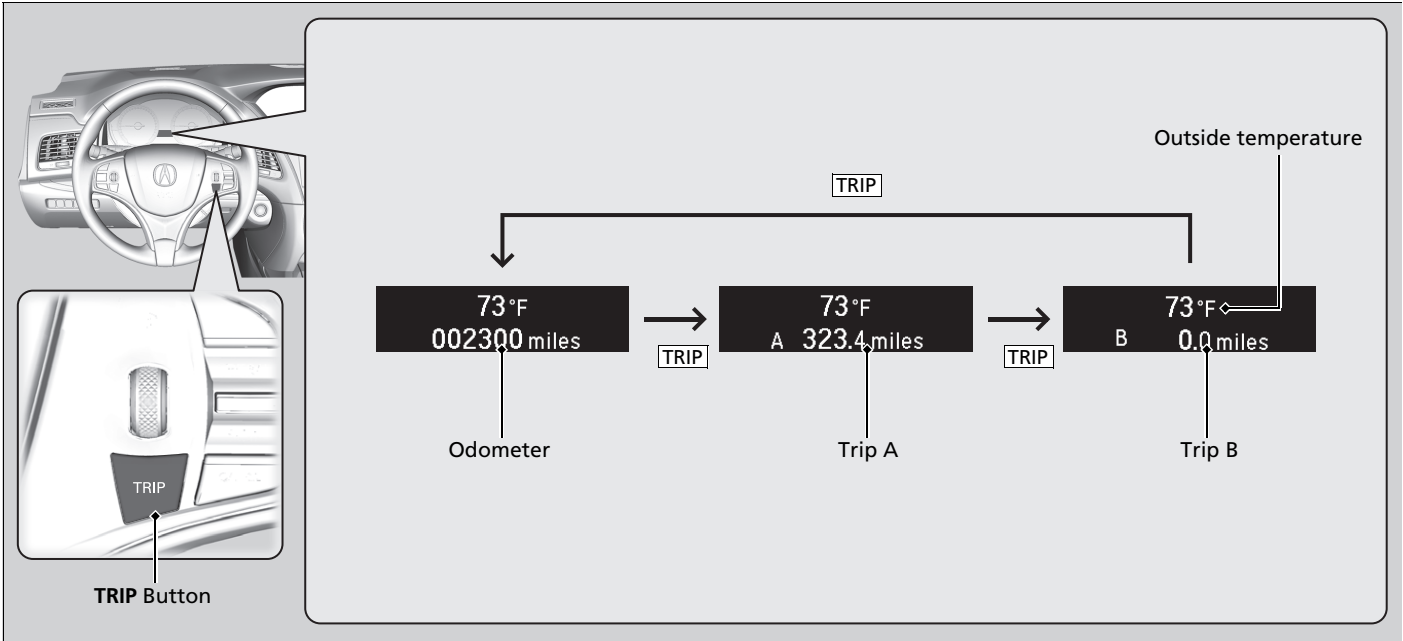

■ Odometer

Shows the total number of miles or kilometers that your vehicle has accumulated.

■ Trip Meter

Shows the total number of miles or kilometers driven since the last reset. Meters A and B can be used to measure two separate trips.

■ Resetting a trip meter

To reset the trip meter, display it, and then press and hold the **TRIP** button. The trip meter is reset to **0.0**.

■ Outside Temperature

Shows the outside temperature in Fahrenheit (U.S.) or Celsius (Canada).

■ Adjusting the outside temperature display

Adjust the temperature reading by up to $\pm 5^{\circ}\text{F}$ (U.S.) or $\pm 3^{\circ}\text{C}$ (Canada) if the temperature reading seems incorrect.

Use the audio/information screen to correct the temperature.

➤ **Customized Features** P. 295

■ Average Fuel Economy

Shows the estimated average fuel economy of each trip meter in mpg (U.S.) or l/100 km (Canada). The display is updated at set intervals. When a trip meter is reset, the average fuel economy is also reset.

➤ Trip Meter

Switch between trip meter A and trip meter B by pressing the **TRIP** button.

➤ Outside Temperature

The temperature sensor is in the front bumper. Road heat and exhaust from another vehicle can affect the temperature reading when your vehicle speed is less than 19 mph (30 km/h).

It may take several minutes for the display to be updated after the temperature reading has stabilized.

➤ Average Fuel Economy

You can change when the average fuel economy is reset.

➤ **Customized Features** P. 295

■ Instant Fuel Economy

Shows the instant fuel economy as a bar graph in mpg (U.S.) or l/100 km (Canada).

■ Range

Shows the estimated distance you can travel on the remaining power and fuel. This estimated distance is based on the vehicle's current fuel economy.

■ Elapsed Time

Shows the time elapsed since Trip A or Trip B was reset.

■ Average Speed

Shows the average speed in mph (U.S.) or km/h (Canada) since Trip A or Trip B was reset.

■ Current Mode for ACC with Low Speed Follow, the LKAS, and Traffic Jam Assist

Shows the current mode for ACC with Low Speed Follow, LKAS, and traffic jam assist.

- To Switch ACC with Low Speed Follow to Cruise Control P. 414
- Lane Keeping Assist System (LKAS) P. 421
- Traffic Jam Assist P. 428

⌘ Elapsed Time

You can change when the elapsed time is reset.
➤ **Customized Features** P. 295

⌘ Average Speed

You can change when the average speed is reset.
➤ **Customized Features** P. 295

■ Turn-by-Turn Directions

The navigation system shows you turn-by-turn directions to your destination.

When the navigation system is not providing driving guidance, an image of a compass appears in the multi-information display.

➤ **Refer to the Navigation System Manual**

■ Engine Oil Life

Shows the remaining oil life and Maintenance Minder™.

➤ **Maintenance Minder™** P. 495

■ Tire Pressure Monitor

Shows the tire pressure of each tire.

➤ **Tire Pressure Monitoring System (TPMS)** P. 445

■ Head-Up Display Content

Shows the display for changing the head-up display content.

➤ **To Change Head-Up Display Content** P. 121

☒ Turn-by-Turn Directions

You can select whether to have the turn-by-turn display come on during the route guidance.

➤ **Customized Features** P. 295

Head-Up Display

Shows the power distribution monitor, current mode for ACC with Low Speed Follow, LKAS, and traffic jam assist, tachometer, gear position indicator, or turn-by-turn directions along with the vehicle speed. You can choose which item to be displayed using the multi-information display. They are displayed when the power mode is in ON.

To turn the head-up display on and off: Press the **HUD** button.

The display can be moved up and down to come level with your eyes.

To raise or lower the head-up display: Press and hold the ▲ or ▼ button until the desired position is reached.

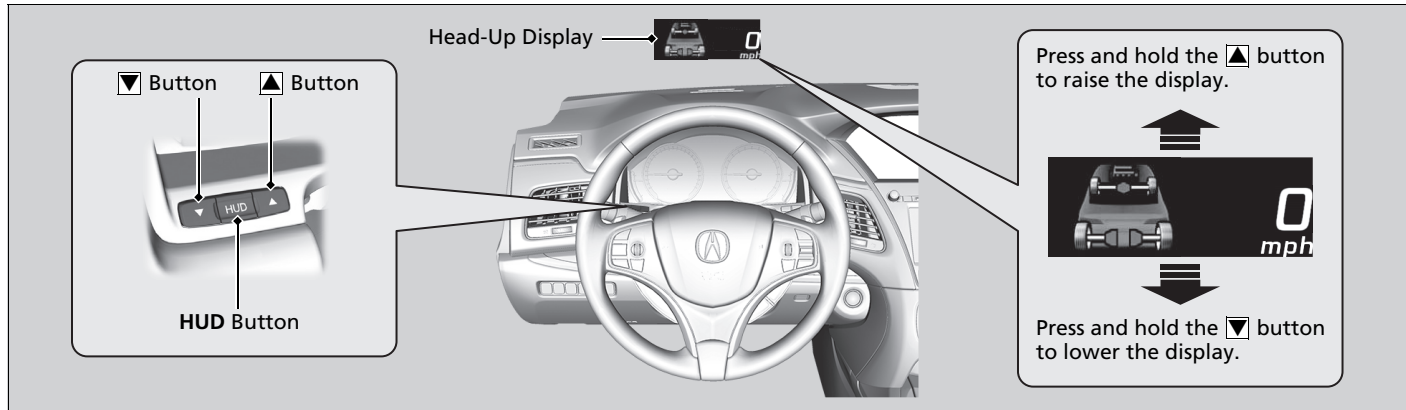

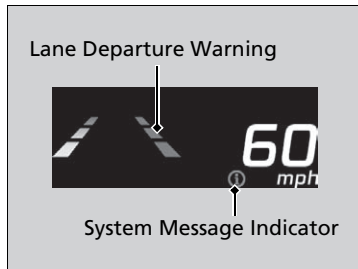

The display also shows the following warnings.

- **System Message Indicator:** Appears when a problem is detected. A system message on the multi-information display appears at the same time.
 - ▶ **Multi-Information Display Warning and Information Messages** P. 94
- **Lane Departure Warning:** When your vehicle is too close to the traffic lane lines, the lane departure warning appears.
 - ▶ **Lane Keeping Assist System (LKAS)** P. 421
- **Head-up Warning Lights:** Flash when the **BRAKE** message appears on the multi-information display.
 - ▶ **Collision Mitigation Braking System™ (CMBS™)** P. 458Come on when the **BRAKE** message appears on the multi-information display.
 - ▶ **Adaptive Cruise Control (ACC) with Low Speed Follow** P. 402

■ To Change Head-Up Display Content

To change the item that comes on along with the vehicle speed on the head-up display, do the following:

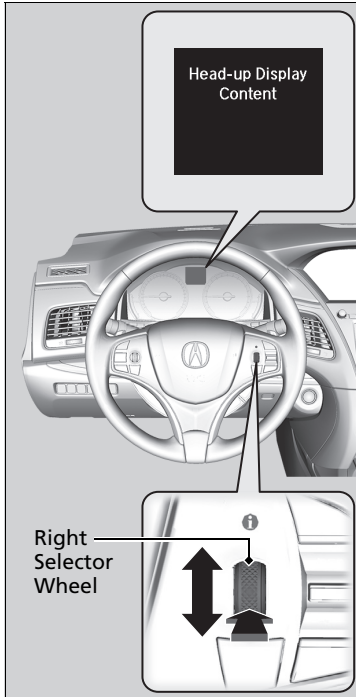

1. Roll the right selector wheel to select **Head-up Display Content** on the multi-information display, then push the right selector wheel.

➤ **Switching the Display** P. 114

☒ To Change Head-Up Display Content

Accessing the **Head-up Display Content** menu on the multi-information display turns on the head-up display.

When pushing the right selector wheel on any display on the multi-information display, you can also access the **Head-up Display Content** menu.

2. Roll the right selector wheel to select the vehicle information you want to display, then push the right selector wheel.
 - ▶ The head-up display and multi-information display show the same content.

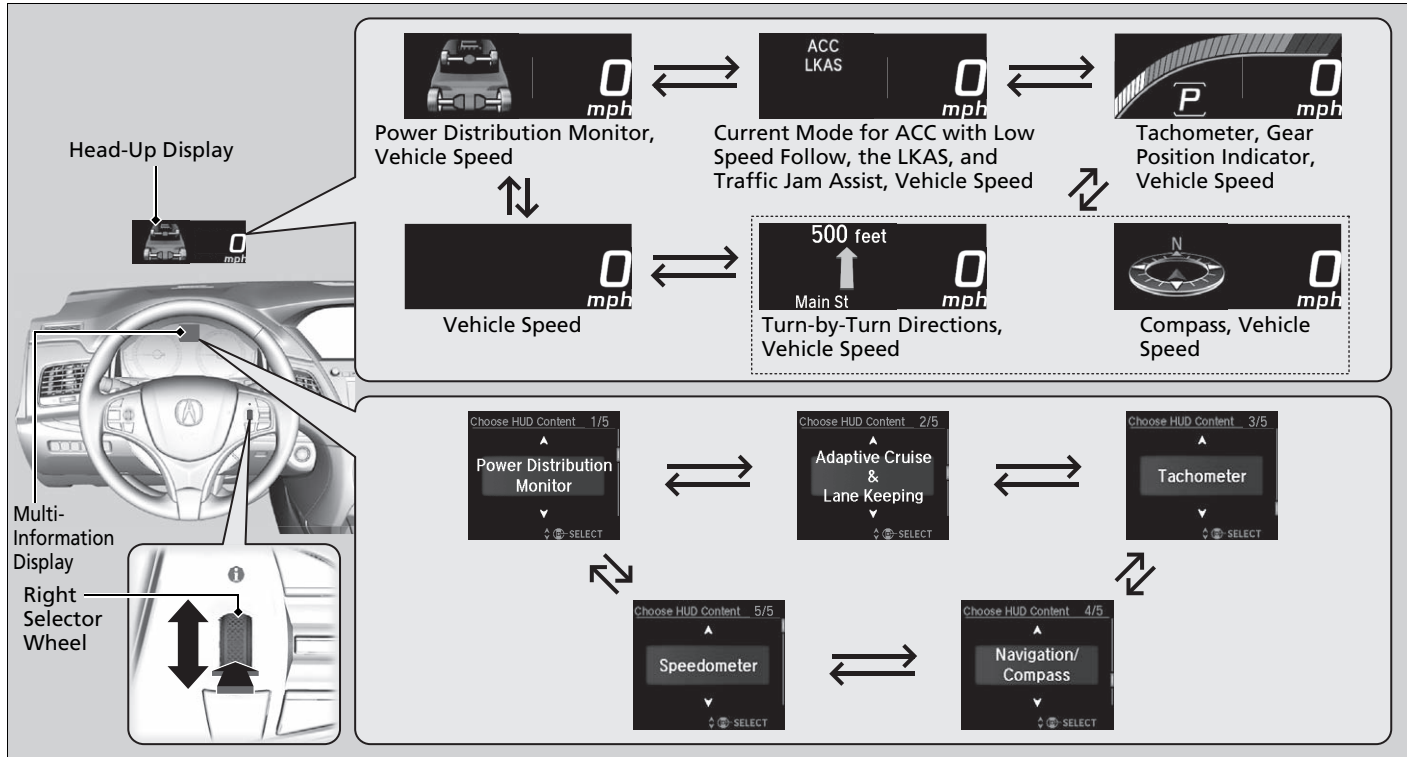

■ Vehicle Speed

Shows your driving speed in mph or km/h.

■ Tachometer

Shows the number of engine revolutions as a bar graph.

■ Gear Position Indicator

Shows the current gear selection.

➤ **Gear Position Indicator** P. 81

■ Current Mode for ACC with Low Speed Follow, the LKAS, and Traffic Jam Assist

Shows the current mode for ACC with Low Speed Follow, LKAS, and traffic jam assist.

➤ **To Switch ACC with Low Speed Follow to Cruise Control** P. 414

➤ **Lane Keeping Assist System (LKAS)** P. 421

➤ **Traffic Jam Assist** P. 428

■ Turn-by-Turn Directions

The navigation system shows you turn-by-turn directions to your destination.

When the navigation system is not providing driving guidance, an image of a compass appears in the head-up display.

➤ **Refer to the Navigation System Manual**

☒ Vehicle Speed

Switch between mph and km/h by using the customized features on the audio/information screen.

➤ **Customized Features** P. 295

☒ Turn-by-Turn Directions

You can select whether to have the turn-by-turn display come on during the route guidance.



➤ **Customized Features** P. 295

■ Power Distribution Monitor

Consists of two monitoring displays, one that indicates the vehicle's power flow, and the other, the torque distribution.

■ Power flow monitor

Shows motor and engine power flow, indicating what supplies power to the vehicle, or if the battery is being charged.

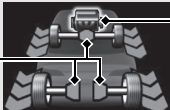
	Head-up display	Color of indicators
Power is supplied by the motors and the engine.		Blue
Power is only supplied by the motors.		Blue
Power is only supplied by the engine.		Blue
The motors charge the High Voltage battery.		Green

▶▶ Power Distribution Monitor

The power distribution monitor can be also displayed on the audio/information display.

▶▶ **Audio/Information Screen P. 225**

While the vehicle is stationary with the engine running, the following may appear on the display.



■ **SPORT HYBRID SH-AWD® torque distribution monitor**

The indicators on the display show the amount of torque being transferred to each wheel or regenerative energy being supplied to the High Voltage battery.

■ **SPORT HYBRID Super Handling-All Wheel Drive™ (SPORT HYBRID SH-AWD®)**

P. 442

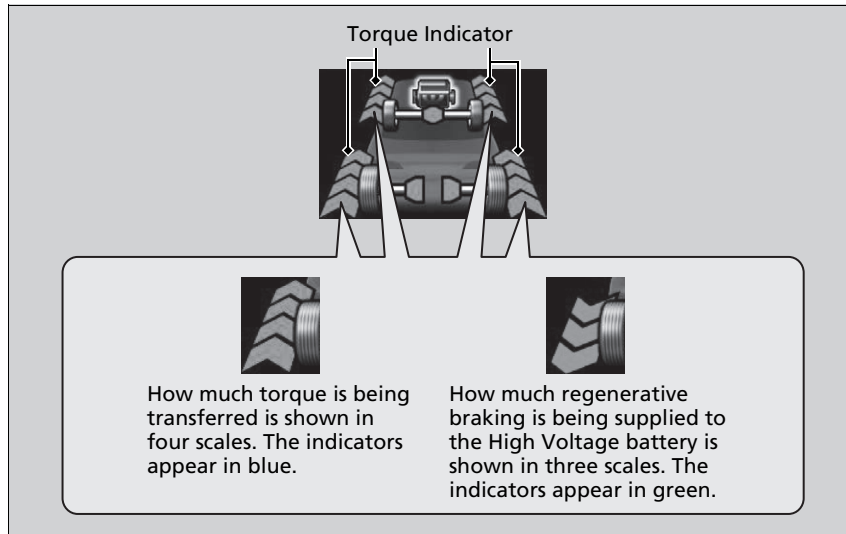

Controls

This chapter explains how to operate the various controls necessary for driving.



Clock	128
Locking and Unlocking the Doors	
Key Type and Functions	129
Low Keyless Access Remote Signal Strength	130
Locking/Unlocking the Doors from the Outside	131
Locking/Unlocking the Doors from the Inside	139
Childproof Door Locks	141
Auto Door Locking/Unlocking	142
Opening and Closing the Trunk	143
Security System	
Immobilizer System	146
Security System Alarm.....	146

Opening and Closing the Windows	149
Moonroof	151
Operating the Switches Around the Steering Wheel	
POWER Button.....	152
Turn Signals	155
Light Switches.....	156
Fog Lights*	159
Daytime Running Lights	159
Auto High-Beam	160
Wipers and Washers	163
Brightness Control	166
Rear Defogger/Heated Door Mirror/Heated Windshield Button	168

Driving Position Memory System	169
Adjusting the Steering Wheel	171
Adjusting the Mirrors	
Interior Rearview Mirror	172
Power Door Mirrors	173
Adjusting the Seats	
Front Seats	175
Interior Lights/Interior Convenience Items	
Interior Lights	182
Interior Convenience Items	184
Climate Control System	
Using Automatic Climate Control	200
Automatic Climate Control Sensors.....	209

* Not available on all models

Adjusting the Clock









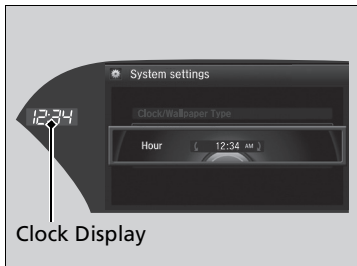

The clock is automatically updated through the navigation system, so the time does not need to be adjusted.

You can also adjust the time manually in the audio/information screen, with the power mode in ON.

Adjusting the Time

Using the Settings menu on the audio/information screen



1. Press the **SETTINGS** button.
2. Rotate  to select **System Settings**, then press .
3. Move  or  to select the **Clock** tab.
4. Rotate  to select **Clock Adjustment**, then press .
5. Rotate  to change hour, then press .
6. Rotate  to change minute, then press .

Adjusting the Clock

These indications are used to show how to operate the interface dial.

Rotate  to select.

Press  to enter.

You can customize the clock display to show the 12 hour clock or 24 hour clock.

 **Customized Features** P. 295

Key Type and Functions

This vehicle comes with the following keys:



Use the keys to turn on and off the power system, to lock and unlock the doors and to open the trunk. You can also use the keyless access system to lock and unlock the doors and trunk.

Built-in Key

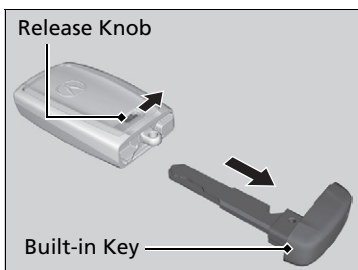

The built-in key can be used to lock/unlock the doors when the keyless access remote battery becomes weak and the power door lock/unlock operation is disabled.

To remove the built-in key, slide the release knob and then pull out the key. To reinstall the built-in key, push the built-in key into the keyless access remote until it clicks.

Key Type and Functions

All the keys have an immobilizer system. The immobilizer system helps to protect against vehicle theft.

➤ **Immobilizer System** P. 146

Follow the advice below to prevent damage to the keys:

- Do not leave the keys in direct sunlight, or in locations with high temperature or high humidity.
- Do not drop the keys or set heavy objects on them.
- Keep the keys away from liquids, dust or sand.
- Do not take the keys apart except for replacing the battery.

If the circuits in the keys are damaged, the power system may not activate, and the remote transmitter may not work.

If the keys do not work properly, have them inspected by a dealer.

You can remotely turn the power system on using the remote engine start.

➤ **Remote Engine Start with Vehicle Feedback** P. 380

■ Key Number Tag

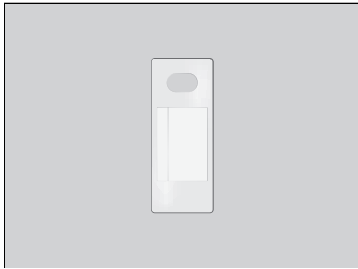

Contains a number that you will need if you purchase a replacement key.

Low Keyless Access Remote Signal Strength

The vehicle transmits radio waves to locate the keyless access remote when locking/unlocking the doors, opening the trunk, or to activate the power system.

In the following cases, locking/unlocking the doors, opening the trunk, or activating the power system may be inhibited or operation may be unstable:

- Strong radio waves are being transmitted by nearby equipment.
- You are carrying the keyless access remote together with telecommunications equipment, laptop computers, cell phones, or wireless devices.
- A metallic object is touching or covering the keyless access remote.

☒ Key Number Tag

Keep the key number tag separate from the key in a safe place outside of your vehicle. If you wish to purchase an additional key, contact a dealer.

If you lose your key and you cannot activate the power system, contact a dealer.

☒ Low Keyless Access Remote Signal Strength

Communication between the keyless access remote and the vehicle consumes the keyless access remote's battery.

Battery life is about two years, but this varies depending on regularity of use.

The battery is consumed whenever the keyless access remote is receiving strong radio waves. Avoid placing it near electrical appliances such as televisions and personal computers.

Locking/Unlocking the Doors from the Outside

■ Using the Keyless Access System

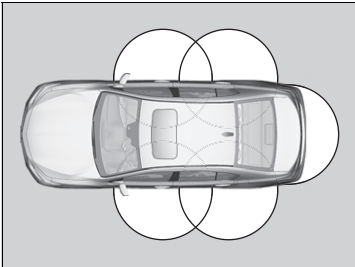

When you carry the keyless access remote, you can lock/unlock the doors and open the trunk.

You can lock/unlock the doors within a radius of about 32 inches (80 cm) of the outside door handle. You can open the trunk within about 32 inches (80 cm) radius from the trunk release button.

☒ Locking/Unlocking the Doors from the Outside

If the interior light switch is in the door activated position, the interior lights come on when you unlock the doors.

No doors opened: The lights fade out after 30 seconds.

Doors relocked: The lights go off immediately.

☒ **Interior Lights** P. 182

■ Locking the doors and trunk

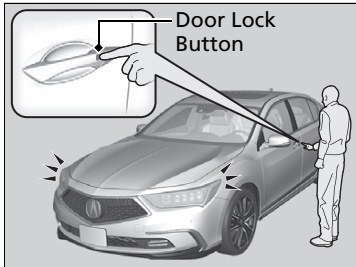

Press the door lock button on the front or rear door.

- ▶ Some exterior lights flash; the beeper sounds; all the doors and trunk lock; and the security system sets.

☒ Using the Keyless Access System

You can lock or unlock doors using the keyless access system only when the power mode is in VEHICLE OFF.

- Do not leave the keyless access remote in the vehicle when you get out. Carry it with you.
- Even if you are not carrying the keyless access remote, you can lock/unlock the doors while someone else with the remote is within range.
- The door may be unlocked if the door handle is covered with water in heavy rain or in a car wash if the keyless access remote is within range.
- If you grip a front or rear door handle wearing gloves, the door sensor may be slow to respond or may not respond by unlocking the doors.
- After locking the door, you have up to two seconds during which you can pull the door handle to confirm whether the door is locked. If you need to unlock the door immediately after locking it, wait at least two seconds before gripping the handle, otherwise the door will not unlock.
- The door might not open if you pull it immediately after gripping the door handle. Grip the handle again and confirm that the door is unlocked before pulling the handle.
- Even within the 32 inches (80 cm) radius, you may not be able to lock/unlock the doors with the keyless access remote if it is above or below the outside handle.
- The keyless access remote may not operate if it is too close to the door and door glass.

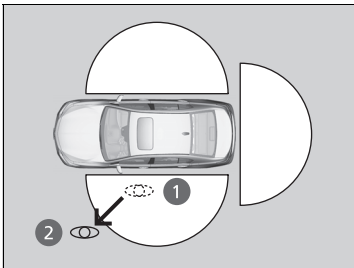
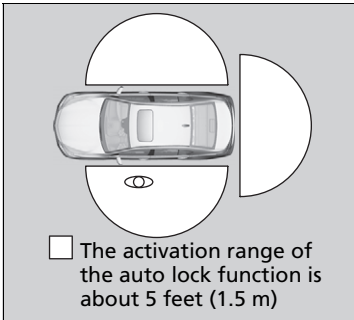

■ Locking the doors and trunk (Walk away auto lock®)

When you walk away from the vehicle while carrying the keyless access remote, the doors will automatically lock.

The auto lock function activates when all doors are closed, and the keyless access remote is within about 5 feet (1.5 m) radius of the outside door handle.

Exit vehicle while carrying keyless access remote and close door(s).

1. While within about 5 feet (1.5 m) radius of the vehicle.
 - ▶ The beeper sounds; the auto lock function will be activated.
2. Carry the keyless access remote beyond about 5 feet (1.5 m) from the vehicle and remain outside this range for 2 or more seconds.
 - ▶ Some exterior lights flash; the beeper sounds; all doors will then lock.

▣ Locking the doors and trunk (Walk away auto lock®)

The auto lock function is set to OFF as the factory default setting. The auto lock function can be set to ON using the audio/information screen.

If you set the auto lock function to ON using the audio/information screen, only the remote transmitter that was used to unlock the driver's door prior to the setting change can activate auto lock.

▶ **Customized Features** P. 295

After the auto lock function has been activated, when you stay within the locking/unlocking operation range, the indicator on the keyless access remote will continue to flash until the doors are locked.

When you stay beside the vehicle within the operation range, the doors will automatically lock approximately 30 seconds after the auto lock function activating beeper sounds.

When you open a door after the auto lock function activating beeper sounds, the auto lock function will be delayed until all doors are closed.

When all doors have been closed and the keyless access remote is inside the vehicle, or if the keyless access remote is not detected within about 5 feet (1.5 m) of the vehicle, auto lock function will not be activated.

To temporarily deactivate the function:

1. Set the power mode to OFF.
2. Open the driver's door.
3. Using the master door lock switch, operate the lock as follows:
Lock → Unlock → Lock → Unlock.
▶ The beeper sounds and the function is deactivated.

To restore the function:

- Set the power mode to ON.
- Lock the vehicle without using the auto lock function.
- With the keyless remote on you, move out of the auto lock function operation range.
- Open any door.

🔒 Locking the doors and trunk (Walk away auto lock®)

The auto lock function does not operate when any of the following conditions are met.

- The keyless access remote is inside the vehicle.
- A door or the hood is not closed.
- The power mode is set to any mode other than OFF.
- The keyless access remote is not located within a radius of about 5 feet (1.5 m) from the vehicle when you get out of the vehicle and close the doors.

Auto lock function operation stop beeper

After the auto lock function has been activated, the auto lock operation stop beeper sounds for approximately two seconds in the following cases.

- The keyless access remote is put inside the vehicle through a window.
- You are located too close to the vehicle.
- The keyless access remote is put inside the trunk.

If the warning beeper sounds, check that you are carrying the keyless access remote. Then, open/close a door and confirm the auto lock activation beeper sounds once.

In the case that the keyless remote is out of operating range when you close a door or the trunk, a beeper will sound to indicate that the auto lock function has been canceled.

■ Unlocking the doors and trunk

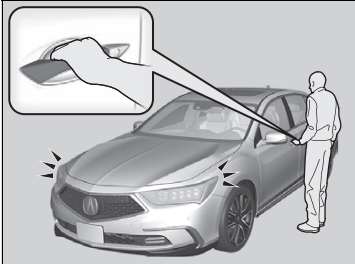

Grab the driver's door handle:

- ▶ The driver's door unlocks.
- ▶ Some exterior lights flash twice and the beeper sounds twice.

Grab the front passenger's or rear door handle:

- ▶ All the doors unlock.
- ▶ Some exterior lights flash twice and the beeper sounds twice.

Press the trunk release button:

- ▶ The trunk unlocks and opens.
- ▶ A beeper will sound.

➤ **Using the Trunk Release Button** P. 144

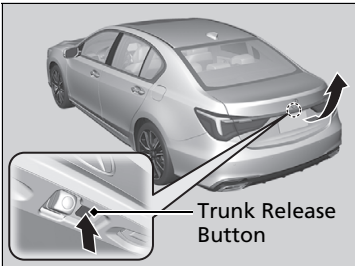

☒ Using the Keyless Access System

If you do not open a door within 30 seconds of unlocking the vehicle with the keyless access system, the doors will automatically relock.

When you go into the keyless access system working range with all the doors locked, the front and rear door outer handle ambient lights come on for 30 seconds.

The lights do not come on if you have previously stayed within the range for more than five minutes, or the doors have been locked for a few days. The feature activates again after you drive the vehicle, then lock the doors.

The light flash, beep and unlock settings can be customized using the audio/information screen.

➤ **Customized Features** P. 295

■ Using the Remote Transmitter

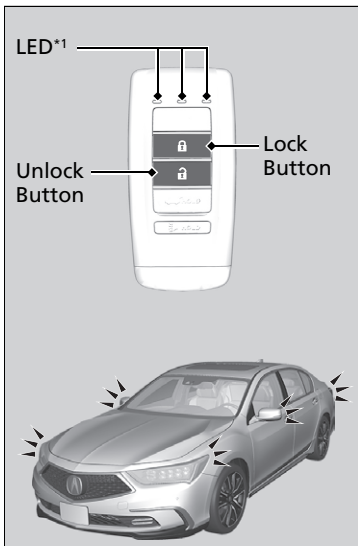

*1: Checking Door Lock Status P. 138

■ Locking the doors

Press the lock button.

Once:

- ▶ Some exterior lights flash, all the doors lock, and the security system sets.

Twice (within five seconds after the first push):

- ▶ The beeper sounds and verifies the security system is set.

■ Unlocking the doors

Press the unlock button.

Once:

- ▶ Some exterior lights flash twice, and the driver's door unlocks.

Twice:

- ▶ The remaining doors unlock.

▣ Using the Remote Transmitter

If you do not open a door within 30 seconds of unlocking the vehicle with the remote transmitter, the doors will automatically relock. You can change the relock timer setting.

▣ **Customized Features** P. 295

You can lock or unlock doors using the remote transmitter only when the power mode is in VEHICLE OFF.

The remote transmitter uses low-power signals, so the operating range may vary depending on the surroundings.

The remote will not lock the vehicle when a door is open.

If the distance at which the remote transmitter works varies, the battery is probably low. If the LED does not come on when you press a button, the battery is dead.

▣ **Replacing the Button Battery** P. 530

You can customize the door unlock mode setting.

▣ **Customized Features** P. 295

■ Locking/Unlocking the Doors Using a Key

If the lock or unlock button of the remote does not work, use the key instead. Fully insert the key and turn it.

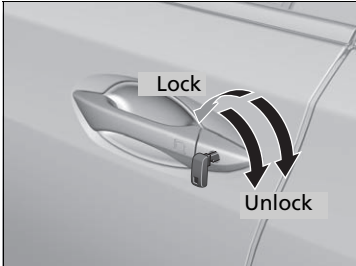

■ Locking a Door Without Using a Key

If you do not have the key on you, or if for some reason you cannot lock a door using the key, you can lock the door without it.

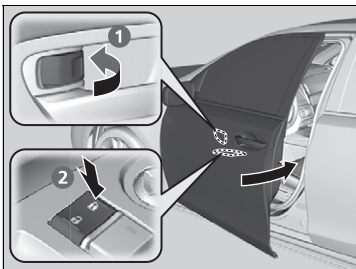

■ Locking the front doors

Push the lock tab forward **1** or push the master door lock switch in the lock direction **2**, and close the door.

■ Locking the rear doors

Push the lock tab forward and close the door.

■ Lockout prevention system

The doors cannot be locked when the keyless access remote is inside the vehicle.

⊗ Locking/Unlocking the Doors Using a Key

When you lock the driver's door with a key, all the other doors lock at the same time. When unlocking, the driver's door unlocks first. Turn the key a second time within a few seconds to unlock the remaining doors.

If you unlock the doors with the key, the alarm activates when you open the hood before the power mode is set to ON.

You can customize the door unlock mode setting.

➤ **Customized Features** P. 295

⊗ Locking a Door Without Using a Key

When you lock the driver's door, all the other doors lock at the same time.

When you lock the front passenger's door with the master door lock switch, all the other doors lock at the same time.

Before locking a door, make sure that the key is not inside the vehicle.

■ Checking Door Lock Status

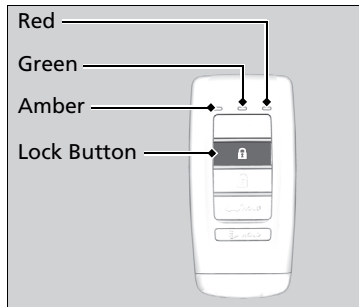

You can remotely check if your vehicle's doors are all locked or any are unlocked using the keyless access remote from extended distances.

Press the lock button, the Amber (LEFT) LED blinks once. Then after three seconds one of the following feedback will come:

- Green (center) comes on: Acknowledges that the doors are locked.
- Red (right) comes on: Acknowledges that doors are not locked, or any door is not completely closed.
- Red (right) blinks three times: The remote does not receive the door lock status from the vehicle.

▣ Checking Door Lock Status

Operate the remote in an open space. If there are buildings or other obstacles between your vehicle and the remote, the remote may not work even within the operable range. However, the range of unlock, all doors, and panic functions are the same as the standard keyless access remote.

▣ **Using the Remote Transmitter** P. 136

When checking the door lock status, you can also turn the power system on or off.

▣ **Remote Engine Start with Vehicle Feedback** P. 380

Locking/Unlocking the Doors from the Inside

■ Using the Lock Tab

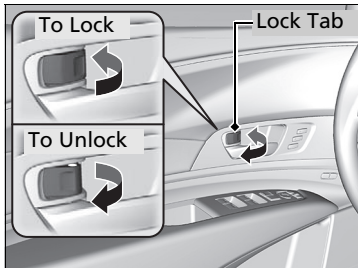

■ Locking a door

Push the lock tab forward.

■ Unlocking a door

Pull the lock tab rearward.

☒ Using the Lock Tab

When you lock the door using the lock tab on the driver's door, all the other doors lock at the same time.

When you unlock the door using the lock tab on the driver's door, only the driver's door will unlock.

■ Unlocking Using the Front Door Inner Handle

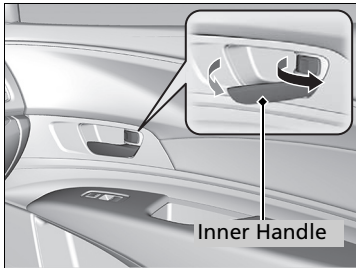

Pull the front door inner handle.

- ▶ The door unlocks and opens in one motion.

Unlocking and opening the driver's door from the inner handle unlocks all the other doors.

To avoid all the doors to be unlocked, use the lock tab on the driver's door to unlock, then lock again before opening the door.

- ▶ This setting works for one time only. If you do not want all the doors to be unlocked all the time, customize the **Auto Door Unlock** setting to **Off** using the audio/information screen.

▣ Unlocking Using the Front Door Inner Handle

The front door inner handles are designed to allow front seat occupants to open the door in one motion. However, this feature requires that front seat occupants never pull a front door inner handle while the vehicle is in motion.

Children should always ride in a rear seat where childproof door locks are provided.

▣ **Childproof Door Locks** P. 141

■ Using the Master Door Lock Switch

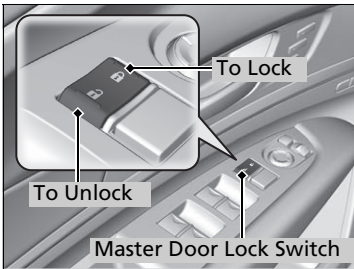

Press the master door lock switch in as shown to lock or unlock all doors.

☒ Using the Master Door Lock Switch

When you lock/unlock either front door using the master door lock switch, all the other doors lock/unlock at the same time.

Childproof Door Locks

The childproof door locks prevent the rear doors from being opened from the inside regardless of the position of the lock tab.

☒ Childproof Door Locks

To open the door from the inside when the childproof door lock is on, put the lock tab in the unlock position, lower the rear window, put your hand out of the window, and pull the outside door handle.

■ Setting the Childproof Door Locks

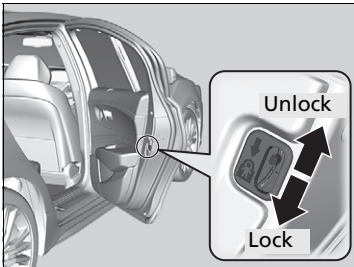

Slide the lever in the rear door to the lock position, and close the door.

■ When opening the door

Open the door using the outside door handle.

Auto Door Locking/Unlocking

Your vehicle locks and unlocks all doors automatically when a certain condition is met.

■ Auto Door Locking

■ Drive lock mode

All doors lock when the vehicle's speed reaches about 10 mph (15 km/h).

■ Auto Door Unlocking

■ Driver's door open mode

All doors unlock when the driver's door is opened.

☒ Auto Door Locking/Unlocking

You can turn off or change to another auto door locking/unlocking setting using the audio/information screen.

☒ **Customized Features** P. 295

Precautions for Opening/Closing the Trunk

■ Opening the trunk

Open the trunk all the way.

- ▶ If it is not fully opened, the trunk lid may begin to close under its own weight.

■ Closing the trunk

Keep the trunk lid closed while driving to:

- ▶ Avoid possible damage.
- ▶ Prevent exhaust gas from leaking into the vehicle.
 - **Exhaust Gas Hazard** P. 72

Using the Trunk Opener

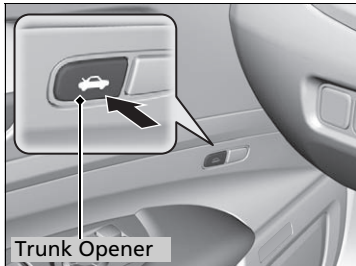

Pressing the trunk opener on the driver's door unlocks and opens the trunk.

- **When You Cannot Open the Trunk** P. 582

Using the Trunk Release Button

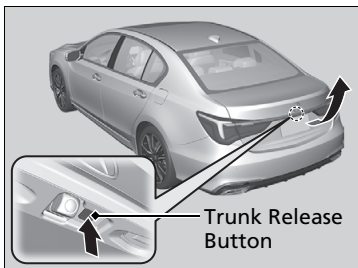

Push up the release button on the trunk lid after the doors are unlocked.

➤ **When You Cannot Open the Trunk** P. 582

Even if the trunk is locked, you can open the trunk if you carry the keyless access remote.

▶ The beeper sounds.

Using the Trunk Release Button

- A person who is not carrying the keyless access remote can unlock the trunk if a person who is carrying it is within range.
- If you forget the remote inside, the beeper will sound and the trunk will not close.
- If the beeper sounds after you close the trunk, move the keyless access remote away from the trunk and close again.
- The keyless access remote may not operate if it is too close to the trunk.

Using the Remote Transmitter

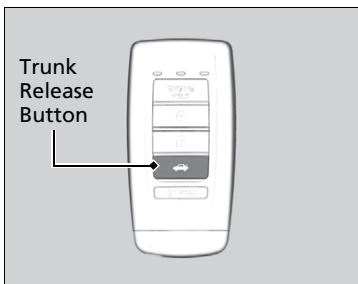

Press the trunk release button for approximately one second to unlock and open the trunk.

Emergency Trunk Opener

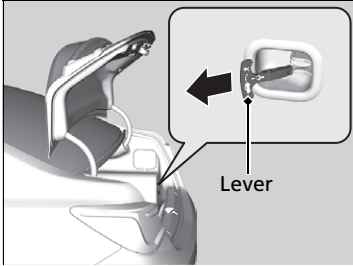

The trunk release lever allows you to open the trunk from inside for your safety.

Pull the release lever in the direction of the arrow.

Emergency Trunk Opener

Parents should decide if their children should be shown how to use this feature.

Immobilizer System

The immobilizer system prevents a key that has not been pre-registered from starting the power system. Each key contains electronic transmitters that use electronic signals to verify the key.

Pay attention to the following when pressing the **POWER** button:

- Do not allow objects that emit strong radio waves near the **POWER** button.
- Make sure the key is not covered by or touching a metal object.
- Do not bring a key from another vehicle's immobilizer system near the **POWER** button.
- Do not put the key near magnetic items. Electronic devices, such as televisions and audio systems emit strong magnetic fields. Note that even a key chain can become magnetic.

Security System Alarm

The security system alarm activates when the trunk, hood or doors are forcibly opened. The alarm does not activate if the trunk or doors are opened with the key, remote transmitter or keyless access system.

However, the alarm activates if a door is opened with the key, then the hood is opened before the power mode is set to ON.

■ When the security system alarm activates

The horn sounds intermittently, and some exterior lights flash.

■ To deactivate the security system alarm

Unlock the vehicle using the key, remote transmitter or keyless access system, or the power mode is set to ON. The system, along with the horn and flashing lights, is deactivated.

☒ Immobilizer System

NOTICE

Leaving the key in the vehicle can result in theft or accidental movement of the vehicle. Always take the key with you whenever you leave the vehicle unattended.

Do not alter the system or add other devices to it. Doing so may damage the system and make your vehicle inoperable.

☒ Security System Alarm

The security system alarm continues for a maximum of two minutes until the security system alarm deactivates.

■ Setting the security system alarm

The security system alarm automatically sets when the following conditions have been met:

- The power mode is set to VEHICLE OFF.
- The hood and trunk are closed.
- All doors are locked from outside with the key, remote transmitter or keyless access system.

■ When the security system alarm sets

The security system alarm indicator in the instrument panel blinks and the blinking interval changes after about 15 seconds.

■ To cancel the security system alarm

The security system is canceled when the vehicle is unlocked using the key, remote transmitter or keyless access system, or when the power mode is set to ON. The security system alarm indicator goes off at the same time.

▣ Security System Alarm

Do not set the security system alarm when someone is in the vehicle or a window is open. The system can accidentally activate when:

- Unlocking the door with the lock tab.
- Opening the trunk with the trunk opener on the driver's door or the emergency trunk opener.
- Opening the hood with the hood release.

If the 12-volt battery goes dead after you have set the security system alarm, the security alarm may activate once the 12-volt battery is recharged or replaced. If this occurs, deactivate the security system alarm by unlocking a door using the remote transmitter or keyless access system.

Do not alter the system or add other devices to it. Doing so may damage the system and make your vehicle inoperable.

■ Panic Mode

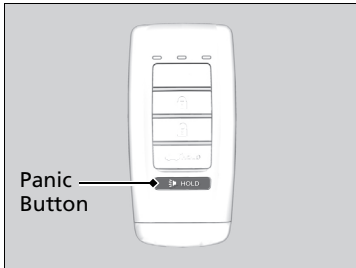

■ The panic button on the remote transmitter

If you press the panic button for approximately one second, the following will occur for about 30 seconds:

- The horn sounds.
- Some exterior lights flash.

■ Canceling panic mode

Press any button on the remote transmitter, or set the power mode to ON.

Opening/Closing the Power Windows

The power windows can be opened and closed when the power mode is in ON, using the switches on the doors.

The driver's side switches can be used to open and close all the windows. The power window lock button on the driver's side must be switched off (not pushed in, indicator off) to open and close the windows from anywhere other than the driver's seat.

When the power window lock button is pushed in, the indicator comes on and you can only operate the driver's window. Turn the power window lock button on if a child is in the vehicle.

Opening/Closing the Windows with Auto-Open/Close Function

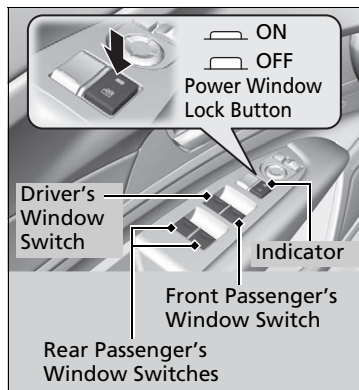

Automatic operation

To open: Push the switch down firmly.

To close: Pull the switch up firmly.

The window opens or closes completely. To stop the window at any time, push or pull the switch briefly.

Manual operation

To open: Push the switch down lightly, and hold it until the desired position is reached.

To close: Pull the switch up lightly, and hold it until the desired position is reached.

Opening/Closing the Power Windows

WARNING

Closing a power window on someone's hands or fingers can cause serious injury.

Make sure your passengers are away from the windows before closing them.

The power windows can be operated for up to 10 minutes after you set the power mode to VEHICLE OFF.

Opening either front door cancels this function.

Auto Reverse

If a power window senses resistance when closing automatically, it stops closing and reverses direction.

The driver's window auto reverse function is disabled when you continuously pull up the switch.

The auto reverse function stops sensing when the window is almost closed to ensure that it fully closes.

■ Opening the Windows and Moonroof with the Remote

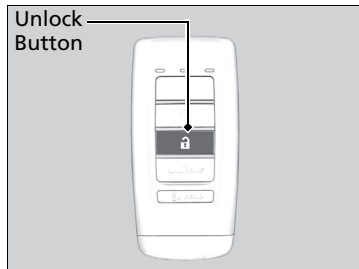

To open: Press the unlock button, and then within 10 seconds, press it again and hold it. If the windows and moonroof stop midway, repeat the procedure.

■ Opening/Closing the Windows and Moonroof with the Key

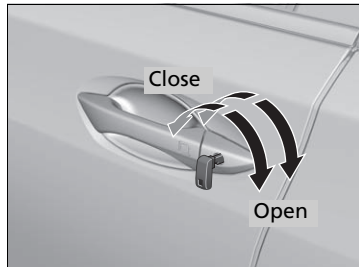

To open: Unlock the driver's door with the key. Within 10 seconds of returning the key to the central position, turn the key in the unlock direction and hold it there.

To close: Lock the driver's door with the key. Within 10 seconds of returning the key to the central position, turn the key in the lock direction and hold it there.

Release the key to stop the windows and moonroof at the desired position. If you want further adjustment, repeat the same operation.

Opening/Closing the Moonroof

■ Using the Moonroof Switch

You can only operate the moonroof when the power mode is in ON. Use the switch in the front of the ceiling to open and close the moonroof.

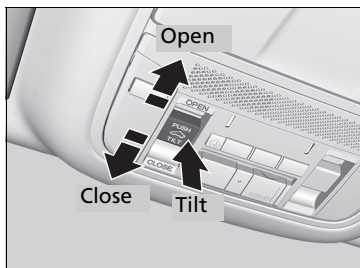

■ Automatic operation

To open: Pull the switch back firmly.

To close: Push the switch forward firmly.

The moonroof will automatically open or close all the way. To stop the moonroof midway, touch the switch briefly.

■ Manual operation

To open: Pull the switch back lightly, and hold it until the desired position is reached.

To close: Push the switch forward lightly, and hold it until the desired position is reached.

■ Tilting the moonroof up

To tilt: Push on the center of the moonroof switch.

To close: Push the switch forward firmly, then release.

☒ Using the Moonroof Switch

⚠ WARNING

Opening or closing the moonroof on someone's hands or fingers can cause serious injury.

Make sure all hands and fingers are clear of the moonroof before opening or closing it.

NOTICE

Opening the moonroof in below freezing temperature or when it is covered with snow or ice can damage the moonroof panel or motor.

The moonroof can be operated for up to 10 minutes after you set the power mode to VEHICLE OFF. Opening either front door cancels this function.

When resistance is detected, the auto reverse function causes the moonroof to change directions, then stop. Auto reverse stops sensing when the moonroof is almost closed to ensure that it fully closes. Make sure that all objects, including fingers, are clear of the moonroof.

You can use the remote transmitter or the key to operate the moonroof.

☒ **Opening the Windows and Moonroof with the Remote** P. 150

☒ **Opening/Closing the Windows and Moonroof with the Key** P. 150

POWER Button

■ Changing the Power Mode

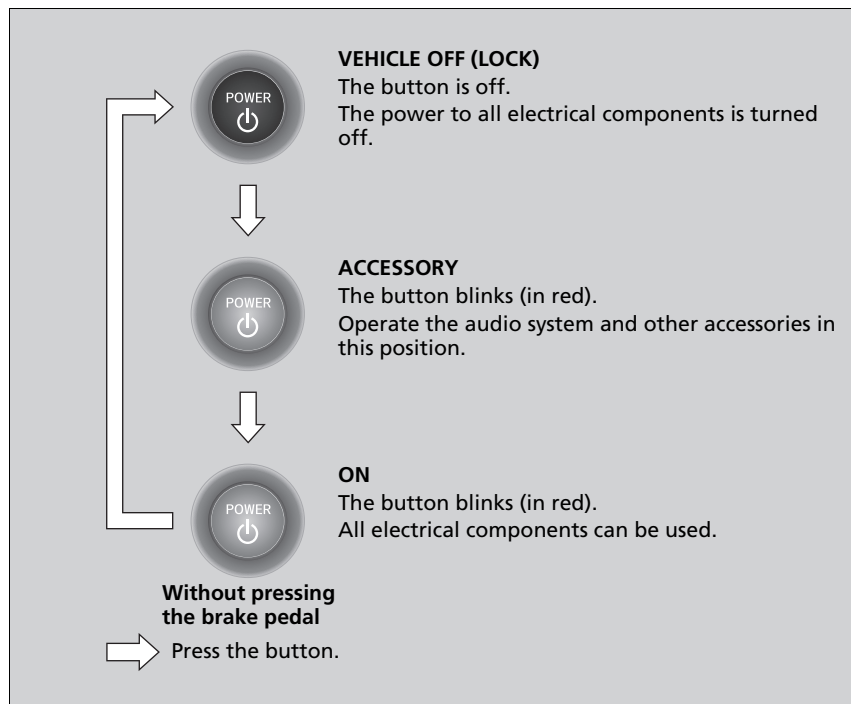

▶ POWER Button

POWER Button Operating Range

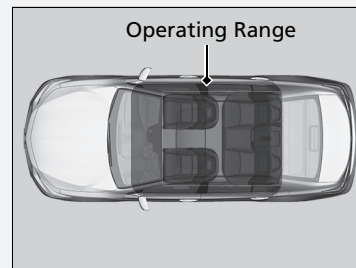

You can start the power system when the keyless access remote is inside the vehicle. The power system may also start if the keyless access remote is close to a door or window, even if it is outside the vehicle.

ON mode:
The **POWER** button is on (in red), if the power system is on.

If the battery of the keyless access remote is getting low, the power system may not start when you press the **POWER** button. If the power system does not start, refer to the following link.

▶ **If the Keyless Access Remote Battery is Weak** P. 560

Do not leave the power mode in ACCESSORY or ON when you get out.

■ Automatic Power Off

If you leave the vehicle for 30 to 60 minutes with the transmission in **P** and the power mode in ACCESSORY, the vehicle automatically goes into the mode similar to VEHICLE OFF (LOCK) to avoid draining the 12-volt battery.

■ Power Mode Reminder

If you open the driver's door when the power mode is set to ACCESSORY, a warning buzzer sounds.

■ Keyless Access Remote Reminder

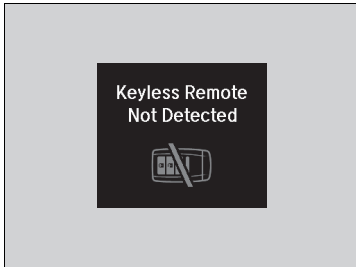

Warning buzzers may sound from inside and/or outside the vehicle to remind you that the keyless access remote is out of the vehicle. If the buzzer continues even after the remote is put back inside, place it to be within its operational range.

■ When the power mode is in ON

If the keyless access remote is taken out of the vehicle, and the driver's door is closed, a warning buzzer sounds from both inside and outside the vehicle. A warning message on the multi-information display notifies the driver inside that the remote is outside of the vehicle.

■ When the power mode is in ACCESSORY

If the keyless access remote is taken out of the vehicle, and all the doors are closed, a warning buzzer sounds from outside the vehicle.

⊠ Keyless Access Remote Reminder

When the keyless access remote is within the system's operational range, and the driver's door is closed, the warning function cancels.

If the keyless access remote is taken out of the vehicle after the power system has been turned on, you can no longer change the **POWER** button mode or restart the power system. Always make sure if the remote is in your vehicle when you operate the **POWER** button.

Removing the keyless access remote from the vehicle through a window does not activate the warning buzzer.

Do not put the keyless access remote on the dashboard or in the glove box. It may cause the warning buzzer to activate. Under some other conditions that can prevent the vehicle from locating the remote, the warning buzzer may also activate even if the remote is within the system's operational range.

Turn Signals

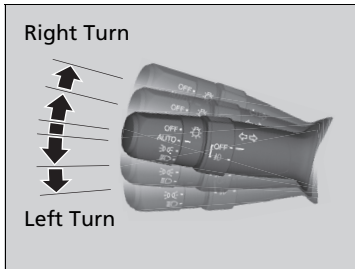

The turn signals can be used when the power mode is in ON.

■ One-touch turn signal

When you lightly push up or down and release the turn signal lever, the exterior turn signals and turn signal indicator blink three times.

This feature can be used when signaling for a lane change.

Light Switches

Manual Operation

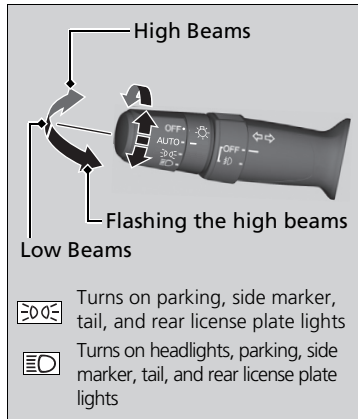

Rotating the light switch turns the lights on and off, regardless of the power mode setting.

High beams

Push the lever forward until you hear a click.

Low beams

When in high beams, pull the lever back to return to low beams.

Flashing the high beams

Pull the lever back, and release it.

Lights off

Turn the lever to **OFF** either when:

- The transmission is in **P**.
- The parking brake is applied.

To turn the lights on again, turn the lever to **OFF** to cancel the lights off mode. Even if you do not cancel the lights off mode, the lights come on automatically when:

- The transmission is taken out of **P** and the parking brake is released.
- The vehicle starts to move.

Light Switches

If you leave the power mode in VEHICLE OFF while the lights are on, a chime sounds when the driver's door is opened.

When the lights are on, the lights on indicator in the instrument panel will be on.

Lights On Indicator P. 87

Do not leave the lights on when the power system is off because it will cause the 12-volt battery to discharge.

Your vehicle is equipped with the automatic headlight adjusting system that automatically adjusts the vertical angle of the headlights. If you find a significant change in the vertical angle of the headlights, there may be a problem with the system. Have your vehicle checked by a dealer.

Automatic Operation (automatic lighting control)

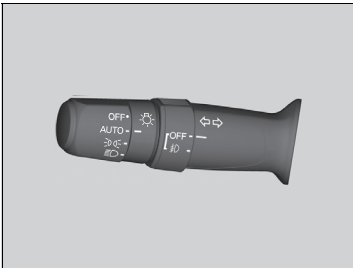

Automatic lighting control can be used when the power mode is in ON.

When the light switch is in **AUTO**, the headlights and other exterior lights will switch on and off automatically depending on the ambient brightness.

The headlights comes on when you unlock a door in dark areas with the headlight switch in **AUTO**.

- ▶ Once you lock the door, the headlights will go off.

Automatic Operation (automatic lighting control)

We recommend that you turn on the lights manually when driving at night, in a dense fog, or in dark areas such as long tunnels or parking facilities.

The light sensor is in the location shown below. Do not cover this light sensor with anything; otherwise, the automatic lighting system may not work properly.

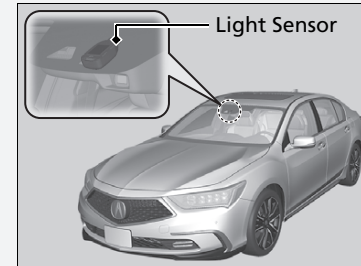

You can adjust the auto light sensitivity as follows:

Setting	The exterior lights come on when the ambient light is at	
Max		
High		Bright
Mid		
Low		
Min		Dark

▶ Customized Features P. 295

■ Headlight Integration with Wipers*

The headlights automatically come on when the wipers are used several times within a certain intervals with the headlight switch in **AUTO**.
The headlights automatically go off a few minutes later if the wipers are stopped.

■ Automatic Lighting Off Feature

The headlights, all other exterior lights, and the instrument panel lights turn off 15 seconds after you set the power mode to VEHICLE OFF, take the remote with you, and close the driver's door.

If you set the power mode to VEHICLE OFF with the headlight switch on, but do not open the door, the lights turn off after 10 minutes (three minutes, if the switch is in the **AUTO** position).

The lights turn on again when you unlock or open the driver's door. If you unlock the door, but do not open it within 15 seconds, the lights go off. If you open the driver's door, you will hear a lights on reminder chime.

⌘ Headlight Integration with Wipers*

This feature activates when the headlights are off in **AUTO**.
The instrument panel brightness does not change when the headlights come on.

At dark ambient light levels, the automatic lighting control feature turns on the headlights, regardless of the number of wiper sweeps.

⌘ Automatic Lighting Off Feature

You can change the headlight auto off timer setting.
🔧 **Customized Features** P. 295

Fog Lights*

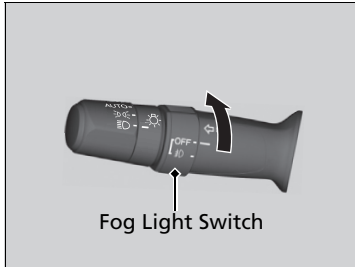

When the low beam headlights are on, turn the fog light switch on to use the fog lights.

Daytime Running Lights

The parking/daytime running lights come on when the following conditions have been met:

- The power mode is in ON.
- The headlight switch is **AUTO**, or in .
- The parking brake is released.

The lights remain on even if you set the parking brake. Setting the power mode to VEHICLE OFF will turn off the daytime running lights.

The daytime running lights go off once the headlight switch is turned on, or when the headlight switch is in **AUTO** and it is getting dark outside.

⊗ Fog Lights*

The fog lights go off when the headlights turn off, or when the daytime running lights are on.

* Not available on all models

Auto High-Beam

The front sensor camera detects the light sources ahead of the vehicle such as the lights of a preceding or oncoming vehicle, or street lights. When you are driving at night, the system automatically switches the headlights between low beam and high beam depending on the situation.

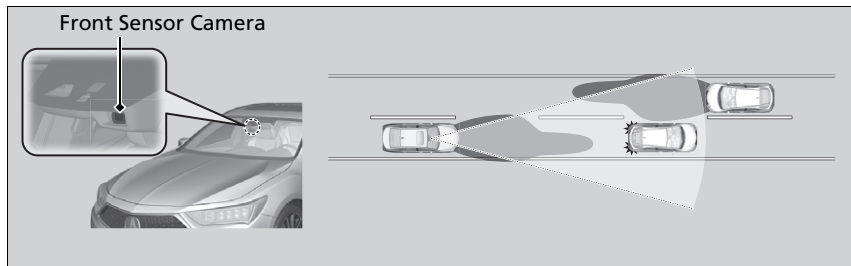

How to Use the Auto High-Beam

When all of the following conditions have been met, the auto high-beam indicator comes on and the auto high-beam is activated.

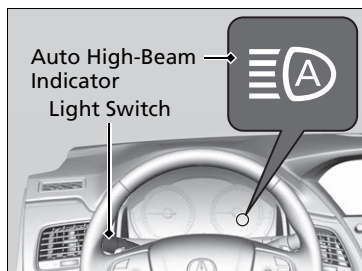

- The power mode is in ON.
- The light switch is in **AUTO**.
- The lever is in the low beam position.
- The headlights have been automatically activated.
- It is dark outside the vehicle.

If the auto high-beam indicator does not come on even when all the conditions have been met, carry out the following procedure and the indicator will come on.

- Pull the lever toward you for flashing the high beams then release it while driving.

Auto High-Beam

The auto high-beam system does not always operate in every situation. This system is just for assisting the driver. Always observe your surroundings and switch the headlights between high beam and low beam manually if necessary.

If you find the timing of beam changes inconvenient for driving, change the headlight beams manually.

The range and the distance at which the camera can recognize varies depending on conditions surrounding your vehicle.

For the auto high-beam to work properly:

- Do not place an object that reflects light on the dashboard.
- Keep the windshield around the camera clean. When cleaning the windshield, be careful not to apply the windshield cleanser to the camera lens.
- Do not attach an object, sticker or film to the area around the camera.
- Do not touch the camera lens.

If the camera receives a strong impact, or repairing of the area near the camera is required, consult a dealer.

■ Automatic switching between high-beam and low-beam

When auto-high beam is active, the headlights switch between high beam and low beam based on the following conditions.

Switching to high beam:

All of the following conditions must be met before the high beams turn on.

- Your vehicle speed is 25 mph (40 km/h) or more.
- There are no preceding or oncoming vehicle with headlights or taillights turned on.
- There are few street lights on the road ahead.



Switching to low beam:

One of the following conditions must be met before the low beams turn on.

- Your vehicle speed is 15 mph (24 km/h) or less.
- There is a preceding or oncoming vehicle with headlights or taillights turned on.
- There are many street lights on the road ahead.

■ Manual switching between high-beam and low-beam

If you want to manually switch the headlights between high beam and low beam, follow either of the procedures below. Note that when you do this, the auto high-beam indicator will turn off and the auto high-beam will be deactivated.

Using the lever:

Pull the lever toward you for flashing the high beams then release it within about one second while driving.

- ▶ To reactivate the auto high-beam, pull the lever toward you for flashing the high beams then release it while driving. The auto high-beam indicator will come on.

Using the light switch:

Turn the light switch to .

- ▶ To reactivate the auto high-beam, turn the light switch to **AUTO** when the lever is in the low beam position, the auto high-beam indicator will come on.

How to Use the Auto High-Beam

In the following cases, the auto high-beam system may not switch the headlights properly or the switching timing may be changed. In case of the automatic switching operation does not fit for your driving habits, please switch the headlights manually.

- The brightness of the lights from the preceding or oncoming vehicle is intense or poor.
- Visibility is poor due to the weather (rain, snow, fog, windshield frost, etc.).
- Surrounding light sources, such as street lights, electric billboards and traffic lights are illuminating the road ahead.
- The brightness level of the road ahead constantly changes.
- The road is bumpy or has many curves.
- A vehicle suddenly appears in front of you, or a vehicle in front of you is not in the preceding or oncoming direction.
- Your vehicle is tilted with a heavy load in the rear.
- A traffic sign, mirror, or other reflective object ahead is reflecting strong light toward the vehicle.
- The oncoming vehicle frequently disappears under roadside trees or behind median barriers.
- The preceding or oncoming vehicle is a motorcycle, bicycle, mobility scooter, or other small vehicle.

The auto high-beam system keeps the headlight low beam when:

- Windshield wipers are operating at a high speed.
- The camera has been detected a dense fog.

■ How to Turn Off the Auto High-Beam

You can turn the auto high-beam system off. If you want to turn the system off or on, set the power mode to ON, then carry out the following procedures while the vehicle is stationary.

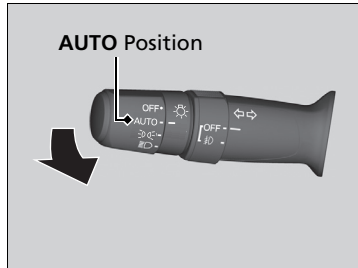

To turn the system off:

With the light switch is in **AUTO**, pull the lever toward you and hold it for at least 40 seconds. After the auto high-beam indicator light blinks twice, release the lever.

To turn the system on:

With the light switch is in **AUTO**, pull the lever toward you and hold it for at least 30 seconds. After the auto high-beam indicator light blinks once, release the lever.

☒ How to Use the Auto High-Beam

If the **Some Driver Assist Systems Cannot Operate: Camera Temperature Too High** message appears:

- Use the climate control system to cool down the interior and, if necessary, also use defroster mode with the airflow directed toward the camera.
- Start driving the vehicle to lower the windshield temperature, which cools down the area around the camera.

If the **Auto High-Beam Cannot Operate: Clean Windshield** message appears:

- Park your vehicle in a safe place, and clean the windshield. If the message does not disappear after you have cleaned the windshield and driven for a while, have your vehicle checked by a dealer.

☒ How to Turn Off the Auto High-Beam

If you turn the auto high-beam system off, the system does not operate until you turn the system on.

Park in a safe place before turning the system off or on.

Wipers and Washers

■ Windshield Wiper/Washer



The windshield wipers and washers can be used when the power mode is in ON.

■ MIST

The wipers run at high speed until you release the lever.

■ Wiper switch (OFF, AUTO, LO, HI)

Move the lever up or down to change the wiper settings.

■ Washer

Sprays while you pull the lever toward you. When you release the lever for more than one second, the spray stops, the wipers sweep two or three more times to clear the windshield, then stop.

» Wipers and Washers

NOTICE

Do not use the wipers when the windshield is dry. The windshield will get scratched, or the rubber blades will get damaged.

NOTICE

In cold weather, the blades may freeze to the windshield. Operating the wipers in this condition may damage the wipers. Use the defroster to warm the windshield, then turn the wipers on.

Turn the washers off if no washer fluid comes out. The pump may get damaged.

The wiper motor may stop motor operation temporarily to prevent an overload. Wiper operation will return to normal within a few minutes, once the circuit has returned to normal.

If the wipers stop operating due to any obstacle such as the build-up of snow, park the vehicle in a safe place.

Rotate the wiper switch to **OFF**, and set the power mode to ACCESSORY or VEHICLE OFF, then remove the obstacle.

■ Automatic Intermittent Wipers

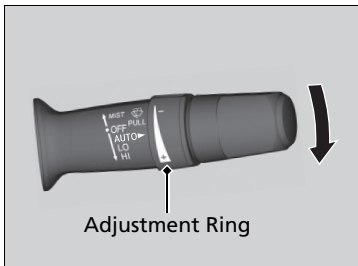

When you push the lever down to **AUTO**, the windshield wipers sweep once, and go into the automatic mode.

The wipers operate intermittently, at low speed, or at high speed and stops in accordance with the amount of rainfall the rainfall sensor detects.

■ AUTO sensitivity adjustment

When the wiper function is set to **AUTO**, you can adjust the sensitivity of the rainfall sensor (using the adjustment ring) so that wipers will operate in accordance with your preference.

Sensor sensitivity

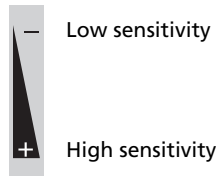

▶ Automatic Intermittent Wipers

The rainfall sensor is in the location shown below.

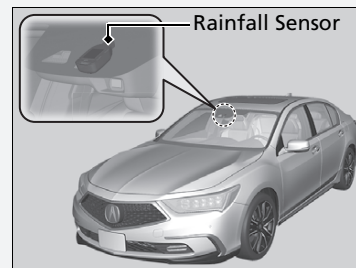

AUTO should always be turned **OFF** before the following situations in order to prevent severe damage to the wiper system:

- Cleaning the windshield
- Driving through a car wash
- No rain present

You can change the automatic intermittent wiper setting in the **AUTO** position.

Rain Sensing, Intermittent, and Speed Sensitive can be selected.

Rain Sensing: Default setting.

Intermittent: You can adjust the intermittent time using the adjustment ring.

Speed Sensitive: You can adjust the intermittent time using the adjustment ring. In addition, the intermittent time becomes a few seconds shorter when the vehicle speeds up.

▶ **Customized Features** P. 295

Canadian models

Headlight Washers

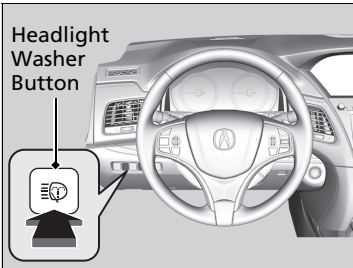

Turn the headlights on and press the headlight washer button to operate. The headlight washers also operate when you turn the windshield washers for the first time after the power mode sets to ON.

Headlight Washers

The headlight washers use the same fluid reservoir as the windshield washers.

Brightness Control

■ Adjusting the Instrument Panel Brightness

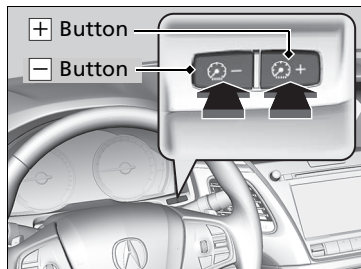

When the power mode is in ON, you can use the **+** or **-** button to adjust instrument panel brightness.

Brighten: Press the **+** button.

Dim: Press the **-** button.

You will hear a beep when the brightness reaches minimum or maximum. Several seconds after you have adjusted the brightness, you will be returned to the previous screen.

■ Brightness level indicator

The brightness level is shown on the multi-information display while you are adjusting it.

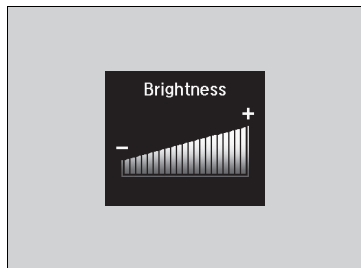

▶▶ Adjusting the Instrument Panel Brightness

Instrument panel brightness varies, depending on whether the exterior lights are on or off. The instrument panel dims to reduce glare when they are on.

When it is bright outside and the headlight integration with the wiper* is activated, the instrument panel brightness does not change.

To cancel the reduced instrument panel brightness when the exterior lights are on, press the **+** button until the brightness display is up to max, the beeper sounds.

The brightness can be set differently for when the exterior lights are on, and when they are off.

■ Adjusting the Head-Up Display Brightness

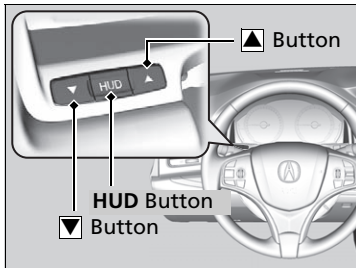

When the head-up display is on, press and hold the **HUD** button until its brightness level indicator on the multi-information display.

Brighten: Press the ▲ button.

Dim: Press the ▼ button.

Several seconds after you have adjusted the brightness, you will be returned to the previous screen.

■ Brightness level indicator

The brightness level is shown on the multi-information display while you are adjusting it.

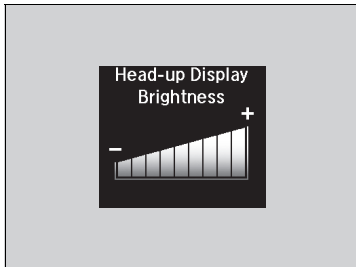

Rear Defogger/Heated Door Mirror/Heated Windshield Button

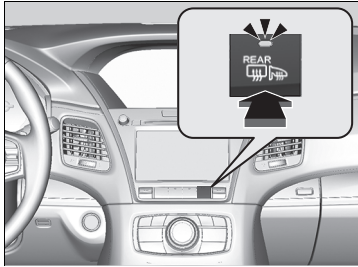

Press the rear defogger, heated door mirror, and heated windshield button to defog the rear window and mirrors, and to deice the windshield when the power mode is in ON.

The rear defogger, heated door mirrors, and heated windshield automatically switch off after 10-30 minutes depending on the outside temperature.

However, if the outside temperature is 32°F (0°C) or below, they do not automatically switch off.

⌘ Rear Defogger/Heated Door Mirror/Heated Windshield Button

This system consumes a lot of power, so turn it off when the window has been defogged or deiced. Also, do not use the system for a long time while the power system is stopped. This may weaken the 12-volt battery, making it difficult to turn the power system on.

When the power mode is set to ON and the outside temperature is below 41°F (5°C), the heated door mirror may automatically activate for 10 minutes.

When the outside temperature is below 39°F (4°C) and the windshield defroster is turned on, the heated windshield may automatically activate. The heated windshield deactivates itself once the windshield defroster is turned off or the outside temperature reaches 43°F (6°C).

Driving Position Memory System

You can store two driver's seat (except for power lumbar), steering wheel and door mirror positions with the driving position memory system.

When you unlock and open the driver's door with a remote transmitter, or keyless access system, door mirrors adjust to one of the two preset positions and the seat adjusts to retracted positions of one of the two preset positions automatically.

The steering wheel and the seat will move to the stored position when you set the power mode to ACCESSORY.

When you enter the vehicle, the multi-information display briefly shows you which remote transmitter you used to unlock the vehicle.

- **DRIVER 1** transmitter is linked to memory button 1.
- **DRIVER 2** transmitter is linked to memory button 2.

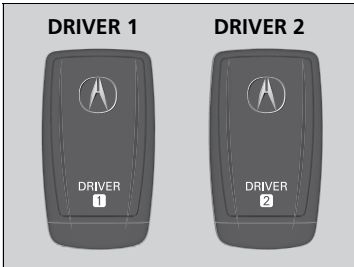

The driver's seat moves rearward and steering wheel fully up depending on the set seating position once you

- Stop the vehicle.
- Put the transmission in **P**.
- Set the power mode to VEHICLE OFF.
- Then open the driver's door.

Once the power mode is in the ACCESSORY position, the driver's seat and steering wheel moves to the **DRIVER 1** or **2** preset position.

▶▶ Driving Position Memory System

Using the audio/information screen, you can disable the automatic seat, steering wheel and door mirrors adjustment function.

▶▶ **Customized Features** P. 295

You can change the driver's seat easy exit feature setting.

▶▶ **Customized Features** P. 295

System Operation

The system will not operate if:

- The vehicle speed is above 2 mph (3 km/h).
- Either memory position button is pressed while the seat, steering wheel or the outside mirror is in motion.
- The seat, steering wheel or the outside mirror position is adjusted while in operation.
- The memory 1 or 2 position is set fully to the rear.

■ Storing a Position in Memory

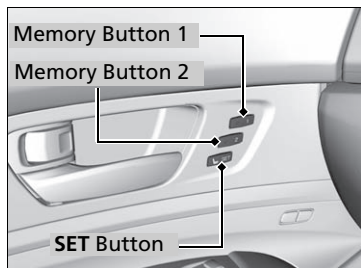

1. Set the power mode to ON. Adjust the driver's seat, the steering wheel and the door mirrors to the desired position.
2. Press the **SET** button.
 - ▶ You will hear the beep, and the memory button indicator light will blink.
3. Press memory button **1** or **2** within five seconds of pressing the **SET** button.
 - ▶ You will hear two beeps, and the indicator light on the button you pressed stays on once the seat, the steering wheel, and the outside mirror positions have been memorized.

■ Recalling the Stored Position

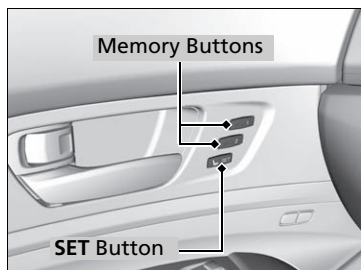

1. Change to **P**.
2. Apply the parking brake.
3. Press a memory button (**1** or **2**).
 - ▶ You will hear the beep, and the indicator light will blink.

The seat, the steering wheel and the door mirrors will automatically move to the memorized positions. When it has finished moving, you will hear two beeps, and the indicator light stays on.

▶▶ Storing a Position in Memory

After you press the **SET** button, the storing operation will be canceled when:

- You do not press the memory button within five seconds.
- You readjust the seat, the steering wheel or the outside mirror position before the double-beep.
- You set the power mode to any position except ON.

▶▶ Recalling the Stored Position

The seat, the steering wheel and the door mirrors will stop moving if you:

- Press the **SET** button, or a memory button (**1** or **2**).
- Adjust the seat, the steering wheel or the door mirror position.
- Put the transmission into a position other than **P**.

Adjusting the Steering Wheel

The steering wheel height and distance from your body can be adjusted so that you can comfortably grip the steering wheel in an appropriate driving posture.

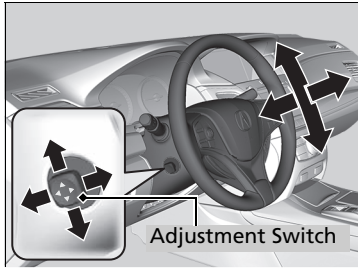

Push and hold the adjustment switch to move the steering wheel in, out, up or down.

Make sure you can see the instrument panel gauges and indicators.

Adjusting the Steering Wheel

⚠ WARNING

Adjusting the steering wheel position while driving may cause you to lose control of the vehicle and be seriously injured in a crash.

Adjust the steering wheel only when the vehicle is stopped.

Interior Rearview Mirror

Adjust the angle of the rearview mirror when you are sitting in the correct driving position.

Adjusting the Mirrors

Keep the inside and outside mirrors clean and adjusted for best visibility.

Adjust the mirrors before you start driving.

➤ **Front Seats** P. 175

Automatic Dimming Rearview Mirror and Power Door Mirrors*

The auto dimming function cancels when the transmission is in **R**.

Automatic Dimming Rearview Mirror and Power Door Mirrors*

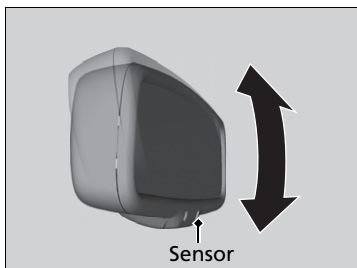

When driving after dark, the automatic dimming rearview mirror and power door mirrors* reduce the glare from headlights behind you, based in inputs from the mirror sensor. This feature is always active.

Power Door Mirrors

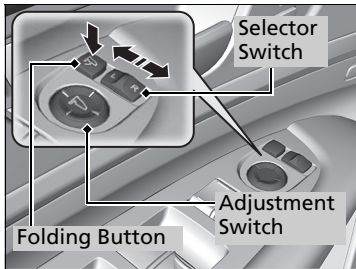

You can adjust the door mirrors when the power mode is in ON.

■ Mirror position adjustment

L/R selector switch: Select the left or right mirror. After adjusting the mirror, return the switch to the center position.

Mirror position adjustment switch: Press the switch left, right, up, or down to move the mirror.

■ Folding door mirrors

Press the folding button to fold in and out the door mirrors.

■ Reverse Tilt Door Mirror

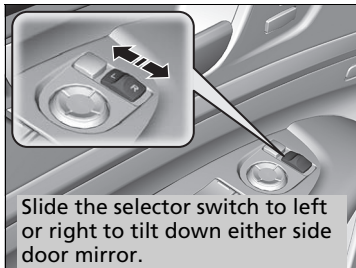

If activated, either side door mirror automatically tilts downward when you put the transmission into **R**; this improves close-in visibility on the selected side of the vehicle when backing up. The mirror automatically returns to its original position when you take the transmission out of **R**.

To activate this feature, set the power mode to ON and slide the selector switch to the left or right side.

■ Automatic Folding Door Mirror Function

■ Folding in the door mirrors

Press the lock button on the keyless access remote, or press the door lock button on any door.

- ▶ The mirrors start folding in automatically.

■ Folding out the door mirrors

Press the unlock button on the keyless access remote, or grab the door handle on any door.

- ▶ The mirrors start folding out automatically.

⌘ Automatic Folding Door Mirror Function

You can turn the automatic folding door mirror function on and off.

- ⌘ **Customized Features** P. 295

⌘ Folding out the door mirrors

You cannot turn the automatic folding out automatically if they have been folded in using the folding button.

Adjusting the Seats

Front Seats

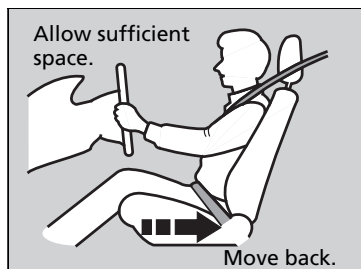

Adjust the driver's seat as far back as possible while allowing you to maintain full control of the vehicle. You should be able to sit upright, well back in the seat and be able to adequately depress the pedals without leaning forward, and grip the steering wheel comfortably. The passenger's seat should be adjusted in a similar manner, so that it is as far back from the front airbag in the dashboard as possible.

■ Adjusting the front power seats

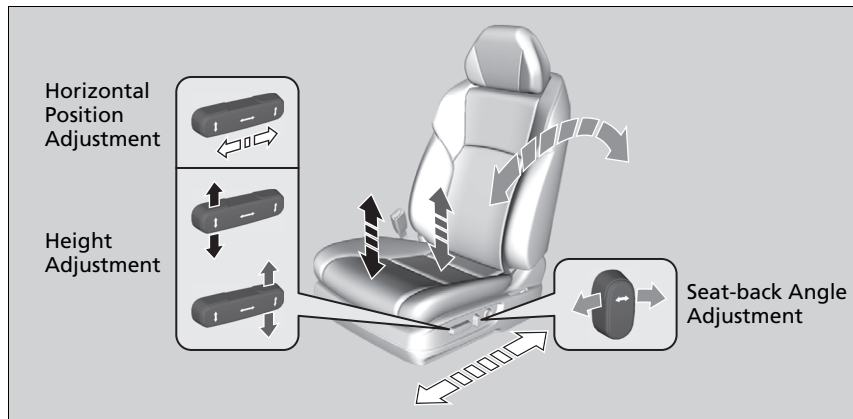

Adjusting the Seats

⚠ WARNING

Sitting too close to a front airbag can result in serious injury or death if the front airbags inflate.

Always sit as far back from the front airbags as possible while maintaining control of the vehicle.

The National Highway Traffic Safety Administration and Transport Canada recommend that drivers allow at least 10 inches (25 cm) between the center of the steering wheel and the chest.

Always make seat adjustments before driving.

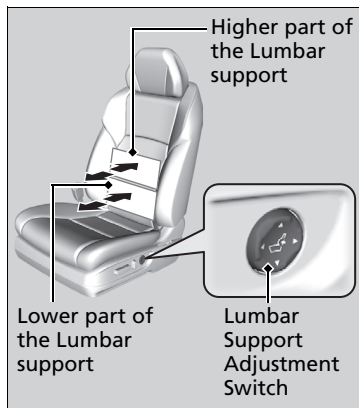

■ Lumbar Support Adjustment Switch

Press the top: To increase the higher part of the lumbar support.

Press the bottom: To increase the lower part of the lumbar support. (The higher part support is decreased.)

Press the front: To increase the entire lumbar support.

Press the rear: To decrease the entire lumbar support.

■ Adjusting the Seat-Backs

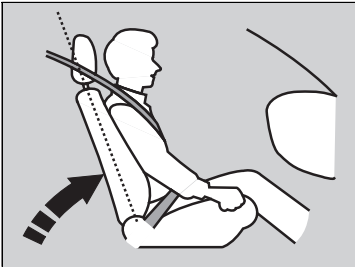

Adjust the driver's seat-back to a comfortable, upright position, leaving ample space between your chest and the airbag cover in the center of the steering wheel.

The front seat passenger should also adjust their seat-back to a comfortable, upright position.

Reclining a seat-back so that the shoulder part of the belt no longer rests against the occupant's chest reduces the protective capability of the belt. It also increases the chance of sliding under the belt in a crash and being seriously injured. The farther a seat-back is reclined, the greater the risk of injury.

⌘ Adjusting the Seat-Backs

⚠ WARNING

Reclining the seat-back too far can result in serious injury or death in a crash.

Adjust the seat-back to an upright position, and sit well back in the seat.

Do not put a cushion, or other object, between the seat-back and your back. Doing so may interfere with proper seat belt or airbag operation.

If you cannot get far enough away from the steering wheel and still reach the controls, we recommend that you investigate whether some type of adaptive equipment may help.

Head Restraints

Your vehicle is equipped with head restraints in all seating positions.

■ Adjusting the Front and Rear Outer Head Restraint Positions

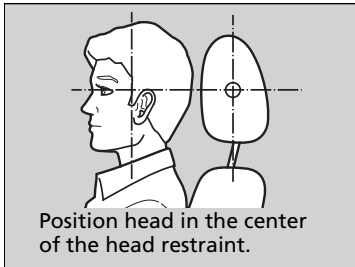

Head restraints are most effective for protection against whiplash and other rear-impact crash injuries when the center of the back of the occupant's head rests against the center of the restraint. The tops of the occupant's ears should be level with the center height of the restraint.

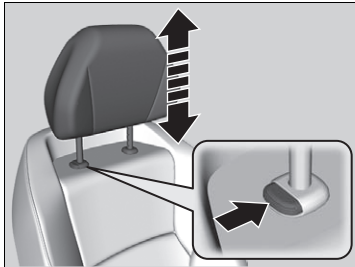

▣ Adjusting the Front and Rear Outer Head Restraint Positions

⚠ WARNING

Improperly positioning head restraints reduces their effectiveness and increases the likelihood of serious injury in a crash.

Make sure head restraints are in place and positioned properly before driving.

In order for the head restraint system to work properly:

- Do not hang any items on the head restraints, or from the restraint legs.
- Do not place any object between an occupant and the seat-back.
- Install each restraint in its proper location.

■ Changing the Rear Center Seat Head Restraint Positions

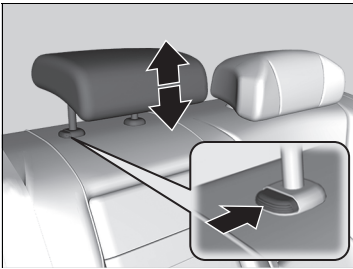

A passenger sitting in the center back seating position should adjust the height of their head restraint to an appropriate position before the vehicle begins moving.

To raise the head restraint:

Pull it upward.

To lower the head restraint:

Push it down while pressing the release button.

■ Removing and Reinstalling the Head Restraints

Head restraints can be removed for cleaning or repair.

To remove a head restraint:

Pull the restraint up as far as it will go. Then push the release button, and pull the restraint up and out.

To reinstall a head restraint:

Insert the legs back in place, then adjust the head restraint to an appropriate height while pressing the release button. Pull up on the restraint to make sure it is locked in position.

✕ Removing and Reinstalling the Head Restraints

⚠ WARNING

Failure to reinstall, or correctly reinstall, the head restraints can result in severe injury during a crash.

Always replace the head restraints before driving.

Maintain a Proper Sitting Position

After all occupants have adjusted their seats and head restraints, and put on their seat belts, it is very important that they continue to sit upright, well back in their seats, with their feet on the floor, until the vehicle is safely parked and the power system is off.

Sitting improperly can increase the chance of injury during a crash. For example, if an occupant slouches, lies down, turns sideways, sits forward, leans forward or sideways, or puts one or both feet up, the chance of injury during a crash is greatly increased.

In addition, an occupant who is out of position in the front seat can be seriously or fatally injured in a crash by striking interior parts of the vehicle or being struck by an inflating front airbag.

► Maintain a Proper Sitting Position

WARNING

Sitting improperly or out of position can result in serious injury or death in a crash.

Always sit upright, well back in the seat, with your feet on the floor.

Armrest

■ Using the Rear Seat Armrest

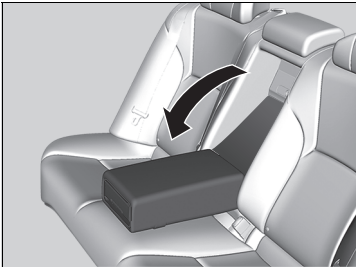

Pull down the armrest in the center backrest.

Interior Lights

Interior Light Switches

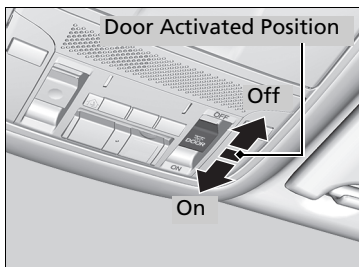

■ ON

The interior lights come on regardless whether the doors are open or closed.

■ Door activated

The interior lights come on in the following situations:

- When any doors are opened.
- You unlock the driver's door.
- When the power mode is set to VEHICLE OFF.

■ OFF

The interior lights remain off regardless whether the doors are open or closed.

Interior Light Switches

In the door activated position, the interior lights fade out and go off about 30 seconds after the doors are closed.

The lights go off after 30 seconds in the following situations:

- When you unlock the driver's door but do not open it.
- When you set the power mode to VEHICLE OFF but do not open a door.

You can change the interior lights dimming time.

➤ **Customized Features** P. 295

The interior lights go off immediately in the following situations:

- When you lock the driver's door.
- When you close the driver's door in ACCESSORY mode.
- When you set the power mode to ON.

If you leave any doors open, the interior lights go off after about 15 minutes.

To avoid draining the battery, do not leave the interior light on for an extended length of time when the power system is off.

Map Lights

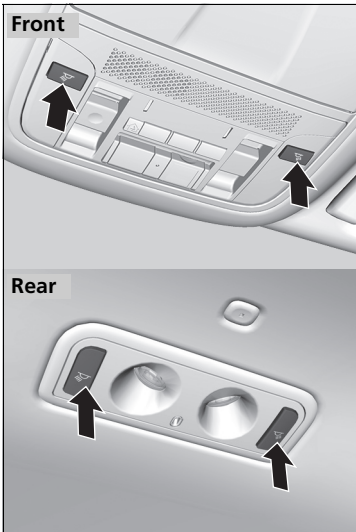

The map lights can be turned on and off by pressing the  (map light) button.

Map Lights

When the interior light switch is in the door activated position and any door is open, the map light will not go off when you press the  (map light) button.

Interior Convenience Items

■ Glove Box

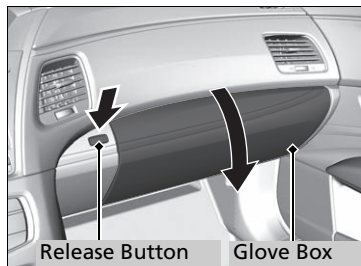

Press the release button to open the glove box.

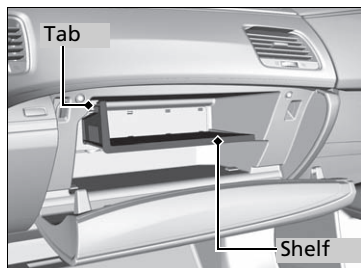

■ Removable shelf

The shelf in the glove box is detachable. To remove it, disengage the tabs.



The removable shelf can be stored upside down in the glove box.

» Glove Box

⚠ WARNING

An open glove box can cause serious injury to your passenger in a crash, even if the passenger is wearing the seat belt.

Always keep the glove box closed while driving.

Valet Mode

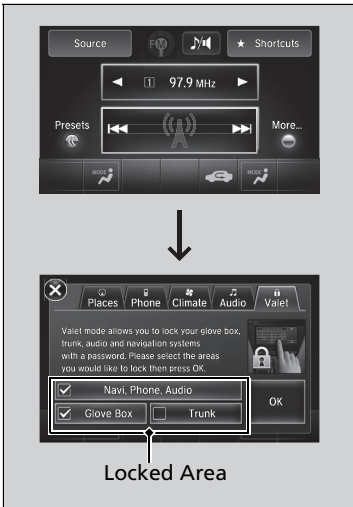

You can lock the glove box, trunk, and/or navigation system, entering a PIN code from the On Demand Multi-Use Display™.

To lock:

1. Select **Shortcuts**.
2. Select **Valet**.
3. Select the item you want to be PIN-protected from the locked area, then select **OK**.

Valet Mode

If you need to give the key to someone else, lock the cover in the rear center seat-back first, and give the keyless access remote without a built-in key as a valet key.

➤ **When You Cannot Open the Trunk** P. 582



4. The previous code is displayed. Select **OK**.
 - You will receive a confirmation message on the display. Select **OK**.

When you enter the PIN code for the first time or if you want to change the code:

1. Select **Shortcuts**.
2. Select **Valet**.
3. Select the item you want to be PIN-protected from the locked area, then select **OK**.
4. Enter your selected four-digit PIN code, then select **OK**.
5. You will be asked to enter the same four-digit PIN code again. Enter, then select **OK**.
 - You will receive a confirmation message on the display. Select **OK**.

To unlock:

1. Select **Valet**.
2. Select **Unlock**.
3. Enter the four-digit PIN code you have previously selected, then select **OK**.

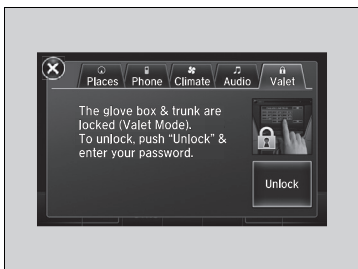

► Valet Mode

The PIN code entering screen also appears when you press:

- The glove box open button
 - The trunk release button on the trunk, on the remote, or the trunk opener on the driver's door
- While the glove box or the trunk is PIN-protected.

If you have locked all the items of the locked area, the PIN code entering screen appears with the power mode in ACCESSORY.

You can cancel the valet mode when you manually open the trunk.

► **When You Cannot Open the Trunk** P. 582

If you have only set **Navi, Phone, Audio** PIN-protected but forgot your four-digit PIN code, you need to go to a dealer to have the set valet mode reset.

■ Console Compartment

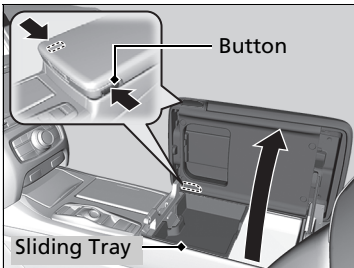

Your vehicle has a multi-function center console. It includes a storage compartment, an armrest, and a sliding tray.

Push the button on either side of the console compartment to open the console compartment.

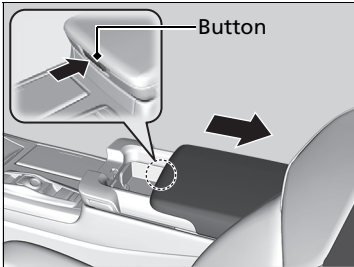

You can put small items in the sliding tray located in the console compartment lid. To use the tray, push the button, then slide the console compartment lid out fully. To close the lid, push the button. It is automatically slid back.

☒ Console Compartment

The console compartment light comes on when the parking lights are on.

Center Pocket

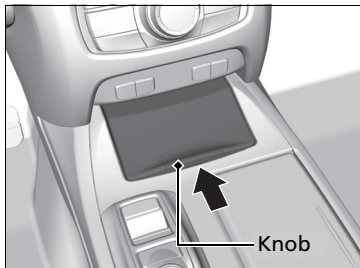

Slide the lid using the release knob to use the center pocket.
To close it, push the release knob. It is automatically slid back.

■ Beverage Holders

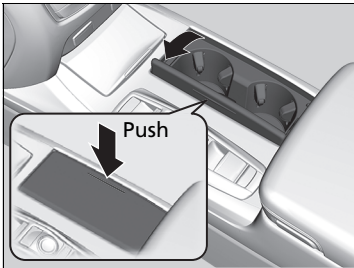

■ Front seat beverage holders

Press the raised detent to open the lid. To close the lid, push it down until it latches.

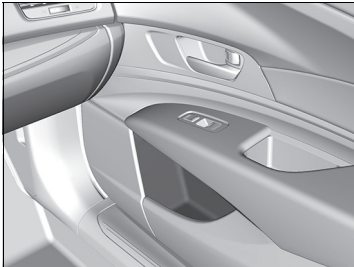

■ Front door beverage holders

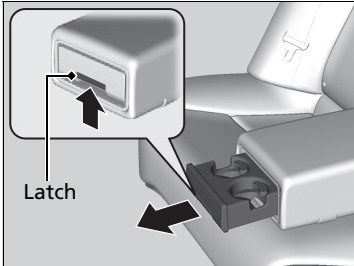

■ Rear seat beverage holders

The rear beverage holders are in the rear seat armrest. Open the beverage holders by pulling the latch up on the front.

» Beverage Holders

NOTICE

Spilled liquids damage the upholstery, carpeting, and electrical components in the interior.

Be careful when you are using the beverage holders. Hot liquid can scald you.

■ Accessory Power Sockets

The accessory power sockets can be used when the power mode is in ACCESSORY or ON.

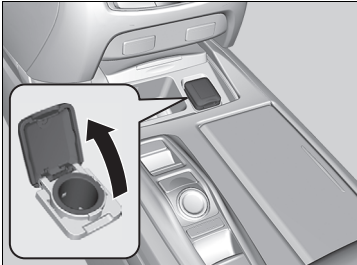

■ Center pocket

Open the lid and the cover to use it.

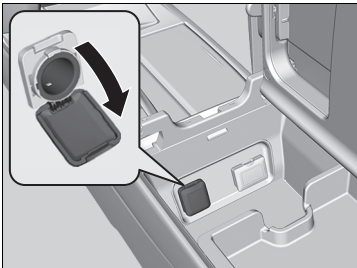

■ Console compartment

Open the console lid and the cover to use it.

» Accessory Power Sockets

NOTICE

Do not insert an automotive type cigarette lighter element.

This can overheat the power socket.

The accessory power sockets are designed to supply power for 12-volt DC accessories that are rated 180 watts (15 amps) or less.

To prevent 12-volt battery drain, only use the power socket with the power system on.

When both sockets are being used, the combined power rating of the accessories should not exceed 180 watts (15 amps).

■ Coat Hooks



There is a coat hook on the rear grab handle of both sides. Pull it down to use it.

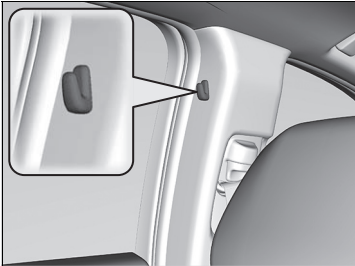

There is a coat hook on the door pillar of both sides.

☒ Coat Hooks

The coat hooks are not designed for large or heavy items.

■ Tie-down Anchors

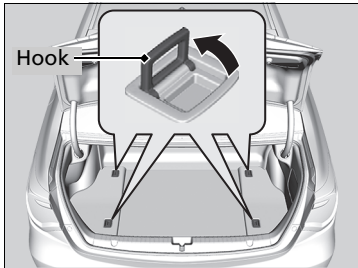

The tie-down anchors on the trunk floor can be used to install a net for securing items.

■ Cargo Hooks

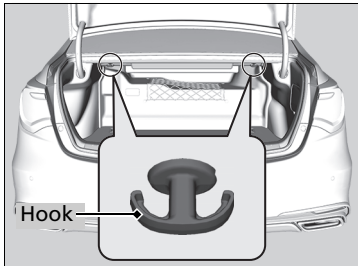

The cargo hooks in the trunk can be used to install a net for securing items.

▣ Tie-down Anchors

Distribute cargo evenly on the floor of the trunk, placing the heaviest items on the bottom and as far forward as possible.

➤ **Maximum Load Limit** P. 375

▣ Cargo Hooks

Distribute cargo evenly on the floor of the trunk, placing the heaviest items on the bottom and as far forward as possible.

➤ **Maximum Load Limit** P. 375

■ Cargo Area

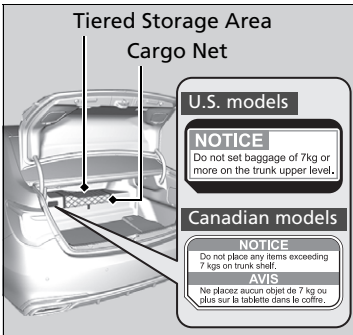

In addition to the larger cargo area, the trunk incorporates a small shelf above the High Voltage (HV) battery module that can carry up to 15 lbs (7 kg). Do not exceed this capacity.

The cargo net can be used to help hold down items stored in the trunk.

In the event a flat tire, a tire repair kit is provided beneath the trunk floor.

➤ **Temporarily Repairing a Flat Tire** P. 541

▣ Cargo Area

NOTICE

Heavy objects may damage the trunk shelf. Make sure any items put on the shelf weigh less than 15 lbs (7 kg).

■ Heated Steering Wheel

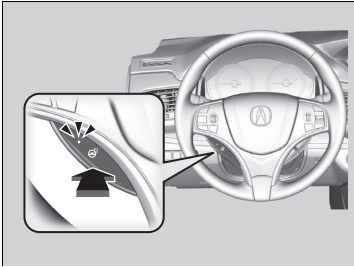

The power mode must be in ON to use the heated steering wheel.

Press the button on the left side of the steering wheel.

When a comfortable temperature is reached, press the button again to turn it off.

The heated steering wheel is turned off every time you start the power system, even if you turned it on the last time you drove the vehicle.

▣ Heated Steering Wheel

Do not use the heated steering wheel continuously when the power system is off. Under such conditions, the 12-volt battery may be weakened, making the power system difficult to start.

Front Seat Heaters*



The power mode must be in ON to use the seat heaters.

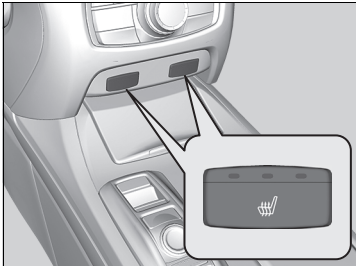

Press the seat heater button:

- Once - The HI setting (three indicators on)
- Twice - The MID setting (two indicators on)
- Three times - The LO setting (one indicator on)
- Four times - The OFF setting (no indicators on)

Front Seat Heaters*

⚠ WARNING

Heat induced burns are possible when using seat heaters.

Persons with a diminished ability to sense temperature (e.g., persons with diabetes, lower-limb nerve damage, or paralysis) or with sensitive skin should not use seat heaters.

Do not use the seat heaters even in LO when the power system is off. Under such conditions, the 12-volt battery may be weakened, making the power system difficult to start.

* Not available on all models

■ Front Seat Heaters and Ventilation*



The power mode must be in ON to use the seat heaters and ventilation.

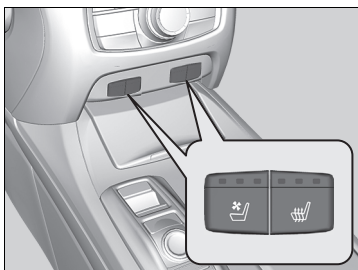

Press the seat heater or the seat ventilation button:

Once - The HI setting (three indicators on)

Twice - The MID setting (two indicators on)

Three times - The LO setting (one indicator on)

Four times - The OFF setting (no indicators on)

⌘ Front Seat Heaters and Ventilation*

⚠ WARNING

Heat induced burns are possible when using seat heaters.

Persons with a diminished ability to sense temperature (e.g., persons with diabetes, lower-limb nerve damage, or paralysis) or with sensitive skin should not use seat heaters.

Do not use the seat heaters and the seat ventilation even in LO when the power system is off. Under such conditions, the 12-volt battery may be weakened, making the power system difficult to start.

Rear Seat Heaters



The power mode must be in ON to use the seat heaters.

There is no heater in the rear center seating position.

Press the seat heater button:

Once - The HI setting (three indicators on)

Twice - The MID setting (two indicators on)

Three times - The LO setting (one indicator on)

Four times - The OFF setting (no indicators on)

Sunglasses Holder

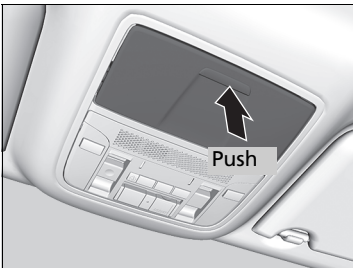

To open the sunglasses holder, push and release the indent. To close, push it again until it latches.

You can store eyeglasses and other small items in this holder.

ⓘ Rear Seat Heaters

⚠ WARNING

Heat induced burns are possible when using seat heaters.

Persons with a diminished ability to sense temperature (e.g., persons with diabetes, lower-limb nerve damage, or paralysis) or with sensitive skin should not use seat heaters.

Do not use the seat heaters even in LO when the power system is off. Under such conditions, the 12-volt battery may be weakened, making the power system difficult to start.

ⓘ Sunglasses Holder

Keep the holder closed while driving except when accessing stored items.

■ Power Rear Sunshade*

The power rear sunshade can be operated with the power mode in ON.

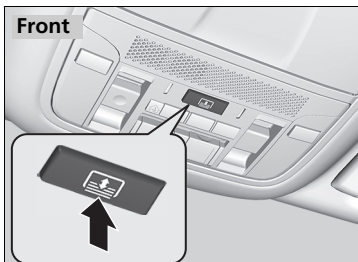

To raise: Press the button.

To lower: Press the button again.

When the transmission is put into **[R]**, the rear sunshade lowers automatically.

- If the vehicle is travelling at 10 mph (15 km/h) or more, or if the transmission is put into **[P]**, the sunshade returns to its original position.



Even if the power mode is switched to OFF, the sunshade can be operated for approximately 1 minute.

⌘ Power Rear Sunshade*

⚠ WARNING

Opening or closing the sunshade on someone's hands or fingers can cause serious injury.

Make sure all hands and fingers are clear of the sunshade before opening or closing it.

If the sunshade stops while moving, check for and clear any obstacles, then push the button again.

Expanded Rear Door Sunshades*

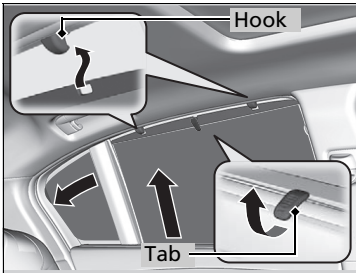

Pull the tab and roll up the sunshade all the way. Use the hooks to hang it.

Expanded Rear Door Sunshades*

Use the sunshades only when the windows are fully closed. Using the shade while a window is open can unhook and blow off the shade, hitting and possibly hurting anyone sitting near the window.

* Not available on all models

Using Automatic Climate Control

The automatic climate control system maintains the interior temperature you select. The system also selects the proper mix of heated or cooled air that raises or lowers the interior temperature to your preference as quickly as possible.

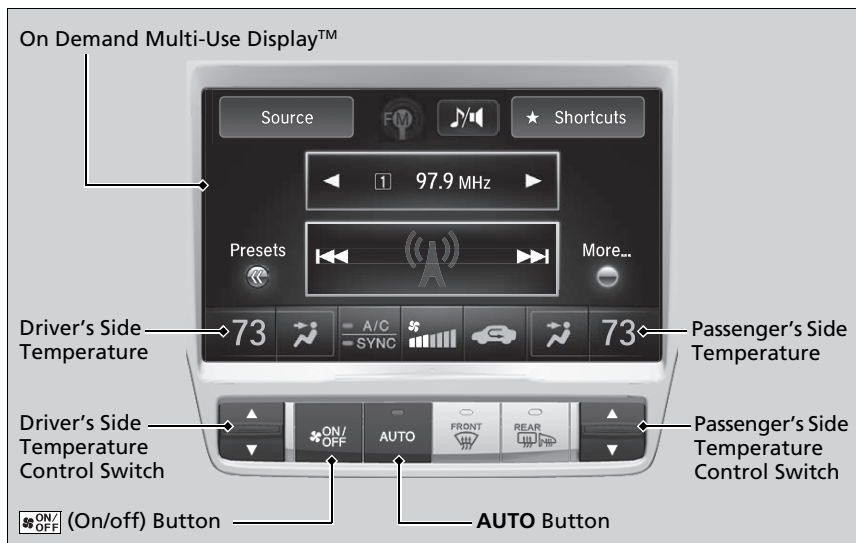

Use the system when the power system is on.

1. Press the **AUTO** button.
2. Adjust the interior temperature using the driver's side or passenger's side temperature control switch.
3. Press the **ON/OFF** (on/off) button to cancel.

In addition to the button/switch operations, you can control the climate control system from the On Demand Multi-Use Display™ touch screen.

Using Automatic Climate Control

If any buttons/icons on the touch screen are pressed while using the climate control system in auto, the function of the button/icon that was pressed will take priority. The AUTO indicator will go off, but functions unrelated to the button/icon that was pressed will be controlled automatically.

To prevent cold air from blowing in from outside, the fan may operate at low speed for a while after the **AUTO** button has been pressed.

If the interior is very warm, you can cool it down more rapidly by partially opening the windows, turning the system on auto, and setting the temperature to low. Change the fresh mode to recirculation mode until the temperature cools down.

When you set the temperature to the lower or upper limit, **Lo** or **Hi** is displayed.

Pressing the **ON/OFF** button switches the climate control system between on and off. When turned on, the system returns to your last selection.

When you unlock the doors with your remote, the driver's ID (**Driver 1** or **Driver 2**) is detected, and the climate control settings are turned to the respective mode automatically when you set the power mode to ON.

The High Voltage battery level being low may reduce the climate control system performance.

■ Operating from the On Demand Multi-Use Display™

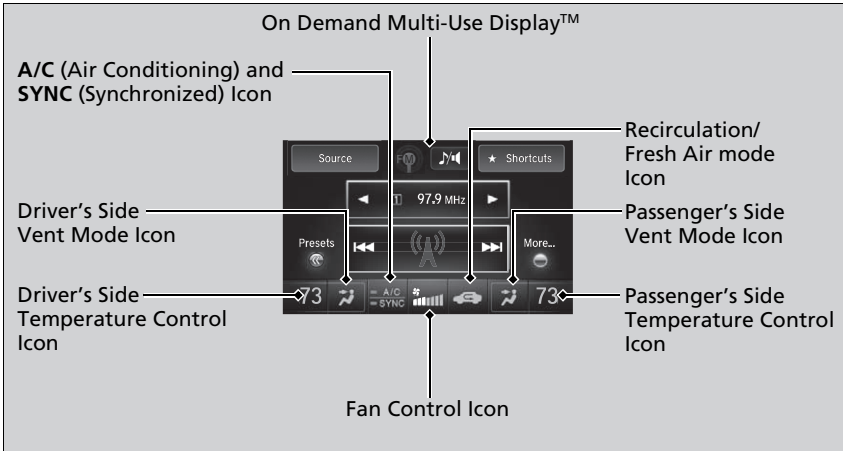

▣ Using Automatic Climate Control

You can store two customized climate control settings to the system and recall them from the On Demand Multi-Use Display™.

➤ **Shortcuts** P. 218

■ Changing the interior temperature setting

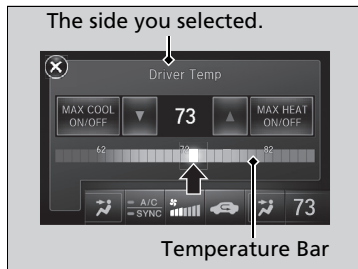

1. Select the driver's or passenger's side temperature control.
2. Change the temperature setting from the following:

Temperature bar: Select a point where your desired temperature setting is. Farther to the left is for a lower, and to the right for a higher setting.

▲/▼: To raise or lower the temperature setting one degree at a time.

While you select and hold **▲/▼**, the temperature decreases or increases.

MAX COOL ON/OFF: To rapidly cool down the interior.

- The AUTO indicator comes on. The setting returns to the previously selected value when you select it again.

MAX HEAT ON/OFF: To rapidly warm up the interior.

- The AUTO indicator comes on. The setting returns to the previously selected value when you select it again.

► Using Automatic Climate Control

When you set the temperature to the lower or upper limit, **Lo** or **Hi** is displayed.

When you set the **MAX COOL** or **MAX HEAT**, **MAX COOL** or **MAX HEAT** is displayed.

■ Switching the vent mode



1. Select the driver's or passenger's side vent mode.
2. Select a desired vent mode icon, or **Driver Mode Auto** (driver's side)/**Passenger Mode Auto** (passenger's side): The system automatically selects the vent mode most suitable to the ambient environment.

Vent mode



: Dashboard vents and back of the center console



: Dashboard and floor vents, and back of the center console



: Floor vents



: Floor and defroster vents (driver's side only)

■ A/C on and off

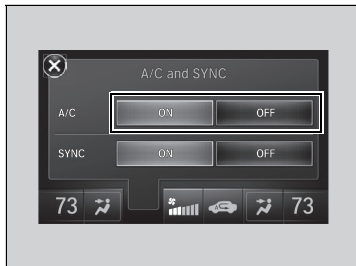

1. Select **A/C**.
2. Select **ON** or **OFF**.

Switching the vent mode

While the climate control system is in auto, **Driver Mode Auto** or **Passenger Mode Auto** is highlighted.

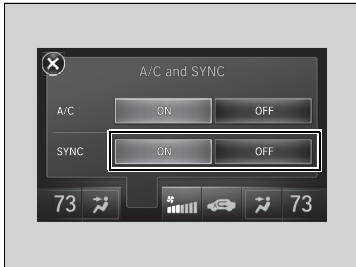

■ SYNC on and off

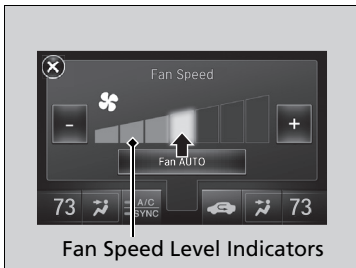

1. Select **SYNC**.
2. Select **ON** for synchronization mode, and **OFF** for dual mode.
 - When in synchronization mode, the passenger's side temperature and vent mode become the same as the driver's side settings.
3. Adjust the temperature or change the mode from the driver's side.

■ Changing the fan speed



1. Select .
2. Change the fan speed with one of the following:
 - The fan speed level indicators: Select your desired speed level. The smaller indicator is for a slower speed, and the larger for a faster speed.
 - /: To go up or down one level at a time.
 - Fan AUTO:** The system automatically selects the fan speed most suitable to the ambient environment.

» SYNC on and off

When you press the  button, the system changes to synchronization mode.

When the system is in dual mode, the driver's side temperature and vent mode, and the passenger's side temperature and vent mode can be set separately.

You can also return to dual mode by changing the passenger's side temperature or switching the vent mode.



The system adjusts each temperature based on the information of the sunlight sensor and the sun position updated by the navigation system's GPS.

» Changing the fan speed

While the climate control system is in auto, **Fan AUTO** is highlighted.

■ Switching between the recirculation and fresh air modes



1. Select ,  or  currently shown.
2. Switch the mode depending on environmental conditions to the following:

 (recirculation mode): Recirculates air from the vehicle's interior through the system.

 (auto mode): Automatically switch between the recirculation and fresh air modes most suitable to environmental conditions. If the ambient temperature is low, the mode may not change to recirculation to keep the windows from fogging up.

 (fresh air mode): Maintains outside ventilation. Keep the system in fresh air mode in normal situations.

Switching between the recirculation and fresh air modes

While the climate control system is in AUTO,  is highlighted.

Continued

■ Shortcuts

You can store two sets of your preferred temperature, fan speed, and vent mode settings to the climate control system.

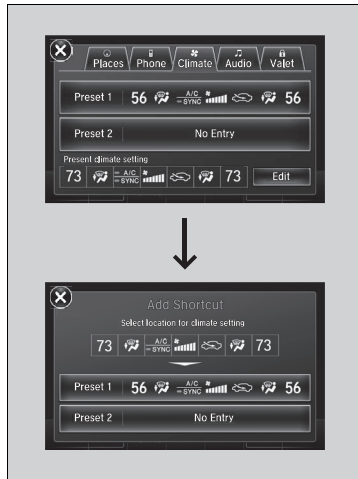

To store a set of the climate control settings:

1. Select **Shortcuts**.
2. Adjust the climate control system to your preference.
 - **Climate Control System** P. 200
3. Select **Climate**.
4. Select **Edit**.
5. Select **Add**.
6. Select **Preset 1** or **Preset 2** you want to store your settings to.

To recall one of the settings:

1. Select **Shortcuts**.
2. Select **Climate**.
3. Select **Preset 1** or **Preset 2**.

To delete a preset:

1. Select **Shortcuts**.
2. Select **Climate**.
3. Select **Edit**.
4. Select **Delete**.
5. Select **Preset 1** or **Preset 2** you want to delete.

► Shortcuts

You can also store a set by pressing and holding the preset number you want to store that setting after step 3.

Defrosting the Windshield and Windows

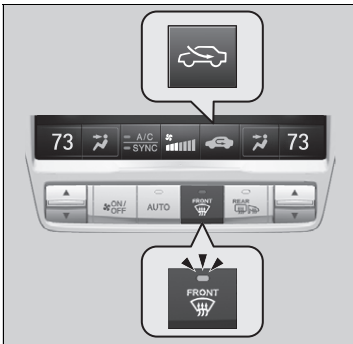

Pressing the  button turns the air conditioning system on and automatically switches the system to fresh air mode.

Press the  button again to turn off, the system returns to the previous settings.

To rapidly defrost the windows



1. Press the  button.
2. Select the recirculation mode.
 - **Switching between the recirculation and fresh air modes** P. 205

Defrosting the Windshield and Windows

For your safety, make sure you have a clear view through all the windows before driving.

Do not set the temperature near the upper or lower limit.

When cold air hits the windshield, the outside of the windshield may fog up.

If the side windows fog up, adjust the vents so that the air hits the side windows.

To rapidly defrost the windows

After defrosting the windows, switch over to fresh air mode.

If you keep the system in recirculation mode, the windows may fog up from humidity. This impedes visibility.

■ Rear Temperature Control Dial

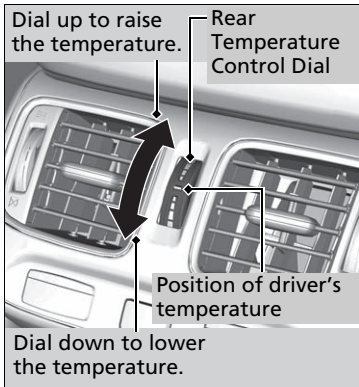

You can set the rear passenger compartment temperature different than the driver's, using the rear temperature control dial.

▣ Rear Temperature Control Dial

The rear temperature can be adjusted when the climate control system is on.

Automatic Climate Control Sensors

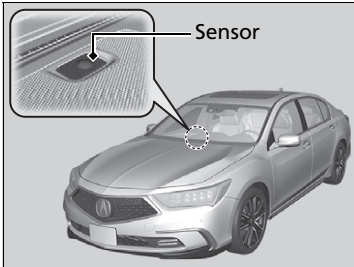

The automatic climate control system is equipped with sensors. Do not cover or spill any liquid on them.

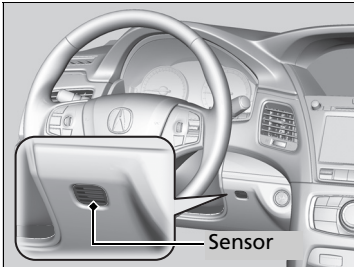

Features

This chapter describes how to operate technology features.

Audio System

About Your Audio System	212
USB Port	213
Auxiliary Input Jack	213
Audio System Theft Protection	214
Audio Remote Controls	215
Audio System Basic Operation	216
On Demand Multi-Use Display™	217
Audio/Information Screen	225
Adjusting the Sound	230
Display Setup	231
Voice Control Operation	232
Playing AM/FM Radio	237
Playing SiriusXM® Radio	242

Playing a CD	245
Playing Hard Disk Drive (HDD) Audio	248
Playing an iPod	258
Song By Voice™ (SBV)	262
Playing Internet Radio	266
Playing a USB Flash Drive	268
Playing <i>Bluetooth</i> ® Audio	271

Audio Error Messages

CD Player	273
Hard Disk Drive (HDD) Audio	274
iPod/USB Flash Drive	275
Pandora®	276

General Information on the Audio System

SiriusXM® Radio Service	277
-------------------------------	-----

Recommended CDs	278
Compatible iPod, iPhone, and USB Flash Drives	280
Honda App License Agreement	281
License Information	293
About Open Source Licenses	294
Customized Features	295
Defaulting All the Settings	319
Deleting all HDD Data	320
HomeLink® Universal Transceiver ...	321
Bluetooth® HandsFreeLink®	
Using HFL	324
HFL Menus	326
AcuraLink®	363

About Your Audio System

The audio system features AM/FM radio and SiriusXM® Radio service. It can also play audio CDs, WMA/MP3/AAC files, Hard Disk Drive (HDD) audio, USB flash drives, and iPod, iPhone and *Bluetooth*® devices.

You can operate the audio system from the buttons and switches on the panel, the remote controls on the steering wheel, or the icons on the On Demand Multi-Use Display™.

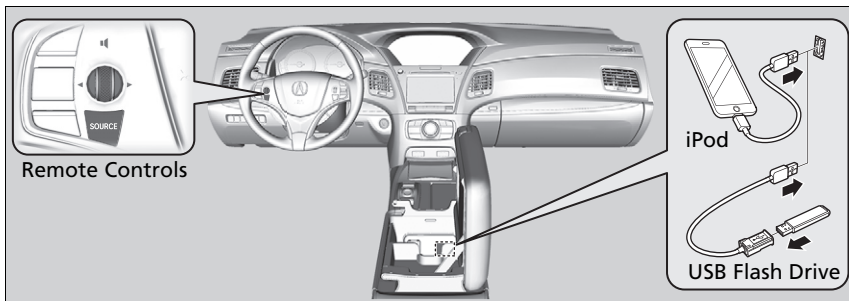

About Your Audio System

SiriusXM® Radio is available on a subscription basis only. For more information on SiriusXM® Radio, contact a dealer.

General Information on the Audio System P. 277

SiriusXM® Radio is available in the United States and Canada, except Hawaii, Alaska, and Puerto Rico.

SiriusXM® is a registered trademark of SiriusXM Radio, Inc.

Video CDs, DVDs, and 3-inch (8-cm) mini CDs are not supported.

iPod, iPhone and iTunes are trademarks of Apple Inc.

State or local laws may prohibit the operation of handheld electronic devices while operating a vehicle.

When the screen is viewed through polarized sunglasses, a rainbow pattern may appear on the screen due to optical characteristics of the screen. If this is disturbing, please operate the screen without polarized sunglasses.

USB Port

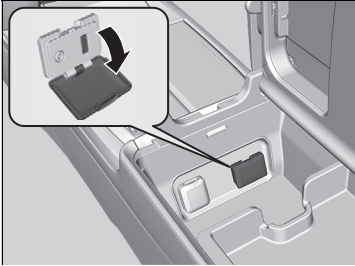

Install the iPod USB connector or the USB flash drive to the USB port.

⌘ USB Port

- Do not leave the iPod or USB flash drive in the vehicle. Direct sunlight and high temperatures may damage it.
- We recommend using an extension cable with the USB port.
- Do not connect the iPod or USB flash drive using a hub.
- Do not use a device such as a card reader or hard disk drive, as the device or your files may be damaged.
- We recommend your data backed up before using the device in your vehicle.
- Displayed messages may vary depending on the device model and software version.

If the audio system does not recognize the iPod, try reconnecting it a few times or reboot the device. To reboot, follow the manufacturer's instructions provided with the iPod or visit www.apple.com/ipod.

Auxiliary Input Jack

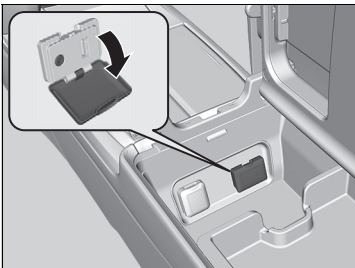

Use the jack to connect standard audio devices.

1. Open the **AUX** cover.
2. Connect a standard audio device to the input jack using a 1/8 inch (3.5 mm) stereo miniplug.
 - ▶ The audio system automatically switches to the AUX mode.

⌘ Auxiliary Input Jack

You can return to the AUX mode by selecting **Change Source** on the **Audio menu** screen or **Source** on the On Demand Multi-Use Display™.

Audio System Theft Protection

The audio system is disabled when it is disconnected from the power source, such as when the 12-volt battery is disconnected or goes dead. In certain conditions, the system may display a code entry screen. If this occurs, reactivate the audio system.

■ Reactivating the audio system

1. Set the power mode to ON.
2. Turn on the audio system.
3. Press and hold the audio system power button for more than two seconds.
 - ▶ The audio system is reactivated when the audio control unit establishes a connection with the vehicle control unit. If the control unit fails to recognize the audio unit, you must go to a dealer and have the audio unit checked.

Audio Remote Controls

Allows you to operate the audio system while driving. The information is shown on the multi-information display or head-up display.

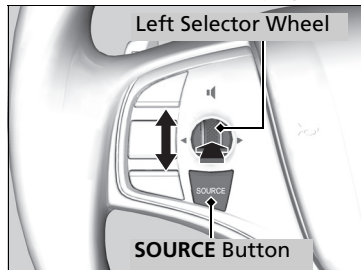

SOURCE Button

Cycles through the audio modes as follows:
 FM→AM→SiriusXM®→CD→HDD→USB→
 iPod→*Bluetooth*® Audio→Pandora®*→AUX

Left Selector Wheel

Roll Up: To increase the volume.

Roll Down: To decrease the volume.

Push: To mute. Push again to unmute.

- When listening to the radio
 - Move to the right:** To select the next preset radio station.
 - Move to the left:** To select the previous preset radio station.
 - Move to the right and hold:** To select the next strong station.
 - Move to the left and hold:** To select the previous strong station.
- When listening to a CD, HDD, iPod, USB flash drive, or *Bluetooth*® Audio
 - Move to the right:** To skip to the next song.
 - Move to the left:** To go back to the beginning of the current or previous song.
 - Move to the right and hold:** To go to the group up. (*Bluetooth*® Audio only)
 - Move to the left and hold:** To go to the group down. (*Bluetooth*® Audio only)
- When listening to a CD, HDD or USB flash drive
 - Move to the right and hold:** To skip to the next folder.
 - Move to the left and hold:** To go back to the previous folder.
- When listening to Pandora®*
 - Move to the right:** To skip to the next song.
 - Move to the right and hold:** To select the next station.
 - Move to the left and hold:** To select the previous station.

* Not available on all models

Audio Remote Controls

Some mode appears only when an appropriate device or medium is used.

To use the audio system function, the power mode must be in ACCESSORY or ON.

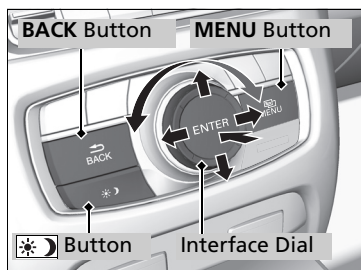



Use the interface dial or **MENU** button to access some audio functions.

Press  to switch between the normal and extended display for some functions.

Interface dial: Rotate left or right to scroll through the available choices. Press to set your selection. Move right, left, up or down to select a secondary menu.

MENU button: Press to select any mode. The available mode includes **Sound**, **Change Source**, **Refresh Station List**, **Save Preset**, **Radio Text**, **Music Search**, and play modes. Play modes can be also selected from **Scan**, **Random/Repeat**, and so on.

BACK button: Press to go back to the previous display.

 **(Day/Night) button:** Press to change the audio/information screen brightness. Press  once and make an adjustment using the interface dial.

- ▶ Each time you press , the mode switches between the daytime mode, nighttime mode and off mode.

Audio System Basic Operation

Voice Control System





The navigation system is voice operable.

▶ **Voice Control Operation** P. 232

These indications are used to show how to operate the interface dial.

Rotate  to select.

Press  to enter.

Move , ,  or  to select a secondary menu.

Audio Menu Items

▶ **Sound** P. 230

▶ **Refresh Station List** P. 239

▶ **Save Preset** P. 238, 244

▶ **Radio Text** P. 240

▶ **Music Search** P. 246, 250, 260, 269

▶ **Scan** P. 240, 247, 251, 270

▶ **Random/Repeat** P. 247, 251, 261, 270

When you unlock the doors with your remote, the driver's ID (**Driver 1** or **Driver 2**) is detected, and the audio system settings and preset memory are turned to the respective mode automatically when you set the power mode to ON.

On Demand Multi-Use Display™

Use the On Demand Multi-Use Display™ to operate the audio system.

Selecting an Audio Source

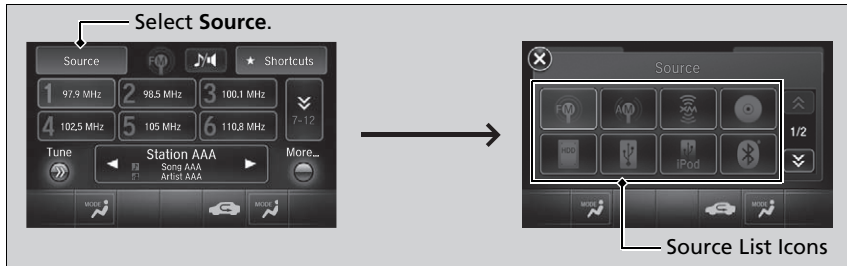

Select **Source**, then select an icon on the source list to switch the audio source.

Displaying the Menu Items

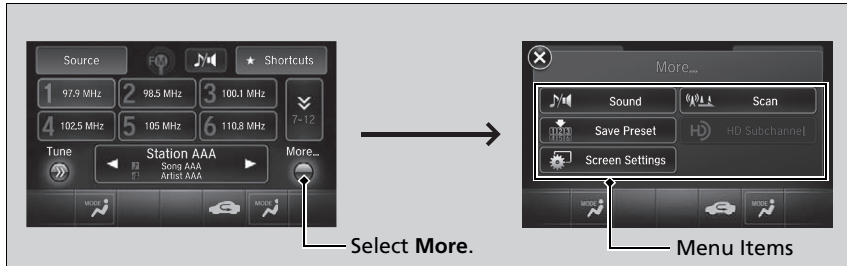

Select **More** to display the menu items.

On Demand Multi-Use Display™

Icons that appear on the screen vary by the source selected.

Select to go back to the previous screen.

Use the </>/ icons to turn the page.

Selecting an Audio Source

You can change the order of source icons displayed.



1. Select **Source**, , then **Edit Order**.

2. Select two icons, then select **Done**.

The locations of these icons are switched.

To go back to the original display order, select **Default**.

Shortcuts

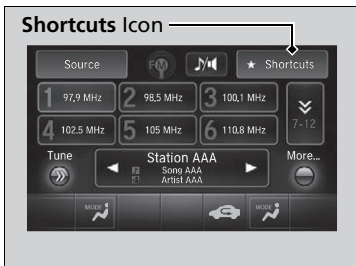

You can preset the settings of four categories (**Places, Phone, Climate, Audio**) from **Shortcuts**.

Shortcuts

The preset memory is cleared when it is disconnected from the power source, such as when the 12-volt battery is disconnected or goes dead.

■ Places

You can store up to six addresses, and the home address for your preset destinations.

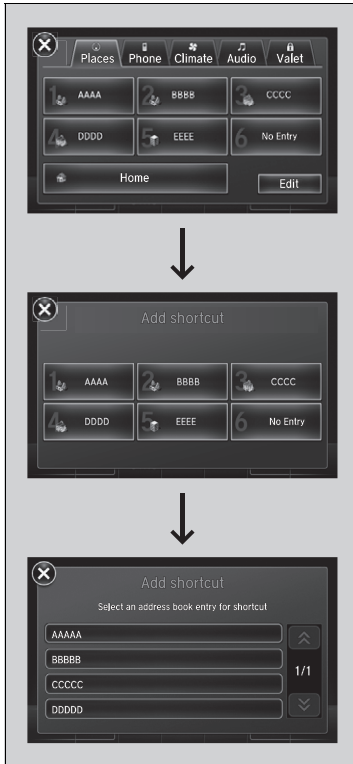

To store an address on the selected preset number:

1. Select **Shortcuts**.
2. Select **Places**.
3. Select **Edit** or **No Entry**.
 - ▶ If you select **No Entry**, go to step 6.
4. Select **Add**.
 - ▶ All the six preset icons appear.
5. Select the preset number to which you want to store an address.
6. The screen changes to a list of addresses stored in your address book.
7. Select an address you want to store as a preset.

To enter one of the preset addresses, or **Home** as your destination:

1. Select **Shortcuts**.
2. Select **Places**.
3. Select a preset number or **Home**.
 - ▶ The system starts to calculate the route to your selected destination.

▶▶ Places

See the Navigation System Manual for how to store address book entries, and enter your home address.

To delete a preset address:

1. Select **Shortcuts**.
2. Select **Places**.
3. Select **Edit**.
4. Select **Delete**.
5. Select the preset number with the destination you want to delete.

■ Phone

You can preset five speed dial entries, and make a call from one of the preset numbers, or call history when the phone is paired and connected to the vehicle's *Bluetooth*® HandsFreeLink® (HFL) system. ▶ **Phone Setup** P. 330

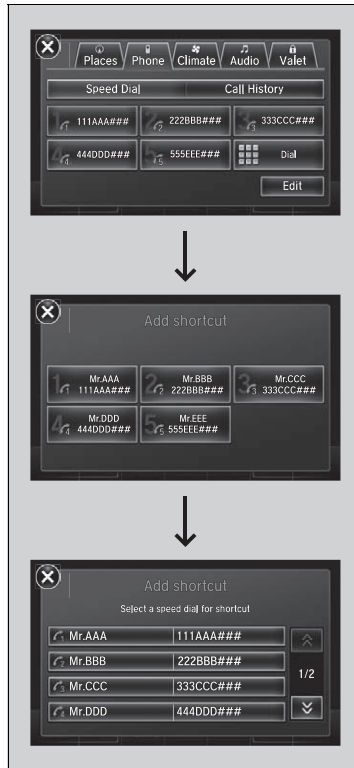

To preset a speed dial:

1. Select **Shortcuts**.
2. Select **Phone**.
3. Select **Speed Dial**.
4. Select **Edit** or **No Entry**.
 - ▶ If you select **No Entry**, go to step 6.
5. Select **Add**.
 - ▶ Five presets appear. Select a **No Entry** preset or an existing preset.
 - ▶ The screen changes to a list of previously stored speed dial entries.
6. Select a number you want to store as a shortcut.

To make a call from a speed dial entry:

1. Select **Shortcuts**.
2. Select **Phone**.
3. Select **Speed Dial**.
4. Select a preset number.
 - ▶ Dialing starts automatically.

☒ Phone

Dial icon

You can make a call using the keyboard on the On Demand Multi-Use Display™ to input numbers.

- ▶ **To make a call using a phone number**
P. 351

To delete a speed dial:

1. Select **Shortcuts**.
2. Select **Phone**.
3. Select **Speed Dial**.
4. Select **Edit**.
5. Select **Delete**.
6. Select the preset number with the phone number you want to delete.



To make a call from call history:

1. Select **Shortcuts**.
2. Select **Phone**.
3. Select **Call History**.
4. Select a phone number.
 - ▶ Dialing starts automatically.

☒ Phone

The call history displays the last six dialed, received, or missed calls.

■ Audio

You can store up to six radio stations, and HDD audio album/play lists when playing AM, FM, or SiriusXM® radio, or HDD audio.

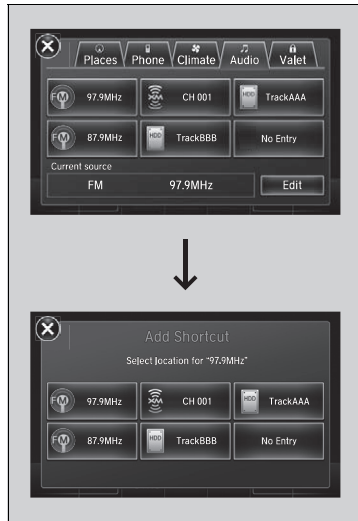

To preset a station or song:

1. Tune to a radio station or select a song from HDD audio.

▶ **Playing AM/FM Radio** P. 237

▶ **Playing SiriusXM® Radio** P. 242

▶ **Playing Hard Disk Drive (HDD) Audio**
P. 248

2. Select **Shortcuts**.
3. Select **Audio**.
4. Select **Edit** or **No Entry**.
▶ If you select **No Entry**, go to step 6.
5. Select **Add**.
6. Select the preset icon you want to store the station or song to.

To play a preset station or song:

1. Select **Shortcuts**.
2. Select **Audio**.
3. Select a preset icon.

To delete a preset station or song:

1. Select **Shortcuts**.
2. Select **Audio**.
3. Select **Edit**.
4. Select **Delete**.
5. Select the preset icon with the radio station or a song you want to delete.

▶▶ Audio

You can also preset a station or song by pressing and holding the preset icon you want to store that station or song after step 3.

■ Adjusting the Sound

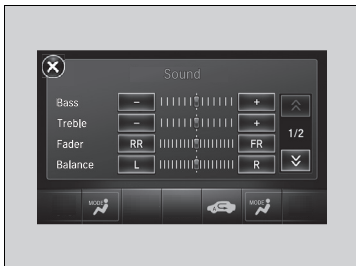

1. Select **More**, then **Sound**.
2. Use **+**, **-** or other icons to adjust the setting.

■ Changing the Screen Settings

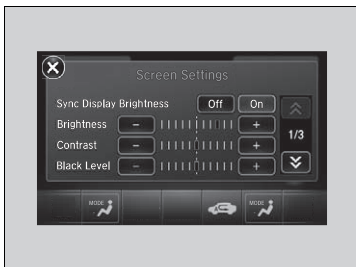

1. Select **More**, then **Screen Settings**.
2. Use **+**, **-** or other icons to adjust the setting.

▶▶ Adjusting the Sound

Select **Off**, **Low**, **Mid** or **High** for the SVC setting.
 ▶▶ **Adjusting the Sound** P. 230

Instead of using **+**, **-** or icons, you can also touch the point where your desired setting is.

You can also adjust the sound by selecting  on the On Demand Multi-Use Display™.

▶▶ Changing the Screen Settings

The following are adjustable screen settings:

- **Sync Display Brightness**
Selects whether the screen brightness synchronizes with the instruments panel brightness.
- **Brightness**
- **Contrast**
- **Black Level**
- **Display**
Changes between the daytime or nighttime modes.
- **Beep**
Mutes a beep that sounds every time you touch the screen.
- **Keyboard**
Changes the on-screen keyboard from the alphabetical order to the qwerty type.
- **Vibration**
Turns on and off the vibration when you touch the screen.
- **Fade Timer**
Sets the screen black out timing.

Instead of using **+**, **-** or icons, you can also touch the point where your desired setting is.

Audio/Information Screen

Displays the audio status and wallpaper. From this screen, you can go to various setup options.

Switching the Display

Press the **NAV**, **PHONE**, **INFO** and **AUDIO** buttons to go to the corresponding display.

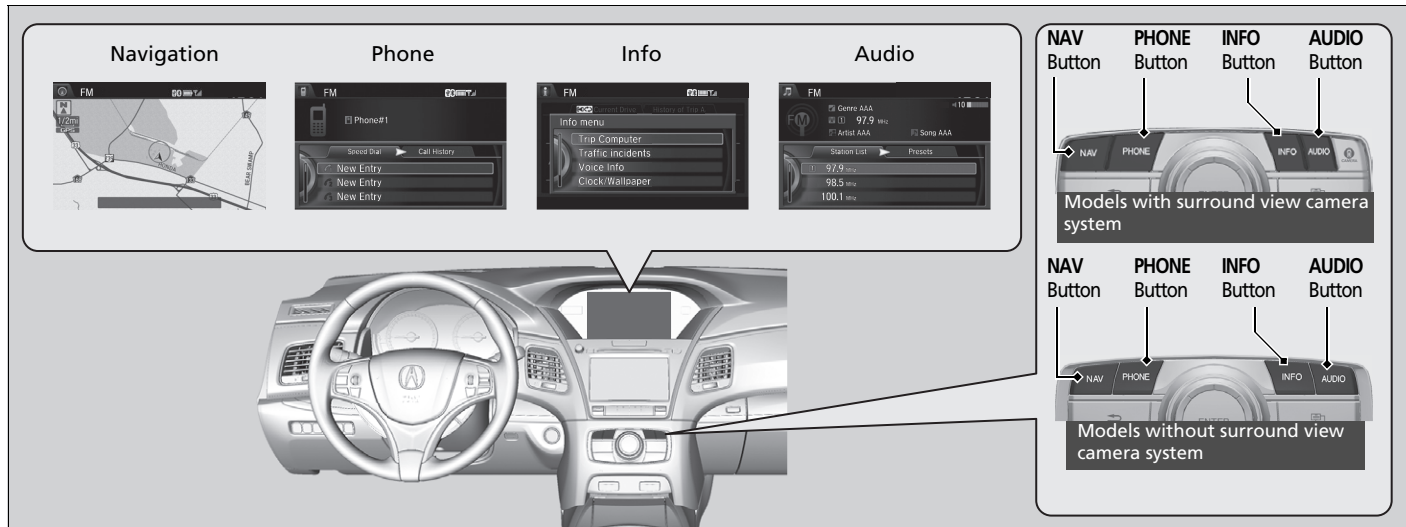

■ Audio

Shows the current audio information.

■ Navigation

Shows the navigation screen.  **Refer to the Navigation System Manual**

■ Phone

Shows the HFL information.  **Bluetooth® HandsFreeLink®** P. 324

■ Info

Shows the **Trip Computer** or **Clock/Wallpaper** and other information. Rotate  to select an item, then press .





■ Trip computer (Current Drive)

Shows the range, instant and average fuel economy, and EV/total drive of the current trip, as well as the average fuel economy from your last trip.

■ Trip computer (History of Trip A)

Shows the range, average fuel economy and distances traveled for the current trip, as well as the average fuel economy and distances traveled during the last three driving cycles. Each time you reset the trip meter A, the information on the display updates. The history of the previous three driving cycles is kept.

■ Deleting the history manually

1. Move  on the **History of Trip A** screen to select **Delete History**, then press .
2. You will receive a confirmation message on the screen. Rotate  to select **Yes**, then press .

■ Clock/Wallpaper

Shows a clock screen or an image you import.

■ Power Distribution Monitor

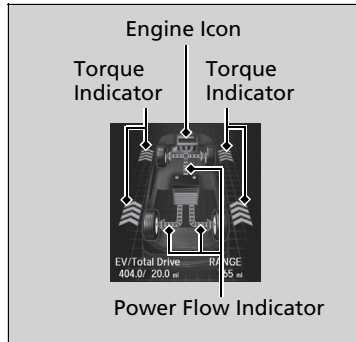

Consists of two monitoring displays, one that indicates the vehicle's power flow, and the other, the torque distribution.

⊞ Power Distribution Monitor

The power distribution monitor is also displayed on the head-up display. See **Power Distribution Monitor** on P. 124 for details.

While the vehicle is stationary with the engine running, the following may appear on the display.

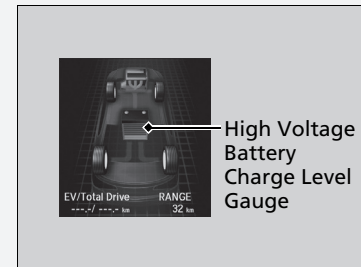

The High Voltage battery charge level gauge shows the current High Voltage battery charge level. The amount shown here is the same level as the gauge amount shown in the instrument panel.

➤ **High Voltage Battery Charge Level Gauge**
P. 113

■ Wallpaper Setup

You can change, store, and delete the wallpaper on the audio/information screen.

■ Import wallpaper

You can import up to three images, one at a time, for wallpaper from a USB flash drive.



1. Connect the USB flash drive to the USB port.

▶ **USB Port P. 213**

2. Press the **SETTINGS** button.

3. Rotate to select **System Settings**, then press .

4. Move or to select the **Clock** tab.

5. Rotate to select **Clock/Wallpaper Type**, then press .

6. Move to select **Wallpaper**.

▶ The screen will change to the wallpaper list.

7. Move to select **Add New Wallpaper**, then press .

8. Rotate to select a desired picture.

▶ The preview is displayed on the left side on the screen.











9. Press , then move to select **Start Import**.

▶ The confirmation message will appear. Then the display will return to the wallpaper list.















▶▶ Wallpaper Setup

- When importing wallpaper files, the image must be in the USB flash drive's root directory. Images in a folder cannot be imported.
- The file name must be fewer than 64 characters.
- The file format of the image that can be imported is BMP (bmp) or JPEG (jpg).
- The individual file size limit is 6 MB.
- The maximum image size is 1,680 x 936 pixels. If the image size is less than 420 x 234 pixels, the image is displayed in the middle of the screen with the extra area appearing in black.
- Up to 255 files can be selected.
- If the USB flash drive does not have any pictures, the **No files detected** message appears.



■ Select wallpaper

1. Press the **SETTINGS** button.
2. Rotate  to select **System Settings**, then press .
3. Move  or  to select the **Clock** tab.
4. Rotate  to select **Clock/Wallpaper Type**, then press .
5. Move  to select **Wallpaper**.
 - ▶ The screen changes to the wallpaper list.
6. Rotate  to select a desired wallpaper.
 - ▶ The preview is displayed on the left side on the screen.
7. Press .
 - ▶ The pop-up menu appears on the screen.
8. Rotate  to select **Set**, then press .
 - ▶ The display will return to the wallpaper list.

■ Delete wallpaper

1. Press the **SETTINGS** button.
2. Rotate  to select **System Settings**, then press .
3. Move  or  to select the **Clock** tab.
4. Rotate  to select **Clock/Wallpaper Type**, then press .
5. Move  to select **Wallpaper**.
 - ▶ The screen changes to the wallpaper list.
6. Rotate  to select a wallpaper that you want to delete, then press .
 - ▶ The preview is displayed on the left side on the screen.
7. Press .
 - ▶ The pop-up menu appears on the screen.
8. Rotate  to select **Delete**, then press .
 - ▶ The confirmation message will appear.
9. Rotate  to select **Yes**, then press  to delete completely.
 - ▶ The display will return to the wallpaper list.

Wallpaper Setup

From the pop-up menu, rotate  to select **Preview** and press  to see a preview at full-size screen.



To go back to the previous screen, press  to select **OK**, or press the **BACK** button.

When the file size is large, it takes a while to be previewed.

Adjusting the Sound

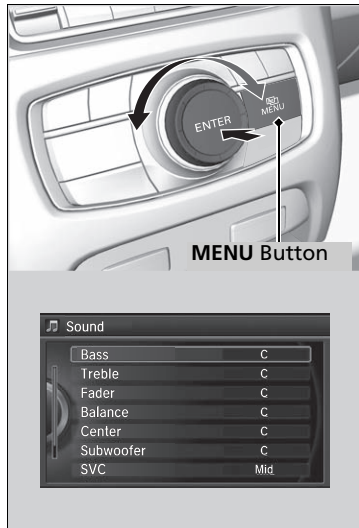

1. Press the **MENU** button.
2. Rotate to select **Sound**, then press .

Rotate to scroll through the following choices:

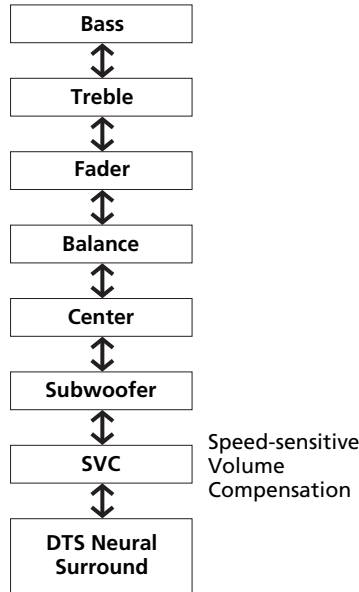

▶▶ Adjusting the Sound

The SVC has four modes: **Off**, **Low**, **Mid**, and **High**. SVC adjusts the volume level based on the vehicle speed. As you go faster, audio volume increases. As you slow down, audio volume decreases.

DTS Neural Surround is a trademark of DTS, Inc.

On Demand Multi-Use Display™

▶▶ **Adjusting the Sound** P. 224

Display Setup

You can change the brightness or color theme of the audio/information screen.

Changing the Screen Brightness

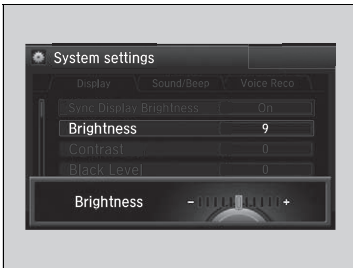

1. Press the **SETTINGS** button.
2. Rotate to select **System Settings**, then press .
3. Move or to select the **Display** tab.
4. Rotate to select **Brightness**, then press .
5. Rotate to adjust the setting.

Changing the Screen's Color Theme

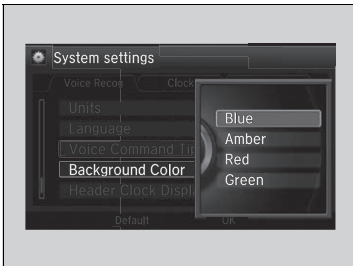



1. Press the **SETTINGS** button.
2. Rotate to select **System Settings**, then press .
3. Move or to select the **Others** tab.
4. Rotate to select **Background Color**, then press .
5. Rotate to select the setting you want, then press .

Changing the Screen Brightness

You can change the **Contrast** and **Black Level** settings in the same manner.

Voice Control Operation

Your vehicle has a voice control system that allows hands-free operation of most of the navigation system functions.

The voice control system uses the  (Talk) and  (hang-up/back) buttons on the steering wheel and a microphone near the map lights on the ceiling.

Voice Recognition

To achieve optimum voice recognition when using the voice control system:

- Make sure the correct screen is displayed for the voice command that you are using.



The system recognizes only certain commands. Available voice commands.

 **Voice Portal Screen** P. 233

- Close the windows and moonroof.
- Adjust the dashboard and side vents so air does not blow onto the microphone on the ceiling.
- Speak clearly in a clear, natural speaking voice without pausing between words.
- Reduce any background noise if possible. The system may misinterpret your command if more than one person is speaking at the same time.
- Refer to the Voice Help feature.

 **Refer to the Navigation System Manual**

Voice Control Operation

When you press the  button, a helpful prompt asks what you would like to do. Press and release the  button again to bypass this prompt and give a command.

Voice Recognition

The voice control system can only be used from the driver's seat because the microphone unit removes noises from the front passenger's side.

Voice Portal Screen

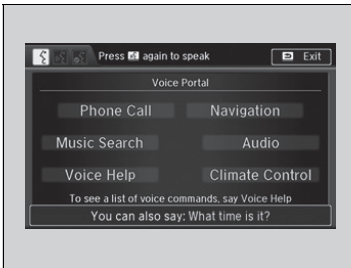

When the  (Talk) button is pressed, available voice commands appear on the screen.

For a complete list of commands, say “Voice Help” after the beep or select **Voice Help**.

You can see the list of commands in **Voice Info** on the Info menu screen. Select **Info**, then select .

The system only recognizes the commands on the following pages, at certain screens. Free form voice commands are not recognized.

Phone Call

This can be only used when the phone is connected. When the system recognizes the *Phone call* command, the screen will change the dedicated screen for the voice recognition of the phone.

- Call <Your Contact Name>
- Call <Phone Number>

Music Search

This can be only used when the iPod or HDD device is connected.

Voice Help

You can see a list of the available commands on the screen.

- Navigation Commands
- Useful Commands
- Phone Commands
- Audio Commands
- On Screen Commands
- Music Search Commands
- General Commands
- Climate Control Commands
- All Commands
- Voice Settings
- Getting Started

Navigation

The screen changes the navigation screen.

- ▶ Refer to the Navigation System Manual

■ Audio

When the system recognizes the *Audio* command, the screen will change the dedicated screen for the voice recognition of the audio.

- *Audio On**¹
- *Audio Off**¹
- *FM*
- *AM*
- *SXM*
- *Disc*
- *HDD*
- *USB*
- *iPod*
- *Bluetooth*[®] *Audio*
- *Pandora**
- *AUX*

➤ **Audio Commands** P. 235

*1: These commands toggle the function on and off, so the command may not match your intended action.

■ Climate Control

The screen changes the climate control screen.

➤ **Climate Control Commands** P. 236

■ Useful Commands

The system accepts these commands on the voice portal top screen.

- *Call <Your Contact Name>*
- *Call <Phone Number>*
- *What time is it?*
- *What is today's date?*

■ Phone Commands

The system accepts these commands on the dedicated screen for the voice recognition of the phone.

- *Call <Your Contact Name>*
- *Call <Phone Number>*

Audio Commands

The system accepts these commands on the dedicated screen for the voice recognition of the audio.

Radio FM Commands

- *Radio tune to <87.7-107.9> FM*
- *Radio FM preset <1-12>*

Radio AM Commands

- *Radio tune to <530-1710> AM*
- *Radio AM preset <1-6>*

Radio SXM Commands

- *SXM channel <0-999>*
- *Radio SXM preset <1-12>*

Disc Commands

- *Disc play*
- *Disc play track <1-30>*

HDD Commands

- *HDD play*
- *HDD play track <1-30>*
- *Music Search*
- *What album is this?*
- *What am I listening to?*

* Not available on all models

iPod Commands

- *iPod play*
- *iPod play track <1-30>*
- *Music Search*
- *What album is this?*
- *What am I listening to?*

USB Commands

- *USB play*
- *USB play track <1-30>*

Bluetooth® Audio Commands

- *Bluetooth® Audio play*

NOTE:

Bluetooth® Audio commands may not work on some phones or *Bluetooth®* Audio devices.

Pandora Commands*

- *Pandora play*

AUX Commands

- *AUX play*

On Screen Commands

The system accepts the voice command operation of the voice recognition screen.

■ Music Search Commands

The system accepts these commands on the **Music Search** screen.

■ Using Song By Voice

Song By Voice™ is a feature that allows you to select music from your iPod or HDD device using Voice Commands. To activate this mode, you must press the  (Talk) button and say: "Music Search".

■ Song By Voice Commands

- *Music Search*
- *What am I listening to?*
- *Who am I listening to?*
- *Who is this?*
- *What's playing?*
- *Who's playing?*
- *What album is this?*

■ Play Commands

- *Play artist <Name>*
- *Play album <Name>*
- *Play song <Name>*
- *Play composer <Name>*
- *Play genre <Name>*
- *Play playlist <Name>*

■ List Commands

- *List artist <Name>*
- *List album <Name>*
- *List composer <Name>*
- *List genre <Name>*
- *List playlist <Name>*

■ General Commands

- *What time is it?*
- *What is today's date?*

■ Climate Control Commands

The system accepts these commands on the **Climate control** screen.

- *Climate Control Automatic*
- *Climate Control On*¹*
- *Climate Control Off*¹*
- *Air conditioner On*¹*
- *Air conditioner Off*¹*
- *Defrost On*¹*
- *Defrost Off*¹*
- *Vent*
- *Dash and Floor*
- *Floor Vents*
- *Floor and Defrost*
- *Fan Speed Up*
- *Fan Speed Down*
- *Fan Speed <1-7>*
- *Temperature Up*
- *Temperature Down*
- *Temperature Max Heat*
- *Temperature Max Cool*
- *Temperature <57-87> Degrees (U.S.)*
- *Temperature <18-32> Degrees (Canada)*

*1: These commands toggle the function on and off, so the command may not match your intended action.

Playing AM/FM Radio

Audio/Information Screen
 Select to change a band or change an audio source.

Source
 Select to change a band or change an audio source.

(Power) Button
 Press to turn the audio system on and off.

VOL (Volume) Knob (Pushed out)
 Turn to adjust the volume.

Tune
 Select to switch to tune mode.

Skip/Seek Icons
 Select **◀◀** or **▶▶** to search up and down the selected band for a station with a strong signal.

Scan
 Select to sample each of the strongest stations on the selected band for 10 seconds.

BACK Button
 Press to go back to the previous display.

On Demand Multi-Use Display™

Preset Icons
 Select to store a station. To listen to a stored channel, select 1-6 (AM) or 1-12 (FM).

More
 Select to display the menu items.

Tune Up/Down Icons
 Select **◀** or **▶** to tune the radio frequency.

MENU Button
 Press to display the menu items.

Interface Dial/ENTER Button
 Press and turn to select preset radio stations. Move up, down, right and left to select secondary menu.

■ Preset Memory

To store a station:

Interface Dial

1. Tune to the selected station.
2. Move ◀ or ▶ to select the **Preset** tab.
3. Rotate 📻 to select the preset number you want to store the station.
4. Press and hold 🕒 for a few seconds.

You can also store that station by the following procedure.

1. Tune to the selected station.
2. Press the **MENU** button.
3. Rotate 📻 to select **Save Preset**, then press 🕒.
4. Rotate 📻 to select the preset number you want to store that station, then press 🕒.

On Demand Multi-Use Display™

1. Tune to the selected station.
2. Change the display to the preset screen.
3. Select and hold the preset number you want to store that station.

You can also store that station by the following procedure.

1. Tune to the selected station.
2. Select **More**.
3. Select **Save Preset**.
4. Select the preset number you want to store that station.

▶▶ Playing AM/FM Radio

You can control the AM/FM radio using voice commands.

▶ **Voice Control Operation** P. 232

The **ST** indicator appears on the display indicating stereo FM broadcasts.
Stereo reproduction in AM is not available.

Switching the Audio Mode

Press the **SOURCE** button on the steering wheel.

▶ **Audio Remote Controls** P. 215

You can also switch the mode by pressing the **MENU** button and selecting **Change Source** on the **Audio menu** screen.

You can store 6 AM stations and 12 FM stations into the preset memory.

Models with HD Radio™ feature

HD Radio Technology manufactured under license from iBiquity Digital Corporation. U.S. and Foreign Patents. HD Radio™ and the HD, HD Radio, and "Arc" logos are proprietary trademarks of iBiquity Digital Corp.



Radio Data System (RDS)

Provides text data information related to your selected RDS-capable FM station.

To find an RDS station from Station List



1. Move ◀ or ▶ to select the **Station List** tab.
2. Rotate ⌚ to select the station, then press ⌚.

Manual update

Updates your available station list at any time.

Rotate ⌚ to select **Refresh**, then press ⌚.

You can also update a station by the following procedure.

1. Press the **MENU** button while listening to an FM station.
2. Rotate ⌚ to select **Refresh Station List**, then press ⌚.

■ Radio text

Display the radio text information of the selected RDS station.

1. Press the **MENU** button.
2. Rotate  to select **Radio Text**, then press .

■ Scan

Samples each of the strongest stations on the selected band for 10 seconds.

Interface Dial

1. Press the **MENU** button.
 2. Rotate  to select **Scan**, then press .
- To turn off scan, press  to select **Cancel Scan**, or press the **BACK** button.

On Demand Multi-Use Display™





▶ **Playing AM/FM Radio** P. 237

To turn off scan, select **Stop Scan**.



■ HD subchannel

Displays the subchannel list when an HD Radio™ station is selected.

Interface Dial

1. Press the **MENU** button.
2. Rotate  to select **HD Subchannel**, then press .
3. Rotate  to select a channel from a list, then press .

On Demand Multi-Use Display™

Select the  or  when the subchannel number is displayed.

You can also select the channel by the following procedure.

1. Select **More**.
2. Select **HD Subchannel**.
3. Select the channel number.

Playing SiriusXM® Radio

Audio/Information Screen — Select to change an audio source.

Source — Select to change an audio source.

(Power) Button — Press to turn the audio system on and off.

VOL (Volume) Knob (Pushed out) — Turn to adjust the volume.

Tune — Select to switch to tune mode.

Skip/Seek Icons — Select **◀◀** or **▶▶** to the previous or next channel. In channel mode, select and hold to change the channel rapidly.

Scan — Select to sample each of the strongest stations on the selected band for 10 seconds.

BACK Button — Press to go back to the previous display.

On Demand Multi-Use Display™

Preset Icons — Select to store a station. To listen to a stored channel, select 1-12.

More — Select to display the menu items.

Category Up/Down Icons — Select **◀** or **▶** to display and select a SiriusXM® Radio category.

MENU Button — Press to display the menu items.

Interface Dial/ENTER Button — Press and turn to select preset radio stations. Move up, down, right and left to select secondary menu.





To Play the SiriusXM® Radio

1. Select the SiriusXM® mode.



➤ **Audio Remote Controls** P. 215

➤ **On Demand Multi-Use Display™** P. 217

Interface Dial





2. Press the **MENU** button.
3. Rotate  to select **Channel List**, then press .
4. Rotate  to select a channel from a list, then press .

On Demand Multi-Use Display™

2. Select a channel using the , , ,  icons on the tune mode screen or the preset numbers (**1-12**) on the preset mode screen.

To change the tune mode:

Interface Dial

1. Press the **MENU** button.
2. Rotate  to select **XM Tune Mode**, then press .
3. Rotate  to select **Channel Mode** or **Category Mode**, then press .

On Demand Multi-Use Display™

1. Select **More**.
2. Select **XM Tune Mode**.
3. Select **Channel Mode** or **Category Mode**.

▶▶ Playing SiriusXM® Radio

You can control the SiriusXM® radio using voice commands.

➤ **Voice Control Operation** P. 232

In the channel mode, all available channels are selectable. In the category mode, you can select a channel within a category (Jazz, Rock, Classical, etc.).

There may be instances when SiriusXM® Radio does not broadcast all the data fields (artist name, title). This does not indicate a problem with your audio system.

SiriusXM® Radio stations load in ascending order, which can take about a minute. Once they have loaded you will be able to scroll up or down to make your selections.

■ Preset Memory

To store a station:

Interface Dial

1. Tune to the selected station.
2. Move ◀○ or ○▶ to select the **Preset** tab.
3. Rotate 📻 to select the preset number you want to store the station.
4. Press and hold 📻 for a few seconds.

You can also store that station by the following procedure.

1. Tune to the selected station.
2. Press the **MENU** button.
3. Rotate 📻 to select **Save Preset**, then press 📻.
4. Rotate 📻 to select the preset number you want to store that station, then press 📻.

On Demand Multi-Use Display™

1. Tune to the selected station.
2. Change the display to the preset screen.
3. Select and hold the preset number you want to store that station.

You can also store that station by the following procedure.

1. Tune to the selected station.
2. Select **More**.
3. Select **Save Preset**.
4. Select the preset number you want to store that station.

▶▶ Playing SiriusXM® Radio

You can store 12 SiriusXM® stations into the preset memory.

Playing a CD

Your audio system supports audio CDs, CD-Rs and CD-RWs in either MP3, WMA, or AAC*1 format. With the CD loaded, select the CD mode.

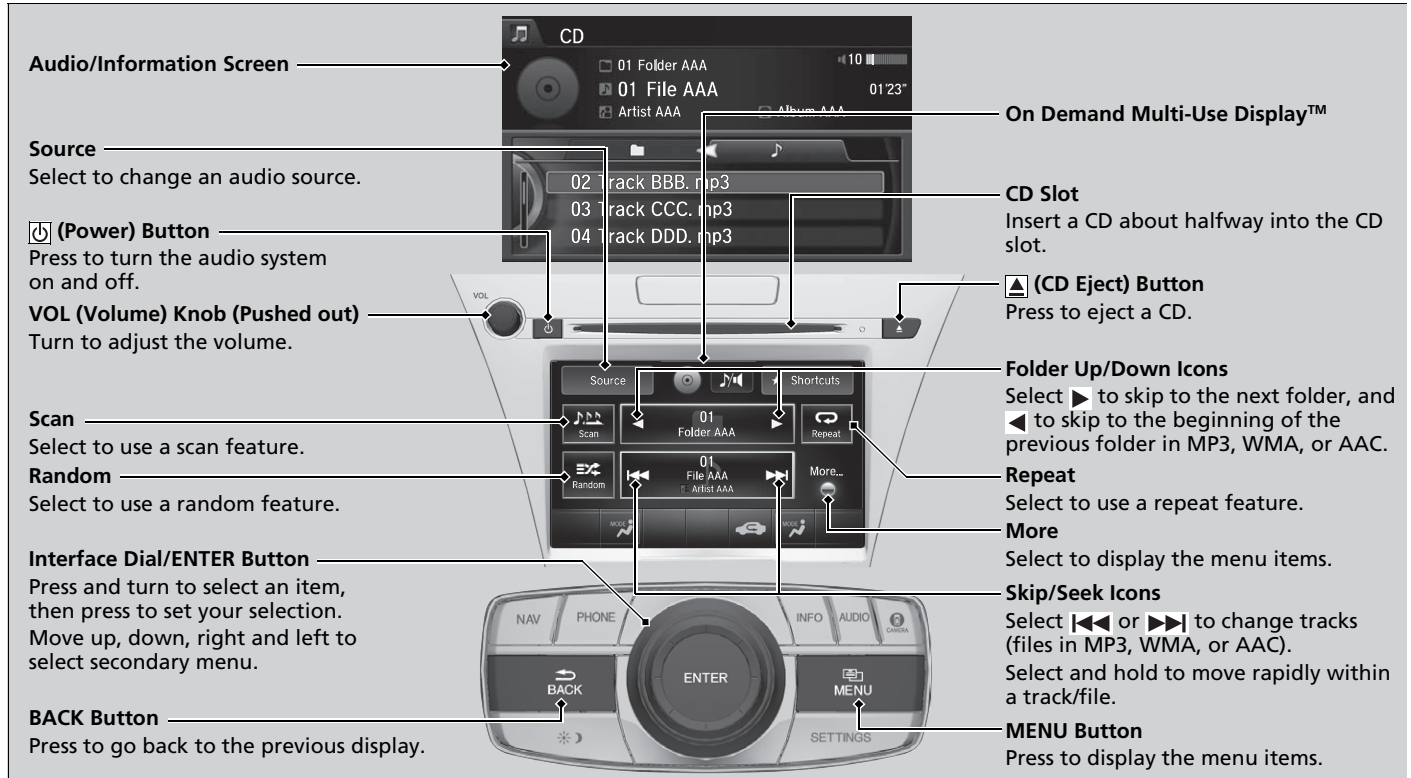

*1: Only AAC format files recorded with iTunes are playable on this unit.

How to Select a File from the Music Search List (MP3/WMA/AAC)



Folder Selection

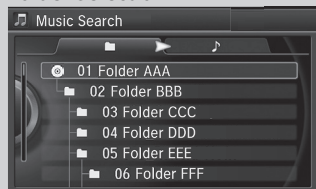

File Selection



1. Press the **MENU** button.
2. Rotate to select **Music Search**, then press .
3. Rotate , move or , then press to select a file from the **Music Search** list.

You can also select a file by the following procedure.

1. Rotate or press to display the song list.
2. Rotate , move or , then press to select a file from the list.

▶▶ Playing a CD

NOTICE

Do not use CDs with adhesive labels. The label can cause the CD to jam in the unit.

WMA and AAC files protected by digital rights management (DRM) cannot be played.

The audio system displays **Unplayable File**, then skips to the next file.

Text data appears on the display under the following circumstances:

- When you select a new folder, file, or track.
- When you change the audio mode to CD.
- When you insert a CD.

If you eject the CD but do not remove it from the slot, the system reloads the CD automatically after several seconds.

You can control a CD audio using voice commands.

Voice Control Operation P. 232

How to Select a Play Mode

You can select scan, repeat, and random modes when playing a track or file.



Interface Dial

1. Press the **MENU** button.
2. Rotate to select **Scan** or **Random/Repeat**, then press .
3. Rotate to select a mode, then press .

On Demand Multi-Use Display™

1. Select **Scan**, **Random** or **Repeat**.
Playing a CD P. 245
2. Select a mode.

To turn off a play mode

Interface Dial

1. Press the **MENU** button.
2. Rotate to select the mode you want to turn off, then press .

On Demand Multi-Use Display™

1. Select **Scan**, **Random** or **Repeat**.
Playing a CD P. 245
2. Select the mode you want to turn off.

How to Select a Play Mode

Play Mode Menu Items

Scan

Scan Folders (MP3/WMA/AAC): Provides a 10-second sampling of the first file in each of the main folders.

Scan Tracks: Provides a 10-second sampling of all tracks on the CD (all files in the current folder in MP3, WMA, or AAC).

Random/Repeat

Repeat Folder (MP3/WMA/AAC): Repeats all files in the current folder.

Repeat Track: Repeats the current track/file.

Random in Folder (MP3/WMA/AAC): Plays all files in the current folder in random order.

Random All Tracks: Plays all tracks/files in random order.

Playing Hard Disk Drive (HDD) Audio

The Hard Disk Drive (HDD) Audio function plays tracks from music CDs that have been recorded onto the built-in HDD. You can arrange the tracks in playlists or play the tracks using various search methods.

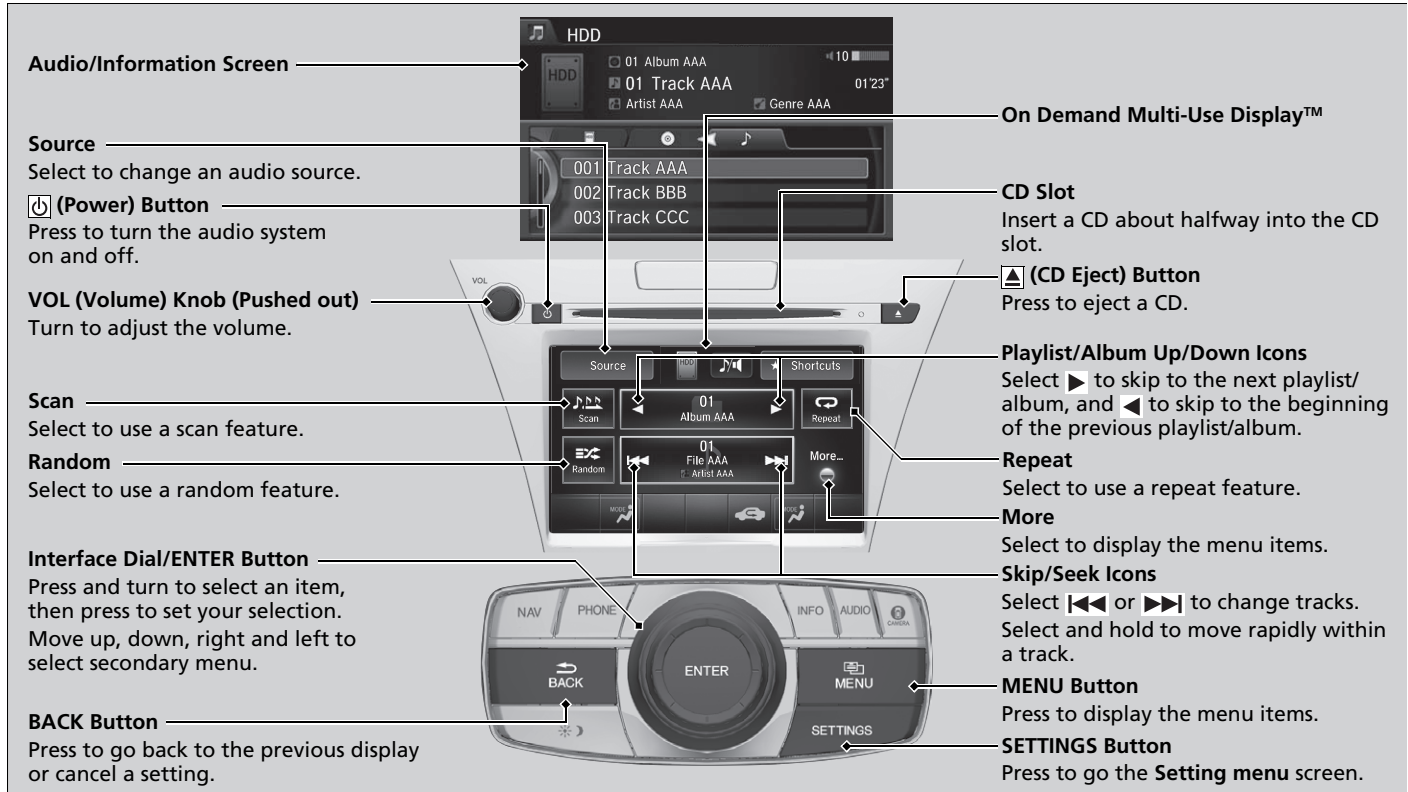

Recording a Music CD to HDD

When **Recording from CD** is set to **Auto**, the songs on music CDs are automatically recorded to the HDD the first time you play each disc. You can then play the songs directly from the HDD.

➤ **Customized Features** P. 295

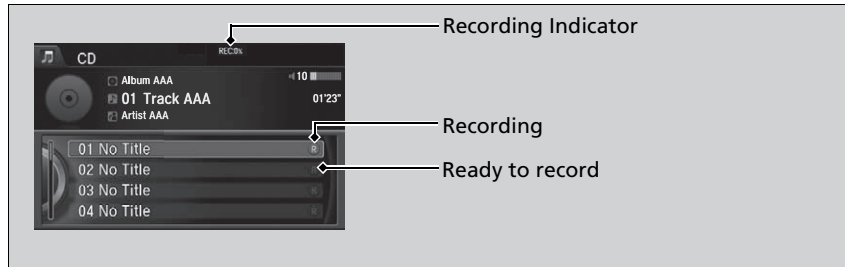

Stop Recording

1. Press the **MENU** button.
2. Rotate to select **Cancel Record to HDD**, then press .

Recording a CD Manually

When **Recording from CD** is set to **Manual**, the songs on music CDs can be manually recorded to the HDD.

1. Press the **MENU** button.
2. Rotate to select **Rec to HDD**, then press .

Recording a Music CD to HDD

You can add tracks to user playlists, where you can mix and match tracks from other CDs recorded on the HDD.

➤ **Editing an Album or Playlist** P. 252

➤ **Editing Track Information** P. 255

If you turn the power system off or the audio system is turned off while recording a CD, there may be pauses between songs when you play back from the HDD.

Repeat, random, and scan functions are not available during recording.

You can play music from other sources (e.g., SiriusXM®, HDD, etc.) while recording.

Please note that there is no compensation offered in the case of unsuccessful recording of audio data or the loss of audio data due to any cause whatsoever.

Clearing the HDD

Any music tracks stored on the HDD can be deleted.

➤ **Deleting all HDD Data** P. 320

How to Select a Track from the Music Search List

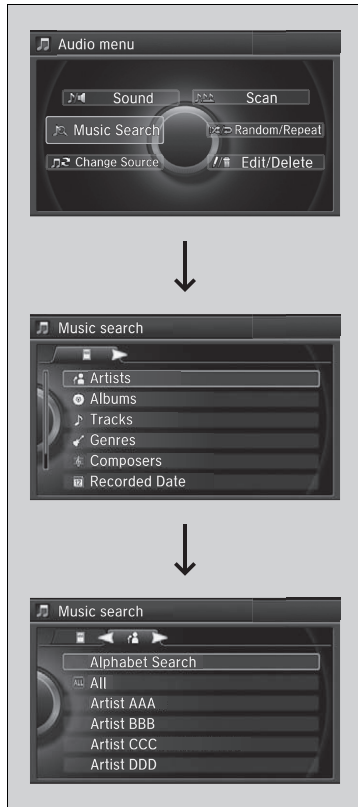

1. Press the **MENU** button.
2. Rotate to select **Music Search**, then press .
3. Rotate , move or , then press to select a track from the **Music Search** list.
 - ▶ Title information is displayed if found in the Gracenote® Album Info (Gracenote® Media Database) stored on the HDD.
 - ▶ The HDD has two types of playlists: original playlists and user playlists. An original playlist is automatically created for each album when a music CD is recorded. You can customize up to six user playlists provided on the HDD by adding tracks from your original playlists.

You can also select a track by the following procedure.

1. Rotate or press to display the song list.
2. Rotate , move or , then press to select a track from the list.

How to Select a Track from the Music Search List

You can control the HDD audio using voice commands.

- ▶ **Voice Control Operation** P. 232
- ▶ **Song By Voice™ (SBV)** P. 262

Music tracks recorded on HDD cannot be recorded onto CDs or other devices.

Tracks are recorded at four times the playback speed using ultra-efficient compression technology; therefore, sound quality may vary slightly from the original.

If the HDD is ever replaced, all music data is lost and cannot be recovered.

If there is a problem, you may see an error message on the display.

- ▶ **Hard Disk Drive (HDD) Audio** P. 274

How to Select a Play Mode

You can select scan, repeat, and random modes when playing a track.



Interface Dial

1. Press the **MENU** button.
2. Rotate to select **Scan** or **Random/Repeat**, then press .
3. Rotate to select a mode, then press .

On Demand Multi-Use Display™

1. Select **Scan**, **Random** or **Repeat**.
Playing Hard Disk Drive (HDD) Audio
 P. 248
2. Select a mode.

To turn off a play mode

Interface Dial

1. Press the **MENU** button.
2. Rotate to select the mode you want to turn off, then press .

On Demand Multi-Use Display™

1. Select **Scan**, **Random** or **Repeat**.
Playing Hard Disk Drive (HDD) Audio P. 248
2. Select the mode you want to turn off.

How to Select a Play Mode

Play Mode Menu Items

Scan

Scan Albums: Provides a 10-second sampling of the first track in each album.

Scan Tracks: Provides a 10-second sampling of all tracks on the HDD.

Random/Repeat

The following menu items vary depending on the category you selected by the **Music Search** list.

Repeat Artist: Repeats all tracks in the current artist.

Repeat Album: Repeats all tracks in the current album.

Repeat Track: Repeats the current track.

Random in Artist: Plays all tracks in the current artist in random order.

Random in Album: Plays all tracks in the current album in random order.

Random All Tracks: Plays all tracks in random order.

■ Editing an Album or Playlist

Change the playlist name, album name, genre, and track order of the current playlist. You can also delete tracks, playlists, and albums.



■ Editing an album

1. Press the **MENU** button.
2. Rotate to select **Edit/Delete**, then press .
3. Rotate to select **Albums**, then press .
 - ▶ The pop-up menu appears on the screen.
4. Rotate to select an album that you want to edit or delete, then press .
5. To edit an album name:
 - Rotate to select **Edit Name**, then press .
 - ▶ Enter the name using the interface dial or the On Demand Multi-Use Display™.

To delete an album:

Rotate to select **Delete**, then press .

To edit track information or delete a track:

Rotate to select **List Tracks**, then press .

▶ **Editing Track Information P. 255**

▶▶ Editing an Album or Playlist

The maximum number of songs in each of the six user playlists is 999. Adding new songs overwrites the oldest songs.

The maximum number of original playlists is 999 with a maximum of 99 songs in each playlist.

Each album CD counts as an original playlist. Adding a track from a user playlist into the same user playlist will cause the track to appear twice in the playlist.

Deleting an album (original playlist) also deletes the album tracks you have stored in any user playlists.

Deleting a user playlist or deleting all tracks from a user playlist does not remove the playlist folder. The folder retains the playlist name and artist information.



Select to enter symbols.

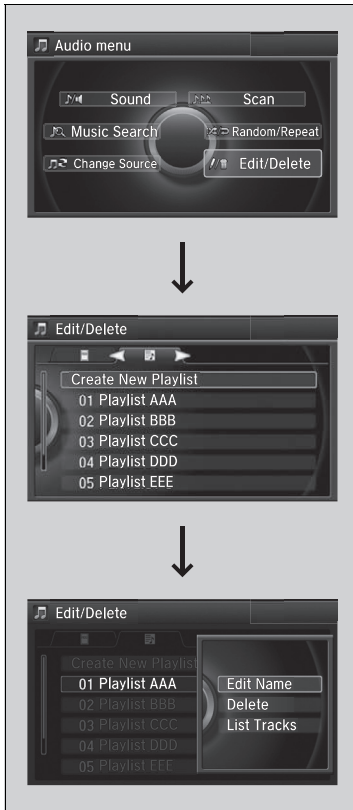

■ Editing a playlist

1. Press the **MENU** button.
2. Rotate to select **Edit/Delete**, then press .
3. Rotate to select **Playlists**, then press .
 - ▶ The pop-up menu appears on the screen.
4. Rotate to select a playlist that you want to edit or delete, then press .
5. To edit a playlist name:
 - Rotate to select **Edit Name**, then press .
 - ▶ Enter the name using the interface dial or the On Demand Multi-Use Display™.

To delete a playlist:

Rotate to select **Delete**, then press .





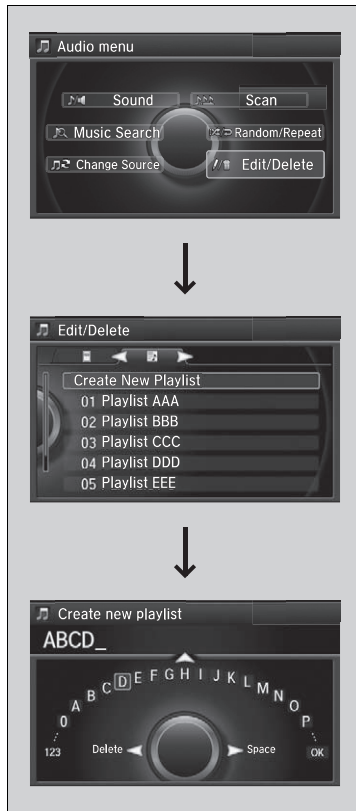

To edit track information or delete a track:

Rotate to select **List Tracks**, then press .

▶ **Editing Track Information** P. 255













■ Creating a new playlist

1. Press the **MENU** button.
2. Rotate  to select **Edit/Delete**, then press .
3. Rotate  to select **Playlists**, then press .
4. Rotate  to select **Create New Playlist**, then press .
 - ▶ Enter the name using the interface dial or the On Demand Multi-Use Display™, then select tracks from the **Music Search** list.

Editing Track Information

Change the track title, artist name, genre and composer. You can also delete tracks.



1. Press the **MENU** button.
2. Rotate  to select **Edit/Delete**, then press .
3. Rotate  to select **Tracks**, then press .
4. Rotate  to select a track you want to edit or delete, then press .
 - ▶ The pop-up menu appears on the screen.
5. To edit track information:
 - Rotate  to select **Edit Name**, then press .
 - ▶ Enter the track name, track artist, etc. using the interface dial or the On Demand Multi-Use Display™. Move , rotate  to select **OK**, then press .

To delete a track:

Rotate  to select **Delete**, then press .

Continued

■ Displaying Music Information

Music information (album name, artist name, genre) can be acquired by accessing the Gracenote® Album Info.



1. Press the **MENU** button.
2. Rotate to select **Edit/Delete**, then press .
3. Rotate to select **Albums**, then press .
4. Rotate to select an album you want to edit, then press .
 - ▶ The pop-up menu appears on the screen.
5. Rotate to select **Edit Name**, then press .
6. Move to select **Get Music Info**, then press .
 - ▶ The system starts to access the Gracenote® Album Info.

Updating Gracenote® Album Info

Update the Gracenote® Album Info (Gracenote® Media Database) that is included with the navigation system.

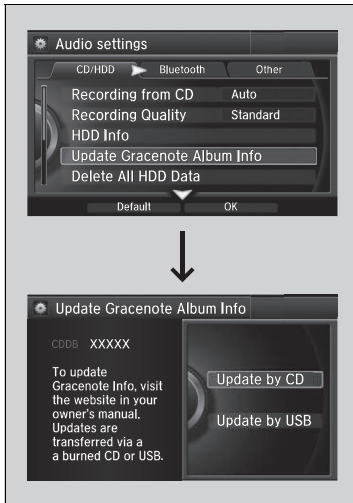

1. Insert the update disc into the disc slot or connect the USB flash drive that includes the update.
2. Press the **SETTINGS** button in the HDD mode.
3. Rotate to select **Audio Settings**, then press .
4. Move or to select the **CD/HDD** tab.
5. Rotate to select **Update Gracenote Album Info**, then press .
6. Rotate to select **Update by CD** or **Update by USB**, then press .
 - ▶ The system starts updating and the confirmation message appears on the screen. Press to finish.

Updating Gracenote® Album Info

To acquire updated files:

- Consult a dealer.
- U.S.: Visit www.acura.com.
- Canada: Visit www.acura.ca.

Once you perform an update, any information you edited before will be overwritten or erased.

Playing an iPod

Connect the iPod using your USB connector to the USB port, then select the iPod mode.

➤ **USB Port** P. 213

Audio/Information Screen — Points to the top section of the iPod screen.

Album Art — Points to the album art icon on the iPod screen.

Source — Points to the 'Source' button on the interface dial. Select to change an audio source.

(Power) Button — Points to the power button on the interface dial. Press to turn the audio system on and off.

VOL (Volume) Knob (Pushed out) — Points to the volume knob on the interface dial. Turn to adjust the volume.

Play/Pause Icon — Points to the play/pause icon on the iPod screen. Select to resume or play a song.

Shuffle — Points to the shuffle icon on the iPod screen. Select to use a shuffle feature.

Interface Dial/ENTER Button — Points to the central dial on the interface. Press and turn to select an item, then press to set your selection. Move up, down, right and left to select secondary menu.

BACK Button — Points to the 'BACK' button on the interface dial. Press to go back to the previous display.

USB Indicator — Points to the USB indicator icon on the iPod screen. Appears when an iPod is connected.

Album Art Icon — Points to the album art icon on the iPod screen.

On Demand Multi-Use Display™ — Points to the iPod screen.

Repeat — Points to the repeat icon on the iPod screen. Select to use a repeat feature.

Album Bar — Points to the album bar on the iPod screen. Select to search for an album.

More — Points to the 'More...' icon on the iPod screen. Select to display the menu items.

Skip/Seek Icons — Points to the skip/seek icons on the iPod screen. Select **||◀** or **▶▶** to change songs. Select and hold to move rapidly within a song.

MENU Button — Points to the 'MENU' button on the interface dial. Press to display the menu items.

Features

How to Select an Album

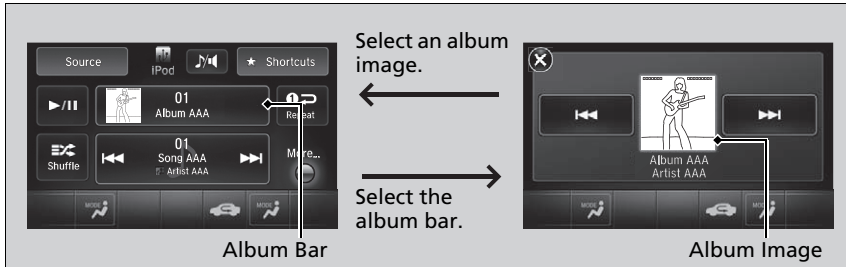

1. Select the album bar.
 - ▶ The image of the current album is displayed.
2. Select **⏮** or **⏭** icon to search for an album.
 - ▶ When the album image you are looking for appears, select it to play.

How to Select an Album

This function may not be available depending on models or versions.

Select **X** to go back to the previous screen.

■ How to Select a Song from the Music Search List

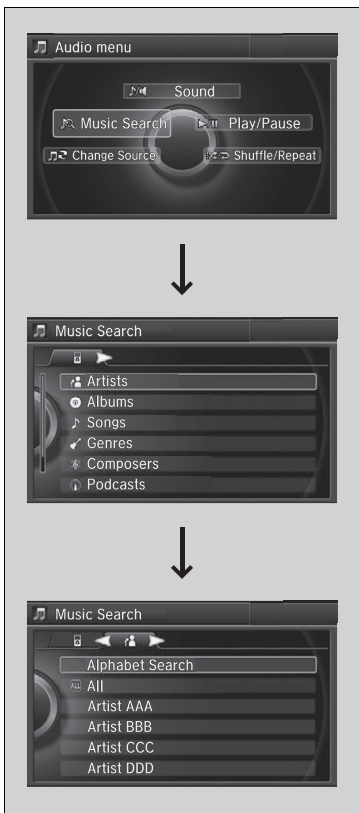

1. Press the **MENU** button.
2. Rotate to select **Music Search**, then press .
3. Rotate , move or , then press to select a song from the **Music Search** list.

You can also select a song by the following procedure.

1. Rotate or press to display the song list.
2. Rotate , move or , then press to select a song from the list.

▶▶ How to Select a Song from the Music Search List

You can control an iPod using voice commands.

- ▶▶ **Voice Control Operation** P. 232
- ▶▶ **Song By Voice™ (SBV)** P. 262

Available operating functions vary on models or versions. Some functions may not be available on the vehicle's audio system.

If there is a problem, you may see an error message on the audio/information screen.

- ▶▶ **iPod/USB Flash Drive** P. 275

How to Select a Play Mode

You can select repeat and shuffle modes when playing a file.



Interface Dial

1. Press the **MENU** button.
2. Rotate to select **Shuffle/Repeat**, then press .
3. Rotate to select a mode, then press .

On Demand Multi-Use Display™

1. Select **Shuffle** or **Repeat**.
Playing an iPod P. 258
2. Select a mode.

To turn off a play mode

Interface Dial

1. Press the **MENU** button.
2. Rotate to select the mode you want to turn off, then press .

On Demand Multi-Use Display™

1. Select **Shuffle** or **Repeat**.
Playing an iPod P. 258
2. Select the mode you want to turn off.

How to Select a Play Mode

Play Mode Menu Items

Repeat Song: Repeats the current track.

Shuffle Albums: Plays all available albums in a selected list (playlists, artists, albums, songs, genres, or composers) in random order.

Shuffle All Songs: Plays all available files in a selected list (playlists, artists, albums, songs, genres, or composers) in random order.

Song By Voice™ (SBV)

Use SBV to search for and play music from your HDD or iPod using voice commands.

■ To enable SBV

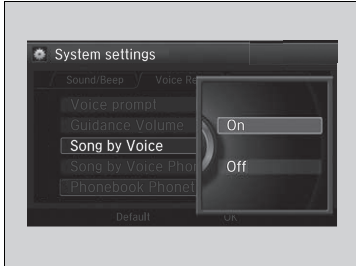

1. Press the **SETTINGS** button.
2. Rotate to select **System Settings**, then press .
3. Move or to select the **Voice Reco** tab.
4. Rotate to select **Song By Voice**, then press .
5. Rotate to select **On** or **Off**, then press .



☒ Song By Voice™ (SBV)

Setting options:

- **On** (factory default): Song By Voice™ commands are available.
- **Off**: Disable the feature.

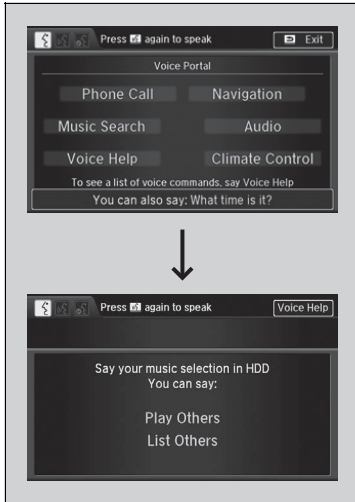
■ Searching for music using SBV



1. Set the **Song By Voice** setting to **On**.
2. Press the  (Talk) button and say "Music Search" to activate the SBV feature for the HDD and iPod.
3. Press the  button and say a command.
 - ▶ Example 1: Say "(List) 'Artist A'" to view a list of songs by that artist. Select the desired song to start playing.
 - ▶ Example 2: Say "Play 'Artist A'" to start playing songs by that artist.
4. To cancel SBV, press the  (hang-up/back) button on the steering wheel. The selected song continues playing.

Once you have canceled this mode, you need to press the  button and say "Music Search" again to re-activate this mode.

☒ Searching for music using SBV

Song By Voice™ Commands List

➤ **Song By Voice Commands** P. 236

NOTE:

Song By Voice™ commands are available for tracks stored on the HDD or iPod.

You can add phonetic modifications of difficult words so that it is easier for SBV to recognize artists, songs, albums, and composers in voice commands.

➤ **Phonetic Modification** P. 264

Continued

Phonetic Modification

Add phonetic modifications of difficult or foreign words so that it is easier for SBV to recognize artists, songs, albums, and composers in voice commands when searching for music on the HDD or iPod.











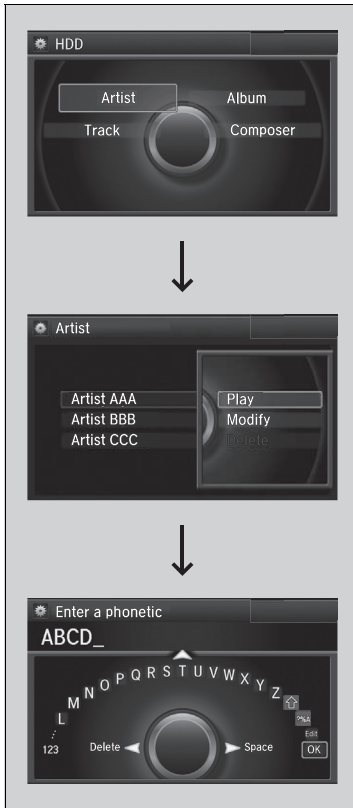



1. Press the **SETTINGS** button.
2. Rotate to select **System Settings**, then press .
3. Move or to select the **Voice Reco** tab.
4. Rotate to select **Song By Voice Phonetic Modification**, then press .
5. Move and rotate to select **New Modification**, then press .
6. Rotate to select **HDD** or **iPod**, then press .

Phonetic Modification

Phonetic Modification is grayed out when **Song By Voice** is set to **Off**.

You can store up to 2,000 phonetic modification items.



7. Rotate  to select the item to modify (e.g., **Artist**), then press .
 - ▶ The list of the selected item appears on the screen.
8. Rotate  to select an entry (e.g., **No Name**), then press .
 - ▶ The pop-up menu appears on the screen.
 - ▶ To listen to the current phonetic modification, rotate  to select **Play**, then press .
 - ▶ To delete the current phonetic modification, rotate  to select **Delete**, then press .
9. Rotate  to select **Modify**, then press .
10. Enter the phonetic spelling you wish to use (e.g., "Artist A") when prompted.
11. Move  to select **OK** to exit.
 - ▶ The artist "No Name" is phonetically modified to "Artist A." When in the SBV mode, you can press the  (Talk) button and use the voice command "Play 'Artist A'" to play songs by the artist "No Name."

Compatible phones only

Playing Internet Radio

Connect a compatible phone through *Bluetooth*®.

iPhone

You can also connect the phone using your USB connector to the USB port.

▶▶ Playing Internet Radio

Pandora®, the Pandora logo, and the Pandora trade dress are trademarks or registered trademarks of Pandora Media, Inc., used with permission. Pandora is currently available exclusively in the United States.

Audio/Information Screen

Album Art

Source

Select to change an audio source.

(Power) Button

Press to turn the audio system on and off.

VOL (Volume) Knob (Pushed out)

Turn to adjust the volume.

Play/Pause Icon

Select to resume or play a song.

BACK Button

Press to go back to the previous display.

Interface Dial/ENTER Button

Press and turn to select an item, then press to set your selection. Move up, down, right and left to select secondary menu.

Bluetooth® Indicator

Appears when your phone is connected to HFL.

USB Indicator

Appears when a phone is connected.

Rating Icon

On Demand Multi-Use Display™

Station Up/Down Icons

Select to change a station.

Skip Icon

Select to skip a song.

More

Select to display the menu items.

Like/Dislike Icons

Select to evaluate a song.

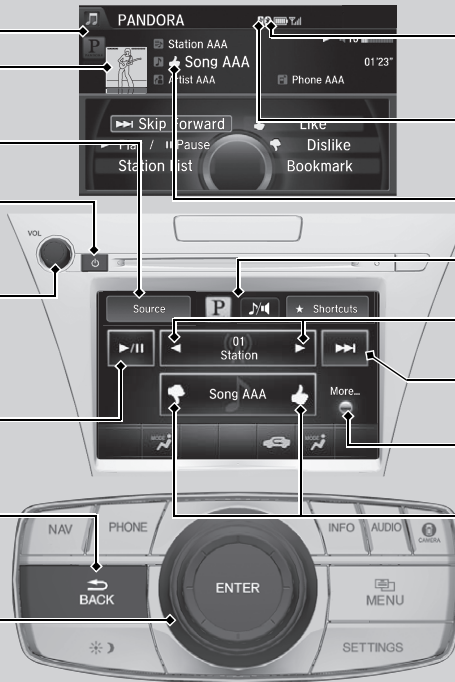

U.S. models



Pandora® Menu

You can operate some of the Pandora® menu items from your vehicle's audio system. The available items are:

- **Skip Forward**
- **Play/Pause**
- **Station List**
- **Like**
- **Dislike**
- **Bookmark Track**
- **Bookmark Artist**
- **Change Source**
- **Sound**

■ Operating a menu item

The menu items are shown in the lower half of the audio/information screen.

Rotate  to select an item and press .

To select **Change Source** or **Sound**, press the **MENU** button, then press .

▶▶ Playing Internet Radio

To find out if your phone is compatible with this feature, visit www.Handsfreeink.com/Acura, or call 1-888-528-7876.

Pandora® is a personalized Internet radio service that selects music based on an artist, song, or genre a user enters, and streams what is likely to be of interest.

To use this service in your vehicle, the Pandora® app must first be installed on your phone. Visit www.pandora.com for more information.

If you cannot operate Pandora® through the audio system, it may be streaming through *Bluetooth®* Audio. Make sure Pandora® mode on your audio system is selected.

▶▶ Pandora® Menu

You can control Pandora® using voice commands.

▶ **Voice Control Operation** P. 232

Available operating functions vary on software versions. Some functions may not be available on the vehicle's audio system.

If there is a problem, you may see an error message on the audio/information screen.

▶ **Pandora®** P. 276

There are restrictions on the number of songs you can skip or dislike in a given hour.

Playing a USB Flash Drive

Your audio system reads and plays sound files on a USB flash drive in either MP3, WMA, or AAC*1 format.

Connect your USB flash drive to the USB port, then select the USB mode.

➤ **USB Port** P. 213

Audio/Information Screen — Points to the top display showing 'USB' mode, track information (01 File AAA), and a list of tracks (Track BBB, mp3; Track CCC, mp3; Track DDD, mp3).

Source — Select to change an audio source.

(Power) Button — Press to turn the audio system on and off.

VOL (Volume) Knob (Pushed out) — Turn to adjust the volume.

Scan — Select to use a scan feature.

Random — Select to use a random feature.

Interface Dial/ENTER Button — Press and turn to select an item, then press to set your selection. Move up, down, right and left to select secondary menu.

BACK Button — Press to go back to the previous display.

USB Indicator — Appears when a USB flash drive is connected.

On Demand Multi-Use Display™ — Points to the bottom display showing 'Source', '01 Folder AAA', and '01 File AAA'.

Folder Up/Down Icons — Select ▶ to skip to the next folder, and ◀ to skip to the beginning of the previous folder.

Repeat — Select to use a repeat feature.

More — Select to display the menu items.

Skip/Seek Icons — Select |◀◀ or ▶▶| to change files. Select and hold to move rapidly within a file.

MENU Button — Press to display the menu items.

*1: Only AAC format files recorded with iTunes are playable on this unit.

How to Select a File from the Music Search List

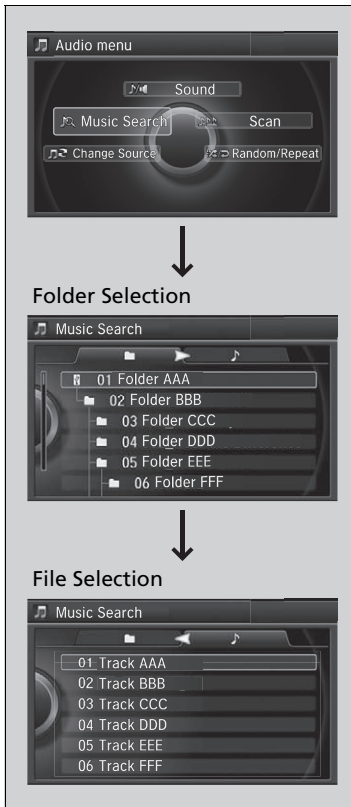

1. Press the **MENU** button.
2. Rotate to select **Music Search**, then press .

3. Rotate , move or , then press to select a file from the **Music Search** list.

You can also select a file by the following procedure.

1. Rotate or press to display the song list.
2. Rotate , move or , then press to select a file from the list.

▶▶ Playing a USB Flash Drive

You can control a USB flash drive using voice commands.

▶ **Voice Control Operation** P. 232

Use the recommended USB flash drives.

▶ **General Information on the Audio System**
P. 277

Files in WMA/AAC format protected by digital rights management (DRM) cannot be played.

The audio system displays **Unplayable File**, and then skips to the next file.

If there is a problem, you may see an error message on the audio/information screen.

▶ **iPod/USB Flash Drive** P. 275

Continued

How to Select a Play Mode

You can select scan, repeat, and random modes when playing a file.



Interface Dial

1. Press the **MENU** button.
2. Rotate to select **Scan** or **Random/Repeat**, then press .
3. Rotate to select a mode, then press .

On Demand Multi-Use Display™

1. Select **Scan**, **Random** or **Repeat**.
Playing a USB Flash Drive P. 268
2. Select a mode.

To turn off a play mode

Interface Dial

1. Press the **MENU** button.
2. Rotate to select the mode you want to turn off, then press .

On Demand Multi-Use Display™

1. Select **Scan**, **Random** or **Repeat**.
Playing a USB Flash Drive P. 268
2. Select the mode you want to turn off.

How to Select a Play Mode

Play Mode Menu Items

Scan

Scan Folders: Provides a 10-second sampling of the first file in each of the main folders.

Scan Tracks: Provides a 10-second sampling of all files in the current folder.

Random/Repeat

Repeat Folder: Repeats all files in the current folder.

Repeat Track: Repeats the current file.

Random in Folder: Plays all files in the current folder in random order.

Random All Tracks: Plays all files in random order.

Playing *Bluetooth*® Audio

Your audio system allows you to listen to music from your *Bluetooth*-compatible phone.

This function is available when the phone is paired and connected to the vehicle's *Bluetooth*® HandsFreeLink® (HFL) system.

☒ **Phone Setup** P. 330

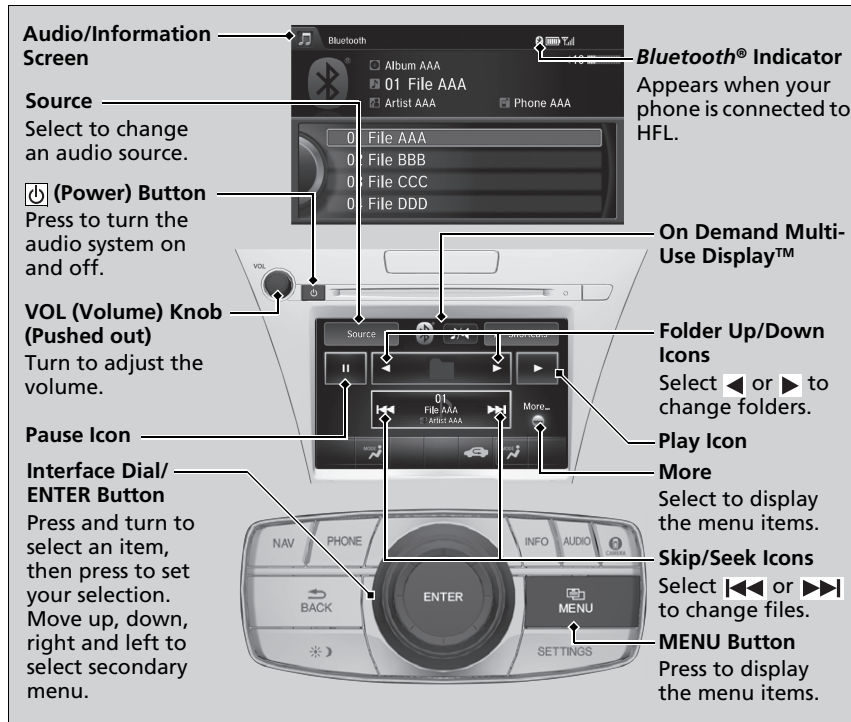

☒ Playing *Bluetooth*® Audio

Not all *Bluetooth*-enabled phones with streaming audio capabilities are compatible with the system.

For a list of compatible phones:

- U.S.: Visit www.HandsfreeLink.com/Acura, or call 1-888-528-7876.
- Canada: For more information on smartphone compatibility, call 1-888-528-7876.

In some states, it may be illegal to perform some data device functions while driving.

If more than one phone is paired to the HFL system, there will be a delay before the system begins to play.

You can control *Bluetooth*® Audio using voice commands.

☒ **Voice Control Operation** P. 232

■ To Play *Bluetooth*® Audio Files

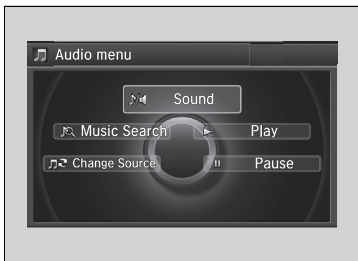



1. Make sure that your phone is paired and connected to HFL.
2. Select the *Bluetooth*® Audio mode.

If the phone is not recognized, another HFL-compatible phone, which is not compatible for *Bluetooth*® Audio, may already be connected.

■ To pause or resume a file

Interface Dial

1. Press the **MENU** button.
2. Rotate  to select **Play** or **Pause**, then press .

On Demand Multi-Use Display™

Select the play icon or pause icon.

▶▶ To Play *Bluetooth*® Audio Files





To play the audio files, you may need to operate your phone. If so, follow the phone maker's operating instructions.

The pause function may not be available on some phones.

Switching to another mode pauses the music playing from your phone. This function may not be available on some phones.

CD Player

If a disc error occurs, you may see the following error messages.

Error Message	Cause	Solution
Unplayable File	Track/file format not supported	<ul style="list-style-type: none"> Current track/file will be skipped. The next supported track/file plays automatically.
Bad Disc Please Check Owner's Manual Push Eject	Mechanical error	<ul style="list-style-type: none"> Press the  (eject) button and remove the disc, and check that the error message is cleared. Check that the disc is not damaged or deformed, and insert the disc again. <ul style="list-style-type: none">  Protecting CDs P. 279 If the error message reappears, press the  button, and pull out the disc. Insert a different disc. If the new disc plays, there is a problem with the first disc. If the error message repeats, or the disc cannot be removed, contact a dealer. Do not try to force the disc out of the player.
Mecha Error		
Bad Disc Please Check Owner's Manual	Servo error	
Check Disc	Disc error	<ul style="list-style-type: none"> Check that the disc is not damaged or deformed. <ul style="list-style-type: none">  Protecting CDs P. 279
Heat Error	High temperature	<ul style="list-style-type: none"> Turn the audio system off and allow the player to cool down until the error message is cleared.

Hard Disk Drive (HDD) Audio

If an error occurs while playing the Hard Disk Drive (HDD) Audio, you may see the following error messages. If you cannot clear the error message, contact a dealer.

Error Message	Solution
HDD access error. Please consult your dealer.	—
The display system temperature is too high. For protection, the system will shut off until the display cools down.	Turn the audio system off and allow the player to cool down until the error message is cleared.
The navigation system temperature is too low. For protection, the system will shut off until it warms up.	The navigation system has difficulty reading the HDD when the temperature is below approximately -22°F (-30°C). The navigation system starts up automatically when the display warms up.
Unplayable File	Appears when a file format not supported. Current track will be skipped. The next supported track plays automatically.

iPod/USB Flash Drive

If an error occurs while playing an iPod or USB flash drive, you may see the following error messages. If you cannot clear the error message, contact a dealer.

Error Message	Solution
USB Error	Appears when there is a problem with the audio system. Check if the device is compatible with the audio system.
Incompatible USB Device Please Check Owner's Manual	Appears when an incompatible device is connected. Disconnect the device. Then turn the audio system off, and turn it on again. Do not reconnect the device that caused the error.
Unsupported Version	Appears when an unsupported iPod is connected. If it appears when a supported iPod is connected, update the iPod software to the newer version.
Connect Retry	Appears when the system does not acknowledge the iPod. Reconnect the iPod.
Unplayable File	Appears when the files in the USB flash drive are DRM or an unsupported format. This error message appears for about 3 seconds, then plays the next song.
No Data	iPod Appears when the iPod is empty.
	USB flash drive Appears when the USB flash drive is empty or there are no MP3, WMA, or AAC files in the USB flash drive.
	iPod and USB flash drive Check that compatible files are stored on the device.
Unsupported	Appears when an unsupported device is connected. If it appears when a supported device is connected, reconnect the device.

U.S. models

Pandora®

If an error occurs while playing Pandora®, you may see the following error messages.

If you cannot clear the error message, contact a dealer.

Error Message	Solution
Incompatible USB Device Please Check Owner's Manual	Appears when an incompatible device is connected. Disconnect the device. Then turn the audio system off, and turn it again. Do not reconnect the device that caused the error.
No stations have been created. Please create a station on the device.	Appears when there is no station list on the device. Use the device to create a station.
Music licenses force us to limit the number of tracks you may skip each hour.	Appears when you try to skip a song or select Dislike over the predetermined number of times in an hour.
Unable to save rating. Unable to save bookmark or Unable to skip	Appears when the commanded operation is failed. Try again later.
No data	Appears when no data is available with Pandora® activated. Reboot the app and reconnect the device.
PANDORA Unsupported	Appears when Pandora® version is not supported. Update Pandora® to the latest version.
PANDORA system maintenance	Appears when the Pandora® server is in maintenance. Try again later.
Cannot connect to PANDORA. When stopped, check your mobile device.	Appears when Pandora® is unable to play music. Check your device.

SiriusXM® Radio Service

■ Subscribing to SiriusXM® Radio

1. You need your radio ID ready before registering for subscription. To see the ID in the On Demand Multi-Use Display™, select **◀◀** until **CH 000** and the radio ID appears.
2. Have your radio ID and credit card number ready, and either call or visit the SiriusXM® website to subscribe.

■ Receiving SiriusXM® Radio

Switch to the SiriusXM® mode by pressing the **SOURCE** button repeatedly or operating the On Demand Multi-Use Display™, and stay in this mode for about 30 minutes until the service is activated. Make sure your vehicle is in an open area with good reception.

■ SiriusXM® Radio Display Messages

Loading:

SiriusXM® is loading the audio or program information.

Channel off air:

The channel is not currently broadcasting.

Channel unsubscribed:

You are not subscribed to the channel selected.

No signal:

The signal is too weak in the current location.

Channel unavailable:

No such channel exists.

Check antenna, Antenna disconnected, Antenna shorted:

There is a problem with the SiriusXM® antenna. Contact a dealer.

☒ Subscribing to SiriusXM® Radio

Contact Information for SiriusXM® Radio:

- U.S.: SiriusXM® Radio at www.siriusxm.com/subscribe or 1-855-236-9236
- Canada: SiriusXM® Canada at www.siriusxm.ca/subscribe-now, or (877) 209-0079

☒ Receiving SiriusXM® Radio

The SiriusXM® satellites are in orbit over the equator; therefore, objects south of the vehicle may cause satellite reception interruptions. Satellite signals are more likely to be blocked by tall buildings and mountains the farther north you travel from the equator.

You may experience reception problems under the following circumstances:

- In a location with an obstruction to the south of your vehicle.
- In tunnels
- On the lower level of a multi-tiered road
- Large items carried on the roof rack

Recommended CDs

- Use only high-quality CD-R or CD-RW discs labeled for audio use.
- Use only CD-R or CD-RW discs on which the recordings are closed.
- Play only standard round-shaped CDs.

The CD packages or jackets should have one of these marks.



CDs with MP3, WMA or AAC files

- Some software files may not allow for audio play or text data display.
- Some versions of MP3, WMA or AAC formats may be unsupported.

▶▶ Recommended CDs

A Dual-disc cannot play on this audio unit. If recorded under certain conditions, a CD-R or CD-RW may not play either.

■ Protecting CDs

Follow these precautions when handling or storing CDs:

- Store a CD in its case when it is not being played.
- When wiping a CD, use a soft clean cloth from the center to the outside edge.
- Handle a CD by its edge. Never touch either surface.
- Never insert foreign objects into the CD player.
- Keep CDs out of direct sunlight and extreme heat.
- Do not place stabilizer rings or labels on the CD.
- Avoid fingerprints, liquids, and felt-tip pens on the CD.

▶▶ Protecting CDs

NOTICE

Do not insert a damaged CD. It may be stuck inside and damage the audio unit.

Examples:

- Bubbled, wrinkled, labeled, and excessively thick CDs



Bubbled/
Wrinkled



With Label/
Sticker



Using
Printer Label
Kit



Sealed



With Plastic Ring

- Damaged CDs



Chipped/
Cracked



Warped

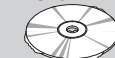

Burrs

- Poor quality CDs



3-inch
(8-cm)
CD

Compatible iPod, iPhone, and USB Flash Drives

■ iPod and iPhone Model Compatibility

Model
iPod (5th generation)
iPod classic 80GB/160GB (launch in 2007)
iPod classic 120GB (launch in 2008)
iPod classic 160GB (launch in 2009)
iPod nano (1st to 7th generation) released between 2005 and 2012
iPod touch (1st to 5th generation) released between 2007 and 2012/iPod touch 6th generation 2015 release
iPhone 3G/iPhone 3GS/iPhone 4/iPhone 4s/iPhone 5/iPhone 5c/iPhone 5s/iPhone 6/iPhone 6 Plus/iPhone 6s/iPhone 6s Plus/iPhone 7/iPhone 7 Plus

■ USB Flash Drives

- A USB flash drive of 256 MB or higher is recommended.
- Some digital audio players may not be compatible.
- Some USB flash drives (e.g., a device with security lockout) may not work.
- Some software files may not allow for audio play or text data display.
- Some versions of MP3, WMA, or AAC formats may be unsupported.

⌘ iPod and iPhone Model Compatibility

This system may not work with all software versions of these devices.

⌘ USB Flash Drives

Files on the USB flash drive are played in their stored order. This order may be different from the order displayed on your PC or device.

Honda App License Agreement

END USER LICENSE AGREEMENT

PLEASE CAREFULLY READ THIS END USER LICENSE AGREEMENT (THIS "AGREEMENT") WHICH GOVERNS YOUR USE OF THE SOFTWARE INSTALLED ON YOUR HONDA OR ACURA VEHICLE (YOUR "VEHICLE") AS WELL AS THE APPLICATIONS, SERVICES, FUNCTIONS, AND CONTENT PROVIDED THROUGH THE SOFTWARE (COLLECTIVELY, THE "SERVICES"). YOUR USE OF THE SOFTWARE OR SERVICES WILL SERVE AS YOUR CONSENT TO THE TERMS OF THIS AGREEMENT. THE SOFTWARE IS OWNED (OR LICENSED), PROVIDED, AND/OR OPERATED BY AMERICAN HONDA MOTOR CO. INC., ("HONDA," "US," "WE," OR "OUR"), WITH ITS BUSINESS ADDRESS AT 1919 TORRANCE BLVD., TORRANCE, CA 90501. REFERENCE TO "HONDA" IN THIS AGREEMENT INCLUDES HONDA'S PARENT COMPANY AND ITS AFFILIATES AND DESIGNATED AGENTS. THE SERVICES ARE OWNED (OR LICENSED), PROVIDED, AND/OR OPERATED BY HONDA OR A THIRD-PARTY SERVICE PROVIDER (A "PROVIDER"). REFERENCE TO A "PROVIDER" IN THIS AGREEMENT INCLUDES SUCH PROVIDER'S PARENT COMPANY, AFFILIATES, AND DESIGNATED AGENTS.

A. Description of the Software. The SOFTWARE includes the software, firmware and the like, installed and executing on your VEHICLE during manufacture, and thereafter updated from time to time by HONDA, you or an authorized HONDA dealer (a "DEALER"). The SOFTWARE allows you to access and use a variety of SERVICES, including but not limited to: (a) HONDA applications, services, and content provided through the SOFTWARE (together, "HONDA SERVICES"); and (b) PROVIDER applications, services, and content provided through the SOFTWARE (together, "PROVIDER SERVICES"), each of which may provide access to various information, media, content, and services.

B. SOFTWARE Licensing and Intellectual Property.

1. SOFTWARE. This AGREEMENT grants you a non-exclusive, limited, and revocable license to use the SOFTWARE and SERVICES solely (a) as installed on your VEHICLE by HONDA, (b) as updated on your Vehicle by HONDA, you (but only as and when directed by HONDA), or a DEALER and (c) as permitted under the terms of this AGREEMENT.

2. HONDA Services. The SOFTWARE may provide you with access to various HONDA SERVICES. Installation, activation, or use of HONDA SERVICES may require your consent to additional terms, conditions, and privacy policies applicable to those HONDA SERVICES (the "HONDA TERMS"). You acknowledge and agree that any collection, use, sharing of data generated by your VEHICLE or your use of your VEHICLE, and your use of the HONDA SERVICES shall be subject to this AGREEMENT and any additional HONDA TERMS that may be specifically applicable to such HONDA SERVICES or data generation. The HONDA SERVICES may collect, use, and share such data while you are using the SOFTWARE.

3. Open-Source Software. The SOFTWARE and SERVICES may incorporate software licensed to HONDA under free or open-source licenses which govern HONDA's distribution and your use of such software. HONDA and the third-party authors, licensors, and distributors of such software disclaim all warranties and all liability arising from any and all use or distribution of the software. To the extent such software is provided under terms that differ from the applicable free or open-source licenses, those terms are offered by HONDA alone. Additional information regarding free and open-source software incorporated in the SOFTWARE and SERVICES is available in this manual or within the SOFTWARE.

4. Provider Services. The SOFTWARE may provide you with access to various PROVIDER SERVICES. Installation or use of such PROVIDER SERVICES may require your consent to additional terms, conditions, and privacy policies of the applicable PROVIDER (the "PROVIDER TERMS"). This AGREEMENT restricts the manner in which you can install and use PROVIDER SERVICES but does not grant you a license or permission to use such PROVIDER SERVICES. Your permission to use PROVIDER SERVICES is limited and subject to any license grants, conditions, and limitations included in the PROVIDER TERMS. You acknowledge that any collection, use, sharing of your information, targeted advertising practices by PROVIDERS, and your use of the PROVIDER SERVICES shall be subject to both this AGREEMENT and any applicable PROVIDER TERMS. The PROVIDER SERVICES may collect, use, and share such information while you are using the SOFTWARE.

5. License Limitations and Restrictions on Use.

(a) Limited License. You understand and agree that the SOFTWARE and SERVICES are licensed, not sold, to you solely for use in accordance with this AGREEMENT and any applicable PROVIDER TERMS, and any documentation for the VEHICLE made available to you by HONDA (any "DOCUMENTATION"). HONDA and its licensors reserve all rights in the SOFTWARE and HONDA SERVICES not expressly granted to you under this AGREEMENT. PROVIDERS and their licensors reserve all rights in the PROVIDER SERVICES not expressly granted to you under the applicable PROVIDER TERMS.

(b) Restrictions on Use. The licenses granted under this AGREEMENT do not permit you to use the SOFTWARE or SERVICES on a device other than your VEHICLE. As a condition of using the SOFTWARE and SERVICES, you agree that you may not and will not:

- (1) copy, download, distribute, modify, publish, sell, rent, lease, lend, license, sublicense, reuse, or create derivative works of the SOFTWARE or SERVICES or any of the content or other material within the SOFTWARE or SERVICES, including without limitation, HONDA or PROVIDER names, logos, or any other trademarks of HONDA or PROVIDERS or used in association with the SOFTWARE or any SERVICES, except as required to use the SOFTWARE or SERVICES in accordance with this AGREEMENT, any applicable PROVIDER TERMS, and the DOCUMENTATION;
- (2) access or use the SOFTWARE or SERVICES in any manner intended to damage or impair the operation of the SOFTWARE or SERVICES or interfere with anyone else's use and enjoyment of the SOFTWARE or SERVICES;
- (3) access or attempt to access any system or server on which the SOFTWARE or SERVICES is hosted or modify or alter the SOFTWARE or SERVICES in any way;
- (4) use the SOFTWARE or SERVICES for any unlawful purpose, or in violation of any third party rights;
- (5) use the SOFTWARE or SERVICES in violation of any applicable traffic regulations, rules or laws, including but not limited to any driver distraction laws, rules or regulations;
- (6) violate the terms of this AGREEMENT, any HONDA TERMS, any PROVIDER TERMS or other applicable third-party terms, conditions, and privacy policies; or
- (7) reverse engineer, decompile, disassemble, attempt to derive the source code of, nor permit others to reverse engineer, decompile, or disassemble, or attempt to derive the source code of the SOFTWARE or SERVICES, except and only to the extent that such activity is expressly permitted (a) by applicable law notwithstanding this limitation or (b) the terms of applicable free or opensource software licenses.

6. Intellectual Property Rights. All title and intellectual property rights in and to the SOFTWARE and SERVICES, the accompanying DOCUMENTATION, and all copies of the SOFTWARE or SERVICES are owned by HONDA, PROVIDERS, or their suppliers or licensors. This AGREEMENT does not grant you any rights in connection with any trademarks or service marks of HONDA, PROVIDERS, or their licensors, affiliates, or suppliers.

7. Export Restrictions: You acknowledge that the SOFTWARE and SERVICES are subject to U.S., European Union, and other export jurisdictions. You agree to comply with all applicable international and national laws that apply to the SOFTWARE and SERVICES, including the U.S. Export Administration Regulations, as well as end-user, end-use, and destination restrictions issued by the U.S. and other governments.

C. SOFTWARE Operation

1. HONDA reserves the right to suspend or terminate your access to and use of the SOFTWARE or SERVICES if you are found to be in violation of this AGREEMENT or as reasonably deemed necessary by HONDA.

2. Eligibility/Registration/Activation. The SOFTWARE is intended for and available to individuals who (a) are of legal age of majority in their jurisdiction of residence (and at least 18 years of age), or are younger than 18 years of age and possess a valid driver's license issued by their jurisdiction of residence, and (b) own or have permissive access to a compatible VEHICLE. We do not knowingly collect any information, including personal information, from children under 13. If we learn or are notified that we have collected personal information of a child under 13, we will immediately take steps to delete such information.

3. Use of PROVIDER SERVICES through the SOFTWARE. Certain PROVIDER SERVICES made available through the SOFTWARE may require that you register or otherwise have an account with the PROVIDER and agree to PROVIDER TERMS. Any use of any of such PROVIDER SERVICES within the SOFTWARE is subject to this AGREEMENT and the applicable PROVIDER TERMS. HONDA does not exercise control over such PROVIDER SERVICES and is not responsible or liable for the availability, security, or content of such PROVIDER SERVICES, and the inclusion of any PROVIDER SERVICES does not imply a referral from, the approval of, or the endorsement by HONDA of such PROVIDER SERVICES. HONDA is not responsible or liable, directly or indirectly, for any damage relating to or resulting from your use of the PROVIDER SERVICES.

4. Links to Third Party Sites: The SOFTWARE may provide you with the ability to access third-party sites and content through the use of the SOFTWARE or SERVICES. The third-party sites and content are not under the control of HONDA. HONDA is not responsible or liable, directly or indirectly, for such third-party websites and their content or for any damage relating to or resulting from your access or use of such websites and content.

5. Unauthorized Use and Abuse. You are responsible for ensuring your (and any authorized third parties') use of the SOFTWARE and SERVICES remains in compliance with this AGREEMENT and all other applicable HONDA TERMS and PROVIDER TERMS. You acknowledge and agree that any use of the SOFTWARE or SERVICES occurring through your VEHICLE will be deemed your actions and that HONDA and PROVIDERS may rely upon such actions. You agree to immediately notify us if you suspect fraudulent or abusive activity involving the SOFTWARE or SERVICES. If you so notify us or if we otherwise suspect fraudulent or abusive activity, you agree to cooperate with us in any fraud investigation and to use any fraud prevention measures we prescribe. Your failure to immediately notify us or cooperate to use such measures will result in your liability for all fraudulent usage or abusive activity associated with your VEHICLE.

6. SOFTWARE Updates. The SOFTWARE and SERVICES may be updated when your VEHICLE is serviced by a DEALER or remotely, over-the-air, by HONDA from time to time; such updates may occur with or without further notice or your future consent. The SOFTWARE may be updated at HONDA's discretion and for any purpose including, without limitation, to patch or otherwise improve the SOFTWARE or SERVICES functionality, security, or stability. All updates to the SOFTWARE and SERVICES are subject to this AGREEMENT and any other applicable HONDA TERMS and PROVIDER TERMS.

7. Uninstalling, Removing, and Replacing the SOFTWARE. Replacing SOFTWARE or HONDA SERVICES with software or firmware not provided and installed by HONDA or a DEALER will render all representations and warranties for the SOFTWARE, HONDA SERVICES, and VEHICLE functionality reliant upon the SOFTWARE or HONDA SERVICES null and void.

D. SOFTWARE Operational Notices and Warnings

1. Vehicle Geolocation Information. You acknowledge that your VEHICLE may be equipped with certain traffic and map features. The traffic feature will automatically collect and transmit, through GPS technology, your Vehicle's current location (longitude and latitude), travel direction and speed ("VEHICLE GEOLOCATION INFORMATION") to HONDA and PROVIDERS. The VEHICLE GEOLOCATION INFORMATION is used by HONDA and PROVIDERS to provide traffic and navigation-related information to you, but may also be used to provide other SERVICES or offers to you. HONDA will not use such VEHICLE GEOLOCATION INFORMATION for its own marketing efforts, or provide such information to unaffiliated third parties for their own purposes, without your express consent.

2. Potential Map Inaccuracy and Route Safety. Maps used by this system may be inaccurate because of changes in roads, traffic controls, routing, or driving conditions. Always use good judgment and common sense when following suggested routes. Do not follow the route suggestions if doing so would result in an unsafe or illegal driving maneuver, if you would be placed in an unsafe situation, or if you would be directed into an area that you consider unsafe. Do not rely on any navigation features included in the system to route you to emergency services. Not all emergency services such as police, fire stations, hospitals, or clinics are likely to be contained in the map database for such navigation features. Ask local authorities or an emergency services operator for such locations and routes. The driver is ultimately responsible for the safe operation of the vehicle and therefore, must evaluate whether it is safe to follow the suggested directions. Any navigation features are provided only as an aid. Make your driving decisions based on your observations of local conditions and existing traffic regulations. Navigation features are not a substitute for your personal judgment. Any route suggestions made by the SOFTWARE or SERVICES should never replace any local traffic regulations or your personal judgment or knowledge of safe driving practices.

3. Speech Recognition: You acknowledge and understand that HONDA and PROVIDERS may record, retain, and use voices commands when you use the speech recognition components of the SOFTWARE or SERVICES. You and all VEHICLE operators and passengers (a) consent to the recording and retention of voice commands in support of providing speech recognition components and (b) release HONDA and PROVIDERS from all claims, liabilities, and losses that may result from any use of such recorded voice commands. Recognition errors are inherent in speech recognition. It is your responsibility to monitor any speech recognition functions included in the system and address any errors. Neither HONDA nor PROVIDERS will be liable for any damages arising out of errors in the speech recognition process.

4. Distraction Hazards. Navigation features may require manual (non-verbal) input or setup. Attempting to perform such set-up or insert data while driving can seriously distract your attention and could cause a crash or other serious consequences; the ability to undertake such interactions may also be limited by state or local law, which laws you are responsible to know and follow. Even occasional short scans of the screen may be hazardous if your attention has been diverted away from your driving at a critical time. Pull over and stop the vehicle in a safe and legal manner before attempting to access a function of the system requiring prolonged attention. Do not raise the volume excessively. Keep the volume at a level where you can still hear outside traffic and emergency signals while driving. Driving while unable to hear these sounds could result in a crash.

E. Information Collection and Storage

1. Information Collection, Use, Transmission and Storage of Data. Consent to Use of Data: You agree that HONDA and PROVIDERS may collect and use your information gathered in any manner as part of product support services related to the SOFTWARE or related services. HONDA may share such information with third parties, including, without limitation, PROVIDERS, third party software and services suppliers, their affiliates and/or their designated agents, solely to improve their products or to provide services or technologies to you. HONDA, third party software and systems suppliers, their affiliates and/or their designated agent may disclose this information to others, but not in a form that personally identifies you.

2. Information Storage. Depending on the type of multimedia system you have in your VEHICLE, certain information may be stored for ease of use of the SOFTWARE including, without limitation, search history, location history in certain applications, previous and saved destinations, map locations within certain applications, and device numbers and contact information.

(a) Vehicle Health Information. Your VEHICLE may remotely transmit information regarding the status and health of your VEHICLE (“VEHICLE INFORMATION”) to HONDA without notification to you. VEHICLE INFORMATION may contain VEHICLE maintenance and malfunction status that is derived from VEHICLE diagnostic data and includes, but is not limited to, status of powered doors and windows, battery life data, battery charging data, VEHICLE speed, coolant temperature, air compressor revolution, output power, warning codes, diagnostic trouble codes, fuel injection volume, and engine rotations per minute. VEHICLE HEALTH INFORMATION may be used by HONDA for research and development, to deliver HONDA SERVICES and information to you, and to contact you, and is retained only for a period of time necessary to fulfill these goals.

(b) VEHICLE Geolocation Data (non-navigation/map based). If you opt-in to geolocation-based SERVICES, your vehicle’s geolocation data (latitude and longitude) will be automatically sent from your VEHICLE to HONDA and PROVIDERS.

(c) You understand that the inputting or uploading of information to your VEHICLE’s multimedia system or the SOFTWARE or SERVICES is at your own risk and that HONDA is not responsible for unauthorized access to or use of any personal or other information. All information uploaded to the SOFTWARE and SERVICES may be stored on your VEHICLES’s multimedia system and you understand that the security and safety of your VEHICLE’s multimedia system is your sole responsibility.

F. NO WARRANTY. You understand and agree that your use of the SOFTWARE and SERVICES are solely at your own risk and that you will be solely responsible for any damage to your VEHICLE's multimedia system or any other equipment or any loss of data that may result from your use of the SOFTWARE or SERVICES. THE SOFTWARE AND SERVICES ARE PROVIDED ON AN "AS IS" AND "AS AVAILABLE" BASIS WITHOUT ANY WARRANTY OF ANY KIND, EXPRESSED, IMPLIED OR STATUTORY. WE SPECIFICALLY DISCLAIM ANY IMPLIED WARRANTIES OF MERCHANTABILITY, FITNESS FOR A PARTICULAR PURPOSE, AND NON-INFRINGEMENT. HONDA makes no warranties that the SOFTWARE or SERVICES will meet your requirements, or that the SOFTWARE or SERVICES will be uninterrupted, timely, secure, non-infringing or error free. You understand and agree that you are responsible for any and all charges, costs or expenses associated with your use of the SOFTWARE or SERVICES. Advice or information, whether oral or written, obtained by you from us or through the SOFTWARE or SERVICES are provided for informational purposes only and will not create any warranty not expressly made herein. You should not rely on any such information or advice. We assume no liability or responsibility for any errors or omissions in the SOFTWARE or SERVICES. We do not make any warranty or representation that your use of the material displayed on, or obtained through, the SOFTWARE or SERVICES is non-infringing of any rights of any third party. Any decision or action taken by you on the basis of information or content provided via the application is at your sole discretion and risk. HONDA and PROVIDERS are not responsible or liable for any such decision, or for the accuracy, completeness, usefulness, or availability of any content or information displayed, transmitted, or otherwise made available via the SOFTWARE or SERVICES. To the extent jurisdictions do not allow the exclusion of certain warranties, some of the above exclusions may not apply to you.

G. LIMITATIONS ON LIABILITY. You and HONDA are each waiving important rights.

1. Limitations on YOUR liability. HONDA cannot recover from you any consequential, indirect, incidental, or special damages, or attorney's fees in connection with your use of the SOFTWARE or HONDA SERVICES. HONDA WAIVES TO THE FULLEST EXTENT ALLOWED BY LAW ANY CLAIM FOR DAMAGES OTHER THAN DIRECT, COMPENSATORY DAMAGES AS LIMITED IN THIS AGREEMENT.

2. Limitation on HONDA and PROVIDER liability. Neither HONDA nor PROVIDERS will be liable to you or any other party for consequential, indirect, incidental, special, or punitive damages (including without limitation lost profits) in connection with your use of the SOFTWARE or SERVICES, even if HONDA or PROVIDERS are aware of the possibility of such damages. These limitations apply to all claims, including, without limitation, claims in contract and tort (such as negligence, product liability and strict liability). To the extent that a jurisdiction does not permit the exclusion or limitation of liability as set forth herein our liability is limited to the maximum extent permitted by law in such states. If HONDA or PROVIDERS are found liable to you for any reason, you agree that the aggregate liability of all these parties to you for any claim is limited to ten U.S. dollars (US \$10.00). Neither HONDA nor any PROVIDER would have agreed to provide the SOFTWARE or SERVICES to you if you did not agree to this limitation. This amount is the sole and exclusive liability of HONDA and PROVIDERS to you, and is payable as liquidated damages and not as a penalty. Except where prohibited by law, you may not bring any claim against HONDA or any third-party beneficiary more than two (2) years after the claim arises. We do not have any liability for SOFTWARE or SERVICES interruptions of any length.

(a) **Release of HONDA and PROVIDERS** For yourself and anyone else claiming under you, you agree to release and discharge HONDA, PROVIDERS, their respective officers, directors, and employees, and each third-party beneficiary from all claims, liabilities and losses in connection with the SOFTWARE or SERVICES, including, but not limited to claims for personal injury or property damage arising from the total or partial failure of performance of the SOFTWARE or SERVICES, even if caused by or based upon the negligence, gross negligence, strict products liability, Deceptive Trade Practices Act violations, bad faith, or breach of warranty of us or the malfunction of the SOFTWARE or SOFTWARE SERVICES. YOU AGREE TO WAIVE TO THE FULLEST EXTENT ALLOWED BY LAW, ANY CLAIM FOR DAMAGES OTHER THAN DIRECT, COMPENSATORY DAMAGES AS LIMITED IN THIS AGREEMENT. YOU HEREBY RELEASE AND DISCHARGE HONDA AND ITS LICENSORS AND CONTRACTORS (INCLUDING ANY THIRD PARTIES PROVIDING ALL OR PART OF THE SOFTWARE OR SERVICES) FROM AND AGAINST ANY CLAIMS, DAMAGES, EXPENSES AND LIABILITY ARISING FROM OR RELATED TO ANY INJURIES, DAMAGES, OR LOSSES TO ANY PERSON (INCLUDING DEATH) OR PROPERTY OF ANY KIND RESULTING IN WHOLE OR PART, DIRECTLY OR INDIRECTLY, FROM YOUR USE OF THE SOFTWARE OR SERVICES.

H. Survival. You agree that the limitations of liability and indemnities in this AGREEMENT will survive even after the AGREEMENT has ended. These limitations of liability apply not only to you, but to anyone using the SOFTWARE or SERVICES via your VEHICLE, to anyone making a claim on your behalf, and to any claims made by your family, employees, customers, or others arising out of or relating to your VEHICLE, the SOFTWARE, or SERVICES.

I. Availability/Interruption. The SOFTWARE and certain SERVICES are made available through your VEHICLE's compatible multimedia system when the VEHICLE is turned on. Certain SERVICES may be available only through your compatible mobile device when it is within the operating range of the VEHICLE and a wireless carrier. The availability of the SOFTWARE and SERVICES may be subject to transmission limitation or interruption, including but not limited to technical obsolescence or sunset of the hardware, software or firmware, inside of or external to the Vehicle, required for data transmission or receipt. HONDA does not guarantee that the SOFTWARE, SERVICES, or any portion thereof will be available at all times or in all areas. You acknowledge and agree that HONDA is not responsible for performance degradation, interruption or delays. You acknowledge that HONDA shall not be liable to you if the SOFTWARE or SERVICES in a given location are not available. If the SOFTWARE or SERVICES are not available within your intended location, you agree that your sole remedy shall be to cease using the SOFTWARE and SERVICES.

J. PRODUCT SUPPORT: Product support for the SOFTWARE is provided by HONDA. For product support, please refer to HONDA instructions provided in the DOCUMENTATION. Should you have any questions concerning this AGREEMENT, or if you desire to contact HONDA for any other reason, please refer to the HONDA contact information provided in the DOCUMENTATION.

K. Termination and Transfer.

1. Termination. This AGREEMENT is effective until terminated by you or US. WE may terminate this AGREEMENT for any or no reason, and with or without notice to you. Your rights under this AGREEMENT will terminate automatically without notice from US if you fail to comply with any term of this AGREEMENT. Upon termination of this AGREEMENT, you shall cease all use of the SOFTWARE and SERVICES.

2. Transfer: You may permanently transfer your rights under this AGREEMENT only as part of a sale or transfer of the VEHICLE, provided you retain no copies, you transfer all of the SOFTWARE and HONDA SERVICES (including all component parts, the media and printed materials, and any upgrades), and the recipient agrees to the terms of this AGREEMENT. You agree to notify HONDA upon the sale or transfer of the VEHICLE. To contact HONDA, please refer to the HONDA contact information provided in the DOCUMENTATION.

L. Changes to the SOFTWARE or SERVICES. WE may change, modify, or update the SOFTWARE or SERVICES from time to time. Unless explicitly stated otherwise, any new features or services that augment or enhance the SOFTWARE or SERVICES in the future shall respectively be considered part of the SOFTWARE or SERVICES and subject to this AGREEMENT. WE reserve the right at any time and from time to time to interrupt, restrict, modify, suspend, discontinue, temporarily or permanently, the SOFTWARE or SERVICES (or any portion thereof), with or without notice to you, and you agree that HONDA shall not be liable to you or to any third party for any modification, suspension or discontinuance of the SOFTWARE or SERVICES.

M. ARBITRATION:

PLEASE READ THIS ARBITRATION PROVISION CAREFULLY TO UNDERSTAND YOUR RIGHTS. YOU AGREE THAT ANY CLAIM THAT YOU MAY HAVE IN THE FUTURE MUST BE RESOLVED THROUGH BINDING ARBITRATION. YOU WAIVE THE RIGHT TO HAVE YOUR DISPUTE HEARD IN COURT AND WAIVE THE RIGHT TO BRING CLASS CLAIMS. YOU UNDERSTAND THAT DISCOVERY AND APPEAL RIGHTS ARE MORE LIMITED IN ARBITRATION.

Arbitration is a method of resolving a claim, dispute or controversy without filing a lawsuit. By agreeing to arbitrate, the right to go to court is waived and instead claims, disputes or controversies are submitted to binding arbitration. This provision sets forth the terms and conditions of our agreement. YOU and HONDA agree and acknowledge that this Agreement affects interstate commerce and the Federal Arbitration Act ("FAA") applies. By using the Software, Vehicle, or Services, YOU elect to have disputes resolved by arbitration. YOU, HONDA or any involved third party may pursue a Claim. "Claim" means any dispute between YOU, HONDA, or any involved third party relating to your use of the Software, the Vehicle, or the Services, this Agreement, or our relationship, including any representations, omissions or warranties. "Claim" does not include personal injury or wrongful death claims. YOU or HONDA may seek remedies in small claims court or provisional judicial remedies without arbitrating. In addition, notwithstanding anything herein to the contrary, YOU or HONDA may seek equitable relief in a court of competent jurisdiction.

YOU or HONDA may select arbitration with American Arbitration Association, JAMS or National Arbitration and Mediation. Contact these sponsors for their rules. The hearing will be in the federal district where YOU reside. If agreed, it may be by telephone or written submissions. Filing and arbitrator fees to be paid per the sponsor rules. You may contact the sponsor for a fee waiver. If no fee waivers, HONDA will pay filing and arbitrator fees up to \$5,000, unless law requires more. Each party is responsible for other fees. Arbitrator may award costs or fees to prevailing party, if permitted by law. HONDA will not seek fees, unless the claims are frivolous.

Arbitrator shall be an attorney or current or retired judge familiar with automotive or consumer software. The arbitrator shall follow substantive law, statute of limitations and decide all issues relating to the interpretation, construction, enforceability and applicability of this provision. The arbitrator may order relief permitted by law. This provision is governed and enforceable by the FAA. An award shall include a written opinion and be final, subject to appeal by the FAA.

This provision survives termination of this Agreement or relationship, bankruptcy, assignment or transfer. If part of this provision is unenforceable, the remainder remains in effect. If unenforceability allows arbitration as a class action, then this provision is entirely unenforceable. YOU may opt out within 30 days of your initial use of the Software by sending a signed, written notice to HONDA at Honda Financial Services, P.O. Box 165007, Irving, TX 75016. HONDA reserves the right to make changes to this provision after providing written notice and an opportunity to opt out.

N. Miscellaneous: You may not assign this AGREEMENT without HONDA's prior written consent. This AGREEMENT and any additional HONDA TERMS and PROVIDER TERMS represents the entire agreement between you and US. HONDA may amend the terms of this AGREEMENT by providing you with notices of such updated terms. If you do not consent to be bound by the updated terms, your sole remedy will be to cease using the SOFTWARE and SERVICES. If any part of this AGREEMENT is found invalid, void, or unenforceable, the balance of the AGREEMENT will remain valid and enforceable according to its terms. To the fullest extent permitted by law, and except as explicitly provided otherwise, this AGREEMENT and any disputes arising out of or relating to it will be governed by the laws of the State of California, except that California laws concerning choice of law or conflicts shall not apply if they would cause the substantive law of another jurisdiction to apply. Notwithstanding the foregoing, Section M shall be governed by the Federal Arbitration Act and the laws of the State of California, as applicable, as set forth therein. The failure to enforce any term of this AGREEMENT on one occasion shall not prevent enforcement on any other occasion or the enforcement of any other term. Headings and captions shall not be considered included for purposes of interpretation or application hereof, but are for convenience only.

License Information

■ DTS

For DTS patents, see <http://patents.dts.com>. Manufactured under license from DTS Licensing Limited. DTS, the Symbol, & DTS and the Symbol together are registered trademarks, and DTS Digital Surround and Neural Surround are trademarks of DTS, Inc. © DTS, Inc. All Rights Reserved.



About Open Source Licenses

■ Important Information on the Software

About the software license of the product



The software installed in the product contains open source software.
See the following website for details on the open source software.

<http://hondaopensource6.com/oss/www/index.html>

Customized Features

Use the audio/information screen to customize certain features.



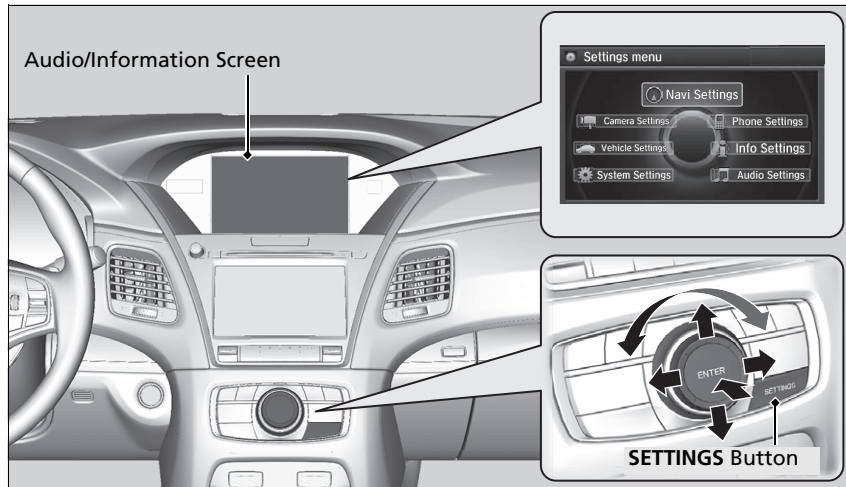

■ How to customize

Select your desired setting item by pressing the **SETTINGS** button, then rotating  while the power mode is in ON and the vehicle is at a complete stop. Press .



▣ Customized Features

When you customize setting, make sure that the vehicle is at a complete stop and shift to **[P]**.

To customize other features, rotate , move ,  or , and press .

▣ **List of customizable options** P. 304

■ Customization flow

Press the **SETTINGS** button.

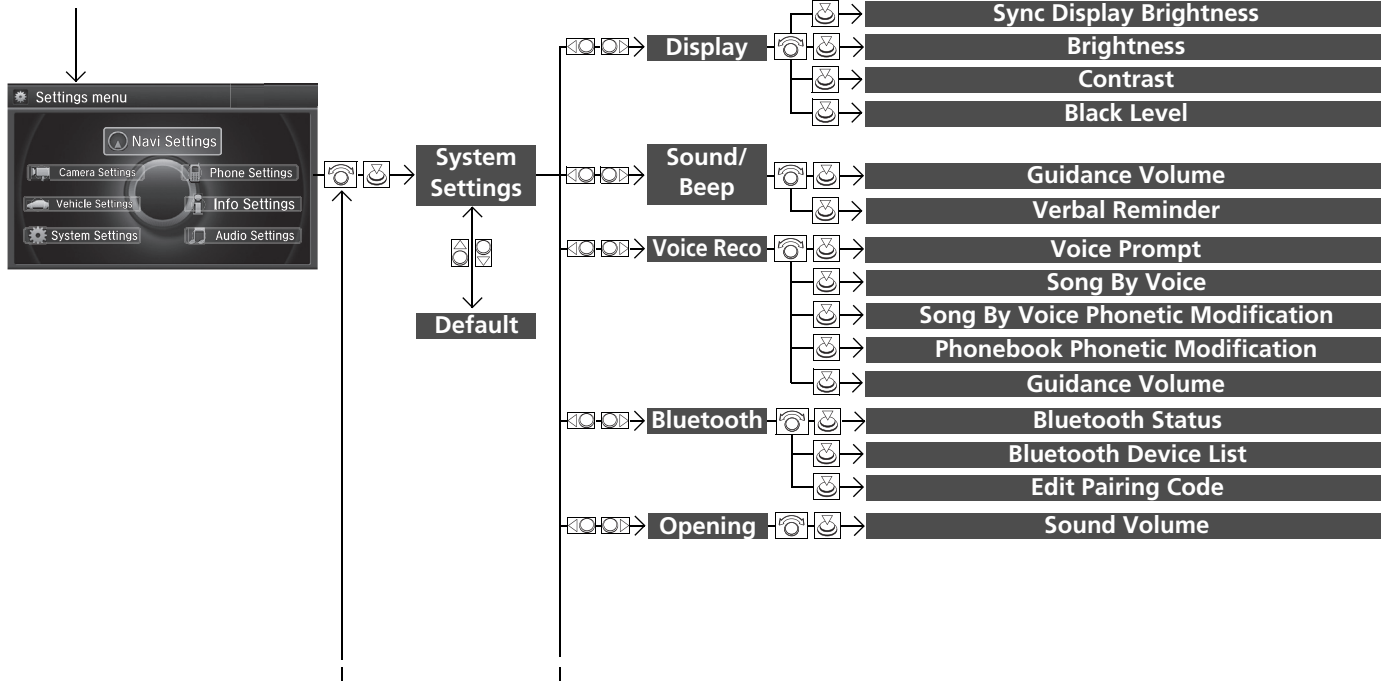

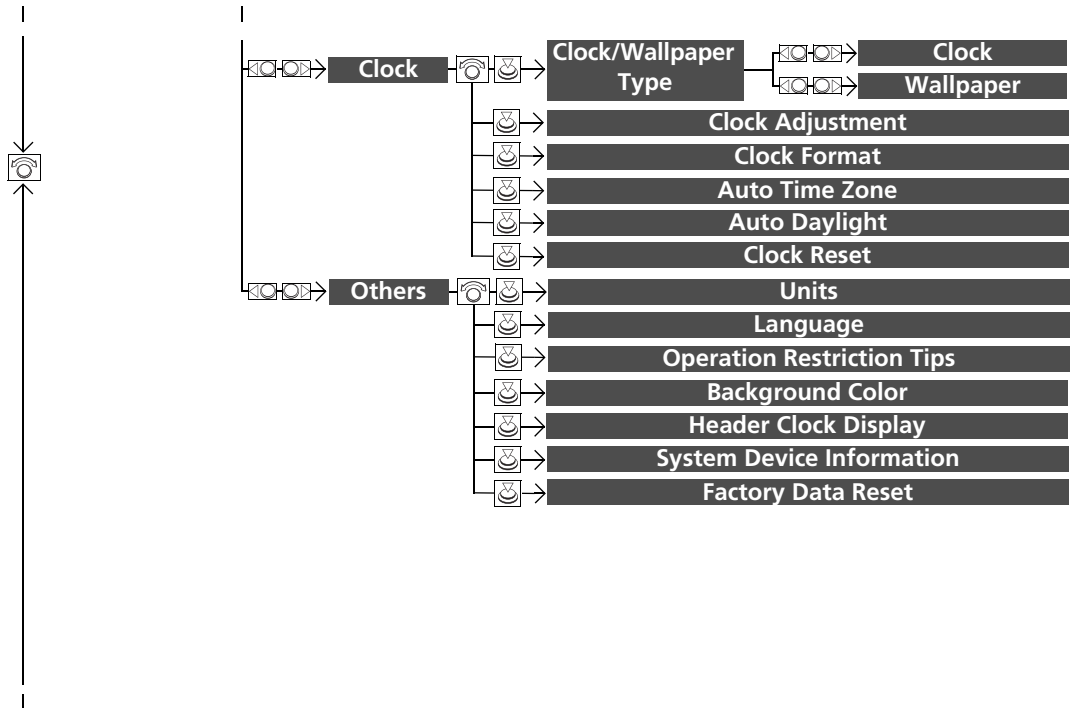

Features

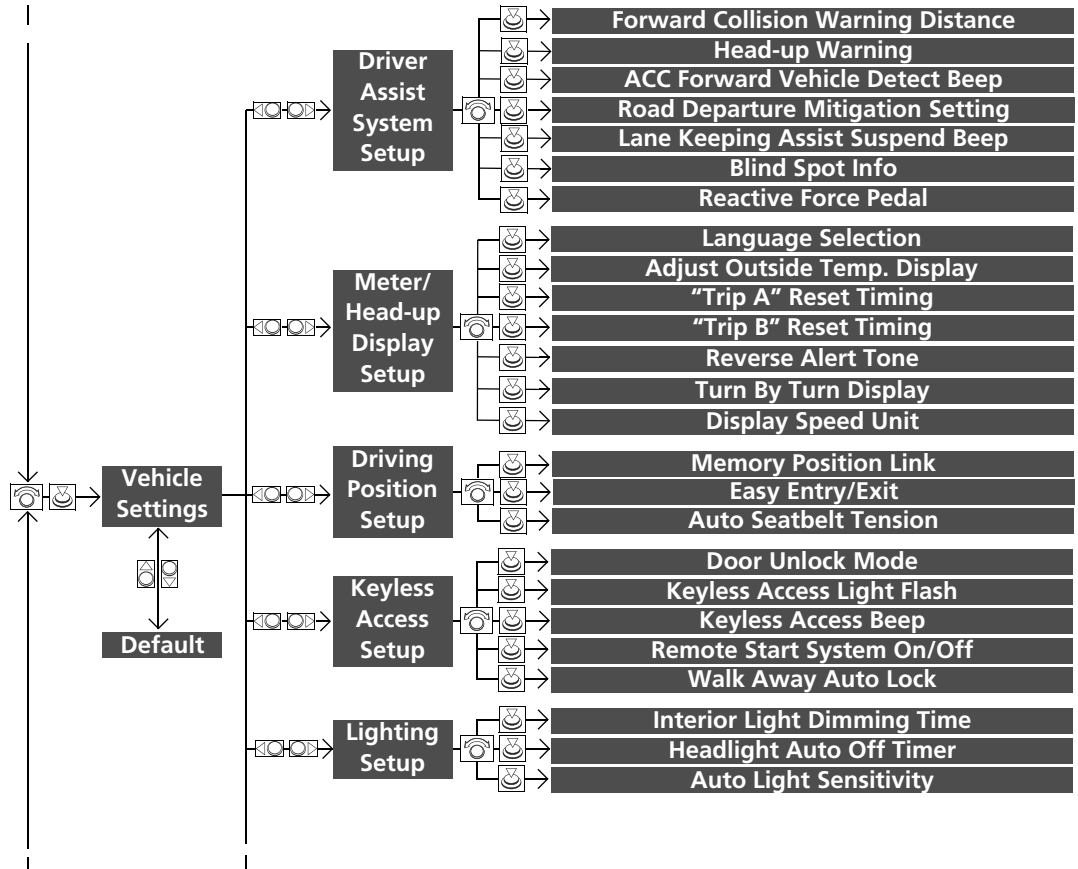

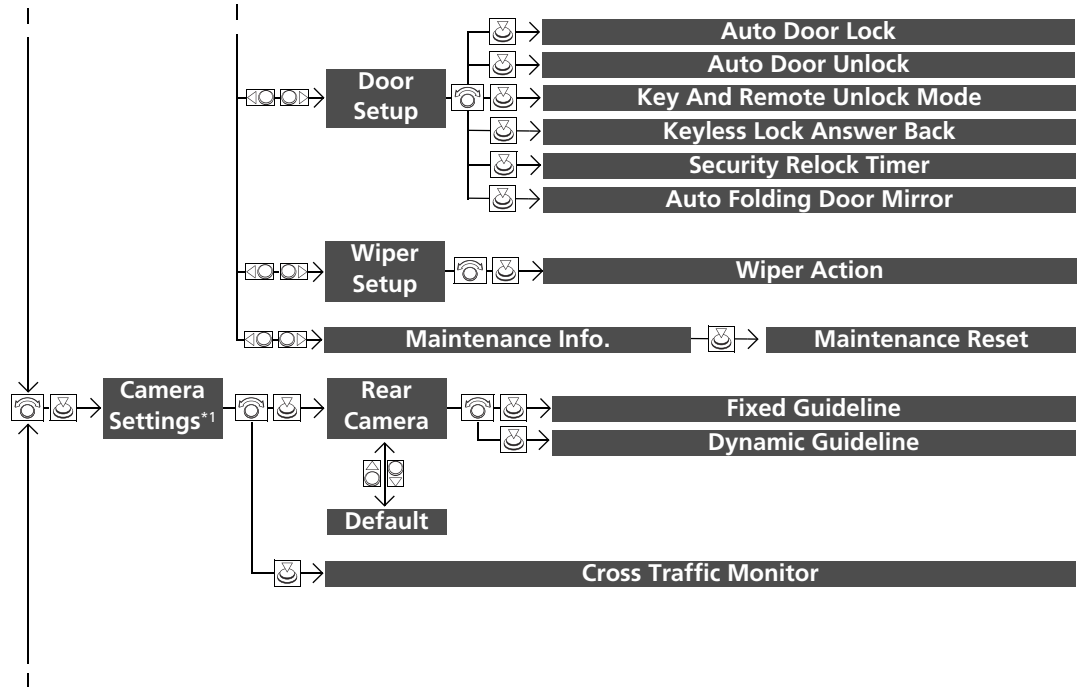

Features

*1: Models with multi-view rear camera

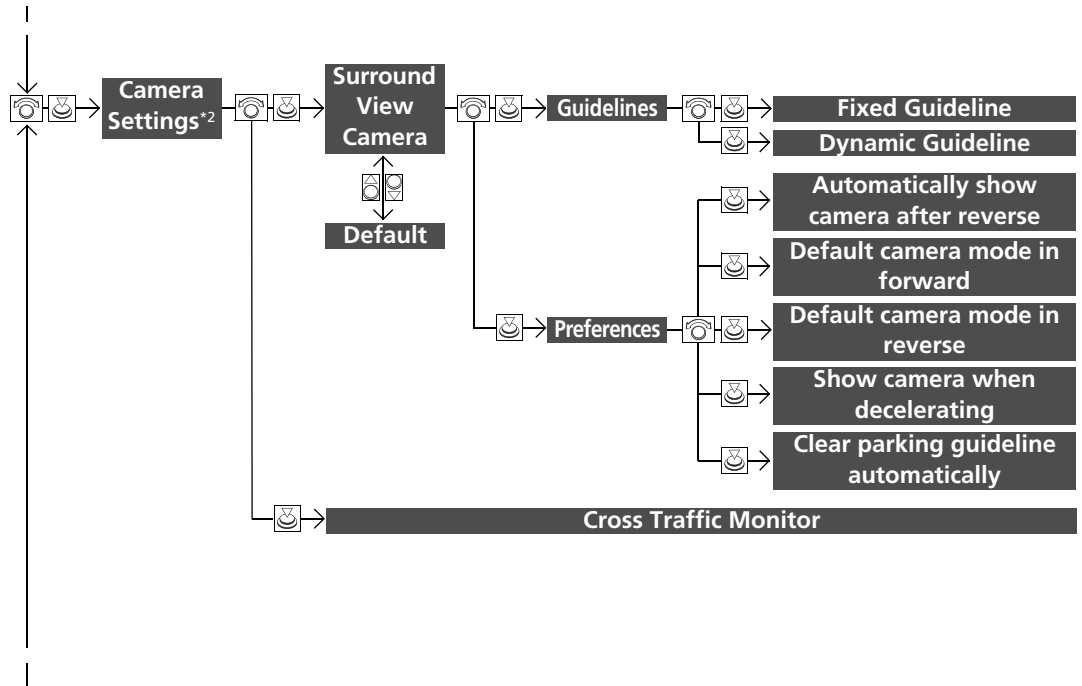

*2: Models with surround view camera system

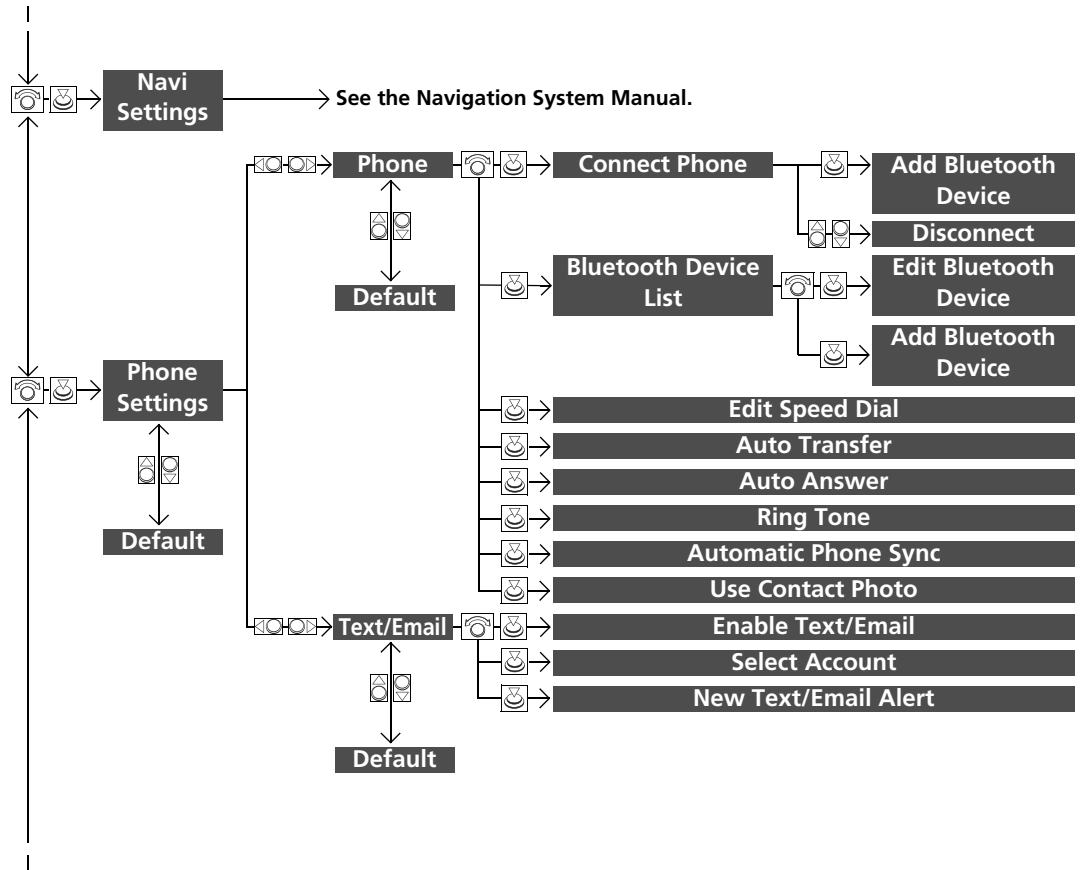

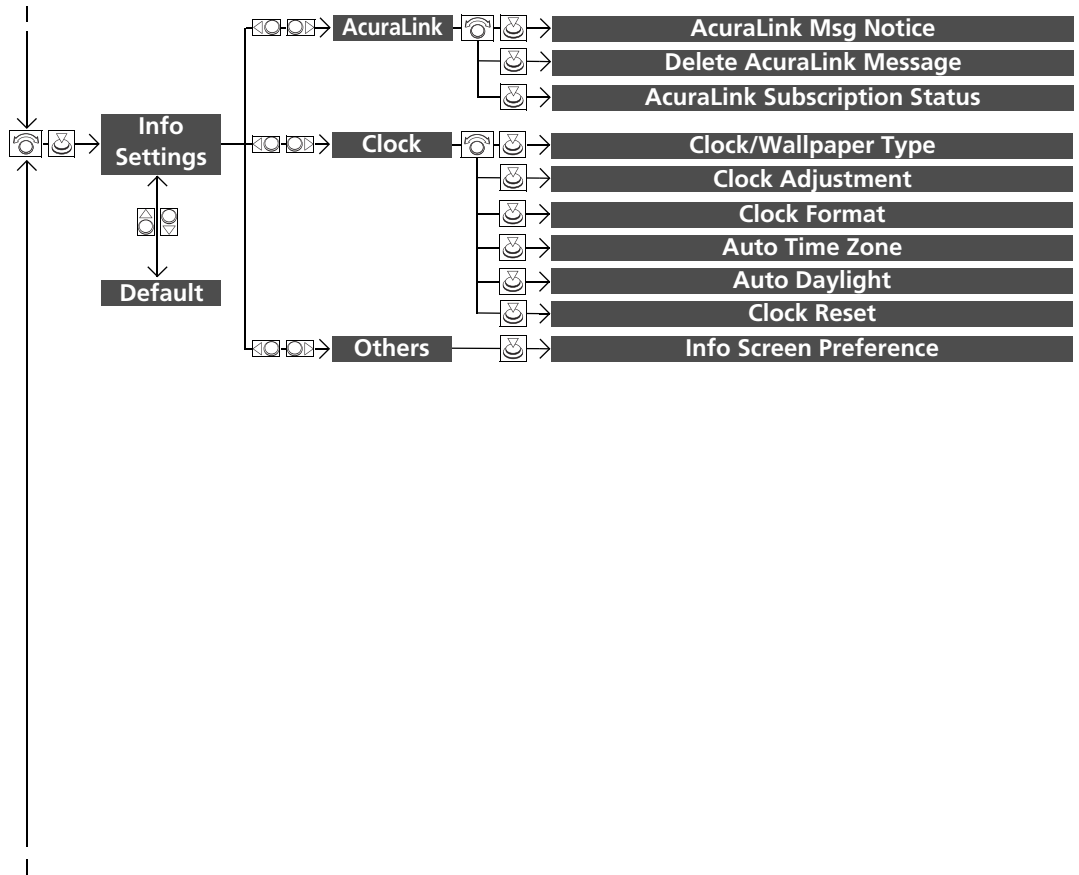

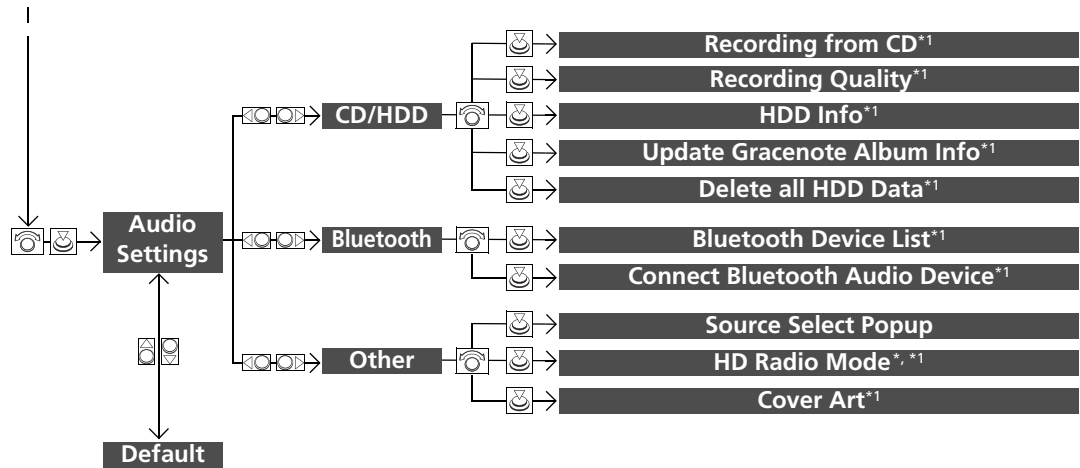

* 1: May change depending on your currently selected source.

* Not available on all models

■ List of customizable options

Setup Group	Customizable Features	Description	Selectable Settings	
System Settings	Display	Sync Display Brightness	Selects whether the display brightness synchronizes with the instrument panel brightness.	On^{*1}/Off
		Brightness	Changes the brightness of the audio/information screen.	—
		Contrast	Changes the contrast of the audio/information screen.	—
		Black Level	Changes the black level of the audio/information screen.	—
	Sound/Beep	Guidance Volume	Changes the volume of the audio speakers.	0 ~ 6^{*1} ~ 11
		Verbal Reminder	Turns the verbal reminders on and off.	On^{*1}/Off
		Voice Prompt	Turns the voice prompt on and off.	On^{*1}/Off
	Voice Reco	Song By Voice	Turns the Song By Voice™ on and off. ➤ Song By Voice™ (SBV) P. 262	On^{*1}/Off
		Song By Voice Phonetic Modification	Modifies a voice command for music stored in the HDD or an iPod. ➤ Phonetic Modification P. 264	—
		Phonebook Phonetic Modification	Modifies a voice command for the phonebook. ➤ Phonebook Phonetic Modification P. 344	—
Guidance Volume		Changes the volume of the voice prompt.	0 ~ 6^{*1} ~ 11	

*1: Default Setting

Setup Group	Customizable Features	Description	Selectable Settings	
System Settings	Bluetooth Status	Turns the <i>Bluetooth</i> ® on and off.	On*¹/Off	
	Blue-tooth	Bluetooth Device List	Pairs a new phone to HFL, edits and deletes a paired phone, and creates a security PIN. ▶ Phone Setup P. 330	—
		Edit Pairing Code	Changes a pairing code. ▶ To change the pairing code setting P. 332	Random/Fixed*¹
	Opening	Sound Volume	Changes the volume of the system's startup sound.	0 ~ 6*¹ ~ 11
	Clock/Wallpaper Type	Clock	Changes the clock display type.	Analog/Digital*¹/Small Digital/Off
		Wallpaper	<ul style="list-style-type: none"> Changes the wallpaper type. Imports an image file for a new wallpaper. Deletes an image file for a wallpaper. ▶ Wallpaper Setup P. 228	Blank/Galaxy*¹/Metallic
	Clock	Clock Adjustment	Adjusts Clock. ▶ Clock P. 128	—
		Clock Format	Selects the digital clock display from 12H to 24H.	12H*¹/24H
		Auto Time Zone	Sets the navigation system to automatically adjust the clock when driving through different time zones.	On*¹/Off

*1:Default Setting

Setup Group	Customizable Features	Description	Selectable Settings	
System Settings	Clock	Auto Daylight	Sets the navigation system to automatically adjust the clock ("spring ahead" or "fall back" by one hour) when a daylight saving time change occurs.	On ^{*1} /Off
		Clock Reset	Resets the settings of all items in the Clock group.	—
	Others	Units	Changes the distance unit on the navigation map screen.	mile ^{*1} /km (U.S.) mile/km ^{*1} (Canada)
		Language	Changes the display language.	English ^{*1} /Français/ Español
		Operation Restriction Tips	Alerts you when manual control of the system is disabled to prevent distraction while driving. Only voice commands are available.	On ^{*1} /Off
		Background Color	Changes the background color of the audio/information screen and the On Demand Multi-Use Display™.	Blue ^{*1} /Amber/Red/ Green
		Header Clock Display	Selects whether the clock display comes on.	On/Off ^{*1}
		System Device Information	Displays the system/device information.	—
		Factory Data Reset	Resets all the settings to their factory default. <input checked="" type="checkbox"/> Defaulting All the Settings P. 319	—
		Default	Cancels /Resets all customized items in the System Settings group as default.	Default/OK

*1: Default Setting

Setup Group	Customizable Features	Description	Selectable Settings
Vehicle Settings Driver Assist System Setup	Forward Collision Warning Distance	Changes at which distance the CMBS™ alerts.	Long/Normal*¹/Short
	Head-up Warning	Turns the head-up warning on and off.	On*¹/Off
	ACC Forward Vehicle Detect Beep	Causes the system to beep when the system detects a vehicle, or when the vehicle goes out of the ACC with Low Speed Follow range.	On/Off*¹
	Road Departure Mitigation Setting	Changes the setting for the road departure mitigation system.	Narrow/Normal*¹/Wide/Warning Only
	Lane Keeping Assist Suspend Beep	Causes the system to beep when the LKAS is suspended.	On/Off*¹
	Blind Spot Info	Changes the setting for the blind spot information system.	Audible And Visual Alert*¹/Visual Alert/Off
	Reactive Force Pedal	Change the amount of the accelerator pedal resistance force.	High Force/Low Force*¹

*1:Default Setting

Setup Group	Customizable Features	Description	Selectable Settings	
Vehicle Settings	Meter/Head-up Display Setup	Language Selection	Changes the displayed language on the multi-information display.	English^{*1}/Français/Español
		Adjust Outside Temp. Display	Adjusts the temperature reading by a few degrees.	-5°F ~ ±0°F^{*1} ~ +5°F (U.S.) -3°C ~ ±0°C^{*1} ~ +3°C (Canada)
		"Trip A" Reset Timing	Changes the setting of how to reset trip meter A, average fuel economy A, average speed A, and elapsed time A.	When Refueled/IGN Off/Manually Reset^{*1}
		"Trip B" Reset Timing	Changes the setting of how to reset trip meter B, average fuel economy B, average speed B, and elapsed time B.	When Refueled/IGN Off/Manually Reset^{*1}
		Reverse Alert Tone	Turns the reverse alert tone on and off.	On^{*1}/Off
		Turn By Turn Display	Selects whether the turn-by-turn display comes on during the route guidance.	On^{*1}/Off
		Display Speed Unit	Changes the speed unit for ACC with Low Speed Follow on the multi-information display, and the speed unit on the head-up display.	km/h/mph^{*1} (U.S.) km/h^{*1}/mph (Canada)

*1:Default Setting

Setup Group	Customizable Features	Description	Selectable Settings	
Vehicle Settings	Memory Position Link	Turns the driving position memory system on and off.	On^{*1}/Off	
	Driving Position Setup	Easy Entry/Exit	Moves the seat fully rearward and steering wheel fully up when you get in/get out of the vehicle. Changes the setting for this feature.	Seat & Steering Wheel^{*1}/Seat Only/Steering Wheel Only/Off
		Auto Seatbelt Tension	Turns the auto seat belt tension setting for the seat belt e-pretensioner on and off.	On^{*1}/Off
		Door Unlock Mode	Changes which doors unlock when you grab the driver's door handle.	Driver Door Only^{*1}/All Doors
		Keyless Access Light Flash	Causes some exterior lights to flash when you unlock/lock the doors.	On^{*1}/Off
	Keyless Access Setup	Keyless Access Beep	Causes the beeper to sound when you unlock/lock the doors.	On^{*1}/Off
		Remote Start System On/Off	Turns the remote engine start feature on and off.	On^{*1}/Off
		Walk Away Auto Lock	Changes the settings for the auto lock function when you walk away from the vehicle.	On/Off^{*1}

*1:Default Setting

Setup Group	Customizable Features	Description	Selectable Settings	
Vehicle Settings	Lighting Setup	Interior Light Dimming Time	Changes the length of time the interior lights stay on after you close the doors.	60seconds/ 30seconds*¹/ 15seconds
		Headlight Auto Off Timer	Changes the length of time the exterior lights stay on after you close the driver's door.	60seconds/ 30seconds/ 15seconds*¹/ 0seconds
		Auto Light Sensitivity	Changes the timing for the headlights to come on.	Max/High/Mid*¹/ Low/Min
	Door Setup	Auto Door Lock	Changes the setting for when the doors automatically lock.	With Vehicle Speed*¹/Shift from P/Off
		Auto Door Unlock	Changes the setting for when the doors automatically unlock.	All Doors When Driver's Door Opens*¹/All Doors When Shifted to Park/All Doors When Ignition Switched Off/Off
		Key And Remote Unlock Mode	Sets up either the driver's door or all doors to unlock on the first push of the remote.	Driver Door*¹/All Doors
		Keyless Lock Answer Back	LOCK/UNLOCK- The exterior lights flash. LOCK (2nd push)- The beeper sounds.	On*¹/Off

*1:Default Setting

Setup Group	Customizable Features	Description	Selectable Settings	
Vehicle Settings	Door Setup	Security Relock Timer	Changes the time it takes for the doors to relock and the security system to set after you unlock the vehicle without opening any door.	90seconds/ 60seconds/ 30seconds*¹
		Auto Folding Door Mirror	Changes how you can fold the door mirrors.	Auto Fold With Keyless*¹/Manual Only
	Wiper Setup	Wiper Action	Changes the setting for the automatic intermittent wipers in the AUTO position.	Rain Sensing*¹/ Intermittent/Speed Sensitive
	Maintenance Info.	Maintenance Reset	Resets the engine oil life display when you have performed the maintenance service.	—
	Default		Cancels/Resets all customized items in the Vehicle Settings group as default.	Default/OK
Models with multi-view rear camera Camera Settings	Rear Camera	Fixed Guideline	Selects whether the fixed guidelines come on the rear camera monitor.	On*¹/Off
		Dynamic Guideline	Selects whether the dynamic guidelines come on the rear camera monitor.	On*¹/Off
		Default	Cancels/Resets all customized items in the Rear Camera group as default.	Default/OK
	Cross Traffic Monitor	Turns the cross traffic monitor feature on and off.	On*¹/Off	



*1:Default Setting

Setup Group	Customizable Features	Description	Selectable Settings	
<div style="border: 1px solid black; padding: 2px; display: inline-block; margin-bottom: 5px;">Models with surround view camera system</div> Camera Settings	Guidelines	Fixed Guideline	Sets whether to turn on the reference line display. On*¹/Off	
		Dynamic Guideline	Sets whether to turn on the projection line display. On*¹/Off	
	Surround View Camera	Automatically show camera after reverse	Sets the rear view to be automatically switched to the front view when the gear is shifted out of [R] . On*¹/Off	
		Preferences	Default camera mode in forward	Selects which screen to display when the surround view camera system is turned on while the vehicle is moving forward. Front Ground View*¹/Last Used/ Front Blind View/ Side View
			Default camera mode in reverse	Sets which screen to display when the surround view camera system is turned on while the vehicle is reversing. Rear Ground View*¹/Last Used/ Rear View/Rear Wide View

*1:Default Setting

Setup Group	Customizable Features		Description	Selectable Settings
Models with surround view camera system Camera Settings	Surround View Camera	Preferences	Show camera when decelerating Sets the screen to automatically return to the camera view at vehicle speeds of 7 mph (12 km/h) or lower. The screen can return only when the display has been switched to the audio/information screen at the vehicle speed of over 9 mph (15 km/h).	On^{*1}/Off
			Clear parking guidance automatically Turns the parking guide lines on and off.	On^{*1}/Off
		Default Cancels/Resets all customized items in the Camera Settings group as default.	Default/OK	
		Cross Traffic Monitor Turns the cross traffic monitor feature on and off.	On^{*1}/Off	

*1:Default Setting

Setup Group	Customizable Features	Description	Selectable Settings	
Phone Settings	Phone	Connect Phone	Pairs a new phone to HFL, connects or disconnects a paired phone.  Phone Setup P. 330	—
		Bluetooth Device List	Pairs a new phone to HFL, edits or deletes a paired phone, or creates a security PIN.  Phone Setup P. 330	—
		Edit Speed Dial	Edits, adds or deletes a speed dial entry.  Phone Setup P. 330	—
		Auto Transfer	Sets calls to automatically transfer from your phone to HFL when you enter the vehicle.	On^{*1}/Off
		Auto Answer	Sets whether to automatically answer an incoming call after about four seconds.	On/Off^{*1}
		Ring Tone	Selects the ring tone.	Fixed/Mobile Phone^{*1}/Off
		Automatic Phone Sync	Sets a phonebook data to be automatically imported when a phone is paired to HFL.	On^{*1}/Off
		Use Contact Photo	Displays a caller's picture on an incoming call screen.	On^{*1}/Off

*1:Default Setting

Setup Group	Customizable Features	Description	Selectable Settings
Phone Settings	Enable Text/Email	Turns the text/e-mail message function on and off.	On^{*1}/Off
	Select Account	Selects a text/e-mail message account.	—
	New Text/Email Alert	Selects whether a pop-up alert comes on the screen when HFL receives a new text/e-mail message.	On/Off^{*1}
	Default	Cancels/Resets all customized items in the Phone Settings group as default.	Default/OK

*1:Default Setting

Setup Group	Customizable Features	Description	Selectable Settings
Acura Link	AcuraLink Msg Notice	Selects whether newly received AcuraLink messages to be displayed.	On^{*1}/Off
	Delete AcuraLink Message	Deletes AcuraLink messages.	—
	AcuraLink Subscription Status	Displays your current AcuraLink subscription status.	—
Info Settings	Clock/ Wallpaper Type	Clock _____	See System Settings on P. 304 to P. 306.
		Wallpaper	
	Clock Adjustment	_____	
	Clock Format	_____	
	Auto Time Zone	_____	
	Auto Daylight	_____	
	Clock Reset	_____	
Other	Info Screen Preference	Selects the top menu when the INFO button is pressed. <ul style="list-style-type: none"> • Info Top- A brief menu pops up. • Info Menu- A full menu pops up. • Off- A menu does not pop up. 	Info Top/Info Menu^{*1}/Off
Default		Cancels/Resets all customized items in the Info Settings group as default.	Default/OK

*1: Default Setting

Setup Group	Customizable Features	Description	Selectable Settings
Audio Settings	CD mode Recording from CD	Selects whether the songs on music CDs are automatically recorded to the HDD.	Auto^{*1}/Manual
	CD mode Recording Quality	Selects the quality of the music files recorded to the HDD.	Standard^{*1}/High
	HDD mode HDD Info	Displays the HDD capacity.	—
	CD or HDD mode Update Gracenote Album Info	Updates the Gracenote® Album Info (Gracenote® Media Database).	Update by CD/ Update by USB
	HDD mode Delete All HDD Data	 Delete all HDD Data P. 320	—
	Bluetooth	Bluetooth® Audio or Pandora®* mode Bluetooth Device List	Edits or deletes a <i>Bluetooth®</i> Audio device paired to HFL.
Bluetooth® Audio or Pandora®* mode Connect Bluetooth Audio Device		Connects, disconnects or pairs a <i>Bluetooth®</i> Audio device to HFL.	—

*1:Default Setting

* Not available on all models

Setup Group	Customizable Features	Description	Selectable Settings
Audio Settings	Source Select Popup	Selects whether the list of selectable audio sources comes on when the AUDIO button is pressed.	On/Off *1
	Other AM/FM mode HD Radio Mode *	Selects whether the audio system automatically switches to the digital radio waves or receives the analogue waves only.	Auto *1/ Analog
	CD (MP3/WMA/AAC), iPod, USB or Pandora®* mode Cover Art	Turns on and off the cover art display.	On *1/ Off
	Default	Cancels/Resets all customized items in the Audio Settings group as default.	Default/OK

*1: Default Setting

Defaulting All the Settings

You can reset all the menu and customized settings as the factory defaults.



1. Press the **SETTINGS** button.
2. Rotate to select **System Settings**, then press .
3. Move or to select the **Others** tab.
4. Rotate to select **Factory Data Reset**, then press .
 - The pop-up menu appears on the screen.
5. Rotate to select **Yes**, then press .
 - The confirmation message will appear.
6. Rotate to select **Yes**, then press again to reset the settings.
 - The confirmation message will appear. Press to select **OK**.

Defaulting All the Settings

When you transfer the vehicle to a third party, reset all settings to default and delete all personal data.

The following settings will be reset:

- Routing & Guidance: Rerouting, Unverified Area Routing, Traffic Rerouting, Edit Waypoint Search Area, Guidance Mode, Street Name Guidance
- Route Preference
- Audio preset settings
- Phonebook entries
- Other display and each item settings.

Deleting all HDD Data

You can reset all the menu and customized settings, and delete all music data on the HDD.

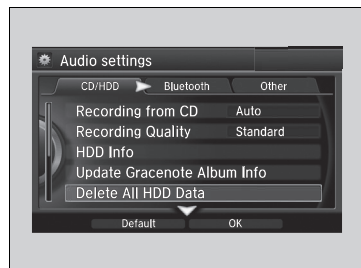

1. Turn on the audio system and select the HDD mode.
2. Press the **SETTINGS** button.
3. Rotate to select **Audio Settings**, then press .
4. Move or to select the **CD/HDD** tab.
5. Rotate to select **Delete all HDD Data**, then press .
 - ▶ The confirmation message will appear.
6. Rotate to select **Yes**, then press .

The HomeLink® Universal Transceiver can be programmed to operate up to three remote controlled devices around your home, such as garage doors, lighting, or home security systems.

■ Important Safety Precautions

Refer to the safety information that came with your garage door opener to test that the safety features are functioning properly. If you do not have the safety information, contact the manufacturer.

Before programming HomeLink, make sure that people and objects are out of the way of the garage or gate to prevent potential injury or damage.

When programming a garage door opener, park just outside the garage door's path.

⌘ HomeLink® Universal Transceiver

Before programming HomeLink to operate a garage door opener, confirm that the opener has an external entrapment protection system, such as an "electronic eye," or other safety and reverse stop features. If it does not, HomeLink may not be able to operate it.

Training HomeLink

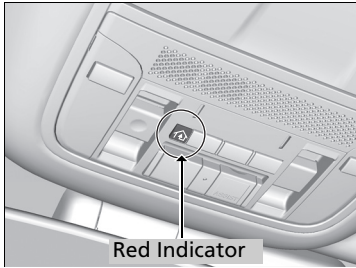

If it is necessary to erase a previously entered learned code:

- Press and hold the two outside buttons for about 20 seconds, until the red indicator blinks. Release the buttons, and proceed to step 1.
- If you are training the second or third button, go directly to step 1.

The instructions on the next page should work for most gate or garage openers, but may not work for all. For detailed instructions about your specific remote opener, visit <http://www.homelink.com> or call (800) 355-3515.

Training a Button

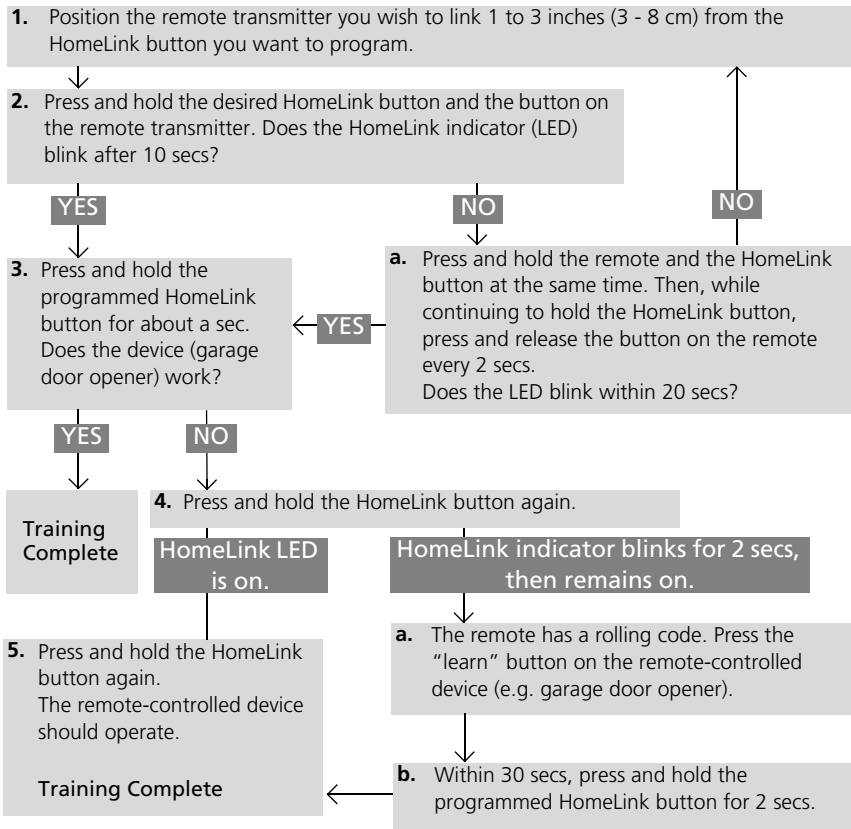

Training HomeLink

Retraining a Button
 If you want to retrain a programmed button for a new device, you do not have to erase all button memory. You can replace the existing memory code using this procedure:

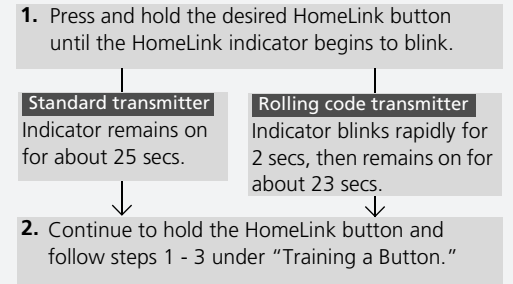

Erasing Codes
 To erase all the codes, press and hold the two outside buttons until the HomeLink indicator begins to blink (about 10 to 20 secs). You should erase all codes before selling the vehicle.

If you have any problems, see the device's instructions, visit www.homelink.com, or call HomeLink at (800) 355-3515.

HomeLink® is a registered trademark of Gentex Corporation.

Bluetooth® HandsFreeLink® (HFL) allows you to place and receive phone calls using your vehicle's navigation system, without handling your cell phone.

Using HFL

HFL Buttons

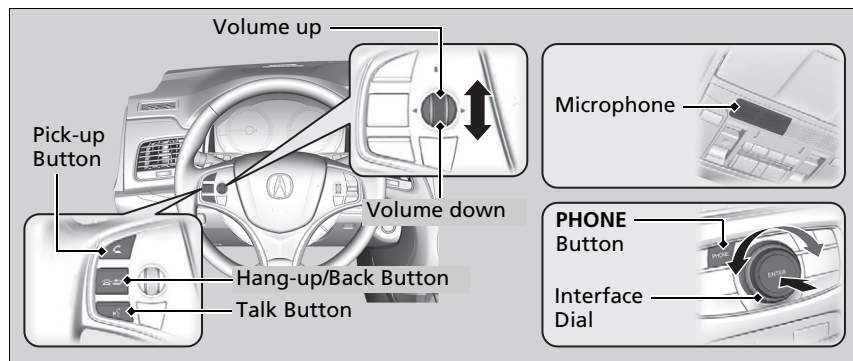





 **(Pick-up) button:** Press to go to the **Speed Dial/Call History** on the multi-information display or the head-up display, or to answer an incoming call.

 **(Hang-up/back) button:** Press to end a call, to cancel a command or to clear the phone information on the multi-information display or the head-up display.

 **(Talk) button:** Press to give HFL voice commands.

PHONE button: Press to go directly to the Phone screen.

Interface dial: Rotate  to select an item on the screen, then press . Move ,  or  to select secondary menu.

Bluetooth® HandsFreeLink®

Place your phone where you can get good reception.

To use HFL, you need a *Bluetooth*-compatible cell phone. For a list of compatible phones, pairing procedures, and special feature capabilities:

- U.S.: Visit www.Handsfreelink.com/Acura, or call 1-888-528-7876.
- Canada: For more information on smartphone compatibility, call 1-888-528-7876.

To use HFL, the **Bluetooth** setting must be **On**.

 **Customized Features** P. 295

Voice control tips:

- Aim the vents away from the ceiling and close the windows, as noise coming from them may interfere with the microphone.
- Press and release the  button when you want to call a number using a stored voice tag, a phonebook name, or a number. Speak clearly and naturally after a beep.
- If the microphone picks up voices other than yours, the command may be misinterpreted.
- To change the volume level, use the audio system's volume knob or the remote audio controls on the steering wheel.

State or local laws may prohibit the operation of handheld electronic devices while operating a vehicle.

HFL Status Display

The audio/information screen notifies you when there is an incoming call.

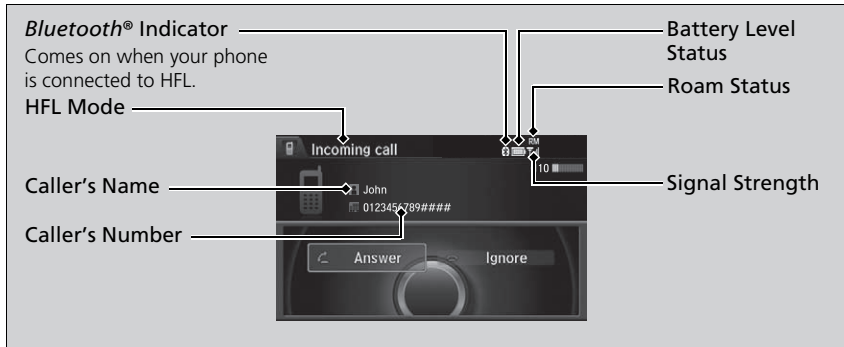

Limitations for Manual Operation

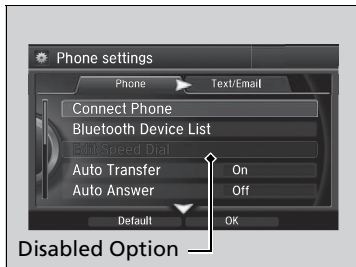

Certain manual functions are disabled or inoperable while the vehicle is in motion. You cannot select a grayed-out option until the vehicle is stopped.

Only previously stored speed dial entries with voice tags, phonebook names, or numbers can be called using voice commands while the vehicle is in motion.

▶ **Speed Dial** P. 341

Bluetooth® HandsFreeLink®

Bluetooth® Wireless Technology

The *Bluetooth*® word mark and logos are registered trademarks owned by Bluetooth SIG, Inc., and any use of such marks by Honda Motor Co., Ltd., is under license. Other trademarks and trade names are those of their respective owners.

HFL Limitations

An incoming call on HFL will interrupt the audio system when it is playing. It will resume when the call is ended.

If you receive a call while using the audio system, the system resumes its operation after ending the call.

HFL Status Display

The information that appears on the audio/information screen varies between phone models.

You can change the system language.

▶ **Customized Features** P. 295

HFL Menus

The power mode must be in ACCESSORY or ON to use HFL.

■ Phone Settings screen



1. Press the **SETTINGS** button.
2. Rotate to select **Phone Settings**, then press .

▶▶ HFL Menus

To use HFL, you must first pair your *Bluetooth*-compatible cell phone to the system while the vehicle is parked.

Some functions are limited while driving. A message appears on the screen when the vehicle is moving and the operation is canceled.

Features

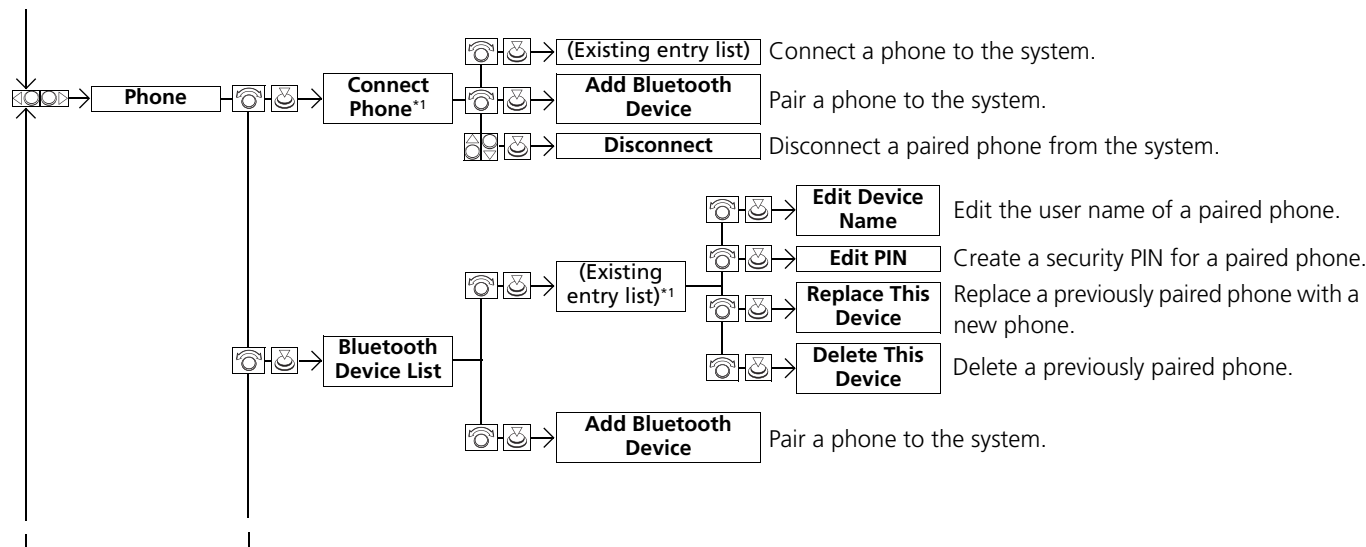

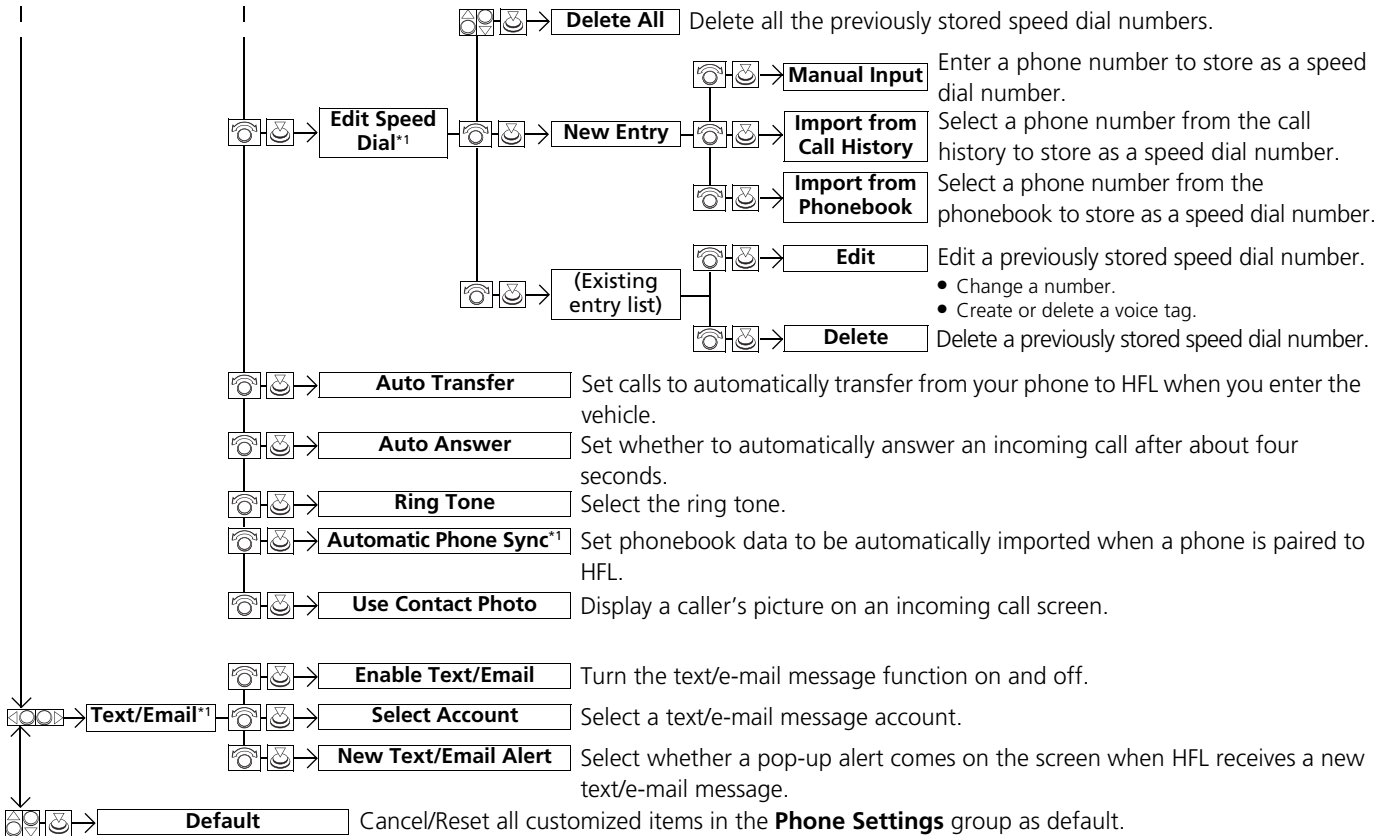

*1: Appears only when a phone is connected to HFL.

■ Phone screen



1. Press the **PHONE** button.
2. Press the **MENU** button to display the menu items.

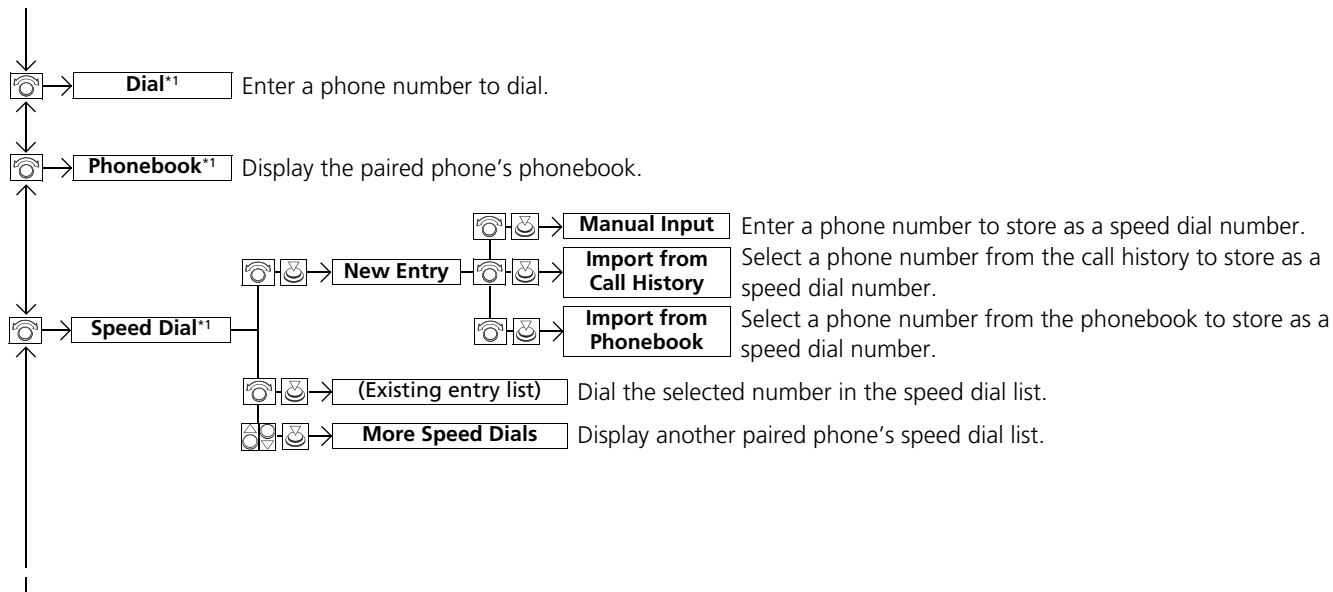

*1: Appears only when a phone is connected to HFL.

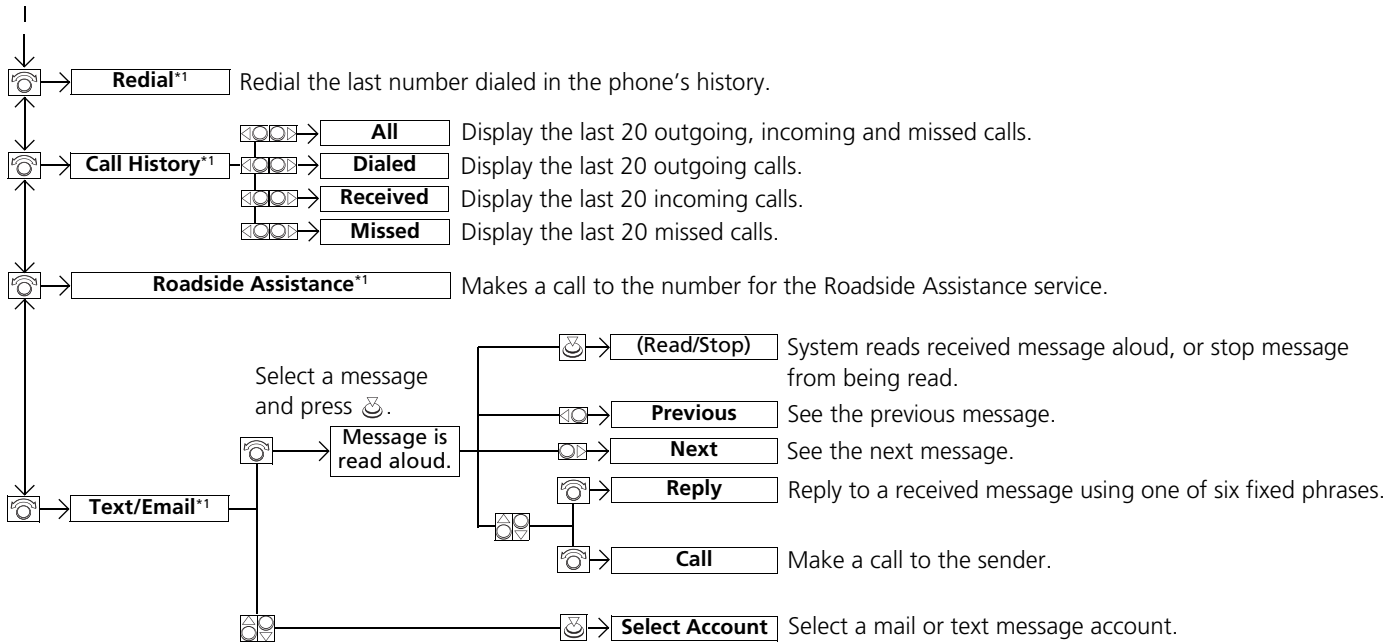

*1: Appears only when a phone is connected to HFL.

Phone Setup

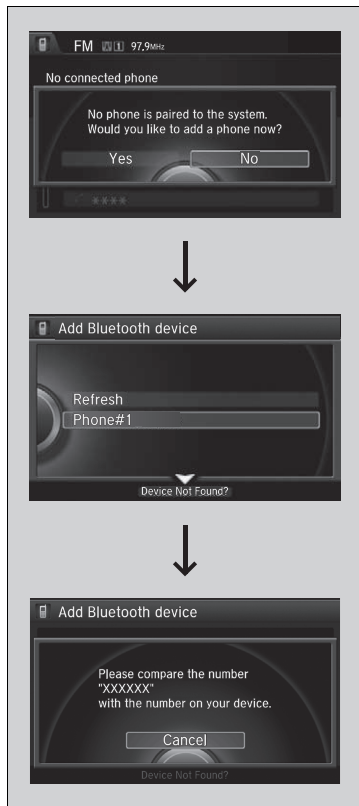

■ To pair a cell phone (when there is no phone paired to the system)

1. Press the **PHONE** button.
2. Rotate to select **Yes**, then press .
3. Make sure your phone is search or discoverable mode, then press .
 - ▶ HFL automatically searches for a *Bluetooth* device.
4. When your phone appears on the list, select it by pressing .
 - ▶ If your phone does not appear, you can select **Refresh** to search again.
 - ▶ If your phone still does not appear, move to select **Device Not Found?** and search for *Bluetooth* devices using your phone. From your phone, select **HandsFreeLink**.
5. HFL gives you a pairing code on the audio/information screen.
 - ▶ Confirm if the pairing code on the screen and your phone match. This may vary by phone.
6. You will receive a notification on the screen if pairing is successful.

☞ Phone Setup

Your *Bluetooth*-compatible phone must be paired to HFL before you can make and receive hands-free calls.

Phone Pairing Tips:

- You cannot pair your phone while the vehicle is moving.
- Up to six phones can be paired.
- Your phone's battery may drain faster when it is connected to HFL.
- If your phone is not ready for pairing or not found by the system within three minutes, the system will time out and returns to idle.

Once you have paired a phone, you can see it displayed on the screen with one or two icons on the right side.

These icons indicate the following:

- : The phone can be used with HFL.
- : The phone is compatible with *Bluetooth*® Audio.

When pairing is completed, an **Automatic Phone Sync** prompt appears. Select **On** if you want your call history and phonebook automatically imported to HFL.

▶ **Changing the Automatic Phone Sync setting** P. 340

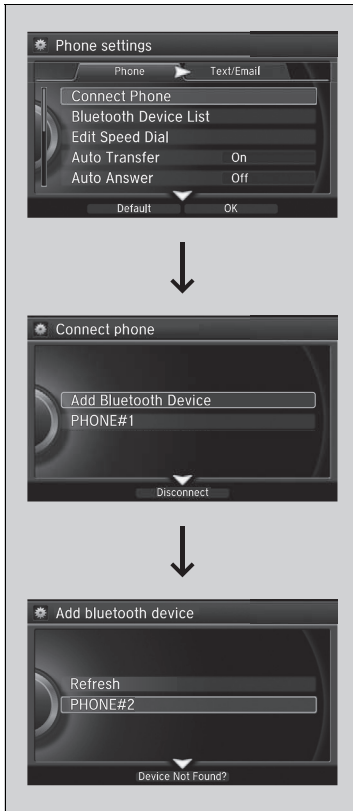

■ **To pair a cell phone (when a phone has already been paired to the system)**

1. Press the **SETTINGS** button.
2. Rotate to select **Phone Settings**, then press .
3. Move or to select the **Phone** tab.
4. Rotate to select the **Connect Phone**, then press .
 - ▶ Repeat the procedure to select **Add Bluetooth Device**.
5. Make sure your phone is in search or discoverable mode, then press .
 - ▶ HFL automatically searches for a *Bluetooth* device.
6. When your phone appears on the list, select it by pressing .
 - ▶ If your phone does not appear, you can select **Refresh** to search again.
 - ▶ If your phone still does not appear, move to select **Device Not Found?** and search for *Bluetooth* devices using your phone. From your phone, select **HandsFreeLink**.
7. HFL gives you a pairing code on the audio/information screen.
 - ▶ Confirm if the pairing code on the screen and your phone match. This may vary by phone.
8. You will receive a notification on the screen if pairing is successful.

Continued

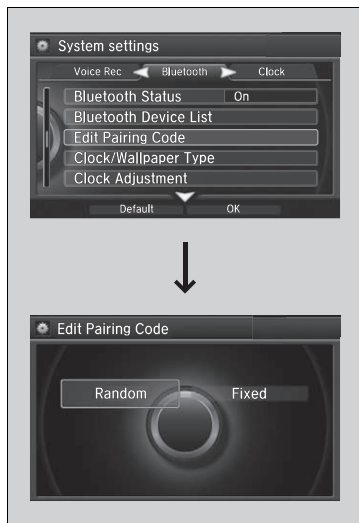

■ **To change the pairing code setting**

1. Press the **SETTINGS** button.
2. Rotate to select **System Settings**, then press .
3. Move or to select the **Bluetooth** tab.
4. Rotate to select **Edit Pairing Code**, then press .
5. Rotate to select **Fixed** or **Random**, then press .

▶▶ **To change the pairing code setting**

The pairing code may be six or four digits depending on your phone.

The default pairing code is **0000** until you change the setting.

To create your own, select **Fixed**, and delete the current code, then enter a new one.

For a randomly generated pairing code each time you pair a phone, select **Random**.

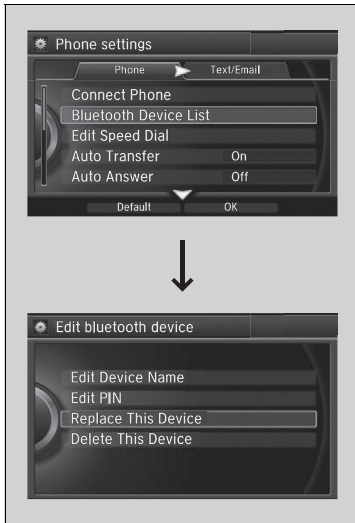

■ **To replace an already-paired phone with a new phone**

1. Press the **SETTINGS** button.
2. Rotate to select **Phone Settings**, then press .
3. Move or to select the **Phone** tab.
4. Rotate to select **Bluetooth Device List**, then press .
5. Rotate to select a paired phone you want to replace, then press .
6. Rotate to select **Replace This Device**, then press .
7. HFL enters the pairing process and searches for a new phone.
 - ▶ Follow the prompts to pair a new phone.
8. You will receive a notification on the screen if pairing is successful.

▶▶ To replace an already-paired phone with a new phone

The replaced phone will keep the same speed dial entries, and security PIN information from the previously paired phone.

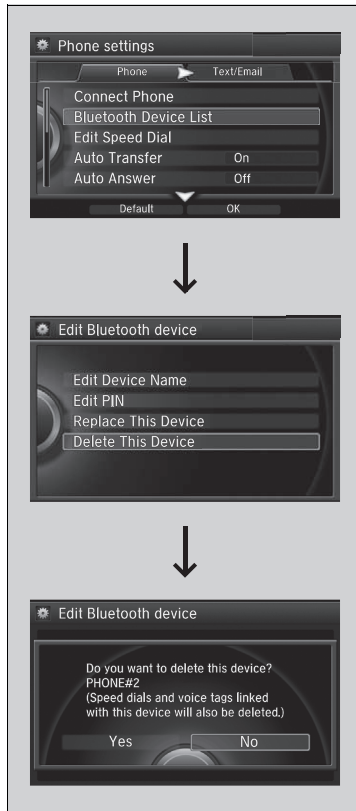

■ **To delete a paired phone**

1. Press the **SETTINGS** button.
2. Rotate to select **Phone Settings**, then press .
 - ▶ Repeat the procedure to select **Bluetooth Device List**.
3. Move or to select the **Phone** tab.
4. Rotate to select **Bluetooth Device List**, then press .
5. Rotate to select a phone you want to delete, then press .
6. Rotate to select **Delete This Device**, then press .
7. You will receive a confirmation message on the screen. Rotate to select **Yes**, then press .
8. You will receive a notification on the screen if it is successful.

To Set Up a Text/E-mail Message Option

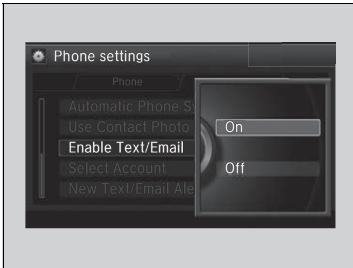

■ To turn on or off the text/e-mail message function

1. Press the **SETTINGS** button.
2. Rotate to select **Phone Settings**, then press .
3. Move or to select the **Text/Email** tab.
4. Rotate to select **Enable Text/Email**, then press .
 - ▶ A pop-up menu appears on the screen.
5. Rotate to select **On** or **Off**, then press .

■ To turn on or off the text/e-mail message notice

1. Press the **SETTINGS** button.
2. Rotate to select **Phone Settings**, then press .
3. Move or to select the **Text/Email** tab.
4. Rotate to select **New Text/Email Alert**, then press .
 - ▶ A pop-up menu appears on the screen.
5. Rotate to select **On** or **Off**, then press .



☒ To Set Up a Text/E-mail Message Option

To use the text/E-mail message function, you need a *Bluetooth*-compatible cell phone. For a list of compatible phones, pairing procedures, and special feature capabilities:

- U.S.: Visit www.HandsfreeLink.com/Acura, or call 1-888-528-7876.
- Canada: For more information on smartphone compatibility, call 1-888-528-7876.

☒ To turn on or off the text/e-mail message notice

- On:** A pop-up notification comes on every time you receive a new message.
- Off:** The message you receive is stored in the system without notification.

Continued

■ To Create a Security PIN

You can protect each of the six cell phones with a security PIN.



1. Press the **SETTINGS** button.
2. Rotate to select **Phone Settings**, then press .
3. Move or to select the **Phone** tab.
4. Rotate to select **Bluetooth Device List**, then press .
5. Rotate to select a phone you want to add a security PIN to, then press .
6. Rotate to select **Edit PIN**, then press .
7. Enter a new four-digit number.

▶ **Audio/information screen**

Rotate to select, then press . Move to delete. Rotate to select **OK** to enter the security PIN.

▶ **On Demand Multi-Use Display™**

You can also enter a number using the icons.

8. Re-enter the four-digit number.
 - ▶ The screen returns to the screen in step 4.

▶▶ To Create a Security PIN

If the phone is already security PIN protected, you need to enter the current security PIN before clearing the PIN or creating a new one.

Editing User Name

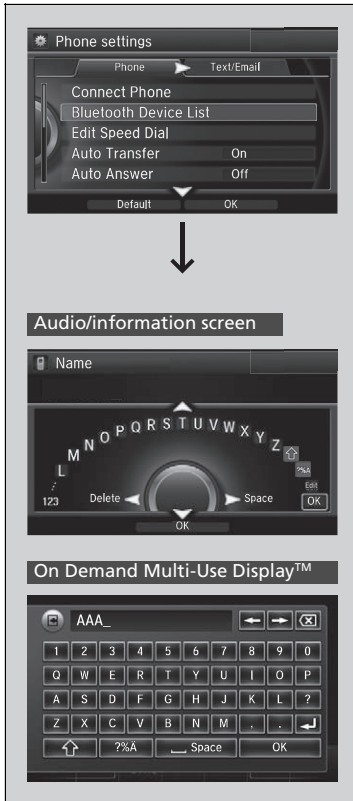

Edit the user name of a paired phone as follows:

1. Press the **SETTINGS** button.
2. Rotate to select **Phone Settings**, then press .
3. Move or to select the **Phone** tab.
4. Rotate to select **Bluetooth Device List**, then press .
5. Rotate to select a phone you want to edit, then press .
6. Rotate to select **Edit Device Name**, then press .
7. Enter a new name of the phone.

- ▶ **Audio/information screen**
Rotate to select, then press . Move to delete. Rotate or move to select **OK** then press to enter the name.
- ▶ **On Demand Multi-Use Display™**
You can also enter a name using the icons.

▶▶ Editing User Name

Audio/Information screen



Select to enter symbols.

Continued

■ Automatic Transferring

If you get into the vehicle while you are on the phone, the call can be automatically transferred to HFL.

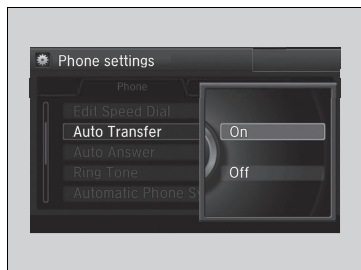

1. Press the **SETTINGS** button.
2. Rotate to select **Phone Settings**, then press .
3. Move or to select the **Phone** tab.
4. Rotate to select **Auto Transfer**, then press .
5. Rotate to select **On**, then press .

■ Auto Answer

You can set HFL to automatically answer an incoming call in four seconds.



1. Press the **SETTINGS** button.
2. Rotate to select **Phone Settings**, then press .
3. Move or to select the **Phone** tab.
4. Rotate to select **Auto Answer**, then press .
5. Rotate to select **On**, then press .

Ring Tone

You can change the ring tone setting.



1. Press the **SETTINGS** button.
2. Rotate to select **Phone Settings**, then press .
3. Move or to select the **Phone** tab.
4. Rotate to select **Ring Tone**, then press .
5. Rotate to select **Fixed**, **Mobile Phone** or **Off**, then press .

Use Contact Photo

You can display a caller's picture on an incoming call screen.



1. Press the **SETTINGS** button.
2. Rotate to select **Phone Settings**, then press .
3. Move or to select the **Phone** tab.
4. Rotate to select **Use Contact Photo**, then press .
5. Rotate to select **On** or **Off**, then press .

Ring Tone

- Fixed:** The fixed ring tone sounds from the speaker.
- Mobile Phone:** The ring tone stored in the connected cell phone sounds from the speaker.
- Off:** No ring tones sound from the speaker.

■ Automatic Import of Cellular Phonebook and Call History

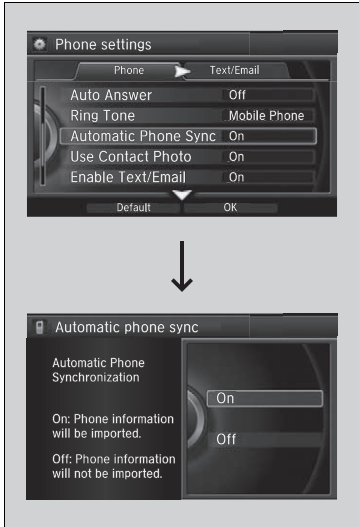

■ When Automatic Phone Sync is set to On:

When your phone is paired, the contents of its phonebook and call history are automatically imported to HFL.

■ Changing the Automatic Phone Sync setting

1. Press the **SETTINGS** button.
2. Rotate to select **Phone Settings**, then press .
3. Move or to select the **Phone** tab.
4. Rotate to select **Automatic Phone Sync**, then press .
5. Rotate to select **On** or **Off**, then press .

▶▶ Automatic Import of Cellular Phonebook and Call History

When you select a person from the list in the cellular phonebook, you can see up to three category icons. The icons indicate what types of numbers are stored for that name.

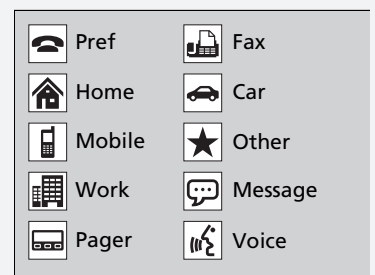

On some phones, it may not be possible to import the category icons to HFL.

The phonebook is updated after every connection. Call history is updated after every connection or call.

Speed Dial

Up to 20 speed dial numbers can be stored per phone.

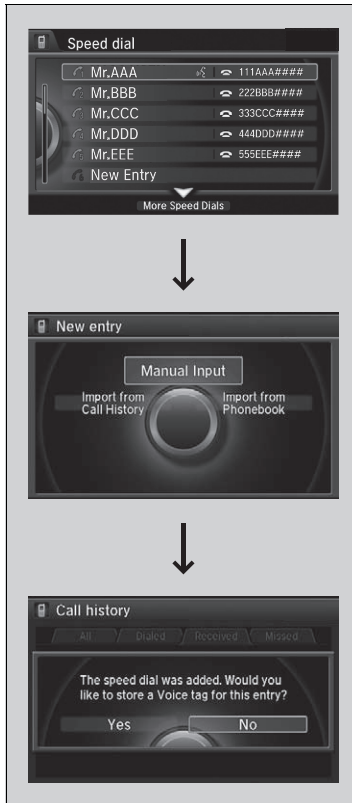

To store a speed dial number:

1. Press the **PHONE** button.
2. Press the **MENU** button.
3. Rotate to select **Speed Dial**, then press .
- ▶ Repeat the procedure to select **New Entry**.
4. Rotate to select a place to choose a number from, then press .
 - From **Import from Call History**:
 - ▶ Select a number from the call history.
 - From **Manual Input**:
 - ▶ Input the number manually.
 - From **Import from Phonebook**:
 - ▶ Select a number from the linked cell phone's imported phonebook.
5. When the speed dial is successfully stored from **Import from Call History** or **Import from Phonebook**, you are asked to create a voice tag for the number. Rotate to select **Yes** or **No**, then press .
6. Using the button, follow the prompts to store a voice tag for the speed dial entry.

Speed Dial

When a voice tag is stored, press the button to call the number using the voice tag. Say "Call" and the voice tag name.

Continued

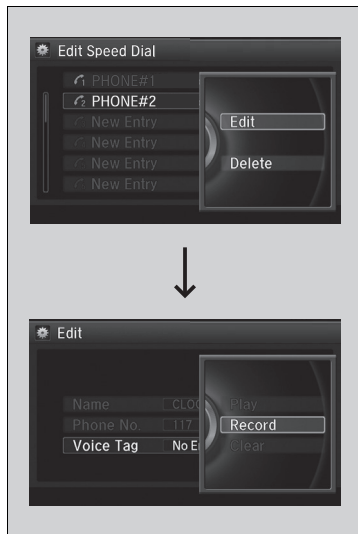

■ To add a voice tag to a stored speed dial number

1. Press the **SETTINGS** button.
2. Rotate to select **Phone Settings**, then press .
3. Move or to select the **Phone** tab.
4. Rotate to select **Edit Speed Dial**, then press .
5. Select an existing speed dial entry.
 - ▶ From the pop-up menu, rotate to select **Edit**, then press .
6. Rotate to select **Voice Tag**, then press .
7. From the pop-up menu, rotate to select **Record**, then press .
 - ▶ After selecting **Record**, wait for the beep(s) to sound before you state the name.
8. Move and select **OK** to complete the voice tag.

▶▶ Speed Dial

Avoid using duplicate voice tags.
 Avoid using "home" as a voice tag.
 It is easier for HFL to recognize a longer name. For example, use "John Smith" instead of "John."



■ **To delete a voice tag**

1. Press the **SETTINGS** button.
2. Rotate to select **Phone Settings**, then press .
3. Move or to select the **Phone** tab.
4. Rotate to select **Edit Speed Dial**, then press .
5. Select an existing speed dial entry.
 - ▶ From the pop-up menu, rotate to select **Edit**, then press .
6. Rotate to select **Voice Tag**, then press .
 - ▶ From the pop-up menu, rotate to select **Clear**, then press .
7. You will receive a confirmation message on the screen. Rotate to select **Yes**, then press .



■ **To delete a speed dial**

1. Press the **SETTINGS** button.
2. Rotate to select **Phone Settings**, then press .
3. Move or to select the **Phone** tab.
4. Rotate to select **Edit Speed Dial**, then press .
5. Select an existing speed dial entry.
 - ▶ From the pop-up menu, rotate to select **Delete**, then press .
6. You will receive a confirmation message on the screen. Rotate to select **Yes**, then press .

Continued

Phonebook Phonetic Modification

Add phonetic modifications or a new voice tag to the phone's contact name so that it is easier for HFL to recognize voice commands.

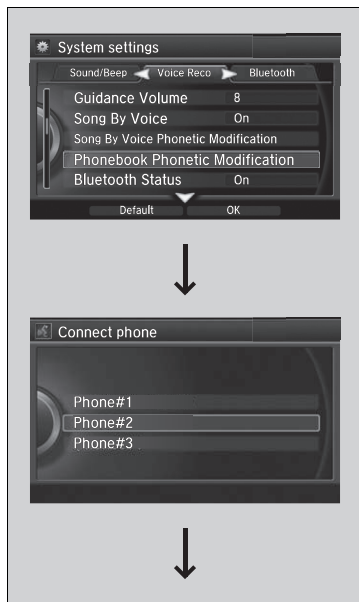

To add a new voice tag

1. Press the **SETTINGS** button.
2. Rotate to select **System Settings**, then press .
3. Move or to select the **Voice Reco** tab.
4. Rotate to select **Phonebook Phonetic Modification**, then press .
5. Rotate to select the phone you want to add phonetic modification to, then press .

Phonebook Phonetic Modification

You can store up to 20 phonetic modification items.

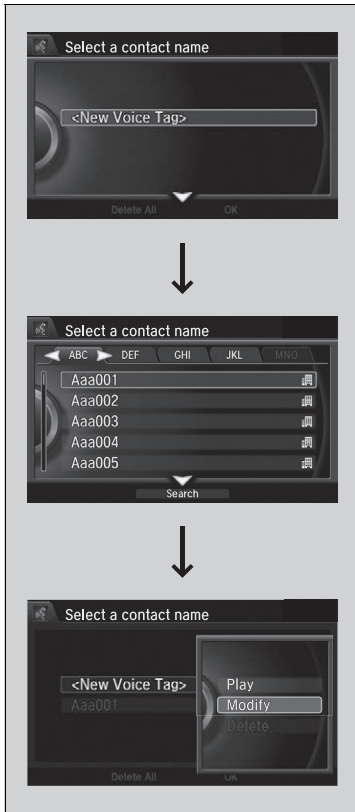

6. Rotate to select **New Voice Tag**, then press .
7. Move or and rotate to select a contact name, then press .
 - ▶ The pop-up menu appears on the screen.
8. Rotate to select **Modify**, then press .
9. Using the button, follow the prompts to complete the voice tag.
10. You will receive a confirmation message on the screen. Rotate to select **OK**, then press .



■ To modify a voice tag

1. Press the **SETTINGS** button.
2. Rotate to select **System Settings**, then press .
3. Move or to select the **Voice Reco** tab.
4. Rotate to select **Phonebook Phonetic Modification**, then press .
5. Rotate to select the phone you want to add phonetic modification to, then press .
6. Rotate to select a contact name you want to modify, then press .
 - ▶ The pop-up menu appears on the screen.
7. Rotate to select **Modify**, then press .
8. Using the button, follow the prompts to complete the voice tag.
9. You will receive a confirmation message on the screen. Rotate to select **OK**, then press .

▶▶ Phonebook Phonetic Modification

You can only modify or delete contact names for the currently connected phone.



■ **To delete a modified voice tag**

1. Press the **SETTINGS** button.
2. Rotate to select **System Settings**, then press .
3. Move or to select the **Voice Reco** tab.
4. Rotate to select **Phonebook Phonetic Modification**, then press .
5. Rotate to select the phone you want to delete phonetic modification, then press .
6. Rotate to select a contact name you want to delete, then press .
 - ▶ The pop-up menu appears on the screen.
7. Rotate to select **Delete**, then press .
8. Move and rotate to select **OK**, then press .

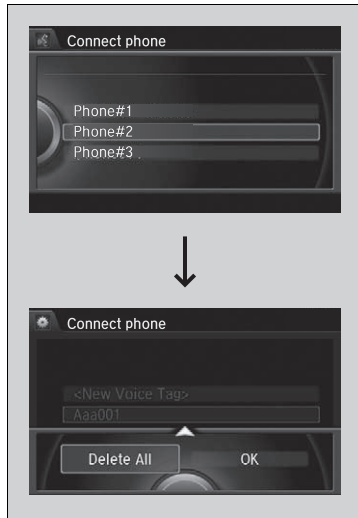

■ **To delete all modified voice tags**

1. Press the **SETTINGS** button.
2. Rotate to select **System Settings**, then press .
3. Move or to select the **Voice Reco** tab.
4. Rotate to select **Phonebook Phonetic Modification**, then press .
5. Rotate to select the phone you want to delete phonetic modification, then press .
 - ▶ The contact name list appears.
6. Move and rotate to select **Delete All**, then press .
7. You will receive a confirmation message on the screen. Rotate to select **Yes**, then press .

Making a Call

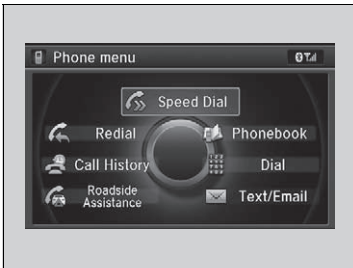

You can make calls by inputting any phone number, or by using the imported phonebook, call history, speed dial entries, or redial.

☒ Making a Call

Any voice-tagged speed dial entry, phonebook name, or number can be dialed by voice from most screens. Press the  button and say "Call" and the voice tag name, "Call by name" and the phonebook name, or "Call" and the phone number.

The maximum range between your phone and vehicles is 30 feet (10 meters).

Once a call is connected, you can hear the voice of the person you are calling through the audio speakers.

Continued

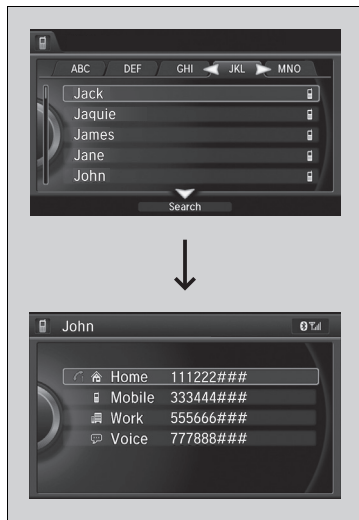

■ **To make a call using the imported phonebook**

1. Press the **PHONE** button.
2. Press the **MENU** button.
3. Rotate to select **Phonebook**, then press .
4. The phonebook is stored alphabetically. Move to **Search**.
 - ▶ You can use the keyboard on the touch screen for an alphabetical search.
5. Rotate to select a number, then press .
 - ▶ Dialing starts automatically.

▶▶ To make a call using the imported phonebook

This function is disabled while the vehicle is moving. However, you can call a stored voice-tagged speed dial number, phonebook name, or number using voice commands.

- ▶ **Limitations for Manual Operation** P. 325
- ▶ **Speed Dial** P. 341

You can use the keyboard on the On Demand Multi-Use Display™ for an alphabetical search.





■ **To make a call using a phone number**

1. Press the **PHONE** button.
2. Press the **MENU** button.
3. Rotate to select **Dial**, then press .
4. Rotate to select a number, then press .
5. Rotate to select , then press .
▶ Dialing starts automatically.

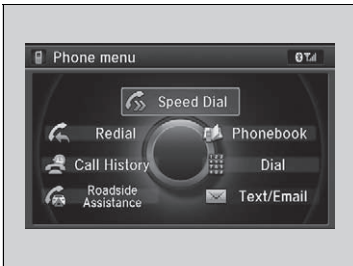

■ **To make a call using redial**

1. Press the **PHONE** button.
2. Press the **MENU** button.
3. Rotate to select **Redial**, then press .
▶ Dialing starts automatically.

☒ To make a call using a phone number

You can use the keyboard on the On Demand Multi-Use Display™ to input numbers. Select numbers, then to start dialing.



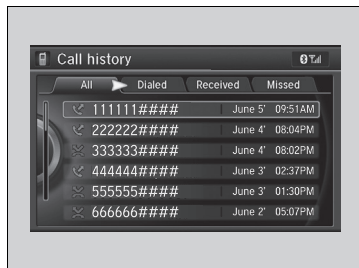

■ **To make a call using the call history**

Call history is stored by **All, Dialed, Received, and Missed.**

1. Press the **PHONE** button.
2. Press the **MENU** button.
3. Rotate to select **Call History**, then press .
4. Move or to select **All, Dialed, Received, and Missed.**
5. Rotate to select a number, then press .
 - ▶ Dialing starts automatically.

▶▶ To make a call using the call history

The call history displays the last 20 dialed, received, or missed calls.
(Appears only when a phone is connected to HFL.)

These icons next to the number indicate the following:

- : Dialed calls.
- : Received calls.
- : Missed calls.

Steering switches

The call history displays the last 12 dialed, received, or missed calls.

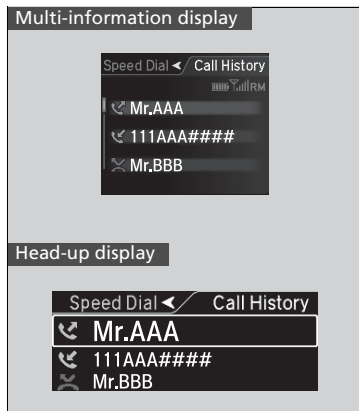





Steering switches

1. Press the button.
2. Move the left selector wheel right to select **Call History.**
3. Roll the left selector wheel to select a number.
4. Push the left selector wheel or the button.
 - ▶ Dialing starts automatically.



■ **To make a call using a speed dial entry**

1. Press the **PHONE** button.
2. Press the **MENU** button.
3. Rotate  to select **Speed Dial**, then press .
4. Rotate  to select a number, then press .
 - ▶ Dialing starts automatically.

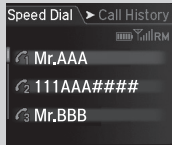

Multi-information display



Head-up display



Steering switches

1. Press the  button.
2. Move the left selector wheel left to select **Speed Dial**.
3. Roll the left selector wheel to select a number.
4. Push the left selector wheel or the  button.
 - ▶ Dialing starts automatically.

▶▶ To make a call using a speed dial entry

Move  to select **More Speed Dials** to view another paired phone's speed dial list. You can make a call from that list using the currently connected phone.

When a voice tag is stored, press the  button to call the number using the voice tag.

▶ **Speed Dial** P. 341

Any voice-tagged speed dial entry, phonebook name or number can be dialed by voice from any screen. Press the  button and follow the prompts.



Steering switches

The speed dial displays the 20 speed dial entries.

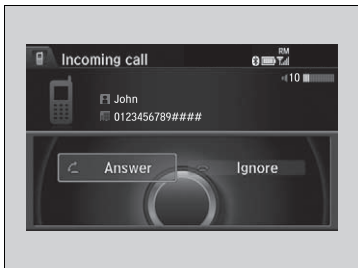

■ Receiving a Call





When there is an incoming call, an audible notification sounds (if activated) and the **Incoming call** screen appears.

Press the  button to answer the call.
Press the  button to decline or end the call.

▣ Receiving a Call

Call Waiting
Press the  button to put the current call on hold to answer the incoming call.
Press the  button again to return to the current call.
Ignore the incoming call if you do not want to answer it.
Press the  button if you want to hang up the current call.

You can select the icons on the On Demand Multi-Use Display™ instead of the  and  buttons.



Options During a Call

The following options are available during a call.



Mute: Mute your voice.

Transfer: Transfer a call from HFL to your phone.

Touch Tones: Send numbers during a call. This is useful when you call a menu-driven phone system.



The available options are shown on the Phone screen.

Rotate  to select the option, then press .

- ▶ The mute icon appears when **Mute** is selected. Select **Mute** again to turn it off.

Options During a Call

Touch Tones: Available on some phones.



You can select the icons on the On Demand Multi-Use Display™.

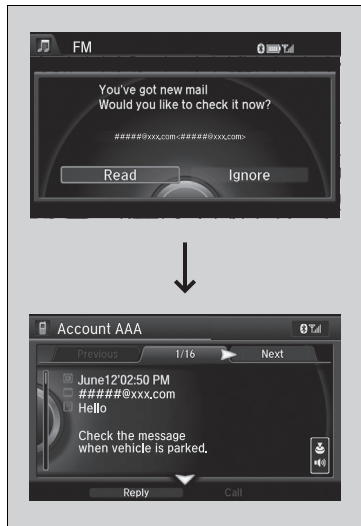

■ Receiving a Text/E-mail Message

HFL can display newly received text/e-mail messages as well as 20 of the most recently received messages on a linked cell phone. Each received message can be read aloud and replied to using a fixed common phrase.



1. A pop-up appears and notifies you of a new text/e-mail message.
2. Rotate  to select **Read** to check the message, then press .
 - ▶ The text/e-mail message is displayed.

▣ Receiving a Text/E-mail Message

The system does not display any received messages while you are driving. You can only hear them read aloud.

With some phones, you may be able to display up to 20 most recent text/e-mail messages.

State or local laws may limit your use of the HFL text/e-mail message feature. Only use the text/e-mail message feature when conditions allow you to do so safely.

When you receive a text/e-mail message for the first time since the phone is paired to HFL, you are asked to turn the **New Text/Email Alert** setting to **On**.

- ▶ **To turn on or off the text/e-mail message notice** P. 335

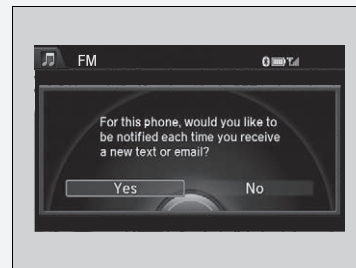

Selecting a Mail Account

If a paired phone has text message or mail accounts, you can select one of them to be active and receive notifications.

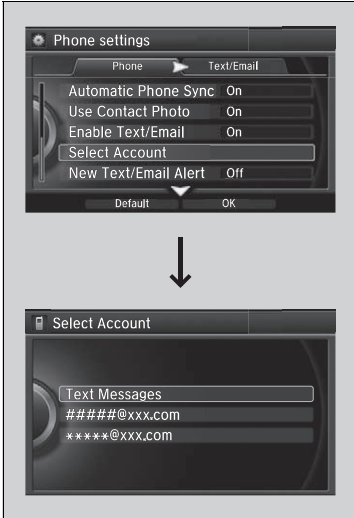

1. Press the **SETTINGS** button.
2. Rotate to select **Phone Settings**, then press .
3. Move or to select the **Text/Email** tab.
4. Rotate to select **Select Account**, then press .
5. Rotate to select **Text Messages** or an e-mail account you want, then press .

Selecting a Mail Account

You can also select a mail account from the folder list screen or the message list screen.

Move to select **Select Account**, then press .

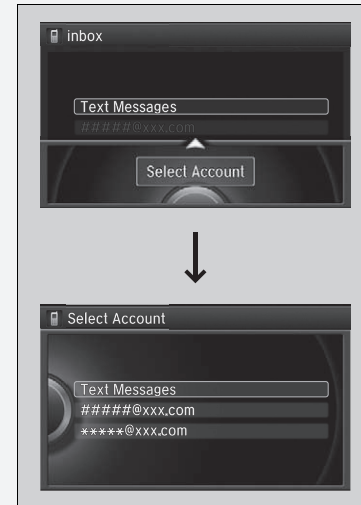





You can only receive notifications from one text message or mail account at a time.

■ Displaying Messages





■ Displaying text messages

1. Press the **PHONE** button.
2. Press the **MENU** button.
3. Rotate  to select **Text/Email**, then press .
 - ▶ Select account if necessary.
4. Rotate  to select a message, then press .
 - ▶ The text message is displayed.

» Displaying Messages

The  icon appears next to an unread message.

If you delete a message on the phone, the message is also deleted in the system. If you send a message from the system, the message goes to your phone's mailbox.

To see the previous or next message, move  or  on the text message screen.

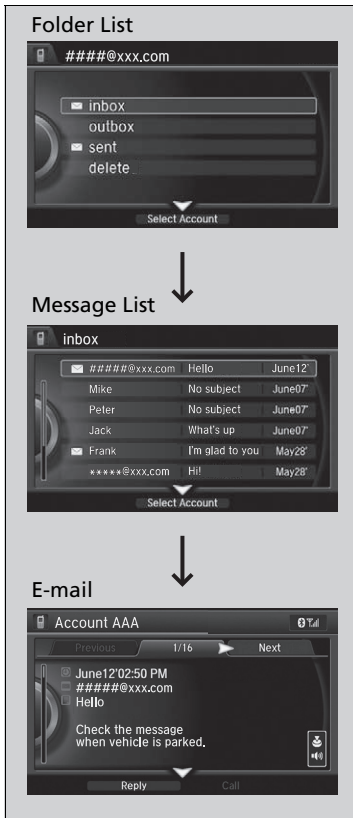

■ Displaying e-mail messages

1. Press the **PHONE** button.
2. Press the **MENU** button.
3. Rotate to select **Text/Email**, then press .
4. Rotate to select a folder, then press .
5. Rotate to select a message, then press .
 - ▶ The e-mail is displayed.

⌘ Displaying e-mail messages

Received text/e-mail messages may appear in the message list screen at the same time. In this case, text messages are titled **No subject**.

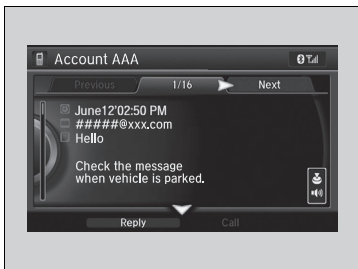

■ Read or stop reading a message

1. Go to the text/e-mail message screen.
 ▶ **Displaying Messages** P. 358
2. Press to read the message aloud.
3. Press to stop reading.
 Press again to start reading the message from the beginning.

■ Reply to a message

1. Go to the text/e-mail message screen.
 ▶ **Displaying Messages** P. 358
2. Move and rotate to select **Reply**, then press .
3. Rotate to select the reply message, then press .
 ▶ The pop-up menu appears on the screen.
4. Select **Send** to send the message.
 ▶ **Message sent** appears on the screen when the reply message was successfully sent.

▶▶ Reply to a message

The available fixed reply messages are as follows:

- **Talk to you later, I'm driving.**
- **I'm on my way.**
- **I'm running late.**
- **OK**
- **Yes**
- **No**



You cannot add, edit, or delete reply messages.

Only certain phones receive and send messages when paired and connected. For a list of compatible phones:

- U.S.: Visit www.Handsfreelink.com/Acura, or call 1-888-528-7876.
- Canada: For more information on smartphone compatibility, call 1-888-528-7876.







■ Making a call to a sender

1. Go to the text message screen.
 - ▶ **Displaying text messages** P. 358
2. Move  and rotate  to select **Call**, then press .

Roadside Assistance

Provides a nationwide service for unexpected incidents. You can call for assistance using a phone paired and connected to Bluetooth® HandsFreeLink®.



1. From the **Phone** screen, press the **MENU** button.
 2. Rotate  to select **Roadside Assistance**, then press .
 3. Rotate  to select a phone number, then press .
- ▶ Dialing starts automatically.

Roadside Assistance

If you are subscribed to a paid AcuraLink package, you can call roadside assistance using the **LINK** button instead of your phone.

▶ **AcuraLink®** P. 363

Is a subscription-based service that provides convenient features such as voice communication in case of emergency, online security, one-on-one operator assistance, and the transmission of important messages regarding your vehicle's status.

For information on traffic rerouting and traffic information updates, provided by the AcuraLink server, see the Navigation System Manual.

In Case of Emergency

Automatic collision notification

When connected to the AcuraLink operator:

Audio/information screen

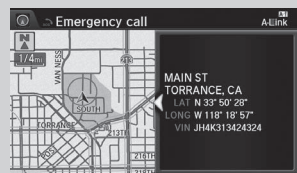

On Demand Multi-Use Display™

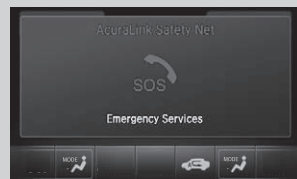

If your vehicle's airbags deploy or if the unit detects that the vehicle is severely impacted, your vehicle will automatically attempt to connect to the AcuraLink operator. Once connected, information about your vehicle, its positioning, and its condition will be sent to the operator; you also can speak to the operator when connected.

AcuraLink®

AcuraLink also provides services you can operate from the Internet or your smartphone.

To subscribe to AcuraLink, or to get more information about all of its features, contact an Acura dealer, or visit owners.acura.com (in U.S.) or www.acura.ca (in Canada).

In Case of Emergency

Your vehicle may not be able to connect to the operator if the battery level is low, the line is disconnected or you do not have adequate cellular coverage.

You cannot use emergency services when:

- You travel outside the AcuraLink service coverage areas.
- There is a problem with the connecting devices, such as the **ASSIST** button, microphone, speakers, or the unit itself.
- You are not subscribed to the service or your subscription is no longer valid.

You cannot operate other navigation- or phone-related functions using the screens while talking to the operator.

Only the operator can terminate the connection to your vehicle.

Automatic collision notification

If the unit fails to connect to the operator, it repeatedly tries until it succeeds.

■ Manual operator connection

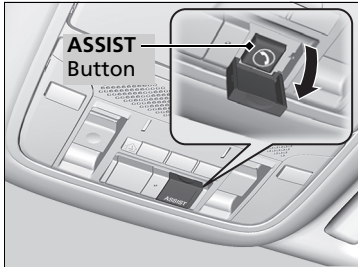

If you need to talk to the AcuraLink operator in an emergency situation, you can manually connect to them by pressing the **ASSIST** button with the power mode in ACCESSORY or ON.

1. Open the cover attached to the ceiling console.
2. Press the **ASSIST** button.
 - ▶ You are connected to the AcuraLink operator.

☒ Manual operator connection

Do not press the button while driving. When you need to contact the operator, park the vehicle in a safe place.

If the unit fails to connect to the operator, it automatically cancels the action after three minutes.

In an emergency, the cover can be broken through to press the **ASSIST** button.

■ Security Features

Your subscribed telematics service provider can track your vehicle's location, remotely lock or unlock doors, and help you find your vehicle. To use these features, you need your user ID and personal identification number (PIN).

■ Stolen vehicle tracking

This feature searches and tracks down your vehicle position even if it is on the move. If you believe that your vehicle has been stolen, contact the police as well as the provider.

■ Remote door lock/unlock

The provider can remotely lock or unlock doors upon your request.

■ Vehicle finder

This feature is convenient to use when trying to locate your vehicle in large areas, such as a crowded parking lot. If you cannot locate your vehicle after using the remote transmitter's answerback function, you can contact the provider which can then flash your vehicle's exterior lights and sound the horn.

■ Security alarm notification

If the security system in your vehicle detects an abnormal condition, such as someone tampering with the lock on your vehicle, the provider notifies you by e-mail or SMS.

☒ Security Features

The contact information of your provider, your user ID and PIN will be given when you subscribe to AcuraLink. If you forget any of the above, contact a dealer, or go to owners.acura.com (in U.S.) or www.acura.ca (in Canada).

You can also activate the remote door lock/unlock and vehicle finder features from the Internet or using your smartphone app. Ask a dealer, or visit owners.acura.com (in U.S.) or www.acura.ca (in Canada) for details.

☒ Vehicle finder

The lights will stop flashing and horn will stop sounding under the following conditions:

- When 30 seconds have elapsed.
- You unlock the doors using the remote transmitter.
- You unlock the doors using the keyless access system.
- You unlock the doors using the built-in key.
- The power mode is set to ACCESSORY or ON.

■ Operator Assistance

Connect to the AcuraLink operator when trying to find a destination or for roadside assistance.



1. Press the **LINK** button.
 - ▶ Connection to the operator begins.

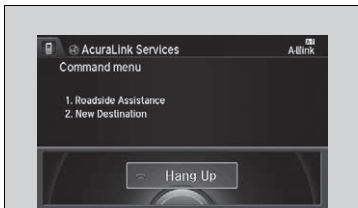

Audio/information screen when connected to the AcuraLink operator.

2. Talk to the operator.
 - ▶ To disconnect, press the selector knob, select **End Call** on the On Demand Multi-Use Display™, or press the Hang-up button.

▶▶ Operator Assistance

Remain attentive to road conditions and driving during operator assistance.

AcuraLink Message

Message Icon

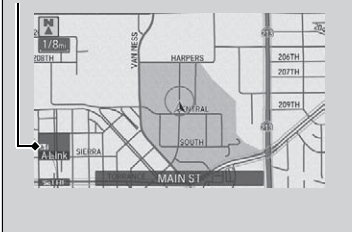

AcuraLink sends you messages on vehicle features, safety and emissions recall campaigns, maintenance reminders (U.S. models only), and diagnostic information. When you receive a new message, an icon appears on the audio/information screen.

Message category



There are six message categories.

- **Feature Guide:** Appears for the first 90 days of ownership, introducing vehicle features each day.
- **Quick Tips:** Supplements your Owner's Manual with updated vehicle information.
- **Diagnostic Info:** Appears when a warning indicator or message comes on. Rotate  to select **Check Later** or **Check Now**.
▶ Selecting **Check Now** lets you know if you should see a dealer immediately or later in accordance with the warning severity level.
- **Scheduled Dealer Appointment** (U.S. models only): An appointment made through the Acura server or Acura Owners website can be rescheduled or canceled from this option. ▶ **Dealer Appointments** P. 369
- **Maintenance Minder** (U.S. models only): Lets you know which maintenance item is due along with a reminder message.
- **Recalls/Campaigns:** Reminds you of a recall or important safety information. You should also be notified by mail.

AcuraLink Message

Messages may not appear immediately after your vehicle purchase. It can take several days for your dealer to register your vehicle's ID.

If an icon includes an exclamation point, it indicates that Acura gives high priority to this message compared to the one without.

- : An unread message with high priority
- : An unread message

Message category

Message categories can be added, edited, or deleted through broadcast messages from Acura.

You can call your dealer, find the nearest dealer, or schedule appointments (U.S. models only) from the message options in **Maintenance Minder** (U.S. models only), **Recalls/Campaigns**, and **Diagnostic Info**.

▶ **Message Options** P. 368

■ Reading a message



1. Press the **INFO** button, rotate to select **AcuraLink/Messages**, then press .
 - ▶ If your display has changed from **Info** menu to **Current Drive**, press the **MENU** button.
 - ▶ AcuraLink messages appears.
2. Rotate to select a category, then press .
 - ▶ If there are unread messages in a category, a message icon appears next to that category.
3. Rotate to select a message you want to read, then press .

■ Message Options

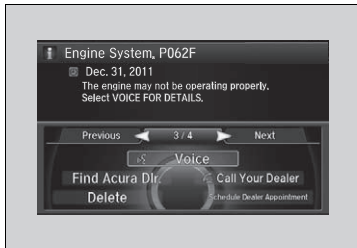

Available options are:

- **Voice:** Reads the message aloud. Select **Stop Reading** to cancel it.
- **Find Acura Dir.** (U.S. models only): Searches for the nearest Acura dealer.
- **Delete** (U.S. models only): Deletes the displayed message. Rotate to select this option, then press .
- **Call Your Dealer:** Calls your Acura dealer using HFL.

▶▶ Reading a message

If there is no message listed on the menu, **AcuraLink/Messages** is grayed out and cannot be selected.

The message icon disappears once you read the message.

However, the exclamation mark that indicates that the message has a high priority remains.

- : A read message with high priority.

▶▶ Message Options

The available options vary by message category.

You can delete all messages in a category at once.

- ▶ **Customized Features** P. 295

Voice is available only when the language selected is English.

- ▶ **Customized Features** P. 295





- **Schedule Dealer Appointment** (U.S. models only): Automatically sets an appointment date at your dealer.
- **Phone number**: Dials a number displayed in the message via HFL.
- **Diagnostic Info**: Updates the current diagnostic message by connecting to the Acura server using HFL.

U.S. models only

■ Dealer Appointments

You can confirm the scheduled appointment date when you receive a **Maintenance Minder** or **Recalls/Campaigns** message, or reschedule any existing appointments.



1. Select a **Maintenance Minder, Recalls/Campaigns, or Scheduled Dealer Appointment** message.
2. Rotate  to select **Scheduled Dealer Appointment** or **Reschedule Appointment** (depending on the screen). Press .
▶ A suggested time and date are displayed.
3. Rotate  to select **Confirm Appointment**. Press  to accept the time and date.
4. Press  to select **OK**.

☒ Dealer Appointments

To set up an automated dealer appointment when a regular maintenance is due, visit the Acura Owners website at owners.acura.com (in U.S.) or www.acura.ca (in Canada), and set the required option. A reminder message will be sent as the date for the dealer appointment approaches. A reminder message will also be sent if you schedule an appointment online using **Acura Owners' Schedule Service Appointment** function.

If you are not satisfied with the proposed appointment date and time, call your dealer directly.

To cancel the scheduled appointment, select **Cancel Appointment** when a message is displayed.

Driving



This chapter discusses driving and refueling.

Before Driving

Driving Preparation	372
Maximum Load Limit.....	375

Towing a Trailer

377

When Driving

Turning on the Power	378
Precautions While Driving.....	383
Dual Clutch Transmission	384
Shifting	385
SPORT Mode.....	393
Reactive Force Pedal.....	394
Acoustic Vehicle Alerting System.....	395
AcuraWatch™.....	396
Front Sensor Camera	400

Adaptive Cruise Control (ACC) with Low Speed Follow	402
Road Departure Mitigation (RDM) System....	416
Lane Keeping Assist System (LKAS) ..	421
Traffic Jam Assist	428
Vehicle Stability Assist™ (VSA®), aka Electronic Stability Control (ESC), System	439
Agile Handling Assist	441
SPORT HYBRID Super Handling-All Wheel Drive™ (SPORT HYBRID SH-AWD®)....	442
Blind spot information System.....	443
Tire Pressure Monitoring System (TPMS) ..	445
Tire Pressure Monitoring System (TPMS) - Required Federal Explanation	447
High Voltage Battery.....	449

Braking

Brake System	450
Anti-lock Brake System (ABS)	456
Brake Assist System	457
Collision Mitigation Braking System™ (CMBS™) ...	458

Parking Your Vehicle

When Stopped	466
Parking Sensor System*	468
Cross Traffic Monitor	472

Multi-View Rear Camera*

476

Surround View Camera System*

478

Refueling

Fuel Information	488
How to Refuel	489

Fuel Economy and CO₂ Emissions....

490

* Not available on all models

Driving Preparation

Check the following items before you start driving.

Exterior Checks

- Make sure there are no obstructions on the windows, door mirrors, exterior lights, or other parts of the vehicle.
 - ▶ Remove any frost, snow, or ice.
 - ▶ Remove any snow on the roof, as this can slip down and obstruct your field of vision while driving. If frozen solid, remove ice once it has softened.
 - ▶ When removing ice from around the wheels, be sure not to damage the wheel or wheel components.
- Make sure the hood is securely closed.
 - ▶ If the hood opens while driving, your front view will be blocked.
- Make sure the tires are in good condition.
 - ▶ Check air pressures, and check for damage and excessive wear.
 - ✦ **Checking and Maintaining Tires** P. 520
- Make sure there are no people or objects behind or around the vehicle.
 - ▶ There are blind spots from the inside.

Exterior Checks

NOTICE

When doors are frozen shut, use warm water around the door edges to melt any ice. Do not try to force them open, as this can damage the rubber trim around the doors. When done, wipe dry to avoid further freezing.

Do not pour warm water into the key cylinder. You will be unable to insert the key if the water freezes in the hole.

Heat from the engine and exhaust can ignite flammable materials left under the hood, causing a fire. If you've parked your vehicle for an extended period, inspect and remove any debris that may have collected, such as dried grass and leaves that have fallen or have been carried in for use as a nest by a small animal. Also check under the hood for leftover flammable materials after you or someone else has performed maintenance on your vehicle.

Interior Checks

- Store or secure all items on board properly.
 - ▶ Carrying too much cargo, or improperly storing it, can affect your vehicle's handling, stability, stopping distance, and tires, and make it unsafe.
 - ✦ **Maximum Load Limit** P. 375
- Do not pile items higher than the seat height.
 - ▶ They can block your view and may be thrown forward in the event of sudden braking.
- Do not place anything in the front seat footwells. Make sure to secure the floor mat.
 - ▶ An object or unsecured floor mat can interfere with your brake and accelerator pedal operation while driving.
- If you have any animals on board, do not let them move around in the vehicle.
 - ▶ They may interfere with driving and a crash could occur.
- Securely close and lock all doors and the trunk.
 - ✦ **Locking/Unlocking the Doors from the Inside** P. 139
- Adjust your seating position properly.
 - ▶ Adjust the head restraint, too.
 - ✦ **Adjusting the Seats** P. 175
 - ✦ **Adjusting the Front and Rear Outer Head Restraint Positions** P. 178
- Adjust the mirrors and steering wheel properly for your driving.
 - ▶ Adjust them while sitting in the proper driving position.
 - ✦ **Adjusting the Mirrors** P. 172
 - ✦ **Adjusting the Steering Wheel** P. 171

Interior Checks

The headlight aim is set by the factory, and does not need to be adjusted. However, if you regularly carry heavy items in the trunk have the aiming readjusted at a dealer or by a qualified technician.

- Be sure items placed on the floor behind the front seats cannot roll under the seats.
 - ▶ They can interfere with the driver's ability to operate the pedals, the operation of the seats, or the operation of the sensors under the seats.
- Everyone in the vehicle must fasten their seat belt.
 - 📄 **Fastening a Seat Belt** P. 41
- Make sure that the indicators in the instrument panel come on when you start the vehicle, and go off soon after.
 - ▶ Always have a dealer check the vehicle if a problem is indicated.
 - 📄 **Indicators** P. 76

Maximum Load Limit

The maximum load for your vehicle is 850 lbs (385 kg). See the Tire and Loading Information label attached to the driver's doorjamb.

Label Example

TIRE AND LOADING INFORMATION			
SEATING CAPACITY		TOTAL X	FRONT X REAR X
The combined weight of occupants and cargo should never exceed XXXkg or XXXlbs.			
TIRE	SIZE	COLD TIRE PRESSURE	SEE OWNER'S MANUAL FOR ADDITIONAL INFORMATION
FRONT	XXXX/XXXXX XXX	XXXKPA, XXPSI	
REAR		XXXKPA, XXPSI	
SPARE	none		

This figure includes the total weight of all occupants, cargo, and accessories, and the tongue load if you are towing a trailer.

Steps for Determining Correct Load Limit -

- (1)** Locate the statement "The combined weight of occupants and cargo should never exceed XXX kg or XXX lbs." on your vehicle's placard.
- (2)** Determine the combined weight of the driver and passengers that will be riding in your vehicle.
- (3)** Subtract the combined weight of the driver and passengers from XXX kg or XXX lbs.
- (4)** The resulting figure equals the available amount of cargo and luggage load capacity. For example, if the "XXX" amount equals 1,400 lbs. and there will be five 150 lb. passengers in your vehicle, the amount of available cargo and luggage load capacity is 650 lbs. (1,400 - 750 (5 x 150) = 650 lbs.)

Continued

Maximum Load Limit

⚠ WARNING

Overloading or improper loading can affect handling and stability and cause a crash in which you can be hurt or killed.

Follow all load limits and other loading guidelines in this manual.

Gross Vehicle Weight Rating (GVWR):
The maximum allowable weight of the vehicle, all occupants, all accessories and all cargo.

➤ **Specifications** P. 586

Gross Axle Weight Rating (GAWR):
The maximum allowable weight of the vehicle axle.

➤ **Specifications** P. 586

- (5) Determine the combined weight of luggage and cargo being loaded on the vehicle. That weight may not safely exceed the available cargo and luggage load capacity calculated in step 4.
- (6) If your vehicle will be towing a trailer, load from your trailer will be transferred to your vehicle. Consult this manual to determine how this reduces the available cargo and luggage load capacity of your vehicle.

In addition, the total weight of the vehicle, all occupants, accessories, cargo, and trailer tongue load must not exceed the Gross Vehicle Weight Rating (GVWR) or the Gross Axle Weight Rating (GAWR). Both are on a label on the driver's doorjamb.







▶▶ Maximum Load Limit

Towing a Trailer:

See Towing a Trailer to determine whether your vehicle is designed to tow a trailer.

▶▶ **Towing a Trailer** P. 377

Load Limits Example

<p>Example 1</p>  <p>Max Load 850 lbs (385 kg)</p>	\geq	 <p>Passenger Weight 150 lbs x 2 = 300 lbs (68 kg x 2 = 136 kg)</p>	<p>+</p>	 <p>Cargo Weight 550 lbs (249 kg)</p>
<p>Example 2</p>  <p>Max Load 850 lbs (385 kg)</p>	\geq	 <p>Passenger Weight 150 lbs x 5 = 750 lbs (68 kg x 5 = 340 kg)</p>	<p>+</p>	 <p>Cargo Weight 100 lbs (45 kg)</p>

Your vehicle is not designed to tow a trailer. Attempting to do so can void your warranties.

Towing Your Vehicle

Your vehicle is not designed to be towed behind a motor home. If your vehicle needs to be towed in an emergency, refer to the emergency towing information.

📄 **Emergency Towing** P. 580

Turning on the Power

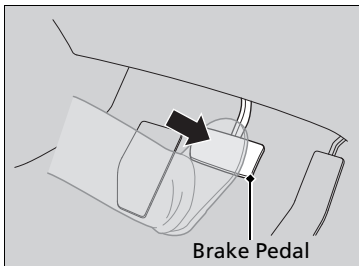
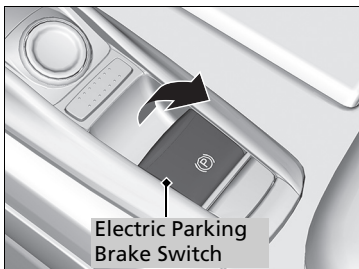

1. Make sure the parking brake is applied.
 - ▶ The electric parking brake indicator comes on for 15 seconds when you pull up the electric parking brake switch.
2. Depress the brake pedal.

Turning on the Power

Keep your foot firmly on the brake pedal when starting the power system.

The engine is harder to start in cold weather and in thinner air found at altitudes above 8,000 feet (2,400 meters).

When turning on the power system in cold weather, turn off all electrical accessories such as the lights, climate control system, and rear defogger in order to reduce 12-volt battery drain.

If you live in a region where winter is extremely cold, an engine block heater and transmission clutch actuator heater will improve starting and reduce the warming time required before driving. Consult a dealer for details.

If the exhaust system sounds abnormal or you can smell exhaust gas inside the vehicle, have your vehicle checked by a dealer. There may be a problem with the engine or exhaust system.

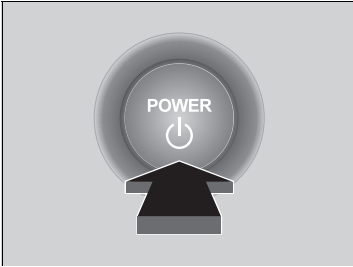

3. Press the **POWER** button without depressing the accelerator pedal.
 - ▶ The **Ready To Drive** message appears on the multi-information display.
 - ▶ When the ambient temperature is extremely low, the vehicle does not move until certain conditions are met. A warning message appears instead of **Ready To Drive**.
 - ❏ **Multi-Information Display Warning and Information Messages** P. 103
 - ▶ If the High Voltage battery is fully charged, the gasoline engine may not start.
 - ▶ If the High Voltage battery charge level is low, the gasoline engine starts.

■ Stopping the Power System

You can turn the power system off when the vehicle is completely stopped.

1. Put the transmission into **P**.
2. Press the **POWER** button.

❏ Turning on the Power

The immobilizer system protects your vehicle from theft. If an improperly coded key (or other device) is used, the power system does not activate.

❏ **Immobilizer System** P. 146

When you set the power mode to ON, you may feel as if the brake pedal is sinking down. This is normal.

Bring the keyless access remote close to the **POWER** button if the battery in the keyless access remote is weak.

❏ **If the Keyless Access Remote Battery is Weak** P. 560

The power system may not activate if the keyless access remote is subjected to strong radio waves.

The engine may not run when the vehicle is ready for driving.

You can start driving with the **READY** indicator on. If you press the **POWER** button while depressing the brake pedal with the **READY** indicator on, the power mode is set to VEHICLE OFF and you cannot start driving.

❏ **READY Indicator** P. 80

■ Remote Engine Start with Vehicle Feedback

You can remotely turn the power system on using the two-way keyless access remote from extended distances.

■ To turn the power system on

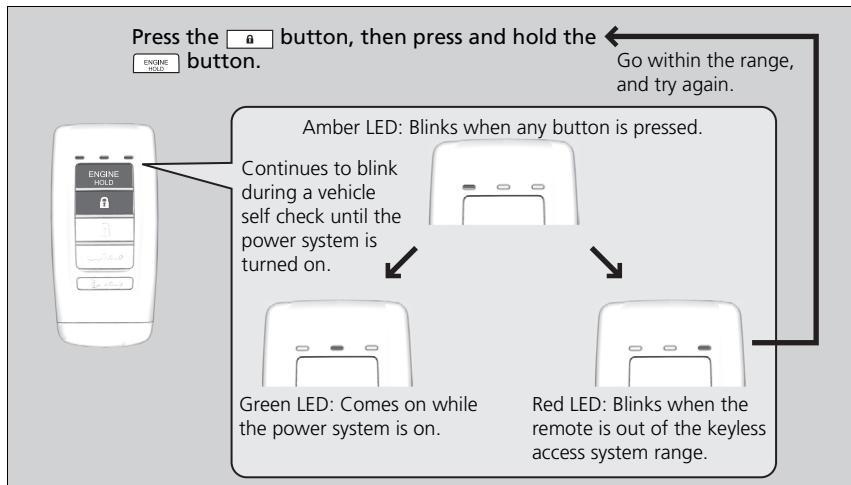

The power system is on for up to 10 minutes without you starting the vehicle. To extend the time for another 10 minutes during the first 10 minutes, press the button, then press and hold the .

▶ The amber LED blinks, then the green LED comes back on if a 10-minute extension request was transmitted successfully.

After pressing the button, wait for the green LED to blink. This indicates that all the doors and the trunk are locked.

⊠ Remote Engine Start with Vehicle Feedback

⚠ WARNING

Carbon monoxide gas is toxic and can rapidly accumulate in closed or even partly enclosed areas. Breathing it can cause unconsciousness and even kill you.

Never use the remote engine starter with the vehicle parked in a garage or other areas with limited ventilation.

If there are buildings and obstacles between your vehicle and the remote, the range will be reduced. The range may be less when the vehicle is running. This distance may vary by external electrical interference.

The power system may not be turned on by the remote engine start if:

- You have disabled a remote engine start setting using the audio/information screen.
- The power mode is not in VEHICLE OFF.
- The transmission is in a position other than **P**.
- The hood is open, or any door or the trunk is unlocked.
- You have already used the remote twice to turn the power system on.
- Another registered keyless access remote is in the vehicle.
- There is any antenna failure.
- The door is unlocked with the built-in key.

■ To turn the power system off

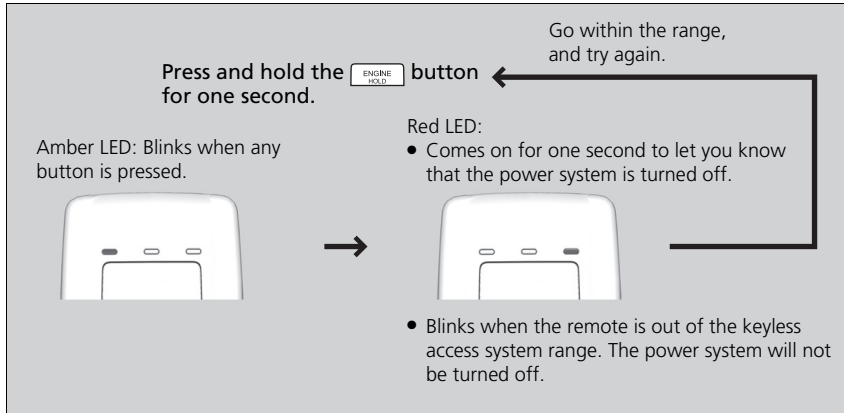

▶▶ Remote Engine Start with Vehicle Feedback

- The engine oil pressure is low.
- The engine coolant temperature is extremely high.
- The telematics unit malfunctions.
- The security system alarm is not set.

Before turning the power system on, make sure to check the door lock status using the remote. When you press the  button, wait for the green LED to blink. If the red LED turns on, the doors and trunk did not lock, and the power system is not turned on.

While the power system is on, the vehicle will automatically precondition inside the vehicle. When it is cold outside:

- The defroster and heated windshield are activated at a moderately warm temperature.
- The rear defogger, door mirror heaters and heated windshield are activated.
- The heated steering wheel is activated.

▶ **Heated Steering Wheel** P. 194

Starting to Drive

When the power system is turned on using the two-way keyless access remote

1. While depressing the brake pedal, press the **POWER** button.

When the power system is turned on in any case

2. Keeping your right foot on the brake pedal, press the **[D]** button. Select **[R]** when reversing.

3. With the parking brake applied, release the brake pedal and gently depress the accelerator pedal.

▶ Make sure the electric parking brake indicator goes off.

➤ **Parking Brake** P. 450

➤ **If the Transmission System Indicator Blinks along with the Warning Message** P. 571

Hill start assist system

Hill start assist keeps the brake engaged briefly to help prevent the vehicle from rolling on inclines as you move your foot from the brake pedal to the accelerator.

Change to **[D]** when facing uphill, or **[R]** when facing downhill, then release the brake pedal.

Starting to Drive

You can also release the parking brake by pressing the electric parking brake switch while depressing the brake pedal.

When facing downhill, you can start your vehicle more smoothly by manually releasing it with the electric parking brake switch than by releasing it with the accelerator pedal.

When the power system is turned on using the two-way keyless access remote

The power system is turned off when the gear position is changed from **[P]** before the **POWER** button is pressed. Follow the step 1 when starting to drive.

Hill start assist system

Hill start assist may not prevent the vehicle from rolling downhill on a very steep or slippery slope, and does not operate on small inclines.

Hill start assist is not a replacement for the parking brake.

Precautions While Driving

In Rain

Avoid driving in deep water and on flooded roads. This can damage the power system or driveline, or cause electrical component failure.

Precautions While Driving

NOTICE

Do not change the gear position while pressing the accelerator pedal. You could damage the transmission.

NOTICE

The following can damage the under spoiler:

- Parking the vehicle by a parking block
- Parallel parking along the road shoulder
- Driving toward the bottom of a hill
- Driving up or down to a different surface level (such as a road shoulder)
- Driving on a rutted or bumpy road
- Driving on a road with potholes.

NOTICE

If you repeatedly turn the steering wheel at an extremely low speed, or hold the steering wheel in the full left or right position for a while, the electric power steering (EPS) system heats up. The system goes into a protective mode, and limits its performance. The steering wheel becomes harder and harder to operate. Once the system cools down, the EPS system is restored.

Repeated operation under these conditions can eventually damage the system.

If the power mode is set to ACCESSORY while driving, the power system will shut down and all steering and brake power assist functions will stop, making it difficult to control the vehicle.

Continued

■ Other Precautions

If there is a strong impact with something under the vehicle, stop in a safe location. Check the underside of the vehicle for damage or any fluid leaks.

Dual Clutch Transmission

■ Creeping

As with a conventional gasoline-powered vehicle with an automatic transmission, this vehicle will creep.

Keep the brake pedal firmly depressed when stopped.

■ Kickdown

Quickly depressing the accelerator pedal while driving uphill may cause the transmission to drop to a lower gear, unexpectedly increasing vehicle speed. Depress the accelerator pedal carefully, especially on slippery roads and curves.

⚠ Precautions While Driving

Do not change the gear position to **N**, as you will lose regenerative braking (and acceleration) performance.

During the first 600 miles (1,000 km) of operation, avoid sudden acceleration or full throttle operation so as not to damage the engine or powertrain.

Avoid hard braking for the first 200 miles (300 km). You should also follow this when the brake pads are replaced.

Shifting

Change the gear position in accordance with your driving needs.

■ Shift button positions

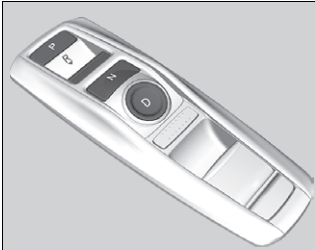

- P** **Park**
Used when parking or before turning the power on or off
Transmission is locked
- R** **Reverse**
Used when reversing
- N** **Neutral**
Transmission is not locked
- D** **Drive**
Used for:
- Normal driving (gears change between 1st and 7th automatically)
 - Temporarily driving in the sequential mode
 - Driving in the sequential mode (when driving in SPORT mode)

⚠ Shifting

⚠ WARNING

The vehicle can roll away if left unattended without confirming that Park is engaged.

A vehicle that rolls away could cause a crash resulting in serious injury or death.

Always keep your foot on the brake pedal until you have confirmed that **P** is shown on the gear position indicator.

While the High Voltage battery level is full, or the High Voltage battery temperature is low, regenerative braking may become less effective.

To prevent malfunction and unintended engagement:

- Do not spill any liquids on or around shift buttons.
- Do not place or drop any objects on or around shift buttons.
- Do not let passengers or children operate the shift buttons.

You may occasionally find that it takes longer than usual for the vehicle to start moving when you select **R**, release the brake pedal, and/or depress the accelerator pedal. This may occur when the High Voltage battery level is extremely low, and does not indicate a vehicle malfunction.

Continued

■ **P (parking) button**

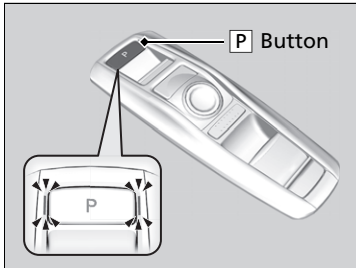

The gear position changes to **P** when you press the **P** button while the vehicle is parked with the power mode in ON. The indicators on the sides of the **P** button come on.

▶ Shifting

The beeper sounds and a message appears on the multi-information display when you depress the accelerator pedal with the gear position in **N**. Change the gear position to **D** or **R** with the brake pedal depressed.

When shifting gears in extremely low temperatures (-22°F/-30°C), there may be a short delay before the gear position is indicated in the display. Always confirm you are in the correct gear before driving.

Shift Operation

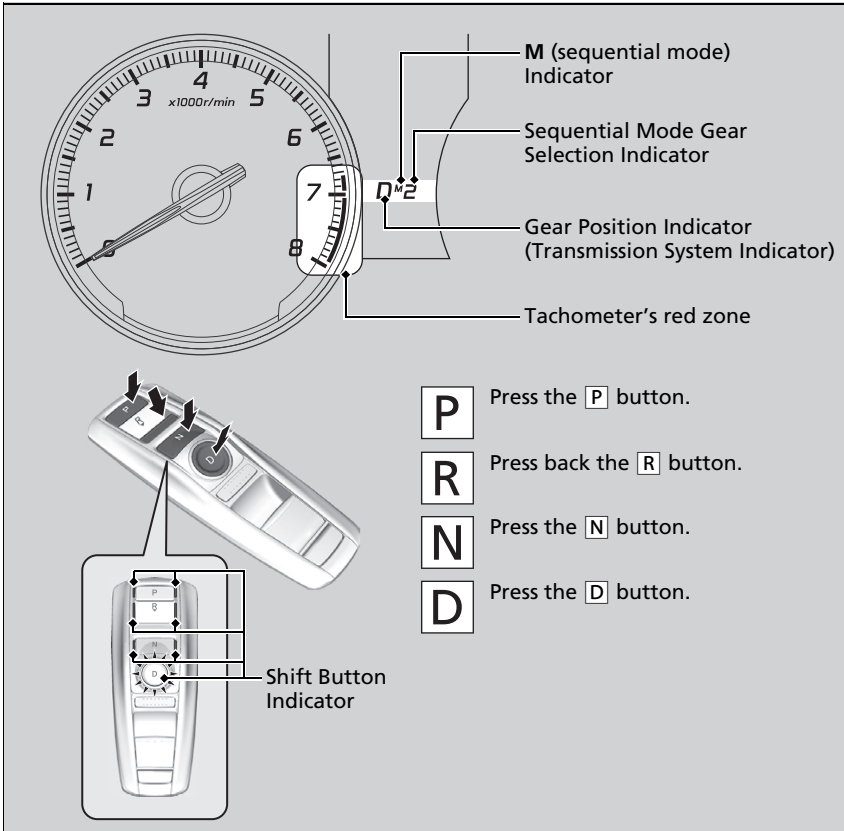

Shift Operation

NOTICE

When you change **D** to **R** and vice versa, come to a complete stop and keep the brake pedal depressed. Operating the shift button before the vehicle has come to a complete standstill can damage the transmission.

Use the gear position indicator and the shift button indicator to check the gear position before selecting a shift button.

If the indicator of the currently selected gear position, or all the gear position indicators are blinking simultaneously, there is a problem with the transmission.

Avoid sudden acceleration and have the transmission checked by a dealer as soon as possible.

The fuel supply may be cut off if you drive at engine speeds in or over the tachometer's red zone (engine speed limit). If this happens, you may experience a slight jolt.

When the engine speed is increased while the transmission is in **N**, **P** or **R**, the fuel supply may be cut off even without the engine speed entering the tachometer's red zone.

The beeper sounds once when you change to **R**.

▶ **Customized Features P. 295**

Continued

■ When opening the driver's door

If you open the driver's door under the following conditions, the gear position automatically changes to **P**;

- The vehicle is in stationary with the power mode in ON, or moving at 1 mph (2 km/h) or slower.
- The transmission is in other than **P**.
- You have unfastened the driver side seat belt.
 - ▶ If you manually change the gear position from **P** with the brake pedal depressed, the gear position will automatically return to **P** once you release the brake pedal.

■ When turning off the power mode

If you turn the power system off while the vehicle is stationary, and the transmission is in other than **P**, the gear position automatically changes to **P**.

⌘ When opening the driver's door

While the system is designed to automatically change the gear position to **P** under the described conditions, in the interest of safety you should always select **P** before opening the driver's door. Make sure to park the vehicle in a safe place.

🔍 When Stopped P. 466

If you want to drive the vehicle after the gear position has automatically changed to **P** under the described conditions, close the door, fasten the seat belt, depress the brake pedal, then change the gear position.

If you leave the vehicle, turn off the power system and lock the doors.

■ If you want to keep the transmission in **[N]** position (car wash mode)

With the power system on:

1. Press and hold the brake pedal.
2. Press and release the **[N]** button.
 - ▶ **[N]** (Neutral) hold mode will appear on the multi-information display.
3. Press the **[N]** button again and hold it for two seconds.
 - ▶ The vehicle will enter car wash mode, which must be used when your vehicle is pulled through a conveyor type automatic car wash where you or an attendant do not remain in the vehicle.

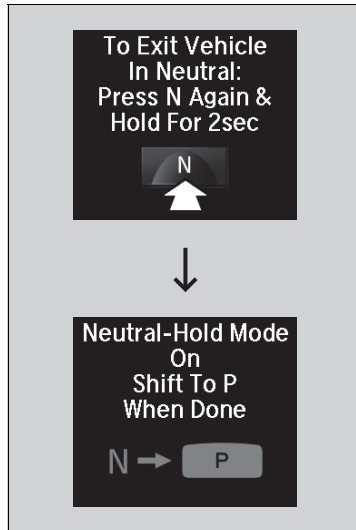

If the **POWER** button is pressed after car wash mode has been activated, the power mode will change to ACCESSORY and a message will be displayed on the multi-information display.

- ▶ For 15 minutes the gear position remains in **[N]** and the power mode will remain in ACCESSORY. After that, the position automatically changes to **[P]** and the power mode changes to OFF.
- ▶ Manually changing to **[P]** cancels ACCESSORY mode. The **[P]** indicator comes on and the power mode changes to OFF. You must always shift to **[P]** when car wash mode is no longer needed.

ⓘ If you want to keep the transmission in **[N]** position (car wash mode)

To keep the vehicle in **[N]** position, you can also follow this procedure:

While the power system is on, select **[N]**, and then within five seconds, press the **POWER** button.

Note that the transmission may not stay in **[N]** position while any of the following indicators is on:

- Transmission system indicator.
- Malfunction indicator lamp.
- Charging system indicator.

■ **Restriction on selecting a gear position**

You cannot select a gear position under certain circumstances that may lead to a crash.

When the transmission is in:	1. Under the circumstances of that:	2. You cannot select:	3. The gear position remains in/changes to:	How to change the gear position
P	The brake pedal is not depressed. The accelerator pedal is depressed.	Other gear position	P	Release the accelerator pedal and depress the brake pedal.
N	The vehicle is moving at low speed without the brake pedal depressed. The vehicle is moving at low speed with the accelerator pedal depressed.		N	
N or D	The vehicle is moving forward.		R	Park your vehicle in a safe place.
R or N	The vehicle is moving backward.		D	
R , N , or D	The vehicle is moving.	P		
P or N	The READY indicator is not on.	A gear position other than P or N	P or N	Make sure that the READY indicator comes on.

Sequential Mode

Use the paddle shifters to change between 1st and 7th gears without removing your hands from the steering wheel. The transmission will switch to the sequential mode.

■ When the transmission is in **D**:

The vehicle will go into the sequential mode momentarily, and the sequential mode gear selection indicator will come on.

Once you start traveling at a constant speed, the sequential mode will automatically switch off, and the sequential mode gear selection indicator will go off.

Hold the **+** paddle shifter for two seconds to return to normal drive.

■ When the transmission is in **D** with **SPORT** mode:

The vehicle will go into the sequential mode, and the **M** (sequential mode) indicator and sequential mode gear selection indicator will come on.

If the vehicle speed increases and the engine speed reaches near the tachometer's red zone, the transmission automatically shifts up to 6th.

You can cancel this mode by pulling the **+** paddle shifter for two seconds. When the sequential mode is canceled, the sequential mode indicator and sequential mode gear selection indicator will go off.

Sequential Mode

The vehicle is engine operated when SPORT mode is on.

Sequential Mode Operation

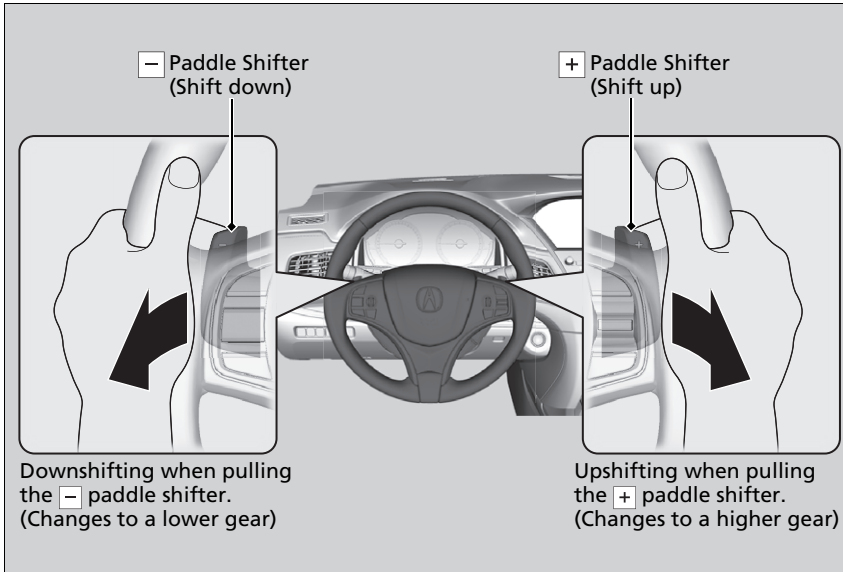

Sequential Mode Operation

Each paddle shift operation makes a single gear change.
To change gears continuously, release the paddle shifter before pulling it again for the next gear.

If the sequential mode gear selection indicator blinks when you try to shift up or down, this means your vehicle speed is not in its allowable gear range or the protection of transmission system is necessary. Slightly accelerate to shift up and decelerate to shift down while the indicator is blinking.

In SPORT mode, to prioritize the engine performance enhancement, the transmission may not allow for shifting up while the engine speed is low.

SPORT Mode

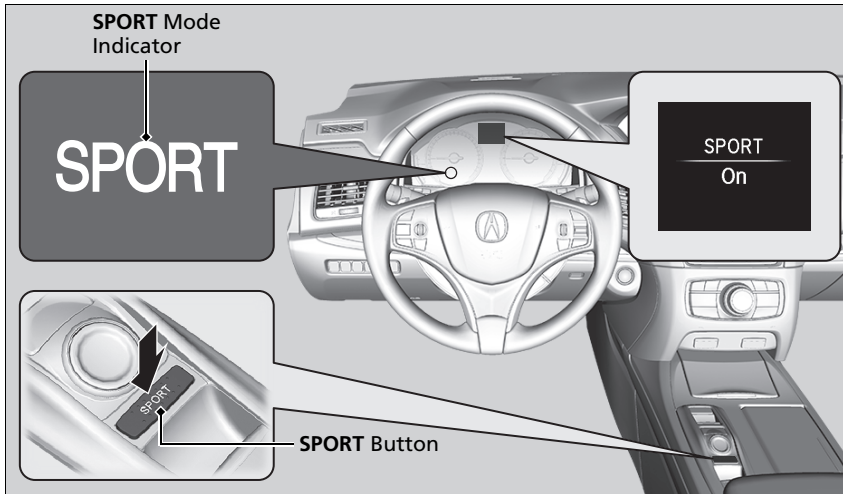

To turn the SPORT mode on and off, press the **SPORT** button.

The SPORT mode increases engine performance and handling. This mode is not recommended for fuel economy enhancement, but suitable for driving on hills or through curves on mountain roads.

The SPORT mode is turned off every time you start the power system, even if you turned it on the last time you drove the vehicle.

Reactive Force Pedal

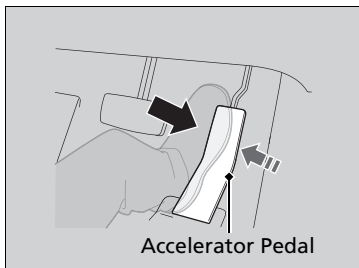

The system increases the accelerator pedal resistance force when you depress the accelerator pedal. This gives you the feeling that the vehicle's acceleration is in response to your pedal operation.

At the same time, a slight increase in the accelerator pedal resistance force helps to modify your driving style to be in an efficient manner especially when you apply more force to the pedal than is necessary.

The Reactive Force Pedal is designed also to help prevent your wheels from possibly spinning out due to excessive throttle, and help make the vehicle start smoothly when roads are slippery due to ice, snow, excessive rainfall, etc.

▶▶ Reactive Force Pedal

The Reactive Force Pedal system in no way restricts or limits your ability to operate the accelerator pedal to accelerate the vehicle.

If the Collision Mitigation Braking System™ (CMBS™) detects a possible collision, you may feel an opposing force from the accelerator pedal.

▶▶ **Collision Mitigation Braking System™ (CMBS™)** P. 458

You can change the amount of the accelerator pedal resistance force.

▶▶ **Customized Features** P. 295

The Reactive Force Pedal system is deactivated when SPORT mode is on.

Acoustic Vehicle Alerting System

Alerts pedestrians when a vehicle is propelled solely by electricity, approaching at speeds around 12 mph (20 km/h) or less.

Canadian models

Acoustic Vehicle Alerting System OFF Button

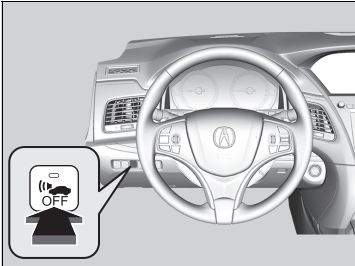

Press the button to turn the system on and off.

- ▶ The indicator in the button comes on when the system is off.

The system is turned on every time you turn the power system on, even if you turned it off the last time you drove the vehicle.

AcuraWatch™

AcuraWatch™ is a driver support system which employs the use of two distinctly different kinds of sensors, a radar sensor located in the front grille and a front sensor camera mounted to the interior side of the windshield, behind the rearview mirror.

AcuraWatch™ has the following functions:

■ Functions that do not need to be activated by the driver

- Road Departure Mitigation (RDM) System 📄 P. 416
- Collision Mitigation Braking System™ (CMBS™) 📄 P. 458

■ Functions that need to be activated by the driver

- Adaptive Cruise Control (ACC) with Low Speed Follow 📄 P. 402
- Lane Keeping Assist System (LKAS) 📄 P. 421
- Traffic Jam Assist 📄 P. 428

■ Operation Switches for the ACC with Low Speed Follow/ LKAS/Traffic Jam Assist

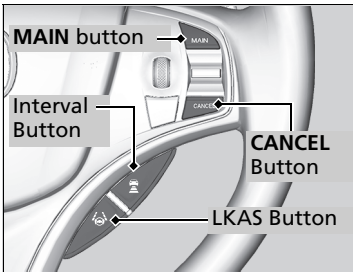

■ MAIN Button

Press to activate standby mode for ACC with Low Speed Follow, LKAS, and Traffic Jam Assist. Or press to cancel these systems.

■ LKAS Button

Press to activate or cancel the LKAS and Traffic Jam Assist.

■ RES/+ / SET/- Switch

Press **RES/+** to resume the ACC with Low Speed Follow or increase the vehicle speed. Press **SET/-** to set the ACC with Low Speed Follow or decrease the vehicle speed.

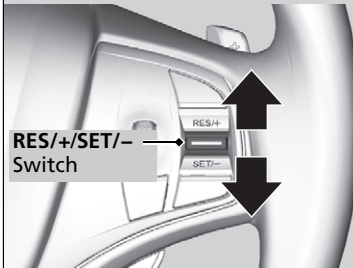

■ Interval Button

Press the  (interval) button to change the ACC with Low Speed Follow following-interval.

■ CANCEL Button

Press to cancel ACC with Low Speed Follow.

Multi-Information Display Content

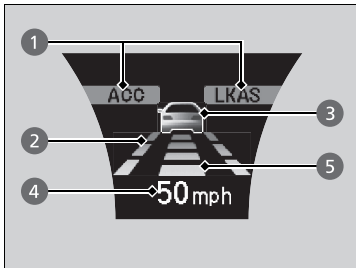

You can see the current state of ACC with Low Speed Follow, LKAS and Traffic Jam Assist.

- 1 Indicates that ACC with Low Speed Follow, Traffic Jam Assist, and LKAS are ready to be activated.
- 2 Indicates that LKAS and Traffic Jam Assist are activated and whether or not traffic lane lines are detected.
- 3 Indicates whether or not a vehicle is detected ahead.
- 4 Shows the set vehicle speed.
- 5 Shows the set vehicle interval.

Multi-Information Display Content

You can have the head-up display show you the current state of each function.

▶ **Head-Up Display** P. 119

How to Operate the Buttons on the Steering Wheel

To activate ACC with Low Speed Follow, LKAS, and Traffic Jam Assist, carry out the following steps:

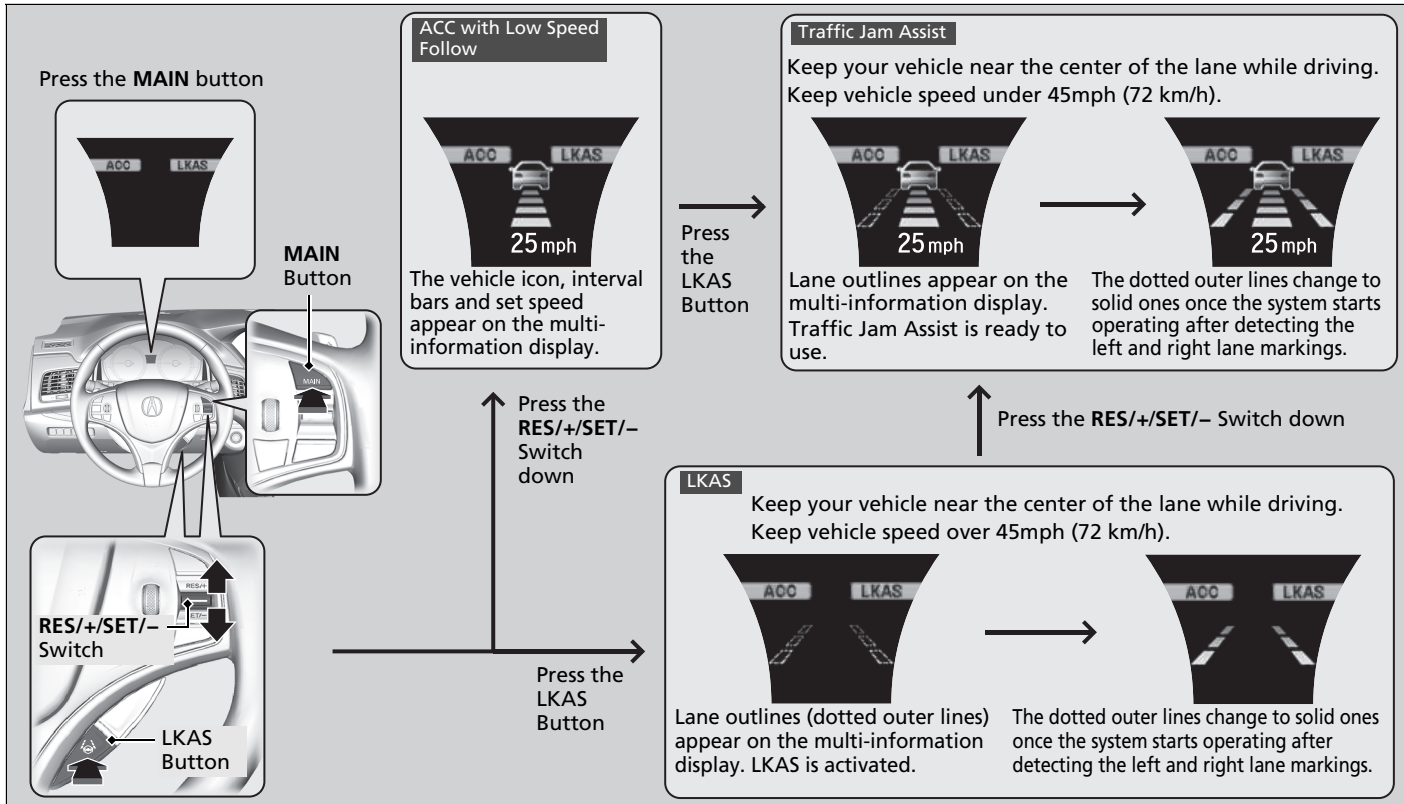

Front Sensor Camera

The camera, used in systems such as LKAS, RDM, ACC with Low Speed Follow, Traffic Jam Assist, and CMBS™, is designed to detect an object that triggers any of the systems to operate its functions.

■ Camera Location and Handling Tips

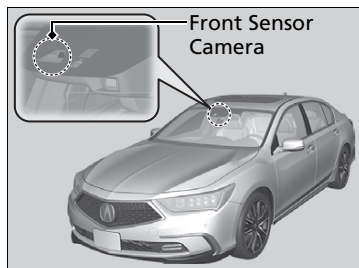

This camera is located behind the rearview mirror.

To help reduce the likelihood that high interior temperatures will cause the camera's sensing system to shut off, when parking, find a shady area or face the front of the vehicle away from the sun. If you use a reflective sun shade, do not allow it to cover the camera housing. Covering the camera can concentrate heat on it.

▣ Front Sensor Camera

Never apply a film or attach any objects to the windshield, the hood, or the front grille that could obstruct the camera's field of vision and cause the system to operate abnormally.

Scratches, nicks, and other damage to the windshield within the camera's field of vision can cause the system to operate abnormally. If this occurs, we recommend that you replace the windshield with a genuine Acura replacement windshield. Making even minor repairs within the camera's field of vision or installing an aftermarket replacement windshield may also cause the system to operate abnormally. After replacing the windshield, have a dealer recalibrate the camera. Proper calibration of the camera is necessary for the system to operate properly.

Do not place an object on the top of the instrument panel. It may reflect onto the windshield and prevent the system from detecting lane lines properly.

⌘ Front Sensor Camera

If the **Some Driver Assist Systems Cannot Operate: Camera Temperature Too High** message appears:

- Use the climate control system to cool down the interior and, if necessary, also use defroster mode with the airflow directed towards the camera.
- Start driving the vehicle to lower the windshield temperature, which cools down the area around the camera.

If the **Some Driver Assist Systems Cannot Operate: Clean Front Windshield** message appears:

- Park your vehicle in a safe place, and clean the windshield. If the message does not disappear after you have cleaned the windshield and driven for a while, have your vehicle checked by a dealer.

Adaptive Cruise Control (ACC) with Low Speed Follow

Helps maintain a constant vehicle speed and a set following-interval behind a vehicle detected ahead of yours and, if the detected vehicle comes to a stop, decelerates and stop your vehicle, without you having to keep your foot on the brake or the accelerator.

When ACC with Low Speed Follow slows your vehicle by applying the brakes, your vehicle's brake lights will illuminate.

▶ Adaptive Cruise Control (ACC) with Low Speed Follow

⚠ WARNING

Improper use of ACC with Low Speed Follow can lead to a crash.

Use ACC with Low Speed Follow only when driving on expressways or freeways and in good weather conditions.

⚠ WARNING

ACC with Low Speed Follow has limited braking capability and may not stop your vehicle in time to avoid a collision with a vehicle that quickly stops in front of you.

Always be prepared to apply the brake pedal if the conditions require.

Important Reminder

As with any system, there are limits to ACC with Low Speed Follow. Use the brake pedal whenever necessary, and always keep a safe interval between your vehicle and other vehicles.

When to use

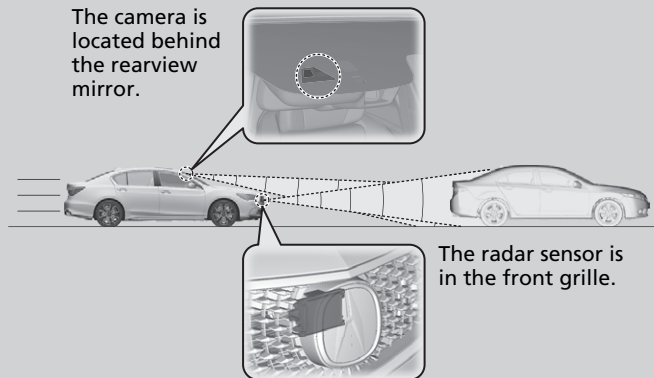

■ Vehicle speed for ACC with Low Speed Follow: **A vehicle is detected ahead within ACC with Low Speed Follow range** – ACC with Low Speed Follow operates at speeds up to 90 mph (145 km/h).

No vehicle is detected within ACC with Low Speed Follow range – ACC with Low Speed Follow operates at the speed of 25 mph (40 km/h) or above.

■ Gear position for ACC with Low Speed Follow: In **D**.

■ How to activate the system

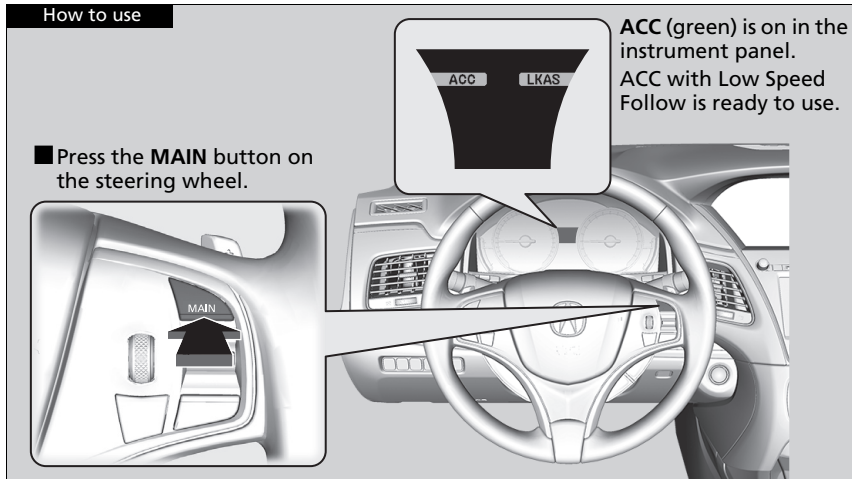

▣ Adaptive Cruise Control (ACC) with Low Speed Follow

When the **MAIN** button is pressed, both ACC with Low Speed Follow and the Lane Keeping Assist System (LKAS) are either turned on or off.

ACC with Low Speed Follow may not work properly under certain conditions.

▣ ACC with Low Speed Follow Conditions and Limitations P. 407

When not using ACC with Low Speed Follow: Turn off adaptive cruise by pressing the **MAIN** button. This also will turn off the Lane Keeping Assist System (LKAS).

Do not use Traffic Jam Assist under the following conditions:

- You are driving on a road with sharp curves.
- ▶ The system may not allow your vehicle to respond in a manner best suited for the road conditions.
- You are entering a toll booth, interchange, service area, or parking area.
- ▶ If the vehicle ahead disappears from the travel path of your vehicle, your vehicle may suddenly accelerate to resume the set speed.
- You are driving in bad weather (rain, fog, snow, etc.).
- ▶ The system may not be able to correctly determine the distance between your vehicle and the one ahead.
- The surface of the road is slippery, for example, it is icy or covered with snow.
- ▶ The tires may slip, causing you to lose control of the vehicle.

■ To Set the Vehicle Speed

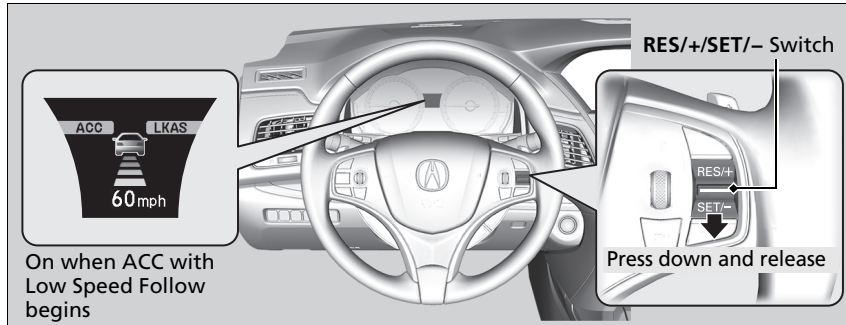

When driving at about 25 mph (40 km/h) or above: Take your foot off the pedal and press down the **RES/+SET/-** switch when you reach the desired speed. The moment you release the switch, the set speed is fixed, and ACC with Low Speed Follow begins.

When driving at slower than about 25 mph (40 km/h): If the vehicle is moving and the brake pedal is not depressed, pressing the switch fixes the set speed to about 25 mph (40 km/h) regardless of current vehicle speed. If the vehicle is stationary, you can set the vehicle speed even with the brake pedal depressed.

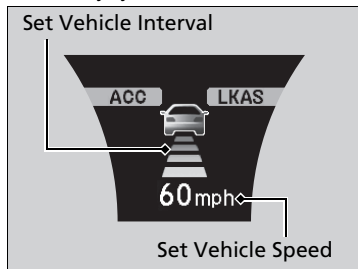

When ACC with Low Speed Follow starts operating, the vehicle icon, interval bars and set speed appear on the multi-information display.

▶▶ To Set the Vehicle Speed

You can switch the displayed set speed measurements on the audio/information screen between mph and km/h.

▶ **Customized Features** P. 295

■ When in Operation

■ There is a vehicle ahead

ACC with Low Speed Follow monitors if a vehicle ahead of you enters the ACC with Low Speed Follow range. If a vehicle is detected doing so, the ACC with Low Speed Follow system maintains or decelerates your vehicle's set speed in order to keep the vehicle's set following-interval from the vehicle ahead.

➤ **To Set or Change Following-Interval** P. 410

When a vehicle whose speed is slower than your set speed is detected in front of you, your vehicle starts to slow down.

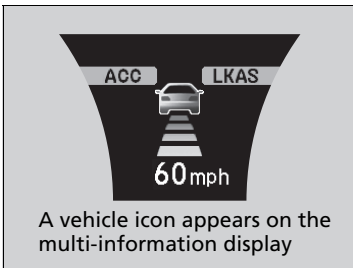
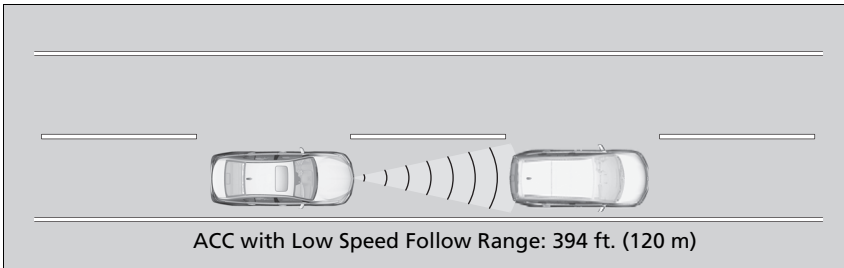

▶ When in Operation

If the vehicle detected ahead of you slows down abruptly, or if another vehicle is detected cutting in front of you, the beeper sounds, a message appears on the multi-information display, and the head-up warning come on.

Depress the brake pedal, and keep an appropriate interval from the vehicle ahead.

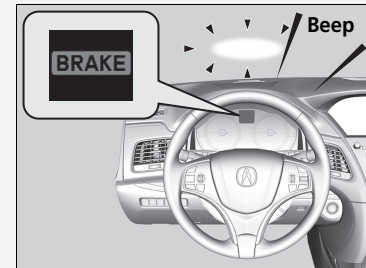

Even if the interval between your vehicle and the vehicle detected ahead is short, ACC with Low Speed Follow may start accelerating your vehicle under the following circumstances:

- The vehicle ahead of you is going at almost the same speed as, or faster than, your vehicle.
- A vehicle that cuts in front of you is going faster than your vehicle, gradually increasing the interval between the vehicles.

You can also set the system to beep when a vehicle in front of you comes in and goes out of the ACC with Low Speed Follow detecting range. Change the **ACC Forward Vehicle Detect Beep** setting.

➤ **Customized Features** P. 295

■ **There is no vehicle ahead**

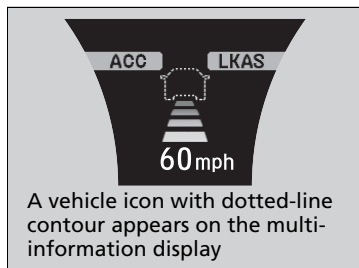

Your vehicle maintains the set speed without having to keep your foot on the brake or accelerator pedal. If there previously was a vehicle detected ahead that kept your vehicle from traveling at the set speed, ACC with Low Speed Follow accelerates your vehicle to the set speed, and then maintains it.

■ **When you depress the accelerator pedal**

You can temporarily increase the vehicle speed. In this case, there is no audible or visual alert even if a vehicle is in the ACC with Low Speed Follow range. ACC with Low Speed Follow stays on unless you cancel it. Once you release the accelerator pedal, the system resumes an appropriate speed for keeping the following-interval while a vehicle ahead is within the ACC with Low Speed Follow range.

■ **A vehicle detected ahead is within ACC with Low Speed Follow range and slows to a stop**



Your vehicle also stops, automatically. The **Stopped** message appears on the multi-information display. When the vehicle ahead of you starts again, the vehicle icon on the multi-information display blinks. If you press the **RES/+ / SET / -** switch up or down, or depress the accelerator pedal, ACC with Low Speed Follow operates again within the prior set speed.

⌘ When in Operation

Limitations

You may need to use the brake to maintain a safe interval when using ACC with Low Speed Follow. Additionally, ACC with Low Speed Follow may not work properly under certain conditions.

▶ **ACC with Low Speed Follow Conditions and Limitations** P. 407

⌘ A vehicle detected ahead is within ACC with Low Speed Follow range and slows to a stop

⚠ WARNING

Exiting a vehicle that has been stopped while the ACC with Low Speed Follow system is operating can result in the vehicle moving without operator control.

A vehicle that moves without operator control can cause a crash, resulting in serious injury or death.

Never exit a vehicle when the vehicle is stopped by ACC with Low Speed Follow.

■ ACC with Low Speed Follow Conditions and Limitations

The system may automatically shut off and the **ACC** indicator will come on under certain conditions. Some examples of these conditions are listed below. Other conditions may reduce some of the ACC functions.

📷 **Front Sensor Camera** P. 400

■ Environmental conditions

- Driving in bad weather (rain, fog, snow, etc.).

■ Roadway conditions

- Driving on a snowy or wet roadway (obscured lane marking, vehicle tracks, reflected lights, road spray, high contrast).

■ Vehicle conditions

- The outside of the windshield is blocked by dirt, mud, leaves, wet snow, etc.
- An abnormal tire or wheel condition (Wrong sized, varied size or construction, improperly inflated, compact spare tire*, etc.).
- The camera temperature gets too high.
- The parking brake is applied.
- When the front grille is dirty.
- The vehicle is tilted due to a heavy load or suspension modifications.
- When tire chains are installed.

* Not available on all models

📷 ACC with Low Speed Follow Conditions and Limitations

The radar sensor for ACC with Low Speed Follow is shared with the Collision Mitigation Braking System™ (CMBS™).

📷 **Collision Mitigation Braking System™ (CMBS™)** P. 458

You can read about handling information for the camera equipped with this system.

📷 **Front Sensor Camera** P. 400

Always keep the radar sensor cover clean.

Never use chemical solvents or polishing powder for cleaning the sensor cover. Clean it with water or a mild detergent.

Do not put a sticker on the radar sensor cover or replace the radar sensor cover.

If you need the radar sensor to be repaired, or removed, or the radar sensor cover is strongly impacted, turn off the system by pressing the **MAIN** button and take your vehicle to a dealer.

Have your vehicle checked by a dealer if you find any unusual behavior of the system (e.g., the warning message appears too frequently).

■ Detection limitations

- A vehicle suddenly crosses in front of you.
- The interval between your vehicle and the vehicle ahead of you is too short.
- A vehicle cuts in front of you at a slow speed, and it brakes suddenly.
- When you accelerate rapidly and approach the vehicle ahead of you at high speed.
- The vehicle ahead of you is a motorcycle, bicycle, mobility scooter, or other small vehicle.
- When there are animals in front of your vehicle.
- When you drive on a curved or winding or undulating road that makes it difficult for the sensor to properly detect a vehicle in front of you.
- The speed difference between your vehicle and a vehicle in front of you is significantly large.
- An oncoming vehicle suddenly comes in front of you.
- Your vehicle abruptly crosses over in front of an oncoming vehicle.
- When driving through a narrow iron bridge.
- When the vehicle ahead of you brakes suddenly.
- When the vehicle ahead of you has a unique shape.
- When your vehicle or the vehicle ahead of you is driving on one edge of the lane.

⚡ ACC with Low Speed Follow Conditions and Limitations

If the front of the vehicle is impacted in any of the following situations, the radar sensor may not work properly. Have your vehicle checked by a dealer:

- The vehicle mounted onto a bump, curb, chock, embankment, etc.
- You drive the vehicle where the water is deep.
- Your vehicle has a frontal collision.

■ To Adjust the Vehicle Speed

Increase or decrease the vehicle speed using the **RES/+**/**SET/-** switch on the steering wheel.

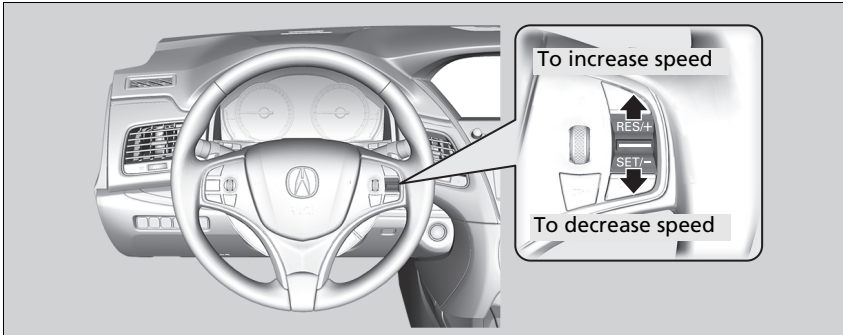



- Each time you press the switch up or down, the vehicle speed is increased or decreased by about 1 mph or 1 km/h accordingly.
- If you keep the switch pressed up or down, the vehicle speed increases or decreases by about 5 mph or 5 km/h accordingly.

☒ To Adjust the Vehicle Speed

If a vehicle detected ahead is going at a speed slower than your increased set speed, ACC with Low Speed Follow may not accelerate your vehicle. This is to maintain the set following-interval between your vehicle and the vehicle ahead.

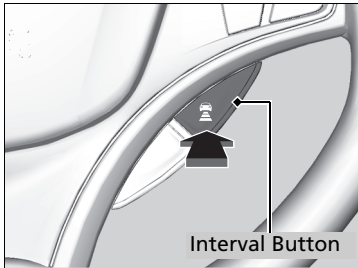
■ To Set or Change Following-Interval







Press the  (interval) button to change the ACC with Low Speed Follow following-interval.

Each time you press the button, the following-interval (the interval behind a vehicle detected ahead of you) setting cycles through short, middle, long, and extra long following-interval.

Determine the most appropriate following-interval setting based on your specific driving conditions. Be sure to adhere to any following-interval requirements set by local regulation.

The higher your vehicle's following-speed is, the longer the short, middle, long or extra long following-interval becomes. See the following examples for your reference.

Following-interval		When the Set Speed is:	
		50 mph (80 km/h)	65 mph (104 km/h)
Short		84 feet 26 meters 1.1 sec	102 feet 31 meters 1.1 sec
Middle		111 feet 34 meters 1.5 sec	139 feet 43 meters 1.5 sec
Long		155 feet 48 meters 2.1 sec	202 feet 62 meters 2.1 sec
Extra Long		204 feet 62 meters 2.8 sec	265 feet 81 meters 2.8 sec

When your vehicle stops automatically because a vehicle detected ahead of you has stopped, the interval between the two vehicles will vary based on the ACC with Low Speed Follow interval setting.

■ To Cancel

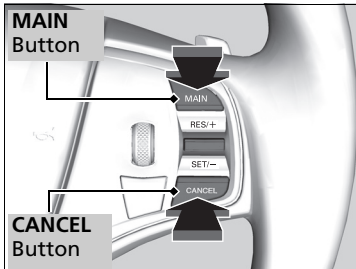

To cancel ACC with Low Speed Follow, do any of the following:

- Press the **CANCEL** button.
- Press the **MAIN** button.
 - ▶ ACC with Low Speed Follow indicator goes off.
- Depress the brake pedal.
 - ▶ When the Low Speed Follow function has stopped the vehicle, you cannot cancel ACC with Low Speed Follow by depressing the brake pedal.

▶▶ To Cancel

Resuming the prior set speed:

After you have canceled ACC with Low Speed Follow, you can resume the prior set speed while it is still displayed. Press the **RES/+**/**SET/-** switch up.

The set speed cannot be set or resumed when ACC with Low Speed Follow has been turned off using the **MAIN** button. Press the **MAIN** button to activate the system, then set the desired speed.

■ Automatic cancellation

The beeper sounds and a message appears on the multi-information display when ACC with Low Speed Follow is automatically canceled. Any of these conditions may cause the ACC with Low Speed Follow to automatically cancel:

- Bad weather (rain, fog, snow, etc.)
- When the radar sensor in the front grille gets dirty.
- The vehicle ahead of you cannot be detected.
- An abnormal tire condition is detected, or the tires are skidding.
- Driving on a mountainous road, or driving off road for extended periods.
- Abrupt steering wheel movement.
- When the ABS, VSA® or CMBS™ is activated.
- When the ABS or VSA® system indicator comes on.
- When the vehicle is stopped on a very steep slope.
- When you manually apply the parking brake.
- When the detected vehicle within the ACC with Low Speed Follow range is too close to your vehicle.
- When a detected vehicle goes out of the ACC with Low Speed Follow range while your vehicle is stationary.
- The camera behind the rearview mirror, or the area around the camera, including the windshield, gets dirty.

The ACC with Low Speed Follow automatic cancellation can be also triggered by the following causes. In these cases, the parking brake will be automatically applied.

- The driver's seat belt is unfastened when the vehicle is stationary.
- The vehicle stops for more than 10 minutes.
- The power system is turned off.

⌘ Automatic cancellation

Even though ACC with Low Speed Follow has been automatically canceled, you can still resume the prior set speed. Wait until the condition that caused ACC with Low Speed Follow to cancel improves, then press the **RES/+SET/-** switch up.

■ To Switch ACC with Low Speed Follow to Cruise Control

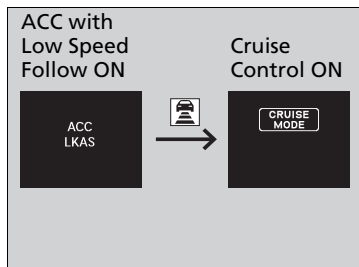

Press and hold the  (interval) button for one second. **Cruise Mode Selected** appears on the multi-information display for two seconds, and then the mode switches to Cruise.

To switch back to ACC with Low Speed Follow, press and hold the  (interval) button again for one second. **ACC Mode Selected** appears on the multi-information display for two seconds.

☒ To Switch ACC with Low Speed Follow to Cruise Control

Always be aware which mode you are in. When you are driving in Cruise mode, the system will not assist you to maintain a following-interval from a vehicle ahead of you.

■ When to use

Desired speed in a range above roughly 25 mph (40 km/h) ~.

■ To Set the Vehicle Speed

Take your foot off the pedal and press the **RES/+ / SET / -** switch down when you reach the desired speed.

The moment you release the **RES/+ / SET / -** switch, the set speed is fixed, and cruise control begins. The **CRUISE CONTROL** indicator comes on.

■ To Adjust the Vehicle Speed

Each time you press the **RES/+ / SET / -** switch up or down, the vehicle speed is increased or decreased by about 1 mph (1.6 km/h).

If you keep the **RES/+ / SET / -** switch pressed up or down, the vehicle speed increases or decreases until you release it. This speed is then set.

■ To Cancel

To cancel cruise control, do any of the following:

- Press the **CANCEL** button.
- Press the **MAIN** button.
- Depress the brake pedal.

The **CRUISE CONTROL** indicator goes off.

☒ To Cancel

Resuming the prior set speed:

After cruise control has been canceled, you can still resume the prior set speed by pressing the **RES/+ / SET/-** switch up while driving at a speed of at least 25 mph (40 km/h) or more.

You cannot set or resume in the following situations:

- When vehicle speed is less than 25 mph (40 km/h)
- When the **MAIN** button is turned off.

At vehicle speeds of 22 mph (35 km/h) or less, cruise control canceled automatically.

Road Departure Mitigation (RDM) System

Alerts and helps to assist you when the system detects a possibility of your vehicle unintentionally crossing over detected lane markings and/or leaving the roadway altogether.

How the System Works

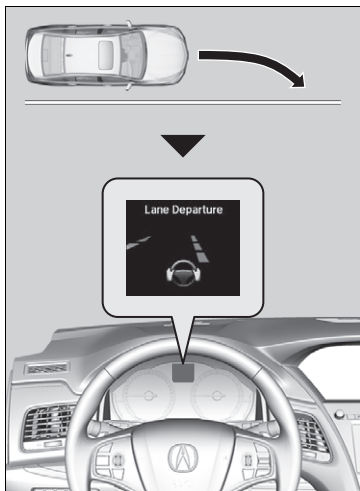

The front camera behind the rearview mirror monitors left and right lane markings (in white or yellow). If your vehicle is getting too close to detected lane markings without a turn signal activated, the system, in addition to a visual alert, applies steering torque and alerts you with rapid vibrations on the steering wheel, to help you remain within the detected lane.

▶ **Customized Features** P. 295

As a visual alert, the **Lane Departure** message appears on the multi-information display.

If the system determines that its steering input is insufficient to keep your vehicle on the roadway, it may apply braking.

▶ Braking is applied only when the lane markings are solid continuous lines.

▶▶ Road Departure Mitigation (RDM) System

Important Safety Reminder

Like all assistance systems, the RDM system has limitations.

Over-reliance on the RDM system may result in a collision. It is always your responsibility to keep the vehicle within your driving lane.

The RDM system only alerts you when lane drift is detected without a turn signal in use. The RDM system may not detect all lane markings or lane or roadway departures; accuracy will vary based on weather, speed and lane marker condition. It is always your responsibility to safely operate the vehicle and avoid collisions.

You can read about handling information for the camera equipped with this system.

▶ **Front Sensor Camera** P. 400

The RDM system may not work properly or may work improperly under the certain conditions:

▶ **RDM Conditions and Limitations** P. 419

There are times when you may not notice RDM functions due to your operation of the vehicle, or road surface conditions.

The system cancels assisting operations when you turn the steering wheel to avoid crossing over detected lane markings.

If the system operates several times without detecting driver response, the system beeps to alert you.

▣ Road Departure Mitigation (RDM) System

If LKAS is off and you have selected **Narrow** from the customized options using the audio/information screen, the message below will appear in case the system determines a possibility of your vehicle crossing over detected lane markings.

▣ **Customized Features** P. 295

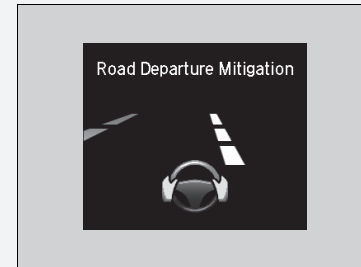

Continued

■ How the System Activates

The system becomes ready to start searching for lane markings when all the following conditions are met:

- The vehicle is traveling between 45 and 89 mph (72 and 144 km/h).
- The vehicle is on a straight or slightly curved road.
- The turn signals are off.
- The brake pedal is not depressed.
- The wipers are not in continuous operation.
- The system makes a determination that the driver is not actively accelerating, braking or steering.

■ RDM On and Off

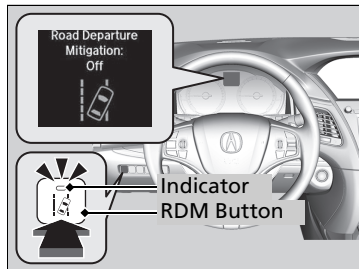

Press the RDM button to turn the system on and off.

- ▶ The indicator in the button comes on and the message appears on the multi-information display when the system is on.

▶ How the System Activates

The RDM system may automatically shut off and the  indicator comes and stays on.

▶ **Indicators** P. 76

RDM system function can be impacted when the vehicle is:

- Not driven within a traffic lane.
- Driven on the inside edge of a curve, or outside of a lane.
- Driven in a narrow lane.

▶ RDM On and Off

When you have selected **Warning Only** from the customized options using the audio/information screen, the system does not operate the steering wheel and braking.

▶ **Customized Features** P. 295

RDM Conditions and Limitations

The system may not properly detect lane markings and the position of your vehicle under certain conditions. Some examples of these conditions are listed below.

■ Environmental conditions

- Driving in bad weather (rain, fog, snow, etc.).
- Sudden changes between light and dark, such as an entrance or exit of a tunnel.
- There is little contrast between lane lines and the roadway surface.
- Driving into low sunlight (e.g., at dawn or dusk).
- Strong light is reflected onto the roadway.
- Driving in the shadows of trees, buildings, etc.
- Shadows of adjacent objects are parallel to lane markings.
- Roadway objects or structures are misinterpreted as lane markers.
- Reflections on the interior of the windshield.
- Driving at night or in a dark condition such as a tunnel.

■ **Roadway conditions**

- Driving on a snowy or wet roadway (obscured lane marking, vehicle tracks, reflected lights, road spray, high contrast).
- Driving on a road with temporary lane markings.
- Faint, multiple, or varied lane markings are visible on the roadway due to road repairs or old lane markings.
- The roadway has merging, split, or crossing lines (e.g., such as at an intersection or crosswalk).
- The lane markings are extremely narrow, wide, or changing.
- The vehicle in front of you is driving near the lane lines.
- The road is hilly or the vehicle is approaching the crest of a hill.
- Driving on rough or unpaved roads, or over bumpy surfaces.
- When objects on the road (curb, guard rail, pylons, etc.) are recognized as white lines (or yellow lines).
- Driving on roads with double lines.
- The road has ruts.

■ **Vehicle conditions**

- Headlight lenses are dirty or the headlights are not properly adjusted.
- The outside of the windshield is streaked or blocked by dirt, mud, leaves, wet snow, etc.
- The inside of the windshield is fogged.
- The camera temperature gets too high.
- An abnormal tire or wheel condition (wrong sized, varied size or construction, improperly inflated, compact spare tire*, etc.).
- The vehicle is tilted due to a heavy load or suspension modifications.
- When tire chains are installed.

Lane Keeping Assist System (LKAS)

Provides steering input to help keep the vehicle in the middle of a detected lane and provides tactile and visual alerts if the vehicle is detected drifting out of its lane.

■ Steering input assist
The system applies torque to the steering to keep the vehicle between the left and right lane lines. The applied torque becomes stronger as the vehicle gets closer to either of the lane lines.

■ Front sensor camera
Monitors the lane lines

■ Tactile and visual alerts
Rapid vibrations on the steering wheel and a warning display alert you that the vehicle is drifting out of a detected lane.

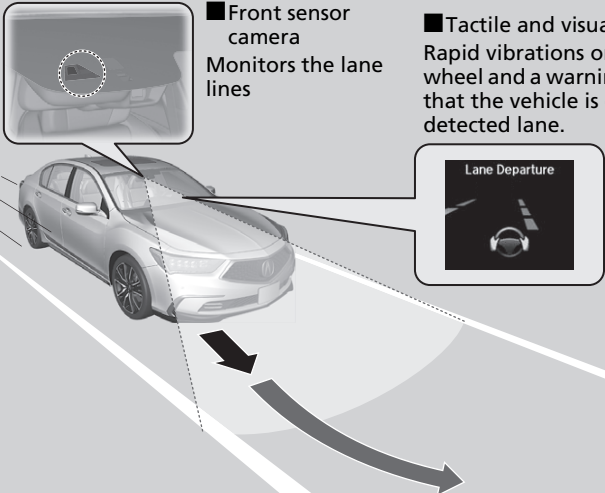

When you operate the turn signals to change lanes, the system is suspended, and resumes after the signals are off.
If you make a lane change without operating the turn signals, the LKAS alerts activate, and torque is applied to the steering.

ⓘ Lane Keeping Assist System (LKAS)

Important Safety Reminders

The LKAS is for your convenience only. It is not a substitute for your vehicle control. The system does not work if you take your hands off the steering wheel or fail to steer the vehicle.

📌 Multi-Information Display Warning and Information Messages P. 94

Do not place objects on the instrument panel. Objects may reflect on the front windshield and prevent correct detection of the traffic lanes.

The LKAS only alerts you when lane drift is detected without a turn signal in use. The LKAS may not detect all lane markings or lane departures; accuracy will vary based on weather, speed, and lane marker condition. It is always your responsibility to safely operate the vehicle and avoid collisions.

The LKAS is convenient when it is used on freeways.

The LKAS may not work properly or may work improperly under the certain conditions:

📌 LKAS Conditions and Limitations P. 426

You can read about handling information for the camera equipped with this system.

📌 Front Sensor Camera P. 400

■ Lane Keep Support Function

Provides assistance to keep the vehicle in the center of the lane. When the vehicle nears a white or yellow line, steering force of the electric power steering will become stronger.

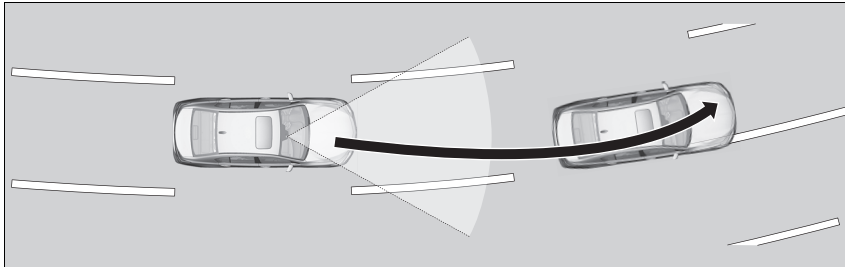

■ Lane Departure Warning Function

When the vehicle enters the warning area, the LKAS alerts you with slight steering wheel vibration as well as a warning display.

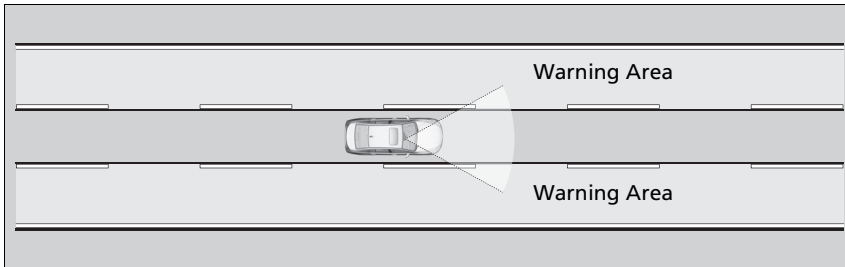

☒ Lane Keeping Assist System (LKAS)

The LKAS may not function as designed while driving in frequent stop and go traffic, or on roads with sharp curves.

When it fails to detect lanes, the system will temporarily be canceled. When lane is detected, system will recover automatically.

■ When the System can be Used

The system can be used when the following conditions are met.

- The lane in which you are driving has detectable lane markers on both sides, and your vehicle is in the center of the lane.
- The vehicle speed is between 45 and 89 mph (72 and 144 km/h).
- You are driving on a straight or slightly curved road.
- The driver is gripping the steering wheel.

■ How to activate the system

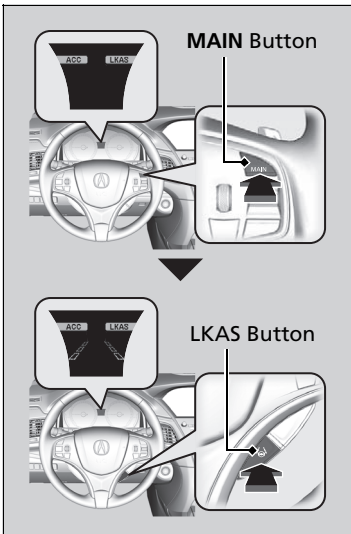

1. Press the **MAIN** button.

- ▶ The **LKAS** indicator comes on in the multi-information display.
The system is ready to use.

2. Press the LKAS button.

- ▶ Lane outlines (dotted outer lines) appear on the multi-information display.
The system is activated.

☒ When the System can be Used

If the vehicle drifts toward either left or right lane line due to the system applying torque, turn off the LKAS and have your vehicle checked by a dealer.

☒ How to activate the system

You can have the head-up display show you the current state of Traffic Jam Assist.

- ☒ **Head-Up Display** P. 119

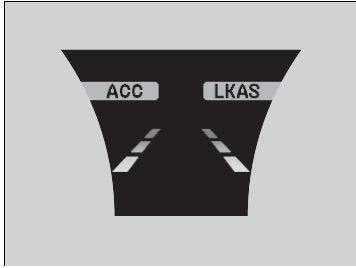

3. Keep your vehicle near the center of the lane while driving.
 - ▶ The dotted outer lines change to solid ones once the system starts operating after detecting the left and right lane markings.

■ To cancel

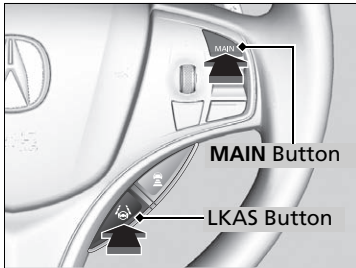

To cancel the LKAS:
Press the **MAIN** or LKAS button.

The LKAS is turned off every time you turn the power system off, even if you turned it on the last time you drove the vehicle.

▶▶ To cancel

Pressing the **MAIN** button also turns ACC with Low Speed Follow on and off.

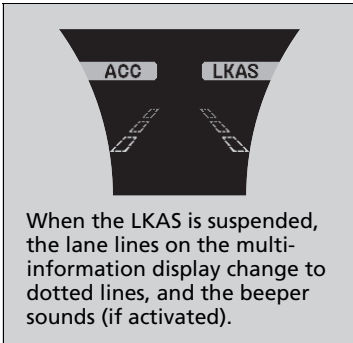

■ **The system operation is suspended if you:**

- The wipers are set to **HI**.
 - ▶ Turning the wipers off resumes the LKAS.
- Decrease the vehicle speed to about 40 mph (64 km/h) or less.
 - ▶ Increasing the vehicle speed to about 45 mph (72 km/h) or more resumes the LKAS.
- Depress the brake pedal.
 - ▶ The LKAS resumes and starts detecting the lane lines again once you release the brake pedal.
- Your vehicle is driving to the right or the left of the lane.

■ **The LKAS may automatically be suspended when:**

- The system fails to detect lane lines.
 - The steering wheel is quickly turned.
 - You fail to steer the vehicle.
 - Driving through a sharp curve.
 - Driving at a speed in excess of approximately 89 mph (144 km/h).
- Once these conditions no longer exist, the LKAS automatically resumes.

■ **The LKAS may automatically be canceled when:**

It is possible that under any of the following circumstances, dotted outer lines will appear on the multi-information display, a buzzer will sound, and LKAS will be canceled automatically.

- The camera temperature gets extremely high or low.
- The camera behind the rearview mirror, or the area around the camera, including the windshield, gets dirty.
- The ABS or VSA® system engages.

The beeper sounds if the LKAS is automatically canceled.

■ **LKAS Conditions and Limitations**

The system may not detect lane markings and therefore may not keep the vehicle in the middle of a lane under certain conditions, including the following:

■ **Environmental conditions**

- Driving in bad weather (rain, fog, snow, etc.).
- Sudden changes between light and dark, such as an entrance or exit of a tunnel.
- There is little contrast between lane lines and the roadway surface.
- Driving into low sunlight (e.g., at dawn or dusk).
- Strong light is reflected onto the roadway.
- Shadows are cast across the lane lines (e.g., trees, buildings, guardrails, vehicle, etc.).
- Roadway objects or structures are misinterpreted as lane markers.
- Reflections on the interior of the windshield.
- Driving at night or in a dark condition such as a tunnel.

■ Roadway conditions

- The lines are not very distinguishable from the surface of the road.
- Driving on a snowy or wet roadway (obscured lane marking, vehicle tracks, reflected lights, road spray, high contrast).
- Driving on a road with temporary lane markings.
- Faint, multiple, or varied lane markings are visible on the roadway due to road repairs or old lane markings.
- The roadway has merging, split, or crossing lines (e.g., such as at an intersection or crosswalk).
- The lane markings are extremely narrow, wide, or changing.
- The vehicle in front of you is driving near the lane lines.
- The road is hilly or the vehicle is approaching the crest of a hill.
- Driving on rough or unpaved roads, or over bumpy surfaces.
- When objects on the road (curb, guard rail, pylons, etc.) are recognized as white lines (or yellow lines).
- Driving on roads with double lines.

■ Vehicle conditions

- Headlight lenses are dirty or the headlights are not properly adjusted.
- The outside of the windshield is streaked or blocked by dirt, mud, leaves, wet snow, etc.
- The inside of the windshield is fogged.
- The camera temperature gets too high.
- An abnormal tire or wheel condition (wrong sized, varied size or construction, improperly inflated, compact spare tire*, etc.).
- The vehicle is tilted due to a heavy load or suspension modifications.
- The tires are equipped with snow chains.

* Not available on all models

Traffic Jam Assist

The traffic jam assist system uses a radar sensor mounted inside the front grille and a camera mounted to the upper portion of the windshield to detect and monitor left and right white (yellow) traffic lane lines as well as any vehicle ahead. Based on inputs from the radar sensor and camera, the system adjusts the speed of your vehicle to maintain a set interval between your vehicle and the one detected ahead. It also applies steering torque to keep your vehicle in the center of the detected lane when you are driving in heavy traffic.

■ How Traffic Jam Assist works

If you are in heavy traffic and Adaptive Cruise Control with Low Speed Follow is active, the traffic jam assist system, upon detecting the traffic lane lines and a vehicle ahead, will apply steering torque to help keep your vehicle in the center of the lane. The system adjusts the speed of your vehicle to maintain a set interval between your vehicle and the one detected ahead.

▶▶ Traffic Jam Assist

WARNING

Improper reliance on Traffic Jam Assist can cause a crash resulting in injury or death. Always maintain full control over your vehicle even when this system is active, and only use when on expressways or freeways. Traffic Jam Assist is not an autonomous driving system:

WARNING

Failure to securely park vehicle when stopped using Adaptive Cruise Control with Low Speed Follow is active can allow the vehicle to roll away, resulting in a crash causing injury or death. Never stop the vehicle and exit it without placing it in Park and setting the parking brake.

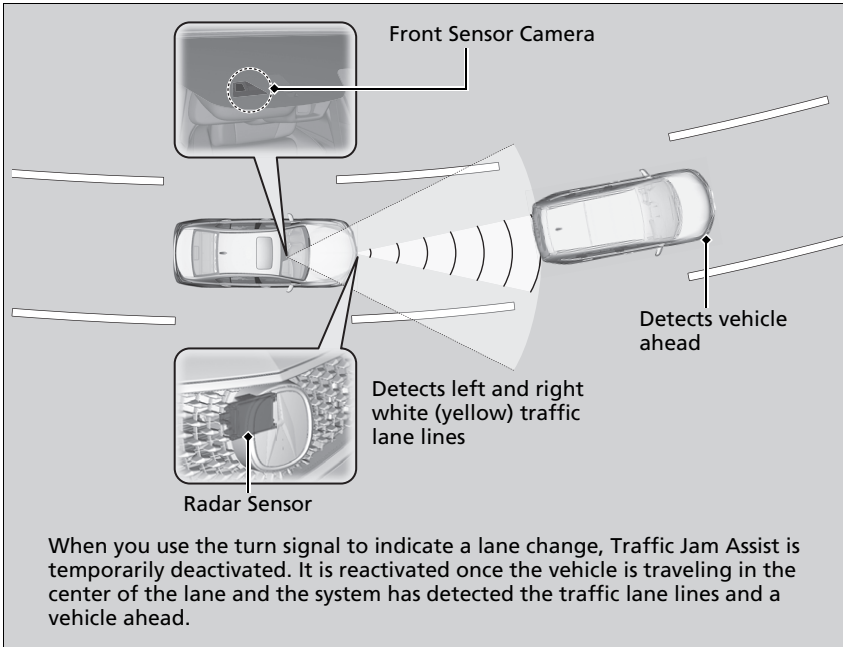

When the driver takes direct control of steering, the steering assist function is temporarily canceled. The torque applied to steering may not be noticeable when the driver has direct control of steering, or when the surface of the road is rough or uneven.

▶▶ Traffic Jam Assist

You can read about handling information for the camera equipped with this system.

▶ **Front Sensor Camera** P. 400

Traffic Jam Assist may not always be able to detect lane division lines or a vehicle traveling ahead. Depending on weather and road conditions and other factors, Traffic Jam Assist may not function normally. Always be aware of your surroundings and the road conditions, and conduct yourself in a manner conducive to safe driving. Traffic Jam Assist may not function properly when you are driving through a sharp curve or repeatedly accelerating and decelerating.

Traffic Jam Assist may not work properly under the certain conditions:

▶ **Traffic Jam Assist: Conditions and limitations** P. 434

Traffic Jam Assist Activation

Traffic Jam Assist is activated when all of the following circumstances exist:

- LKAS is activate.
- ACC with Low Speed Follow is active.
- The vehicle speed is between 0 and 45mph (0 and 72km/h) and there is a vehicle detected traveling ahead.
- The lane in which you are driving has detectable lane markers on both sides, and your vehicle is in the center of the lane.
- You are driving on a straight or slightly curved road.
- The driver is gripping the steering wheel.

Do not use Traffic Jam Assist in any of the following situations:

- You are traveling on a road with sharp curves.
 - ▶ The system may not allow your vehicle to respond in a manner best suited for the road conditions.
- You are entering a toll booth, interchange, service area, or parking area.
 - ▶ If the vehicle ahead disappears from the travel path of your vehicle, your vehicle may suddenly accelerate to resume the set speed.
- You are driving in adverse weather (rain, fog, snow, etc.).
 - ▶ The system may not be able to correctly determine the interval between your vehicle and the one ahead.
- The surface of the road is slippery, for example, it is icy or covered with snow.
 - ▶ The tires may slip, causing you to lose control of the vehicle.
- You are driving in a HOV lane and motorcycles are passing you to the side, or you are required to keep your vehicle to the right or the left of the lane.
 - ▶ The system may not be able to correctly determine the vehicle ahead.

Traffic Jam Assist Activation

Refer to the following page for proper handling of the Adaptive Cruise Control with Low Speed Follow:

▶ **Adaptive Cruise Control (ACC) with Low Speed Follow** P. 402

Refer to the following page for proper handling of the Lane Keeping Assist System (LKAS):

▶ **Lane Keeping Assist System (LKAS)** P. 421

Refer to the following page for steering buttons and displays:

▶ **How to Operate the Buttons on the Steering Wheel** P. 399

■ How Traffic Jam Assist Works

■ When a vehicle is traveling ahead

When a vehicle ahead of yours is detected entering the Traffic Jam Assist detection area, Traffic Jam Assist adjusts the speed of your vehicle to maintain the selected interval between your vehicle and the one ahead. It also applies steering torque to keep your vehicle in the center of the detected lane.

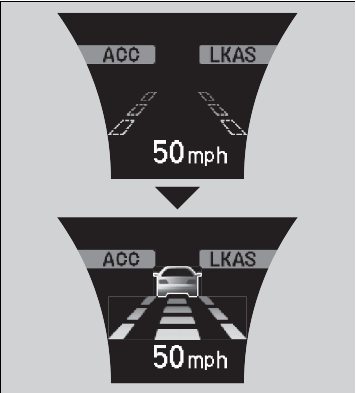
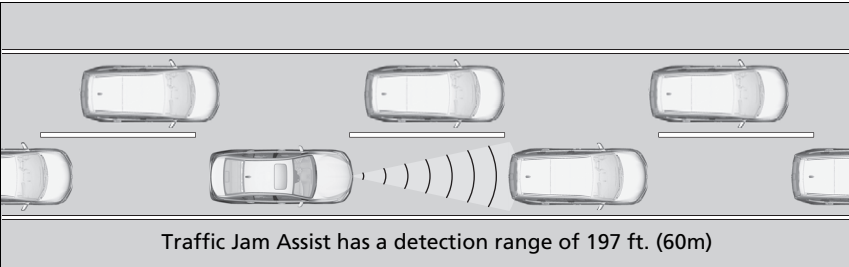

Keep your vehicle near the center of the lane while driving.

- ▶ Traffic Jam Assist will be activated once the camera has detected the white (yellow) traffic lane lines on either side of the lane and the radar sensor and camera have detected a vehicle driving ahead.
- The dotted outer lines change to solid ones and a vehicle icon appears on the multi-information display.

Continued

⊠ How Traffic Jam Assist Works

If your vehicle veers too far to the right or the left of the white (yellow) traffic lane lines while Traffic Jam Assist is active, deactivate Traffic Jam Assist and have an authorized Acura dealer inspect your vehicle.

In some cases the system cannot properly detect the traffic lane lines and, as a result, will not provide steering assistance.

⊠ Traffic Jam Assist: Conditions and limitations P. 434

If the driver takes his or her hands off the steering wheel or does not adequately maintain control of steering, the warning below will appear.



If the driver does not grip the steering wheel after the warning above has repeatedly appeared, a warning buzzer will sound and Traffic Jam Assist will be canceled.

You can have the head-up display show you the current state of Traffic Jam Assist.

⊠ Head-Up Display P. 119

■ When no vehicle is traveling ahead

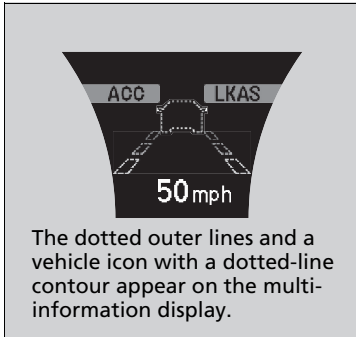

If the vehicle detected ahead disappears from the travel path of your vehicle (for example, it changes lanes), Traffic Jam Assist will be deactivated temporarily and your vehicle will gradually accelerate until it reaches the set speed, after which it will maintain that speed.

⌘ How Traffic Jam Assist Works

If the vehicle detected ahead suddenly slows down, or if another vehicle is detected cutting in front of yours, a warning buzzer will sound, and a warning in the multi-information display and head-up warning will appear.

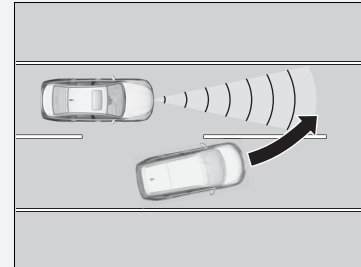

Depress the brake pedal and take direct control of steering.

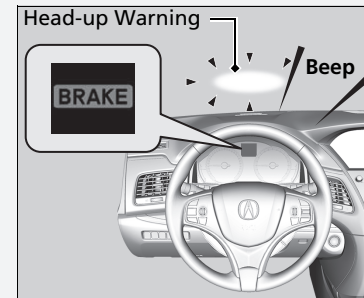

■ Canceling Traffic Jam Assist

To cancel Traffic Jam Assist, you can do any of the following:

- Press the **MAIN** button.
- Press the LKAS button.
- When the ACC with Low Speed Follow is deactivated.

■ When Traffic Jam Assist may automatically be suspended when:

The system is temporarily canceled automatically under the following circumstances.

- The system fails to detect lane lines.
- The vehicle ahead of you cannot be detected.
- The steering wheel is turned quickly.
- You fail to steer the vehicle.
- The vehicle in front of you is driving near the lane lines.

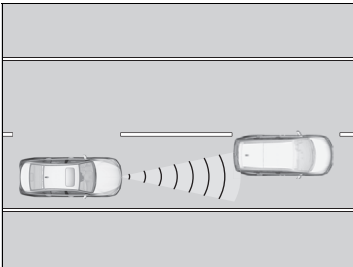

- The wipers are set to high.
- The interval between your vehicle and the one traveling ahead is over 197 feet (60m).

Once these conditions no longer exist, the Traffic Jam Assist automatically resumes.

⌘ How Traffic Jam Assist Works

If you are traveling slower than the vehicle detected ahead or a vehicle that is detected cutting in front of you and the interval between your vehicle and the detected vehicle gradually increases, your vehicle will continue to follow that vehicle without emitting any warning, even if the interval between the vehicle is minimal.

⌘ When Traffic Jam Assist may automatically be suspended when:

You are traveling over 45mph (72km/h).

▶ When the speed of the vehicle reaches 45mph (72km/h), Traffic Jam Assist is deactivated and LKAS is activated instead. Once the speed of the vehicle drops to under 42mph (68km/h), Traffic Jam Assist is reactivated.

■ When Traffic Jam Assist may automatically be canceled when:

It is possible that under any of the following circumstances, broken lines representing traffic lane lines will appear in the multi-information display, a buzzer will sound, and Traffic Jam Assist will be canceled.

- The temperature of the camera is too high.
- The camera behind the rearview mirror, or the area around the camera, including the windshield, is dirty.

■ Traffic Jam Assist: Conditions and limitations

Under the following circumstances, some features of Traffic Jam Assist may not work.

■ Vehicle conditions

- The front grille is dirty.
- Headlight lenses are dirty or the headlights are not properly adjusted.
- The outside of the windshield is streaked or blocked by dirt, mud, leaves, wet snow, etc.
- The inside of the windshield is fogged up.
- Your vehicle is fitted with tires or wheels of differing size, type, or structure, or the tires are not properly inflated.
- The vehicle is tilted due to a heavy load or suspension modifications.
- The interval between your vehicle and the detected vehicle ahead of you is too short.
- Snow chains are installed on the tires.

■ Environmental conditions

- Bad weather (rain, fog, snow, etc.).
- You are driving into low sunlight (e.g., at dawn or dusk).
- Strong light is reflected onto your vehicle or the roadway.
- Brightness in the immediate area suddenly changes between light and dark, such as at the entrance or exit of a tunnel.
- The road has puddles or the surface of the road is shiny due to recent rainfall.
- Shadows are cast across the lane lines (e.g., trees, buildings, guardrails, vehicle, etc.).
- Spray or snow coming off the vehicle ahead.
- Driving at night or in a dark condition such as a tunnel.

■ Roadway conditions

Certain features of the road can interfere with proper camera operation. Here are some examples:

- The lines are not very distinguishable from the surface of the road.
- The section of the road has lane restrictions or temporarily marked lanes.
- The lines are faded, removed lines remain visible next to newer lines (duplicate lines), or the road is marked with tire tracks.

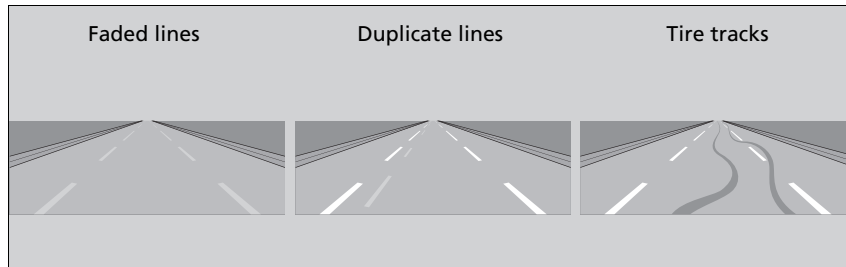

Continued

- The roadway has merging, split, or crossing lines (e.g., such as at an intersection or crosswalk).
- The lane markings are extremely narrow, wide, or of inconsistent width.

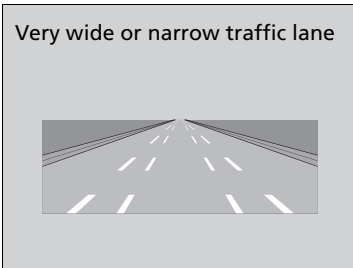

- The lane lines are partly concealed by your vehicle or another vehicle.
- The road is hilly or the vehicle is approaching the crest of a hill.
- The vehicle is shaking considerably because of an uneven road surface, etc.
- Objects on the road (curb, guard rail, pylons, etc.) are recognized as white lines (or yellow lines).
- The lines appear distorted or they briefly disappear out of the camera detection range due to an uneven road surface.
- The road is unpaved, or has a rough or bumpy surface.
- The roads has double lines.
- The surface of the road is slippery due to icy or snowy conditions.
- Sections of the paved road are obscured by puddles or snow.
- The road has ruts.

- The section of the road branches off or merges with another road.

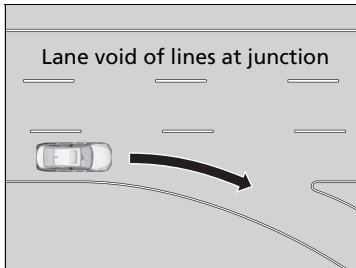

■ **Certain features of the road can interfere with proper radar sensor operation. Here are some examples:**

- The road has curves, undulations, slopes, etc.

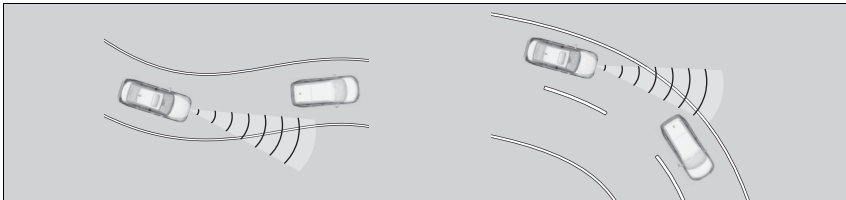

- The radar beam is reflecting off multiple items that are within close proximity of your vehicle. This can happen when you are driving, for example, across a narrow truss bridge.

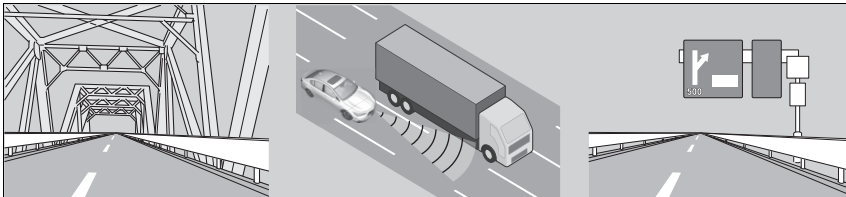

Continued

■ Detection limitations

- The vehicle ahead suddenly accelerates.
- The vehicle ahead is a panel truck or a vehicle whose shape is not of standard dimensions.

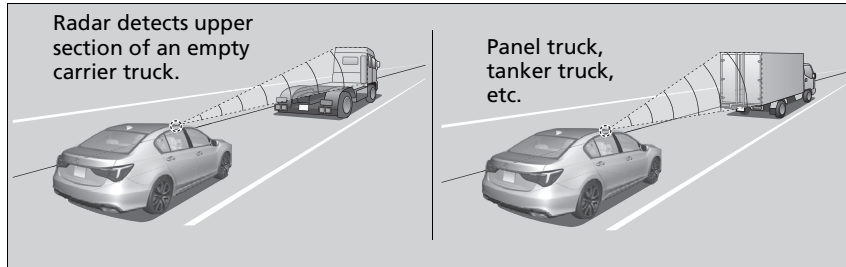

- The vehicle ahead of you is a motorcycle, bicycle, mobility scooter, or other small vehicle.
- The ground clearance of the vehicle ahead is unusually high.

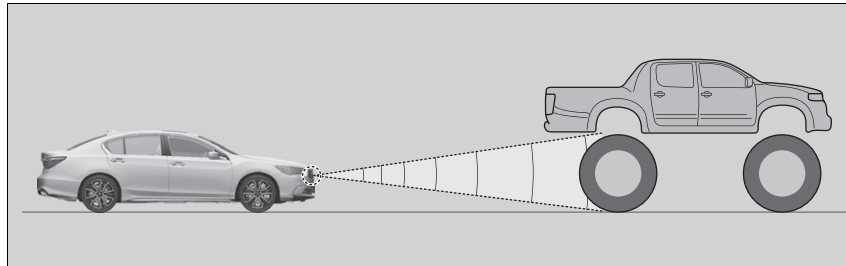

- A vehicle suddenly cuts in front of yours.

Vehicle Stability Assist™ (VSA®), aka Electronic Stability Control (ESC), System

VSA® helps to stabilize the vehicle during cornering if the vehicle turns more or less than what was intended. It also assists in maintaining traction on slippery surfaces. It does so by regulating engine and motor output and selectively applying the brakes.

■ VSA® Operation

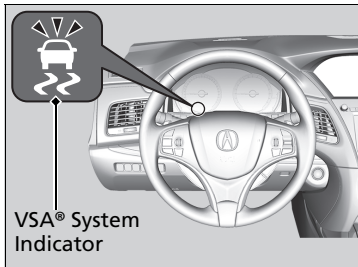

When VSA® activates, you may notice that the engine and motor do not respond to the accelerator. You may also notice some noise from the hydraulic system. You will also see the indicator blink.

⊠ Vehicle Stability Assist™ (VSA®), aka Electronic Stability Control (ESC), System

The VSA® may not function properly if tire type and size are mixed. Make sure to use the same size and type of tire, and the air pressures as specified.

When the VSA® system indicator comes on and stays on while driving, there may be a problem with the system. While this may not interfere with normal driving, have your vehicle checked by a dealer immediately.

VSA® cannot enhance stability in all driving situations and does not control the entire braking system. You still need to drive and corner at speeds appropriate for the conditions and always leave a sufficient margin of safety.

The main function of the VSA® system is generally known as Electronic Stability Control (ESC). The system also includes a traction control function.

■ VSA® On and Off

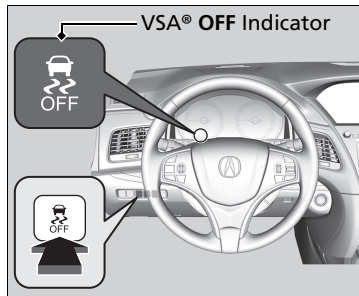

This button is on the driver side control panel. To partially disable VSA® functionality/features, press and hold it until you hear a beep.

Your vehicle will have normal braking and cornering ability, but traction control function will be less effective.

To restore VSA® functionality/features, press the  (VSA® OFF) button until you hear a beep.

VSA® is turned on every time you turn the power system on, even if you press the button the last time you drove the vehicle.

▶▶ Vehicle Stability Assist™ (VSA®), aka Electronic Stability Control (ESC), System

In certain unusual conditions when your vehicle gets stuck in shallow mud or fresh snow, it may be easier to free it with the VSA® temporarily switched off.

When the  button is pressed, the traction control function becomes less effective. This allows for the wheels to spin more freely at low speed. You should only attempt to free your vehicle with the VSA® off if you are not able to free it when the VSA® is on.

Immediately after freeing your vehicle, be sure to switch VSA® on again. We do not recommend driving your vehicle with the VSA® system switched off.

You may hear a motor sound coming from the engine compartment while system checks are being performed immediately after turning the power system on or while driving. This is normal.

Agile Handling Assist

Lightly brakes each of the front and rear wheels, as needed, when you turn the steering wheel, and helps support the vehicle's stability and performance during cornering.

ⓘ Agile Handling Assist

The agile handling assist cannot enhance stability in all driving situations. You still need to drive and corner at speeds appropriate for the conditions and always leave a sufficient margin of safety.

When the VSA® system indicator comes on and stays on while driving, the agile handling assist does not activate.

You may hear a sound coming from the engine compartment while the agile handling assist is activated. This is normal.

SPORT HYBRID Super Handling-All Wheel Drive™ (SPORT HYBRID SH-AWD®)

The system controls and transfers varying amounts of motor and/or engine torque to each wheel in accordance with the driving conditions.

SPORT HYBRID SH-AWD® helps to enhance driving stability, and lets you handle situations like slippery surfaces, such as snow, sand, mud, and steep hills, better than when driving with standard two wheel drive. However, the system does not help to enhance braking. Be cautious about the following:

- It is still your responsibility to drive safely when you steer, accelerate, and apply brakes.
- Leave a sufficient margin when braking on slippery surfaces.

⚠ SPORT HYBRID Super Handling-All Wheel Drive™ (SPORT HYBRID SH-AWD®)

Do not drive through deep water.

The SPORT HYBRID SH-AWD® system may not function properly if tire type and size are mixed. Make sure to use the same size and type of tire, and the air pressures as specified.

➡ **Tire and Wheel Replacement** P. 526

Blind spot information System

Is designed to detect vehicles in specified alert zones adjacent to your vehicle, particularly in harder to see areas commonly known as “blind spots.” When the system detects vehicles approaching from behind in adjacent lanes, the appropriate indicator comes on for a few seconds, providing assistance when you change lanes.

■ How the system works

- The transmission is in **D**.
- Your vehicle speed is between 20 mph (32 km/h) and 100 mph (160 km/h).

Alert zone range

- A: Approx. 1.6 ft. (0.5 m)
- B: Approx. 10 ft. (3 m)
- C: Approx. 10 ft. (3 m)

Radar Sensors: underneath the rear bumper corners

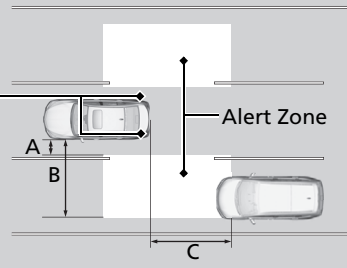

Blind spot information System

⚠ WARNING

Failure to visually confirm that it is safe to change lanes before doing so may result in a crash and serious injury or death. Do not rely only on the blind spot information system when changing lanes.

Always look in your mirrors, to either side of your vehicle, and behind you for other vehicles before changing lanes.

Important Safety Reminder

Like all assistance systems, blind spot information system has limitations. Over reliance on the blind spot information system may result in a collision.

The system is for your convenience only. Even if an object is within the alert zone, the following situations may occur.

- The blind spot information system alert indicator may not come on due to obstruction (splashes, etc.) even without the **Blind Spot Info Not Available** multi-information display appearing.
- The blind spot information system alert indicator may come on even with the message appearing.

The blind spot information system alert indicator may not come on under the following conditions:

- A vehicle does not stay in the alert zone for more than two seconds.
- A vehicle is parked in a side lane.
- The speed difference between your vehicle and the vehicle you are passing is greater than 6 mph (10 km/h).

Continued

■ When the system detects a vehicle

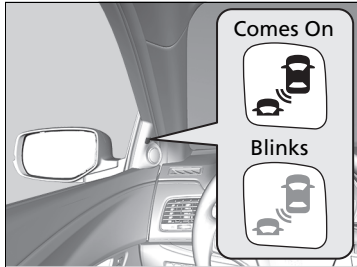

Blind spot information System Alert Indicator:
Located near the outside rearview mirror on
both sides.

Comes on when:

- A vehicle enters the alert zone from behind to overtake you with a speed difference of no more than 31 mph (50 km/h) from your vehicle.
- You pass a vehicle with a speed difference of no more than 12 mph (20 km/h).

Blinks and a beeper sounds when:

You move the turn signal lever in the direction of the detected vehicle. The beeper sounds three times.

▣ Blind spot information System

- An object not detected by the radar sensors approaches or passes your vehicle.
- A vehicle running in the adjacent lane is a motorcycle or other small vehicle.

The system does not operate when in **[R]**.

You can turn off the audible alert, or all the blind spot information system alert using the audio/information screen.

▣ Customized Features P. 295

Blind spot information system may be adversely affected when:

- Objects (guard rails, poles, trees, etc.) are detected.
- An object that does not reflect radio waves well, such as a motorcycle, is in the alert zone.
- Driving on a curved road.
- A vehicle is moving from a far lane to the adjacent lane.
- The system picks up external electrical interference.
- The rear bumper or the sensors have been improperly repaired or the rear bumper has been deformed.
- The orientation of the sensors has been changed.
- In bad weather (Heavy rain, snow, and fog).

For proper blind spot information system operation:

- Always keep the rear bumper corner area clean.
- Do not cover the rear bumper corner area with labels or stickers of any kind.
- Take your vehicle to a dealer if you need the rear bumper corner area or the radar sensors to be repaired, or the rear bumper corner area is strongly impacted.

Tire Pressure Monitoring System (TPMS)

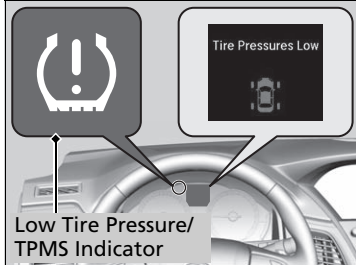

Monitors the tire pressure while you are driving. If your vehicle's tire pressure becomes significantly low, the low tire pressure/TPMS indicator comes on and a message appears on the multi-information display.

☒ Tire Pressure Monitoring System (TPMS)

Conditions such as low ambient temperature and altitude change directly affect tire pressure and can trigger the low tire pressure/TPMS indicator to come on.

☒ **If the Low Tire Pressure/TPMS Indicator Comes On or Blinks** P. 570

Tire pressure checked and inflated in:

- Warm weather can become under-inflated in colder weather.
- Cold weather can become over-inflated in warmer weather.

The low tire pressure/TPMS indicator will not come on as a result of over inflation.

■ Tire Pressure Monitor

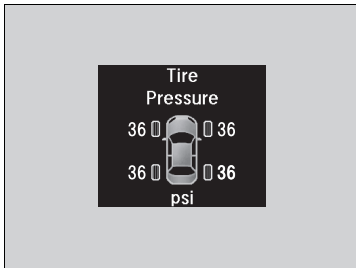

To select the tire pressure monitor, set the power mode to ON, and roll the right selector wheel until you see the tire pressure screen.

The pressure for each tire is displayed in psi (U.S.) or kPa (Canada).

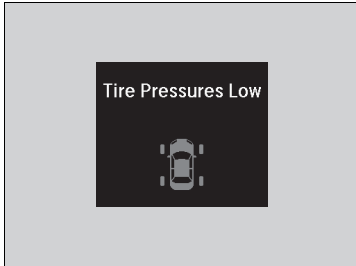

Tire Pressures Low is displayed when a tire has significantly low pressure. The specific tire is displayed on the screen.

▶ Tire Pressure Monitor

The pressure displayed on the multi-information display can be slightly different from the actual pressure as measured by a gauge. If there is a significant difference between the two values, or if the low tire pressure/TPMS indicator and the message on the multi-information display do not go off after you have inflated the tire to the specified pressure, have the system checked by a dealer.

Tire Pressure Monitor Problem may appear if you drive with the compact spare tire*, or there is a problem with the TPMS.

Tire Pressure Monitoring System (TPMS) - Required Federal Explanation

Each tire, including the spare (if provided), should be checked monthly when cold and inflated to the inflation pressure recommended by the vehicle manufacturer on the vehicle placard or tire inflation pressure label.

(If your vehicle has tires of a different size than the size indicated on the vehicle placard or tire inflation pressure label, you should determine the proper tire inflation pressure for those tires.)

As an added safety feature, your vehicle has been equipped with a tire pressure monitoring system (TPMS) that illuminates a low tire pressure telltale



when one or more of your tires is significantly under-inflated.

Accordingly, when the low tire pressure telltale illuminates, you should stop and check your tires as soon as possible, and inflate them to the proper pressure.

Driving on a significantly under-inflated tire causes the tire to overheat and can lead to tire failure. Under-inflation also reduces fuel efficiency and tire tread life, and may affect the vehicle's handling and stopping ability.

Please note that the TPMS is not a substitute for proper tire maintenance, and it is the driver's responsibility to maintain correct tire pressure, even if under-inflation has not reached the level to trigger illumination of the TPMS low tire pressure telltale.

Your vehicle has also been equipped with a TPMS malfunction indicator to indicate when the system is not operating properly. The TPMS malfunction indicator is combined with the low tire pressure telltale. When the system detects a malfunction, the telltale will flash for approximately one minute and then remain continuously illuminated. This sequence will continue upon subsequent vehicle start-ups as long as the malfunction exists.

When the malfunction indicator is illuminated, the system may not be able to detect or signal low tire pressure as intended.

TPMS malfunctions may occur for a variety of reasons, including the installation of replacement or alternate tires or wheels on the vehicle that prevent the TPMS from functioning properly.

Always check the TPMS malfunction telltale after replacing one or more tires or wheels on your vehicle to ensure that the replacement or alternate tires and wheels allow the TPMS to continue to function properly.

High Voltage Battery

The High Voltage battery gradually discharges when the vehicle is not in use. As a result, if your vehicle is parked for an extended period of time, the battery level may get low. Keeping your vehicle's battery level low can shorten the battery life. To maintain the battery, drive your vehicle for more than 30 minutes to recharge the battery at least once every three months.

To help maintain the battery life, when parking under the direct sunlight during summer, try find a shaded area.

Brake System

■ Parking Brake

Use the parking brake to keep the vehicle stationary when parked. When the parking brake is applied, you can manually or automatically release it.

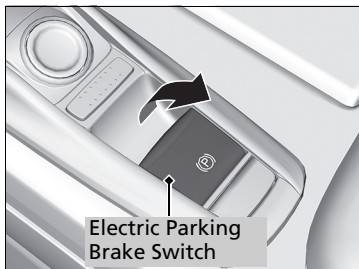

■ To apply

The electric parking brake can be applied any time the vehicle has battery, no matter which power mode the vehicle is in.

Pull the electric parking brake switch up gently and securely.

- ▶ The electric parking brake indicator comes on.

» Brake System

When you depress the brake pedal, you may hear a whirling sound from the engine compartment. This is because the brake system is in operation, and it is normal.

» Parking Brake

You may hear the electric parking brake system motor operating from the rear wheel area when you apply or release the parking brake. This is normal.

The brake pedal may slightly move due to the electric parking brake system operation when you apply or release the parking brake. This is normal.

You cannot apply or release the parking brake if the battery goes dead.

▶ **Jump Starting** P. 562

If you pull up and hold the electric parking brake switch while driving, the brakes on all four wheels are applied by the VSA® system until the vehicle come to a stop. The electric parking brake then applies, and the switch should be released.

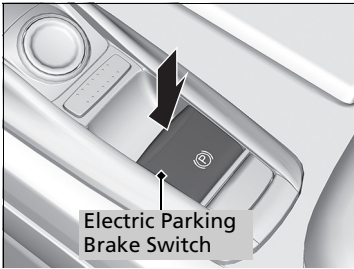

■ To release

The power mode must be in the ON position to release the electric parking brake.

1. Depress the brake pedal.
2. Press the electric parking brake switch.
 - ▶ The electric parking brake indicator goes off.

Manually releasing the parking brake using the switch helps your vehicle start slowly and smoothly when facing downhill on steep hills.

▣ Parking Brake

In the following situations, the parking brake automatically operates.

- When the vehicle stops more than 10 minutes while ACC with Low Speed Follow is activated.
- When the driver's seat belt is unfastened while your vehicle is stopped automatically by ACC with Low Speed Follow.
- When the power system is turned off while ACC with Low Speed Follow is activated.
- When the vehicle stops with the automatic brake hold system activated for more than 10 minutes.
- When the driver's seat belt is unfastened while your vehicle is stopped and brake hold is applied.
- When the power system is turned off while brake hold is applied.
- When there is a problem with the Brake Hold System.

■ To release automatically

Depressing the accelerator pedal releases the parking brake. Use the accelerator pedal to release the brake when you are starting the vehicle facing uphill, or in a traffic jam.

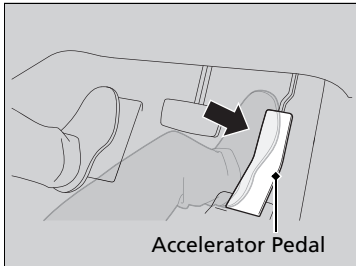

Gently depress the accelerator pedal. When on a hill, it may require more accelerator input to release.

- The electric parking brake indicator goes off.

The parking brake automatically releases as you depress the accelerator pedal when:

- You are wearing the driver's seat belt.
- The power system is on.
- The transmission is not in **P** or **N**.

⊠ Parking Brake

If the parking brake cannot be released automatically, release it manually.

When the vehicle is traveling uphill, the accelerator pedal may need to be pressed farther to automatically release the electric parking brake.

The parking brake cannot be released automatically while the following indicators are on:

- Malfunction indicator lamp
- Transmission system indicator

The parking brake may not be released automatically while the following indicators are on:

- Electric parking brake system indicator
- VSA® system indicator
- **ABS** indicator
- Supplemental restraint system indicator

Foot Brake

Your vehicle is equipped with disc brakes at all four wheels. The brake assist system increases the stopping force when you depress the brake pedal hard in an emergency situation. The anti-lock brake system (ABS) helps you retain steering control when braking very hard.

➤ **Brake Assist System** P. 457

➤ **Anti-lock Brake System (ABS)** P. 456

Foot Brake

Check the brakes after driving through deep water, or if there is a buildup of road surface water. If necessary, dry the brakes by lightly depressing the pedal several times.

If you hear a continuous metallic friction sound when applying the brakes, this is caused by the brake wear indicator rubbing on the brake rotor and indicates that the brake pads need to be replaced. Have the vehicle checked by a dealer. If you hear only an occasional squeak or squeal when you initially apply the brake pedal, this may be normal and caused by high frequency vibration of the brake pads against the rotating brake disc.

Constantly using the brake pedal while going down a long hill builds up heat, which reduces the brake effectiveness. Apply regenerative braking by taking your foot off the accelerator pedal and downshifting to a lower gear.

Do not rest your foot on the brake pedal while driving, as it will lightly apply the brakes and cause them to lose effectiveness over time and reduce pad life. It will also confuse drivers behind you.

Continued

■ Automatic Brake Hold

Keeps the brake applied after releasing the brake pedal until the accelerator pedal is pressed. You can use this system only while the vehicle is temporarily stopped, like at traffic lights and in heavy traffic.

⚠ Automatic Brake Hold

⚠ WARNING

Activating the automatic brake hold system on steep hills or slippery roads may still allow the vehicle to move if you remove your foot from the brake pedal.

If a vehicle unexpectedly moves, it may cause a crash resulting in serious injury or death.

Never activate the automatic brake hold system or rely on it to keep a vehicle from moving when stopped on a steep hill or slippery roads.

⚠ WARNING

Using the automatic brake hold system to park the vehicle may result in the vehicle unexpectedly moving.

If a vehicle moves unexpectedly, it may cause a crash, resulting in serious injury or death.

Never leave the vehicle when braking is temporarily kept by automatic brake hold and always park the vehicle by putting the transmission in **P** and applying the parking brake.

■ Turning on the system



Automatic Brake Hold Button

Fasten your seat belt properly, then start the power system. Press the automatic brake hold button.

- The automatic brake hold system indicator comes on. The system is turned on.

■ Activating the system

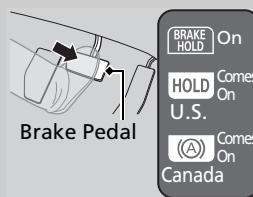

Brake Pedal

Depress the brake pedal to come to a complete stop. The transmission must be in **D** or **N**.

- The automatic brake hold indicator comes on. Braking is kept for up to 10 minutes.
- Release the brake pedal after the automatic brake hold indicator comes on.

■ Canceling the system



Accelerator Pedal

Depress the accelerator pedal while the transmission is in **D**. The system is canceled and the vehicle starts to move.

- The automatic brake hold indicator goes off. The system continues to be on.

■ **The system automatically cancels when:**

- You depress the brake pedal and change to **P** or **R**.
- You engage the parking brake.

■ **The system automatically cancels and the parking brake is applied when:**

- Braking is kept for more than 10 minutes.
- The driver's seat belt is unfastened.
- The power system is turned off.
- **Brake Hold System Problem** appears on the multi-information display.

■ **Turning off the automatic brake hold system**

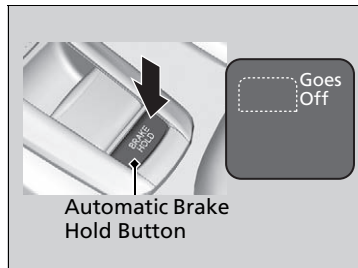

While the system is on, press the automatic brake hold button again.

- ▶ The automatic brake hold system indicator goes off.

If you want to turn off automatic brake hold while the system is in operation, press the automatic brake hold button with the brake pedal depressed.

⊞ Automatic Brake Hold

While the system is activated, you can turn off the power system or park the vehicle through the same procedure as you normally do.

⊞ **When Stopped** P. 466

Whether the system is on, or the system is activated, the automatic brake hold turns off once the power system is off.

⊞ Turning off the automatic brake hold system

Make sure to turn off the automatic brake hold system before using an automated car wash.

You may hear an operating noise if the vehicle moves while the automatic brake hold system is in operation.

Anti-lock Brake System (ABS)

■ ABS

Helps prevent the wheels from locking up, and helps you retain steering control by pumping the brakes rapidly, much faster than you.

The electronic brake distribution (EBD) system, which is part of the ABS, also balances the front-to-rear braking distribution according to vehicle loading.

You should never pump the brake pedal. Let the ABS work for you by always keeping firm, steady pressure on the brake pedal. This is sometimes referred to as “stomp and steer.”

■ ABS operation

The brake pedal may pulsate slightly when the ABS is working. Depress the brake pedal and keep holding the pedal firmly down. On dry pavement, you will need to press on the brake pedal very hard before the ABS activates. However, you may feel the ABS activate immediately if you are trying to stop on snow or ice.

ABS may activate when you depress the brake pedal when driving on:

- Wet or snow covered roads.
- Roads paved with stone.
- Roads with uneven surfaces, such as potholes, cracks, manholes, etc.

When the vehicle speed goes under 6 mph (10 km/h), the ABS stops.

►► Anti-lock Brake System (ABS)

NOTICE

The ABS may not function correctly if you use a tire of the wrong size or type.

If the **ABS** indicator comes on while driving, there may be a problem with the system. While normal braking will not be affected, there is a possibility that the ABS will not operating. Have your vehicle checked by a dealer immediately.

The ABS is not designed for the purpose of reducing the time or distance it takes for a vehicle to stop: It is designed to limit brake lockup which can lead to skidding and loss of steering control.

In the following cases, your vehicle may need more distance to stop than a vehicle without the ABS:

- You are driving on rough or uneven road surfaces, such as gravel or snow.
- The tires are equipped with snow chains.

The following may be observed with the ABS system:

- Motor sounds coming from the engine compartment when the brakes are applied, or when system checks are being performed after the engine has been started and while the vehicle accelerates.
- Brake pedal and/or the vehicle body vibration when ABS activates.

These vibrations and sounds are normal to ABS systems and are no cause for concern.

Brake Assist System

Designed to assist the driver by generating greater braking force when you depress the brake pedal hard during emergency braking.

■ Brake assist system operation

Press the brake pedal firmly for more powerful braking.

When brake assist operates, the pedal may wiggle slightly and an operating noise may be heard. This is normal. Keep holding the brake pedal firmly down.

Collision Mitigation Braking System™ (CMBS™)

Can assist you when there is a possibility of your vehicle colliding with a vehicle or a pedestrian detected in front of yours. The CMBS™ is designed to alert you when a potential collision is determined, as well as to reduce your vehicle speed to help minimize collision severity when a collision is deemed unavoidable.

■ How the system works

When to use

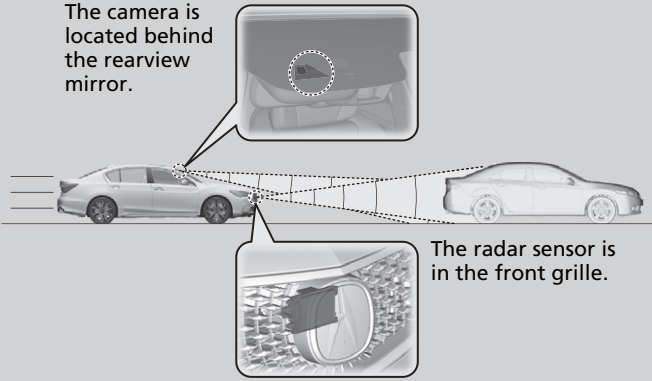

The camera is located behind the rearview mirror.

The radar sensor is in the front grille.

The system starts monitoring the roadway ahead when your vehicle speed is about 3 mph (5 km/h) and there is a vehicle in front of you.

The CMBS™ activates when:

- The speed difference between your vehicle and a vehicle or pedestrian detected in front of you becomes about 3 mph (5 km/h) and over with a chance of a collision.
- Your vehicle speed is about 62 mph (100 km/h) or less and there is a chance of a collision with an oncoming detected vehicle or a pedestrian in front of you.

▣ Collision Mitigation Braking System™ (CMBS™)

Important Safety Reminder

The CMBS™ is designed to reduce the severity of an unavoidable collision. It does not prevent a collision nor stop the vehicle automatically. It is still your responsibility to operate the brake pedal and steering wheel appropriately according to the driving conditions.

The CMBS™ may not activate or may not detect a vehicle in front of your vehicle under certain conditions:

▣ **CMBS™ Conditions and Limitations** P. 462

You can read about handling information for the camera equipped with this system.

▣ **Front Sensor Camera** P. 400

Be careful not to have the radar sensor cover strongly impacted.

▣ How the system works

Rapid vibrations on the steering wheel alert you when your vehicle speed is between 19 and 62 mph (30 and 100 km/h) with an oncoming vehicle detected in front of you.

When the CMBS™ activates, it may automatically apply the brake. It will be canceled when your vehicle stops or a potential collision is not determined.

■ When the system activates

The system provides visual, audible and tactile alerts of a possible collision, and stops if the collision is avoided.

- ▶ Take appropriate action to prevent a collision (apply the brakes, change lanes, etc.)

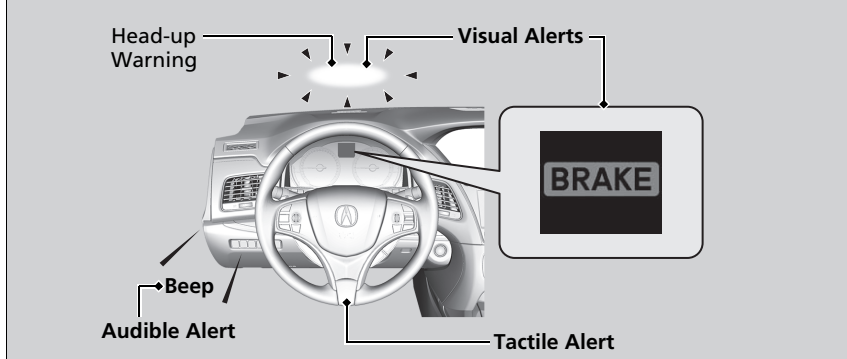

At system's earliest collision alert stage, you can change the distance (**Long/Normal/Short**) between vehicles at which alerts will come on through audio/information screen setting options.

- ▶ **Customized Features** P. 295

■ Vibration alert on the steering wheel

When a potential collision to an oncoming detected vehicle is determined, the system alerts you with rapid vibration on the steering wheel, in addition to visual and audible alerts.

- ▶ Take appropriate action to prevent a collision (apply the brakes, operate the steering wheel, etc.).

▶▶ When the system activates

The camera in the CMBS™ is also designed to detect pedestrians.

However, this pedestrian detection feature may not activate or may not detect a pedestrian in front of your vehicle under certain conditions. Refer to the ones indicating the pedestrian detection limitations from the list.

- ▶ **CMBS™ Conditions and Limitations** P. 462

The head-up warning uses a lens located at the front end of the dashboard.

Do not cover the lens or spill any liquid on it.

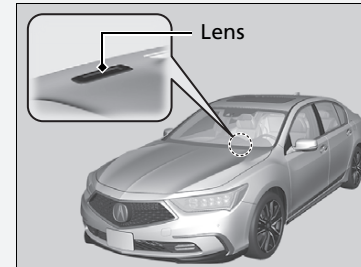

▶▶ Vibration alert on the steering wheel

Vibration alert function is disabled when the electric power steering (EPS) system indicator comes on.

- ▶ **Electric Power Steering (EPS) System Indicator** P. 84

■ Collision Alert Stages

The system has three alert stages for a possible collision. However, depending on circumstances, the CMBS™ may not go through all of the stages before initiating the last stage.

Distance between vehicles		CMBS™				
		The radar sensor detects a vehicle	E-pretensioner/ Reactive Force Pedal	Audible & Visual WARNINGS	Steering Wheel	Braking
Stage one		There is a risk of a collision with the vehicle ahead of you.	<p>Increases the accelerator pedal resistance force.</p> <p>Accelerator Pedal</p>	When in Long , visual and audible alerts come on at a longer distance from a vehicle ahead than in Normal setting, and in Short , at a shorter distance than in Normal .	In case of an oncoming vehicle detected, rapid vibration is provided.	—
Stage two		The risk of a collision has increased, time to respond is reduced.	<p>Retracts the driver's seat belt gently a few times, providing a physical warning.</p>	Visual and audible alerts.	—	Lightly applied
Stage three		The CMBS™ determines that a collision is unavoidable.	<p>Forcefully tightens driver and front passenger seat belts.</p>	Visual and audible alerts.	—	Forcefully applied

CMBS™ On and Off

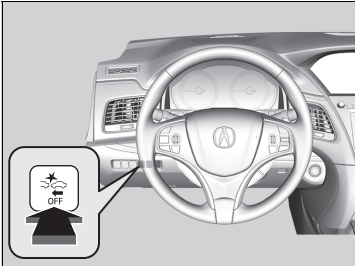

Press and hold the button until the beeper sounds to switch the system on or off.

When the CMBS™ is off:

- The CMBS™ indicator in the instrument panel comes on.
- A message on the multi-information display reminds you that the system is off.

The CMBS™ is turned on every time you turn the power system on, even if you turned it off the last time you drove the vehicle.

Collision Mitigation Braking System™ (CMBS™)

The CMBS™ may automatically shut off, and the CMBS™ indicator will come and stay on under certain conditions:

► **CMBS™ Conditions and Limitations** P. 462

■ CMBS™ Conditions and Limitations

The system may automatically shut off and the CMBS™ indicator will come on under certain conditions. Some examples of these conditions are listed below. Other conditions may reduce some of the CMBS™ functions.

➤ **Front Sensor Camera** P. 400

■ Environmental conditions

- Driving in bad weather (rain, fog, snow, etc.).
- Sudden changes between light and dark, such as an entrance or exit of a tunnel.
- There is little contrast between objects and the background.
- Driving into low sunlight (e.g., at dawn or dusk).
- Strong light is reflected onto the roadway.
- Driving in the shadows of trees, buildings, etc.
- Roadway objects or structures are misinterpreted as vehicles and pedestrians.
- Reflections on the interior of the windshield.
- Driving at night or in a dark condition such as a tunnel.

■ Roadway conditions

- Driving on a snowy or wet roadway (obscured lane marking, vehicle tracks, reflected lights, road spray, high contrast).
- Driving on curvy, winding, or undulating roads.
- The road is hilly or the vehicle is approaching the crest of a hill.

⌘ CMBS™ Conditions and Limitations

Do not paint, or apply any coverings or paint to the radar sensor area. This can impact CMBS™ operation.

Have your vehicle checked by a dealer if you find any unusual behavior of the system (e.g., the warning message appears too frequently).

If the front of the vehicle is impacted in any of the following situations, the radar sensor may not work properly. Have your vehicle checked by a dealer:

- The vehicle mounted onto a bump, curb, chock, embankment, etc.
- You drive the vehicle where the water is deep.
- Your vehicle has a frontal collision.

If you need the radar sensor to be repaired, or removed, or the radar sensor cover is strongly impacted, turn off the system by pressing the CMBS™ **OFF** button and take your vehicle to a dealer.

■ Vehicle conditions

- Headlight lenses are dirty or the headlights are not properly adjusted.
- The outside of the windshield is blocked by dirt, mud, leaves, wet snow, etc.
- The inside of the windshield is fogged.
- An abnormal tire or wheel condition (wrong sized, varied size or construction, improperly inflated, compact spare tire*, etc.).
- When tire chains are installed.
- The vehicle is tilted due to a heavy load or suspension modifications.
- The camera temperature gets too high.
- Driving with the parking brake applied.
- When the radar sensor in the front grille gets dirty.

■ Detection limitations

- A vehicle or pedestrian suddenly crosses in front of you.
- The distance between your vehicle and the vehicle or pedestrian ahead of you is too short.
- A vehicle cuts in front of you at a slow speed, and it brakes suddenly.
- When you accelerate rapidly and approach the vehicle or pedestrian ahead of you at high speed.
- The vehicle ahead of you is a motorcycle, bicycle, mobility scooter or other small vehicle.
- When there are animals in front of your vehicle.
- When you drive on a curved, winding or undulating road that makes it difficult for the sensor to properly detect a vehicle in front of you.
- The speed difference between your vehicle and a vehicle or pedestrian in front of you is significantly large.
- An oncoming vehicle suddenly comes in front of you.
- Another vehicle suddenly comes in front of you at an intersection, etc.
- Your vehicle abruptly crosses over in front of an oncoming vehicle.
- When driving through a narrow iron bridge.
- When the lead vehicle suddenly slows down.

* Not available on all models

Limitations applicable to pedestrian detection only

- When there is a group of people in front of your vehicle walking together side by side.
- Surrounding conditions or belongings of the pedestrian alter the pedestrian's shape, preventing the system from recognizing that the person is a pedestrian.
- When the pedestrian is shorter than about 3.3 feet (1 meter) or taller than about 6.6 feet (2 meters) in height.
- When a pedestrian blends in with the background.
- When a pedestrian is bent over or squatting, or when their hands are raised or they are running.
- When several pedestrians are walking ahead in a group.
- When the camera cannot correctly identify that a pedestrian is present due to an unusual shape (holding luggage, body position, size).

Automatic shutoff

The CMBS™ may automatically shut itself off and the CMBS™ indicator comes and stays on when:

- The temperature inside the system is high.
- You drive off-road or on a mountain road, or curved and winding road for an extended period.
- An abnormal tire condition is detected (wrong tire size, flat tire, etc.).
- The camera behind the rearview mirror, or the area around the camera, including the windshield, gets dirty.

Once the conditions that caused the CMBS™ to shut off improve or are addressed (e.g., cleaning), the system comes back on.

■ With Little Chance of a Collision

The CMBS™ may activate even when you are aware of a vehicle ahead of you, or when there is no vehicle ahead. Some examples of this are:

■ When Passing

Your vehicle approaches another vehicle ahead of you and you change lanes to pass.

■ At an intersection

Your vehicle approaches or passes another vehicle that is making a left or right turn.

■ On a curve

When driving through curves, your vehicle comes to a point where an oncoming vehicle is right in front of you.

■ Through a low bridge at high speed

You drive under a low or narrow bridge at high speed.

■ Speed bumps, road work sites, train tracks, roadside objects, etc.

You drive over speed bumps, steel road plates, etc., or your vehicle approaches train tracks or roadside objects [such as a traffic sign and guard rail] on a curve or, when parking, stationary vehicles and walls.

⌘ Collision Mitigation Braking System™ (CMBS™)

For the CMBS™ to work properly:

Always keep the radar sensor cover clean.

Never use chemical solvents or polishing powder for cleaning the sensor cover. Clean it with water or a mild detergent.

When Stopped

1. Depress the brake pedal firmly.
2. With the brake pedal depressed, pull up the electric parking brake switch slowly, but fully.
3. Change the gear position to **P**.
4. Turn off the power system.
 - ▶ The electric parking brake indicator goes off in about 15 seconds.

Always confirm the electric parking brake is set, in particular if you are parked on an incline.

▣ Parking Your Vehicle

WARNING

The vehicle can roll away if left unattended without confirming that Park is engaged.

A vehicle that rolls away could cause a crash resulting in serious injury or death.

Always keep your foot on the brake pedal until you have confirmed that **P** is shown on the gear position indicator.

Do not park your vehicle near flammable objects, such as dry grass, oil, or timber. Heat from the exhaust can cause a fire.

If during in Auto Engine Stop, the gear position changes to **P** and the engine restarts automatically under the following conditions:

- The power system is on.
- The gear position is not in **P**.
- You unfasten the driver side seat belt and open the door.

⌘ When Stopped

NOTICE

The following can damage the driveline:

- Depressing the accelerator and brake pedals simultaneously.
- Changing into **P** before the vehicle stops completely.

When facing uphill, do not hold the vehicle by depressing the accelerator pedal.

Doing so may cause the power system to overheat and fail.

In extremely cold temperatures, the parking brake may freeze up if applied. If such temperatures are expected, do not apply the parking brake but, if parking on a slope, either turn the front wheels so they will contact the curb if the vehicle rolls down the slope or block the wheels to keep the vehicle from moving. If you do not take either precaution, the vehicle may roll unexpectedly, leading to a crash.

Parking Sensor System *

The corner and center sensors monitor obstacles around your vehicle, and the beeper and audio/information screen let you know the approximate distance between your vehicle and the obstacle.

■ The sensor location and range

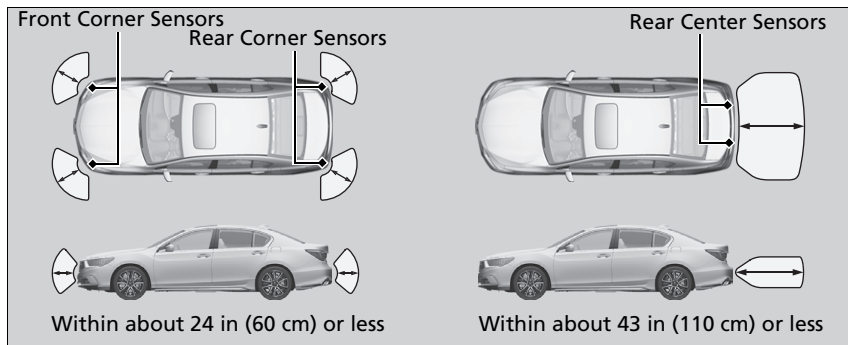

▣ Parking Sensor System *

Even when the system is on, always confirm if there is no obstacle near your vehicle before parking.

The system may not work properly when:

- The sensors are covered with snow, ice, mud or dirt.
- The vehicle is on uneven surface, such as grass, bumps, or a hill.
- The vehicle has been out in hot or cold weather.
- The system is affected by devices that emit ultrasonic waves.
- Driving in bad weather.

The system may not sense:

- Thin or low objects.
- Sonic-absorptive materials, such as snow, cotton, or sponge.
- Objects directly under the bumper.

Do not put any accessories on or around the sensors.

■ Parking sensor system on and off

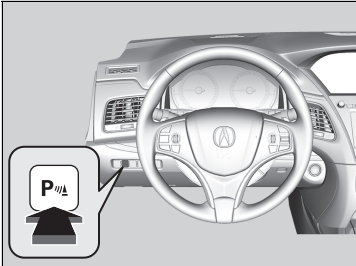

With the power mode in ON, press the parking sensor system button to turn the system on or off. The indicator in the button comes on when the system is on.

The front corner sensors and the rear center and corner sensors start to detect an obstacle when the transmission is in **R**.

The front corner sensors start to detect an obstacle when the transmission is not in **P**, and the vehicle speed is less than 6 mph (9 km/h).

■ When the distance between your vehicle and obstacles behind becomes shorter

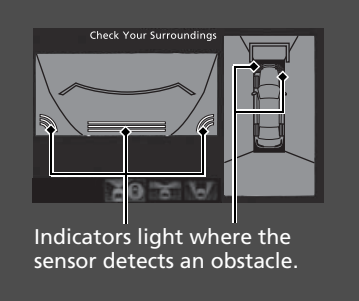
Length of the intermittent beep	Distance between the Bumper and Obstacle		Indicator	Audio/information screen
	Corner Sensors	Center Sensors		
Moderate	—	Rear: About 43-24 in (110-60 cm)	Blinks in Yellow*1	 <p>Indicators light where the sensor detects an obstacle.</p>
Short	About 24-18 in (60-45 cm)	About 24-18 in (60-45 cm)	Blinks in Amber	
Very short	About 18-14 in (45-35 cm)	About 18-14 in (45-35 cm)		
Continuous	About 14 in (35 cm) or less	About 14 in (35 cm) or less	Blinks in Red	

*1: At this stage, only the center sensors detect obstacles.

■ Turning off All Rear Sensors

1. Make sure that the parking sensor system is not activated. Set the power mode to VEHICLE OFF.
2. Press and hold the parking sensor system button, and set the power mode to ON.
3. Keep pressing the button for ten seconds. Release the button when the indicator in the button blinks.
 - ▶ The beeper sounds once.
4. Press the button again. The indicator in the button goes off.
 - ▶ The beeper sounds twice. The rear sensors are now turned off.

To turn the rear sensors on again, follow the above procedure. The beeper sounds three times when the rear sensors come back on.

☒ Turning off All Rear Sensors

When you select **[R]**, the indicator in the parking sensor system button blinks as a reminder that the rear sensors have been turned off.

Cross Traffic Monitor

Monitors the rear corner areas using the radar sensors when reversing, and alerts you if a vehicle approaching from a rear corner is detected.

The system is convenient when you are backing out of a parking space.

ⓘ Cross Traffic Monitor

CAUTION

Cross Traffic Monitor cannot detect all approaching vehicles and may not detect an approaching vehicle at all.

Failure to visually confirm that it is safe to back up the vehicle before doing so may result in a collision.

Do not solely rely on the system when reversing; always also use your mirrors, and look behind and to the sides of your vehicle before reversing.

Models with parking sensor system

The parking sensor system's alerting buzzer overrides the Cross Traffic Monitor buzzer when the sensors are detecting obstacles at the closest range.

How the System Works

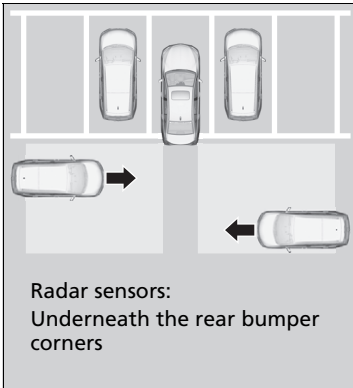

The system activates when:

- The power mode is in ON.
- The Cross Traffic Monitor is turned on.
 - **Cross Traffic Monitor On and Off** P. 475
 - **Customized Features** P. 295
- The transmission is in **R**.
- Your vehicle is moving at 3 mph (5 km/h) or lower.

When a vehicle is detected approaching from a rear corner, Cross Traffic Monitor alerts you with a buzzer and a displayed warning or accelerator pedal resistibility.

The system will not detect a vehicle that approaches from directly behind your vehicle, nor will it provide alerts about a detected vehicle when it moves directly behind your vehicle.

The system does not detect or provide alerts for a vehicle that is moving away from your vehicle, and it may alert for pedestrians, bicycles, or stationary objects.

⊗ Cross Traffic Monitor

Cross Traffic Monitor may not detect or may delay alerting an approaching vehicle, or may alert without an approaching vehicle under the following conditions:

- An obstacle, such as another vehicle and a wall, near your vehicle's rear bumper, is blocking the radar sensor's scope.
- Your vehicle is moving at the speed of about 3 mph (5 km/h) or higher.
- A vehicle is approaching at the speed other than between about 6 mph (10 km/h) and 16 mph (25 km/h).
- The system picks up external interference such as other radar sensors from another vehicle or strong radio wave transmitted from a facility nearby.
- Either corner of the rear bumper is covered with snow, ice, mud or dirt.
- When there is bad weather.
- Your vehicle is on an incline.
- Your vehicle is tilted due to a heavy load in the rear.
- Your vehicle is reversing towards a wall, a pole, a vehicle, and so on.
- The rear bumper or the sensors have been improperly repaired or the rear bumper has been deformed. Have your vehicle checked by a dealer.

For proper operation, always keep the rear bumper corner area clean.

Do not cover the rear bumper corner area with labels or stickers of any kind.

■ When the System Detects a Vehicle

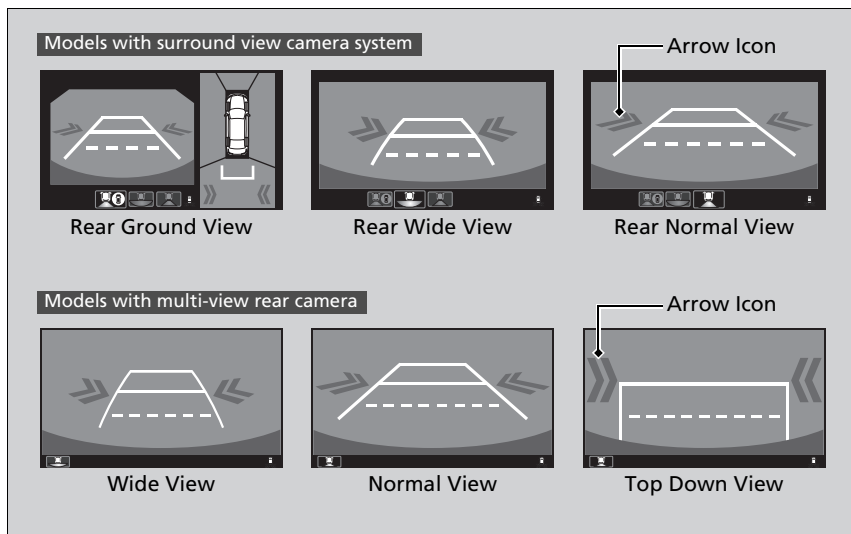

An arrow icon appears on the side a vehicle is approaching on the audio/information screen.

▶▶ When the System Detects a Vehicle

If the [P] on the lower right changes to [P] in amber when the transmission is in [R], mud snow or ice, etc. may have accumulated in the vicinity of the sensor. The system is temporarily canceled. Check the bumper corners for any obstructions, and thoroughly clean the area if necessary.

If the [P] comes on when the transmission is in [R], there may be a problem with the Cross Traffic Monitor system. Do not use the system and have your vehicle checked by a dealer.

If the display remains the same with the transmission in [R], there may be a problem with the rear camera system and the Cross Traffic Monitor system. Do not use the system and have your vehicle checked by a dealer.

■ Cross Traffic Monitor On and Off

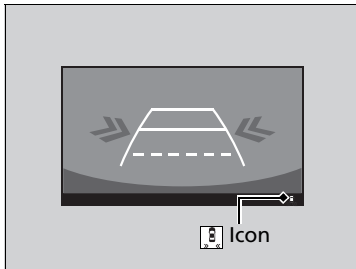

You can switch the system on and off using the audio/information screen.

▶ **Customized Features** P. 295

About Your Multi-View Rear Camera

The audio/information screen can display your vehicle's rear view. The display automatically changes to the rear view when the transmission is put into **R**.

Multi-View Rear Camera Display Area

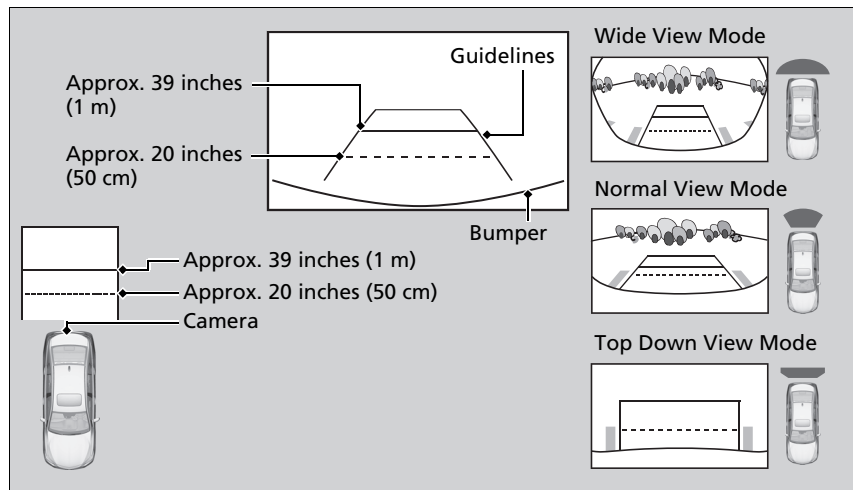

You can view three different camera modes on the rearview display. Press the interface dial to switch the angle.

About Your Multi-View Rear Camera

The rear camera view is restricted. You cannot see the corner ends of the bumper or what is underneath the bumper. Its unique lens also makes objects appear closer or farther than they actually are.

Visually confirm that it is safe to drive before backing up. Certain conditions (such as weather, lighting, and high temperatures) may also restrict the rear view. Do not rely on the rearview display which does not give you all information about conditions at the back of your vehicle.

If the camera lens is covered with dirt or moisture, use a soft, moist cloth to keep the lens clean and free of debris.

You can change the **Fixed Guideline** and **Dynamic Guideline** settings.

Customized Features P. 295

Fixed Guideline

On: Guidelines appear when you put the transmission into **R**.

Off: Guidelines do not appear.

Dynamic Guideline

On: Guidelines move according to the steering wheel direction.

Off: Guidelines do not move.

- If you were last using Wide view mode or Normal view mode, the same view mode will be activated the next time you put the transmission into **R**.
- If you were using Top down view mode before you turned the power mode to OFF, Wide view mode will be activated the next time you set the power mode to ON and put the transmission into **R**.
- If you were using Top down view mode and 10 seconds elapsed after you took the transmission out of **R**, Wide view mode will be activated the next time you put the transmission into **R**.

Is a four camera system that views areas commonly known as “blind spots” from different angles, then displays the images on the audio/information screen. This system can be used to:

- Check the right and left sides of the vehicle while crossing at intersections with poor visibility (fog, heavy rain, obstructed view, etc.).
 - **Checking from the front wide view at intersections** P. 486
- Check for obstacles in front of the vehicle when parking or maneuvering in confined areas.
 - **Checking the sides of your vehicle** P. 486
- Check for obstacles when you are moving in **R**.
 - **Checking for Obstacles at the Back of Your Vehicle** P. 482
- Assist you when backing into or parallel parking the vehicle in a lined parking space.
 - **Reversing into a Parking Space Marked with Parking Lines** P. 483
 - **Parallel Parking into a Parking Space Marked with Parking Lines** P. 484

Surround View Camera System*

WARNING

Failure to visually assess the area around the vehicle (directly or by use of the mirrors) may result in a crash causing serious injury or death.

The areas shown in the surround view camera system display are limited. The display may not show all pedestrians or other objects around your vehicle.

Do not solely rely only on the surround view camera system display to assess whether it is safe to move your vehicle.

WARNING

Failure to pay proper attention to your surroundings while driving may result in a crash causing serious injury or death.

To help mitigate the chances of a collision, only look at the surround view camera system display when it is safe to do so.

Displaying an Image From the Surround View Cameras

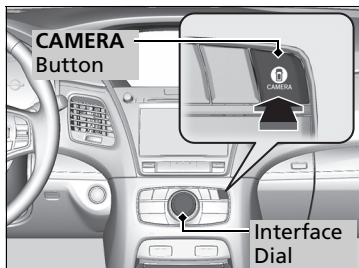

■ For frontal views:

Press the **CAMERA** button when the vehicle is stationary or moving at 12 mph (20 km/h) or slower. Press the button again or the interface dial to switch camera views.

■ For rear reviews:

Change the gear position to **R** when the vehicle is stationary. Press the **CAMERA** button or the interface dial to switch to rear view mode.

You can customize the display setting.

▶ **Customized Features** P. 295

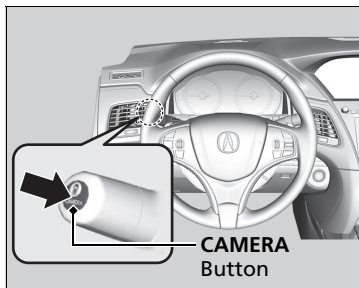

▶ Surround View Camera System*

The surround view camera system does not eliminate all blind spots. The system is for your convenience only.

Always keep the camera lenses clean and free from debris.

The navigation system is disabled when the gear position is in **R**.

* Not available on all models

■ Camera Locations and Images

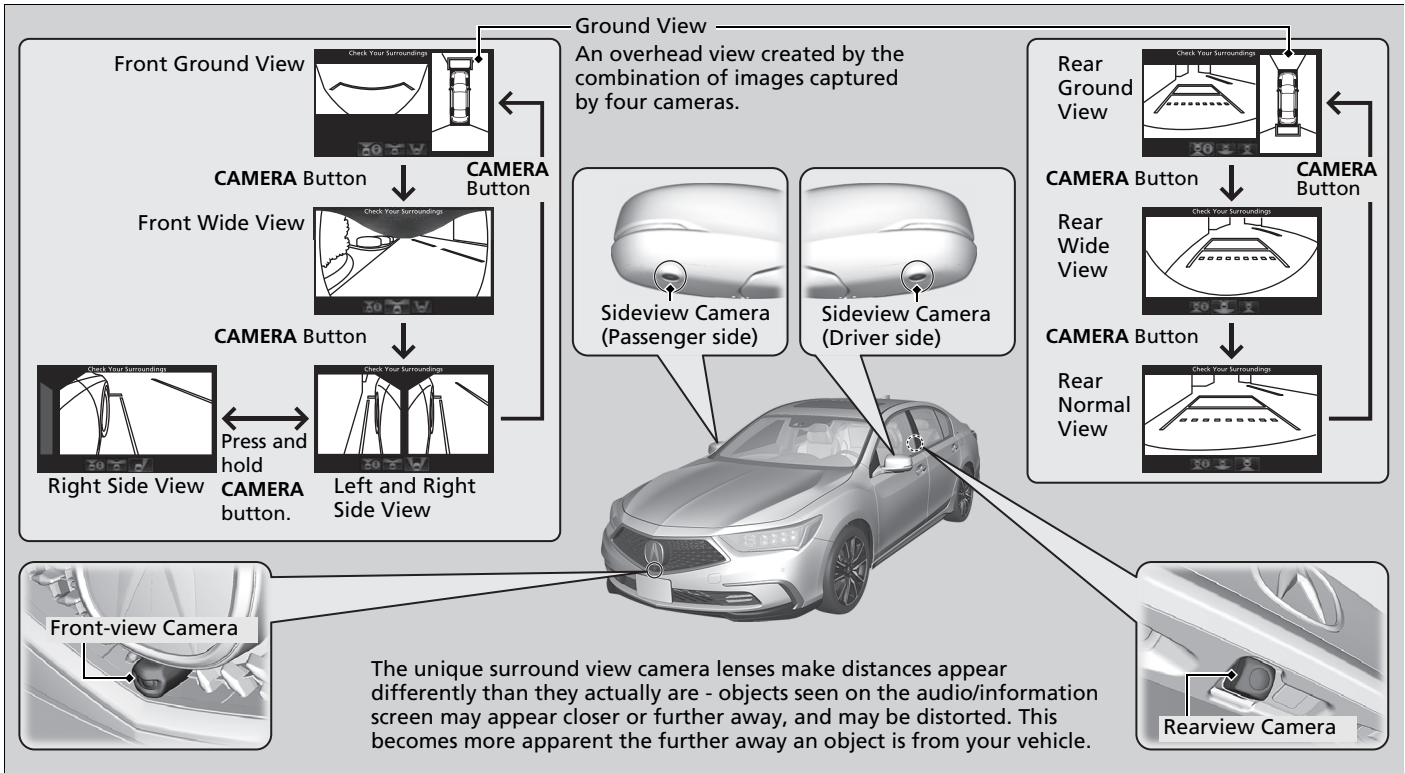

Reference Lines and Guides

Following can be displayed when the system is on.

Guide lines: Help you to get a sense of a distance between your vehicle and the rear surroundings. The distance may appear differently than the actual distance.

Projection lines: Indicate vehicle direction while the steering wheel is in the current position.

Depending on your parking situation, you can select **Back-in Left Park Guidance**, **Back-in Right Park Guidance**, **Left Parallel Park Guidance**, or **Right Parallel Park Guidance** from **Parking Guidance Menu** to display:

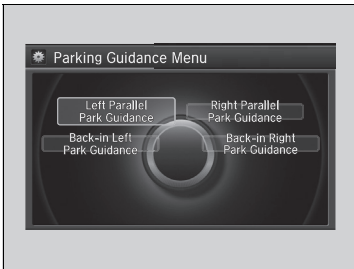

Initial position guide: Marks the point where your vehicle is headed when reversing.

Steering position alignment guide: Indicates when to change the steering wheel position.

▶▶ Displaying an Image From the Surround View Cameras

Operating the navigation system or audio system while the surround view camera system screen is displayed cancels the surround view camera system screen and starts up the navigation system screen.

If you press the **CAMERA** button while the vehicle speed is more than 15 mph (25 km/h), the standby screen appears.

When the vehicle speed is reduced below 12 mph (20 km/h), the screen switches to a surround view camera system image.

▶▶ Reference Lines and Guides

The positions/distances indicated by the guide lines and camera views on the display may differ from the actual positions/distances due to the changes in the vehicle height, road conditions, and other factors. The guide lines should be used as a reference only.

The guide lines can be turned on and off using the audio/information screen.

▶▶ **Customized Features** P. 295

If you turn the guide lines off, they remain off until you turn them back on.

To see the guidance on how to use the reference lines and guides while they appear on the display, press and hold the **CAMERA** button or the interface dial. To close the guidance, press and hold the **CAMERA** button or the interface dial again, or press the **BACK** button.

When Parking Your Vehicle

■ Checking for Obstacles at the Back of Your Vehicle

The display automatically changes to the rear view when the gear position is changed to **R**.

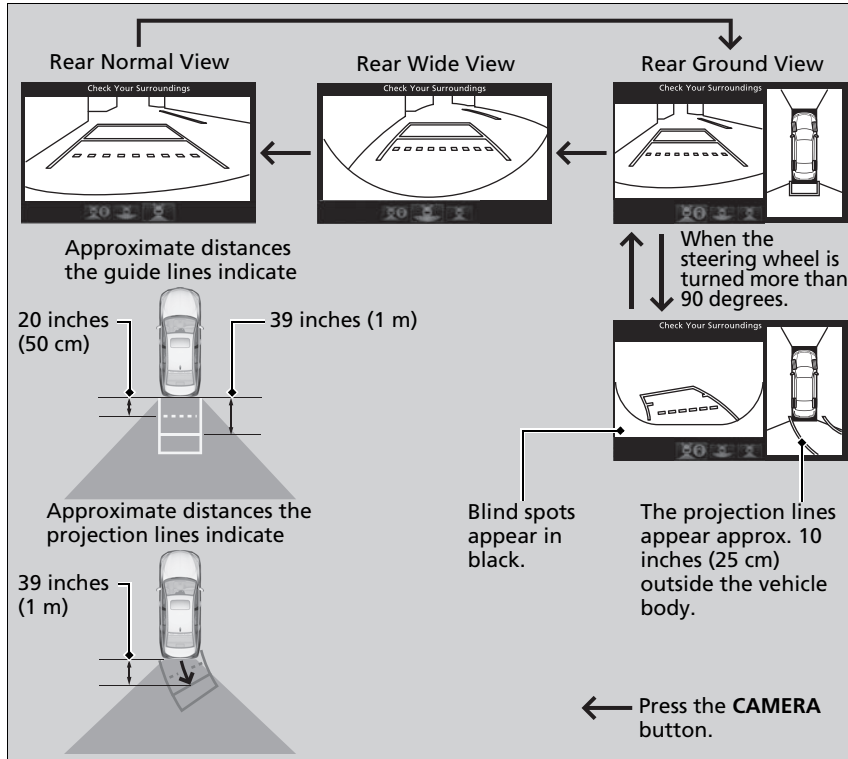

▶▶ When Parking Your Vehicle

The ground view can be displayed even with the door mirrors folded. However, the viewable angle and blind spot change. Do not refer to the surround view camera system when the door mirrors are folded.

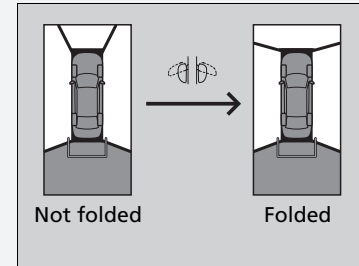

▶▶ Checking for Obstacles at the Back of Your Vehicle

When changing the gear position from/to **R**, you may experience a delay in switching between the audio/information screen and a rear view image.

Reversing into a Parking Space Marked with Parking Lines

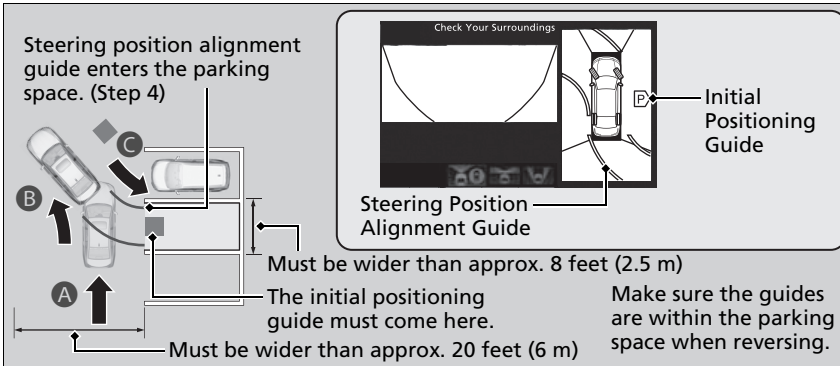

1. With your vehicle at a complete stop, press the **CAMERA** button, then press the **MENU** button. Rotate to select **Back- in left park guidance** or **Back-in right park guidance**. Press .
2. Move the vehicle forward perpendicular to the parking space and stop where the initial positioning guide in the display is at the center of the parking space.
3. Turn the steering wheel fully to the left (if the parking space is on the passenger side) at a stop.
 - ▶ The steering position alignment guide is displayed.
4. Slowly move the vehicle forward.
 - ▶ Stop the vehicle when the steering position alignment guide enters the parking space.
5. Turn the steering wheel fully to the right (if the parking space is on the passenger side) at a stop. Start reversing the vehicle slowly.
6. Stop the vehicle when it is parallel to the parking lines.
7. Return the steering wheel to its center position, then reverse the vehicle slowly until it is parked within the space.

Reversing into a Parking Space Marked with Parking Lines

If the steering position alignment guide does not fit in the parking lines, the parking space is too small for the vehicle.

Reference lines can be useful only when the parking space is in a rectangular shape with straight parking marks and when vehicles in the next parking spaces are within the spaces.



Continued

■ Parallel Parking into a Parking Space Marked with Parking Lines

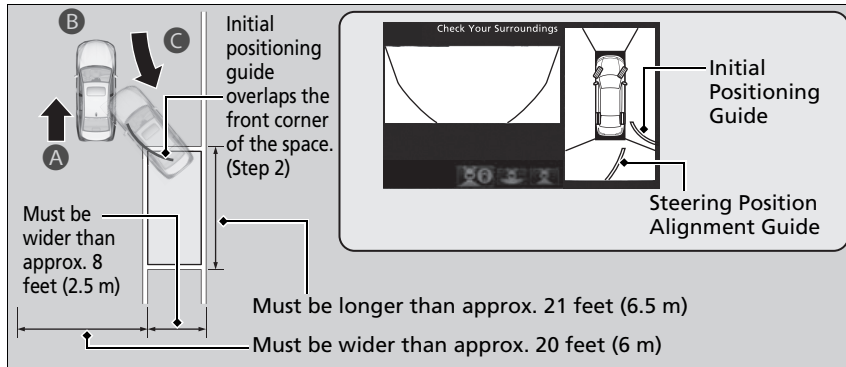

1. Press the **CAMERA** button, then press the **MENU** button. Rotate to select **Left parallel park guidance** or **Right Parallel park guidance**. Press .
2. Move the vehicle forward parallel to the parking space and stop when the initial positioning guide shown in the display overlaps the front corner of the space.
3. Turn the steering wheel fully to the right (if the parking space is on the passenger side) at a stop.
 - ▶ The steering position alignment guide is displayed.
4. Slowly reverse the vehicle.
 - ▶ Stop the vehicle when the steering position alignment guide overlaps the sideline of the parking space.
5. Turn the steering wheel fully to the left (if the parking space is on the passenger side) at a stop. Reverse the vehicle slowly.
6. Stop the vehicle when it is parallel to the parking lines.
7. Return the steering wheel to its center position, then reverse the vehicle slowly until it is parked within the space.

▣ Parallel Parking into a Parking Space Marked with Parking Lines

Reference lines can be useful only when the parking space is in a rectangular shape with straight parking marks and when vehicles in the next parking spaces are within the spaces.

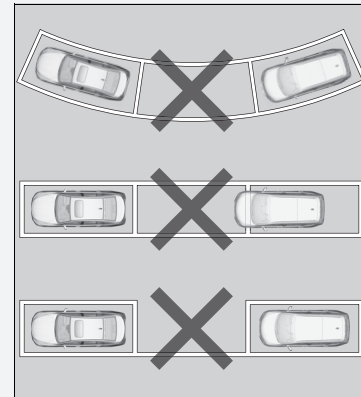

■ Checking for the Sides of Your Vehicle

You can display the front ground view screen using all the four cameras for the system. Pressing the **CAMERA** button when the vehicle speed is at below 12 mph (20 km/h) changes the image as follows.

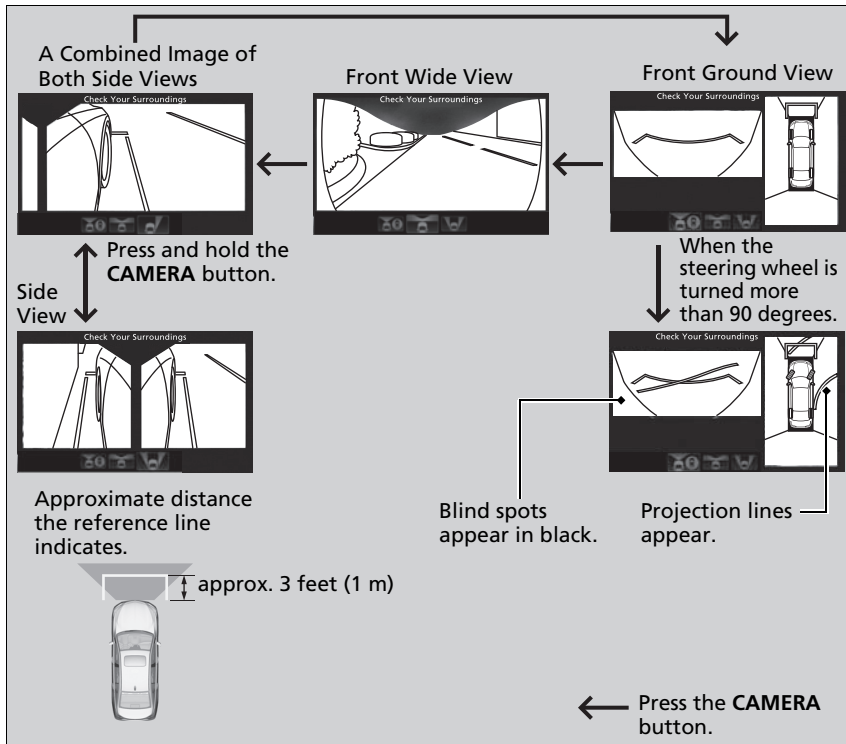

☒ Checking for the Sides of Your Vehicle

When the vehicle speed exceeds 15 mph (25 km/h), the front or side view on the screen automatically switches to the audio information screen. The front or side view screen resumes when the vehicle speed is reduced below 12 mph (20 km/h).

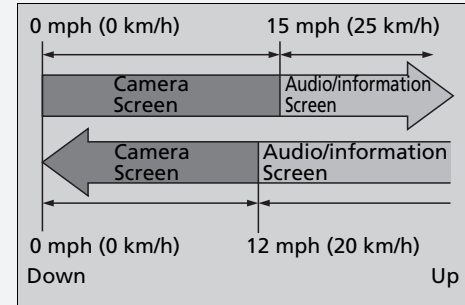

Continued

■ Checking from the front wide view at intersections

The front wide view screen is useful when you need to check for vehicles crossing from either direction at an intersection with poor visibility.

The angle provided by the front wide view screen is 180 degrees.



Front Wide View Screen

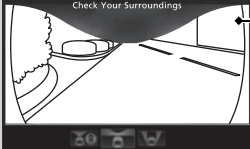

When the vehicle speed is below 12 mph (20 km/h), press the **CAMERA** button repeatedly until the front wide view comes on.

■ Checking the sides of your vehicle

The side view screens are convenient when you pull over at a curb or tollbooth, or slowly pass by oncoming vehicles on a narrow road.

Side Views

The images from the side cameras.

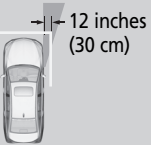

12 inches (30 cm)

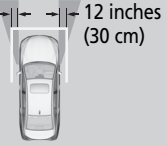

12 inches (30 cm)

Side View Screen

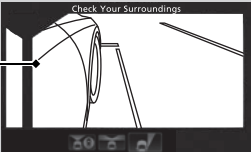

Press and hold the **CAMERA** button.



Approximate distance the projection lines indicate is 12 inches (30 cm) from the vehicle.

☒ Checking from the front wide view at intersections

The front wide view image is a wide-angled view. The displayed image will be largely distorted, and objects may appear closer or more distant than they actually are.

☒ Checking the sides of your vehicle

When the door mirrors are folded, the side views cannot be displayed.

■ Surround View Camera System Limitations

The system may not work properly under the following conditions.

Conditions		Solutions
The images may not appear clearly when:	<ul style="list-style-type: none"> You activate the system in bad weather (heavy rain, snow, fog, etc.) or in the dark. Camera temperatures are high. A sudden change between light and dark such as an entrance or exit of a tunnel. You drive into the sunlight (e.g., at dawn or dusk.) 	Do not use the surround view camera system but rely only on visual confirmation until the conditions allow the system to work properly.
	<ul style="list-style-type: none"> A camera lens is covered with dirt, moisture, or debris. A camera lens is scratched. 	Clean camera lenses with a soft cloth moisturized with water, mild detergent or glass cleaner.
	The audio/information screen is dirty.	Wipe off the screen using a soft dry cloth.
A camera angle is altered.	A camera or the area around the camera has been severely impacted.	Do not use the surround view camera system and contact a dealer.
An error message is displayed while the surround view camera system is in use.		

Fuel Information

■ Fuel recommendation

Unleaded premium gasoline, pump octane number 91 or higher

Use of lower octane gasoline can cause occasional metallic knocking noise in the engine and will result in decreased engine performance.

Use of gasoline with a pump octane less than 87 can lead to engine damage.

■ Top tier detergent gasoline

Because the level of detergency and additives in gasoline vary in the market, Acura endorses the use of "TOP TIER Detergent Gasoline" where available to help maintain the performance and reliability of your vehicle. TOP TIER Detergent Gasoline meets a new gasoline standard jointly established by leading automotive manufacturers to meet the needs of today's advanced engines.

Qualifying gasoline retailers will, in most cases, identify their gasoline as having met "TOP TIER Detergent Gasoline" standards at the retail location. This fuel is guaranteed to contain the proper level of detergent additives and be free of metallic additives. The proper level of detergent additives, and absence of harmful metallic additives in gasoline, help avoid build-up of deposits in your engine and emission control system.

For further important fuel-related information for your vehicle, or on information on gasoline that does not contain MMT, visit Acura Owners at owners.acura.com. In Canada, visit www.acura.ca for additional information on gasoline. For more information on top tier gasoline, visit www.toptiergas.com.

■ Fuel tank capacity: 15.1 US gal (57 L)

☞ Fuel Information

NOTICE

We recommend quality gasoline containing detergent additives that help prevent fuel system and engine deposits. In addition, in order to maintain good performance, fuel economy, and emissions control, we strongly recommend the use of gasoline that does NOT contain harmful manganese-based fuel additives such as MMT, if such gasoline is available.

Use of gasoline with these additives may adversely affect performance, and cause the malfunction indicator lamp on your instrument panel to come on. If this happens, contact a dealer for service. Some gasoline today is blended with oxygenates such as ethanol. Your vehicle is designed to operate on oxygenated gasoline containing up to 15% ethanol by volume. Do not use gasoline containing methanol. If you notice any undesirable operating symptoms, try another service station or switch to another brand of gasoline.

How to Refuel

Your fuel tank is not equipped with a fuel filler cap. You can insert the filler nozzle directly into the filler neck. The tank seals itself again when you pull out the filler nozzle.

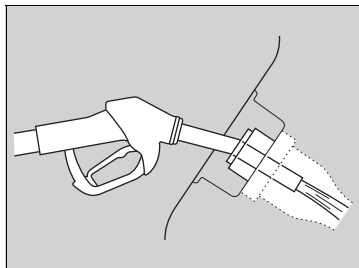

1. Stop your vehicle with the service station pump on the left side of the vehicle in the rear.
2. Turn off the power system.
3. Press the fuel fill door release button.
 - ▶ The fuel fill door opens.
4. Place the end of the filler nozzle on the lower part of filler opening, then insert it slowly and fully.
 - ▶ Make sure that the end of the filler nozzle goes down along with the filler pipe.
 - ▶ Keep the filler nozzle level.
 - ▶ When the tank is full, the filler nozzle will click off automatically.
 - ▶ After filling, wait about five seconds before removing the filler nozzle.
5. Shut the fuel fill door by hand.

How to Refuel

⚠ WARNING

Gasoline is highly flammable and explosive. You can be burned or seriously injured when handling fuel.

- Turn the power system off, and keep heat, sparks, and flame away.
- Handle fuel only outdoors.
- Wipe up spills immediately.

The fuel filler opening is designed to accept only service station filler nozzles for refueling. Use of smaller diameter tubes (e.g., those used to siphon fuel for other uses) or other non-service station devices can damage the area in and around the filler opening.

The filler nozzle automatically stops to leave space in the fuel tank so that fuel does not overflow as a result of changes in air temperature.

If the filler nozzle keeps turning off when the tank is not full, there may be a problem with the pump's fuel vapor recovery system. Try filling at another pump. If this does not fix the problem, consult a dealer.

Do not continue to add fuel after the filler nozzle has automatically stopped. Additional fuel can exceed the full tank capacity.

If you have to refuel your vehicle from a portable container, use the funnel provided with your vehicle.

▶ **Refueling From a Portable Fuel Container** P. 583

Improving Fuel Economy and Reducing CO₂ Emissions

Achieving fuel economy and reducing CO₂ emissions is dependent on several factors, including driving conditions, load weight, idling time, driving habits, and vehicle condition. Depending on these and other factors, you may not achieve the rated fuel economy of this vehicle.

Maintenance and Fuel Economy

You can optimize your fuel economy with proper maintenance of your vehicle. Always maintain your vehicle in accordance with the messages displayed on the multi-information display.

- Use engine oil with the viscosity recommended.
 - ▣ **Recommended Engine Oil** P. 504
- Maintain the specified tire pressure.
- Do not load the vehicle with excess cargo.
- Keep your vehicle clean. A buildup of snow or mud on your vehicle's underside adds weight and increases wind resistance.

Improving Fuel Economy and Reducing CO₂ Emissions

Direct calculation is the recommended method to determine actual fuel consumed while driving.

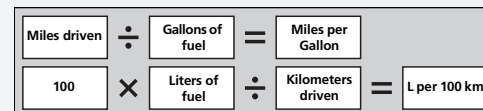

In Canada, posted fuel economy numbers are established following a simulated test. For more information on how this test is performed, please visit <http://oee.nrcan.gc.ca/>

Maintenance

This chapter discusses basic maintenance.



Before Performing Maintenance		
Inspection and Maintenance	492	
Safety When Performing Maintenance	493	
Parts and Fluids Used in Maintenance		
Service	494	
Maintenance Minder™	495	
Maintenance Under the Hood		
Maintenance Items Under the Hood	501	
Opening the Hood	502	
Engine Compartment Cover	503	
Recommended Engine Oil	504	
Oil Check	505	
Adding Engine Oil	506	
Changing the Engine Oil and Oil Filter	507	
Cooling System	509	
Inverter Coolant	511	
Transmission Fluid	512	
Brake Fluid	512	
Refilling Window Washer Fluid	513	
Replacing Light Bulbs	514	
Checking and Maintaining Wiper Blades	517	
Checking and Maintaining Tires		
Checking Tires	520	
Tire and Loading Information Label ..	521	
Tire Labeling	521	
DOT Tire Quality Grading (U.S. Vehicles) ..	523	
Wear Indicators	525	
Tire Service Life	525	
Tire and Wheel Replacement	526	
Tire Rotation	527	
Winter Tires	528	
12-Volt Battery	529	
Remote Transmitter Care		
Replacing the Button Battery	530	
Climate Control System Maintenance	531	
Cleaning		
Interior Care	532	
Exterior Care	534	
Accessories and Modifications	537	

Inspection and Maintenance

For your safety, perform all listed inspections and maintenance to keep your vehicle in good condition. If you become aware of any abnormality (noise, smell, insufficient brake fluid, oil residue on the ground, etc.), have your vehicle inspected by a dealer. (Note, however, that service at a dealer is not mandatory to keep your warranties in effect.) Refer to the separate maintenance booklet for detailed maintenance and inspection information.

Types of Inspection and Maintenance

■ Daily inspections

Perform inspections before long distance trips, when washing the vehicle, or when refueling.

■ Periodic inspections

- Check the brake fluid level monthly.
 - **Brake Fluid** P. 512
- Check the tire pressure monthly. Examine the tread for wear and foreign objects.
 - **Checking and Maintaining Tires** P. 520
- Check the operation of the exterior lights monthly.
 - **Replacing Light Bulbs** P. 514
- Check the condition of the wiper blades at least every six months.
 - **Checking and Maintaining Wiper Blades** P. 517

Inspection and Maintenance

U.S. models

Maintenance, replacement, or repair of emissions control devices and systems may be done by any automotive repair establishment or individuals using parts that are "certified" to EPA standards.

According to state and federal regulations, failure to perform maintenance on the maintenance main items marked with # will not void your emissions warranties. However, all maintenance services should be performed in accordance with the intervals indicated by the multi-information display.

➤ **Maintenance Service Items** P. 498

If you want to perform complex maintenance tasks that require more skills and tools, you can purchase a subscription to the Service Express website at www.techinfo.honda.com.

➤ **Authorized Manuals** P. 595

If you want to perform maintenance yourself, make sure that you have the necessary tools and skills first. After performing maintenance, update the records in the separate maintenance booklet.

Safety When Performing Maintenance

Some of the most important safety precautions are given here. However, we cannot warn you of every conceivable hazard that can arise in performing maintenance. Only you can decide whether you should perform a given task.

Maintenance Safety

- To reduce the possibility of fire or explosion, keep cigarettes, sparks, and flames away from the 12-volt battery, all High Voltage system, and all fuel related parts.
- Never leave rags, towels, or other flammable objects under the hood.
 - ▶ Heat from the engine and exhaust can ignite them, causing a fire.
- To clean parts, use a commercially available degreaser or parts cleaner, not gasoline.
- Wear eye protection and protective clothing when working with the 12-volt battery or compressed air.
- Engine exhaust contains carbon monoxide, which is poisonous and can kill you.
 - ▶ Only operate the engine if there is sufficient ventilation.

⚠ Safety When Performing Maintenance

⚠ WARNING

Improperly maintaining this vehicle or failing to correct a problem before driving can cause a crash in which you can be seriously hurt or killed.

Always follow the inspection and maintenance recommendations according to the schedules in this owner's manual.

⚠ WARNING

Failure to properly follow maintenance instructions and precautions can cause you to be seriously hurt or killed.

Always follow the procedures and precautions in this owner's manual.

■ Vehicle Safety

- The vehicle must be in a stationary condition.
 - ▶ Make sure your vehicle is parked on level ground, the parking brake is set, and the power system is turned off.
- Be aware that hot parts can burn you.
 - ▶ Make sure to let the power system including the engine and exhaust system cool thoroughly before touching vehicle parts.
- Be aware that moving parts can injure you.
 - ▶ Do not activate the power system unless instructed, and keep your hands and limbs away from moving parts. When the power mode is on, the engine can automatically start, or the radiator fan may start operating without the engine running.
- Do not touch the high-voltage battery and wiring (orange).

Parts and Fluids Used in Maintenance Service

The use of Acura genuine parts and fluids is recommended when maintaining and servicing your vehicle. Acura genuine parts are manufactured according to the same high quality standards used in Acura vehicles.

▶▶ Parts and Fluids Used in Maintenance Service

NOTICE

Do not press the engine cover forcibly. This may damage the engine cover and component parts.

If the engine oil life is less than 15%, you will see the Maintenance Minder messages appear on the multi-information display every time you set the power mode to ON. The messages notify you when to change the engine oil, or when to bring your vehicle to a dealer for indicated maintenance services.

To Use Maintenance Minder™

■ Displaying the Maintenance Minder Information

Maintenance items, which should be serviced at the same time that you replace the engine oil, appear on the multi-information display.

You can view them on the engine oil life screen at any time.

1. Set the power mode to ON.
2. Roll the right selector wheel until the engine oil life appears on the multi-information display.

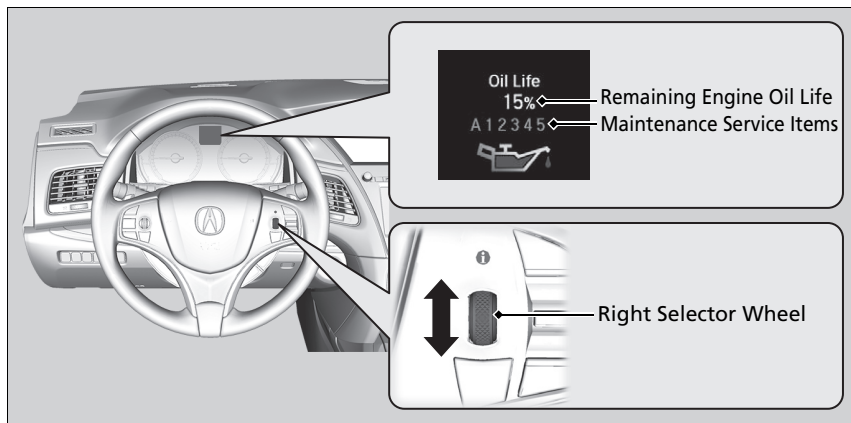

►► Displaying the Maintenance Minder Information





Based on the engine operating conditions, the remaining engine oil life is calculated and displayed as a percentage.

Displayed Engine Oil Life (%)	Calculated Engine Oil Life (%)
100	100 to 91
90	90 to 81
80	80 to 71
70	70 to 61
60	60 to 51
50	50 to 41
40	40 to 31
30	30 to 21
20	20 to 16
15	15 to 11
10	10 to 6
5	5 to 1
0	0

There is a list of maintenance main and sub items you can view on the multi-information display.

► **Maintenance Service Items** P. 498

Maintenance Minder Messages on the Multi-Information Display

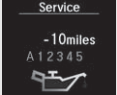
Maintenance Message	Oil Life Display	Explanation	Information
Maintenance Due Soon 	15 % 	The remaining engine oil life is 15 to 6 percent. Once you switch the display by rolling the right selector wheel, this message will go off.	The engine oil is approaching the end of its service life, and the maintenance items should be inspected and serviced soon.
Maintenance Due Now 	5 % 	The remaining engine oil life is 5 to 1 percent. Roll the right selector wheel to switch to another display.	The engine oil has almost reached the end of its service life, and the maintenance items should be inspected and serviced as soon as possible.
Maintenance Past Due 	Negative Distance 	The remaining engine oil life has passed its service life, and a negative distance appears after driving over 10 miles (U.S. models) or 10 km (Canadian models). Roll the right selector wheel to switch to another display.	The engine oil life has passed. The maintenance items must be inspected and serviced immediately.

The system message indicator (ⓘ) comes on along with the Maintenance Minder message.

■ Maintenance Service Items

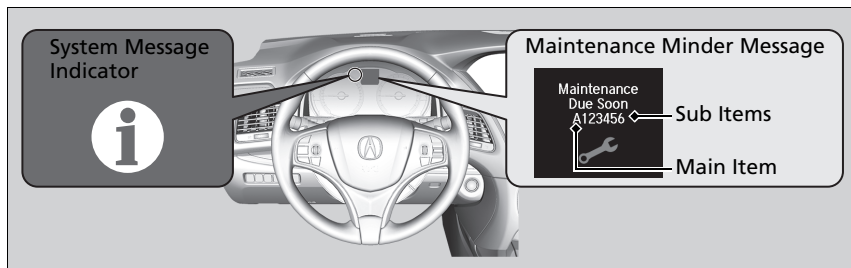

▣ Maintenance Service Items

- Independent of the Maintenance Minder information, replace the brake fluid every 3 years.
- Adjust the valves during services A, B, 1, 2, or 3 if they are noisy.

CODE	Maintenance Main Items
A	<ul style="list-style-type: none"> • Replace engine oil*¹
B	<ul style="list-style-type: none"> • Replace engine oil*¹ and oil filter • Inspect front and rear brakes • Check expiration date for temporary tire repair kit bottle (if equipped) • Inspect tie rod ends, steering gearbox, and boots • Inspect suspension components • Inspect driveshaft boots • Inspect brake hoses and lines (Including ABS/VSA®) • Inspect all fluid levels and condition of fluids • Inspect exhaust system[#] • Inspect fuel lines and connections[#]

*1: If a message **Maintenance Due Now** does not appear more than 12 months after the display is reset, change the engine oil every year.

#: See information on maintenance and emissions warranty.

CODE	Maintenance Sub Items
1	<ul style="list-style-type: none"> • Rotate tires
2	<ul style="list-style-type: none"> • Replace air cleaner element*² • Replace dust and pollen filter*³ • Inspect drive belt
3	<ul style="list-style-type: none"> • Replace transmission fluid*⁴
4	<ul style="list-style-type: none"> • Replace spark plugs • Replace timing belt and inspect water pump*⁵ • Inspect valve clearance
5	<ul style="list-style-type: none"> • Replace engine coolant
6	<ul style="list-style-type: none"> • Replace Twin Motor Unit fluid*⁶

*2: If you drive in dusty conditions, replace the air cleaner element every 15,000 miles (24,000 km).

*3: If you drive primarily in urban areas that have high concentrations of soot in the air from industry and from diesel-powered vehicles, replace the dust and pollen filter every 15,000 miles (24,000 km).

*4: Driving in mountainous areas at very low vehicle speeds results in higher transmission temperature. This requires transmission fluid changes more frequently than recommended by the Maintenance Minder. If you regularly drive your vehicle under this condition, have the transmission fluid changed at 30,000 miles (48,000 km), then every 25,000 miles (40,000 km).

*5: If you drive regularly in very high temperatures (over 110°F, 43°C), in very low temperatures (under -20°F, -29°C), replace every 60,000 miles (100,000 km).

*6: Driving in mountainous areas at very low vehicle speeds results in higher level of mechanical (Shear) stress to fluid. This requires Twin Motor Unit fluid changes more frequently than recommended by the Maintenance Minder. If you regularly drive your vehicle under this condition, have the Twin Motor Unit fluid changed at 7,500 miles (12,000 km), then every 15,000 miles (24,000 km).

Resetting the Display

Reset the maintenance minder information display if you have performed the maintenance service.

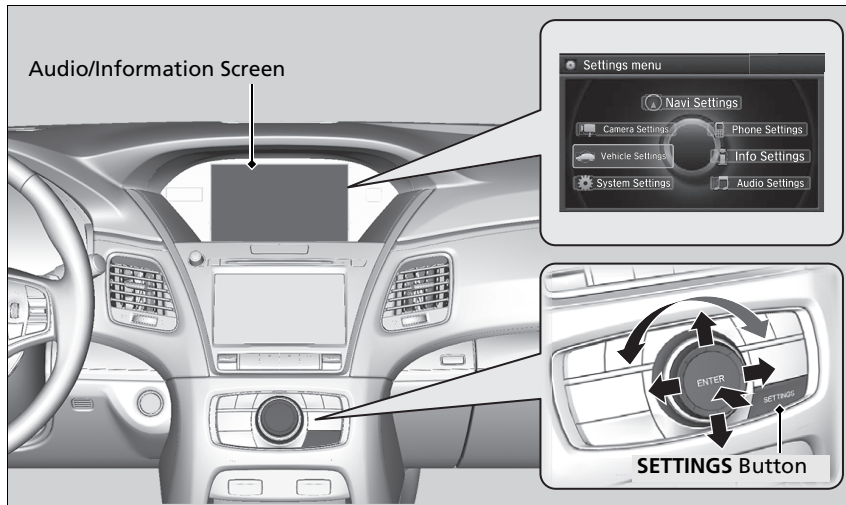

1. Set the power mode to ON.
2. Press the **SETTINGS** button.
3. Select **Vehicle Settings** by rotating the interface dial, then press **ENTER**.
4. Move the interface dial right or left to select **Maintenance Info.** tab.
5. Rotate the interface dial to select **Maintenance Reset**, then press **ENTER**.
6. Move the interface dial down to select **RESET**, then press **ENTER**.
 - A confirmation message appears on the audio/information screen.
7. Rotate the interface dial to select **Reset**, then press **ENTER**.
 - The displayed maintenance items disappear, and the engine oil life returns to 100%.

To cancel the maintenance reset mode, select **Cancel**, then press **ENTER**.

Resetting the Display

NOTICE

Failure to reset the Maintenance Minder™ display after a maintenance service results in the system showing incorrect maintenance intervals, which can lead to serious mechanical problems.

The dealer will reset the Maintenance Minder™ display after completing the required maintenance service. If someone other than a dealer performs maintenance service, reset the Maintenance Minder™ display yourself.

Maintenance Items Under the Hood

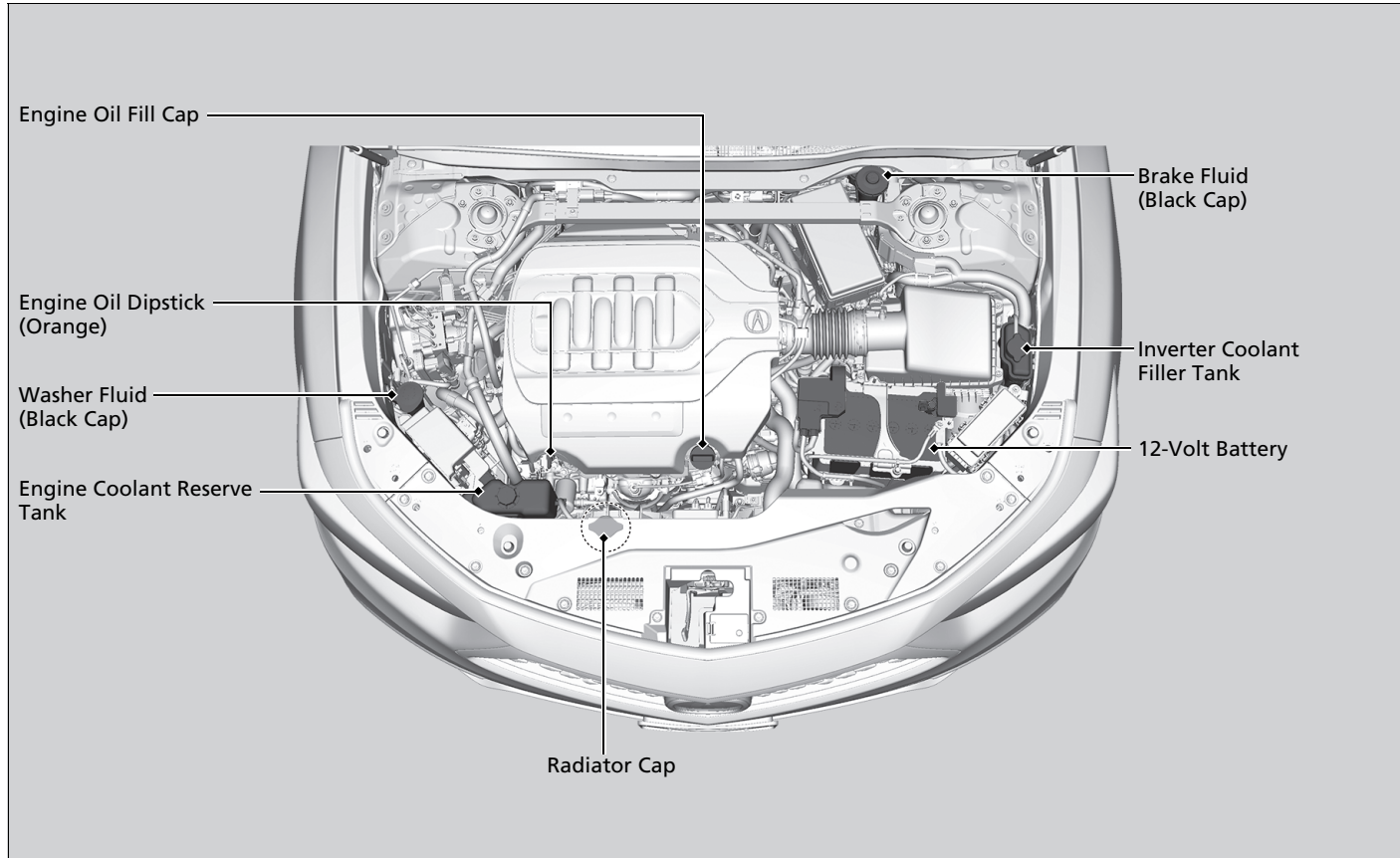

Opening the Hood

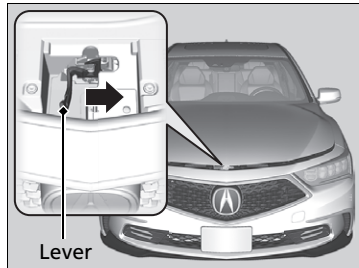
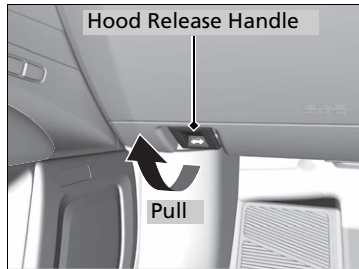

1. Park the vehicle on a level surface, and set the parking brake.
2. Pull the hood release handle under the driver's side lower left corner of the dashboard.
 - The hood will pop up slightly.
3. Push the hood latch lever (located under the front edge of the hood to the center) to the side and raise the hood. Once you have raised the hood slightly, you can release the lever.
4. Lift the hood up most of the way.
 - The hydraulic supports will lift it up the rest of the way and hold it up.

When closing, lower it to approximately 12 inches (30 cm), then press down firmly with your hands.

►► Opening the Hood

NOTICE

Do not open the hood when the wiper arms are raised. The hood will strike the wipers, resulting in damage to the hood and/or the wipers.

NOTICE

Do not press the engine cover forcibly. This may damage the engine cover and component parts.

When closing the hood, check that the hood is securely latched.

If the hood latch lever moves stiffly, or if you can open the hood without lifting the lever, the latch mechanism should be cleaned and lubricated.

Engine Compartment Cover

The component parts in the engine compartment are protected by a cover. You may need to remove the cover when you perform certain maintenance work. To remove the cover:

1. Remove the holding clips.
2. Move the hood seal rubber back and forth to remove it from the fender garnish.
3. Pull up on the engine compartment cover, remove it from the pins.

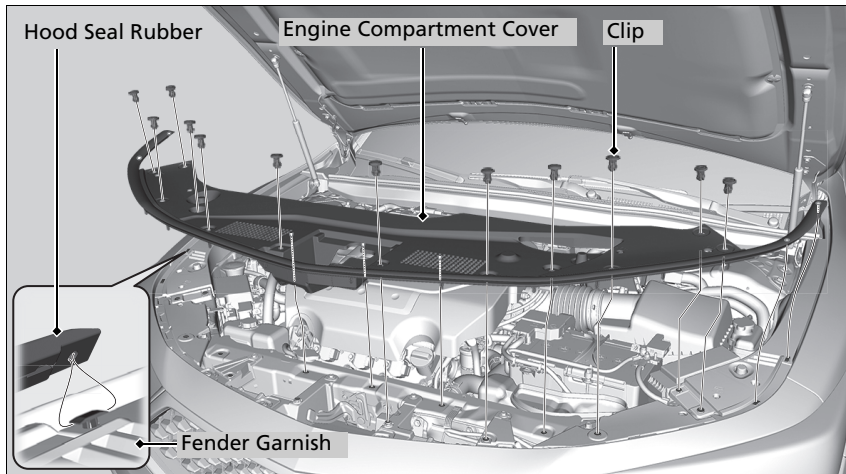

► Engine Compartment Cover

► Holding clip

Insert a flat-tip screwdriver, lift and remove the center pin to remove the clip.

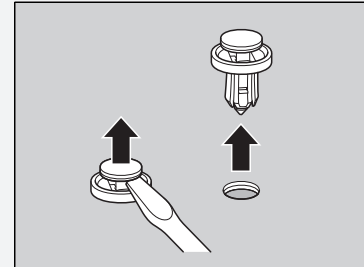

Insert the clip with the center pin raised, and push until it is flat.

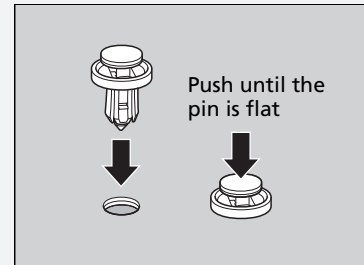

Recommended Engine Oil

Use a genuine engine oil or another commercial engine oil of suitable type and viscosity (for the ambient temperature) as shown in the image that follows.

Oil is a major contributor to your engine's performance and longevity. If you drive the vehicle with insufficient or deteriorated oil, the engine may fail or be damaged.

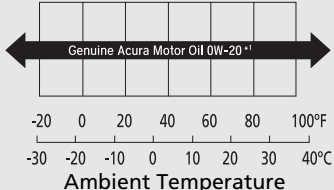
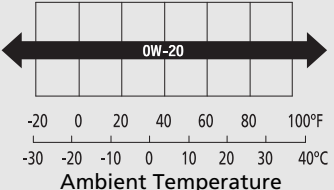
Genuine Engine Oil	Commercial Engine Oil
<ul style="list-style-type: none"> Genuine Acura Motor Oil 	<ul style="list-style-type: none"> Premium-grade 0W-20 detergent oil with an API Certification Seal on the container
 <p style="text-align: center;">Ambient Temperature</p>	 <p style="text-align: center;">Ambient Temperature</p>

*1: Formulated to improve fuel economy.

■ Synthetic oil

You may also use synthetic motor oil if it is labeled with the API Certification Seal and is the specified viscosity grade.

►► Recommended Engine Oil

Engine Oil Additives

Your vehicle does not require oil additives. In fact, they may adversely affect the engine performance and durability.

The following seal indicates the oil is energy conserving and that it meets the American Petroleum Institute's latest requirements.

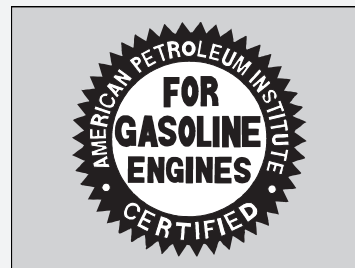

Oil Check

We recommend that you check the engine oil level every time you refuel.

Park the vehicle on level ground.

Turn off the power system. You can check the oil level without the engine having run beforehand. If the engine has been running, wait approximately three minutes before you check the oil.

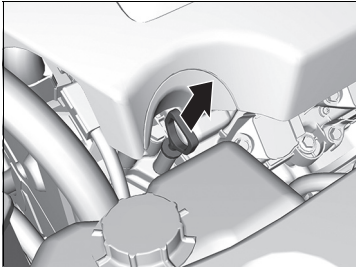

1. Remove the dipstick (orange).
2. Wipe the dipstick with a clean cloth or paper towel.
3. Insert the dipstick back all the way into its hole.

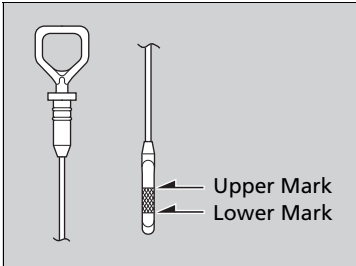

4. Remove the dipstick again, and check the level. It should be between the upper and lower marks. Add oil if necessary.

Oil Check

If the oil level is near or below the lower mark, slowly add oil being careful not to overfill.

Adding Engine Oil

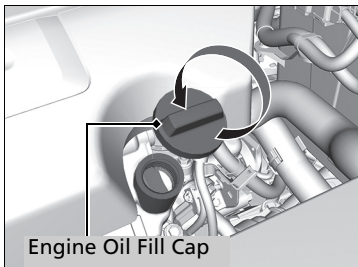

1. Unscrew and remove the engine oil fill cap.
2. Add oil slowly.
3. Reinstall the engine oil fill cap, and tighten it securely.
4. Wait for three minutes and recheck the engine oil dipstick.

► Adding Engine Oil

NOTICE

Do not fill the engine oil above the upper mark. Overfilling the engine oil may result in leaks and engine damage.

If any oil spills, wipe it away immediately. Spilled oil may damage the engine compartment components.

Changing the Engine Oil and Oil Filter

You must change the engine oil and oil filter regularly in order to maintain the engine's lubrication. The engine may be damaged if they are not changed regularly.

Turning the power system on automatically starts the engine if the following conditions are met:

- The SPORT mode is on.
▶ **SPORT Mode** P. 393

Change the oil and filter in accordance with the maintenance message on the multi-information display.

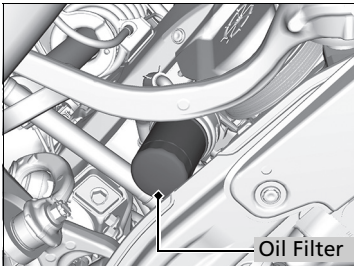
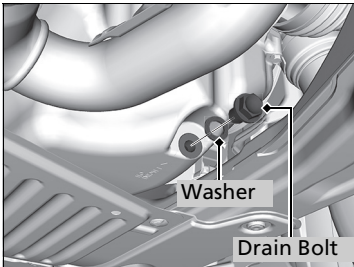

1. Run the engine until it reaches normal operating temperature, and then turn the engine off.
2. Open the hood and remove the engine oil fill cap.
3. Remove the drain bolt and washer from the bottom of the engine, and drain the oil into a suitable container.
4. Remove the oil filter and dispose of the remaining oil.
5. Check that the filter gasket is not stuck to the engine contact surface.
▶ If it is stuck, you must detach it.
6. Wipe away dirt and dust adhering to the contact surface of the engine block, and install a new oil filter.
▶ Apply a light coat of new engine oil to the filter gasket.

✕ Changing the Engine Oil and Oil Filter

NOTICE

You may damage the environment if you do not dispose of the oil in a suitable way. If you are changing the oil by yourself, appropriately dispose of the used oil. Put the oil in a sealed container and take it to a recycling center. Do not throw the oil away into a garbage can or onto the ground.

You will need a special wrench to replace the oil filter. You can buy this wrench from a dealer.

When installing the new oil filter, follow the instructions supplied with the oil filter.

Reinstall the engine oil fill cap. Start the engine. The low oil pressure indicator should go off within five seconds. If it does not, turn off the engine, and check your work.

Continued

7. Put a new washer on the drain bolt, then reinstall the drain bolt.
 - Tightening torque:
30 lbf·ft (40 N·m, 4.0 kgf·m)
8. Pour the recommended engine oil into the engine.
 - Engine oil change capacity (including filter):
4.5 US qt (4.3 L)
9. Reinstall the engine oil fill cap securely and start the engine.
10. Run the engine for a few minutes, and then check that there is no leak from the drain bolt or oil filter.
11. Stop the engine, wait for three minutes, and then check the oil level on the dipstick.
 - If necessary, add more engine oil.

Cooling System

Specified coolant: Acura Long Life Antifreeze/Coolant Type 2

This coolant is premixed with 50% antifreeze and 50% water. Do not add any straight antifreeze or water.

We recommend you check the engine coolant level every time you refuel. Check the reserve tank first. If it is completely empty, also check the coolant level in the radiator. Add the engine coolant accordingly.

Reserve Tank

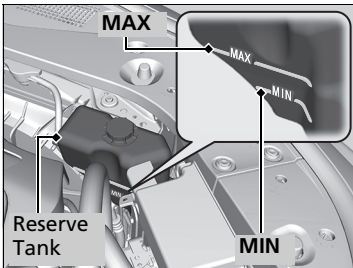

1. **Make sure the engine and radiator are cool.**
2. Check the amount of coolant in the reserve tank.
 - If the coolant level is below the **MIN** mark, add the specified coolant until it reaches the **MAX** mark.

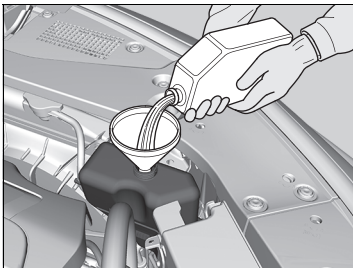

3. Inspect the cooling system for leaks.

⚠ Cooling System

⚠ WARNING

Removing the radiator cap while the engine is hot can cause the coolant to spray out, seriously scalding you.

Always let the engine and radiator cool down before removing the radiator cap.

NOTICE

Genuine Acura engine coolant is a 50/50 mixture of antifreeze and water that can withstand freezing at temperatures as low as about -31°F (-35°C). If your vehicle is consistently subjected to temperatures below this, the concentration of antifreeze in the coolant should be increased. Consult a dealer for details.

If Acura antifreeze/coolant is not available, you may use another major brand of non-silicate coolant as a temporary replacement. Check that it is a high quality coolant recommended for aluminum engines. Continued use of any non-Acura coolant can result in corrosion, causing the cooling system to malfunction or fail. Have the cooling system flushed and refilled with Acura antifreeze/coolant as soon as possible.

Do not add rust inhibitors or other additives to your vehicle's cooling system. They may not be compatible with the coolant or with the engine components.

Continued

Radiator

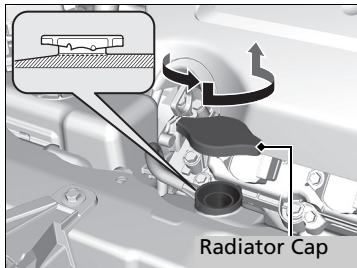

1. **Make sure the engine and radiator are cool.**
2. Remove the engine compartment cover.
 ➤ **Engine Compartment Cover** P. 503
3. Turn the radiator cap 1/8 turn counter-clockwise and relieve any pressure in the cooling system.
4. Push down and turn the radiator cap counter-clockwise to remove it.
5. The coolant level should be up to the base of the filler neck. Add coolant if it is low.
6. Put the radiator cap back on, and tighten it fully.

Radiator

NOTICE

Pour the fluid slowly and carefully so you do not spill any. Clean up any spills immediately; they can damage components in the engine compartment.

Inverter Coolant

Specified coolant: Acura Long Life Antifreeze/Coolant Type 2

This coolant is premixed with 50% antifreeze and 50% water. Do not add any straight antifreeze or water.

We recommend you check the inverter coolant level every time you refuel.

Have a dealer replace the inverter coolant.

Checking the Coolant

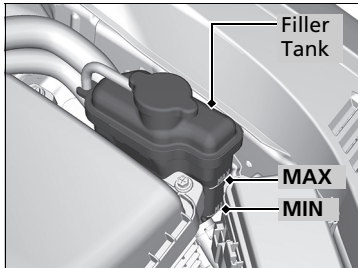

1. Check the fluid level in the tank.
2. If the coolant level has dropped below the **MIN** level, have your vehicle serviced at a dealer.
 - Only a properly trained technician can refill the coolant and check the system for leaks.

⌘ Inverter Coolant

NOTICE

Genuine Acura engine coolant is a 50/50 mixture of antifreeze and water that can withstand freezing at temperatures as low as about -31°F (-35°C). If your vehicle is consistently subjected to temperatures below this, the concentration of antifreeze in the coolant should be increased. Consult a dealer for details.

If Acura antifreeze/coolant is not available, you may use another major brand of non-silicate coolant as a temporary replacement. Check that it is a high quality coolant recommended for aluminum engines. Continued use of any non-Acura coolant can result in corrosion, causing the cooling system to malfunction or fail. Have the cooling system flushed and refilled with Acura antifreeze/coolant as soon as possible.

Do not add rust inhibitors or other additives to your vehicle's cooling system. They may not be compatible with the coolant or with the motor components.

Transmission Fluid

■ Dual Clutch Transmission Fluid

Specified fluid: Acura Automatic Transmission Fluid ATF DW-1

Have a dealer check the fluid level and replace if necessary.

Do not attempt to check or change the automatic transmission fluid yourself.

Brake Fluid

Specified fluid: Acura Heavy Duty Brake Fluid DOT 3

■ Checking the Brake Fluid

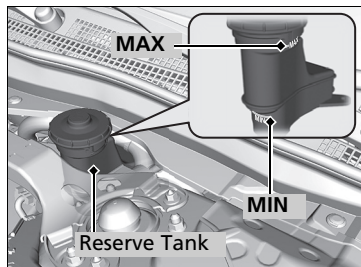

The fluid level should be between the **MIN** and **MAX** marks on the side of the reserve tank.

►► Dual Clutch Transmission Fluid

NOTICE

Acura ATF DW-1 must not be mixed with other transmission fluids.

Using a transmission fluid other than Acura ATF DW-1 may adversely affect the operation and durability of your vehicle's transmission, and damage the transmission.

Any damage caused by using a transmission fluid that is not equivalent to Acura ATF DW-1 is not covered by Acura's new vehicle limited warranty.

►► Brake Fluid

NOTICE

Brake fluid marked DOT 5 is not compatible with your vehicle's braking system and can cause extensive damage.

If the specified brake fluid is not available, you should use only DOT 3 or DOT 4 fluid from a sealed container as a temporary replacement.

Using any non-Acura brake fluid can cause corrosion and decrease the longevity of the system. Have the brake system flushed and refilled with Acura Heavy Duty Brake Fluid DOT 3 as soon as possible.

If the brake fluid level is at or below the **MIN** mark, have a dealer inspect the vehicle for leaks or worn brake pads as soon as possible.

Refilling Window Washer Fluid

If the washer fluid is low, a message appears on the multi-information display. Pour the washer fluid carefully. Do not overflow the reservoir.

ⓘ Refilling Window Washer Fluid

NOTICE

Do not use engine antifreeze or a vinegar/water solution in the windshield washer reservoir. Antifreeze can damage your vehicle's paint. A vinegar/water solution can damage the windshield washer pump.

Use only commercially available windshield washer fluid.

Avoid prolonged use of hard water to prevent lime scale build up.

Headlights

Headlights are LED type. Have an authorized Acura dealer inspect and replace the light assembly.

Parking/Daytime Running Lights

Parking/daytime running lights are LED type. Have an authorized Acura dealer inspect and replace the light assembly.

Fog Lights*

Fog lights are LED type. Have an authorized Acura dealer inspect and replace the light assembly.

Front Turn Signal Lights

Front turn signal lights are LED type. Have an authorized Acura dealer inspect and replace the light assembly.

Headlights

The headlight aim is set by the factory, and does not need to be adjusted. However, if you regularly carry heavy items in the trunk, have the aiming readjusted at a dealer or by a qualified technician.

Front Side Marker Lights

Front side marker lights are LED type. Have an authorized Acura dealer inspect and replace the light assembly.

Side Turn Signal/Emergency Indicator Lights

Door mirror side turn lights are LED type. Have an authorized Acura dealer inspect and replace the light assembly.

Rear Turn Signal Lights

Rear turn signal lights are LED type. Have an authorized Acura dealer inspect and replace the light assembly.

Brake/Taillight and Rear Side Marker Lights

Brake/taillight and rear side marker lights are LED type. Have an authorized Acura dealer inspect and replace the light assembly.

Taillights

Taillights are LED type. Have an authorized Acura dealer inspect and replace the light assembly.

Back-Up Lights

Back-up lights are LED type. Have an authorized Acura dealer inspect and replace the light assembly.

Rear License Plate Lights

Rear license plate lights are LED type. Have an authorized Acura dealer inspect and replace the light assembly.

High-Mount Brake Light

High-mount brake light is LED type. Have an authorized Acura dealer inspect and replace the light assembly.

Door Outer Handle Ambient Lights

Door outer handle ambient lights are LED type. Have an authorized Acura dealer inspect and replace the light assembly.

Checking Wiper Blades

If the wiper blade rubber has deteriorated, it will leave streaks and the hard surfaces of the blade may scratch the window glass.

Changing the Wiper Blade Rubber

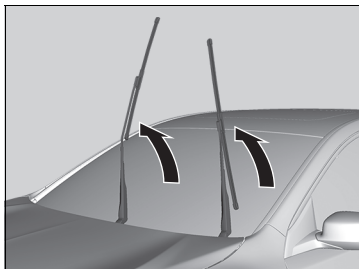
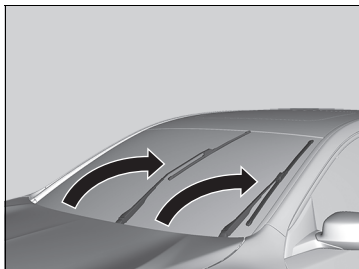

1. Set the power mode to VEHICLE OFF.
2. While holding the wiper switch in the **MIST** position, set the power mode to ON, then to VEHICLE OFF.
 - ▶ Both wiper arms are set to the maintenance position as shown in the image.
3. Lift both wiper arms.

Changing the Wiper Blade Rubber

NOTICE

Avoid dropping the wiper arm onto the windshield, it may damage the wiper arm and/or the windshield.

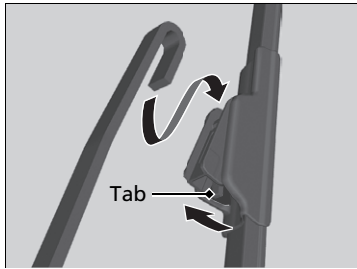

4. Press and hold the tab, then slide the holder off the wiper arm.

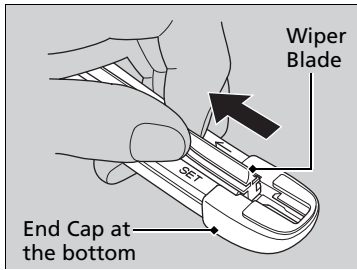

5. Pull the end of the wiper blade in the direction of the arrow in the image until it is out of the holder's end cap.

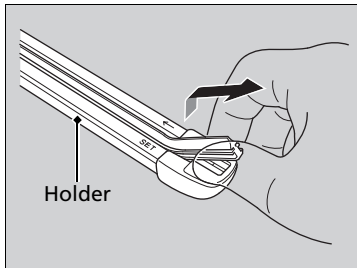

6. Pull the wiper blade in the opposite direction to slide it out of the holder.

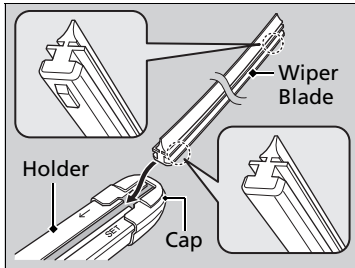

7. Insert the flat side of the new wiper blade onto the bottom part of the holder. Insert the blade all the way.
8. Install the end of the wiper blade into the cap.
9. Slide the holder onto the wiper arm until it locks.
10. Lower both wiper arms.
11. Set the power mode to ON and hold the wiper switch in the **MIST** position until both wiper arms return to the standard position.

Checking Tires

To safely operate your vehicle, your tires must be of the proper type and size, in good condition with adequate tread, and properly inflated.

■ Inflation guidelines

Properly inflated tires provide the best combination of handling, tread life, and comfort. Refer to the driver's doorjamb label or specifications page for the specified pressure.

Underinflated tires wear unevenly, adversely affect handling and fuel economy, and are more likely to fail from overheating.

Overinflated tires make your vehicle ride harshly, are more prone to road hazards, and wear unevenly.

Every day before you drive, look at each of the tires. If one looks lower than the others, check the pressure with a tire gauge.

At least once a month or before long trips, use a gauge to measure the pressure in all tires, including the spare*. Even tires in good condition can lose 1-2 psi (10-20 kPa, 0.1-0.2 kgf/cm²) per month.

■ Inspection guidelines

Every time you check inflation, also examine the tires and valve stems. Look for:

- Bumps or bulges on the side or in the tread. Replace the tire if you find any cuts, splits, or cracks in the side of the tire. Replace it if you see fabric or cord.
- Remove any foreign objects and inspect for air leaks.
- Uneven tread wear. Have a dealer check the wheel alignment.
- Excessive tread wear.
 - **Wear Indicators** P. 525
- Cracks or other damage around valve stem.

* Not available on all models

☞ Checking Tires

WARNING

Using tires that are excessively worn or improperly inflated can cause a crash in which you can be seriously hurt or killed.

Follow all instructions in this owner's manual regarding tire inflation and maintenance.

Measure the air pressure when tires are cold. This means the vehicle has been parked for at least three hours, or driven less than 1 mile (1.6 km). If necessary, add or release air until the specified pressure is reached.

If checked when hot, tire pressure can be as much as 4–6 psi (30–40 kPa, 0.3–0.4 kgf/cm²) higher than if checked when cold.

Have a dealer check the tires if you feel a consistent vibration while driving. New tires and any that have been removed and reinstalled should be properly balanced.

Vehicles with optional spare tire kit

Check the spare tire pressure once a month or before long trips.

Tire and Loading Information Label

The label attached to the driver's doorjamb provides necessary tire and loading information.

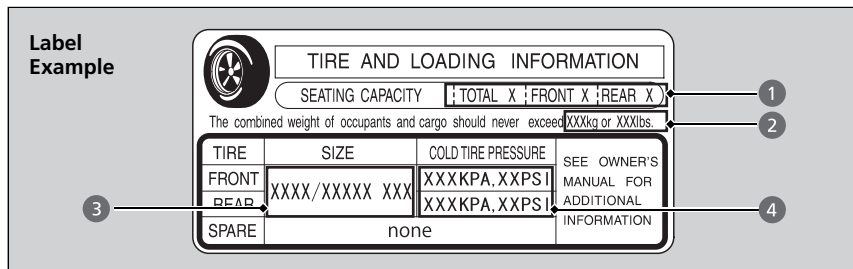

☒ Tire and Loading Information Label

The tire and loading information label attached to the driver's doorjamb contains:

- 1 The number of people your vehicle can carry.
- 2 The total weight your vehicle can carry. Do not exceed this weight.
- 3 The original tire sizes for front, rear, and spare, if equipped.
- 4 The proper cold tire pressure for front, rear, and spare, if equipped.

Tire Labeling

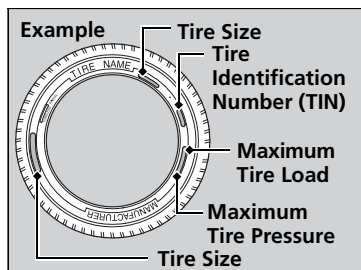

The tires that came on your vehicle have a number of markings. Those you should be aware of are described as follows.

☒ Tire Sizes

Following is an example of tire size with an explanation of what each component means.

245/40R19 98W

- 245: Tire width in millimeters.
- 40: Aspect ratio (the tire's section height as a percentage of its width).
- R: Tire construction code (R indicates radial).
- 19: Rim diameter in inches.
- 98: Load index (a numerical code associated with the maximum load the tire can carry).
- W: Speed symbol (an alphabetical code indicating the maximum speed rating).

Tire Sizes

Whenever tires are replaced, they should be replaced with tires of the same size.

Continued

■ Tire Identification Number (TIN)

The tire identification number (TIN) is a group of numbers and letters that look like the example in the side column. TIN is located on the sidewall of the tire.

■ Glossary of Tire Terminology

Cold Tire Pressure – The tire air pressure when the vehicle has been parked for at least three hours or driven less than 1 mile (1.6 km).

Load Rating – Means the maximum load that a tire is rated to carry for a given inflation pressure.

Maximum Inflation Pressure – The maximum tire air pressure that the tire can hold.

Maximum Load Rating – Means the load rating for a tire at the maximum permissible inflation pressure for that tire.

Recommended Inflation Pressure – The cold tire inflation pressure recommended by the manufacturer.

Treadwear Indicators (TWI) – Means the projections within the principal grooves designed to give a visual indication of the degrees of wear of the tread.

►► Tire Identification Number (TIN)

DOT B97R FW6X 2209

DOT: This indicates that the tire meets all requirements of the U.S. Department of Transportation.

B97R: Manufacturer's identification mark.

FW6X: Tire type code.

22 09: Date of manufacture.

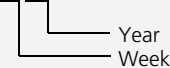

DOT Tire Quality Grading (U.S. Vehicles)

The tires on your vehicle meet all U.S. Federal Safety Requirements. All tires are also graded for treadwear, traction, and temperature performance according to Department of Transportation (DOT) standards. The following explains these gradings.

■ Uniform Tire Quality Grading

Quality grades can be found where applicable on the tire sidewall between tread shoulder and maximum section width.

■ Treadwear

The treadwear grade is a comparative rating based on the wear rate of the tire when tested under controlled conditions on a specified government test course. For example, a tire graded 150 would wear one and one-half (1 1/2) times as well on the government course as a tire graded 100. The relative performance of tires depends upon the actual conditions of their use, however, and may depart significantly from the norm due to variations in driving habits, service practices and differences in road characteristics and climate.

▣ Uniform Tire Quality Grading

For example:
Treadwear 200
Traction AA
Temperature A

All passenger car tires must conform to Federal Safety Requirements in addition to these grades.

■ Traction

The traction grades, from highest to lowest, are AA, A, B, and C. Those grades represent the tire's ability to stop on wet pavement as measured under controlled conditions on specified government test surfaces of asphalt and concrete. A tire marked C may have poor traction performance.

■ Temperature

The temperature grades are A (the highest), B, and C, representing the tire's resistance to the generation of heat and its ability to dissipate heat when tested under controlled conditions on a specified indoor laboratory test wheel. Sustained high temperature can cause the material of the tire to degenerate and reduce tire life, and excessive temperature can lead to sudden tire failure. The grade C corresponds to a level of performance which all passenger car tires must meet under the Federal Motor Vehicle Safety Standard No. 109. Grades B and A represent higher levels of performance on the laboratory test wheel than the minimum required by law.

⊗ Traction

Warning: The traction grade assigned to this tire is based on straight-ahead braking traction tests, and does not include acceleration, cornering, hydroplaning, or peak traction characteristics.

⊗ Temperature

Warning: The temperature grade for this tire is established for a tire that is properly inflated and not overloaded. Excessive speed, underinflation, or excessive loading, either separately or in combination, can cause heat buildup and possible tire failure.

Wear Indicators

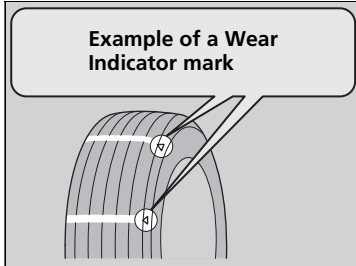

The groove where the wear indicator is located is 1/16 inch (1.6 mm) shallower than elsewhere on the tire. If the tread has worn so that the indicator is exposed, replace the tire.

Worn out tires have poor traction on wet roads.

Tire Service Life

The life of your tires is dependent on many factors, including driving habits, road conditions, vehicle loading, inflation pressure, maintenance history, speed, and environmental conditions (even when the tires are not in use).

In addition to regular inspections and inflation pressure maintenance, it is recommended that you have annual inspections performed once the tires reach five years old. All tires, including the spare*, should be removed from service after 10 years from the date of manufacture, regardless of their condition or state of wear.

* Not available on all models

☒ Checking Tires

High speed driving

We recommend that you do not drive faster than the posted speed limits and conditions allow. If you drive at sustained high speeds (over 118 mph or 190 km/h), adjust the cold tire pressures as shown below to avoid excessive heat build up and sudden tire failure.

Tire Size	245/40R19 98W
Pressure	38 psi (260 kPa, 2.7 kgf/cm ²)

Tire and Wheel Replacement

Replace your tires with radials of the same size, load range, speed rating, and maximum cold tire pressure rating (as shown on the tire's sidewall). Using tires of a different size or construction can cause certain vehicle systems such as the ABS and Vehicle Stability Assist™ (VSA®) system to work incorrectly.

It is best to replace all four tires at the same time. If that isn't possible, replace the front or rear tires in pairs.

If you replace a wheel, only use TPMS specified wheels approved for your vehicle. Make sure that the wheel's specifications match those of the original wheels.

▶▶ Tire and Wheel Replacement

WARNING

Installing improper tires on your vehicle can affect handling and stability. This can cause a crash in which you can be seriously hurt or killed.

Always use the size and type of tires recommended in this owner's manual.

Tire Rotation

Rotating tires according to the maintenance messages on the multi-information display helps to distribute wear more evenly and increase tire life.

■ Tires without rotation marks

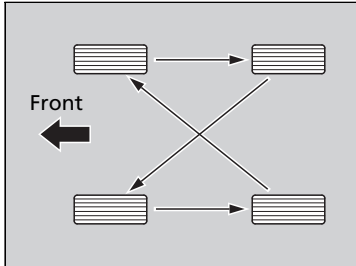

Rotate the tires as shown here.

■ Tires with rotation marks

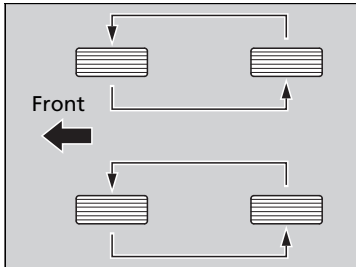

Rotate the tires as shown here.

☒ Tire Rotation

Tires with directional tread patterns should only be rotated front to back (not from one side to the other). Directional tires should be mounted with the rotation indication mark facing forward, as shown below.

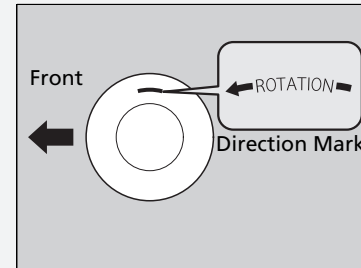

Winter Tires

If driving on snowy or frozen roads, mount all season marked **M+S** tires, snow tires, or tire chains; reduce speed; and maintain sufficient distance between vehicles when driving.

Be particularly careful when operating the steering wheel or brakes to prevent skidding.

Use tire chains, snow tires, or all season tires when necessary or according to the law.

When mounting, refer to the following points.

For winter tires:

- Select the size and load ranges that are the same as the original tires.
- Mount the tires to all four wheels.

For tire chains:

- Install them on the front tires only.
- Because your vehicle has limited tire clearance, we strongly recommend using the chains listed below:

Cable-type: SCC Radial Chain SC1040

- Follow the chain manufacturer's instruction when installing. Mount them as tightly as you can.
- Check that the chains do not touch the brake lines or suspension.
- Drive slowly.

❧ Winter Tires

WARNING

Using the wrong chains, or not properly installing chains, can damage the brake lines and cause a crash in which you can be seriously injured or killed.

Follow all instructions in this owner's manual regarding the selection and use of tire chains.

NOTICE

Traction devices that are the wrong size or improperly installed can damage your vehicle's brake lines, suspension, body, and wheels. Stop driving if they are hitting any part of the vehicle.

When tire chains are mounted, follow the chain manufacturer's instructions regarding vehicle operational limits.

If your vehicle is equipped with summer tires, be aware that these tires are not designed for winter driving conditions. For more information, contact a dealer.

Checking the 12-Volt Battery

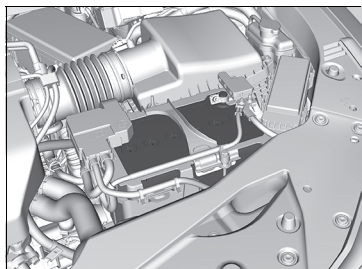

The condition of the battery is monitored by a sensor located on the negative terminal of the battery. If there is a problem with this sensor, the multi-information display will display a warning message. If this happens, have your vehicle inspected by a dealer.

Check the battery terminals for corrosion monthly.

If your vehicle's battery is disconnected or goes dead:

- The audio system is disabled.
 - **Reactivating the audio system** P. 214
- The clock resets.
 - **Clock** P. 128

Charging the 12-Volt Battery

Disconnect both battery cables to prevent damaging your vehicle's electrical system. Always disconnect the negative (–) cable first, and reconnect it last.

12-Volt Battery

⚠ WARNING

The battery gives off explosive hydrogen gas during normal operation.

A spark or flame can cause the battery to explode with enough force to kill or seriously hurt you.

When conducting any battery maintenance, wear protective clothing and a face shield, or have a skilled technician do it.

WARNING: Battery post, terminals, and related accessories contain lead and lead compounds.
Wash your hands after handling.

When you find corrosion, clean the battery terminals by applying a baking powder and water solution. Clean the terminals with a damp towel. Cloth/towel dry the battery. Coat the terminals with grease to help prevent future corrosion.

When replacing the battery, the replacement must be of the same specifications. Consult a dealer for more information.

Replacing the Button Battery

If the indicator does not come on when the button is pressed, replace the battery.

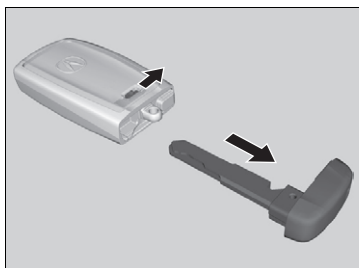

Battery type: CR2032

1. Remove the built-in key.
 - ▶ As a convenience, lightly place masking tape over the remote buttons to hold them in place.
2. Remove the upper half by carefully prying on the edge with a coin.
 - ▶ Wrap a coin with a cloth to prevent scratching the transmitter.
3. Press down on the center of the assembly and remove the battery.
 - ▶ When removing the button battery, be careful not to touch parts around it.
4. Make sure to replace the battery with the correct polarity.

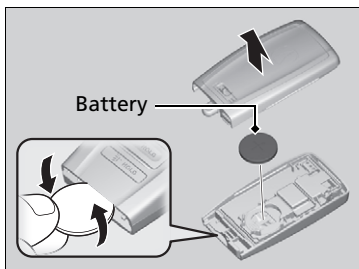

Replacing the Button Battery

⚠ WARNING

CHEMICAL BURN HAZARD

The battery that powers the remote transmitter can cause severe internal burns and can even lead to death if swallowed. Keep new and used batteries away from children.

If you suspect that a child has swallowed the battery, seek medical attention immediately.

NOTICE

An improperly disposed of battery can damage the environment. Always confirm local regulations for battery disposal.

NOTICE

The Remote transmitter is equipped with two batteries: A standard replaceable CR2032 coin button battery and an integral non-replaceable rechargeable battery. To prevent permanent damage to the rechargeable battery, replace the CR2032 battery every three to four years.

Replacement batteries are commercially available or at a dealer.

Dust and Pollen Filter

The climate control system is equipped with a dust and pollen filter that collects pollen, dust, and other debris in the air. The Maintenance Minder™ messages will let you know when to replace the filter.

We recommend that you replace the dust and pollen filter sooner when using your vehicle in areas with high concentrations of dust.

▣ Dust and Pollen Filter

If the airflow from the climate control system deteriorates noticeably, and the windows fog up easily, the filter may need to be replaced. Please contact a dealer for replacement.

Interior Care

Use a damp cloth with a mixture of mild detergent and warm water to remove dirt. Use a clean cloth to remove detergent residue.

Cleaning Seat Belts

Use a soft brush with a mixture of mild soap and warm water to clean the seat belts. Let the belts air dry. Wipe the openings of the seat belt anchors using a clean cloth.

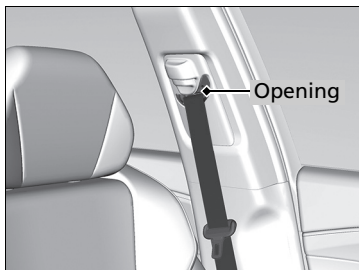

Cleaning the Window

Wipe using a glass cleaner.

Interior Care

Do not spill liquids inside the vehicle. Electrical devices and systems may malfunction if liquids are splashed on them.

Do not use silicone based sprays on electrical devices such as audio devices and switches. Doing so may cause the items to malfunction or cause a fire inside the vehicle.

If a silicone based spray is inadvertently used on electrical devices, consult a dealer.

Depending on their composition, chemicals and liquid aromatics may cause discoloration, wrinkles, and cracking to resin-based parts and textiles. Do not use alkali solvents or organic solvents such as benzene or gasoline.

After using chemicals, make sure to gently wipe them away using a dry cloth.

Do not place used cloths on top of resin based parts or textiles for long periods of time without washing.

Cleaning the Window

Wires are mounted to the inside of the rear window. Wipe along the same direction as the wires with a soft cloth so as not to damage them.

Be careful not to spill fluids, such as water or glass cleaner, on or around the cover of both the front sensor camera and the rainfall/light sensor.

■ Floor Mats

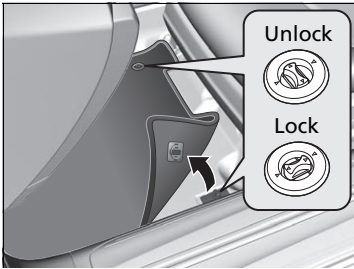

The floor mats hook over floor anchors, which keep them from sliding forward. To remove a mat for cleaning, turn the anchor knobs to the unlock position. When reinstalling the mat after cleaning, turn the knobs to the lock position.

Do not put additional floor mats on top of the anchored mat.

■ Maintaining Genuine Leather

To properly clean leather:

1. Use a vacuum or soft dry cloth first to remove any dirt or dust.
2. Clean the leather with a soft cloth dampened with a solution comprised of 90% water and 10% neutral soap.
3. Wipe away any soap residue with a clean damp cloth.
4. Wipe away residual water and allow leather to air dry in the shade.

▣ Floor Mats

If you use any floor mats that were not originally provided with your vehicle, make sure they are designed for your specific vehicle, fit correctly, and are securely anchored by the floor anchors. Position the rear seat floor mats properly. If they are not properly positioned, the floor mats can interfere with the front seat functions.

▣ Maintaining Genuine Leather

It is important to clean or wipe away dirt or dust as soon as possible. Spills can soak into leather resulting in stains. Dirt or dust can cause abrasions in the leather. In addition, please note that some dark colored clothing can rub onto the leather seats resulting in discoloration or stains.

Exterior Care

Dust off the vehicle body after you drive. Regularly inspect your vehicle for scratches on painted surfaces. A scratch on a painted surface can result in body rust. If you find a scratch, promptly repair it.

■ Washing the Vehicle

Wash the vehicle regularly. Wash more frequently when driving in the following conditions:

- If driving on roads with road salt.
- If driving in coastal areas.
- If tar, soot, bird droppings, insects, or tree sap are stuck to painted surfaces.

■ Using an Automated Car Wash

- Make sure to follow the instructions indicated on the automated car wash.
- Fold in the door mirrors.
- Turn off the automatic intermittent wipers.

⌘ Washing the Vehicle

Do not spray water into the air intake vents. It can cause a malfunction.

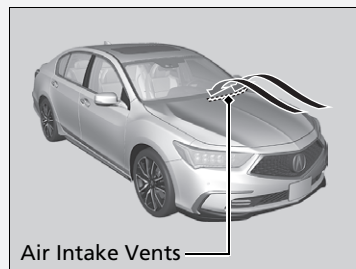

Do not spray water onto the capless unit when the fuel fill door is open. It can cause damage to the fuel system or engine.

⌘ Using an Automated Car Wash

When using an automated car wash that pulls the vehicle through with a conveyor, make sure the transmission is in the **N** position.

❏ **If you want to keep the transmission in **N** position** P. 389

Using High Pressure Cleaners

- Keep sufficient distance between the cleaning nozzle and the vehicle body.
- Take particular care around the windows. Standing too close may cause water to enter the vehicle interior.
- Do not spray high pressure water directly into the engine compartment. Instead, use low pressure water and a mild detergent.

Applying Wax

A good coat of automotive body wax helps protect your vehicle's paint from the elements. Wax will wear off over time and expose your vehicle's paint to the elements, so reapply as necessary.

Maintaining the Bumpers and Other Resin Coated Parts

If you get gasoline, oil, engine coolant, or battery fluid on resin coated parts, they may be stained or the coating may peel. Promptly wipe it away using a soft cloth and clean water.

Cleaning the Window

Wipe using a glass cleaner.

Applying Wax

NOTICE

Chemical solvents and strong cleaners can damage the paint, metal, and plastic on your vehicle. Wipe away spills immediately.

Maintaining the Bumpers and Other Resin Coated Parts

Ask a dealer about the correct coating material when you want to repair the painted surface of the parts made of resin.

■ Maintaining Aluminum Wheels

Aluminum is susceptible to deterioration caused by salt and other road contaminants. When necessary, as early as possible use a sponge and mild detergent to wipe away these contaminants. Do not use a stiff brush or harsh chemicals (including some commercial wheel cleaners). These can damage the protective finish on aluminum alloy wheels, resulting in corrosion.

Depending on the type of finish, the wheels also may lose their luster or appear burnished. To avoid water stains, wipe the wheels dry with a cloth while they are still wet.

■ Fogged Exterior Light Lenses

The inside lenses of exterior lights (headlights, brake lights, etc.) may fog temporarily if you have driven in the rain, or after the vehicle has been run through a car wash. Dew condensation also may build up inside the lenses when there is a significant enough difference between the ambient and inside lens temperatures (similar to vehicle windows fogging up in rainy conditions). These conditions are natural processes, not structural design problems in the exterior lights.

Lens design characteristics may result in moisture developing on the light lens frame surfaces. This also is not a malfunction.

However, if you see large amounts of water accumulation, or large water drops building up inside the lenses, have your vehicle inspected by a dealer.

Accessories

When installing accessories, check the following:

- Do not install accessories on the windshield. They can obstruct your view and delay your reaction to driving conditions.
- Do not install any accessories over areas marked SRS AIRBAG, on the sides or backs of the front seats, on front or side pillars, or near the side windows. Accessories installed in these areas may interfere with proper operation of the vehicle's airbags or may be propelled into you or another occupant if the airbags deploy.
- Be sure electronic accessories do not overload electrical circuits or interfere with proper operation of your vehicle.
 - **Fuses** P. 572
- Before installing any electronic accessory, have the installer contact a dealer for assistance. If possible, have a dealer inspect the final installation.

Accessories and Modifications

WARNING

Improper accessories or modifications can affect your vehicle's handling, stability, and performance, and cause a crash in which you can be seriously hurt or killed.

Follow all instructions in this owner's manual regarding accessories and modifications.

WARNING

Use of improperly designed, engineered or manufactured high-voltage battery assemblies could cause a fire in your vehicle.

A vehicle fire could result in a crash or injury.

Only use a genuine Acura high-voltage battery assembly, or its equivalent, in your vehicle.

Acura Genuine accessories are recommended to ensure proper operation on your vehicle.

Modifications

Do not modify your vehicle in a manner that may affect its handling, stability, or reliability, or install non-genuine Acura parts or accessories that may have a similar effect.

Even minor modifications to vehicle systems can affect overall vehicle performance. Always make sure all equipment is properly installed and maintained, and do not make any modification to your vehicle or its systems that might cause your vehicle to no longer meet federal, state, province, territory, and local regulations.

The on-board diagnostic port (OBD-II/SAE J1962 connector) installed on this vehicle is intended to be used with automobile system diagnostic devices or with other devices that Acura has approved. Use of any other type of device may adversely affect the vehicle's electronic systems or allow them to be compromised, possibly resulting in a system malfunction, drained battery, or other unexpected problems.

Do not modify or attempt to repair your vehicle's high-voltage hybrid power system or otherwise modify vehicle electrical systems. Disassembling or modifying electrical equipment can result in a crash or a fire.

If you ever need to replace your vehicle's high-voltage battery assembly outside of warranty coverage, we highly recommend that you only use a genuine Acura high-voltage battery assembly. Genuine Acura high-voltage battery assemblies are designed to work with your vehicle's hybrid power system and have been designed, engineered and manufactured to avoid overcharging situations. Non-genuine high-voltage battery assemblies may not have been similarly designed, engineered and manufactured, and installation of such assemblies could result in overcharging, fires, loss of power, or other conditions that may increase the likelihood of a crash or injury.

Handling the Unexpected

This chapter explains how to handle unexpected troubles.



Tools

Types of Tools..... 540

If a Tire Goes Flat

Temporarily Repairing a Flat Tire..... 541

Changing a Flat Tire..... 553

Power System Won't Start

Checking the Procedure..... 559

If the Keyless Access Remote Battery is

Weak..... 560

Emergency Power System Off..... 561

Jump Starting..... 562

Overheating

How to Handle Overheating..... 565

Indicator, Coming On/Blinking

If the Low Oil Pressure Indicator Comes
On..... 567

If the 12-Volt Battery Charging System
Indicator Comes On..... 567

If the Malfunction Indicator Lamp Comes
On or Blinks..... 568

If the Brake System Indicator (Red) Comes
On..... 568

If the Electric Power Steering (EPS) System
Indicator Comes On..... 569

If the Electric Parking Brake System
Indicator Comes On..... 569

If the Low Tire Pressure/TPMS Indicator
Comes On or Blinks..... 570

If the Transmission System Indicator Blinks
along with the Warning Message... 571

Fuses

Fuse Locations..... 572

Inspecting and Changing Fuses..... 579

Emergency Towing..... 580

**When You Cannot Unlock the Fuel Fill
Door**..... 581

When You Cannot Open the Trunk..... 582

Refueling

Refueling From a Portable Fuel Container.... 583

Types of Tools

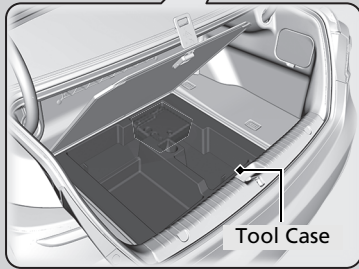

Vehicle without optional spare tire kit is shown.

Vehicles without optional spare tire kit

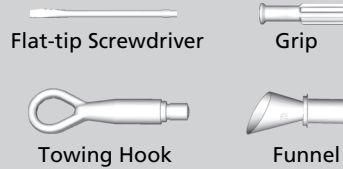

Vehicles with optional spare tire kit

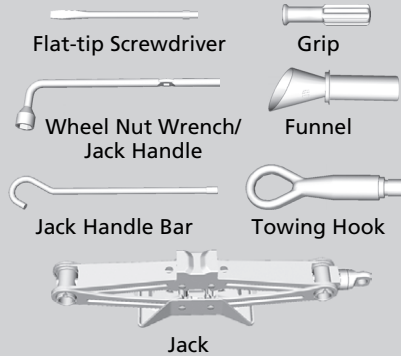

Types of Tools

The tools are stored in the trunk.

Temporarily Repairing a Flat Tire

If the tire has a large cut or is otherwise severely damaged, you will need to have the vehicle towed. If the tire only has a small puncture, from a nail for instance, you can use the temporary tire repair kit so that you can drive to the nearest service station for a more permanent repair.

If a tire goes flat while driving, grasp the steering wheel firmly, and brake gradually to reduce speed. Then stop in a safe place.

1. Park the vehicle on a firm, level, and non-slippery surface and apply the parking brake.
2. Change the gear position to **P**.
3. Turn on the hazard warning lights and set the power mode to VEHICLE OFF.

Temporarily Repairing a Flat Tire

NOTICE

Do not use a puncture-repairing agent other than the one provided in the kit that came with your vehicle. If a different agent is used, you may permanently damage the tire pressure sensor.

The kit should not be used in the following situations. Instead, contact a dealer or a roadside assistant to have the vehicle towed.

- The tire sealant has expired.
- More than one tire is punctured.
- The puncture or cut is larger than 3/16 inch (4 mm).
- The tire side wall is damaged or the puncture is outside the contact area.



When the puncture is:	Kit Use
Smaller than 3/16 inch (4 mm)	Yes
Larger than 3/16 inch (4 mm)	No

- Damage has been caused by driving with the tire extremely under inflated.
- The tire bead is no longer seated.
- The rim is damaged.

Do not remove a nail or screw that punctured the tire. If you remove it from the tire, you may not be able to repair the puncture using the kit.

■ Getting Ready to Temporarily Repair the Flat Tire

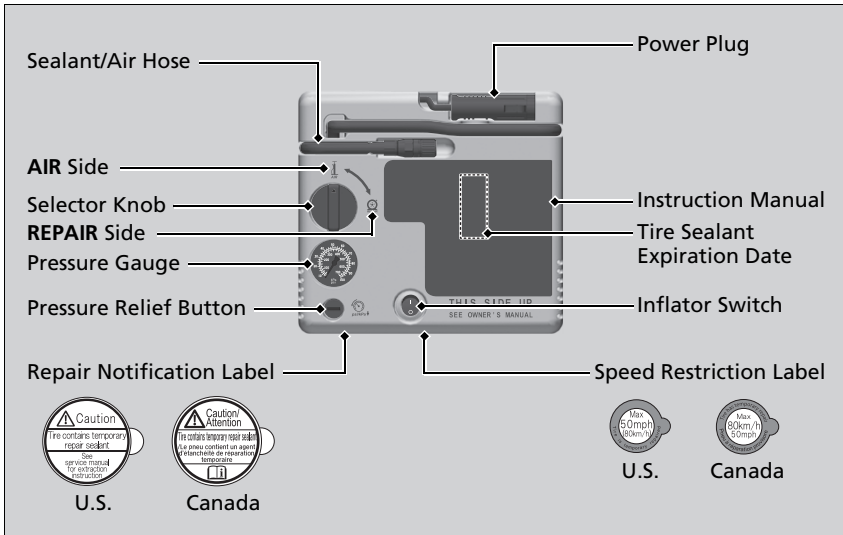

▶▶ Getting Ready to Temporarily Repair the Flat Tire

Repair notification label and speed restriction label are applied to the side of temporary tire repair kit.

When making a temporary repair, carefully read the instruction manual provided with the kit.

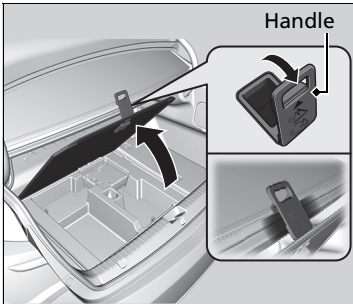

1. Pull the handle on the trunk floor lid and open the lid.
2. Hook the handle to the edge of the trunk opening.

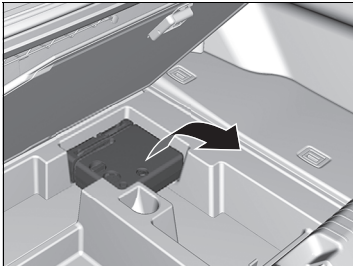

3. Take the kit out of the case.
4. Place the kit face up, on flat ground near the flat tire, and away from traffic. Do not place the kit on its side.

■ Injecting Sealant and Air

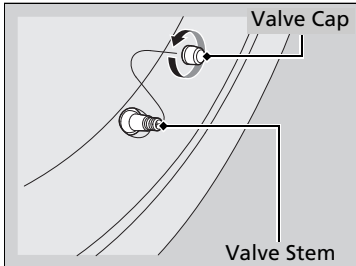

1. Remove the valve cap from the tire valve stem.

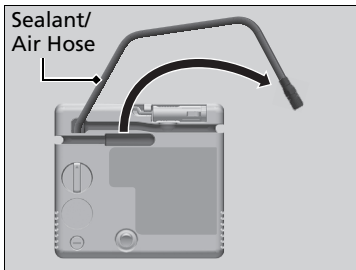

2. Remove the sealant/air hose from the packaging.

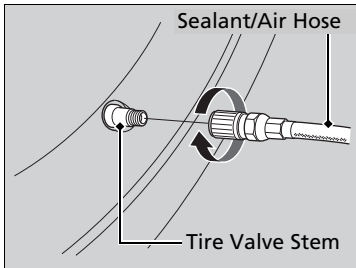

3. Attach the sealant/air hose onto the tire valve stem. Screw it until it is tight.

▶▶ Injecting Sealant and Air

⚠ WARNING

Tire sealant contains substances that are harmful and can be fatal if swallowed.

If accidentally swallowed, do not induce vomiting. Drink plenty of water and get medical attention immediately.

For skin or eye contact, flush with cool water and get medical attention if necessary.

In cold temperatures, the sealant may not flow easily. In this situation, warm it up for five minutes before using.

The sealant can permanently stain clothing and other materials. Be careful during handling and wipe away any spills immediately.

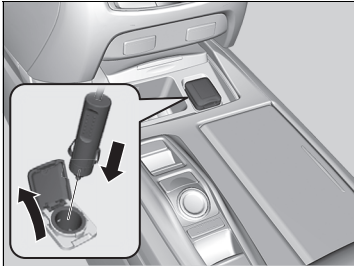

4. Plug in the compressor to the accessory power socket.
 - Be careful not to pinch the cord in a door or window.
 - Do not plug any other electronic devices into other accessory power sockets.
 5. Turn the power system on.
 - Keep the power system on while injecting sealant and air.
-  **Carbon Monoxide Gas** P. 72
6. Turn the selector knob to **REPAIR**.

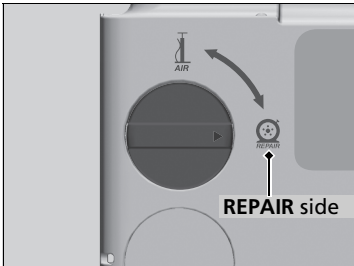

 Injecting Sealant and Air

⚠ WARNING

Running the engine with the vehicle in an enclosed or even partly enclosed area can cause a rapid build-up of toxic carbon monoxide.

Breathing this colorless, odorless gas can cause unconsciousness and even death. Only run the engine to power the air compressor with the vehicle outdoors.

NOTICE

Do not operate the temporary tire repair kit compressor for more than 15 minutes. The compressor can overheat and become permanently damaged.

There are two accessory power sockets:

- In the center pocket
 - In the console compartment
-  **Accessory Power Sockets** P. 190

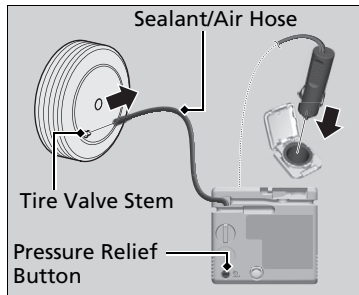
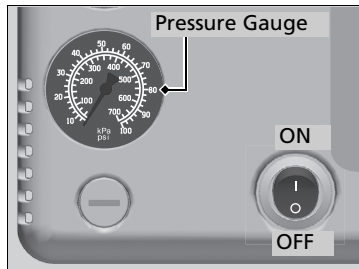

7. Press the inflator switch to turn on the compressor.
 - ▶ The compressor starts injecting sealant and air into the tire.
 - ▶ When the sealant injection is complete, continue to add air.
8. After the air pressure reaches 36 psi (250 kPa), turn off the kit.
 - ▶ To check the pressure, occasionally turn off the compressor and read the gauge.
9. Unplug the power plug from the accessory power socket.
10. Unscrew the sealant/air hose from the tire valve stem. Reinstall the valve cap.
11. Press the pressure relief button until the gauge returns to 0 psi (0 kPa).

▶▶ Injecting Sealant and Air

Until the sealant injection is complete, the pressure shown on the pressure gauge will appear higher than actual. After the sealant injection is complete the pressure will drop and then begin to rise again as the tire is inflated with air. This is normal. To accurately measure the air pressure using the gauge, turn the air compressor off only after the sealant injection is complete.

If the required air pressure is not reached within 10 minutes, the tire may be too severely damaged for the kit to provide the necessary seal and your vehicle will need to be towed.

See an Acura dealer for a replacement sealant bottle and proper disposal of an empty bottle.

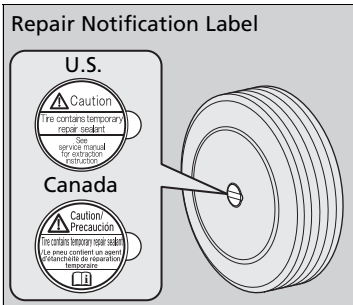

12. Apply the repair notification label to the flat surface of the wheel.
 - The wheel surface must be clean to ensure the label adheres properly.

■ Distributing the Sealant in the Tire

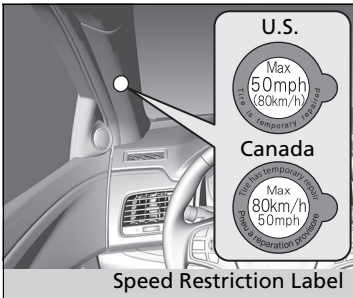

Speed Restriction Label

1. Apply the speed restriction label to the location as shown.
2. Drive the vehicle for about 10 minutes.
 - Do not exceed 50 mph (80 km/h).
3. Stop the vehicle in a safe place.

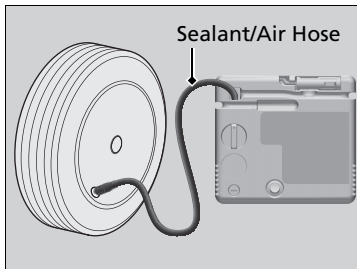

4. Recheck the air pressure using the sealant/air hose on the compressor.

5. Turn the selector knob to **AIR**.

▶ Do not turn the air compressor on to check the pressure.

➤ **Inflating an Under-inflated Tire** P. 550

6. If the air pressure is

- Less than 19 psi (130 kPa):

Do not add air or continue driving. The leak is too severe. Call for help and have your vehicle towed.

➤ **Emergency Towing** P. 580

- 36 psi (250 kPa) or more:

Continue driving for another 10 minutes or until you reach the nearest service station, whichever is sooner. Do not exceed 50 mph (80 km/h). If you have not reached a service station, stop and check the tire pressure.

▶ If the air pressure does not go down after the 10 minute driving, you do not need to check the pressure any more.



- Greater than 19 psi (130 kPa), but less than 36 psi (250 kPa):

Turn the air compressor on to inflate the tire until the tire pressure reaches 36 psi (250 kPa).

▶ **Inflating an Under-inflated Tire** P. 550

Then drive carefully for 10 more minutes or until you reach the nearest service station, whichever is sooner. Do not exceed 50 mph (80 km/h). If you have not reached a service station, stop and check the tire pressure.

▶ You should repeat this procedure as long as the air pressure is within this range.

7. Unplug the kit from the accessory power socket.
8. Unscrew the sealant/air hose from the tire valve stem. Reinstall the valve cap.
9. Press the pressure relief button until the gauge returns to 0 psi (0 kPa).
10. Repackage and properly stow the kit.

▶▶ Distributing the Sealant in the Tire

⚠ WARNING

Running the engine with the vehicle in an enclosed or even partly enclosed area can cause a rapid build-up of toxic carbon monoxide.

Breathing this colorless, odorless gas can cause unconsciousness and even death. Only run the engine to power the air compressor with the vehicle outdoors.

■ Inflating an Under-inflated Tire

You can use the kit to inflate a non-punctured under-inflated tire.

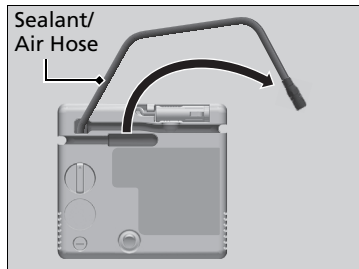

1. Open the trunk floor lid.
 ✘ Getting Ready to Temporarily Repair the Flat Tire P. 542
2. Remove the kit from the case.
3. Place the kit, face up, on flat ground near the flat tire, away from traffic. Do not place the kit on its side.
4. Remove the sealant/air hose from the kit.
5. Remove the valve cap.

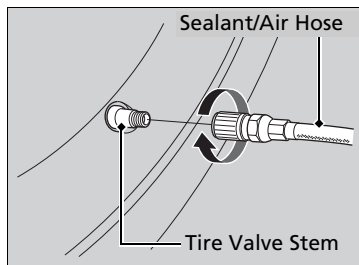
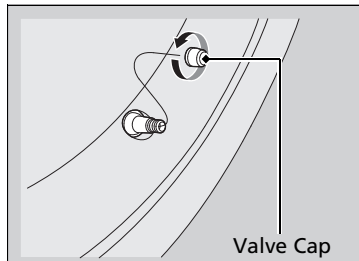

6. Attach the sealant/air hose onto the tire valve stem. Screw it until it is tight.

▶▶ Inflating an Under-inflated Tire

NOTICE

Do not operate the temporary tire repair kit compressor for more than 15 minutes. The compressor can overheat and become permanently damaged.

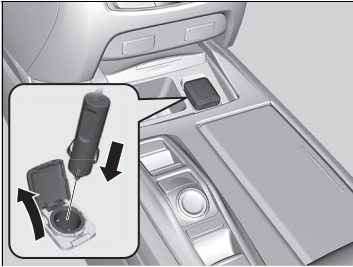

7. Plug in the kit to the accessory power socket.
 - ▶ Be careful not to pinch the cord in a door or window.
 - ▶ Do not plug any other electronic devices into other accessory power sockets.
- **Accessory Power Sockets** P. 190
8. Turn the power system on.
 - ▶ Keep the power system on while injecting air.
- **Carbon Monoxide Gas** P. 72



9. Turn the selector knob to **AIR**.
10. Press the inflator switch to turn on the kit.
 - ▶ The compressor starts to inject air into the tire.
11. Inflate the tire to the specified air pressure.

▶▶ Inflating an Under-inflated Tire

⚠ WARNING

Running the engine with the vehicle in an enclosed or even partly enclosed area can cause a rapid build-up of toxic carbon monoxide.

Breathing this colorless, odorless gas can cause unconsciousness and even death. Only run the engine to power the air compressor with the vehicle outdoors.

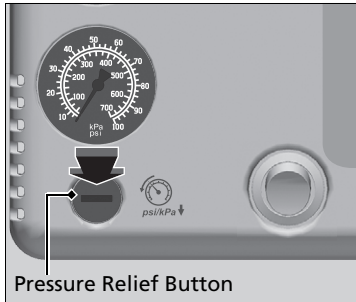

- 12.** Turn off the kit.
 - ▶ Check the pressure gauge on the air compressor.
 - ▶ If overinflated, press the pressure relief button.
- 13.** Unplug the kit from the accessory power socket.
- 14.** Unscrew the sealant/air hose from the tire valve stem. Reinstall the valve cap.
- 15.** Press the pressure relief button until the gauge returns to 0 psi (0 kPa).
- 16.** Repackage and properly stow the kit.

Vehicles with optional spare tire kit

Changing a Flat Tire

If a tire goes flat while driving, grasp the steering wheel firmly, and brake gradually to reduce speed. Then, stop in a safe place. Replace the flat tire with a compact spare tire. Go to a dealer as soon as possible to have the full-size tire repaired or replaced.

1. Park the vehicle on firm, level, and non-slippery surface, and apply the parking brake.
2. Change the gear position to **P**.
3. Turn on the hazard warning lights and set the power mode to VEHICLE OFF.

Changing a Flat Tire

NOTICE

Do not use an unapproved puncture-repairing agent on a flat tire, as it can damage the tire pressure sensor.

NOTICE

Do not use the jack if it doesn't work properly. Call your dealer or a professional towing service.

Follow compact spare precautions:

Periodically check the tire pressure of the compact spare. It should be set to the specified pressure.

Specified Pressure: 60 psi (420 kPa, 4.2 kgf/cm²)

When driving with the compact spare tire, keep the vehicle speed under 50 mph (80 km/h). Replace with a full-size tire as soon as possible.

The compact spare tire and wheel in your vehicle are specifically for this model. Do not use them with another vehicle. Do not use another type of compact spare tire or wheel with your vehicle.

Do not mount tire chains on a compact spare tire.

If a chain-mounted front tire goes flat, remove one of the full-size rear tires and replace it with the compact spare tire. Remove the flat front tire and replace it with the full-size tire that was removed from the rear. Mount the tire chains on the front tire.

Continued

■ Getting Ready to Replace the Flat Tire

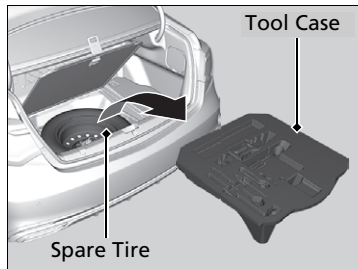

1. Open the trunk floor lid.
 - **Temporarily Repairing a Flat Tire** P. 541
2. Take the tool case out of the trunk. Take the jack and wheel nut wrench out of the tool case.
3. Unscrew the wing bolt, and remove the spacer cone. Then, remove the spare tire.

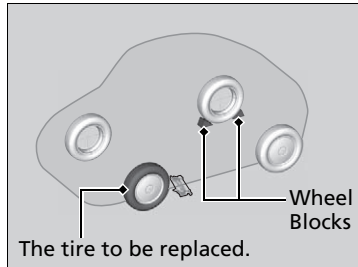

4. Place a wheel block or rock in front and rear of the wheel diagonal to the flat tire.

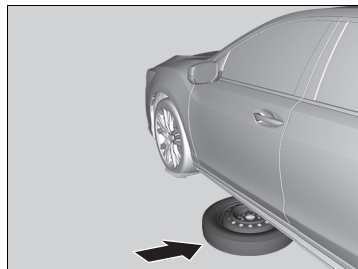

5. Place the compact spare tire (wheel side up) under the vehicle body, near the tire that needs to be replaced.



6. Loosen each wheel nut about one turn using the wheel nut wrench.

How to Set Up the Jack

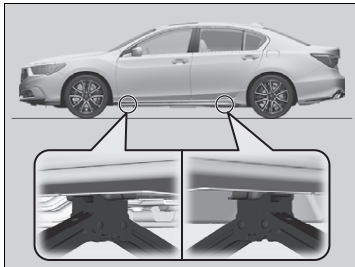

1. Place the jack under the jacking point closest to the tire to be changed.

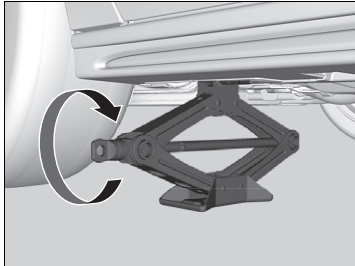

2. Turn the end bracket clockwise as shown in the image until the top of the jack contacts the jacking point.

▶ Make sure that the jacking point tab is resting in the jack notch.

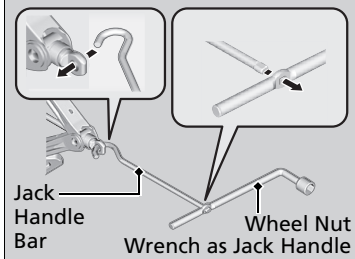

3. Raise the vehicle, using the jack handle bar and the jack handle, until the tire is off the ground.

How to Set Up the Jack

⚠ WARNING

The vehicle can easily roll off the jack, seriously injuring anyone underneath.

Follow the directions for changing a tire exactly, and no person should place any portion of their body under a vehicle that is supported by a jack.

Do not use the jack with people or luggage in the vehicle.

Use the jack provided in your vehicle. Other jacks may not support the weight ("load") or may not fit the jacking point.

The following instructions must be followed to use the jack safely:

- Do not use while the power system is on.
- Use only where the ground is firm and level.
- Use only at the jacking points.
- Do not get in the vehicle while using the jack.
- Do not put anything on top of or underneath the jack.

Replacing the Flat Tire



1. Remove the wheel nuts and flat tire.

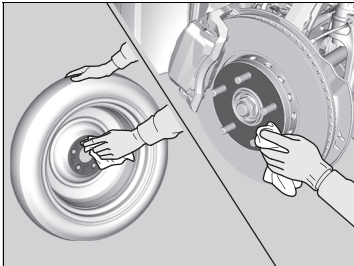

2. Wipe the mounting surfaces of the wheel with a clean cloth.

3. Mount the compact spare tire.

4. Screw the wheel nuts until they touch the lips around the mounting holes, then stop rotating.

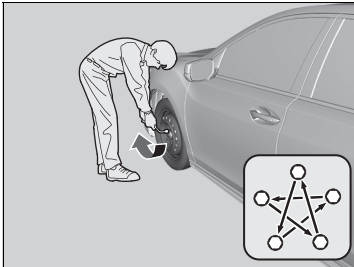

5. Lower the vehicle and remove the jack. Tighten the wheel nuts in the order indicated in the image. Go around, tightening the nuts, two to three times in this order.

Wheel nut torque:

94 lbf·ft (127 N·m, 13 kgf·m)

Replacing the Flat Tire

Do not over tighten the wheel nuts by applying extra torque using your foot or a pipe.

■ Storing the Flat Tire

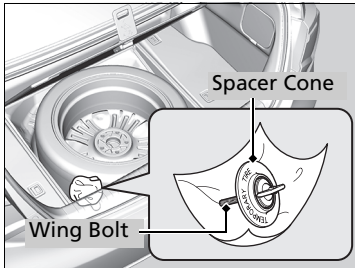

1. Place the flat tire face down in the spare tire well.
2. Wrap the spacer cone and spare tire wing bolt with cloth or paper, and store them in the spare tire well.
3. Store the jack and tools in the tool case. Place the tool case and the trunk floor lid on the flat tire.
4. Close the trunk.

■ TPMS and the Compact Spare Tire

If you replace a flat tire with the spare tire, the low tire pressure/TPMS indicator comes on while you are driving. After driving for a few miles (kilometers), **Tire Pressure Monitor Problem** will appear on the multi-information display and the indicator will start blinking for a short time and then stay on; however, this is normal and is no cause for concern.

If you replace the tire with a full-size tire, the warning message on the multi-information display and the low tire pressure/TPMS indicator will go off after a few miles (kilometers).

▶▶ Storing the Flat Tire

⚠ WARNING

Loose items can fly around the interior in a crash and can seriously injure the occupants.

Store the wheel, jack, and tools securely before driving.

▶▶ TPMS and the Compact Spare Tire

The system cannot monitor the pressure of the spare tire. Manually check the spare tire pressure to be sure that it is correct.

Use the TPMS specific wheels. Each is equipped with a tire pressure sensor mounted inside the tire behind the valve stem.

Checking the Procedure

When the **READY** indicator does not come on and the **Ready To Drive** message does not appear on the multi-information display, check the following items and take appropriate action.

☒ Checking the Procedure

If you must start the vehicle immediately, use an assisting vehicle or booster battery to jump start it.

☒ **Jump Starting** P. 562

Checklist	Condition	What to Do
Check if the related indicator or multi-information display messages come on.	The Temperature Is Too Cold For Vehicle To Operate message appears.	☒ Multi-Information Display Warning and Information Messages P. 94
	The To Start, Hold Remote Near Start Button message appears. ▶ Make sure the keyless access remote is in its operating range. ☒ POWER Button Operating Range P. 152	☒ If the Keyless Access Remote Battery is Weak P. 560
	The POWER SYSTEM indicator comes on. The transmission system indicator blinks and Transmission Problem Apply Parking Brake When Parked message appears.	Have your vehicle checked by a dealer. The power system can be activated as a temporary measure. ☒ If the Transmission System Indicator Blinks along with the Warning Message P. 571
Check the brightness of the interior lights.	The interior lights are dim or do not come on at all.	Have the 12-volt battery checked by a dealer.
	The interior lights come on normally.	Check all fuses, or have your vehicle checked by a dealer. ☒ Inspecting and Changing Fuses P. 579
Check the gear position.	The transmission is not in P .	Change the gear position to P .
Check the immobilizer system indicator.	When the immobilizer system indicator is blinking, the power system cannot be turned on.	☒ Immobilizer System Indicator P. 87

If the Keyless Access Remote Battery is Weak

If the beeper sounds, the **To Start, Hold Remote Near Start Button** message appears on the multi-information display, the **POWER** button flashes, and the **READY** indicator does not come on, turn on the power system as follows:

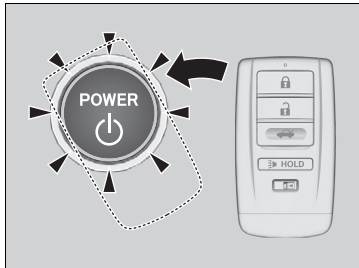

1. Touch the center of the **POWER** button with the **A** logo on the keyless access remote while the **POWER** button is flashing. The buttons on the keyless access remote should be facing you.
 - ▶ The **POWER** button flashes for about 30 seconds.

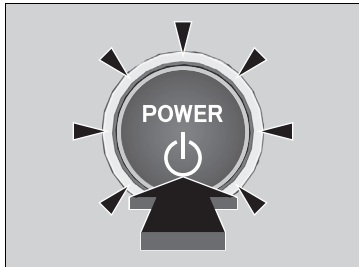

2. Depress the brake pedal and press the **POWER** button within 10 seconds after the beeper sounds and the **POWER** button changes from flashing to on.
 - ▶ If you do not depress the pedal, the mode will change to ACCESSORY.

Emergency Power System Off

The **POWER** button may be used to turn the power system off due to an emergency situation even while driving. If you must turn the power system off, do either of the following operations:

- Press and hold the **POWER** button for about two seconds.
- Firmly press the **POWER** button three times.

The steering wheel will not lock. However, because turning off the engine disables the power assist the engine provides to the steering and braking systems, it will require significantly more physical effort and time to steer and slow the vehicle. Use both feet on the brake pedal to slow down the vehicle and stop immediately in a safe place.

The gear position automatically changes to **P** after the vehicle comes to a complete stop. Then, the power mode changes to VEHICLE OFF.

⚠ Emergency Power System Off

Do not press the button while driving unless it is absolutely necessary for the power system to be turned off.

Jump Starting Procedure

Turn off the power to electric devices, such as audio and lights. Turn off the power system, then open the hood.

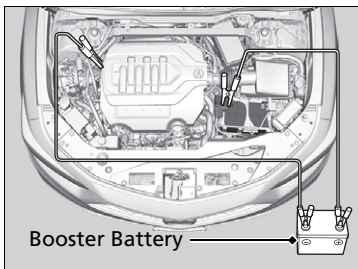
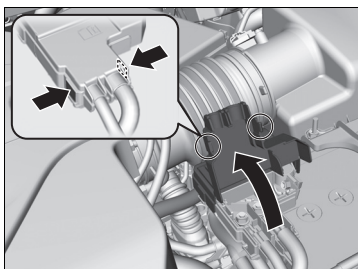

1. Open the fuse box cover on your vehicle's 12-volt battery positive \oplus terminal.

2. Connect the first jumper cable to your vehicle's 12-volt battery \oplus terminal.

3. Connect the other end of the first jumper cable to the booster battery \oplus terminal.

▶ If you use a booster battery, only use a 12-volt booster battery.

▶ When using an automotive battery charger, select a charging voltage lower than 15-volts. Check the charger manual for the proper setting.

4. Connect the second jumper cable to the booster battery \ominus terminal.

Jump Starting

⚠ WARNING

A 12-volt battery can explode if you do not follow the correct procedure, seriously injuring anyone nearby.

Keep all sparks, open flames, and smoking materials away from the 12-volt battery.

Securely attach the jumper cable clips so that they do not come off when the engine vibrates. Also be careful not to tangle the jumper cables or allow the cable ends to touch each other while attaching or detaching the jumper cables.

Battery performance degrades in cold conditions and may prevent the engine from starting.

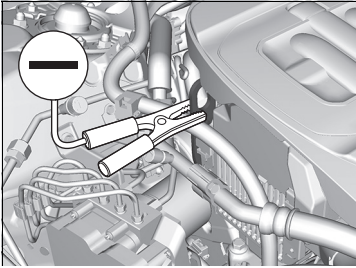

5. Connect the other end of the second jumper cable to the engine hanger as shown. Do not connect this jumper cable to any other part.
6. If your vehicle is connected to another vehicle, start the assisting vehicle's engine and increase its rpm slightly.
7. Attempt to start your vehicle's engine. If it turns over slowly, check that the jumper cables have good metal-to-metal contact.

■ What to Do After the Engine Starts

Once your vehicle's engine has started, remove the jumper cables in the following order.

1. Disconnect the jumper cable from your vehicle's ground.
2. Disconnect the other end of the jumper cable from the booster battery ⊖ terminal.
3. Disconnect the jumper cable from your vehicle's 12-volt battery ⊕ terminal.
4. Disconnect the other end of the jumper cable from the booster battery ⊕ terminal.

Have your vehicle inspected by a nearby service station or a dealer.

How to Handle Overheating

Overheating symptoms are as follows:

- The high temperature indicator comes on or the engine suddenly loses power.
- Steam or spray comes out of the engine compartment.

■ First thing to do

1. Immediately park the vehicle in a safe place.
 - ▶ Change the gear position to **P** and set the parking brake.
2. Turn off all accessories and turn on the hazard warning lights.
 - ▶ **No steam or spray present:** Keep the power system on and open the hood.
 - ▶ **Steam or spray is present:** Turn off the power system and wait until it subsides. Then open the hood.

☒ How to Handle Overheating

⚠ WARNING

Steam and spray from an overheated engine can seriously scald you.

Do not open the hood if steam is coming out.

NOTICE

Continuing to drive with the high temperature indicator on may damage the engine.

Continued

■ Next thing to do

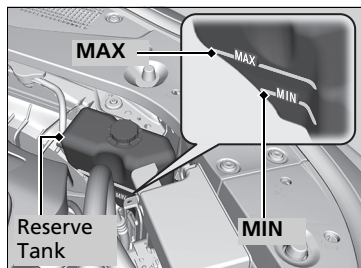

1. Check that the cooling fan is operating and turn the power system off once the high temperature indicator goes off.
 - If the cooling fan is not operating, immediately turn the power system off.
2. Once the engine has cooled down, inspect the coolant level and check the cooling system components for leaks.
 - If the coolant level in the reserve tank is low, add coolant until it reaches the **MAX** mark.
 - If there is no coolant in the reserve tank, check that the radiator is cool. Cover the radiator cap with a heavy cloth and open the cap. If necessary, add coolant up to the base of the filler neck, and put the cap back on.

➤ **Radiator** P. 510

■ Last thing to do

Once the engine has cooled sufficiently, turn the power system on and check the high temperature indicator. If the high temperature indicator is off, resume driving. If it stays on, contact a dealer for repairs.

► How to Handle Overheating

⚠ WARNING

Removing the radiator cap while the engine is hot can cause the coolant to spray out, seriously scalding you.

Always let the engine and radiator cool down before removing the radiator cap.

If the coolant is leaking, contact a dealer for repairs.

Use water as an emergency/temporary measure only. Have a dealer flush the system with proper antifreeze as soon as possible.

If the Low Oil Pressure Indicator Comes On



■ Reasons for the indicator to come on

Comes on when the engine oil pressure is low.

■ What to do as soon as the indicator comes on

1. Immediately park the vehicle on level ground in a safe place.
2. If necessary, turn the hazard warning lights on.

■ What to do after parking the vehicle

1. Turn the power system off and let it sit for about three minutes.
2. Open the hood and check the oil level.
 - ▶ **Oil Check** P. 505
3. Turn the power system on and check the low oil pressure indicator.
 - ▶ The indicator goes off: Start driving again.
 - ▶ The indicator does not go off within 10 seconds: Turn the power system off and contact a dealer for repairs immediately.

If the 12-Volt Battery Charging System Indicator Comes On



■ Reasons for the indicator to come on

Comes on when the 12-volt battery is not being charged.

■ What to do when the indicator comes on

Turn off the climate control system, rear defogger, and other electrical systems, and immediately contact a dealer for repairs.

☒ If the Low Oil Pressure Indicator Comes On

NOTICE

Running the engine with low oil pressure can cause serious mechanical damage almost immediately.

☒ If the 12-Volt Battery Charging System Indicator Comes On

If you need to stop temporarily, do not turn off the power system. Restarting the power system may rapidly discharge the battery.

If the Malfunction Indicator Lamp Comes On or Blinks



■ Reasons for the indicator lamp to come on or blink

- Comes on when there is a problem with the engine emissions control system.
- Blinks when engine misfiring is detected.

■ What to do when the indicator lamp comes on

Avoid high speeds and immediately get your vehicle inspected at a dealer.

■ What to do when the indicator lamp blinks

Park the vehicle in a safe place with no flammable items and wait at least 10 minutes or more with the engine stopped until it cools.

▶▶ If the Malfunction Indicator Lamp Comes On or Blinks

NOTICE

If you drive with the malfunction indicator lamp on, the emissions control system and the engine could be damaged.

If the malfunction indicator lamp blinks again when restarting the engine, drive to the nearest dealer at 31 mph (50 km/h) or less. Have your vehicle inspected.

If the Brake System Indicator (Red) Comes On

■ Reasons for the indicator to come on

- The brake fluid is low.
- There is a malfunction in the brake system.

■ What to do when the indicator comes on while driving

Depress the brake pedal lightly to check pedal pressure.

- If normal, check the brake fluid level the next time you stop.
- If abnormal, take immediate action. If necessary, downshift the transmission to slow the vehicle using regenerative braking.

▶▶ If the Brake System Indicator (Red) Comes On

Have your vehicle repaired immediately. It is dangerous to drive with low brake fluid. If there is no resistance from the brake pedal, stop immediately in a safe place. If necessary, downshift the gears.

If the brake system indicator and **ABS** indicator come on simultaneously, the electronic brake distribution system is not working. This can result in vehicle instability under sudden braking. Have your vehicle inspected by a dealer immediately.

If both red and amber brake system indicators come on, stop the vehicle in a safe place and have it inspected by a dealer immediately.



Canada



If the Electric Power Steering (EPS) System Indicator Comes On



■ Reasons for the indicator to come on

- Comes on when there is a problem with the EPS system.
- If you depress the accelerator pedal repeatedly to increase the engine speed while the engine is idling, the indicator comes on, and sometimes the steering wheel becomes harder to operate.

■ What to do when the indicator comes on

Stop the vehicle in a safe place and turn on the power system again.

If the indicator comes on and stays on, immediately have your vehicle inspected by a dealer.

If the Electric Parking Brake System Indicator Comes On



■ Reasons for the indicator to come on

Comes on when there is a problem with the electric parking brake system.

■ What to do when the indicator comes on

Avoid using the parking brake and immediately get your vehicle inspected at a dealer.

■ What to do when the electric parking brake indicator comes on or blinks at the same time.

- Release the parking brake. If you cannot release it, immediately stop the vehicle in a safe place and call a dealer.
- If only the electric parking brake indicator goes off, immediately get your vehicle inspected at a dealer.
- If the electric parking brake indicator remains on or blinks even after releasing the parking brake, immediately stop the vehicle in a safe place and call a dealer.

If the Low Tire Pressure/TPMS Indicator Comes On or Blinks



■ Reasons for the indicator to come on or blink

A tire pressure is significantly low. If there is a problem with the TPMS or the compact spare tire* is installed, the indicator blinks for about one minute, and then stays on.

■ What to do when the indicator comes on

Drive carefully and avoid abrupt cornering and hard braking.

Stop your vehicle in a safe place. Check the tire pressure and adjust the pressure to the specified level. The specified tire pressure is on a label on the driver's side doorjamb.

■ What to do when the indicator blinks, then remains on

Have the tire inspected by a dealer as soon as possible. If the compact spare tire* causes the indicator to blink, change the tire to a full-size tire. The indicator goes off after driving for a few miles (kilometers).

▶▶ If the Low Tire Pressure/TPMS Indicator Comes On or Blinks

NOTICE

Driving on an extremely underinflated tire can cause it to overheat. An overheated tire can fail. Always inflate your tires to the prescribed level.

If the Transmission System Indicator Blinks along with the Warning Message



■ Reasons for the indicator to blink

The transmission is malfunctioning.

■ What to do when the indicator blinks

- Immediately have your vehicle inspected by a dealer.
 - Change the gear position to **[N]** after you turn the power system on.
 - ▶ Check if the **[N]** position in the instrument panel and the indicator on the **[N]** button light/blink.
 - ▶ The power system cannot be turned on unless the parking brake is set.
- **Turning on the Power** P. 378

ⓘ If the Transmission System Indicator Blinks along with the Warning Message

You may not be able to turn on the power system.

Make sure to set the parking brake when parking your vehicle.

Call a professional towing service if you need to tow your vehicle.

➤ **Emergency Towing** P. 580

Fuse Locations

If any electrical devices are not working, set the power mode to VEHICLE OFF and check to see if any applicable fuse is blown.

Engine Compartment Fuse Box

There are four fuse boxes in the engine compartment.

Fuse locations are shown on the fuse box cover. Locate the fuse in question by the fuse number and box cover number.

Located near the brake fluid reserve tank. Push the tabs to open the box.

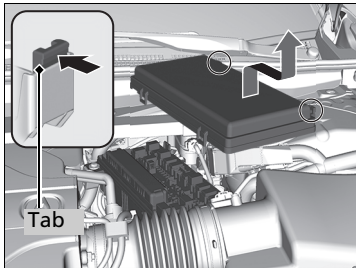

■ Circuit protected and fuse rating

	Circuit Protected	Amps
1	IG1A ACG FR	15 A
2	IG1A MISS SOL1	10 A
3	–	–
4	–	–
5	SMART	7.5 A
6	IG1B ECU FR	7.5 A
7	IG1B OP FR	7.5 A
8	IGP2	15 A
9	DBW	15 A
10	IGP	15 A
11	IG Coil	15 A
12	ACM	20 A
13	Headlight Washer*	(30 A)
14	Interior Lights	10 A
15	Back Up Radio	10 A
16	Back Up	10 A
17	AFP	10 A
18	Front Washer	15 A
19	Stop	7.5 A
20	Right Headlight High Beam	10 A
21	Trunk	10 A
22	Small	15 A
23	Front Fog Lights*	(7.5 A)
24	Left Headlight High Beam	10 A
25	IMA Motor	15 A

	Circuit Protected	Amps
26	Right Headlight Low Beam	15 A
27	Left Headlight Low Beam	15 A
28	IGP2 Sub	7.5 A
29	Power Rear Sunshade*	(20 A)
30	Heated Windshield	20 A
31	Wiper	30 A

Located near the 12-volt battery. Push the tabs to open the box.

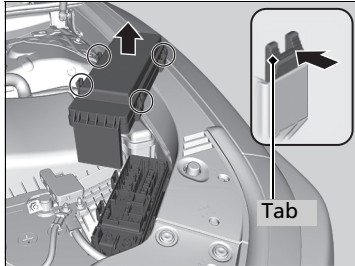

■ **Circuit protected and fuse rating**

	Circuit Protected	Amps
1	Main Fuse	200 A
	–	(40 A)
2	Rear Defroster	40 A
	DR F/B Main 1	60 A
	AS F/B Main 1	60 A
	R/B Main 3	50 A
	AS F/B Main 2	60 A
	ABS/VSA RLY	30 A
	Heater Motor	40 A
	R/B Main 1	60 A
	ESB	40 A
	IG Main	60 A
3	DR F/B Main 2	60 A
	SBW	60 A
	R/B Main 2	60 A
	Horn & Hazard	20 A
	ABS/VSA Motor	40 A
4	EOP	30 A
5	Left Electric Parking Brake	30 A
6	Right Electric Parking Brake	30 A
7	Injector	20 A
8	Hazard	15 A
9	IGA 2	7.5 A
10	–	–
11	Horn	10 A

Located near the ⊕ terminal on the 12-volt battery. Push the tabs to open the box.

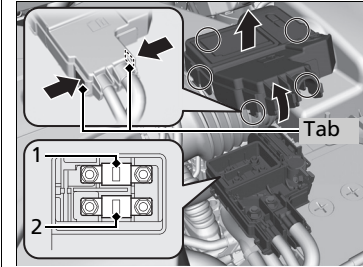

■ **Circuit protected and fuse rating**

	Circuit Protected	Amps
1	Radiator Fan	50 A
2	EPS	80 A

Located inside the left side of the front bumper. Use the following procedure to reach the box.

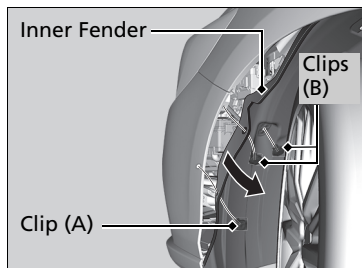

1. Turn the steering wheel all the way to the right.
2. Remove the holding clips (A) and (B) by inserting a flat-tip screwdriver and lifting the center pins up.
 - ▶ Make sure to reinstall the clips after inspecting the fuses.
 - ▶ To reinstall the clips, insert them with the center pins raised, and push until they are flat.

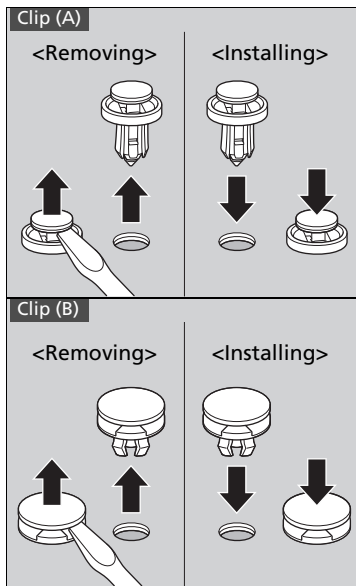

3. Pull the inner fender back.
4. Pull the lock tab to the direction shown in the image and pull out the fuse box.

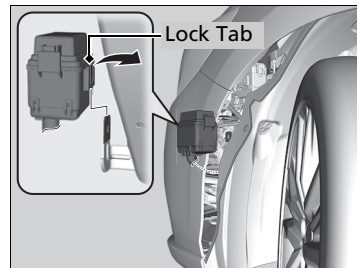

Push the tabs to remove the cover.

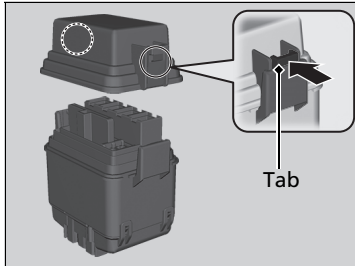

■ **Circuit protected and fuse rating**

	Circuit Protected	Amps
1	HCA 1	20 A
2	TCU	30 A
3	HCA 2	20 A
4	STRG MOVE 1	20 A
5	–	–
6	–	–

■ Driver's Side Interior Fuse Box

There are two fuse boxes in the driver's side.

Located under the dashboard.

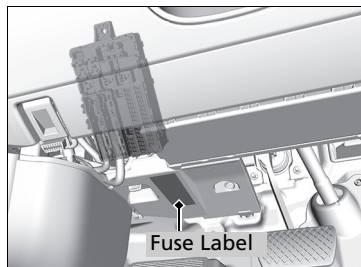

Fuse locations are shown on the label on the under panel.

Locate the fuse in question by the fuse number and label number.

■ Circuit protected and fuse rating

	Circuit Protected	Amps
1	Driver's Side Door Lock	10 A
2	Passenger's Side Door Lock	10 A
3	Driver's Door Lock	10 A
4	Driver's Side Door Unlock	10 A
5	Passenger's Side Door Unlock	10 A
6	Driver's Door Unlock	10 A
7	Door Lock	20 A
8	–	–
9	Power System 1	10 A
10	IG1 DR1	7.5 A
11	Meter	10 A
12	Passenger's Side Fuse Box	20 A
13	ACCESSORY	7.5 A
14	–	–
15	Driver's Power Seat Sliding	20 A
16	Moonroof	20 A
17	Rear Driver's Side Power Window	20 A
18	STRG MOVE 2	20 A
19	Driver's Power Window	20 A
20	Power System 2	15 A
21	Fuel Pump	20 A
22	Power System 2	7.5 A
23	Starter Cut	7.5 A
24	IG1 DR2	7.5 A

	Circuit Protected	Amps
25	Start DIAG	7.5 A
26	Air Conditioning	7.5 A
27	Daytime Running Lights	7.5 A
28	ACC Key Lock	7.5 A
29	Driver's Lumbar Support	7.5 A
30	SMART	10 A
31	–	–
32	Driver's Power Seat Reclining	20 A
33	Left e-pretensioner	(20 A)
34	IG1 Box	30 A

Located inside the driver's side outer panel. When you remove the outer panel, use the following procedure.

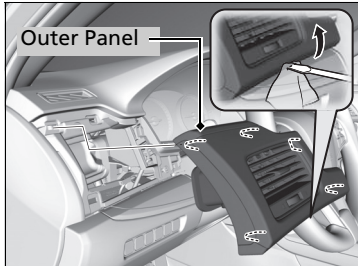

1. Pry on the lower edge of the panel using a flat-tip screwdriver.
 - Wrap the flat-tip screwdriver with a cloth to prevent scratches.
2. Pull the outer panel towards you, then remove it.

Fuse locations are shown on the image below.

Locate the fuse in question by the fuse number in the image and chart.

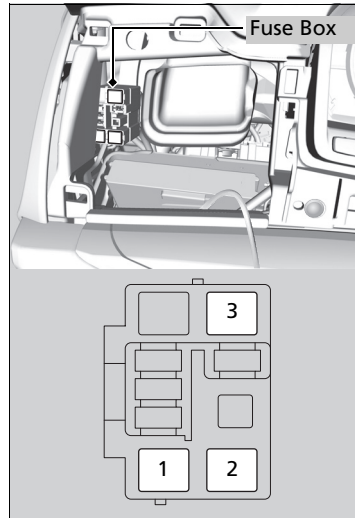

■ **Circuit protected and fuse rating**

	Circuit Protected	Amps
1	IG Main 2	30 A
2	ST MG	30 A
3	IG Main 1	30 A

■ **Passenger's Side Interior Fuse Box**

Located on the lower side panel. Take off the cover to open.

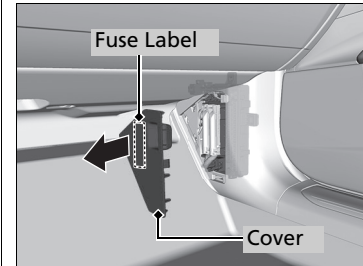

Fuse locations are shown on the cover.

■ **Circuit protected and fuse rating**

	Circuit Protected	Amps
1	–	–
2	Front Seat Heaters/AVS*	20 A
3	Rear Passenger's Side Power Window	20 A
4	Front Passenger's Lumbar Support	7.5 A
5	Daytime Running Lights	7.5 A
6	A/C Water Pump	10 A
7	Passenger's Power Seat Sliding	20 A
8	Passenger's Power Seat Reclining	20 A
9	Rear Seat Heaters	20 A
10	–	–
11	Fly Start	15 A
12	Accessory Power Socket (Console Compartment)	20 A
13	Accessory Power Socket (Center Pocket)	20 A
14	AS ECU	7.5 A
15	Glove Box	7.5 A
16	–	–
17	–	–
18	Front Passenger's Power Window	20 A
19	SRS1	10 A

	Circuit Protected	Amps
20	ABS/VSA	7.5 A
21	BATT ECU	7.5 A
22	e-pretensioner	7.5 A
23	–	–
24	SRS2	7.5 A
25	Illumination	7.5 A
26	Right e-pretensioner	20 A
27	Heated Steering Wheel	10 A
28	Audio AMP	30 A* ¹ 40 A* ²

*1: Models without surround view camera system

*2: Models with surround view camera system

Inspecting and Changing Fuses

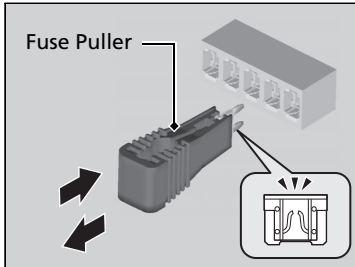
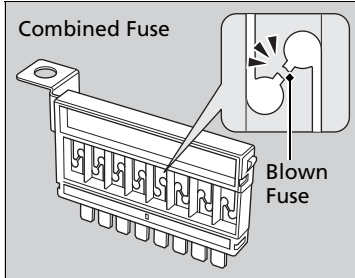
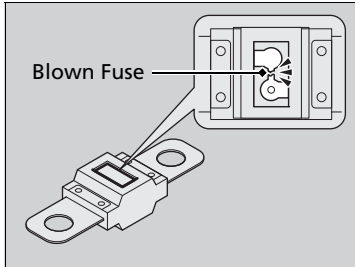

1. Set the power mode to VEHICLE OFF. Turn headlights and all accessories off.
2. Remove the fuse box cover.
3. Check the large fuse in the engine compartment.
 - ▶ If the fuse is blown, use a Phillips-head screwdriver to remove the screw and replace it with a new one.

4. Inspect the small fuses in the engine compartment and the vehicle interior.
 - ▶ If there is a blown fuse, remove it with the fuse puller and replace it with a new one.

Inspecting and Changing Fuses

NOTICE

Replacing a fuse with one that has a higher rating greatly increases the chances of damaging the electrical system.

Replace fuse with a spare fuse of the same specified amperage.

Confirm the specified amperage using the charts on P. 572 to 577.

There is a fuse puller in the engine compartment fuse box located near the brake fluid reserve tank.

Call a professional towing service if you need to tow your vehicle.

■ Flat bed equipment

The operator loads your vehicle on the back of a truck.

This is the only way you can safely transport your vehicle.

Any other towing method will damage the vehicle's drive system.

» Emergency Towing

NOTICE

Trying to lift or tow your vehicle by the bumpers will cause serious damage. The bumpers are not designed to support the vehicle's weight.

NOTICE

Improper towing such as towing behind a motorhome or other motor vehicle can damage the transmission.

Never tow your vehicle with just a rope or chain. It is very dangerous since ropes or chains may shift from side to side or break.

When You Cannot Unlock the Fuel Fill Door

What to Do When Unable to Unlock the Fuel Fill Door

If you cannot unlock the fuel fill door, use the following procedure.

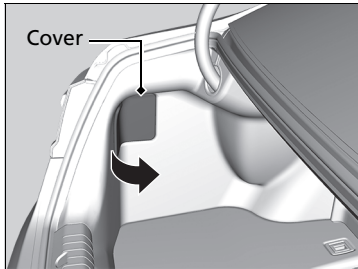

1. Open the trunk and remove the cover.

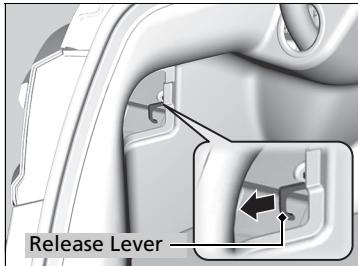

2. Pull the release lever toward you.
 - ▶ The release lever unlocks the fuel fill door when it is pulled.

When You Cannot Unlock the Fuel Fill Door

After taking these steps, contact a dealer to have your vehicle checked.

What to Do When Unable to Open the Trunk

If you cannot open the trunk, use the following procedure.

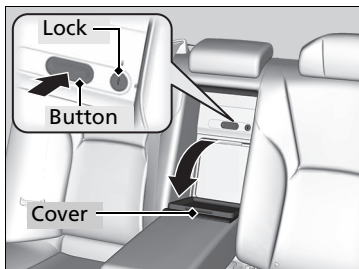

1. Pull the rear seat armrest down.
2. Push the button to open the cover.
 - ▶ The cover latches when you push it back to the original position.
 - ▶ You can lock and unlock this cover using the built-in key.

To lock the cover: Insert the key to the lock, then turn it the right.

To unlock the cover: Insert the key to the lock, then turn it the left.

3. With pulling the inner partition up, pull the trunk release handle down to the direction of the arrow in the image.

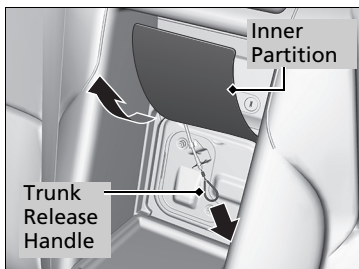

What to Do When Unable to Open the Trunk

Following up:

After taking these steps, contact a dealer to have your vehicle checked.

Refueling From a Portable Fuel Container

If you have run out of fuel and need to refuel your vehicle from a portable fuel container, use the funnel provided with your vehicle.

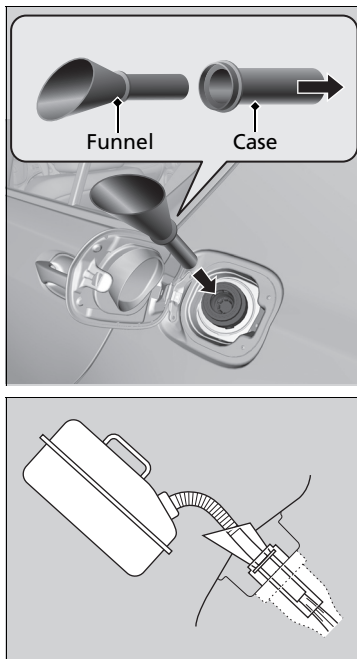

1. Turn off the power system.
2. Press the fuel fill door release button.
 - ▶ The fuel fill door opens.
3. Take the funnel out of the tool case in the trunk.
 - ▶ **Types of Tools** P. 540
4. Remove the **funnel from the case**.
5. Place the end of the funnel on the lower part of filler opening, then insert it slowly and fully.
 - ▶ Make sure that the end of the funnel goes down along with the filler pipe.
6. Fill the tank with fuel from the portable fuel container.
 - ▶ Pour fuel carefully so you do not spill any.
7. Remove the funnel from the filler neck.
 - ▶ Wipe up any fuel from the funnel before storing it.
8. Shut the fuel fill door by hand.

Refueling From a Portable Fuel Container

WARNING

Gasoline is highly flammable and explosive. You can be burned or seriously injured when handling fuel.

- Turn the power system off, and keep heat, sparks, and flame away.
- Handle fuel only outdoors.
- Wipe up spills immediately.

NOTICE

Do not insert the nozzle of a portable fuel container or any funnel other than the one provided with your vehicle. Doing so can damage the fuel system. Do not try to pry open or push open the sealed fuel tank with foreign objects. This can damage the fuel system and its seal.

Make sure the fuel in the portable fuel container is gasoline before you refuel.

Information

This chapter includes your vehicle's specifications, locations of identification numbers, and other information required by regulation.

Specifications	586
Identification Numbers	
Vehicle Identification Number (VIN), Engine Number, Motor Number, and Transmission Number.....	588
Devices that Emit Radio Waves	589
Reporting Safety Defects	590
Emissions Testing	
Testing of Readiness Codes.....	591
Warranty Coverages	593
Authorized Manuals	595
Client Service Information	596

■ Vehicle Specifications

Model	RLX
No. of Passengers:	
Front	2
Rear	3
Total	5
Weights:	
Gross Vehicle Weight Rating	See the certification label on the driver's doorjamb
Gross Axle Weight Rating (Front)	See the certification label on the driver's doorjamb
Gross Axle Weight Rating (Rear)	See the certification label on the driver's doorjamb

■ Air Conditioning

Refrigerant Type	HFC-134a (R-134a)
Charge Quantity	15.3 - 17.1 oz (435 - 485 g)
Lubricant Type	ND-OIL 11
Quantity	7.9 - 8.8 cu-in (130.0 - 145.0 cm ³)

■ Engine Specifications

Displacement	212 cu-in (3,471 cm ³)
Spark Plugs	NGK DILZKR7B11G

■ Fuel

Type	Unleaded premium gasoline, Pump octane number of 91 or higher
Fuel Tank Capacity	15.2 US gal (57 L)

■ Washer Fluid

Tank Capacity	U.S.: 2.6 US qt (2.5 L) Canada: 5.3 US qt (5.0 L)
---------------	--

■ Light Bulbs

Headlights (Low Beam)	LED
Headlights (High Beam)	LED
Fog Lights ^{*1}	LED
Front Turn Signal Lights	LED
Parking/Daytime Running Lights	LED
Front Side Marker Lights	LED
Side Turn Signal Lights (on Door Mirrors)	LED
Brake Lights	LED
Taillights	LED
Rear Side Marker Lights	LED
Back-Up Lights	LED
Rear Turn Signal Lights	LED
High-Mount Brake Light	LED
Rear License Plate Lights	LED
Door Outer Handle Ambient Lights	LED
Interior Lights	
Front and Rear Map Lights	LED
Front and Rear Ambient Lights	LED
Vanity Mirror Lights	1.4 W
Front Door Pocket Lights	LED
Center Pocket Light	LED
Beverage Holder Light	LED
Door Courtesy Lights	3.4 W
Console Compartment Light	LED
Glove Box Light	LED
Front and Rear ^{*1} Foot Lights	LED
Door Inner Handle Lights	LED
Trunk Light	5 W

*1: Not available on all models

■ Brake Fluid

Specified	Acura Heavy Duty Brake Fluid DOT 3
-----------	------------------------------------

■ Dual Clutch Transmission Fluid

Specified	Acura ATF DW-1
Capacity	Change 3.7 US qt (3.5 L)

■ Twin Motor Unit Fluid

Specified	Acura ATF DW-1
Capacity	Change 2.56 US qt (2.42 L)

■ Engine Oil

Recommended	-Genuine Acura Motor Oil 0W-20
	-API Premium-grade 0W-20 detergent oil
Capacity	Change 4.2 US qt (4.0 L)
	Change including filter 4.5 US qt (4.3 L)

■ Engine Coolant

Specified	Acura Long Life Antifreeze/Coolant Type2
Ratio	50/50 with distilled water
Capacity	2.1 US gal (7.9 L)
	(change including the remaining 0.225 US gal (0.85 L) in the reserve tank)

■ Inverter Coolant

Specified	Acura Long Life Antifreeze/Coolant Type2
Ratio	50/50 with distilled water
Capacity	0.32 US gal (1.23 L)
	(change including the remaining 0.03 US gal (0.11 L) in the reserve tank)

■ Tire

Regular	Size	245/40R19 98W
	Pressure psi (kPa [kgf/cm ²])	36 (250 [2.5])
Compact Spare*1	Size	T155/70D17 110M
	Pressure psi (kPa [kgf/cm ²])	60 (420 [4.2])
Wheel Size	Regular	19 x 8J
	Compact Spare*1	17 x 4T

*1: Vehicles with optional spare tire kit

Vehicle Identification Number (VIN), Engine Number, Motor Number, and Transmission Number

Your vehicle has a 17-digit vehicle identification number (VIN) used to register your vehicle for warranty purposes, and for licensing and insuring your vehicle. The locations of your vehicle's VIN, engine number, motor number, and transmission number are shown as follows.

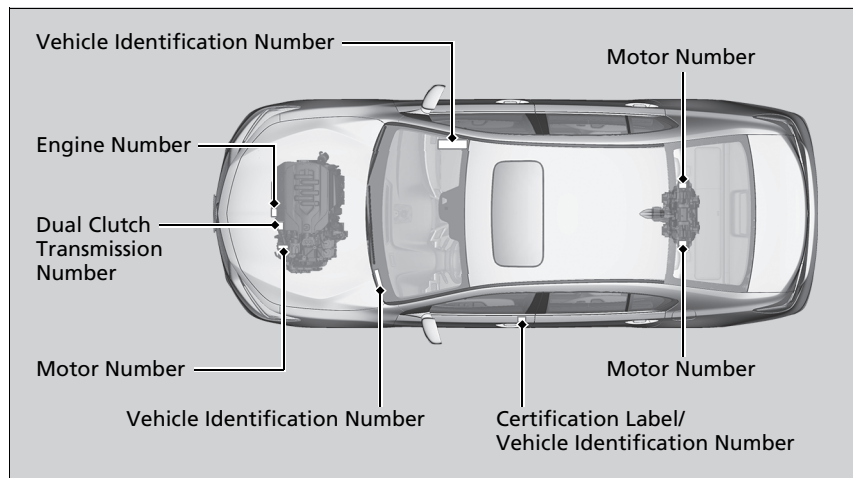

Vehicle Identification Number (VIN), Engine Number, Motor Number, and Transmission Number

The interior vehicle identification number (VIN) is located under the cover.

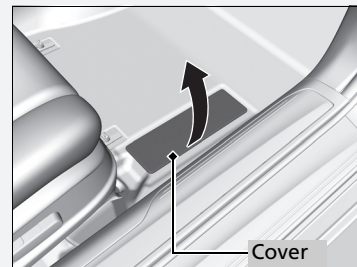

Each radio frequency device installed in the vehicle conforms to the requirements and standards of the regulation listed below:

As required by the FCC:

This device complies with Part 15 of the FCC rules. Operation is subject to the following two conditions: (1) This device may not cause harmful interference, and (2) this device must accept any interference received, including interference that may cause undesired operation.

Changes or modifications not expressly approved by the party responsible for compliance could void the user's authority to operate the equipment.

This device complies with industry Canada licence-exempt RSS standard(s).

Operation is subject to the following two conditions: (1) this device may not cause interference, and (2) this device must accept any interference, including interference that may cause undesired operation of the device.

In the U.S.

If you believe that your vehicle has a defect which could cause a crash or could cause injury or death, you should immediately inform the National Highway Traffic Safety Administration (NHTSA) in addition to notifying American Honda Motor Co., Inc.

If NHTSA receives similar complaints, it may open an investigation, and if it finds that a safety defect exists in a group of vehicles, it may order a recall and remedy campaign. However, NHTSA cannot become involved in individual problems between you, your dealer, or American Honda Motor Co., Inc.

To contact NHTSA, you may call the Vehicle Safety Hotline toll-free at 1-888-327-4236 (TTY: 1-800-424-9153); go to <http://www.safercar.gov>; or write to: Administrator, NHTSA, 1200 New Jersey Avenue, SE., Washington, DC 20590. You can also obtain other information about motor vehicle safety from <http://www.safercar.gov>.

In Canada

If you believe that your vehicle has a defect which could cause a crash or could cause injury or death, you should immediately inform Honda Canada Inc. and you may also inform Transport Canada.

If Transport Canada receives similar complaints, it may open an investigation, and if it finds that a safety defect exists in a group of vehicles, it may lead to a recall and remedy campaign. However, Transport Canada cannot become involved in individual problems between you, your dealer, or Honda Canada Inc.

To contact Transport Canada's Defect Investigations and Recalls Division, you may call 1-800-333-0510. For more information on reporting safety defects or about motor vehicle safety, go to <http://www.tc.gc.ca/roadsafety>.

Testing of Readiness Codes

Your vehicle has readiness codes as part of the onboard self diagnostic system. Some States use these codes for testing to verify whether your vehicle's emissions components are working properly. The codes may not be read properly if testing is performed just after the 12-volt battery has gone dead or been disconnected.

To check if they are set, set the power mode to ON, without turning the power system on. The malfunction indicator lamp will come on for several seconds. If it then goes off, the readiness codes are set. If it blinks five times, the readiness codes are not set.

If you are required to have your vehicle tested before the readiness codes are ready, prepare the vehicle for retesting by doing the following:

1. Fill the gas tank to approximately 3/4 full.
2. Park the vehicle and leave the power system off for 6 hours or more.
3. Make sure the ambient temperature is between 40°F and 95°F (4°C and 35°C).
4. Turn the power system on.

Testing of Readiness Codes

The readiness codes are erased when the 12-volt battery is disconnected, and set again only after several days of driving under a variety of conditions.

If a testing facility determines that the readiness codes are not set, you may be requested to return at a later date to complete the test.

If the testing facility determines the readiness codes are still not set, see a dealer.

5. Select a nearby, lightly traveled major highway where you can maintain a speed of 50 mph (80 km/h) over for at least 20 minutes. Drive on the highway in **D** with SPORT mode. Do not use cruise control.
6. Drive in city or suburban traffic for at least 10 minutes. When traffic conditions allow, let the vehicle coast for several seconds without using the accelerator pedal or the brake pedal.
7. Park the vehicle and leave the power system off for 40 minutes.

■ U.S. Owners

Your new vehicle is covered by these warranties:

New Vehicle Limited Warranty – covers your new vehicle, except for the emissions control systems and accessories, against defects in materials and workmanship.

Emissions Control Systems Defects Warranty and Emissions Performance Warranty – these two warranties cover your vehicle's emissions control systems. Time, mileage, and coverage are conditional. Please read your warranty booklet for exact information.

Seat Belt Limited Warranty – a seat belt that fails to function properly is covered by a limited warranty. Please read your warranty booklet for details.

Rust Perforation Limited Warranty – all exterior body panels are covered against rusting from the inside out for the specified time period, regardless of mileage.

Accessory Limited Warranty – Acura accessories are covered under this warranty. Time and mileage limits depend on the type of accessory and other factors. Please read your warranty booklet for details.

Replacement Parts Limited Warranty – covers all Acura replacement parts against defects in materials and workmanship.

Replacement 12-Volt Battery Limited Warranty – provides prorated coverage for a replacement battery purchased from your dealer.

Replacement Muffler Lifetime Limited Warranty – provides coverage for as long as the purchaser of the muffler owns the vehicle.

Restrictions and exclusions apply to all these warranties. Please read the Acura warranty information booklet that came with your vehicle for precise information on warranty coverages. Your vehicle's original tires are covered by their manufacturer. Tire warranty information is in a separate booklet.

■ Canadian Owners

Please refer to the warranty manual that came with your vehicle.

■ EPA Contact Information

An owner may obtain further information concerning emission warranties or report violations of the terms of the emission warranties by contacting:

U.S. Environmental Protection Agency
Office of Transportation and Air Quality
Compliance Division, Light-Duty Vehicle Group
Attn: Warranty Complaints
2000 Traverwood Drive
Ann Arbor, MI 48105
Email: complianceinfo@epa.gov

■ Service Express

For electronic copies of service publications, you can purchase a subscription to Service Express. Visit www.techinfo.honda.com for pricing and options.

■ For U.S. Owners

Manuals can be purchased from Helm Incorporated. You can order a manual by phone at 1 (800) 782-4356 (credit card orders only), or online at www.helminc.com.

■ For Canadian Owners

Please contact a dealer to order any manuals that you may require.

Acura dealership personnel are trained professionals who should be able to deal with any problems you may encounter with your vehicle. If, however, you are faced with a problem that they cannot resolve to your satisfaction, contact Acura Client Relations/Services.

U.S. Owners

American Honda Motor Co., Inc.
Acura Client Relations
Mail Stop 100-5E-8F
1919 Torrance Blvd.
Torrance, CA 90501-2746
Tel: 1 (800) 382-2238

Canadian Owners

Honda Canada Inc.
Acura Client Services
180 Honda Boulevard Markham, ON
L6C 0H9
Tel: 1-866-78-ACURA
Fax: 1-877-939-0909
E-mail: acura_cr@ch.honda.com

In Puerto Rico and the U.S. Virgin Islands

Bella International
P.O. Box 190816
San Juan, PR 00919-0816
Tel: 1 (787) 620-7546

Client Service Information

When you call or write, please give us the following information:

- Vehicle Identification Number
 - **Vehicle Identification Number (VIN), Engine Number, Motor Number, and Transmission Number** P. 588
- Date of purchase
- Odometer reading of your vehicle
- Your name, address, and telephone number
- A detailed description of the problem
- Name of the dealer who sold the vehicle to you

Gracenote Music Recognition Service (CDDB)



Music recognition technology and related data are provided by Gracenote®. Gracenote is the industry standard in music recognition technology and related content delivery.

For more information, visit www.gracenote.com.

When music is recorded to the HDD from a CD, information such as the recording artist and track name are retrieved from the Gracenote Database and displayed (when available).

Gracenote may not contain information for all albums.

Gracenote is an internet-based music recognition service that allows artist, album, and track information from CDs to display on the HDD.

Gracenote users are allowed 4 free updates a year. More information about Gracenote, its features, and downloads are available at

www.acura.com (in U.S.) or www.acura.ca (in Canada).

CD and music-related data from Gracenote, Inc., copyright © 2000 to present Gracenote. Gracenote Software, copyright © 2000 to present Gracenote.

One or more patents owned by Gracenote apply to this product and service. See the Gracenote website for a non-exhaustive list of applicable Gracenote patents.

Gracenote, CDDB, MusicID, MediaVOCS, the Gracenote logo and logotype, and the "Powered by Gracenote" logo are either registered trademarks or trademarks of Gracenote in the United States and/or other countries.

Gracenote® END USER LICENSE AGREEMENT

This application or device contains software from Gracenote, Inc. of Emeryville, California ("Gracenote"). The software from Gracenote (the "Gracenote Software") enables this application to perform disc and/or file identification and obtain music-related information, including name, artist, track, and title information ("Gracenote Data") from online servers or

embedded databases (collectively, "Gracenote Servers") and to perform other functions. You may use Gracenote Data only by means of the intended End-User functions or this application or device.

You agree that you will use Gracenote Data, the Gracenote Software, and Gracenote Servers for your own personal non-commercial use only.

You agree not to assign, copy, transfer, or transmit the Gracenote Software or any Gracenote Data to any third party.

YOU AGREE NOT TO USE OR EXPLOIT GRACENOTE DATA, THE GRACENOTE SOFTWARE, OR GRACENOTE SERVERS, EXCEPT AS EXPRESSLY PERMITTED HEREIN.

You agree that your non-exclusive license to use the Gracenote Data, the Gracenote Software, and Gracenote Servers will terminate if you violate these restrictions. If your license terminates, you agree to cease any and all use of the Gracenote Data, the Gracenote Software, and Gracenote Servers.

Gracenote reserves all rights in Gracenote Data, the Gracenote Software, and the Gracenote Servers, including all ownership rights. Under no circumstances will Gracenote become liable for any payment to you for any information that you provide. You agree that Gracenote, Inc. may enforce its rights under this Agreement against you directly in its own name.

The Gracenote service uses a unique identifier to track queries for statistical purposes. The purpose of a randomly assigned numeric identifier is to allow the Gracenote service to count queries without knowing anything about who you are. For more information, see the web page for the Gracenote Privacy Policy for the Gracenote service.

The Gracenote Software and each item of Gracenote Data are licensed to you "AS IS."

Gracenote makes no representations or warranties, express or implied, regarding the accuracy of any Gracenote Data from in the Gracenote Servers. Gracenote reserves the right to delete data from the Gracenote Servers or to change data categories for any

cause that Gracenote deems sufficient. No warranty is made that the Gracenote Software or Gracenote Servers are error-free or that functioning of Gracenote Software or Gracenote Servers will be uninterrupted.

Gracenote is not obligated to provide you with new enhanced or additional data types or categories that Gracenote may provide in the future and is free to discontinue its services at any time.

GRACENOTE DISCLAIMS ALL WARRANTIES EXPRESS OR IMPLIED, INCLUDING, BUT NOT LIMITED TO, IMPLIED WARRANTIES OF MERCHANTABILITY, FITNESS FOR A PARTICULAR PURPOSE, TITLE, AND NONINFRINGEMENT. GRACENOTE DOES NOT WARRANT THE RESULTS THAT WILL BE OBTAINED BY YOUR USE OF THE GRACENOTE SOFTWARE OR ANY GRACENOTE SERVER. IN NO CASE WILL GRACENOTE BE LIABLE FOR ANY CONSEQUENTIAL OR INCIDENTAL DAMAGES OR FOR ANY LOST PROFITS OR LOST REVENUES.

© Gracenote 2009

■ Disclaimer of Pandora®

Requirements to access Pandora®

- Latest version of the Pandora app installed on your Android, Blackberry, or iPhone.
- Registered Pandora account (you can create a free account at www.pandora.com <<http://www.pandora.com/>> or on your smartphone)
- Connection to the internet via WiFi or cellular data network.

Limitations

- Access to Pandora requires an active internet connection
- Ability to access Pandora through this system is subject to change without notice
- Certain functionality of Pandora service is not available when accessing the service through this system including, but not limited to, creating new stations, deleting stations, emailing current stations, buying tracks, viewing additional text information, logging in to Pandora, and adjusting Cell Network Audio Quality. Pandora internet radio is a music service not affiliated with HONDA. More information is available at <http://www.pandora.com> <<http://www.pandora.com/>>. Pandora, the Pandora logo, and the Pandora trade dress are trademarks or registered trademarks of Pandora Media, Inc., used with permission.
- Mobile access requires a smartphone with an active data plan. Standard data rates may apply.
- Pandora is only available in the United States.

Numbers

12-Volt Battery Charging System

Indicator 81, 567

A

AAC..... 245, 268

ABS (Anti-lock Brake System)..... 456

Accessories and Modifications..... 537

Accessory Power Sockets..... 190

Acoustic Vehicle Alerting System 395

AcuraLink..... 363

AcuraWatch™..... 26, 396

Adaptive Cruise Control (ACC) with Low

Speed Follow..... 90, 402

Additives

Coolant..... 509, 511

Washer..... 513

Additives, Engine Oil..... 504

Adjusting

Armrest..... 181

Front Seats..... 175, 178, 180

Head Restraints..... 178

Mirrors..... 172

Steering Wheel..... 171

Temperature..... 116

Agile Handling Assist..... 441

Air Conditioning System (Climate Control

System)..... 200

Changing the Mode..... 203

Defrosting the Windshield and

Windows..... 207

Dust and Pollen Filter..... 531

Rear Temperature Control Dial..... 208

Sensors..... 209

Using Automatic Climate Control..... 200

Air Pressure..... 521, 587

Airbags..... 45

Advanced Airbags..... 51

Airbag Care..... 59

Driver's Knee Airbag..... 52

Event Data Recorder..... 0

Front Airbags (SRS)..... 48

Indicator..... 57, 84

Passenger Airbag Off Indicator..... 58

Sensors..... 45

Side Airbags..... 54

Side Curtain Airbags..... 56

AM/FM Radio..... 237

Anti-lock Brake System (ABS)..... 456

Indicator..... 84

Armrest..... 181

Audio Remote Controls..... 215

Audio System..... 212

Adjusting the Sound..... 230

Auxiliary Input Jack..... 213

Error Messages..... 273

General Information..... 277

HDD..... 248

Internet Radio..... 266

iPod..... 258

MP3/WMA/AAC..... 245, 268

Reactivating..... 214

Recommended CDs..... 278

Recommended Devices..... 280

Remote Controls..... 215

Security Code..... 214

Shortcuts..... 218

Theft Protection..... 214

USB Flash Drives..... 280

USB Port..... 213

Audio/Information Screen..... 225

Authorized Manuals..... 595

Auto Door Locking/Unlocking..... 142

Customize..... 310

Auto Engine Stop/Start..... 13

Auto High-Beam..... 160

Indicator..... 87

Automatic Brake Hold..... 454

Indicator..... 78, 454

Automatic Brake Hold System

Indicator..... 78, 454

Automatic Lighting..... 157

Auxiliary Input Jack..... 213

Average Fuel Economy..... 116

Average Speed..... 117

B

Battery

12-Volt	529
12-Volt Battery Charging System	
Indicator	81, 567
Charging (12-Volt Battery)	529
High Voltage.....	449
Jump Starting	562
Maintenance (Checking the 12-Volt	
Battery)	529
Maintenance (Replacing).....	530
Battery Types	12
Belts (Seat)	38
Beverage Holders	189
Blind spot information System	443
Bluetooth® Audio	271
Bluetooth® HandsFreeLink®	324
Booster Seats (For Children)	71
Brake System	450
Anti-lock Brake System (ABS).....	456
Automatic Brake Hold.....	454
Brake Assist System.....	457
Fluid	512
Foot Brake	453
Parking Brake.....	450
Brake System (Amber)	
Indicator	79
Brake System (Red)	
Indicator	76, 568
Brightness Control (Head-Up Display)	167

Brightness Control (Instrument Panel)	166
Bulb Replacement	514
Back-Up Lights	516
Brake/Taillights and Rear Side Marker	
Lights	515
Door Outer Handle Ambient Lights.....	516
Fog Lights.....	514
Front Side Marker Lights.....	515
Front Turn Signal Lights.....	514
Headlights	514
High-Mount Brake Light	516
Parking/Daytime Running Lights	514
Rear License Plate Lights	516
Rear Turn Signal Lights	515
Side Turn Signal/Emergency Indicator	
Lights	515
Taillights.....	515
Bulb Specifications	586

C

CAMERA Button	479
Carbon Monoxide Gas	72
Cargo Area	193
Cargo Hooks	192
Carrying Cargo	373, 375
CD Player	245
Center Pocket	188
Certification Label	588
Changing Bulbs	514

Child Safety	60
Childproof Door Locks.....	141
Child Seat	60
Booster Seats	71
Child Seat for Infants.....	62
Child Seat for Small Children.....	63
Installing a Child Seat with a Lap/Shoulder Seat	
Belt	67
Larger Children	70
Rear-facing Child Seat.....	62
Selecting a Child Seat.....	64
Using a Tether.....	69
Childproof Door Locks	141
Cleaning the Exterior	534
Cleaning the Interior	532
Client Service Information	596
Climate Control System	200
Changing the Mode.....	203
Defrosting the Windshield and	
Windows.....	207
Dust and Pollen Filter.....	531
Rear Temperature Control Dial.....	208
Sensors	209
Using Automatic Climate Control.....	200
Clock	128
CMBS™ (Collision Mitigation Braking	
System™)	458
Coat Hooks	191
Collision Mitigation Braking System™	
(CMBS™)	458

Compact Spare Tire (Optional)	553, 587
Console Compartment	187
Controls	127
Coolant (Engine).....	509
Adding to the Radiator	510
Adding to the Reserve Tank	509
High Temperature Indicator	85
Low Temperature Indicator	85
Overheating.....	565
Coolant (Inverter)	511
Creeping (Dual Clutch Transmission).....	384
Cross Traffic Monitor.....	472
Cup Holders.....	189
Customized Features	295

D

Daytime Running Lights.....	159
Dead Battery (12-Volt)	562
Defrosting the Windshield and Windows.....	207
Devices that Emit Radio Waves.....	589
Dimming	
Headlights	156
Rearview Mirror	172
Dipstick (Engine Oil)	505
Directional Signals (Turn Signal).....	155
Door Mirrors	173
Doors	129
Auto Door Locking	142
Auto Door Unlocking.....	142

Door Open Message.....	37
Keys	129
Locking/Unlocking the Doors from the Inside	18, 139
Locking/Unlocking the Doors from the Outside	131
Lockout Prevention System.....	137
DOT Tire Quality Grading	523
Driver's Knee Airbag	52
Driving	371
Braking	450
Dual Clutch Transmission	384
Shifting Gear	385
Turning on the Power.....	378
Driving Position Memory System	169
Dual Clutch Transmission	
Creeping.....	384
Fluid.....	512
Kickdown.....	384
Operating the Shift Button	23, 387
Shifting	385
Dust and Pollen Filter.....	531

E

Elapsed Time.....	117
Electric Parking Brake	
Indicator.....	77
Electric Parking Brake System	
Indicator.....	77, 569

Electric Power Steering (EPS) System	
Indicator	84, 569
Electronic Stability Control (ESC)	439
Emergency	580
Emissions Testing (Readiness Codes)	591
Energy Efficiency.....	12
Engine.....	588
Coolant	509
Jump Starting	562
Oil	504
Remote Engine Start	380
Engine Compartment Cover.....	503
Engine Coolant	509
Adding to the Radiator	510
Adding to the Reserve Tank	509
High Temperature Indicator	85
Low Temperature Indicator	85
Overheating.....	565
Engine Oil.....	504
Adding	506
Checking	505
Displaying Oil Life	496
Low Oil Pressure Indicator	76, 567
Recommended Engine Oil	504
e-pretensioners	40
EPS (Electric Power Steering) System.....	84
Exhaust Gas Hazard (Carbon Monoxide)..	72
Expanded Rear Door Sunshades	199
Exterior Care (Cleaning)	534
Exterior Mirrors.....	173

F			
Features	211		
Filters			
Dust and Pollen	531		
Oil	507		
Flat Tire	541, 553		
Floor Mats	533		
Fluids			
Brake	512		
Dual Clutch Transmission	512		
Engine Coolant	509		
Inverter Coolant	511		
Windshield Washer	513		
Foot Brake	453		
Front Airbags (SRS)	48		
Front Seat Heaters	195		
Front Seat Heaters and Ventilation	196		
Front Seats			
Adjusting	175, 178, 180		
Front Sensor Camera	400		
Fuel	25, 488		
Economy	490		
Gauge	112		
Instant Fuel Economy	117		
Low Fuel Indicator	83		
Range	117		
Recommendation	488, 586		
Refueling	488		
Fuel Economy	490		
Fuel Fill Door	25, 489		
Fuses	572		
Inspecting and Changing	579		
Locations	572, 576, 577		
G			
Gasoline (Fuel)			
Economy	490		
Gauge	112		
Information	488		
Instant Fuel Economy	117		
Low Fuel Indicator	83		
Refueling	488		
Gauges	112		
Gear Position Indicator	81, 387		
Gear Shift Positions			
Dual Clutch Transmission	385		
Glass (care)	532, 535		
Glove Box	184		
H			
Handling the Unexpected	539		
HandsFreeLink® (HFL)	324		
Auto Answer	338		
Automatic Import of Cellular Phonebook and Call History	340		
Automatic Transferring	338		
Displaying Messages	358		
Editing User Name	337		
HFL Buttons	324		
HFL Menus	326		
HFL Status Display	325		
Limitations for Manual Operation	325		
Making a Call	349		
Options During a Call	355		
Phone Setup	330		
Phonebook Phonetic Modification	344		
Receiving a Call	354		
Receiving a Text/E-mail Message	356		
Ring Tone	339		
Roadside Assistance	362		
Selecting a Mail Account	357		
Speed Dial	341		
To Create a Security PIN	336		
To Set Up a Text/E-mail Message Option	335		
Use Contact Photo	339		
Hard Disk Drive (HDD) Audio	248		
Hazard Warning Button	4		
Head Restraints	178		
Headlight Washers	165		
Headlights	156		
Aiming	514		
Auto High-Beam	160		
Automatic Operation	157		
Dimming	156		
Operating	156		
Head-Up Display	119		
Brightness Control	167		
Heated Steering Wheel	194		
Heaters (Seat)	195, 196, 197		

HFL (HandsFreeLink®)	324
High Beam Indicator	87
High Voltage Battery	449
Hill Start Assist System	382
HomeLink® Universal Transceiver	321
Honda App License Agreement	281
Hybrid Vehicle	
SPORT HYBRID Super Handling-All Wheel	
Drive™ (SPORT HYBRID SH-AWD®)	9

I

Identification Numbers

Engine, Motor, and Transmission	588
Vehicle Identification	588

Illumination Control

Buttons	166, 167
---------------	----------

Immobilizer System

Indicator	87
-----------------	----

Indicators

12-Volt Battery Charging System	81, 567
Adaptive Cruise Control (ACC) with Low Speed	
Follow	90, 402
Anti-lock Brake System (ABS)	84
Auto High-Beam	87
Automatic Brake Hold	78, 454
Automatic Brake Hold System	78, 454
Blind spot information System	92, 444
Brake System (Amber)	79
Brake System (Red)	76, 568

Collision Mitigation Braking System™	
(CMBS™)	92, 93
Door and Trunk Open	37
Electric Parking Brake	77
Electric Parking Brake System	77, 569
Electric Power Steering (EPS) System ..	84, 569
Fog Light	87
Gear Position	81
High Beam	87
High Temperature	85
Immobilizer System	87
Keyless Access System	88
Lane Keeping Assist System (LKAS)	91, 423
Lights On	87
Low Fuel	83
Low Oil Pressure	76, 567
Low Temperature	85
Low Tire Pressure/TPMS	86, 445, 447
Malfunction Indicator Lamp	81, 568
POWER SYSTEM	80
READY	80
Road Departure Mitigation (RDM)	89
Seat Belt Reminder	39, 83
Security System Alarm	88
SPORT Mode	88, 393
Supplemental Restraint System	57, 84
System Message	86
Transmission System	82
Turn Signal	86

Vehicle Stability Assist™ (VSA®)	
System	85, 439
VSA® OFF	85, 440
Information	585
Instant Fuel Economy	117
Instrument Panel	75
Brightness Control	166
Interface Dial	216
Interior Lights	182
Interior Rearview Mirror	172
Inverter Coolant	511

J

Jack (Wheel Nut Wrench)	556
Jump Starting	562

K

Key Number Tag	130
Keyless Access System	131
Keyless Lockout Prevention	137
Keys	129
Lockout Prevention	137
Number Tag	130
Rear Door Won't Open	141
Remote Transmitter	136
Two-way Keyless Access Remote	138, 380
Types and Functions	129
Kickdown (Dual Clutch Transmission)	384

L

Lane Keeping Assist System (LKAS)	421
Language (HFL)	325
LATCH (Child Seats)	65
Lights	156, 514
Auto High-Beam	160
Auto High-Beam Indicator	87
Automatic	157
Bulb Replacement	514
Daytime Running Lights	159
Fog Lights	159
High Beam Indicator	87
Interior	182
Light Switches	156
Lights On Indicator	87
Turn Signals	155
Load Limits	375
Locking/Unlocking	129
Auto Door Locking/Unlocking	142
Childproof Door Locks	141
From Inside	139
From Outside	131
Keys	129
Using a Key	137
Lockout Prevention System	137
Low Battery Charge (12-Volt)	567
Low Fuel Indicator	83
Low Keyless Access Remote Signal Strength	130
Low Oil Pressure Indicator	76, 567
Lower Anchors	65

Luggage (Maximum Load Limit)	375
Lumbar Support	176

M

Maintenance	491
12-Volt Battery	529
Brake Fluid	512
Cleaning	532
Climate Control System	531
Coolant	509, 511
Maintenance Minder™	495
Oil	505
Precautions	492
Radiator	510
Remote Transmitter	530
Replacing Light Bulbs	514
Safety	493
Service Items	498
Tires	520
Transmission Fluid	512
Under the Hood	501
Malfunction Indicator Lamp	81, 568
Map Lights	183
Maximum Load Limit	375
Meters, Gauges	112
Mirrors	
Adjusting	172
Door	173
Exterior	173
Interior Rearview	172

Modifications (and Accessories)	537
Moonroof	151
MP3	245, 268
Multi-Information Display	114
Multi-View Rear Camera	476

N

Numbers (Identification)	588
--------------------------------	-----

O

Odometer	116
Oil (Engine)	504, 587
Adding	506
Checking	505
Displaying Oil Life	496
Low Oil Pressure Indicator	76, 567
Recommended Engine Oil	504, 587
Viscosity	504, 587
On Demand Multi-Use Display™	217
Open Source Licenses	294
Opening	
Trunk	582
Opening/Closing	
Hood	502
Moonroof	151
Power Windows	149
Trunk	143
Operating the Switches Around the Steering Wheel	152

Outside Temperature Display	116
Overheating	565

P

Paddle Shifters (Sequential Mode)	392
Pandora®	267
Panic Mode	148
Parking	466
Parking Brake	450
Parking Sensor System	468
Passenger Airbag Off Indicator	58
Passing Indicators	156
POWER Button	152
Power Distribution Monitor	124, 227
Power Rear Sunshade	198
Power System	
Turning on	378
POWER SYSTEM Indicator	80
Power Windows	149
Precautions While Driving	
Rain	383
Pregnant Women	43
Puncture (Tire)	541, 553

R

Radiator	510
Radio (AM/FM)	237
Radio (SiriusXM®)	242

Radio Data System (RDS)	239
Range	117
RDS (Radio Data System)	239
Reactive Force Pedal	394
Readiness Codes (Emissions Testing)	591
READY Indicator	80
Rear Defogger/Heated Door Mirror	
Button	168
Rear Seat Heaters	197
Rear Temperature Control Dial	208
Rearview Mirror	172
Refueling	488
Fuel Gauge	112
Gasoline	488, 586
Low Fuel Indicator	83
Regenerative Energy and Regenerative	
Braking	12
Regulations	447, 523, 589
Remote Engine Start with Vehicle	
Feedback	380
Remote Transmitter	136
Replacement	
Battery	530
Bulbs	514
Fuses	572, 576, 577
Tires	526
Wiper Blade Rubber	517
Reporting Safety Defects	590
Resetting a Trip Meter	116
Reverse Tilt Door Mirror	173

Right Selector Wheel	114
Road Departure Mitigation (RDM)	416
On and Off	418

S

Safe Driving	33
Safety Labels	73
Safety Message	1
Seat Belts	38
Adjusting the Shoulder Anchor	42
Automatic Seat Belt Tensioners	40
Checking	44
e-pretensioners	40
Fastening	41
Installing a Child Seat with a Lap/Shoulder Seat	
Belt	67
Pregnant Women	43
Reminder	39, 83
Warning Indicator	39, 83
Seat Heaters	195, 196, 197
Seats	
Adjusting	175
Front Seats	175, 178, 180
Seat Heaters	195, 196, 197
Security System	146
Immobilizer System Indicator	87
Security System Alarm Indicator	88
Selecting a Child Seat	64
Sequential Mode	391

Sequential Mode Operation	392
Setting the Clock.....	128
Shift Button	23, 385
Operation	387
Shifting (Transmission)	23, 385
Shoulder Anchor	42
Side Airbags	54
Side Curtain Airbags.....	56
SiriusXM® Radio	242
Snow Tires	528
Sounds Unique to the SPORT HYBRID SH- AWD® System	13
Spare Tire (Optional)	553, 587
Spark Plugs	586
Specifications	586
Specified Fuel	488, 586
SPORT HYBRID Super Handling-All Wheel Drive™ (SPORT HYBRID SH-AWD®)	442
SPORT Mode.....	393
SPORT Mode Indicator.....	88, 393
SRS Airbags (Airbags)	48
Steering Wheel Adjusting.....	171
Stopping	466
Summer Tires.....	528
Supplemental Restraint System (SRS)	48
Surround View Camera System.....	478
Switches (Around the Steering Wheel)	4, 5, 152
System Message Indicator	86

T

Temperature

High Temperature Indicator	85
Low Temperature Indicator.....	85
Temperature Sensor	209
Temporary Tire Repair Kit.....	542
Tie-down Anchors	192
Time (Setting)	128

Tire Pressure Monitoring System

(TPMS)	445
Indicator	86, 570

Tires

Air Pressure	521, 587
Chains.....	528
Checking and Maintaining.....	520
Flat Tire (Puncture).....	541
Inspection.....	520
Labeling	521
Regulations	523
Rotation	527
Spare (Optional)	553, 587
Summer	528
Temporary Tire Repair Kit	542
Wear Indicators	525
Winter.....	528

Tools	540
-------------	-----

Towing a Trailer	377
------------------------	-----

Towing Your Vehicle.....	377
--------------------------	-----

Emergency	580
-----------------	-----

Transmission	23, 385
--------------------	---------

Dual Clutch	23, 384, 385
-------------------	--------------

Fluid.....	512
------------	-----

Gear Position Indicator	81, 387
-------------------------------	---------

Number.....	588
-------------	-----

Sequential Mode	391
-----------------------	-----

TRIP Button	115
-------------------	-----

Trip Meter	116
------------------	-----

Troubleshooting	539
-----------------------	-----

Blown Fuse.....	572, 576, 577
-----------------	---------------

Brake Pedal Vibrates.....	29
---------------------------	----

Buzzer Sounds When Opening Door.....	29
--------------------------------------	----

Emergency Towing.....	580
-----------------------	-----

Flat Tire/Puncture	541, 553
--------------------------	----------

Noise When Braking.....	30
-------------------------	----

Overheating	565
-------------------	-----

Power System Won't Start.....	559
-------------------------------	-----

Premium Gasoline	488, 586
------------------------	----------

Rear Door Won't Open.....	29, 141
---------------------------	---------

Warning Indicators.....	76
-------------------------	----

Trunk	
-------------	--

Lid.....	143
----------	-----

Light Bulbs	586
-------------------	-----

Release Handle.....	582
---------------------	-----

Unable to Open.....	582
---------------------	-----

Turn Signals	155
--------------------	-----

Indicators (Instrument Panel)	86
-------------------------------------	----

Turn-by-Turn Directions.....	118, 123
------------------------------	----------

Turning on the Power.....	378
---------------------------	-----

Does Not Activate	559
-------------------------	-----

Jump Starting.....	562
--------------------	-----

Remote Engine Start.....	380
--------------------------	-----

Two-way Keyless Access Remote.....	138, 380
------------------------------------	----------

U

Unlocking the Doors.....	131
Unlocking the Front Doors from the Inside.....	18, 139
USB Flash Drives.....	280
USB Port.....	213
Using the Keyless Access System.....	131

V

Valet Mode.....	185
Vanity Mirrors.....	7
Vehicle Identification Number.....	588
Vehicle Speed.....	123
Vehicle Stability Assist™ (VSA®).....	439
Off Button.....	440
Off Indicator.....	85, 440
System Indicator.....	85, 439
Viscosity (Oil).....	504, 587
VSA® (Vehicle Stability Assist™).....	439

W

Warning and Information Messages.....	94
Warning Indicator On/Blinking.....	567
Warning Labels.....	73
Warranties (Warranty Manual provided separately).....	593
Watts.....	586
Wear Indicators (Tire).....	525
Wheel Nut Wrench (Jack Handle).....	556

Window Washers.....	163
Adding/Refilling Fluid.....	513
Switch.....	163
Windows (Opening and Closing).....	149
Windshield	
Cleaning.....	532, 535
Defrosting/Defogging.....	207
Washer Fluid.....	513
Wiper Blades.....	517
Wipers and Washers.....	163
Winter Tires	
Snow Tires.....	528
Tire Chains.....	528
Wipers and Washers.....	163
Checking and Replacing Wiper Blades.....	517
WMA.....	245, 268
Worn Tires.....	520



owners.acura.com
acura.ca (Canada)

31TY3660
OM-12714
00X31-TY3-6601

2020 Acura RLX Sport Hybrid Owner's Manual
© 2019 Honda Motor Co., Ltd. — All Rights Reserved

Printed in U.S.A.