

TLX



2018
OWNER'S MANUAL

California Proposition 65 Warning

WARNING: This product contains or emits chemicals known to the state of California to cause cancer and birth defects or other reproductive harm.

Event Data Recorders

This vehicle is equipped with an event data recorder (EDR).

The main purpose of an EDR is to record, in certain crash or near crash-like situations, such as an air bag deployment or hitting a road obstacle, data that will assist in understanding how a vehicle's systems performed. **The EDR is designed to record data related to vehicle dynamics and safety systems for a short period of time, typically 30 seconds or less. The EDR in this vehicle is designed to record such data as:**

- **How various systems in your vehicle were operating;**
- **Whether or not the driver and passenger safety belts were buckled/fastened;**
- **How far (if at all) the driver was depressing the accelerator and/or brake pedal; and,**
- **How fast the vehicle was traveling.**

These data can help provide a better understanding of the circumstances in which crashes and injuries occur. NOTE: EDR data are recorded by your vehicle only if a non-trivial crash situation occurs; no data are recorded by the EDR under normal driving conditions and no personal data (e.g., name, gender, age, and crash location) are recorded. However, other parties, such as law enforcement, could combine the EDR data with the type of personally identifying data routinely acquired during a crash investigation.

To read data recorded by an EDR, special equipment is required, and access to the vehicle or the EDR is needed. In addition to the vehicle manufacturer, other parties, such as law enforcement, that have the special equipment, can read the information if they have access to the vehicle or the EDR.

The data belongs to the vehicle owner and may not be accessed by anyone else except as legally required or with the permission of the vehicle owner.

Service Diagnostic Recorders

This vehicle is equipped with service-related devices that record information about powertrain performance. The data can be used to verify emissions law requirements and/or help technicians diagnose and solve service problems. It may also be combined with data from other sources for research purposes, but it remains confidential. Some diagnostic and maintenance information is uploaded to Acura upon vehicle start up.

California Perchlorate Contamination Prevention Act

The airbags, seat belt tensioners, and CR type batteries in this vehicle may contain perchlorate materials - special handling may apply. See www.dtsc.ca.gov/hazardouswaste/perchlorate/

As you read this manual, you will find information that is preceded by a **NOTICE** symbol. This information is intended to help you avoid damage to your vehicle, other property, or the environment.

Software End User License Agreement

Your vehicle comes equipped with software, which is governed by the End User License Agreement in Owner's Manual, and which contains a binding arbitration clause. Please refer to the End User License Agreement for the terms and conditions governing your use of the installed software, as well as the applications, services, functions, and content provided through the software. Your use of the installed software will serve as your consent to the terms and conditions of the End User License Agreement.

You may opt out within 30 days of your initial use of the Software by sending a signed, written notice to HONDA at American Honda Motor Co., Inc. Honda Automobile Customer Services Mail Stop 500-2N-7A, 1919 Torrance Blvd. Torrance, CA 90501-2746.

A Few Words About Safety

Your safety, and the safety of others, is very important. And operating this vehicle safely is an important responsibility.

To help you make informed decisions about safety, we have provided operating procedures and other information on labels and in this manual. This information alerts you to potential hazards that could hurt you or others.

Of course, it is not practical or possible to warn you about all the hazards associated with operating or maintaining your vehicle. You must use your own good judgment.

You will find this important safety information in a variety of forms, including:

- **Safety Labels** - on the vehicle.
- **Safety Messages** - preceded by a safety alert symbol  and one of three signal words: **DANGER**, **WARNING**, or **CAUTION**. These signal words mean:

 **DANGER**

You WILL be KILLED or SERIOUSLY HURT if you don't follow instructions.

 **WARNING**

You CAN be KILLED or SERIOUSLY HURT if you don't follow instructions.

 **CAUTION**

You CAN be HURT if you don't follow instructions.

- **Safety Headings** - such as Important Safety Precautions.
- **Safety Section** - such as Safe Driving.
- **Instructions** - how to use this vehicle correctly and safely.

This entire book is filled with important safety information - please read it carefully.

This owner's manual should be considered a permanent part of the vehicle and should remain with the vehicle when it is sold.

This owner's manual covers all models of your vehicle. You may find descriptions of equipment and features that are not on your particular model.

Images throughout this owner's manual (including the front cover) represent features and equipment that are available on some, but not all, models. Your particular model may not have some of these features.

This owner's manual is for vehicles sold in the United States and Canada.

The information and specifications included in this publication were in effect at the time of approval for printing. Honda Motor Co., Ltd. reserves the right, however, to discontinue or change specifications or design at any time without notice and without incurring any obligation.

➤ Safe Driving P. 29

For Safe Driving P. 30 Seat Belts P. 34 Airbags P. 41

➤ Instrument Panel P. 71

Indicators P. 72 Gauges and Multi-Information Display P. 113

➤ Controls P. 131

Clock P. 132 Locking and Unlocking the Doors P. 133
Opening and Closing the Moonroof P. 156
Adjusting the Seats P. 179

➤ Features P. 213

Audio System P. 214 Audio System Basic Operation P. 219
Customized Features P. 292 HomeLink® Universal Transceiver P. 314

➤ Driving P. 355

Before Driving P. 356 Towing a Trailer P. 361
Multi-View Rear Camera* P. 457 Surround View Camera System* P. 459

➤ Maintenance P. 465

Before Performing Maintenance P. 466 Maintenance Minder™ P. 469
Checking and Maintaining Wiper Blades P. 493
Climate Control System Maintenance P. 508

➤ Handling the Unexpected P. 517

Tools P. 518 If a Tire Goes Flat P. 519
Overheating P. 547 Indicator, Coming On/Blinking P. 549
When You Cannot Open the Trunk P. 562

➤ Information P. 565

Specifications P. 566 Identification Numbers P. 568
Emissions Testing P. 572 Warranty Coverages P. 574

Contents

Child Safety P. 56

Exhaust Gas Hazard P. 69

Safety Labels P. 70

Opening and Closing the Trunk P. 148

Security System P. 151

Opening and Closing the Windows P. 154

Operating the Switches Around the Steering Wheel P. 157

Adjusting the Mirrors P. 176

Interior Lights/Interior Convenience Items P. 188

Climate Control System P. 204

Audio Error Messages P. 267

General Information on the Audio System P. 274

Bluetooth® HandsFreeLink® P. 317

Compass* P. 352

When Driving P. 362

Braking P. 429

Parking Your Vehicle P. 446

Refueling P. 460

Fuel Economy and CO₂ Emissions P. 463

Maintenance Under the Hood P. 474

Replacing Light Bulbs P. 488

Checking and Maintaining Tires P. 495

Battery P. 504

Remote Transmitter Care P. 506

Cleaning P. 509

Accessories and Modifications P. 514

Engine Does Not Start P. 539

Jump Starting P. 542

Shift Lever Does Not Move P. 546

Fuses P. 555

Emergency Towing P. 560

When You Cannot Unlock the Fuel Fill Door P. 561

Refueling P. 563

Devices that Emit Radio Waves P. 569

Reporting Safety Defects P. 571

Authorized Manuals P. 576

Client Service Information P. 577

Quick Reference Guide P. 4

Safe Driving P. 29

Instrument Panel P. 71

Controls P. 131

Features P. 213

Driving P. 355

Maintenance P. 465

Handling the Unexpected P. 517

Information P. 565

Index P. 579

Visual Index

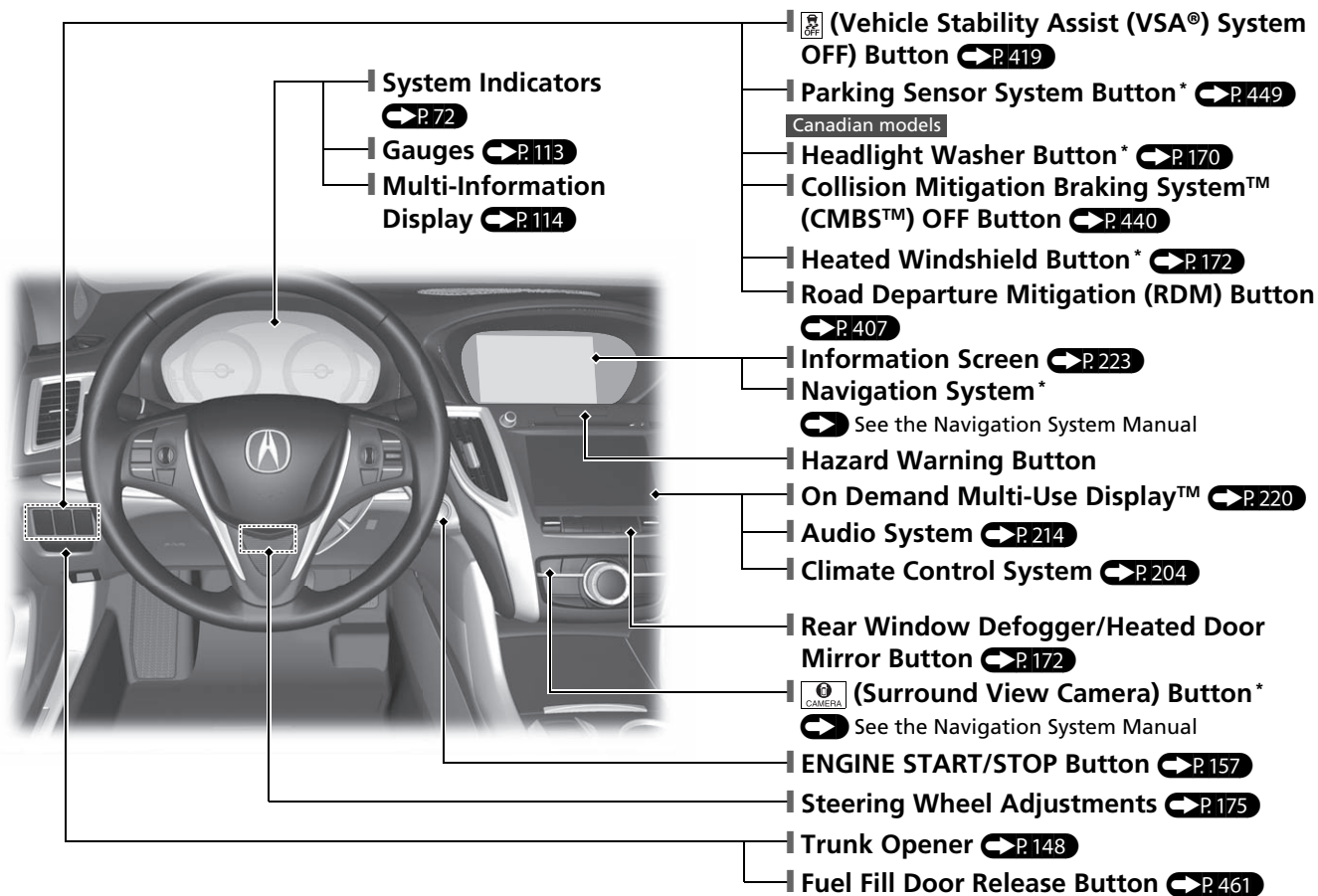

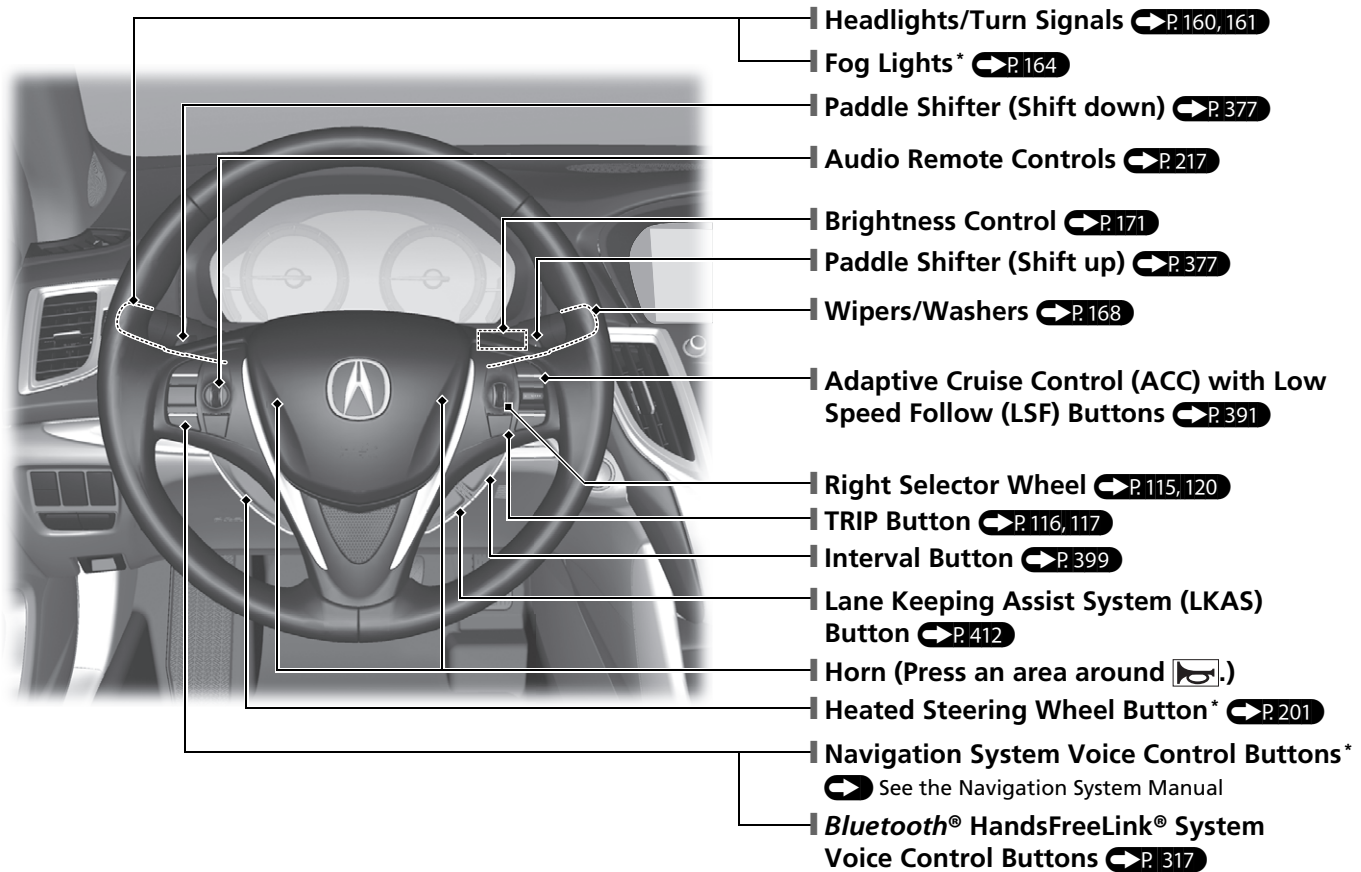

Visual Index

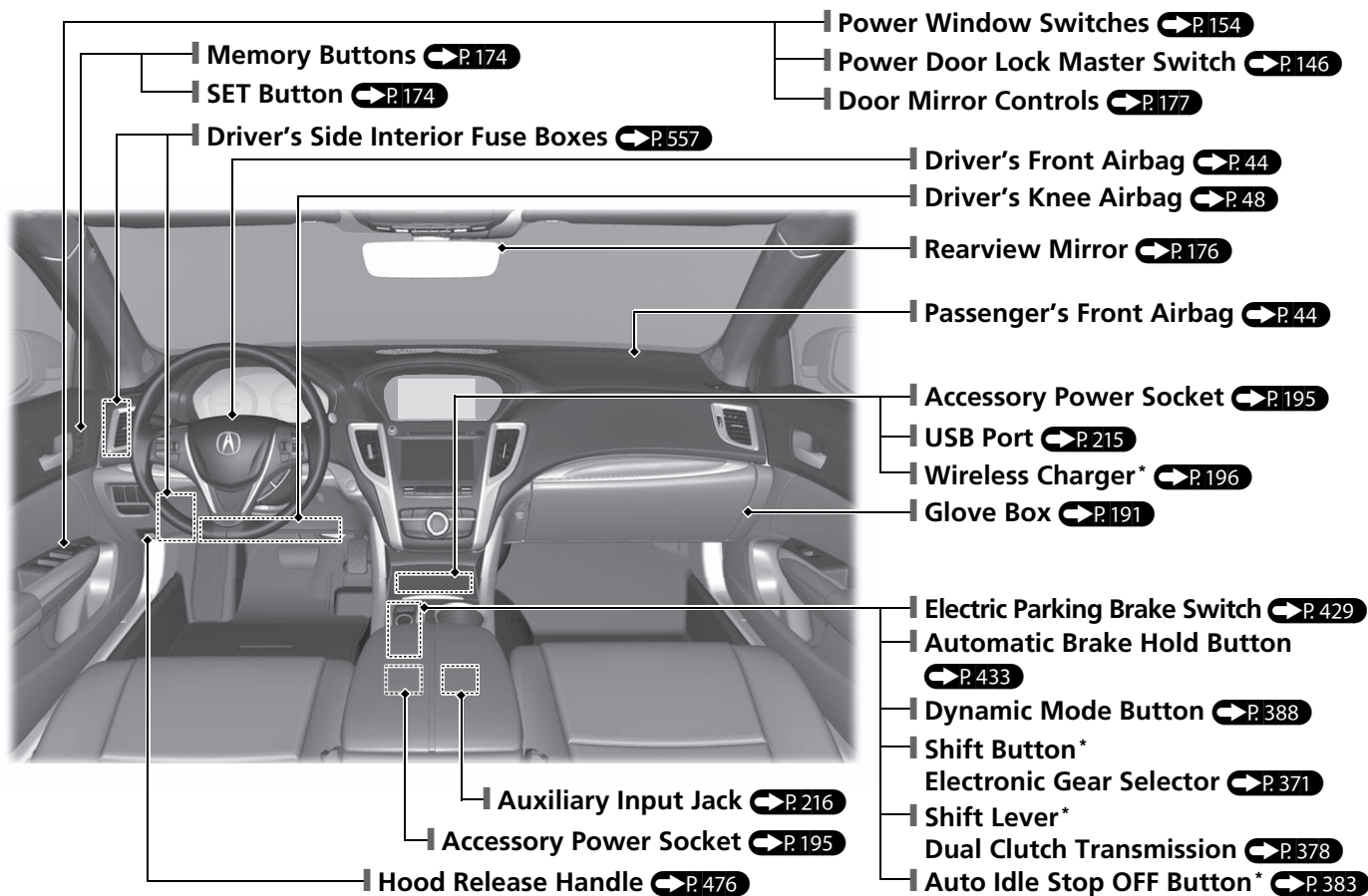

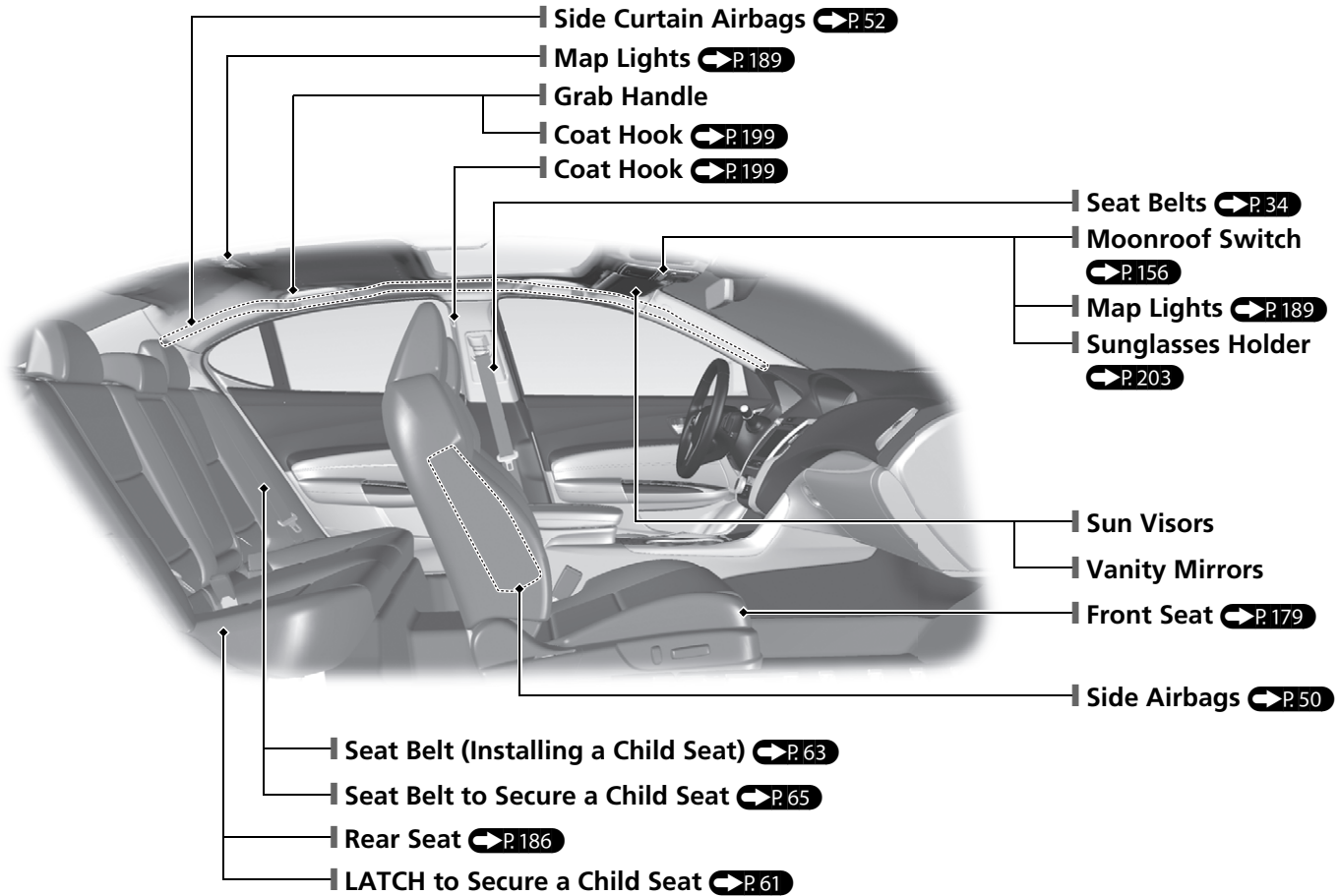



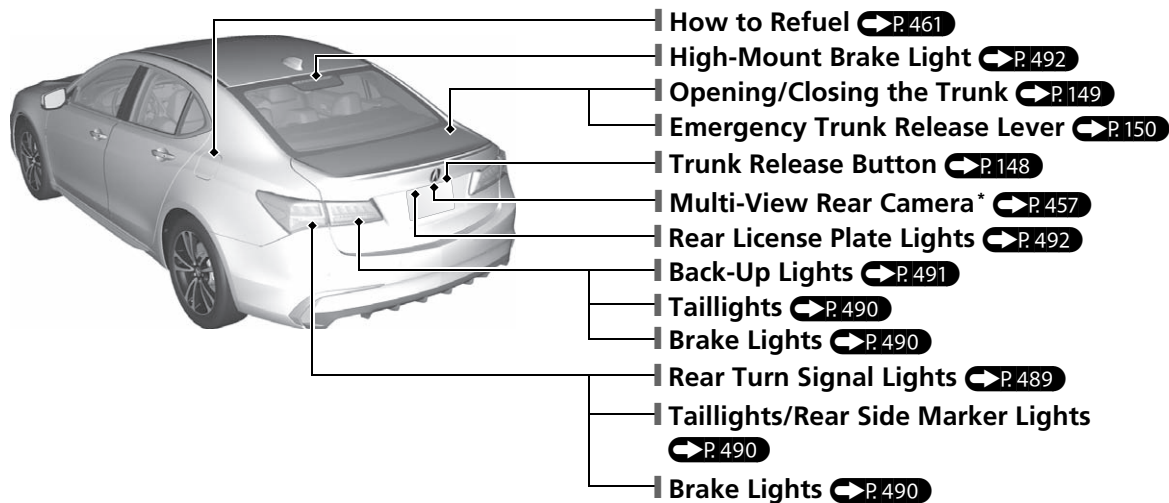
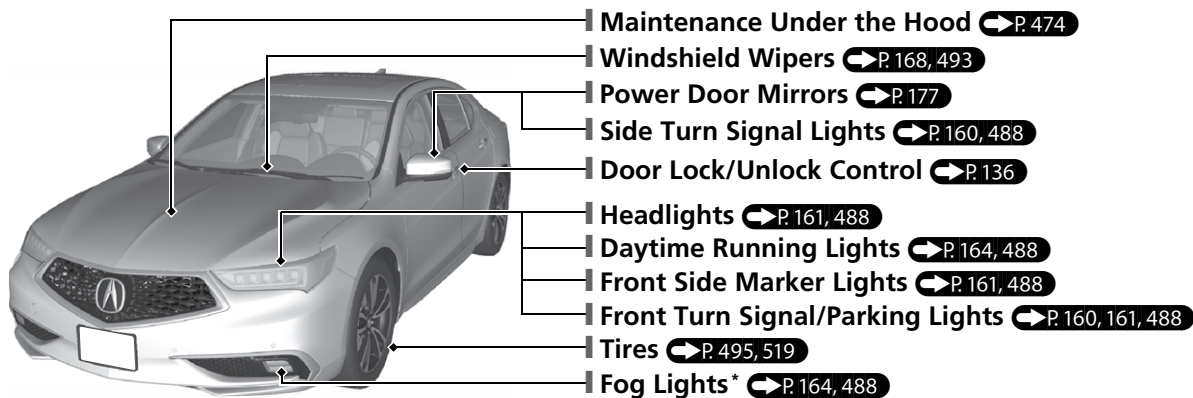

Visual Index

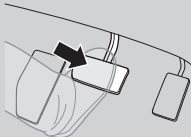
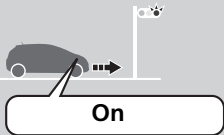

Auto Idle Stop Function*

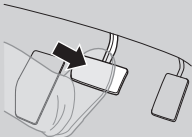
To improve fuel economy, the engine stops and then restarts as detailed below. When Auto Idle Stop is on, the Auto Idle Stop indicator (green) comes on. P. 382

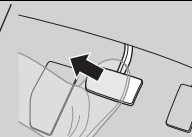
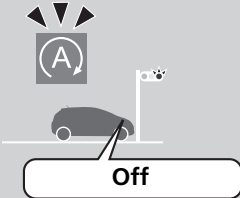
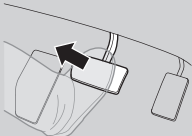
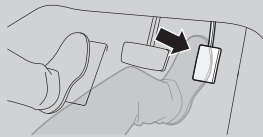
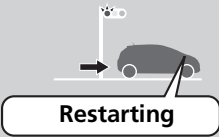
| At | Automatic transmission | Engine status |
|---|--|--|
| <p>Deceleration</p>  |  <p>Stop the vehicle and depress the brake pedal.</p> |  <p>On</p> |
| <p>Stop</p>  |  <p>Keep the brake pedal depressed.</p> <div style="display: flex; justify-content: space-around; align-items: center;"> <div style="text-align: center;"> <p>U.S.</p>  <p>HOLD</p> </div> <div style="text-align: center;"> <p>Canada</p>  <p>(A)</p> </div> </div>  <p>With the automatic brake hold system activated, you can release the brake pedal when the (A) indicator comes on.</p> |  <p>Off</p> |
| <p>Start-up</p> |  <p>Release the brake pedal.</p>  <p>With the automatic brake hold system activated, depress the accelerator pedal.</p> |  <p>Restarting</p> |

Safe Driving P. 29

Airbags P. 41

- Your vehicle is fitted with airbags to help protect you and your passengers during a moderate-to-severe collision.

Child Safety P. 56

- All children 12 and younger should be seated in the rear seat.
- Smaller children should be properly restrained in a forward-facing child seat.
- Infants must be properly restrained in a rear-facing child seat.

Exhaust Gas Hazard P. 69

- Your vehicle emits dangerous exhaust gases that contain carbon monoxide. Do not run the engine in confined spaces where carbon monoxide gas can accumulate.

Seat Belts P. 34

- Fasten your seat belt and sit upright well back in the seat.
- Check that your passengers are wearing their seat belts correctly.

Before Driving Checklist P. 33

- Before driving, check that the front seats, head restraints, steering wheel, and mirrors have been properly adjusted.

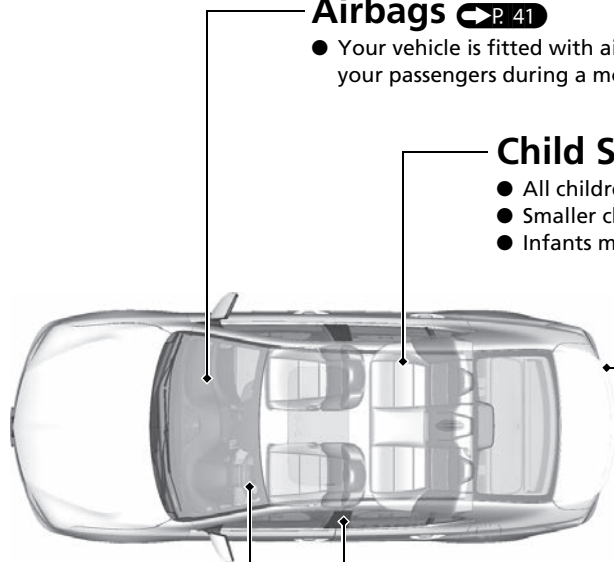

















Fasten your lap belt as low as possible.

Instrument Panel



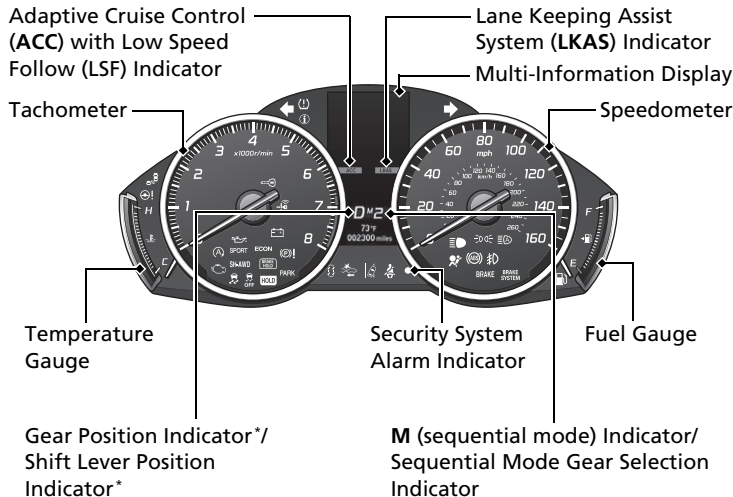

Gauges /Display /System Indicators

System Indicators





-  Blind Spot Information (BSI) Indicator*
-  Electric Power Steering (EPS) System Indicator
-  Malfunction Indicator Lamp
-  Low Oil Pressure Indicator
- SPORT**  SPORT (Sport mode) Indicator
-  Vehicle Stability Assist (VSA®) System Indicator
-  VSA® OFF Indicator
-  Immobilizer System Indicator
-  Keyless Access System Indicator
-  Charging System Indicator
-  Automatic Brake Hold System Indicator
- HOLD**  U.S. Automatic Brake Hold Indicator
-  Canada
-  Electric Parking Brake System Indicator
- PARK**  U.S. Electric Parking Brake Indicator
-  Canada

















System Indicators

-  Low Tire Pressure/TPMS Indicator
-  System Message Indicator
-  Collision Mitigation Braking System™ (CMBS™) Indicator
-  Road Departure Mitigation (RDM) Indicator

Lights Indicators

-  Lights On Indicator
-  High Beam Indicator
-  Fog Light Indicator*
-  Auto High-Beam Indicator

System Indicators

- SH-AWD**  SH-AWD Indicator*
-  Auto Idle Stop System Indicator (Amber)*
-  Auto Idle Stop Indicator (Green)*
- ECON**  ECON (Econ mode) Indicator
-  Turn Signal and Hazard Warning Indicators
-  Supplemental Restraint System Indicator
-  Anti-lock Brake System (ABS) Indicator
- BRAKE**  U.S. Brake System Indicator (Red)
-  Canada
- BRAKE SYSTEM**  U.S. Brake System Indicator (Amber)
-  Canada
-  Low Fuel Indicator
-  Seat Belt Reminder Indicator
-  Precision All-Wheel Steer™ (P-AWS®) Indicator*

* Not available on all models

Controls [P. 131](#)

Clock [P. 132](#)

You can also adjust the time manually.



- 1 Enter the **Clock Adjustment** screen.
➔ **Clock** [P. 132](#)
- 2 Rotate to change hour, then move .
- 3 Rotate to change minute, then press .

Models with navigation system

The navigation system receives signals from GPS satellites, updating the clock automatically.

ENGINE START/STOP Button [P. 157](#)

Press the button to change the vehicle's power mode.



Turn Signals [P. 160](#)

Turn Signal Control Lever

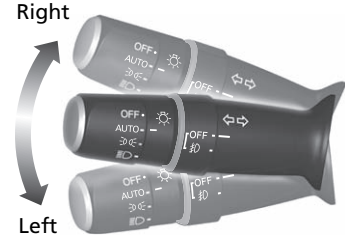

Lights [P. 161](#)

Light Control Switches

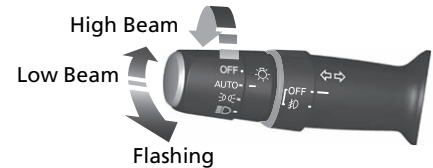

Wipers and Washers

➔ P.168

Wiper/Washer Control Lever

MIST

OFF

AUTO*1: Wiper speed varies automatically

INT*2: Low speed with intermittent

LO: Low speed wipe

HI: High speed wipe

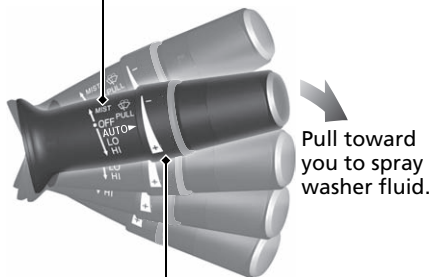

Adjustment Ring

☐: Low Sensitivity*1

: Lower speed, fewer sweeps*2

⊕: High Sensitivity*1

: Higher speed, more sweeps*2

*1: Models with automatic intermittent wipers

*2: Models without automatic intermittent wipers

Models with automatic intermittent wipers

AUTO should always be turned **OFF** before the following situation in order to prevent severe damage to the wiper system:

- Cleaning the windshield
- Driving through a car wash
- No rain present

Steering Wheel ➔ P.175

- To adjust, push the adjustment lever down, adjust to the desired position, then lock the lever back in place.

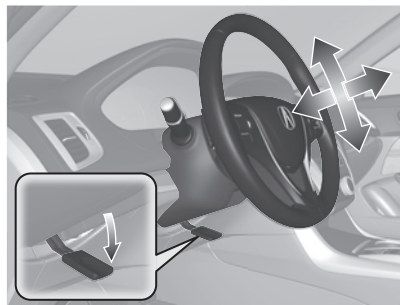

Unlocking the Front Doors from the Inside

➔ P.145

- Pull either front door inner handle to unlock and open it at the same time.



- Unlocking and opening the driver's door from the inner handle unlocks all the other doors.

Trunk P.148

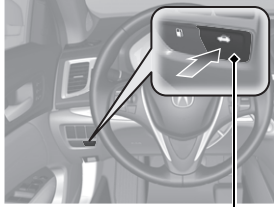

Trunk Opener

- To unlock and open the trunk:
- Press the trunk opener on the driver side control panel.
- Press the trunk release button on the keyless access remote.
- Press the trunk release button on the trunk lid.

Power Door Mirrors

 P.177

- With the power mode in ON, move the selector switch to L or R.
- Push the appropriate edge of the adjustment switch to adjust the mirror.
- Press the folding button* to fold in and out the door mirrors.

Folding Button* Selector Switch

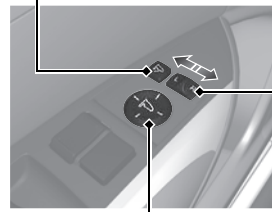

Adjustment Switch

Power Windows P.154

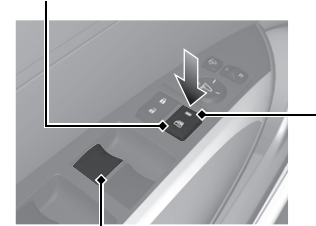

- With the power mode in ON, open and close the power windows.
- If the power window lock button is in the off position, each passenger's window can be opened and closed with its own switch.
- If the power window lock button is in the on position (indicator on), each passenger's window switch is disabled.

Power Window Lock Button Indicator





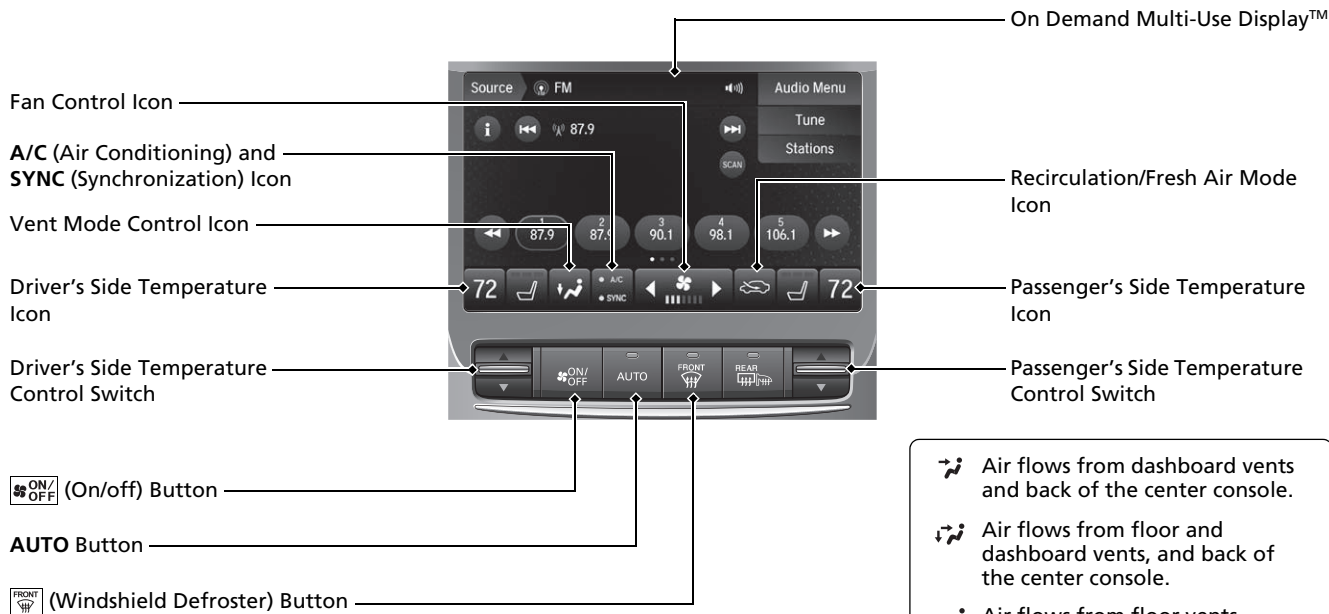

Window Switch

Climate Control System P.204

- Press the **AUTO** button to activate the climate control system.
- Press the  button to turn the system on or off.
- Press the  button or select the **Front**  icon to defrost the windshield.



-  Air flows from dashboard vents and back of the center console.
-  Air flows from floor and dashboard vents, and back of the center console.
-  Air flows from floor vents.
-  Air flows from floor and windshield defroster vents.

Features P.213

Audio System  P.219 For navigation system operation  See the Navigation System Manual



*1:Icons that appear on the screen vary by the source selected.

Audio Remote Controls

➔ P.217

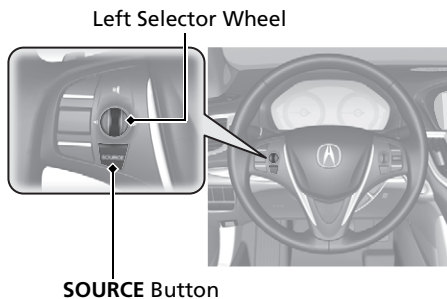

- **SOURCE Button**
Press to change the audio mode: FM/AM/
SiriusXM®/CD/USB/iPod/Apple CarPlay/
Android Auto/*Bluetooth® Audio*/
Pandora®*/AUX.
- **Left Selector Wheel**
Roll to adjust the volume up/down.
Radio: Move to a side to change the
preset station.
Move to a side and hold to select
the next or previous strong station.
CD/USB device:
Move to a side to skip to the
beginning of the next song or
return to the beginning of the
current song.
Move to a side and hold to change
a folder.

Driving P.355

Electronic Gear Selector* P.371

- Always depress the brake pedal before selecting **P** or changing the gear position from **P**.
- Select **P** and depress the brake pedal when starting the engine.
- Gear selection

Gear Position Indicator

The gear position indicator and the shift button indicator indicate the current gear selection.



Gear Position Indicator

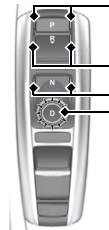
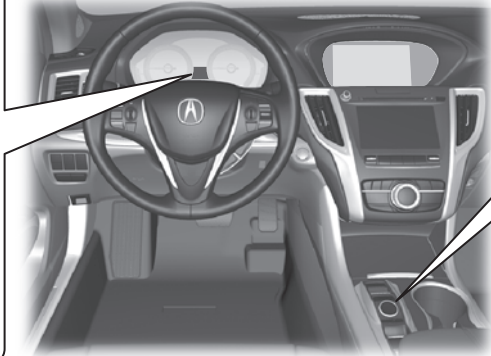

Shift Button Indicator

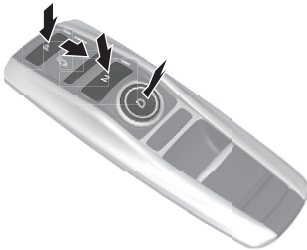

P

Park

Press the **P** button.

Used when parking, before turning off or starting the engine.

Transmission is locked.

R

Reverse

Pull back the **R** button.

Used when reversing.

N

Neutral

Press the **N** button.

Transmission is not locked.

D

Drive

Press the **D** button.

Used for normal driving. The sequential shift mode can be used.

Paddle Shifters

- Paddle shifters allow you to shift gears much like a manual transmission (1st through 9th). This is useful for engine braking.
 - D-paddle shift mode: The transmission will shift back to automatic mode once the system detects that the vehicle is cruising.
 - Sequential mode gear selection: Holds the selected gear, and the **M** (sequential mode) indicator comes on, when the Sport+ mode is on.
 - The sequential mode gear selection is shown in the instrument panel.



Shift Down 
Paddle Shifter



Shift Up 
Paddle Shifter

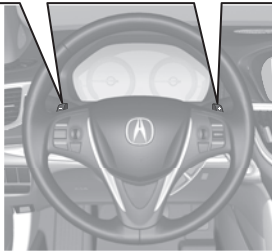

Dual Clutch Transmission*

- Shift to **P** and depress the brake pedal when starting the engine.

● Shifting

P **Park**
Turn off or start the engine.
Transmission is locked.

R **Reverse**
Used when reversing.

N **Neutral**
Transmission is not locked.

D **Drive**
Normal driving. The sequential shift mode can be used.

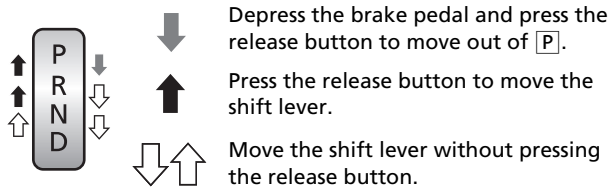

Paddle Shifters

- Paddle shifters allow you to shift gears much like a manual transmission (1st through 8th). This is useful for engine braking.

Shift Lever Position Indicator  M Indicator Selected Gear Number

- D-paddle shift mode: The transmission will shift back to automatic mode once the system detects that the vehicle is cruising.
- Sequential shift mode: Holds the selected gear, and the **M** indicator comes on, when the Sport+ mode is on.
- The selected gear position is shown in the instrument panel.

Shift Down  Paddle Shifter

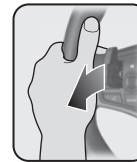

Shift Up  Paddle Shifter

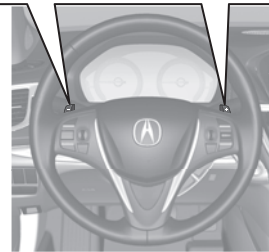

VSA® On and Off P. 419

- The vehicle stability assist (VSA®) system helps stabilize the vehicle during cornering, and helps maintain traction while accelerating on loose or slippery road surfaces.
- VSA® comes on automatically every time you start the engine.
- To partially disable or fully restore VSA® function, press and hold the button until you hear a beep.

CMBS™ On and Off

 P. 440

- When a possible collision is likely unavoidable, the CMBS™ can help you to reduce the vehicle speed and the severity of the collision.
- To turn the CMBS™ on or off, press and hold the button until you hear a beep.

Tire Pressure Monitoring System (TPMS) with Tire Fill Assist P. 425, 553

- The TPMS monitors tire pressure.
- TPMS is turned on automatically every time you start the engine.
- TPMS fill assist provides audible and visual guidance during tire pressure adjustment.

Refueling P. 460

Fuel recommendation: Unleaded premium gasoline, pump octane number 91 or higher

Fuel tank capacity: 17.2 US gal (65 liters)

- 1** Press the fuel fill door release button.

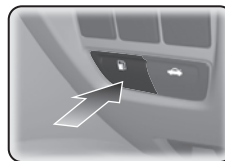

- 2** After refueling, wait for about five seconds before removing the filler nozzle.

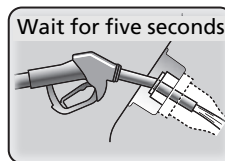

Wait for five seconds



AcuraWatch™

AcuraWatch™ is a driver support system which employs the use of two distinctly different kinds of sensors, a radar sensor located in the front grille and a front sensor camera mounted to the interior side of the windshield, behind the rear view mirror.

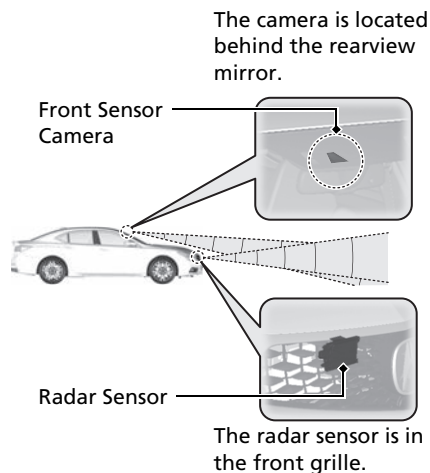

Adaptive Cruise Control (ACC) with Low Speed Follow (LSF) P. 391

Helps maintain a constant vehicle speed and a set following-interval behind a vehicle detected ahead of yours and, if the detected vehicle comes to a stop, can decelerate and stop your vehicle, without you having to keep your foot on the brake or the accelerator.

Road Departure Mitigation (RDM) System P. 405

Alerts and helps to assist you when the system detects a possibility of your vehicle unintentionally crossing over detected lane markings.

Lane Keeping Assist System (LKAS) P. 410

Provides steering input to help keep the vehicle in the middle of a detected lane and provides tactile and visual alerts if the vehicle is detected drifting out of its lane.

Collision Mitigation Braking System™ (CMBS™) P. 437

Can assist you when there is a possibility of your vehicle colliding with a vehicle or a pedestrian detected in front of yours. The CMBS™ is designed to alert you when a potential collision is determined, as well as to reduce your vehicle speed to help minimize collision severity when a collision is deemed unavoidable.

Maintenance ↔ P. 465

Under the Hood ↔ P. 474

- Check engine oil, engine coolant, and windshield washer fluid. Add when necessary.
- Check brake fluid.
- Check the battery condition monthly.

- 1** Pull the hood release handle under the corner of the dashboard.

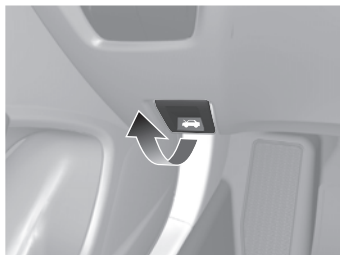

- 2** Locate the hood latch lever, pull it up, and then raise the hood. Once you have raised the hood slightly, you can release the lever.



- 3** When finished, close the hood and make sure it is firmly locked in place.

Wiper Blades ↔ P. 493

- Replace blades if they leave streaks across the windshield.

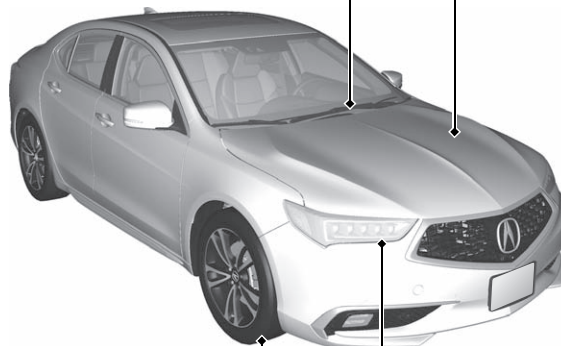

Tires ↔ P. 495

- Inspect tires and wheels regularly.
- Check tire pressures regularly.
- Install snow tires for winter driving.

Lights ↔ P. 488

- Inspect all lights regularly.

Handling the Unexpected ➔ P.517

Flat Tire ➔ P.519

● Vehicles with tire repair kit

Park in a safe location and repair the flat tire using the temporary tire repair kit.

Vehicles with optional spare tire

Park in a safe location and replace the flat tire with the compact spare tire in the trunk.



Engine Won't Start ➔ P.539

- If the battery is dead, jump start using a booster battery.



Overheating ➔ P.547

- Park in a safe location. If you do not see steam under the hood, open the hood, and let the engine cool down.



Indicators Come On

➔ P.549

- Identify the indicator and consult the owner's manual.

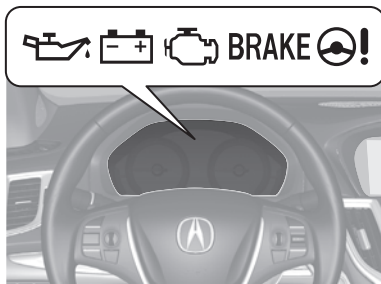

Blown Fuse ➔ P.555

- Check for a blown fuse if an electrical device does not operate.

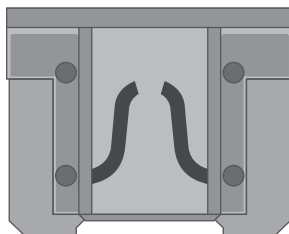

Emergency Towing ➔ P.560

- Call a professional towing service if you need to tow your vehicle.



What to Do If

Q **Canadian models**
The power mode does not change from **VEHICLE OFF (LOCK)** to **ACCESSORY**.
Why?

A

- The steering wheel may be locked.
- Move the steering wheel left and right after pressing the **ENGINE START/STOP** button.



Q **Models with shift lever**
The power mode does not change from **ACCESSORY** to **VEHICLE OFF (LOCK)**.
Why?

A The shift lever should be moved to **P**.



Q Why does the brake pedal pulsate slightly when applying the brakes?

A This can occur when the ABS activates and does not indicate a problem. Apply firm, steady pressure on the brake pedal. Never pump the brake pedal.

➤ Anti-lock Brake System (ABS) ➔ P. 435

Q The rear door cannot be opened from inside the vehicle. Why?

A Check if the childproof lock is in the lock position. If so, open the rear door with the outside door handle.
To cancel this function, slide the lever up to the unlock position.

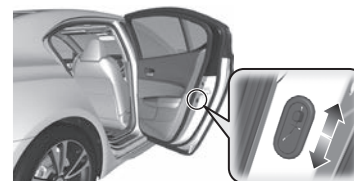

Q Why do the doors lock after I unlocked the doors?

A If you do not open the doors within 30 seconds, the doors are relocked automatically for security.

Q Why does the beeper sound when I open the driver's door?

A The beeper sounds when:

- The power mode is in ACCESSORY.
- The exterior lights are left on.
- The Auto Idle Stop* is in operation.

Q Why does the beeper sound when I start driving?

A The beeper sounds when the driver and/or front passenger are not wearing their seat belts.

Q Pressing the electric parking brake switch does not release the parking brake. Why?

A Press the electric parking brake switch with the brake pedal depressed.

Q Depressing the accelerator pedal does not release the parking brake automatically. Why?

A

- Fasten the driver's seat belt.
- Check if the transmission is in **P** or **N**. If so, select any other position.



Models with electronic gear selector

Why does the gear position automatically change to **P when I open the driver's door to check for parking space lines when reversing?**



- Fasten the driver's seat belt.
- Close the driver's door and manually change the gear position.

▶ When opening the driver's door **P. 373**



Why do I hear a screeching sound when I apply the brake pedal?



The brake pads may need to be replaced. Have your vehicle inspected by a dealer.



I'm seeing an amber indicator of a tire with an exclamation point. What is that?



The Tire Pressure Monitoring System (TPMS) needs attention. Check tire pressure.

▶ If the Low Tire Pressure/TPMS Indicator Comes On or Blinks **P. 553**



Unleaded gasoline with a Pump Octane Number (PON) of 91 or higher is recommended.
Is it possible to use unleaded gasoline with a Pump Octane Number (PON) of 87 or lower on this vehicle?



Unleaded gasoline with a Pump Octane Number (PON) of 91 or higher is recommended.
Use of lower octane gasoline can cause occasional metallic knocking noise in the engine and will result in decreased engine performance.
Use of gasoline with a pump octane less than 87 can lead to engine damage.

Safe Driving

You can find many safety recommendations throughout this chapter, and throughout this manual.

For Safe Driving

| | |
|-------------------------------------|----|
| Important Safety Precautions..... | 30 |
| Your Vehicle's Safety Features..... | 32 |
| Safety Checklist | 33 |

Seat Belts

| | |
|----------------------------|----|
| About Your Seat Belts..... | 34 |
| Fastening a Seat Belt..... | 37 |
| Seat Belt Inspection..... | 40 |

Airbags

| | |
|-------------------------------|----|
| Airbag System Components..... | 41 |
| Types of Airbags..... | 44 |
| Front Airbags (SRS) | 44 |

| | |
|-------------------------------|----|
| Driver's Knee Airbag..... | 48 |
| Side Airbags..... | 50 |
| Side Curtain Airbags..... | 52 |
| Airbag System Indicators..... | 53 |
| Airbag Care | 55 |

Child Safety

| | |
|---|----|
| Protecting Child Passengers | 56 |
| Safety of Infants and Small Children... | 58 |
| Safety of Larger Children | 67 |

Exhaust Gas Hazard

| | |
|--------------------------|----|
| Carbon Monoxide Gas..... | 69 |
|--------------------------|----|

Safety Labels

| | |
|-----------------------|----|
| Label Locations | 70 |
|-----------------------|----|

The following pages explain your vehicle's safety features and how to use them properly. The safety precautions below are ones that we consider to be among the most important.

Important Safety Precautions

■ Always wear your seat belt

A seat belt is your best protection in all types of collisions. Airbags are designed to supplement seat belts, not replace them. So even though your vehicle is equipped with airbags, make sure you and your passengers always wear your seat belts, and wear them properly.

■ Restrain all children

Children ages 12 and under should ride properly restrained in a back seat, not the front seat. Infants and small children should be restrained in a child seat. Larger children should use a booster seat and a lap/shoulder seat belt until they can use the belt properly without a booster seat.

■ Be aware of airbag hazards

While airbags can save lives, they can cause serious or fatal injuries to occupants who sit too close to them, or are not properly restrained. Infants, young children, and short adults are at the greatest risk. Be sure to follow all instructions and warnings in this manual.

■ Don't drink and drive

Alcohol and driving don't mix. Even one drink can reduce your ability to respond to changing conditions, and your reaction time gets worse with every additional drink. So don't drink and drive, and don't let your friends drink and drive, either.

▣ Important Safety Precautions

Some states, provinces and territories prohibit the use of cell phones other than hands-free devices by the driver while driving.

■ **Pay appropriate attention to the task of driving safely**

Engaging in cell phone conversation or other activities that keep you from paying close attention to the road, other vehicles, and pedestrians could lead to a crash. Remember, situations can change quickly, and only you can decide when it is safe to divert some attention away from driving.

■ **Control your speed**

Excessive speed is a major factor in crash injuries and deaths. Generally, the higher the speed, the greater the risk, but serious injuries can also occur at lower speeds. Never drive faster than is safe for current conditions, regardless of the maximum speed posted.

■ **Keep your vehicle in safe condition**

Having a tire blowout or a mechanical failure can be extremely hazardous. To reduce the possibility of such problems, check your tire pressures and condition frequently, and perform all regularly scheduled maintenance.

Your Vehicle's Safety Features

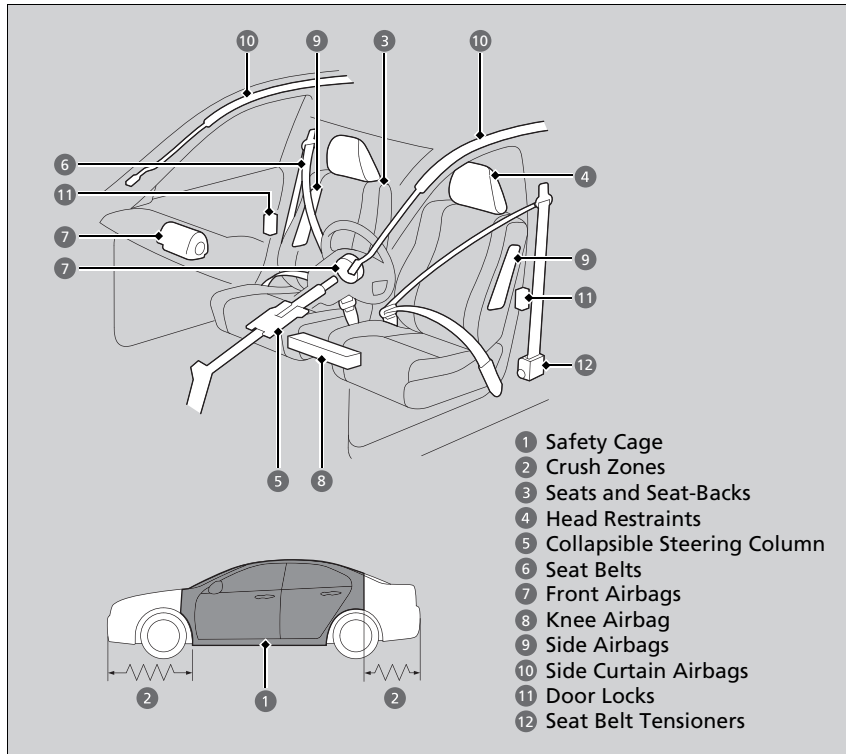

The following checklist will help you take an active role in protecting yourself and your passengers.

► Your Vehicle's Safety Features

Your vehicle is equipped with many features that work together to help protect you and your passengers during a crash.

Some features do not require any action on your part. These include a strong steel framework that forms a safety cage around the passenger compartment, front and rear crush zones, a collapsible steering column, and tensioners that tighten the front seat belts in a sufficient crash.

However, you and your passengers cannot take full advantage of these features unless you remain seated in the correct position and always wear your seat belts. In fact, some safety features can contribute to injuries if they are not used properly.

Safety Checklist

For the safety of you and your passengers, make a habit of checking these items each time before you drive.

- After everyone has entered the vehicle, be sure all doors are closed and locked. Locking the doors helps prevent an occupant from being ejected and an outsider from unexpectedly opening a door.
 - **Locking/Unlocking the Doors from the Inside** P. 144
- Adjust your seat to a position suitable for driving. Be sure the front seats are adjusted as far to the rear as possible while allowing the driver to control the vehicle. Sitting too close to a front airbag can result in serious or fatal injury in a crash.
 - **Adjusting the Seats** P. 179
- Adjust head restraints to the proper position. Head restraints are most effective when the center of the head restraint aligns with the center of your head. Taller persons should adjust their head restraint to the highest position.
 - **Adjusting the Front and Rear Outer Head Restraint Positions** P. 182
- Always wear your seat belt, and make sure you wear it properly. Confirm that any passengers are properly belted as well.
 - **Fastening a Seat Belt** P. 37
- Protect children by using seat belts or child seats according to a child's age, height and weight.
 - **Child Safety** P. 56

☒ Safety Checklist

If the door and/or trunk open message appears on the multi-information display (MID), a door and/or the trunk is not completely closed. Close all doors and the trunk tightly until the message disappears.

➤ **Multi-Information Display Warning and Information Messages** P. 92

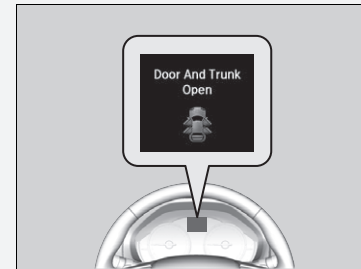

About Your Seat Belts

Seat belts are the single most effective safety device because they keep you connected to the vehicle so that you can take advantage of many built-in safety features. They also help keep you from being thrown against the inside of the vehicle, against any passengers, or out of the vehicle. When worn properly, seat belts also keep your body properly positioned in a crash so that you can take full advantage of the additional protection provided by the airbags.

In addition, seat belts help protect you in almost every type of crash, including:

- frontal impacts
- side impacts
- rear impacts
- rollovers

■ Lap/shoulder seat belts

All five seating positions are equipped with lap/shoulder seat belts with emergency locking retractors. In normal driving the retractor lets you move freely while keeping some tension on the belt. During a collision or sudden stop the retractor locks to restrain your body.

The front passenger's and rear seat belts also have a lockable retractor for use with child seats.

➤ **Installing a Child Seat with a Lap/Shoulder Seat Belt** P. 63

➤ About Your Seat Belts

WARNING

Not wearing a seat belt properly increases the chance of serious injury or death in a crash, even though your vehicle has airbags.

Be sure you and your passengers always wear seat belts and wear them properly.

Seat belts cannot completely protect you in every crash. But in most cases, seat belts can reduce your risk of serious injury.

Most states and all Canadian provinces and territories require you to wear seat belts.

If you extend the seat belt too quickly, it will lock in place. If this happens, slightly retract the seat belt, then extend it slowly.

■ Proper use of seat belts

Follow these guidelines for proper use:

- All occupants should sit upright, well back in the seat, and remain in that position for the duration of the trip. Slouching and leaning reduce the effectiveness of the belt and can increase the chance of serious injury in a crash.
- Never place the shoulder part of a lap/shoulder seat belt under your arm or behind your back. This could cause very serious injuries in a crash.
- Two people should never use the same seat belt. If they do, they could be very seriously injured in a crash.
- Do not put any accessories on the seat belts. Devices intended to improve comfort or reposition the shoulder part of a seat belt can reduce the protective capability and increase the chance of serious injury in a crash.

■ Seat Belt Reminder



The seat belt system includes an indicator on the instrument panel to remind the driver or a front passenger or both to fasten their seat belts.

If you set the power mode to ON and a seat belt is not fastened, a beeper will sound and the indicator will blink. After a few seconds, the beeper will stop and the indicator will come on and remain illuminated until the seat belt is fastened.

The beeper will periodically sound and the indicator will blink while the vehicle is moving until the seat belt is fastened.

⌘ About Your Seat Belts

If a rear seat passenger moves around and extends the seat belt, the lockable retractor may activate. If this happens, release the retractor by unfastening the seat belt and allow the belt to retract completely. Then refasten the belt.

⌘ Seat Belt Reminder

The indicator will also come on if a front passenger does not fasten their seat belt within six seconds after the power mode is set to ON.

When no one is sitting in the front passenger's seat, the indicator will not come on and the beeper will not sound.

The indicator also may not come on and the beeper may not sound when the occupant is not heavy enough to trigger the weight sensor. Such occupants (e.g., infants and smaller children) should be moved to the rear seat as a deploying front airbag likely will injure or kill them.

➤ **Protecting Child Passengers** P. 56

Automatic Seat Belt Tensioners

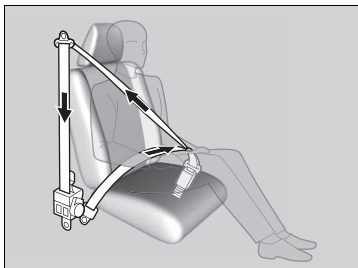

The front seats are equipped with automatic seat belt tensioners to enhance safety.

The tensioners automatically tighten the front seat belts during a moderate-to-severe frontal collision, sometimes even if the collision is not severe enough to inflate the front airbags or the driver's knee airbag.

Automatic Seat Belt Tensioners

The seat belt tensioners can only operate once. If a tensioner is activated, the SRS indicator will come on. Have a dealer replace the tensioner and thoroughly inspect the seat belt system as it may not offer protection in a subsequent crash.

During a moderate-to-severe side impact, the tensioner on that side of the vehicle also activates.

Fastening a Seat Belt

After adjusting a front seat to the proper position, and while sitting upright and well back in the seat:

🔧 **Adjusting the Seats** P. 179

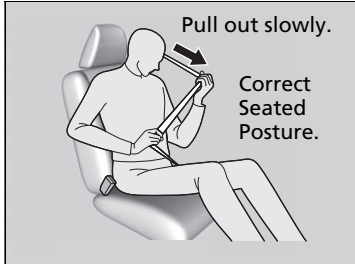

1. Pull the seat belt out slowly.

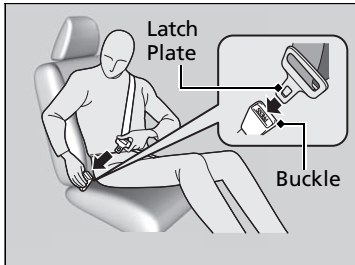

2. Insert the latch plate into the buckle, then tug on the belt to make sure the buckle is secure.

▶ Make sure that the belt is not twisted or caught on anything.

🔧 Fastening a Seat Belt

No one should sit in a seat with an inoperative seat belt or one that does not appear to be working correctly. Using a seat belt that is not working properly may not protect the occupant in a crash. Have a dealer check the belt as soon as possible.

Never insert any foreign objects into the buckle or retractor mechanism.



3. Position the lap part of the belt as low as possible across your hips, then pull up on the shoulder part of the belt so the lap part fits snugly. This lets your strong pelvic bones take the force of a crash and reduces the chance of internal injuries.
4. If necessary, pull up on the belt again to remove any slack, then check that the belt rests across the center of your chest and over your shoulder. This spreads the forces of a crash over the strongest bones in your upper body.

Fastening a Seat Belt

WARNING

Improperly positioning the seat belts can cause serious injury or death in a crash.

Make sure all seat belts are properly positioned before driving.

To release the belt, push the red **PRESS** button and then guide the belt by hand until it has retracted completely. When exiting the vehicle, be sure the belt is properly stowed so that it will not get caught in the closing door.

Adjusting the Shoulder Anchor

The shoulder anchor height can be adjusted to four levels. If the belt contacts your neck, lower the height one level at a time.

After an adjustment, make sure that the shoulder anchor position is secure.

Adjusting the Shoulder Anchor

The front seats have adjustable shoulder anchors to accommodate taller and shorter occupants.

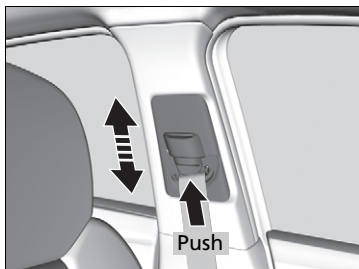

1. Move the anchor up and down while holding the release button.
2. Position the anchor so that the belt rests across the center of your chest and over your shoulder.

Advice for Pregnant Women

If you are pregnant, the best way to protect yourself and your unborn child when driving or riding in a vehicle is to always wear a seat belt and keep the lap part of the belt as low as possible across the hips.

Wear the shoulder belt across the chest avoiding the abdomen.



Wear the lap part of the belt as low as possible across the hips.

Advice for Pregnant Women

Each time you have a checkup, ask your doctor if it is okay for you to drive.

To reduce the risk of injuries to both you and your unborn child that can be caused by an inflating front airbag:

- When driving, sit upright and adjust the seat as far back as possible while allowing full control of the vehicle.
- When sitting in the front passenger's seat, adjust the seat as far back as possible.

Seat Belt Inspection

Regularly check the condition of your seat belts as follows:

- Pull each belt out fully, and look for frays, cuts, burns, and wear.
- Check that the latch plates and buckles work smoothly and the belts retract easily.
 - ▶ If a belt does not retract easily, cleaning the belt may correct the problem. Only use a mild soap and warm water. Do not use bleach or cleaning solvents. Make sure the belt is completely dry before allowing it to retract.

Any belt that is not in good condition or working properly will not provide proper protection and should be replaced as soon as possible.

A belt that has been worn during a crash may not provide the same level of protection in a subsequent crash. Have your seat belts inspected by a dealer after any collision.

Seat Belt Inspection

WARNING

Not checking or maintaining seat belts can result in serious injury or death if the seat belts do not work properly when needed.

Check your seat belts regularly and have any problem corrected as soon as possible.

Airbag System Components

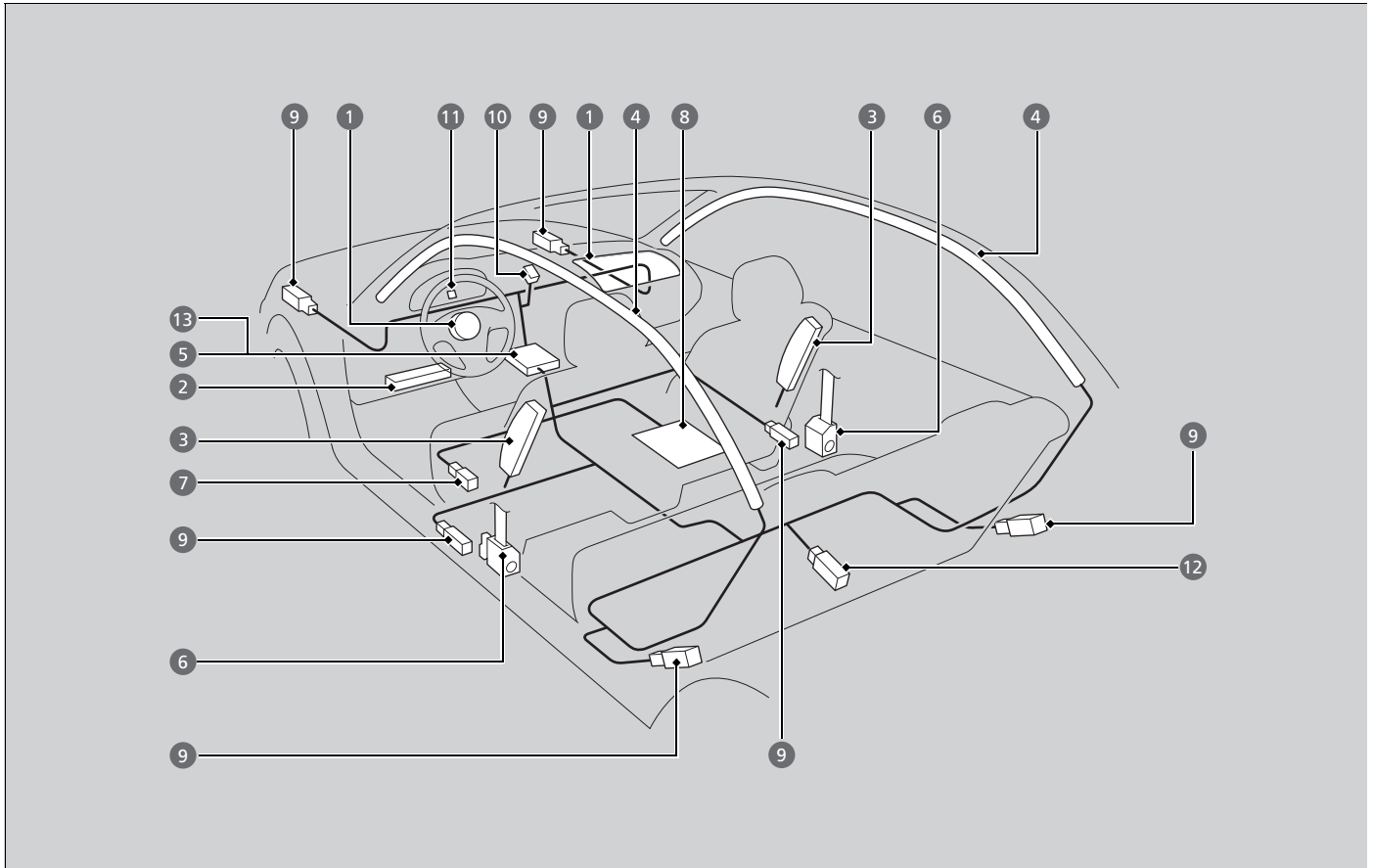

The front, driver's knee, front side, and side curtain airbags are deployed according to the direction and severity of impact. Both side curtain airbags are deployed in a rollover. The airbag system includes:

- 1 Two SRS (Supplemental Restraint System) front airbags. The driver's airbag is stored in the center of the steering wheel; the front passenger's airbag is stored in the dashboard. Both are marked **SRS AIRBAG**.
- 2 Driver's knee airbag. The knee airbag is stored under the steering column. It is marked **SRS AIRBAG**.
- 3 Two side airbags, one for the driver and one for a front passenger. The airbags are stored in the outer edges of the seat-backs. Both are marked **SIDE AIRBAG**.
- 4 Two side curtain airbags, one for each side of the vehicle. The airbags are stored in the ceiling, above the side windows. The front and rear pillars are marked **SIDE CURTAIN AIRBAG**.
- 5 An electronic control unit that, when the vehicle is on, continually monitors information about the various impact sensors, seat and buckle sensors, rollover sensor, airbag activators, seat belt tensioners, and other vehicle information. During a crash event the unit can record such information.
- 6 Automatic front seat belt tensioners. In addition, the driver's and front passenger's seat belt buckles incorporate sensors that detect whether or not the belts are fastened.
- 7 A driver's seat position sensor. If the seat is too far forward, the airbag will inflate with less force.
- 8 Weight sensors in the front passenger's seat. The front passenger's airbag will be turned off if the weight on the seat is approximately 65 lbs (29 kg) or less (the weight of an infant or small child).
- 9 Impact sensors that can detect a moderate-to-severe front or side impact.
- 10 An indicator on the dashboard that alerts you that the front passenger's front airbag has been turned off.
- 11 An indicator on the instrument panel that alerts you to a possible problem with your airbag system or seat belt tensioners.
- 12 Safing Sensor
- 13 A rollover sensor that can detect if your vehicle is about to roll over and signal the control unit to deploy both side curtain airbags.

Important Facts About Your Airbags

Airbags can pose serious hazards. To do their job, airbags must inflate with tremendous force. So, while airbags help save lives, they can cause burns, bruises, and other minor injuries, sometimes even fatal ones if occupants are not wearing their seat belts properly and sitting correctly.

What you should do: Always wear your seat belt properly, and sit upright and as far back from the steering wheel as possible while allowing full control of the vehicle. A front passenger should move their seat as far back from the dashboard as possible.

Remember, however, that no safety system can prevent all injuries or deaths that can occur in a severe crash, even when seat belts are properly worn and the airbags deploy.

Do not place hard or sharp objects between yourself and a front airbag.

Carrying hard or sharp objects on your lap, or driving with a pipe or other sharp object in your mouth, can result in injuries if your front airbag inflates.

Do not attach or place objects on the front and driver's knee airbag covers.

Objects on the covers marked **SRS AIRBAG** could interfere with the proper operation of the airbags or be propelled inside the vehicle and hurt someone if the airbags inflate.

Important Facts About Your Airbags

Do not attempt to deactivate your airbags. Together, airbags and seat belts provide the best protection.

When driving, keep hands and arms out of the deployment path of the front airbag by holding each side of the steering wheel. Do not cross an arm over the airbag cover.

Types of Airbags

Your vehicle is equipped with four types of airbags:

- **Front airbags:** Airbags in front of the driver's and front passenger's seats.
- **Driver's knee airbag:** Airbag under the steering column.
- **Side airbags:** Airbags in the driver's and front passenger's seat-backs.
- **Side curtain airbags:** Airbags above the side windows.

Each is discussed in the following pages.

Front Airbags (SRS)

The front SRS airbags inflate in a moderate-to-severe frontal collision to help protect the head and chest of the driver and/or front passenger.

SRS (Supplemental Restraint System) indicates that the airbags are designed to supplement seat belts, not replace them. Seat belts are the occupant's primary restraint system.

Housing Locations

The front airbags are housed in the center of the steering wheel for the driver, and in the dashboard for the front passenger. Both airbags are marked **SRS AIRBAG**.

Types of Airbags

The airbags can inflate whenever the power mode is in ON.

After an airbag inflates in a crash, you may see a small amount of smoke. This is from the combustion process of the inflator material and is not harmful. People with respiratory problems may experience some temporary discomfort. If this occurs, get out of the vehicle as soon as it is safe to do so.

Front Airbags (SRS)

During a frontal crash severe enough to cause one or both front airbags to deploy, the airbags can inflate at different rates, depending on the severity of the crash, whether or not the seat belts are latched, and/or other factors. Frontal airbags are designed to supplement the seat belts to help reduce the likelihood of head and chest injuries in frontal crashes.

■ Operation

Front airbags are designed to inflate during moderate-to-severe frontal collisions. When the vehicle decelerates suddenly, the sensors send information to the control unit which signals one or both front airbags to inflate.

A frontal collision can be either head-on or angled between two vehicles, or when a vehicle crashes into a stationary object, such as a concrete wall.

■ How the Front Airbags Work

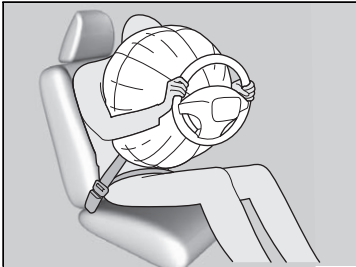

While your seat belt restrains your torso, the front airbag provides supplemental protection for your head and chest.

The front airbags deflate immediately so that they won't interfere with the driver's visibility or the ability to steer or operate other controls.

The total time for inflation and deflation is so fast that most occupants are not aware that the airbags deployed until they see them lying in front of them.

▣ How the Front Airbags Work

Although the driver's and front passenger's airbags normally inflate within a split second of each other, it is possible for only one airbag to deploy. This can happen if the severity of a collision is at the margin, or threshold that determines whether or not the airbags will deploy. In such cases, the seat belt will provide sufficient protection, and the supplemental protection offered by the airbag would be minimal.

■ When front airbags should not deploy

Minor frontal crashes: Front airbags were designed to supplement seat belts and help to save lives, not to prevent minor scrapes, or even broken bones that might occur during a less than moderate-to-severe frontal crash.

Side impacts: Front airbags can provide protection when a sudden deceleration causes a driver or front passenger to move towards the front of the vehicle. Side airbags and side curtain airbags have been specifically designed to help to reduce the severity of injuries that can occur during a moderate-to-severe side impact which can cause the driver or passenger to move towards the side of the vehicle.

Rear impacts: Head restraints and seat belts are your best protection during a rear impact. Front airbags cannot provide any significant protection and are not designed to deploy in such collisions.

Rollovers: In a rollover, your best form of protection is a seat belt or, if your vehicle is equipped with a rollover sensor, both a seat belt and a side curtain airbag. Front airbags, however, are not designed to deploy in a rollover as they would provide little if any protection.

■ When front airbags deploy with little or no visible damage

Because the airbag system senses sudden deceleration, a strong impact to the vehicle framework or suspension might cause one or more of the airbags to deploy. Examples include running into a curb, the edge of a hole, or other low fixed object that causes a sudden deceleration in the vehicle chassis. Since the impact is underneath the vehicle, damage may not be readily apparent.

■ When front airbags may not deploy, even though exterior damage appears severe

Since crushable body parts absorb crash energy during an impact, the amount of visible damage does not always indicate proper airbag operation. In fact, some collisions can result in severe damage but no airbag deployment because the airbags would not have been needed or would not have provided protection even if they had deployed.

Advanced Airbags

The airbags have advanced features to help reduce the likelihood of airbag related injuries to smaller occupants.

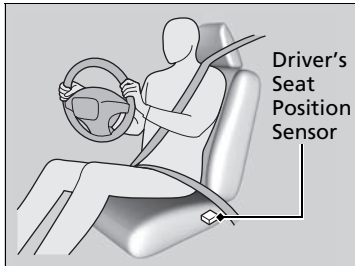

The driver's advanced airbag system includes a seat position sensor.

Based on information from this sensor and the severity of the impact, the advanced airbag system determines the optimal deployment of the driver's airbag.

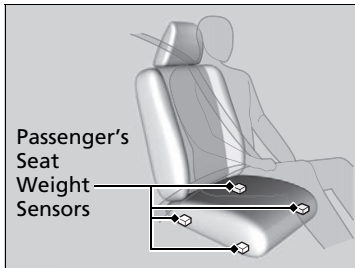

The front passenger's advanced airbag system has weight sensors.

We advise against allowing a child age 12 or under to ride in the front passenger's seat. However, ***if you do allow a child age 12 or under to ride in the front passenger's seat***, note that the system will automatically turn off the front passenger's airbag if the sensors detect that the child is approximately 65 lbs (29 kg) or less.

Advanced Airbags

If there is a problem with the driver's seat position sensor, the SRS indicator will come on and the airbag will inflate with full (normal) force, regardless of the driver's seating position.

For the advanced airbags to work properly:

- Do not spill any liquid on or under the seats.
- Do not put any object under the passenger's seat.
- Make sure any objects are positioned properly on the floor. Improperly positioned objects can interfere with the advanced airbag sensors.
- All occupants should sit upright and wear their seat belts properly.
- Do not cover the passenger's side dashboard with a cloth, towel, cover, etc.

Passenger Front Airbag Off Indicator

P. 54

Make sure the floor mat behind the front passenger's seat is hooked to the floor mat anchor. An improperly placed mat can interfere with the advanced airbag sensors.

Floor Mats P. 510

Driver's Knee Airbag

The driver's knee SRS airbag inflates in a moderate-to-severe frontal collision to help keep the driver in the proper position and to help maximize the benefit provided by the vehicle's other safety features.

SRS (Supplemental Restraint System) indicates that the airbag is designed to supplement seat belts, not replace them. Seat belts are the occupant's primary restraint system.

Housing Locations

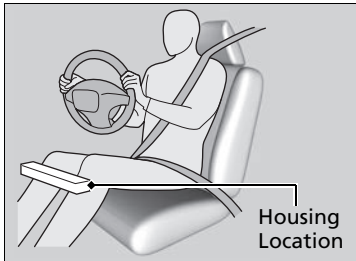

The driver's knee airbag is housed under the steering column.

The airbag is marked **SRS AIRBAG**.

Operation

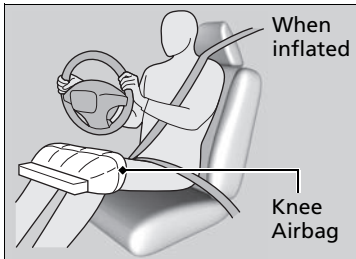

When the driver's front airbag inflates, the driver's knee airbag also inflates.

Even if the collision is not severe enough to deploy the front airbag, the knee airbag may inflate alone.

Driver's Knee Airbag

Do not attach accessories on or near the driver's knee airbag. They can interfere with the proper operation of the airbag, or hurt someone if an airbag inflates.

■ When driver's knee airbag deploys with little or no visible damage

Because the airbag system senses sudden deceleration, a strong impact to the vehicle framework or suspension might cause one or more of the airbags to deploy. Examples include running into a curb, the edge of a hole, or other low fixed object that causes a sudden deceleration in the vehicle chassis. Since the impact is underneath the vehicle, damage may not be readily apparent.

■ When driver's knee airbag may not deploy, even though exterior damage appears severe

Since crushable body parts absorb crash energy during an impact, the amount of visible damage does not always indicate proper airbag operation. In fact, some collisions can result in severe damage but no airbag deployment because the airbags would not have been needed or would not have provided protection even if they had deployed.

Side Airbags

The side airbags help protect the torso and pelvis of the driver or a front passenger during a moderate-to-severe side impact.

Housing Locations

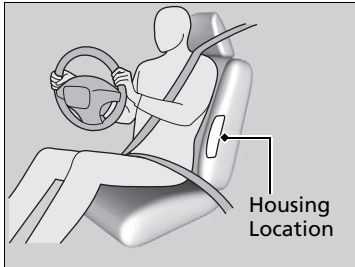

The side airbags are housed in the outside edge of the driver's and passenger's seat-backs.

Both are marked **SIDE AIRBAG**.

Operation

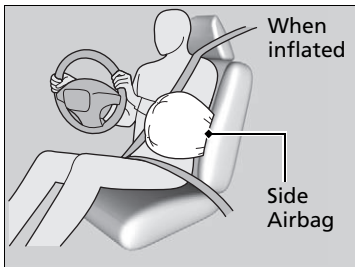

When the sensors detect a moderate-to-severe side impact, the control unit signals the side airbag on the impact side to immediately inflate.

Side Airbags

Make sure you and your front seat passenger always sit upright. Leaning into the path of a side airbag can prevent the airbag from deploying properly and increases your risk of serious injury.

Do not attach accessories on or near the side airbags. They can interfere with the proper operation of the airbags, or hurt someone if an airbag inflates.

Do not cover or replace the front seat-back covers without consulting a dealer. Improperly replacing or covering front seat-back covers can prevent your side airbags from properly deploying during a side impact.

■ When a side airbag deploys with little or no visible damage

Because the airbag system senses sudden acceleration, a strong impact to the side of the vehicle's framework can cause a side airbag to deploy. In such cases, there may be little or no damage, but the side impact sensors detected a severe enough impact to deploy the airbag.

■ When a side airbag may not deploy, even though visible damage appears severe

It is possible for a side airbag to not deploy during an impact that results in apparently severe damage. This can occur when the point of impact was toward the far front or rear of the vehicle, or when the vehicle's crushable body parts absorbed most of the crash energy. In either case, the side airbag would not have been needed nor provided protection even if it had deployed.

Side Curtain Airbags

The side curtain airbags help protect the heads of the driver and passengers in the outer seating positions during a moderate-to-severe side impact. The side curtain airbags equipped in this vehicle are also designed to help reduce the likelihood of partial and complete ejection of vehicle occupants through side windows in crashes, particularly rollover crashes.

Housing Locations

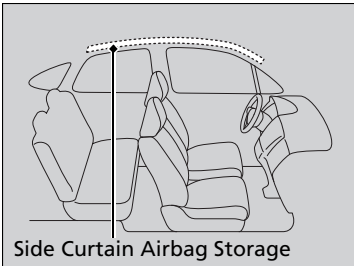

The side curtain airbags are located in the ceiling above the side windows on both sides of the vehicle.

Operation

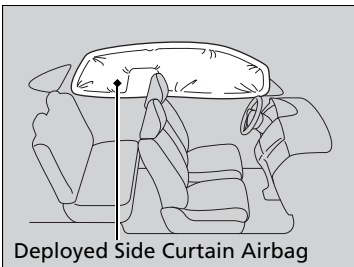

The side curtain airbag is designed to deploy in a rollover or a moderate-to-severe side impact.

Side Curtain Airbags

If the SRS control unit senses that your vehicle is about to rollover, it immediately deploys both side curtain airbags and activates both front seat belt tensioners.

If the impact is on the passenger's side, the passenger's side curtain airbag deploys even if there is no passenger in the passenger seat.

To get the best protection from the side curtain airbags, occupants should wear their seat belts properly and sit upright and well back in their seats.

Do not attach any objects to the side windows or roof pillars as they can interfere with the proper operation of the side curtain airbags.

■ When side curtain airbags deploy in a frontal collision

One or both side curtain airbags may also inflate in a moderate-to-severe angled frontal collision.

Airbag System Indicators

If a problem occurs in the airbag system, the SRS indicator will come on and a message appears on the multi-information display.

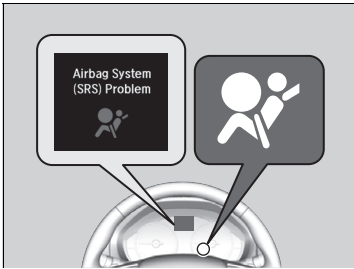
■ Supplemental Restraint System (SRS) Indicator**■ When the power mode is set to ON**

The indicator comes on for a few seconds, then goes off. This tells you the system is working properly.

If the indicator comes on at any other time, or does not come on at all, have the system checked by a dealer as soon as possible. If you don't, your airbags and seat belt tensioners may not work properly when they are needed.

⌘ Supplemental Restraint System (SRS) Indicator

⚠ WARNING

Ignoring the SRS indicator can result in serious injury or death if the airbag systems or tensioners do not work properly.

Have your vehicle checked by a dealer as soon as possible if the SRS indicator alerts you to a possible problem.

Continued

■ Passenger Front Airbag Off Indicator

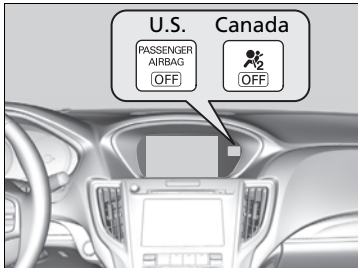

■ When the passenger front airbag off indicator comes on

The indicator comes on to alert you that the passenger's front airbag has been turned off. This occurs when the weight sensors detect about 65 lbs (29 kg) or less, the weight of an infant or small child, on the seat.

Children age 12 or under should always ride properly restrained in a back seat.

➤ **Child Safety** P. 56

Objects placed on the seat can also cause the indicator to come on.

If the front passenger seat is empty, the passenger's front airbag will not deploy and the indicator will not come on.

☒ Passenger Front Airbag Off Indicator

If the indicator comes on with no front passenger and no objects on the passenger's seat, or with an adult riding there, something may be interfering with the weight sensor, such as:

- An object hanging on the seat or in the seat-back pocket.
- A child seat or other object pressing against the rear of the seat-back.
- A rear passenger pushing or pulling on the back of the front passenger's seat.
- The front seat or seat-back is forced back against an object on the seat or floor behind it.
- An object placed under the front passenger's seat.

If none of these conditions exist, have your vehicle checked by a dealer as soon as possible.

The passenger airbag off indicator may come on and go off repeatedly if the total weight on the seat is near the airbag cutoff threshold.

Airbag Care

You do not need to, and should not, perform any maintenance on or replace any airbag system components yourself. However, you should have your vehicle inspected by a dealer in the following situations:

■ When the airbags have deployed

If an airbag has inflated, the control unit and other related parts must be replaced. Similarly, once an automatic seat belt tensioner has been activated, it must be replaced.

■ When the vehicle has been in a moderate-to-severe collision

Even if the airbags did not inflate, have your dealer inspect the following: the driver's seat position sensor, weight sensors in the passenger's seat, front seat belt tensioners, and each seat belt that was worn during the crash.

■ Do not remove or modify a front seat without consulting a dealer

This would likely disable or affect the proper operation of the driver's seat position sensor or the weight sensors in the passenger's seat. If it is necessary to remove or modify a front seat to accommodate a person with disabilities, contact an Acura dealer, or for U.S. vehicles, Acura Client Relations at 1-800-382-2238 and for Canadian vehicles, Acura Client Services at 1-888-9-ACURA-9.

✘ Airbag Care

We recommend against the use of salvaged airbag system components, including the airbag, tensioners, sensors, and control unit.

Protecting Child Passengers

Each year, many children are injured or killed in vehicle crashes because they are either unrestrained or not properly restrained. In fact, vehicle crashes are the number one cause of death of children ages 12 and under.

To reduce the number of child deaths and injuries, every state, Canadian province and territory requires that infants and children be properly restrained when they ride in a vehicle.

Children should sit properly restrained in a rear seat. This is because:

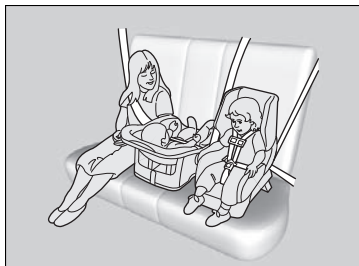

- An inflating front or side airbag can injure or kill a child sitting in the front seat.
- A child in the front seat is more likely to interfere with the driver's ability to safely control the vehicle.
- Statistics show that children of all sizes and ages are safer when they are properly restrained in a rear seat.

Protecting Child Passengers

⚠ WARNING

Children who are unrestrained or improperly restrained can be seriously injured or killed in a crash.

Any child too small for a seat belt should be properly restrained in a child seat. A larger child should be properly restrained with a seat belt, using a booster seat if necessary.

The National Highway Traffic Safety Administration and Transport Canada recommend that all children ages 12 and under be properly restrained in a rear seat. Some states or provinces/territories have laws restricting where children may ride.

- Any child who is too small to wear a seat belt correctly must be restrained in an approved child seat that is properly secured to the vehicle using either the seat belt or the lower anchors of the LATCH system.
- Never hold a child on your lap because it is impossible to protect them in the event of a collision.
- Never put a seat belt over yourself and a child. During a crash, the belt would likely press deep into the child and cause serious or fatal injuries.
- Never let two children use the same seat belt. Both children could be very seriously injured in a crash.
- Do not allow children to operate the doors, windows or seat adjustments.
- Do not leave children in the vehicle unattended, especially in hot weather when the inside of the vehicle can get hot enough to kill them. They could also activate vehicle controls causing it to move unexpectedly.

▶▶ Protecting Child Passengers

⚠ WARNING

Allowing a child to play with a seat belt or wrap one around their neck can result in serious injury or death.

Instruct children not to play with any seat belt and make sure any unused seat belt a child can reach is buckled, fully retracted, and locked.

To deactivate a lockable retractor, release the buckle and allow the seat belt to wind up all the way.

To remind you of the passenger's front airbag hazards and child safety, your vehicle has warning labels on the dashboard (U.S. models) and on the front visors. Please read and follow the instructions on these labels.

▶▶ **Safety Labels** P. 70

Safety of Infants and Small Children

■ Protecting Infants

An infant must be properly restrained in a rear-facing, reclining child seat until the infant reaches the seat manufacturer's weight or height limit for the seat, and the infant is at least one year old.

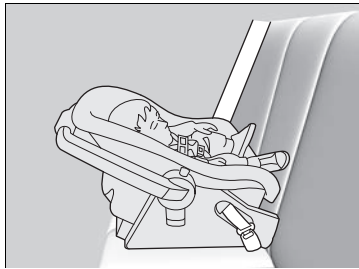

■ Positioning a rear-facing child seat

Child seats must be placed and secured in a rear seating position.

When properly installed, a rear-facing child seat may prevent the driver or a front passenger from moving their seat all the way back, or from locking their seat-back in the desired position.

It can also interfere with proper operation of the passenger's advanced front airbag system.

➤ **Airbags** P. 41

If this occurs, we recommend that you install the child seat directly behind the front passenger's seat, move the seat as far forward as needed, and leave it unoccupied. Or, you may wish to get a smaller rear-facing child seat.

▶▶ Protecting Infants

⚠ WARNING

Placing a rear-facing child seat in the front seat can result in serious injury or death during a crash.

Always place a rear-facing child seat in the rear seat, not the front.

Many experts recommend use of a rear-facing seat for a child up to two years old if the child's height and weight are appropriate for a rear-facing seat.

Rear-facing child seats should never be installed in a forward facing position.

Always refer to the child seat manufacturer's instructions before installation.

■ Protecting Smaller Children

If a child is at least one year old and has exceeded the weight and height limitations of a rearward facing child seat, the child should be properly restrained in a firmly secured forward facing child seat until they exceed the weight and height limitations for the forward facing child seat.

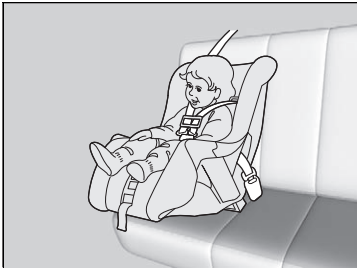

■ Forward-facing child seat placement

We strongly recommend placing a forward-facing child seat in a rear seating position.

Placing a forward-facing child seat in the front seat can be hazardous, even with advanced front airbags that automatically turn the passenger's front airbag off. A rear seat is the safest place for a child.

⚠ Protecting Smaller Children

⚠ WARNING

Placing a forward-facing child seat in the front seat can result in serious injury or death if the front airbag inflates.

If you must place a forward-facing child seat in front, move the vehicle seat as far back as possible, and properly restrain the child.

Educate yourself about the laws and regulations regarding child seat use where you are driving, and follow the child seat manufacturer's instructions.

■ Selecting a Child Seat

Most child seats are LATCH-compatible (Lower Anchors and Tethers for Children). Some have a rigid-type connector while others have a flexible-type connector. Both are equally easy to use. Some existing and previously owned child seats can only be installed using the seat belt. Whichever type you choose, follow the child seat manufacturer's use and care instructions including recommended expiration dates as well as the instructions in this manual. Proper installation is key to maximizing your child's safety.

In seating positions and vehicles not equipped with LATCH, a LATCH-compatible child seat can be installed using the seat belt and a top tether for added security. This is because all child seats are required to be designed so that they can be secured with a lap belt or the lap part of a lap/shoulder belt. In addition, the child seat manufacturer may advise that a seat belt be used to attach a LATCH-compatible seat once a child reaches a specified weight. Please read the child seat owner's manual for proper installation instructions.

■ Important consideration when selecting a child seat

Make sure the child seat meets the following three requirements:

- The child seat is the correct type and size for the child.
- The child seat is the correct type for the seating position.
- The child seat is compliant with Federal Motor Vehicle Safety Standard 213 or Canadian Motor Vehicle Safety Standard 213.

▶▶ Selecting a Child Seat

Installation of a LATCH-compatible child seat is simple.

LATCH-compatible child seats have been developed to simplify the installation process and reduce the likelihood of injuries caused by incorrect installation.

■ Installing a LATCH-Compatible Child Seat

A LATCH-compatible child seat can be installed in either of the two outer rear seats. A child seat is attached to the lower anchors with either the flexible or rigid type of connectors.

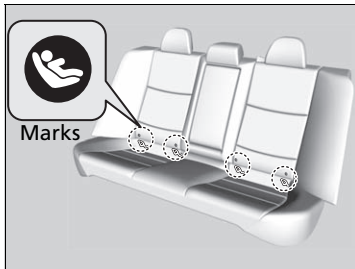

1. Locate the lower anchors under the marks.

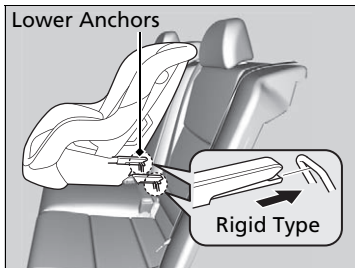

2. Place the child seat on the vehicle seat, then attach the child seat to the lower anchors according to the instructions that came with the child seat.

▶ When installing the child seat, make sure that the lower anchors are not obstructed by the seat belt or any other object.

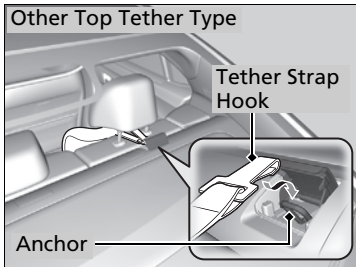
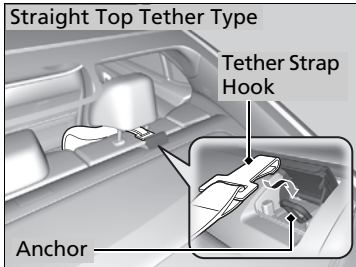
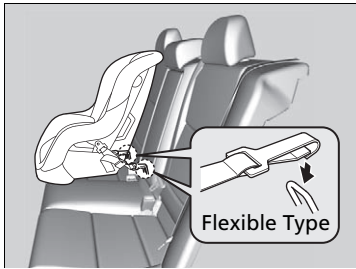

3. Open the tether anchor cover behind the head restraint.
4. Raise the head restraint to its highest position, then route the tether strap between the head restraint legs, and secure the tether strap hook to the anchor.
5. Tighten the tether strap as instructed by the child seat manufacturer.
6. Make sure the child seat is firmly secured by rocking it forward and back and side to side; little movement should be felt.
7. Make sure any unused seat belt that a child can reach is buckled, the lockable retractor is activated, and the belt is fully retracted and locked.

►► Installing a LATCH-Compatible Child Seat

For your child's safety, when using a child seat installed using the LATCH system, make sure that the child seat is properly secured to the vehicle. A child seat that is not properly secured will not adequately protect a child in a crash and may cause injury to the child or other vehicle occupants.

■ Installing a Child Seat with a Lap/Shoulder Seat Belt



1. Place the child seat on the vehicle seat.
2. Route the seat belt through the child seat according to the seat manufacturer's instructions, and insert the latch plate into the buckle.
 - ▶ Insert the latch plate fully until it clicks.

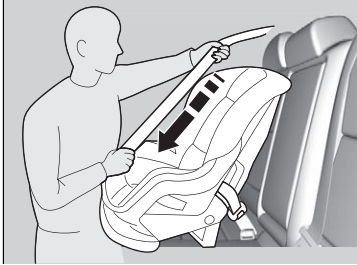

3. Slowly pull the shoulder part of the belt all the way out until it stops. This activates the lockable retractor.
4. Let the seat belt retract a few inches and check that the retractor has switched modes by pulling on the webbing. It should not pull out again until it is reset by removing the latch plate from the buckle.
 - ▶ If you are able to pull the shoulder belt out, the lockable retractor is not activated. Slowly pull the seat belt all the way out, and repeat steps 3 – 4.

⊠ Installing a Child Seat with a Lap/Shoulder Seat Belt

A child seat that is not properly secured will not adequately protect a child in a crash and may cause injury to the child or other vehicle occupants.

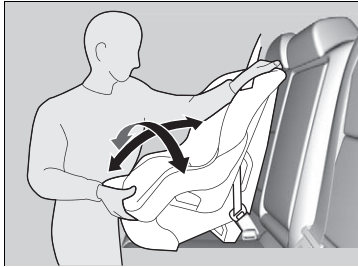
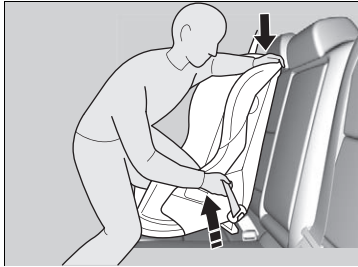

5. Grab the shoulder part of the seat belt near the buckle, and pull up to remove any slack from the lap part of the belt.
 - ▶ When doing this, place your weight on the child seat and push it into the vehicle seat.
6. Make sure the child seat is firmly secured by rocking it forward and back and side to side; little movement should be felt.
7. Make sure any unused seat belt that a child can reach is buckled, the lockable retractor is activated, and the belt is fully retracted and locked.

▶▶ Installing a Child Seat with a Lap/Shoulder Seat Belt

To deactivate a lockable retractor, release the buckle and allow the seat belt to wind up all the way.

■ Adding Security with a Tether

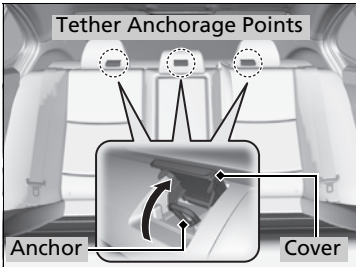

A tether anchorage point is provided behind each rear seating position. If you have a child restraint system that comes with a tether but can be installed with a seat belt, the tether may be used for additional security.

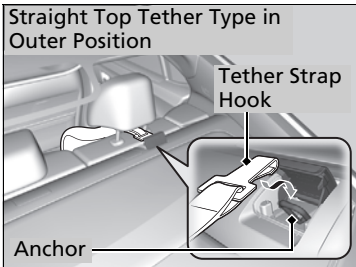

1. Locate the appropriate tether anchorage point and lift the cover.
2. Raise the head restraint to its highest position, then route the tether strap through the head restraint legs. Make sure the strap is not twisted.

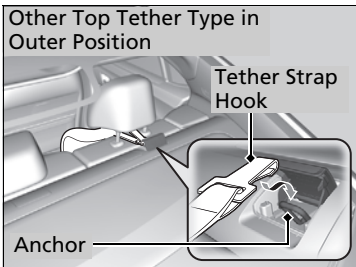

3. Secure the tether strap hook to the anchor.
4. Tighten the tether strap as instructed by the child seat manufacturer.

▣ Adding Security with a Tether

Always use a tether for forward facing child seats when using the seat belt or lower anchors.

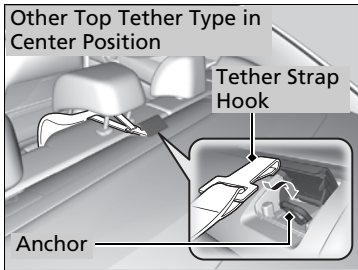
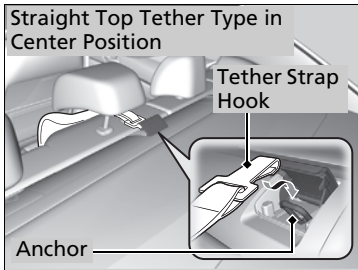

Safety of Larger Children

■ Protecting Larger Children

The following pages give instructions on how to check proper seat belt fit, what kind of booster seat to use if one is needed, and important precautions for a child who must sit in front.

■ Checking Seat Belt Fit

When a child is too big for a child seat, secure the child in a rear seat using the lap/shoulder seat belt. Have the child sit upright and all the way back, then answer the following questions.



■ Checklist

- Do the child's knees bend comfortably over the edge of the seat?
- Does the shoulder belt cross between the child's neck and arm?
- Is the lap part of the seat belt as low as possible, touching the child's thighs?
- Will the child be able to stay seated like this for the whole trip?

If you answer yes to all these questions, the child is ready to wear the lap/shoulder seat belt correctly. If you answer no to any question, the child needs to ride on a booster seat until the seat belt fits properly without a booster seat.

▶▶ Safety of Larger Children

⚠ WARNING

Allowing a child age 12 or under to sit in front can result in injury or death if the passenger's front airbag inflates.

If a larger child must ride in front, move the vehicle seat as far to the rear as possible, have the child sit up properly and wear the seat belt properly, using a booster seat if needed.

Booster Seats

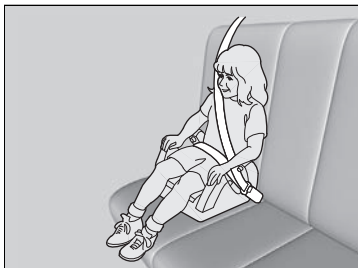

If a lap/shoulder seat belt cannot be used properly, position the child in a booster seat in the rear seat. For the child's safety, check that the child meets the booster seat manufacturer's recommendations.

Protecting Larger Children-Final Checks

Your vehicle has a rear seat where children can be properly restrained. If you ever have to carry a group of children, and a child must ride in front:

- Make sure you read and fully understand the instructions and safety information in this manual.
- Move the front passenger seat as far back as possible.
- Have the child sit upright and well back in the seat.
- Check that the seat belt is properly positioned so that the child is secure in the seat.

Monitoring child passengers

We strongly recommend that you keep an eye on child passengers. Even older, more mature children sometimes need to be reminded to fasten their seat belts and sit up properly.

Booster Seats

When installing a booster seat, make sure to read the instructions that came with it, and install the seat accordingly.

There are high- and low-type booster seats. Choose a booster seat that allows the child to wear the seat belt correctly.

Some U.S. states, and Canadian provinces and territories require children to use a booster seat until they reach a given age or weight (e.g. 6 years or 60 lbs). Be sure to check current laws in the state or province, or territory where you intend to drive.

Carbon Monoxide Gas

The engine exhaust from this vehicle contains carbon monoxide, a colorless, odorless, and highly toxic gas. As long as you properly maintain your vehicle, carbon monoxide gas will not get into the interior.

■ Have the exhaust system inspected for leaks whenever

- The exhaust system is making an unusual noise.
- The exhaust system may have been damaged.
- The vehicle is raised for an oil change.

When you operate a vehicle with the trunk open, airflow can pull exhaust gas into the interior and create a hazardous condition. If you must drive with the trunk open, open all the windows and set the climate control system as shown below.

1. Select the fresh air mode.
2. Select the  mode.
3. Set the fan speed to high.
4. Set the temperature control to a comfortable setting.

Adjust the climate control system in the same manner if you sit in your parked vehicle with the engine running.

Carbon Monoxide Gas

⚠ WARNING

Carbon monoxide gas is toxic.

Breathing it can cause unconsciousness and even kill you.

Avoid any enclosed areas or activities that expose you to carbon monoxide.

An enclosed area such as a garage can quickly fill up with carbon monoxide gas. Do not run the engine with the garage door closed. Even when the garage door is open, drive out of the garage immediately after starting the engine.

Label Locations

These labels are in the locations shown. They warn you of potential hazards that can cause serious injury or death. Read these labels carefully.

If a label comes off or becomes hard to read (except for the U.S. dashboard label which may be removed by the owner), contact a dealer for a replacement.

Sun Visors

U.S. models

⚠ WARNING

EVEN WITH ADVANCED AIR BAGS



- Children can be killed or seriously injured by the air bag.
- The back seat is the safest place for children.
- Never put a rear-facing child seat in the front.
- Always use seat belts and child restraints.
- See owner's manual for more information about air bags.

Canadian models

| ⚠ WARNING | ⚠ ATTENTION |
|---|--|
| <p>To avoid serious injury</p> <ul style="list-style-type: none"> ■ For maximum safety protection in all types of crashes, you must always wear your safety belt. ■ Do not install rearward-facing child seats in any front passenger seat position. ■ Do not sit or lean unnecessarily close to the air bag. ■ Do not place any objects over the air bag or between the air bag and yourself. ■ See the owner's manual for further information and explanations. | <p>Pour éviter des blessures graves</p> <ul style="list-style-type: none"> ■ Pour profiter d'une protection maximale lors d'une collision bouclez toujours votre ceinture de sécurité. ■ N'installez jamais un siège pour enfants faisant face à l'arrière sur le siège du passager avant. ■ Ne vous appuyez pas et ne vous assoyez pas près du coussin gonflable. ■ Ne déposez aucun objet sur le coussin gonflable ou entre le coussin gonflable et vous. ■ Lisez le guide utilisateur pour de plus amples renseignements. |

Dashboard U.S. models only

This Vehicle is Equipped with Advanced Air Bags

Even with Advanced Air Bags
Children can be killed or seriously injured by the air bag.
The back seat is the safest place for children.
Never put a rear-facing child seat in the front.
Always use seat belts and child restraints.
See owner's manual for more information about air bags.
to be retained by owner only.

Radiator Cap

DANGER
WARNING

危險
危險

NEVER OPEN WHEN HOT.
Hot coolant will scald you.
N'OUVREZ PAS QUAND CHAUD.
Nicht beheissen Motor öffnen.
熱い冷却液がやけどをします。
高温時、絶対に開かず。
TOB-170

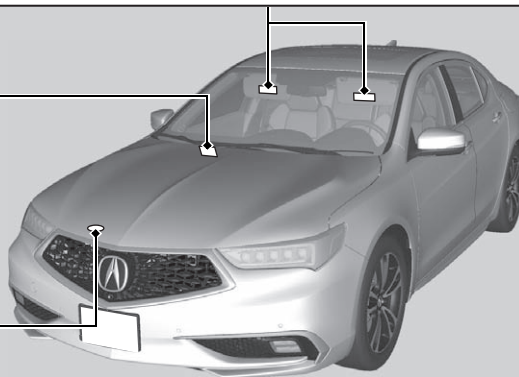







Instrument Panel





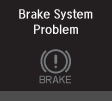

This chapter describes the buttons, indicators, and gauges that are used while driving.

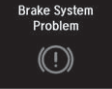
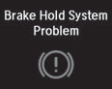









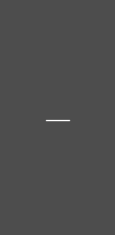

| | |
|--|-----|
| Indicators | 72 |
| Multi-Information Display Warning and Information Messages..... | 92 |
| Gauges and Multi-Information Display .. | 113 |
| Gauges..... | 113 |
| Multi-Information Display | 114 |

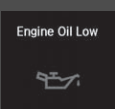
Indicators

| Indicator | Name | On/Blinking | Explanation | Message |
|---|--------------------------------|---|---|---|
|  | Brake System Indicator (Red) | <ul style="list-style-type: none"> Comes on for a few seconds when you set the power mode to ON, then goes off. Comes on when the brake fluid level is low. Comes on if there is a problem with the brake system. | <ul style="list-style-type: none"> Comes on while driving - Check the brake fluid level. <ul style="list-style-type: none"> ➤ What to do when the indicator comes on while driving P. 550 Comes on along with the ABS indicator - Have your vehicle checked by a dealer. <ul style="list-style-type: none"> ➤ If the Brake System Indicator (Red) Comes On P. 550 |   |
|  | Brake System Indicator (Amber) | <ul style="list-style-type: none"> Comes on for a few seconds when you set the power mode to ON, then goes off. Comes on if there is a problem with a system related to braking other than the conventional brake system. Comes on if there is a problem with the automatic brake hold system. | <ul style="list-style-type: none"> Comes on while driving - Have your vehicle checked by a dealer. With this indicator on, your vehicle still has normal braking ability. |     |





| Indicator | Name | On/Blinking | Explanation | Message |
|---|---|--|---|---|
|  | Electric Parking Brake Indicator | <ul style="list-style-type: none"> • Comes on for a few seconds when you set the power mode to ON, then goes off. • Comes on when the parking brake is applied, and goes off when it is released. • Comes on when you try to drive with the parking brake applied. • Comes on for about 15 seconds then goes off when you pull the electric parking brake switch with the power mode in OFF. • Comes on for about 15 seconds then goes off when you set the power mode to OFF with the parking brake applied. | <ul style="list-style-type: none"> • Blinks and the electric parking brake system indicator comes on at the same time - There is a problem with the electric parking brake system. The parking brake may not be set. • Release the Parking Brake manually or automatically. <ul style="list-style-type: none"> ➤ Parking Brake P. 429 |  |
|  | Electric Parking Brake System Indicator | <ul style="list-style-type: none"> • Comes on when you push the electric parking brake switch without depressing the brake pedal. | <ul style="list-style-type: none"> • Depress the brake pedal to release the parking brake. <ul style="list-style-type: none"> ➤ Parking Brake P. 429 |  |
|  | Electric Parking Brake System Indicator | <ul style="list-style-type: none"> • Comes on for a few seconds when you set the power mode to ON, then goes off. • Comes on if there is a problem with the electric parking brake system. | <ul style="list-style-type: none"> • Comes on while driving - Avoid using the parking brake and have your vehicle checked by a dealer immediately. <ul style="list-style-type: none"> ➤ If the Electric Parking Brake System Indicator Comes On P. 552 |  |

| Indicator | Name | On/Blinking | Explanation | Message |
|---|---------------------------------------|--|---|---|
|  | Automatic Brake Hold System Indicator | <ul style="list-style-type: none"> • Comes on for a few seconds when you set the power mode to ON, then goes off. • Comes on when the automatic brake hold system is on. | <ul style="list-style-type: none"> ➤ Automatic Brake Hold P. 433 |  |
|  | Automatic Brake Hold Indicator | <ul style="list-style-type: none"> • Comes on for a few seconds when you set the power mode to ON, then goes off. • Comes on when the automatic brake hold is activated. | <ul style="list-style-type: none"> ➤ Automatic Brake Hold P. 433 |  |
|  | Low Oil Pressure Indicator | <ul style="list-style-type: none"> • Comes on when you set the power mode to ON, and goes off when the engine starts. • Comes on when the engine oil pressure is low. | <ul style="list-style-type: none"> • Comes on while driving - Immediately stop in a safe place. ➤ If the Low Oil Pressure Indicator Comes On P. 549 |  |



| Indicator | Name | On/Blinking | Explanation | Message |
|---|--|--|---|---|
|  | Malfunction Indicator Lamp | <ul style="list-style-type: none"> • Comes on when you set the power mode to ON, and goes off either when the engine starts or after several seconds if the engine did not start. If “readiness codes” have not been set, it blinks five times before it goes off. • Comes on if there is a problem with the emissions control system. • Blinks when a misfire in the engine’s cylinders is detected. | <ul style="list-style-type: none"> • Readiness codes are part of the on board diagnostics for the emissions control systems. <ul style="list-style-type: none"> ▶ Testing of Readiness Codes P. 572 • Comes on while driving - Have your vehicle checked by a dealer. • Blinks while driving - Stop in a safe place where there are no flammable objects. Stop the engine for 10 minutes or more, and wait for it to cool down. Then, take the vehicle to a dealer. <ul style="list-style-type: none"> ▶ If the Malfunction Indicator Lamp Comes On or Blinks P. 550 |  |
|  | Charging System Indicator | <ul style="list-style-type: none"> • Comes on when you set the power mode to ON, and goes off when the engine starts. • Comes on when the battery is not charging. | <ul style="list-style-type: none"> • Comes on while driving - Turn off the climate control system and rear defogger in order to reduce electricity consumption. <ul style="list-style-type: none"> ▶ If the Charging System Indicator Comes On P. 549 |  |
|  | Gear Position Indicator*/Shift Lever Position Indicator* | <ul style="list-style-type: none"> • Indicates the current gear selection. | <ul style="list-style-type: none"> ▶ Shifting P. 371, 378 |  |









* Not available on all models





Models with electronic gear selector



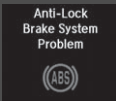

| Indicator | Name | On/Blinking | Explanation | Message |
|---|-------------------------------|---|--|---|
|  | Transmission System Indicator | <ul style="list-style-type: none"> The indicated current gear selection blinks if there is a problem with the transmission system. | <ul style="list-style-type: none"> Avoid sudden start and acceleration, and stop in a safe place immediately. Have your vehicle checked by a dealer. |  |
| | | <ul style="list-style-type: none"> All the gear positions may light for several seconds, and go off. | <ul style="list-style-type: none"> When all the gear positions light, immediately stop your vehicle in a safe place. Indicators go off if there is no problem. However, even if they go off, take your vehicle to a dealer for inspection. | |
| | | <ul style="list-style-type: none"> The indicated current gear selection or all the gear positions blink if there is a problem with the transmission system, and the vehicle no longer moves. | <ul style="list-style-type: none"> Immediately stop in a safe place. <ul style="list-style-type: none"> 🚨 Emergency Towing P. 560 Have your vehicle checked by a dealer. |  |
| | | <ul style="list-style-type: none"> The indicated current gear selection or all the gear positions blink if you cannot select P due to the transmission system failure. | <ul style="list-style-type: none"> The engine can be activated as a temporary measure. <ul style="list-style-type: none"> 🚨 If the Transmission System Indicator Blinks along with the Warning Message P. 554 Set the parking brake when parking. Have your vehicle checked by a dealer immediately. |  |

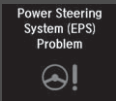

Models with shift lever

| Indicator | Name | On/Blinking | Explanation | Message |
|---|-------------------------------|--|---|---|
|  | Transmission System Indicator | <ul style="list-style-type: none"> Blinks if the transmission system has a problem. | <ul style="list-style-type: none"> Blinks while driving - Avoid sudden starts and acceleration and have your vehicle checked by a dealer immediately. |  |





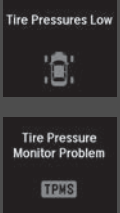

| Indicator | Name | On/Blinking | Explanation | Message |
|---|--|--|--|---|
|  | M (sequential mode) Indicator/ Sequential Mode Gear Selection Indicator | <ul style="list-style-type: none"> Comes on when the manual sequential mode is applied. | <ul style="list-style-type: none">  Sequential Shift Mode Operation P. 381 | — |
|  | Seat Belt Reminder Indicator | <ul style="list-style-type: none"> Comes on and the beeper sounds if you are not wearing a seat belt when you set the power mode to ON. If the front passenger is not wearing a seat belt, the indicator comes on about a few seconds later. Blinks while driving if either you or the front passenger has not fastened a seat belt. The beeper sounds and the indicator blinks at regular intervals. | <ul style="list-style-type: none"> The beeper stops and the indicator goes off when you and the front passenger fasten their seat belts. Stays on after you or the front passenger has fastened the seat belt - A detection error may have occurred in the sensor. Have your vehicle checked by a dealer.  Seat Belt Reminder P. 35 | <div data-bbox="1364 431 1476 532">Fasten Seat Belt </div> <div data-bbox="1364 554 1476 655">Fasten Passenger's Seat Belt </div> |
|  | Low Fuel Indicator | <ul style="list-style-type: none"> Comes on when the fuel reserve is running low (approximately 2.6 U.S. gal/9.7 Liter left on 2WD models, and 2.2 U.S. gal/8.2 Liter left on AWD models). Blinks if there is a problem with the fuel gauge. | <ul style="list-style-type: none"> Comes on - Refuel your vehicle as soon as possible. Blinks - Have your vehicle checked by a dealer. | <div data-bbox="1364 733 1476 834">Fuel Low </div> <div data-bbox="1364 856 1476 957">Fuel Gauge System Problem </div> |





| Indicator | Name | On/Blinking | Explanation | Message |
|---|--|---|--|---|
|  | Anti-lock Brake System (ABS) Indicator | <ul style="list-style-type: none"> • Comes on for a few seconds when you set the power mode to ON, then goes off. • If it comes on at any other time, there is a problem with the ABS. | <ul style="list-style-type: none"> • Stays on constantly - Have your vehicle checked by a dealer. With this indicator on, your vehicle still has normal braking ability but no anti-lock function. ► Anti-lock Brake System (ABS) P. 435 |  |
|  | Supplemental Restraint System Indicator | <ul style="list-style-type: none"> • Comes on for a few seconds when you set the power mode to ON, then goes off. • Comes on if a problem with any of the following is detected: <ul style="list-style-type: none"> - Supplemental restraint system - Side airbag system - Side curtain airbag system - Seat belt tensioners | <ul style="list-style-type: none"> • Stays on constantly or does not come on at all - Have your vehicle checked by a dealer. |  |
|  | Electric Power Steering (EPS) System Indicator | <ul style="list-style-type: none"> • Comes on when you set the power mode to ON, and goes off when the engine starts. • Comes on if there is a problem with the EPS system. | <ul style="list-style-type: none"> • Stays on constantly or does not come on at all - Have your vehicle checked by a dealer. ► If the Electric Power Steering (EPS) System Indicator Comes On P. 551 |  |







| Indicator | Name | On/Blinking | Explanation | Message |
|---|--|---|--|---|
|  | Vehicle Stability Assist (VSA®) System Indicator | <ul style="list-style-type: none"> • Comes on for a few seconds when you set the power mode to ON, then goes off. • Blinks when VSA® is active. • Comes on if there is a problem with the VSA® system or hill start assist system. | <ul style="list-style-type: none"> • Stays on constantly - Have your vehicle checked by a dealer. <ul style="list-style-type: none"> ➤ Vehicle Stability Assist (VSA®), aka Electronic Stability Control (ESC), System P. 418 ➤ Hill Start Assist System P. 368 | <div style="background-color: #333; color: white; padding: 5px; text-align: center;"> Vehicle Stability Assist (VSA) Problem  </div> <div style="background-color: #333; color: white; padding: 5px; text-align: center; margin-top: 5px;"> Hill Start Assist Problem  </div> |
|  | Vehicle Stability Assist (VSA®) OFF Indicator | <ul style="list-style-type: none"> • Comes on for a few seconds when you set the power mode to ON, then goes off. • Comes on when you partially disable VSA®. | <ul style="list-style-type: none"> ➤ VSA® On and Off P. 419 | — |











| Indicator | Name | On/Blinking | Explanation | Message |
|---|---|---|---|---|
|  | <p>Low Tire Pressure/TPMS Indicator</p> | <ul style="list-style-type: none"> • Comes on for a few seconds when you set the power mode to ON, then goes off. • Comes on if the tire pressure of any of the tires becomes significantly low. • Blinks for about one minute, and then stays on if there is a problem with the TPMS, or when a spare tire* is temporarily installed. | <ul style="list-style-type: none"> • Comes on while driving - Stop in a safe place, check tire pressures, and inflate the tire(s) if necessary. • Blinks and remains on - Have your vehicle checked by a dealer. If the vehicle is fitted with a spare tire*, get your regular tire repaired or replaced and put back on your vehicle as soon as you can. |  |
|  | <p>System Message Indicator</p> | <ul style="list-style-type: none"> • Comes on for a few seconds when you set the power mode to ON, then goes off. • Comes on along with a beep when a problem is detected. A system message on the multi-information display appears at the same time. | <ul style="list-style-type: none"> • While the indicator is on, roll the right selector wheel to see the message again. • Refer to the Indicators information in this chapter when a system message appears on the multi-information display. Take the appropriate action for the message. • The multi-information display does not return to the normal screen unless the warning is canceled, or the right selector wheel is rolled. |  |

* Not available on all models





| Indicator | Name | On/Blinking | Explanation | Message |
|---|---|--|---|---------|
|  | Turn Signal and Hazard Warning Indicators | <ul style="list-style-type: none"> Blinks when you operate the turn signal lever. Blinks if you press the hazard warning button. | <ul style="list-style-type: none"> Does not blink or blinks rapidly - A turn signal light bulb has blown. Change the bulb immediately.  Replacing Light Bulbs P. 488 | — |
|  | High Beam Indicator | <ul style="list-style-type: none"> Comes on when the high beam headlights are on. | — | — |
|  | Lights On Indicator | <ul style="list-style-type: none"> Comes on whenever the light switch is on, or in AUTO when the exterior lights are on. | <ul style="list-style-type: none"> If you set the power mode to ACCESSORY or VEHICLE OFF (LOCK) while the exterior lights are on, a chime sounds when the driver's door is opened. | — |
|  | Fog Light Indicator* | <ul style="list-style-type: none"> Comes on when the fog lights are on. | — | — |
|  | Auto High-Beam Indicator | <ul style="list-style-type: none"> Comes on when all the operating conditions of the Auto high-beam are met. |  Auto High-Beam P. 165 | — |







| Indicator | Name | On/Blinking | Explanation | Message*1 |
|--|---------------------------------|--|--|---|
|  | Immobilizer System Indicator | <ul style="list-style-type: none"> • Comes on briefly when you set the power mode to ON, then goes off. • Comes on if the immobilizer system cannot recognize the key information. | <ul style="list-style-type: none"> • Blinks - You cannot start the engine. Set the power mode to VEHICLE OFF (LOCK), then select the ON mode again. • Repeatedly blinks - The system may be malfunctioning. Have your vehicle checked by a dealer. • Do not attempt to alter this system or add other devices to it. Electrical problems can occur. | — |
|  <p>Indicator</p> | Security System Alarm Indicator | <ul style="list-style-type: none"> • Blinks when the security system alarm has been set. | <p>➤ Security System Alarm P. 151</p> | — |
|  | Keyless Access System Indicator | <ul style="list-style-type: none"> • Comes on for a few seconds when you set the power mode to ON, then goes off. • Comes on as soon as a problem is detected in the keyless access system or keyless starting system. | <ul style="list-style-type: none"> • Have your vehicle checked by a dealer. |   |



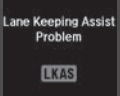

| Indicator | Name | On/Blinking | Explanation | Message |
|---|---|--|--|---|
|  | Road Departure Mitigation (RDM) Indicator | <ul style="list-style-type: none"> • Comes on for a few seconds when you change the power mode to ON, then goes off. • Comes on if there is a problem with the RDM system. | <ul style="list-style-type: none"> • Stays on constantly - Have your vehicle checked by a dealer. |  |
| | | <ul style="list-style-type: none"> • Comes on when the RDM system shuts itself off. | <ul style="list-style-type: none"> • Stays on - The temperature inside the camera is too high. Use the climate control system to cool down the camera. The system activates when the temperature inside the camera cools down.  Front Sensor Camera P. 389 |  |
| | | | <ul style="list-style-type: none"> • Stays on - The area around the camera is blocked by dirt, mud, etc. Stop your vehicle in a safe place, and wipe it off with a soft cloth. • Have your vehicle checked by a dealer if the indicator and message come back on after you cleaned the area around the camera.  Front Sensor Camera P. 389 |  |

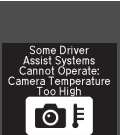





| Indicator | Name | On/Blinking | Explanation | Message |
|---|--|---|---|---|
|  | Precision All-Wheel Steer™ (P-AWS®) System Indicator* | <ul style="list-style-type: none"> • Comes on for a few seconds when you set the power mode to ON, then goes off. • If it comes on at any other time, there is a problem with the Precision All-Wheel Steer™ (P-AWS®) system. | <ul style="list-style-type: none"> • Comes on while driving - Have your vehicle checked by a dealer. • The system may limit the vehicle speed to 50 mph (80 km/h) or less. |  |
|  | SPORT (Sport mode) Indicator | <ul style="list-style-type: none"> • Comes on for a few seconds when you set the power mode to ON, then goes off. • Comes on when you press the Dynamic Mode button if the Sport or Sport+ mode was selected. |  Integrated Dynamics System P. 388 |  |
|  | ECON (Econ mode) Indicator | <ul style="list-style-type: none"> • Comes on for a few seconds when you set the power mode to ON. • Comes on when you press the Dynamic Mode button if the Econ mode was selected. |  Integrated Dynamics System P. 388 |  |
|  | Adaptive Cruise Control (ACC) with Low Speed Follow (LSF) Indicator (Amber) | <ul style="list-style-type: none"> • Comes on for a few seconds when you set the power mode to ON, then goes off. • Comes on if there is a problem with ACC with LSF. | <ul style="list-style-type: none"> • Comes on while driving - Have your vehicle checked by a dealer. |  |

* Not available on all models



| Indicator | Name | On/Blinking | Explanation | Message |
|---|---|--|--|---|
|  | Adaptive Cruise Control (ACC) with Low Speed Follow (LSF) Indicator (Green) | <ul style="list-style-type: none"> • Comes on when you press the MAIN button. | <ul style="list-style-type: none"> ➤ Adaptive Cruise Control (ACC) with Low Speed Follow (LSF) P. 391 |  |
| | | <ul style="list-style-type: none"> • Comes on if anything covers the radar sensor cover and prevents the sensor from detecting a vehicle in front. • May come on when driving in bad weather (rain, snow, fog, etc.) • ACC has been automatically canceled. | <ul style="list-style-type: none"> • When the radar sensor gets dirty, stop your vehicle in a safe place, and wipe off dirt using a soft cloth. • Have your vehicle checked by a dealer if the message does not disappear even after you clean the sensor cover. |  |
| | | <ul style="list-style-type: none"> • Comes on when ACC with LSF is in operation, but the temperature inside the front sensor camera is too high. ACC with LSF cancels automatically. The beeper sounds simultaneously. | <ul style="list-style-type: none"> • Use the climate control system to cool down the camera. • Goes off - The camera has been cooled down and the system activates normally. |  |
| <ul style="list-style-type: none"> • Comes on when the area around the camera is blocked by dirt, mud, etc. Stop your vehicle in a safe place, and wipe it off with a soft cloth. • May come on when driving in bad weather (rain, snow, fog, etc.) | <ul style="list-style-type: none"> • Have your vehicle checked by a dealer if the indicator and message come back on after you cleaned the area around the camera. |  | | |





| Indicator | Name | On/Blinking | Explanation | Message |
|---|---|--|---|--|
|  | Lane Keeping Assist System (LKAS) Indicator (Amber) | <ul style="list-style-type: none"> • Comes on for a few seconds when you set the power mode to ON, then goes off. • Comes on if there is a problem with the LKAS. | <ul style="list-style-type: none"> • Stays on constantly - Have your vehicle checked by a dealer. |  |
|  | Lane Keeping Assist System (LKAS) Indicator (Green) | <ul style="list-style-type: none"> • Comes on when you press the MAIN button. • Comes on when the LKAS is in operation, or the LKAS button is pressed, but the temperature inside the front sensor camera is too high. The LKAS cancels automatically. The beeper sounds simultaneously. • Comes on when the area around the camera is blocked by dirt, mud, etc. Stop your vehicle in a safe place, and wipe it off with a soft cloth. • May come on when driving in bad weather (rain, snow, fog, etc.) | <ul style="list-style-type: none"> •  Lane Keeping Assist System (LKAS) P. 410 • Use the climate control system to cool down the camera. • Goes off - The camera has been cooled down and the system activates normally.  Front Sensor Camera P. 389 • Have your vehicle checked by a dealer if the indicator and message come back on after you cleaned the area around the camera. |   |

| Indicator | Name | On/Blinking | Explanation | Message |
|---|---|--|---|---|
|  | Blind Spot Information (BSI) Indicator* | <ul style="list-style-type: none"> • Comes on for a few seconds when you change the power mode to ON, then goes off. • Stays on while BSI is turned off. | — |  |
| | | <ul style="list-style-type: none"> • Comes on when mud, snow, or ice accumulates in the vicinity of sensor. | <ul style="list-style-type: none"> • Comes on while driving - Remove the obstacle in the vicinity of sensor.  Blind spot information (BSI) System* P. 421 |  |
| | | <ul style="list-style-type: none"> • Comes on if there is a problem with the system. | <ul style="list-style-type: none"> • Comes on while driving - Have your vehicle checked by a dealer. |  |

| Indicator | Name | On/Blinking | Explanation | Message |
|---|--|--|--|---|
|  | Super Handling-All Wheel Drive™ (SH-AWD®) Indicator* | <ul style="list-style-type: none"> Comes on for a few seconds when you set the power mode to ON, then goes off. Comes on if there is a problem with the SH-AWD® system. Blinks when the differential temperature is too high. | <ul style="list-style-type: none"> Stays on constantly - The engine drives the front wheels only in this state. Have your vehicle checked by a dealer. |  |
| | | <ul style="list-style-type: none"> Blinks while driving - Stop in a safe place, put the transmission into P, and idle the engine until the indicator goes off. If the indicator does not stop blinking, take your vehicle to a dealer. <p>➤ Super Handling-All Wheel Drive™ (SH-AWD®)* P. 424</p> |  | |
|  | Auto Idle Stop Indicator (Green)* | <ul style="list-style-type: none"> Comes on when Auto Idle Stop is in operation. The engine automatically shuts off. | <p>➤ Auto Idle Stop* P. 382</p> |  |
|  | Auto Idle Stop System Indicator (Amber)* | <ul style="list-style-type: none"> Comes on for a few seconds when you set the power mode to ON, then goes off. Blinks if there is a problem with the Auto Idle Stop System. Comes on when Auto Idle Stop System has been turned off by Auto Idle Stop OFF Button. | <ul style="list-style-type: none"> Blinks - Have your vehicle checked by a dealer. |  |



* Not available on all models





| Indicator | Name | On/Blinking | Explanation | Message |
|---|--|--|---|---|
|  | Collision Mitigation Braking System™ (CMBS™) Indicator | <ul style="list-style-type: none"> • Comes on for a few seconds when you change the power mode to ON, then goes off. • Comes on when you deactivate the CMBS™. A multi-information display message appears for five seconds. • Comes on if there is a problem with the CMBS™. | <ul style="list-style-type: none"> • Stays on constantly without the CMBS™ off - Have your vehicle checked by a dealer. <ul style="list-style-type: none"> ➤ Collision Mitigation Braking System™ (CMBS™) P. 437 | <div data-bbox="1362 239 1474 273" style="background-color: #333; color: white; padding: 2px; font-size: 8px;">Collision Mitigation System Problem</div>  <div data-bbox="1362 362 1474 396" style="background-color: #333; color: white; padding: 2px; font-size: 8px;">Collision Mitigation Braking System Off</div>  |

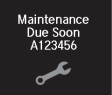



| Indicator | Name | On/Blinking | Explanation | Message |
|---|--|--|--|---|
|  | Collision Mitigation Braking System™ (CMBS™) Indicator | <ul style="list-style-type: none"> Comes on when the CMBS™ system shuts itself off. | <ul style="list-style-type: none"> Stays on - The area around the camera is blocked by dirt, mud, etc. Stop your vehicle in a safe place, and wipe it off with a soft cloth. <ul style="list-style-type: none"> ➤ Front Sensor Camera P. 389 |  |
| | | | <ul style="list-style-type: none"> When the radar sensor gets dirty, stop your vehicle in a safe place, and wipe off dirt using a soft cloth. Have your vehicle checked by a dealer if the message does not disappear even after you clean the sensor cover. <ul style="list-style-type: none"> ➤ Collision Mitigation Braking System™ (CMBS™) P. 437 |  |
| | | | <ul style="list-style-type: none"> Stays on - The temperature inside the camera is too high. Use the climate control system to cool down the camera. The system activates when the temperature inside the camera cools down. <ul style="list-style-type: none"> ➤ Front Sensor Camera P. 389 |  |





Multi-Information Display Warning and Information Messages



The following messages appear only on the multi-information display. Roll the right selector wheel to see the message again with the system message indicator on.

| Message | Condition | Explanation |
|--|---|---|
| <p>Canadian models</p>  | <ul style="list-style-type: none"> Appears when the washer fluid is low. | <ul style="list-style-type: none"> Refill washer fluid. <ul style="list-style-type: none"> ➤ Refilling Window Washer Fluid P. 487 |
|  | <ul style="list-style-type: none"> Appears when the scheduled maintenance is due soon. Consequently, Maintenance Due Now and Maintenance Past Due follow. | <ul style="list-style-type: none"> ➤ Maintenance Minder Messages on the Multi-Information Display P. 471 |
|  | <ul style="list-style-type: none"> Appears when the transmission system temperature is too high. The vehicle does not operate properly. | <ul style="list-style-type: none"> You may find it difficult to accelerate, or to start the vehicle on uphill. Stop in a safe place in P. Let the engine idle until the message disappears. |
|  | <ul style="list-style-type: none"> Appears if you depress the accelerator pedal when the transmission is in N. | <ul style="list-style-type: none"> Release the accelerator pedal. After that, depress the brake pedal and change the transmission position. |



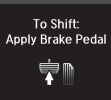

| Message | Condition | Explanation |
|---|---|---|
|  | <ul style="list-style-type: none"> • Appears when the engine coolant temperature gets abnormally high. | <ul style="list-style-type: none"> ► Overheating P. 547 |
|  | <ul style="list-style-type: none"> • Appears when there is a problem with the sensor on the battery. • Appears along with the battery charging system indicator when the battery is not charging. | <ul style="list-style-type: none"> • Have your vehicle checked by a dealer. <ul style="list-style-type: none"> ► Checking the Battery P. 504 • Turn off the climate control system and rear defogger to reduce electricity consumption. <ul style="list-style-type: none"> ► If the Charging System Indicator Comes On P. 549 |
| <div style="border: 1px solid black; padding: 2px; width: fit-content; margin-bottom: 5px;">U.S.</div>  <div style="border: 1px solid black; padding: 2px; width: fit-content; margin-bottom: 5px;">Canada</div>  | <ul style="list-style-type: none"> • Appears when the starter system has a problem. | <ul style="list-style-type: none"> • Hold the ENGINE START/STOP button up to 15 seconds to start the engine. Have your vehicle checked by a dealer. |

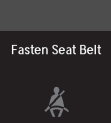

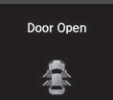
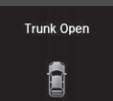
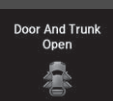
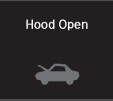

| Message | Condition | Explanation |
|--|---|---|
|  <p>To Switch Vehicle Off: Push Twice</p> | <ul style="list-style-type: none"> Appears after the driver's door is opened when the power mode is in ACCESSORY. | <ul style="list-style-type: none"> Press the ENGINE START/STOP button twice with your foot off the brake pedal to change the power mode to VEHICLE OFF (LOCK). |
|  <p>Accessory Mode</p> | <ul style="list-style-type: none"> Appears when the power mode is in ACCESSORY. | — |
|  <p>Keyless Remote Not Detected</p> | <ul style="list-style-type: none"> Appears when you close the door with the power mode in ON without the keyless access remote inside the vehicle. | <ul style="list-style-type: none"> Disappears when you bring the keyless access remote back inside the vehicle and close the door. <ul style="list-style-type: none"> ➤ Keyless Access Remote Reminder P. 159 |
|  <p>Keyless Remote Battery Low</p> | <ul style="list-style-type: none"> Appears when the keyless access remote battery becomes weak. | <ul style="list-style-type: none"> Replace the battery as soon as possible. <ul style="list-style-type: none"> ➤ Replacing the Button Battery P. 506 |

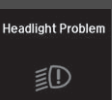



| Message | Condition | Explanation |
|---|---|---|
|  | <ul style="list-style-type: none"> Appears if the keyless access remote's battery is too weak to start the engine or the key is not within operating range to start the engine. A beeper sounds six times. | <ul style="list-style-type: none"> Bring the keyless access remote in front of the ENGINE START/STOP button to be touched with. <ul style="list-style-type: none"> ► If the Keyless Access Remote Battery is Weak P. 540 |
|  | <ul style="list-style-type: none"> Appears three seconds after the To Start, Hold Remote Near Start Button, then To Start Engine messages appears sequentially. | <ul style="list-style-type: none"> Unless you bring the keyless access remote in front of the ENGINE START/STOP button, this message does not appear. <ul style="list-style-type: none"> ► If the Keyless Access Remote Battery is Weak P. 540 |
|  | <ul style="list-style-type: none"> Appears when the power mode is in ACCESSORY or ON. | <ul style="list-style-type: none"> ► Starting the Engine P. 362 |
| <p>Canadian models</p>  | <p>Models with Auto Idle Stop</p> <ul style="list-style-type: none"> Appears when the engine does not restart automatically due to the following reason: <ul style="list-style-type: none"> The hood is open. There is a problem in the system that disables Auto Idle Stop. | <p>Models with Auto Idle Stop</p> <ul style="list-style-type: none"> Follow the normal procedure to start the engine. <ul style="list-style-type: none"> ► Starting the Engine P. 362 Close the hood. |
|  | <ul style="list-style-type: none"> Appears when the steering wheel is locked. | <ul style="list-style-type: none"> Move the steering wheel left and right while pressing the ENGINE START/STOP button. |



| Message | Condition | Explanation |
|--|---|--|
|  <p>To Shift: Apply Brake Pedal</p> | <ul style="list-style-type: none"> • Appears when you try to change the gear position without depressing the brake pedal. | <ul style="list-style-type: none"> • Depress the brake pedal, then select a shift button. |
|  <p>To Shift: Release Accelerator Pedal</p> | <ul style="list-style-type: none"> • Appears when you try to change the gear position without releasing your foot off the accelerator pedal. | <ul style="list-style-type: none"> • Release your foot off the accelerator pedal, then select a shift button. |
|  <p>To Shift: Vehicle Must Be Stopped</p> | <ul style="list-style-type: none"> • Appears when the P button is pressed while the vehicle is moving. • Appears if you change the gear position to R while the vehicle is moving forward, or to D while the vehicle is reversing. | <ul style="list-style-type: none"> • Make sure that the vehicle comes to a stop before operating the select button. |
|  <p>Fasten Seat Belt</p> | <ul style="list-style-type: none"> • Appears when you set the power mode to ON without fastening the driver's seat belt. • Appears when you change the gear position after P has been automatically selected with the driver's door open, the driver's seat belt unfastened, then the brake pedal is released. | <ul style="list-style-type: none"> • Fasten the seat belt properly before you start to drive. ➤ Shift Operation P. 372 |





| Message | Condition | Explanation |
|---|---|---|
| <p>Door Open</p>  <p>Trunk Open</p>  <p>Door And Trunk Open</p>  | <ul style="list-style-type: none"> • Appears if any door or the trunk is not completely closed. • The beeper sounds and the message appears if any door or the trunk is opened while driving. | <ul style="list-style-type: none"> • Goes off when all doors and the trunk are closed. |
| <p>Hood Open</p>  | <ul style="list-style-type: none"> • Appears when the hood is opened. | <ul style="list-style-type: none"> • Close the hood. |

| Message | Condition | Explanation |
|---|---|--|
|  <p>Engine Cooling Problem</p> | <ul style="list-style-type: none"> Appears if there is a problem with the cooling system. | <ul style="list-style-type: none"> Drive slowly to prevent overheating and have your vehicle checked by a dealer as soon as possible. |
|  <p>Dynamic Mode Integrated Dynamics System</p> <p>Econ Normal Sport Sport +</p> | <ul style="list-style-type: none"> Appears when pressing the Dynamic Mode button. <ul style="list-style-type: none"> ► Press again to change the next mode. | <p>► Integrated Dynamics System P. 388</p> |
|  <p>Headlight Problem</p> | <ul style="list-style-type: none"> Appears when there is a problem with the headlights. | <ul style="list-style-type: none"> Appears while driving - The headlights may not be on. When conditions allow you to drive safely, have your vehicle checked by a dealer as soon as possible. |
|  <p>Brake Hold Disabled Apply Brake Pedal</p> | <ul style="list-style-type: none"> Appears if the automatic brake hold system is automatically canceled while it is in operation. | <ul style="list-style-type: none"> Immediately depress the brake pedal. |

| Message | Condition | Explanation |
|---|---|---|
|  <p>Auto High-Beam Problem</p> | <ul style="list-style-type: none"> • Appears if there is a problem with the auto high-beam. | <ul style="list-style-type: none"> • Manually operate the headlight switch. • If you are driving with the high-beam headlights when this happens, the headlights are changed to low beams. |
|  <p>Some Driver Assist Systems Cannot Operate: Camera Temperature Too High</p> | <ul style="list-style-type: none"> • Appears if the temperature inside the camera is too high and either the auto high beams are in operation or the headlight switch is turned to AUTO. | <ul style="list-style-type: none"> • Use the climate control system to cool down the camera. • Goes off - The camera has cooled down. To resume the system, turn the headlight switch to AUTO.  Front Sensor Camera P. 389 |
|  <p>Some Driver Assist Systems Cannot Operate: Clean Front Windshield</p> | <ul style="list-style-type: none"> • Appears when the area around the camera is blocked by dirt, mud, etc. Stop your vehicle in a safe place, and wipe it off with a soft cloth. • May appear when driving in bad weather (rain, snow, fog, etc.) | <ul style="list-style-type: none"> • Have your vehicle checked by a dealer if the message comes back on after you have cleaned the area around the camera. |

| Message | Condition | Explanation |
|---|---|--|
|  <p>Brake Hold System Off</p> | <ul style="list-style-type: none"> • Appears when the automatic brake hold system is turned off. | <p>➤ Automatic Brake Hold P. 433</p> |
|  <p>To Enable Brake Hold: Seat Belt + Push</p> | <ul style="list-style-type: none"> • Appears when the automatic brake hold button is pressed without wearing the driver's seat belt. | <ul style="list-style-type: none"> • Fasten the driver's seat belt. <p>➤ Automatic Brake Hold P. 433</p> |
|  <p>To Disable Brake Hold: Brake + Push</p> | <ul style="list-style-type: none"> • Appears when the automatic brake hold button is pressed without depressing the brake pedal while the automatic brake hold system is in operation. | <ul style="list-style-type: none"> • Press the automatic brake hold system button with the brake pedal depressed. <p>➤ Automatic Brake Hold P. 433</p> |
|  <p>Parking Brake Engaged</p> | <ul style="list-style-type: none"> • Appears when the parking brake is applied automatically while it is in operation. | <p>➤ Automatic Brake Hold P. 433</p> <p>➤ Parking Brake P. 429</p> |

| Message | Condition | Explanation |
|---|---|---|
|  | <ul style="list-style-type: none"> Flashes when the system senses a likely collision with a vehicle in front of you. | <ul style="list-style-type: none"> Take the appropriate means to prevent a collision (apply the brakes, change lanes, etc.) <ul style="list-style-type: none"> ▶ Collision Mitigation Braking System™ (CMBS™) P. 437 ▶ Adaptive Cruise Control (ACC) with Low Speed Follow (LSF) P. 391 |
|  | <ul style="list-style-type: none"> Appears when ACC with LSF has been automatically canceled. | <ul style="list-style-type: none"> You can resume the set speed after the condition that caused ACC with LSF to cancel improves. Press the RES/+SET/- switch up. <ul style="list-style-type: none"> ▶ Adaptive Cruise Control (ACC) with Low Speed Follow (LSF) P. 391 |





| Message | Condition | Explanation |
|--|---|--|
|  | <ul style="list-style-type: none"> Appears when the distance between your vehicle and the vehicle ahead of you is too close while ACC with LSF is in operation. | <ul style="list-style-type: none"> ACC with LSF has been automatically canceled. <ul style="list-style-type: none"> ➤ Adaptive Cruise Control (ACC) with Low Speed Follow (LSF) P. 391 |
|  | <ul style="list-style-type: none"> Appears when pressing the RES/+ / SET/- switch down while the distance between your vehicle and the vehicle ahead of you is too close. | <ul style="list-style-type: none"> ACC with LSF cannot be set. <ul style="list-style-type: none"> ➤ Adaptive Cruise Control (ACC) with Low Speed Follow (LSF) P. 391 |
|  | <ul style="list-style-type: none"> Appears when pressing the RES/+ / SET/- switch down while the driver's seat belt is unfastened. | <ul style="list-style-type: none"> ACC with LSF cannot be set. <ul style="list-style-type: none"> ➤ Adaptive Cruise Control (ACC) with Low Speed Follow (LSF) P. 391 |
|   | <ul style="list-style-type: none"> Appears when pressing the RES/+ / SET/- switch down while the transmission is not in [D]. | <ul style="list-style-type: none"> ACC with LSF cannot be set. <ul style="list-style-type: none"> ➤ Adaptive Cruise Control (ACC) with Low Speed Follow (LSF) P. 391 |

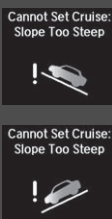
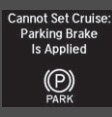

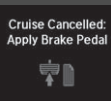
*1: Models with electronic gear selector

*2: Models with shift lever

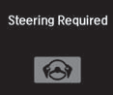

| Message | Condition | Explanation |
|---|--|---|
|  <p>Cruise Cancelled: Slope Too Steep</p> <p>Cruise Cancelled: Slope Too Steep</p> | <ul style="list-style-type: none"> Appears when the vehicle is stopped on a very steep slope while ACC with LSF is in operation. | <ul style="list-style-type: none"> ACC with LSF has been automatically canceled. <ul style="list-style-type: none"> ➤ Adaptive Cruise Control (ACC) with Low Speed Follow (LSF) P. 391 |
|  <p>Cannot Set Cruise: Slope Too Steep</p> <p>Cannot Set Cruise: Slope Too Steep</p> | <ul style="list-style-type: none"> Appears when pressing the RES/+ / SET/- switch down while the vehicle is stopped on a very steep slope. | <ul style="list-style-type: none"> ACC with LSF cannot be set. <ul style="list-style-type: none"> ➤ Adaptive Cruise Control (ACC) with Low Speed Follow (LSF) P. 391 |
|  <p>Cannot Set Cruise: Parking Brake Is Applied</p> | <ul style="list-style-type: none"> Appears when pressing the RES/+ / SET/- switch down while the parking brake is applied. | <ul style="list-style-type: none"> ACC with LSF cannot be set. <ul style="list-style-type: none"> ➤ Adaptive Cruise Control (ACC) with Low Speed Follow (LSF) P. 391 ➤ Parking Brake P. 429 |

| Message | Condition | Explanation |
|--|---|--|
|  <p>Cannot Set Cruise: Brake Pedal Is Applied</p> | <ul style="list-style-type: none"> Appears when pressing the RES/+SET/- switch down while the vehicle is moving and the brake pedal is depressed. | <ul style="list-style-type: none"> ACC with LSF cannot be set. <ul style="list-style-type: none"> ➤ Adaptive Cruise Control (ACC) with Low Speed Follow (LSF) P. 391 |
|  <p>Cruise Cancelled: Apply Brake Pedal</p> | <ul style="list-style-type: none"> Appears if ACC with LSF is canceled while your vehicle is automatically stopped by ACC with LSF. | <ul style="list-style-type: none"> Immediately depress the brake pedal. |



| Message | Condition | Explanation |
|--|---|--|
|   | <p>Lane Keeping Assist System (LKAS)</p> <ul style="list-style-type: none"> • Appears when the vehicle is driving out of a detected lane. The steering wheel vibrates rapidly. <p>Road Departure Mitigation (RDM) System</p> <ul style="list-style-type: none"> • Appears when the vehicle is driving out of a detected lane. <p>When you selected Warning Only</p> <ul style="list-style-type: none"> - The steering wheel vibrates rapidly when the vehicle is drifting out of a detected lane. <p>When you selected Normal or Wide</p> <ul style="list-style-type: none"> - The steering wheel vibrates rapidly when the vehicle is drifting out of a detected lane. The system also steers the vehicle to help you remain within your driving lane. | <ul style="list-style-type: none"> • Keep the vehicle within the lane you are driving. <ul style="list-style-type: none"> ► Lane Keeping Assist System (LKAS) P. 410 • Keep the vehicle within the lane you are driving. <ul style="list-style-type: none"> ► Road Departure Mitigation (RDM) System P. 405 • You can change the setting for the road departure mitigation system. Normal, Wide, and Warning Only can be selected. <ul style="list-style-type: none"> ► Customized Features P. 120, 292 |
|  | <ul style="list-style-type: none"> • Blinks when you fail to steer the vehicle. The beeper sounds simultaneously. | <ul style="list-style-type: none"> • Operate the steering wheel to resume the LKAS. |
|  | <ul style="list-style-type: none"> • Appears when the LKAS is in operation, or the LKAS button is pressed, but there is a problem with a system related to the LKAS. The LKAS cancels automatically. The beeper sounds simultaneously. | <ul style="list-style-type: none"> • If any other system indicators come on, such as the VSA®, ABS and brake system, take appropriate action. |

| Message | Condition | Explanation |
|---|---|--|
|  | <ul style="list-style-type: none"> Appears when the LKAS is in operation, or the LKAS button is pressed, but the temperature inside the front sensor camera is too high. The LKAS cancels automatically. The beeper sounds simultaneously. | <ul style="list-style-type: none"> Use the climate control system to cool down the camera. Goes off - The camera has been cooled down. Pressing the LKAS button can resume the system.  Front Sensor Camera P. 389 |
|  | <ul style="list-style-type: none"> Appears when the area around the camera is blocked by dirt, mud, etc. Stop your vehicle in a safe place, and wipe it off with a soft cloth. May appear when driving in bad weather (rain, snow, fog, etc.) | <ul style="list-style-type: none"> Have your vehicle checked by a dealer if the indicator and message come back on after you cleaned the area around the camera. |



Models with Auto Idle Stop

| Message | Condition | Explanation |
|---|---|---|
|  | <ul style="list-style-type: none"> • Appears when Auto Idle Stop Guidance Screens ON has been selected from the customization menu. | <p> Auto Idle Stop* P. 382</p> |
| | <ul style="list-style-type: none"> • Appears when Auto Idle Stop does not activate for some reason. | |
| | <ul style="list-style-type: none"> • Appears when the engine restarts automatically. • Appears when the battery temperature is around 14°F (–10°C) or lower. | |
| | <ul style="list-style-type: none"> • Appears when Auto Idle Stop does not activate because the climate control system is in use, and the difference between the set temperature and actual interior temperature becomes significant. | |
| | <ul style="list-style-type: none"> • Appears when Auto Idle Stop does not activate because the engine coolant temperature is too low or high. | |
| | <ul style="list-style-type: none"> • Appears when Auto Idle Stop does not activate because the battery charge level is low. | <ul style="list-style-type: none"> • Appears even though the battery is fully charged - The system may not read the battery amount correctly. Drive for a few minutes. • Appears after charging the battery or jump starting - Disconnect the negative ⊖ cable once and reconnect it again to the battery. Drive a few minutes. |

* Not available on all models

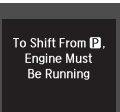
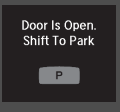

| Message | Condition | Explanation |
|---|--|--|
|  | <ul style="list-style-type: none"> • Appears when Auto Idle Stop does not activate because the pressure to the brake pedal is not enough. | <ul style="list-style-type: none"> • Depress the brake pedal firmly. |
|  | <ul style="list-style-type: none"> • Appears when Auto Idle Stop Guidance Screens ON has been selected from the customization menu. • Appears when the system is under the following conditions while Auto Idle Stop activates: <ul style="list-style-type: none"> - The battery charge level is low. - The battery temperature is around 14°F (–10°C) or lower. - The climate control system is in use, and the difference between the set temperature and actual interior temperature becomes significant. - The humidity in the interior is high. | <ul style="list-style-type: none"> • The engine restarts automatically in a few seconds. <ul style="list-style-type: none"> ▣ Starting the Engine P. 362 |

Models with electronic gear selector

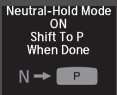
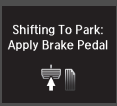
| Message | Condition | Explanation |
|---|--|--|
|  | <ul style="list-style-type: none"> Appears when you attempt to put the transmission into another gear position with the transmission in P and the engine OFF. | <ul style="list-style-type: none"> To select another gear position while in P, the engine must be ON. |
|  | <ul style="list-style-type: none"> Appears when you try to change the gear position after the position has automatically been changed to P with the driver's door open and the driver's seat belt unfastened. | <ul style="list-style-type: none"> Press the P button If you leave the vehicle. |
|  | <ul style="list-style-type: none"> Appears if you press the ENGINE START/STOP button to turn the engine off without the transmission in P. | <p>U.S. models</p> <ul style="list-style-type: none"> Put the transmission into P. The power mode changes to VEHICLE OFF. <p>Canadian models</p> <ul style="list-style-type: none"> Press the ENGINE START/STOP button twice after putting the transmission into P. |
| | <p>Models with Auto Idle Stop</p> <ul style="list-style-type: none"> Appears when the engine stops without the transmission in P, and does not restart automatically. Appears if you open the hood while Auto Idle Stop activates. | <p>Models with Auto Idle Stop</p> <ul style="list-style-type: none"> If you want to set the power mode to ON, put the transmission into P. If you want to start the engine, follow the normal procedure. <p>➤ Starting the Engine P. 362</p> |

| Message | Condition | Explanation |
|---|--|--|
|  | <ul style="list-style-type: none"> Appears for a few seconds if you have not pressed the N button long enough to initiate Neutral-Hold mode. | <ul style="list-style-type: none"> ➤ If you want to keep the transmission in N position [car wash mode] P. 374 |
|  | <ul style="list-style-type: none"> Appears when you press and hold N button for more than 2 seconds. | <ul style="list-style-type: none"> Disappears when you set the gear position to other than N. ➤ If you want to keep the transmission in N position [car wash mode] P. 374 |
|  | <ul style="list-style-type: none"> Appears when you press the P button but it is not engaged due to low ATF temperature. | <ul style="list-style-type: none"> Depress the brake pedal until this message disappear. |



Models with shift lever

| Message | Condition | Explanation |
|---|--|--|
|  | <ul style="list-style-type: none"> Appears if you press the ENGINE START/STOP button to turn the engine off without the shift lever in P. | <p>U.S. models</p> <ul style="list-style-type: none"> Move the shift lever to P. The power mode changes to VEHICLE OFF. <p>Canadian models</p> <ul style="list-style-type: none"> Press the ENGINE START/STOP button twice after moving the shift lever to P. |
|  | <ul style="list-style-type: none"> Appears if the driver's door is open and you try to shift to a position other than P. | <ul style="list-style-type: none"> Moving the shift lever to P If you leave the vehicle. |
|  | <ul style="list-style-type: none"> Appears when the transmission system temperature is too high. The vehicle no longer moves. | <ul style="list-style-type: none"> Immediately stop in a safe place and shift to P. Let the engine idle until the message disappears. |

Models with parking sensor system

| Message | Condition | Explanation |
|--|---|--|
|  <p>Parking Sensor System Problem</p> | <ul style="list-style-type: none"> Appears if there is a problem with the parking sensor system. | <ul style="list-style-type: none"> Check if the area around the sensor(s) is covered with mud, ice, snow, etc. If the indicator(s) stays on even after you clean the area, have the system checked by a dealer. |

Models with two-way keyless access remote

| Message | Condition | Explanation |
|--|--|---|
|  <p>To Start Driving: Brake + Push</p>  <p>To Enter Accessory Mode: Push</p> | <ul style="list-style-type: none"> Appears when you unlock and open the driver's door while the engine is running by two-way keyless access remote. | <p>➤ Remote Engine Start with Vehicle Feedback* P. 365</p> |

Gauges

Gauges include the speedometer, tachometer, fuel gauge and related indicators. They are displayed when the power mode is in ON.

■ Speedometer

Displays your driving speed in mph or km/h.

■ Tachometer

Shows the number of engine revolutions per minute.

■ Fuel Gauge

Displays the amount of fuel left in the fuel tank.

■ Temperature Gauge

Displays the temperature of the engine coolant.

» Fuel Gauge

NOTICE

You should refuel when the needle approaches **E**. Running out of fuel can cause the engine to misfire, damaging the catalytic converter.

The actual amount of remaining fuel may differ from the fuel gauge reading.

» Temperature Gauge

NOTICE

Driving with the temperature gauge pointer in the upper zone can cause serious engine damage. Pull safely to the side of the road and allow engine temperature to return to normal.

➔ **Overheating** P. 547

Multi-Information Display

The multi-information display shows the odometer, trip meter, outside temperature indicator, and other gauges. It also displays important messages such as warnings and other helpful information.

Switching the Display

Main displays

Roll the right selector wheel to change the display.

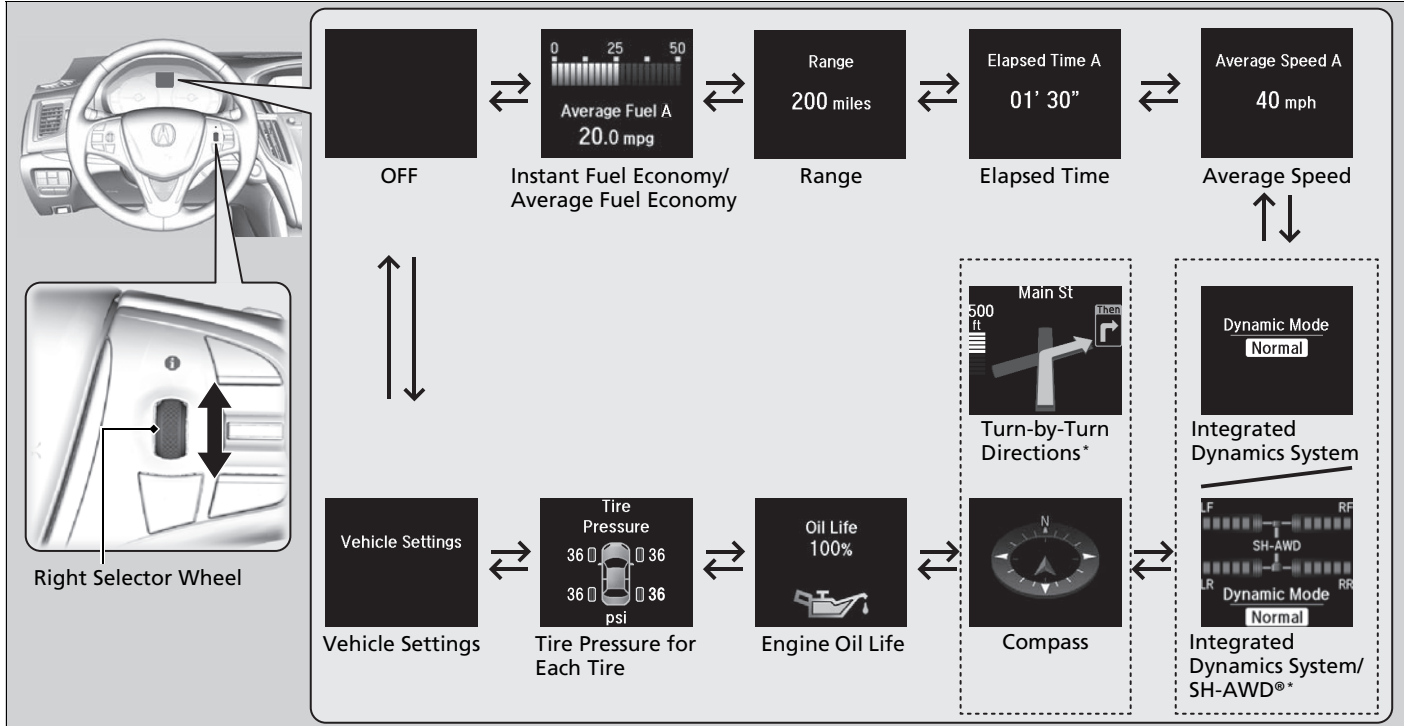

Instrument Panel

* Not available on all models

■ Lower displays

Press the **TRIP** button to change the display.

Instrument Panel

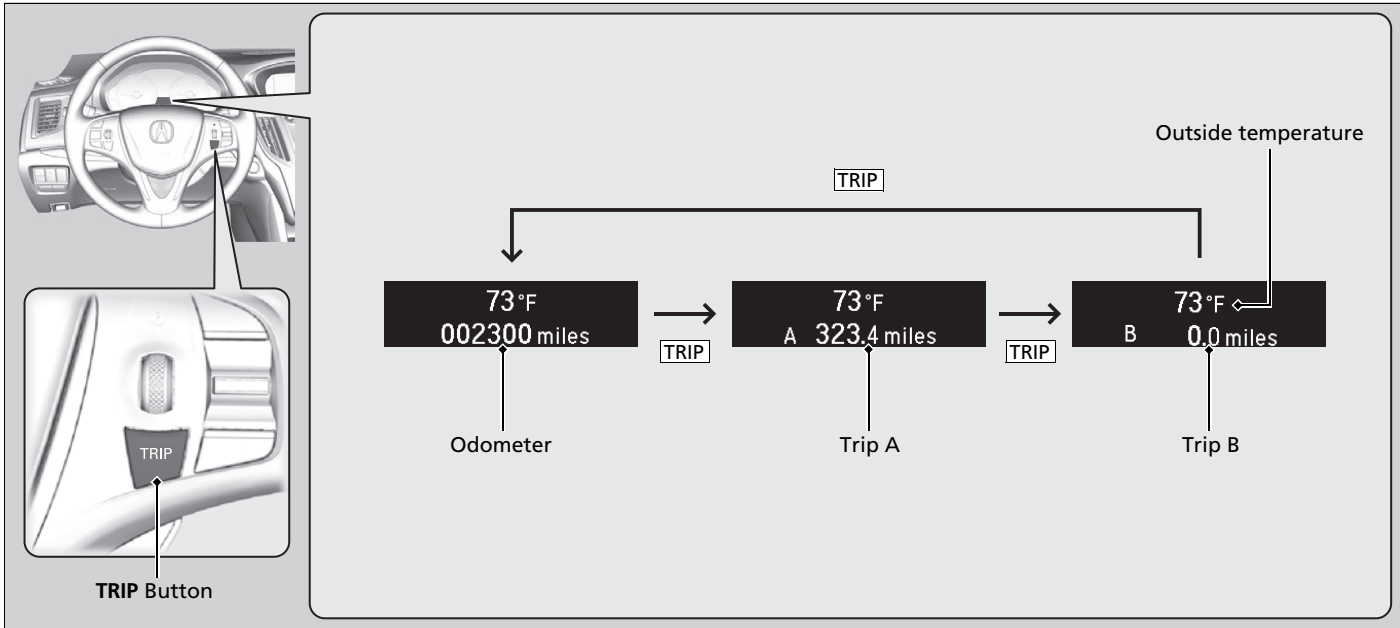

■ Odometer

Shows the total number of miles (U.S.) or kilometers (Canada) that your vehicle has accumulated.

■ Trip Meter

Shows the total number of miles (U.S.) or kilometers (Canada) driven since the last reset. Meters A and B can be used to measure two separate trips.

■ Resetting a trip meter

To reset a trip meter, display it, then press and hold the **TRIP** button. The trip meter is reset to **0.0**.

■ Outside Temperature

Shows the outside temperature in Fahrenheit (U.S.) or Celsius (Canada).

■ Adjusting the outside temperature display

Adjust the temperature reading up to $\pm 5^{\circ}\text{F}$ (U.S.) or $\pm 3^{\circ}\text{C}$ (Canada) if the temperature reading seems incorrect.

■ Average Fuel Economy

Shows the estimated average fuel economy of each trip meter in mpg (U.S.) or l/100 km (Canada). The display is updated at set intervals. When a trip meter is reset, the average fuel economy is also reset.

☒ Trip Meter

Switch between trip meter A and trip meter B by pressing the **TRIP** button.

☒ Outside Temperature

The temperature sensor is in the front bumper. Road heat and exhaust from another vehicle can affect the temperature reading when your vehicle speed is less than 19 mph (30 km/h).

It may take several minutes for the display to be updated after the temperature reading has stabilized.

Use the multi-information display's customized features to correct the temperature.

☒ **Customized Features** P. 120, 292

☒ Average Fuel Economy

You can change when to reset the average fuel economy.

☒ **Customized Features** P. 120, 292

Continued

■ Instant Fuel Economy

Shows the instant fuel economy as a bar graph in mpg (U.S.) or l/100 km (Canada).

■ Range

Shows the estimated distance you can travel on the remaining fuel. This distance is estimated from the fuel economy of your previous trips.

■ Elapsed Time

Shows the time elapsed since the Trip A or Trip B was reset.

■ Average Speed

Shows the average speed in mph (U.S.) or km/h (Canada) since the Trip A or Trip B was reset.

■ Turn-by-Turn Directions*

Shows you turn-by-turn driving directions to your destination linked with the navigation system.

➤ **Refer to the Navigation System Manual**

⌘ Elapsed Time

You can change when to reset the elapsed time.

➤ **Customized Features** P. 120, 292

⌘ Average Speed

You can change when to reset the average speed.

➤ **Customized Features** P. 120, 292

⌘ Turn-by-Turn Directions*

The multi-information display shows a compass when the route guidance is not used.

You can select whether the turn-by-turn display comes on or not during the route guidance.

➤ **Customized Features** P. 120, 292

■ Engine Oil Life and Maintenance Items

Shows the remaining oil life and Maintenance Minder™.

➤ **Maintenance Minder™** P. 469

■ Tire Pressure Monitor

Shows each tire's pressure.

➤ **Tire Pressure Monitoring System (TPMS) with Tire Fill Assist** P. 425

■ Current Mode for Integrated Dynamics System

Shows the current mode for Integrated dynamics system.

➤ **Integrated Dynamics System** P. 388

■ SH-AWD® Torque Distribution Monitor*

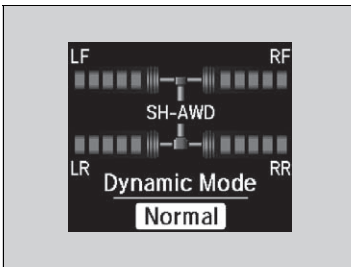

The indicators on the display show the amount of torque being transferred to the right front, left front, right rear, and left rear wheels.

➤ **Super Handling-All Wheel Drive™ (SH-AWD®)*** P. 424

* Not available on all models

■ Customized Features

Use the multi-information display to customize certain features.

■ How to customize

Select the **Vehicle Settings** screen by rolling the right selector wheel while the power mode is in ON, and the vehicle is at a complete stop. Push the right selector wheel.

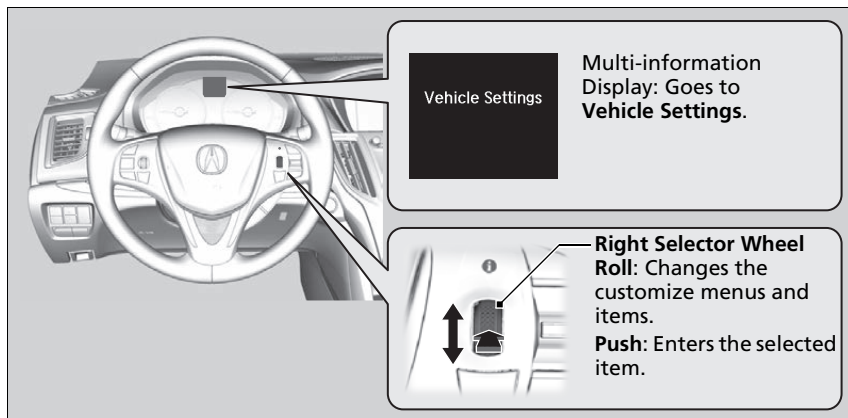

▶ Customized Features

To customize other features, roll the right selector wheel.

- ▶ **List of customizable options** P. 123
- ▶ **Example of customization settings** P. 128

Customization is possible when you see the driver's ID (**Driver 1** or **Driver 2**) on the screen. The driver's ID indicates which remote transmitter you have used to unlock the driver's door. The customized settings are recalled every time you unlock the driver's door with that remote.

Put the transmission into **P** before you attempt to change any customized setting.

Customizing is also available from the information screen.

You cannot have **Vehicle Settings** displayed on the multi-information display while the information screen shows the same menu.

- ▶ **Customized Features** P. 292

■ **Customization flow**

Roll the right selector wheel to select **Vehicle Settings** and push the right selector wheel.

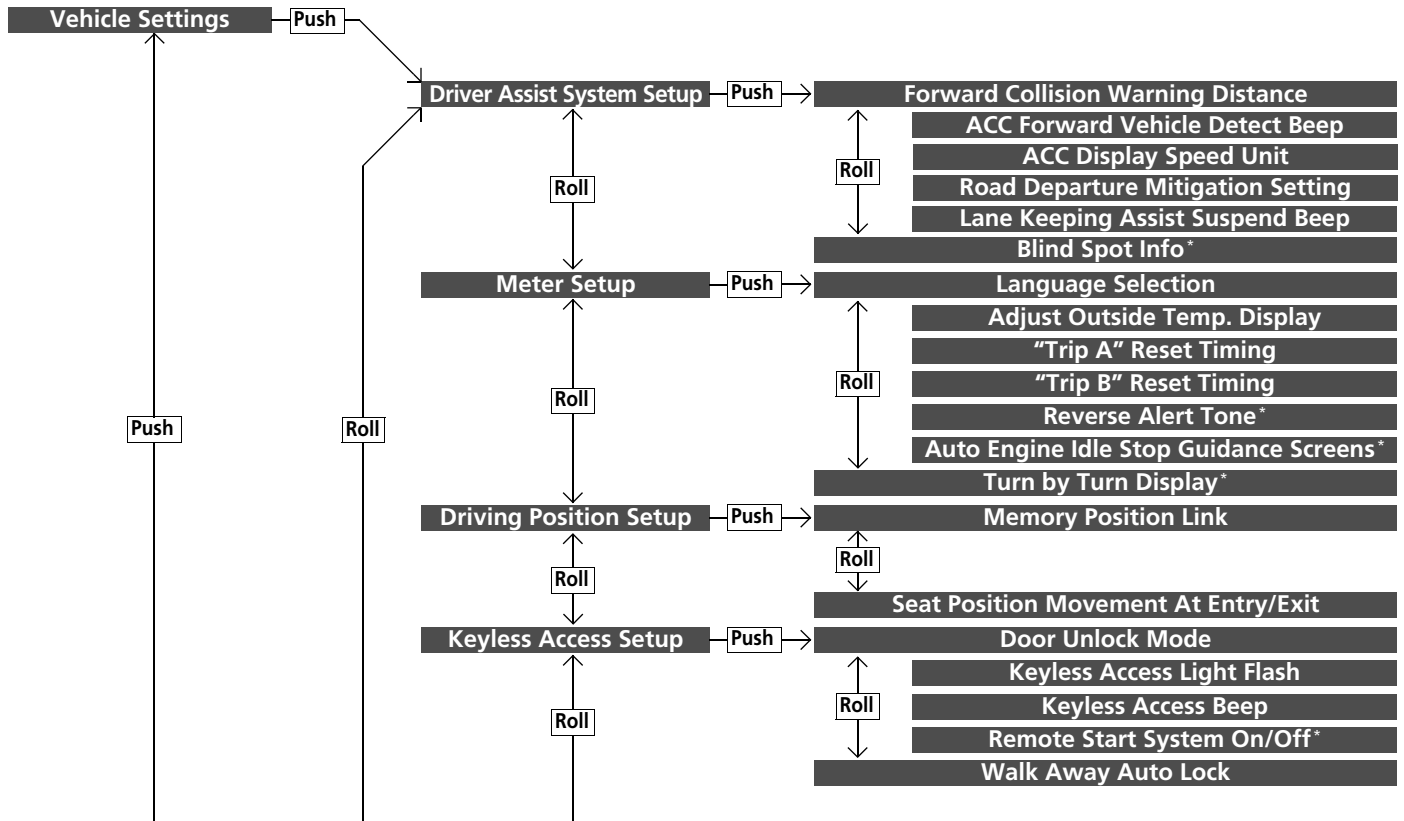

* Not available on all models

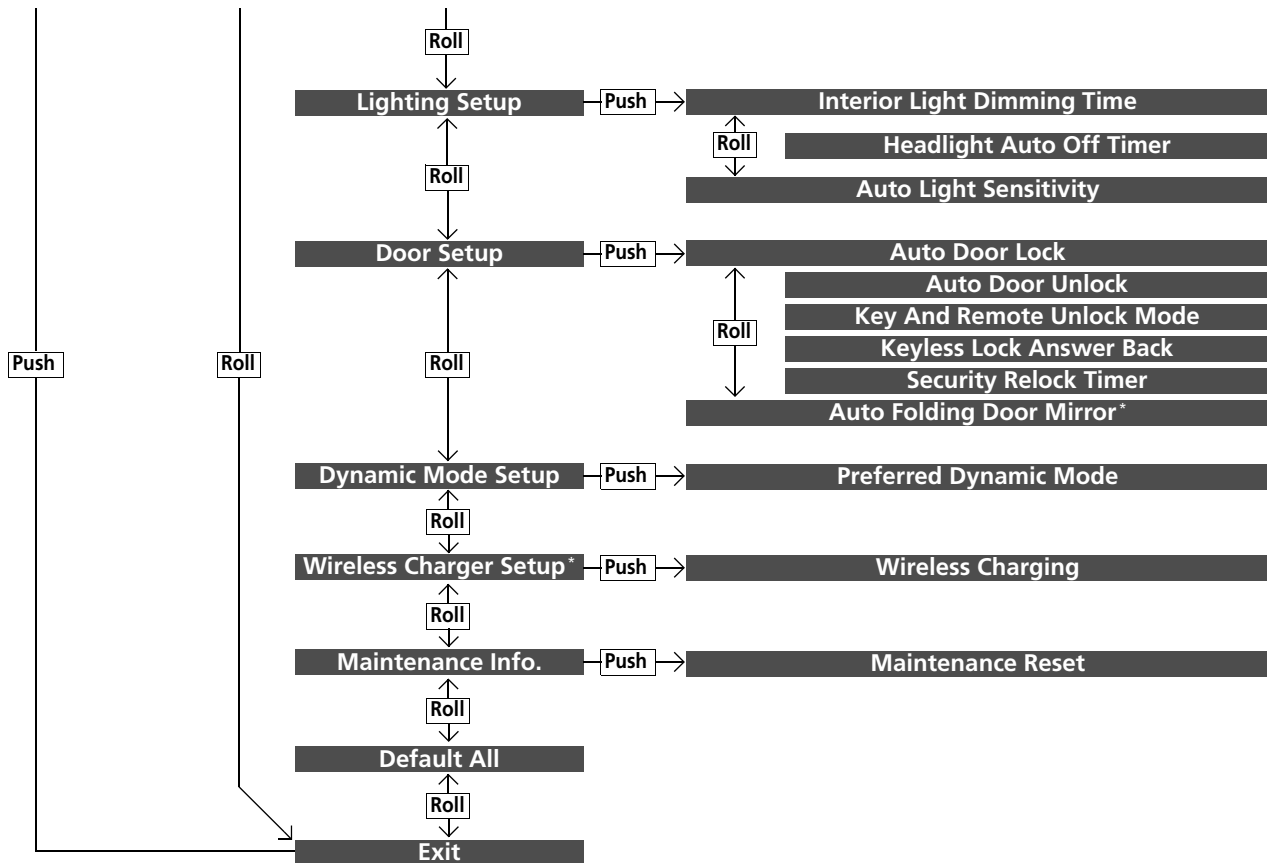

■ List of customizable options

| Setup Group | Customizable Features | Description | Selectable Settings |
|----------------------------|---|--|--|
| Driver Assist System Setup | Forward Collision Warning Distance | Changes at which distance CMBS™ alerts. | Long/Normal*¹/Short |
| | ACC Forward Vehicle Detect Beep | Causes the system to beep when the system detects a vehicle, or when the vehicle goes out of the ACC with LSF range. | On/Off*¹ |
| | ACC Display Speed Unit | Changes the speed unit for ACC with LSF on the multi-information display. | mph*¹/km/h (U.S.) mph/km/h*¹ (Canada) |
| | Road Departure Mitigation Setting | Changes the setting for the road departure mitigation system. | Normal*¹/Wide/Warning Only |
| | Lane Keeping Assist Suspend Beep | Causes the system to beep when the LKAS is suspended. | On/Off*¹ |
| | Blind Spot Info* | Changes the setting for the blind spot information. | Audible And Visual Alert*¹/Visual Alert/Off |

*1:Default Setting

* Not available on all models

| Setup Group | Customizable Features | Description | Selectable Settings |
|--------------------|---|--|--|
| Meter Setup | Language Selection | Changes the displayed language. | English^{*1}/Français/ Español |
| | Adjust Outside Temp. Display | Adjusts the temperature reading by a few degrees. | -5°F ~ ±0°F^{*1} ~ +5°F (U.S.) -3°C ~ ±0°C^{*1} ~ +3°C (Canada) |
| | “Trip A” Reset Timing | Changes the setting of how to reset trip meter A, average fuel economy A, average speed A, and elapsed time A. | When Refueled/IGN Off/ Manually Reset^{*1} |
| | “Trip B” Reset Timing | Changes the setting of how to reset trip meter B, average fuel economy B, average speed B, and elapsed time B. | When Refueled/IGN Off/ Manually Reset^{*1} |
| | Reverse Alert Tone[*] | Causes the beeper to sound once when the change the gear position to [R] . | On^{*1}/Off |
| | Auto Engine Idle Stop Guidance Screens[*] | Selects whether the Auto Idle Stop guidance screens comes on. | On/Off^{*1} |
| | Turn by Turn Display[*] | Selects whether the turn-by-turn display comes on during the route guidance. | On^{*1}/Off |

*1:Default Setting

| Setup Group | Customizable Features | Description | Selectable Settings |
|-------------------------------|---|--|--|
| Driving Position Setup | Memory Position Link | Turns the driving position memory system on and off. | On*¹/Off |
| | Seat Position Movement At Entry/Exit | Depending on the set seating position the driver seat may move forward or rearward when entering/exiting the vehicle. | On*¹/Off |
| Keyless Access Setup | Door Unlock Mode | Changes which doors unlock when you grab the driver's door handle. | Driver Door Only*¹/All Doors |
| | Keyless Access Light Flash | Causes some exterior lights to flash when you unlock/lock the doors. | On*¹/Off |
| | Keyless Access Beep | Causes the beeper to sound when you unlock/lock the doors. | On*¹/Off |
| | Remote Start System On/Off* | Turns the remote engine start feature on and off. | On*¹/Off |
| | Walk Away Auto Lock | Changes the settings for the automatic locking the doors when you walk away from the vehicle while carrying the keyless access remote. | On/Off*¹ |

*1: Default Setting

* Not available on all models

| Setup Group | Customizable Features | Description | Selectable Settings |
|-----------------------|---|---|--|
| Lighting Setup | Interior Light Dimming Time | Changes the length of time the interior lights stay on after you close the doors. | 60sec/30sec^{*1}/15sec |
| | Headlight Auto Off Timer | Changes the length of time the exterior lights stay on after you close the driver's door. | 60sec/30sec/15sec^{*1}/0sec |
| | Auto Light Sensitivity | Changes the timing for the headlights to come on. | Max/High/Mid^{*1}/Low/Min |
| Door Setup | Auto Door Lock | Changes the setting for when the doors automatically lock. | With Vehicle Speed^{*1}/Shift From P/Off |
| | Auto Door Unlock | Changes the setting for when the doors automatically unlock. | All Doors When Driver's Door Opens^{*1}/All Doors When Shifted To Park/All Doors When Ignition Switched Off/Off |
| | Key And Remote Unlock Mode | Sets up either the driver's door or all doors to unlock on the first operation of the remote or built-in key. | Driver Door^{*1}/ All Doors |
| | Keyless Lock Answer Back | LOCK/UNLOCK- The exterior lights flash. LOCK (2nd push)- The beeper sounds. | On^{*1}/Off |
| | Security Relock Timer | Changes the time it takes for the doors to relock and the security system to set after you unlock the vehicle without opening any door. | 90sec/60sec/30sec^{*1} |
| | Auto Folding Door Mirror[*] | Changes how you can fold the door mirrors. | Auto Fold With Keyless^{*1}/ Manual Only |

*1: Default Setting

* Not available on all models

| Setup Group | Customizable Features | Description | Selectable Settings |
|---|-------------------------------|--|---|
| Dynamic Mode Setup | Preferred Dynamic Mode | Changes the Integrated Dynamics System mode setting for when you set the power mode to ON. | Last Used^{*1}/Econ/Normal/Sport |
| Wireless Charger Setup[*] | Wireless Charging | Turns the wireless charging feature on and off. | On^{*1}/Off |
| Maintenance Info. | Maintenance Reset | Resets/Cancel the engine oil life display when you have performed the maintenance service. | Cancel/Reset |
| Default All | — | Cancels/Resets all the customized settings as default. | Cancel/Set |

*1: Default Setting

* Not available on all models

■ Example of customization settings

The steps for changing the “**Trip A**” **Reset Timing** setting to **When Refueled** are shown below. The default setting for “**Trip A**” **Reset Timing** is **Manually Reset**.

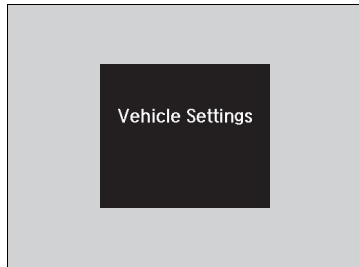

1. Roll the right selector wheel to select **Vehicle Settings**, then push the right selector wheel.



2. Roll the right selector wheel until **Meter Setup** appears on the display.
3. Push the right selector wheel.
 - ▶ **Language Selection** appears first on the display.



4. Roll the right selector wheel until **"Trip A"** **Reset Timing** appears on the display, then push the right selector wheel.
 - The display switches to the customization setup screen, where you can select **When Refueled**, **IGN Off**, **Manually Reset**, or **Exit**.



5. Roll the right selector wheel and select **When Refueled**, then push the right selector wheel.
 - The **When Refueled Setup** screen appears, then the display returns to the customization menu screen.

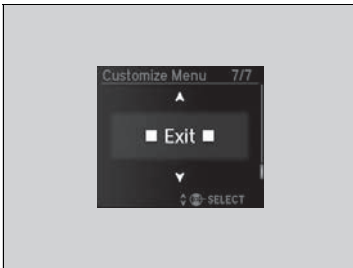

6. Roll the right selector wheel until **Exit** appears on the display, then push the right selector wheel.
7. Repeat Step 6 until you return to the normal screen.

Controls

This chapter explains how to operate the various controls necessary for driving.

| | |
|--|-----|
| Clock | 132 |
| Locking and Unlocking the Doors | |
| Key Types and Functions | 133 |
| Low Keyless Access Remote Signal Strength | 135 |
| Locking/Unlocking the Doors from the Outside | 136 |
| Locking/Unlocking the Doors from the Inside | 144 |
| Childproof Door Locks | 146 |
| Auto Door Locking/Unlocking | 147 |
| Opening and Closing the Trunk | 148 |
| Security System | 151 |
| Immobilizer System | 151 |
| Security System Alarm | 151 |

| | |
|---|-----|
| Opening and Closing the Windows | 154 |
| Opening and Closing the Moonroof | 156 |
| Operating the Switches Around the Steering Wheel | |
| ENGINE START/STOP Button | 157 |
| Turn Signals | 160 |
| Light Switches | 161 |
| Fog Lights* | 164 |
| Daytime Running Lights | 164 |
| Auto High-Beam | 165 |
| Wipers and Washers | 168 |
| Brightness Control | 171 |
| Rear Defogger/Heated Door Mirror Button | 172 |

| | |
|---|-----|
| Driving Position Memory System | 173 |
| Adjusting the Steering Wheel | 175 |
| Adjusting the Mirrors | 176 |
| Interior Rearview Mirror | 176 |
| Power Door Mirrors | 177 |
| Adjusting the Seats | 179 |
| Front Seats | 179 |
| Interior Lights/Interior Convenience Items | 188 |
| Interior Lights | 188 |
| Interior Convenience Items | 191 |
| Climate Control System | 204 |
| Using Automatic Climate Control | 204 |
| Automatic Climate Control Sensors | 211 |

* Not available on all models

Adjusting the Clock

Models without navigation system

You can also adjust the time manually in the information screen, with the power mode in ON.

Adjusting the Time

Using the Settings menu on the information screen

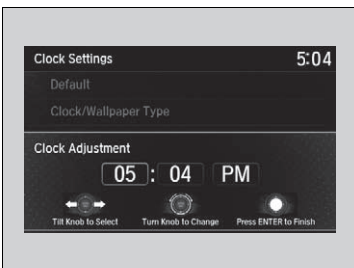

1. Press the **SETTINGS** button.
2. Rotate to select **Clock Settings**, then press .
 - ▶ Repeat the procedure to select **Clock Adjustment**.
3. Rotate to change hour, then move .
4. Rotate to change minute, then press .

Adjusting the Clock

These indications are used to show how to operate the interface dial.

Rotate to select.

Press to enter.

Move to select a secondary menu.

You can customize the clock display to show the 12 hour clock or 24 hour clock.

Customized Features P. 292

You can turn the clock display in the information screen on and off.

Customized Features P. 292

Except Canadian models

You cannot adjust the time while the vehicle is moving.

Models with navigation system

The clock is automatically updated through the navigation system, so the time does not need to be adjusted.

Key Types and Functions

This vehicle comes with the following keys:

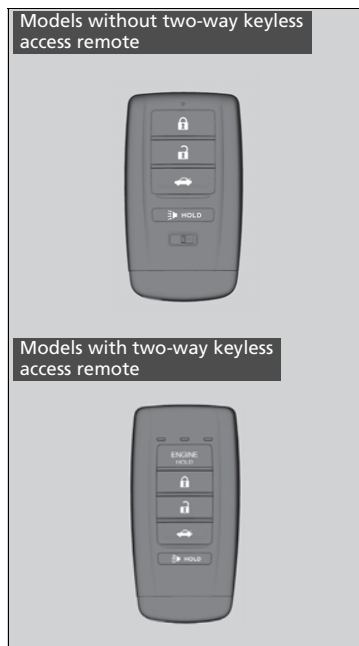

Use the keys to start and stop the engine, and to lock and unlock all the doors and trunk. You can also use the remote transmitter to lock and unlock the doors and trunk.

Key Types and Functions

All the keys have an immobilizer system. The immobilizer system helps to protect against vehicle theft.

Immobilizer System P. 151

Follow the advice below to prevent damage to the keys:

- Do not leave the keys in direct sunlight, or in locations with high temperature or high humidity.
- Do not drop the keys or set heavy objects on them.
- Keep the keys away from liquids, dust and sand.
- Do not take the keys apart except for replacing the battery.

If the circuits in the keys are damaged, the engine may not start, and the remote transmitter may not work.

If the keys do not work properly, have them inspected by a dealer.

Models with two-way keyless access remote

You can remotely start the engine using the two-way keyless access remote.

Remote Engine Start with Vehicle Feedback* P. 365

* Not available on all models

■ Keyless Access Remote

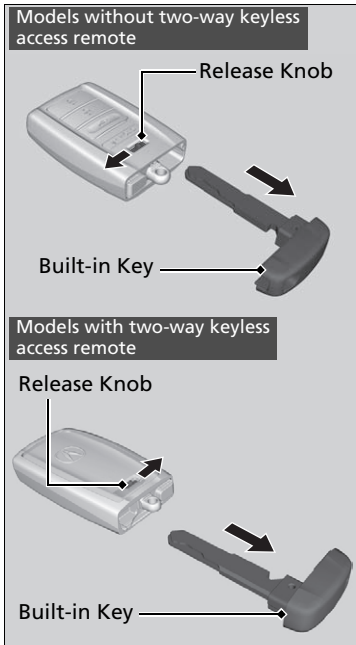

The built-in key can be used to lock/unlock the doors when the keyless access remote battery becomes weak and the power door lock/unlock operation is disabled.

To remove the built-in key, slide the release knob and then pull out the key. To reinstall the built-in key, push the built-in key into the keyless access remote until it clicks.

■ Key Number Tag

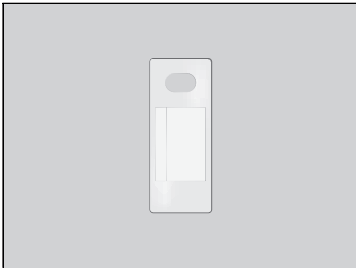

Contains a number that you will need if you purchase a replacement key.

Low Keyless Access Remote Signal Strength

The vehicle transmits radio waves to locate the keyless access remote when locking/unlocking the doors, opening the trunk, or to start the engine.

In the following cases, locking/unlocking the doors, opening the trunk, or starting the engine may be inhibited or operation may be unstable:

- Strong radio waves are being transmitted by nearby equipment.
- You are carrying the keyless access remote together with telecommunications equipment, laptop computers, cell phones, or wireless devices.
- A metallic object is touching or covering the keyless access remote.

☒ Key Number Tag

Keep the key number tag separate from the key in a safe place outside of your vehicle. If you wish to purchase an additional key, contact a dealer.

If you lose your key and you cannot start the engine, contact a dealer.

☒ Low Keyless Access Remote Signal Strength

Communication between the keyless access remote and the vehicle consumes the keyless access remote's battery.

Battery life is about two years, but this varies depending on regularity of use.

The battery is consumed whenever the keyless access remote is receiving strong radio waves. Avoid placing it near electrical appliances such as televisions and personal computers.

Locking/Unlocking the Doors from the Outside

■ Using the Keyless Access System

Models without rear door touch sensor

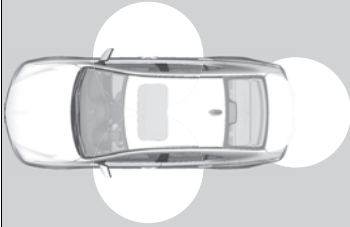

Models with rear door touch sensor

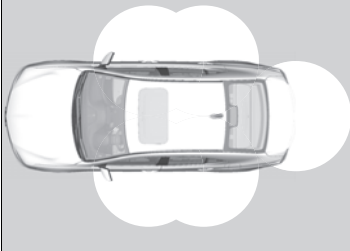

When you carry the keyless access remote, you can lock/unlock the doors and open the trunk.
You can lock/unlock the doors and trunk within a radius of about 32 inches (80 cm) of the outside door handle or trunk release button.

☒ Locking/Unlocking the Doors from the Outside

If the interior light switch is in the door activated position, the interior light comes on when you unlock the doors.

No doors opened: The light fades out after 30 seconds.

Doors relocked: The light goes off immediately.

☒ **Interior Lights** P. 188

☒ Using the Keyless Access System

If you do not open a door within 30 seconds of unlocking the vehicle with the keyless access system, the doors will automatically relock.

You can lock or unlock doors using the keyless access system only when the power mode is in VEHICLE OFF.

■ Locking the doors and trunk

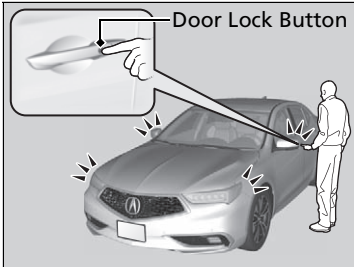

Press the door lock button on the front or rear* door.

- ▶ Some exterior lights flash; the beeper sounds; all the doors lock; and the security system sets.

☒ Using the Keyless Access System

- Do not leave the keyless access remote in the vehicle when you get out. Carry it with you.
- Even if you are not carrying the keyless access remote, you can lock/unlock the doors while someone else with the remote is within range.
- The door may be unlocked if the door handle is covered with water in heavy rain or in a car wash if the keyless access remote is within range.
- If you grip a front or rear* door handle wearing gloves, the door sensor may be slow to respond or may not respond by unlocking the doors.
- After locking the door, you have up to two seconds during which you can pull the door handle to confirm whether the door is locked. If you need to unlock the door immediately after locking it, wait at least two seconds before gripping the handle, otherwise the door will not unlock.
- The door might not open if you pull it immediately after gripping the door handle. Grip the handle again and confirm that the door is unlocked before pulling the handle.
- Even within the 32 inches (80 cm) radius, you may not be able to lock/unlock the doors with the keyless access remote if it is above or below the outside handle.
- The keyless access remote may not operate if it is too close to the door and door glass.

* Not available on all models

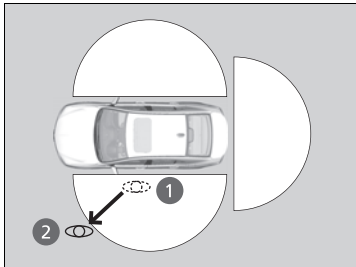
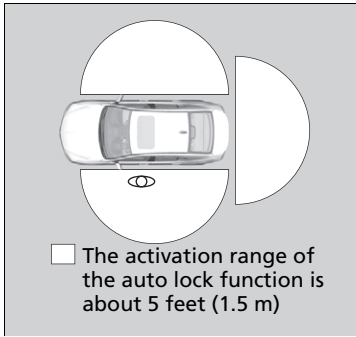

■ Locking the doors and trunk (Walk away auto lock)

When you walk away from the vehicle while carrying the keyless access remote, the doors will automatically lock.

The auto lock function activates when all doors are closed, and the keyless access remote is within about 5 feet (1.5 m) radius of the outside door handle.

Exit vehicle while carrying keyless access remote and close door(s).

1. While within about 5 feet (1.5 m) radius of the vehicle.

▶ The beeper sounds; the auto lock function will be activated.

2. Carry the keyless access remote beyond about 5 feet (1.5 m) from the vehicle and remain outside this range for 2 or more seconds.

▶ Some exterior lights flash; the beeper sounds; all doors will then lock.

▶ Locking the doors and trunk (Walk away auto lock)

The auto lock function is set to OFF as the factory default setting. The auto lock function can be set to ON using the information screen or multi-information display.

If you set the auto lock function to ON using the information screen or the multi-information display, only the remote transmitter that was used to unlock the driver's door prior to the setting change can activate auto lock.

▶ **Customized Features** P. 120, 292

After the auto lock function has been activated, when you stay within the locking/unlocking operation range, the indicator on the keyless access remote will continue to flash until the doors are locked.

When you stay beside the vehicle within the operation range, the doors will automatically lock approximately 30 seconds after the auto lock function activating beeper sounds.

When you open a door after the auto lock function activating beeper sounds, the auto lock function will be delayed until all doors are closed.

When all doors have been closed and the keyless access remote is inside the vehicle, or if the keyless access remote is not detected within about 5 feet (1.5 m) of the vehicle, auto lock function will not be activated.

To temporarily deactivate the function:

1. Set the power mode to OFF.
2. Open the driver's door.
3. Using the master door lock switch, operate the lock as follows:
Lock → Unlock → Lock → Unlock.
▶ The beeper sounds and the function is deactivated.

To restore the function (any step below):

- Set the power mode to ON.
- Lock the vehicle without using the auto lock function.
- With the keyless access remote on you, move out of the auto lock function operation range.
- Open any door.

⌘ Locking the doors and trunk (Walk away auto lock)

The auto lock function does not operate when any of the following conditions are met.

- The keyless access remote is inside the vehicle.
- A door or the hood is not closed.
- The power mode is set to any mode other than OFF.
- The keyless access remote is not located within a radius of about 5 feet (1.5 m) from the vehicle when you get out of the vehicle and close the doors.

Auto lock function operation stop beeper

After the auto lock function has been activated, the auto lock operation stop beeper sounds for approximately two seconds in the following cases.

- The keyless access remote is put inside the vehicle through a window.
 - You are located too close to the vehicle.
 - The keyless access remote is put inside the trunk.
- If the warning beeper sounds, check that you are carrying the keyless access remote. Then, open/close a door and confirm the auto lock activation beeper sounds once.

■ Unlocking the doors and trunk

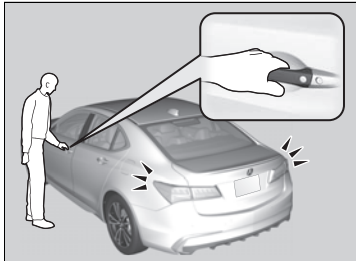

- Grab the driver's door handle:
- ▶ The driver's door unlocks.
 - ▶ Some exterior lights flash twice and the beeper sounds twice.

Grab the front passenger's or rear* door handle:

- ▶ All doors unlock.
- ▶ Some exterior lights flash twice and the beeper sounds twice.

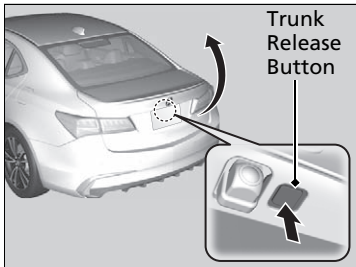

- Press the trunk release button:
- ▶ The trunk unlocks and opens.
 - ▶ A beeper will sound.
- **Using the Trunk Release Button** P. 149

➤ Using the Keyless Access System

The light flash, beep and door unlock mode settings can be customized using the information screen or multi-information display.

➤ **Customized Features** P. 120, 292

Models with puddle lights

When you go into the keyless access system working range with all the doors locked, the puddle lights come on for 30 seconds.

The lights do not come on if you have previously stayed within the range for more than two minutes, or the doors have been locked for a few days.

The feature activates again after you open and close any door, then lock the doors.

■ Using the Remote Transmitter

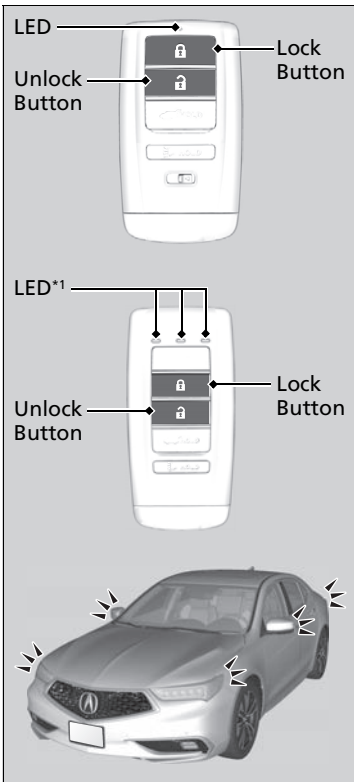

■ Locking the doors

Press the lock button.

Once:

- ▶ Some exterior lights flash, all the doors lock, and the security system sets.

Twice (within five seconds after the first push):

- ▶ The beeper sounds and verifies the security system is set.

■ Unlocking the doors

Press the unlock button.

Once:

- ▶ Some exterior lights flash twice, and the driver's door unlocks.

Twice:

- ▶ The remaining doors unlock.

*1: **Checking Door Lock Status** P. 143

* Not available on all models

☒ Using the Remote Transmitter

If you do not open a door within 30 seconds of unlocking the vehicle with the remote transmitter, the doors will automatically relock.

You can change the relock timer setting.

☒ **Customized Features** P. 120, 292

You can lock or unlock doors using the remote transmitter only when the power mode is in VEHICLE OFF.

The remote transmitter uses low-power signals, so the operating range may vary depending on the surroundings.

The remote will not lock the vehicle when a door is open.

If the distance at which the remote transmitter works varies, the battery is probably low.

If the LED does not come on when you press a button, the battery is dead.

☒ **Replacing the Button Battery** P. 506

You can customize the door unlock mode setting.

☒ **Customized Features** P. 120, 292

■ Locking/Unlocking the Doors Using a Key

If the keyless access remote battery or the vehicle battery is dead, use the key instead of the keyless access remote.

➤ **Replacing the Button Battery** P. 506

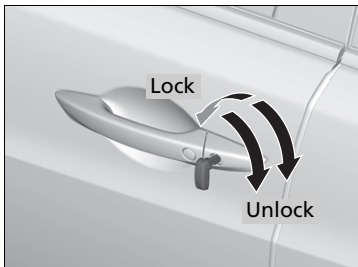

Fully insert the key and turn it.

■ Locking a Door Without Using a Key

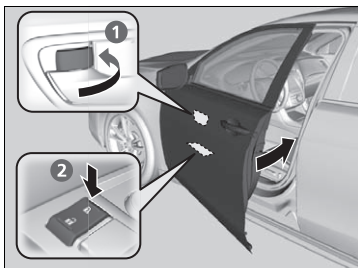

■ Locking the front doors

Push the lock tab forward ① or push the master door lock switch in the lock direction ②, and close the door.

■ Locking the rear doors

Push the lock tab forward and close the door.

■ Lockout prevention system

The doors cannot be locked when the keyless access remote is inside the vehicle.

☒ Locking/Unlocking the Doors Using a Key

When you lock the driver's door with a key, all the other doors lock at the same time. When unlocking, the driver's door unlocks first. Turn the key a second time within a few seconds to unlock the remaining doors.

You can customize the door unlock mode setting.

➤ **Customized Features** P. 120, 292

☒ Locking a Door Without Using a Key

When you lock the driver's door, all the other doors lock at the same time. Make sure you have the key in your hand when you lock the driver's door, any of the other doors, otherwise you may end up locking the key inside the vehicle.

■ Checking Door Lock Status*

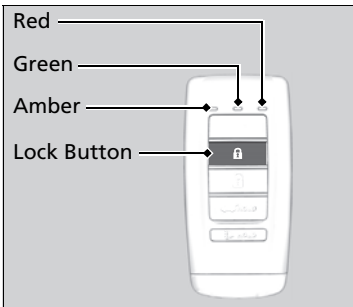

You can remotely check if your vehicle's doors are all locked or any are unlocked using the keyless access remote from extended distances.

Press the lock button, the Amber (LEFT) LED blinks once. Then after three seconds one of the following feedback will come:

- Green (center) comes on: Acknowledges that the doors are locked.
- Red (right) comes on: Acknowledges that doors are not locked, or any door is not completely closed.
- Red (right) blinks three times: The remote does not receive the door lock status from the vehicle.

* Not available on all models

☒ Checking Door Lock Status*

Operate the remote in an open space. If there are buildings or other obstacles between your vehicle and the remote, the remote may not work even within the operable range. However, the range required for unlocking the trunk and all the doors as well as activating the panic function is the same as that required for operating the standard keyless access remote.

☒ **Using the Remote Transmitter** P. 141

When checking the door lock status, you can also start or stop the engine.

☒ **Remote Engine Start with Vehicle Feedback*** P. 365

Locking/Unlocking the Doors from the Inside

■ Using the Lock Tab

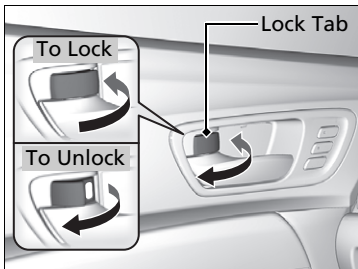

■ **Locking a door**
Push the lock tab forward.

■ **Unlocking a door**
Pull the lock tab rearward.

☒ Using the Lock Tab

When you lock the door using the lock tab on the driver's door, all of the other doors lock at the same time.

When you unlock the door using the lock tab on the driver's door, only the driver's door will unlock.

■ Unlocking Using the Front Door Inner Handle

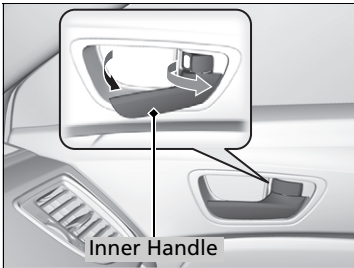

Pull the front door inner handle.

- ▶ The door unlocks and opens in one motion.

Unlocking and opening the driver's door from the inner handle unlocks all the other doors.

To avoid all the doors to be unlocked, use the lock tab on the driver's door to unlock, then lock again before opening the door.

- ▶ This setting works for one time only. If you do not want all the doors to be unlocked all the time, customize the **Auto Door Unlock** setting to **Off** using the multi-information display or information screen.

☒ Unlocking Using the Front Door Inner Handle

The front door inner handles are designed to allow front seat occupants to open the door in one motion. However, this feature requires that front seat occupants never pull a front door inner handle while the vehicle is in motion.

Children should always ride in a rear seat where childproof door locks are provided.

☒ **Childproof Door Locks** P. 146

■ Using the Master Door Lock Switch

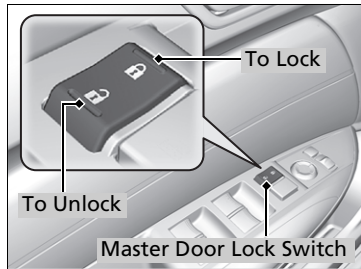

Press the master door lock switch in as shown to lock or unlock all the doors.

Childproof Door Locks

The childproof door locks prevent the rear doors from being opened from the inside regardless of the position of the lock tab.

■ Setting the Childproof Door Locks

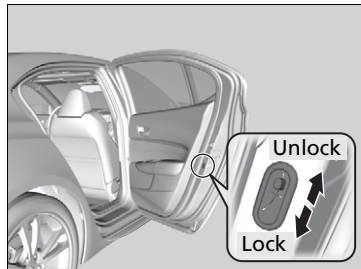

Slide the lever in the rear door to the lock position, and close the door.

■ When opening the door

Open the door using the outside door handle.

☒ Using the Master Door Lock Switch

When you lock/unlock either front door using the master door lock switch, all the other doors lock/unlock at the same time.

☒ Childproof Door Locks

To open the door from the inside when the childproof door lock is on, put the lock tab in the unlock position, lower the rear window, put your hand out of the window, and pull the outside door handle.

Auto Door Locking/Unlocking

Your vehicle locks or unlocks all doors automatically when certain conditions are met.

■ Auto Door Locking

■ Drive lock mode

All doors lock when the vehicle's speed reaches about 10 mph (15 km/h).

■ Auto Door Unlocking

■ Driver's door open mode

All doors unlock when the driver's door is opened.

☒ Auto Door Locking/Unlocking

You can turn off or change to another auto door locking/unlocking setting using the information screen or multi-information display.

☒ **Customized Features** P. 120, 292

Precautions for Opening/Closing the Trunk

■ Opening the trunk

Open the trunk all the way.

- ▶ If it is not fully opened, the trunk lid may begin to close under its own weight.

■ Closing the trunk

Keep the trunk lid closed while driving to:

- ▶ Avoid possible damage.
- ▶ Prevent exhaust gas from leaking into the vehicle.

➤ **Exhaust Gas Hazard** P. 69

Using the Trunk Opener

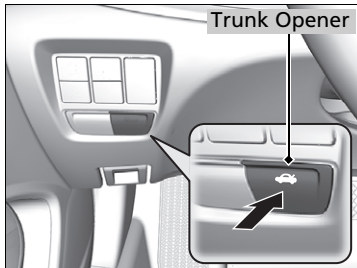

Pressing the trunk opener on the driver side control panel unlocks and opens the trunk.

➤ **When You Cannot Open the Trunk** P. 562

Using the Trunk Release Button

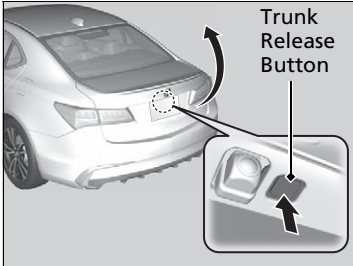

Push up the release button on the trunk lid after the doors are unlocked.

❗ **When You Cannot Open the Trunk** P. 562

Even if the trunk is locked, you can open the trunk if you carry the keyless access remote.

▶ The beeper sounds.

Using the Remote Transmitter

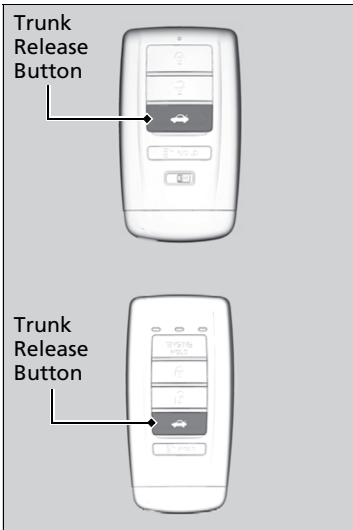

Press the trunk release button for approximately one second to unlock and open the trunk.

⊗ Using the Trunk Release Button

- If you forget the remote inside, the beeper will sound and the trunk will not close.
- A person who is not carrying the keyless access remote can unlock the trunk if a person who is carrying it is within range.
- If the beeper sounds after you close the trunk, move the keyless access remote away from the trunk and close again.
- The keyless access remote may not operate if it is too close to the trunk.

⊗ Using the Remote Transmitter

If the driver's door is locked, the trunk will automatically lock when you close it. Otherwise, you will have to lock it manually.

Trunk Main Switch

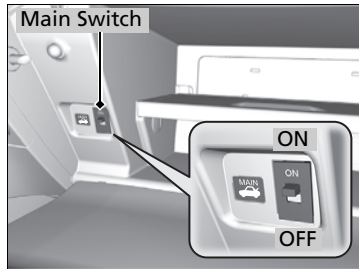

The trunk main switch disables the trunk release button on the remote transmitter, the trunk release button on the trunk lid and trunk opener on the driver side control panel to protect cargo in the trunk.

1. Make sure the rear seat-back is not folded down.
2. Turn off the trunk main switch in the glove box.
3. Lock the glove box.

Emergency Trunk Opener

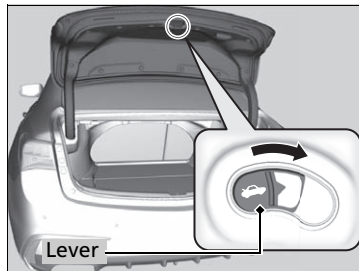

The trunk release lever allows you to open the trunk from inside for your safety.

Slide the release lever in the direction of the arrow.

Trunk Main Switch

If you need to give the key to someone else, remove the built-in key from the keyless access remote by sliding the release knob, and give the remote as a valet key.

Emergency Trunk Opener

Parents should decide if their children should be shown how to use this feature.

Immobilizer System

The immobilizer system prevents a key that has not been pre-registered from starting the engine. Each key contains electronic transmitters that use electronic signals to verify the key.

Pay attention to the following when pressing the **ENGINE START/STOP** button:

- Do not allow objects that emit strong radio waves near the **ENGINE START/STOP** button.
- Make sure the key is not covered by or touching a metal object.
- Do not bring a key from another vehicle's immobilizer system near the **ENGINE START/STOP** button.
- Do not put the key near magnetic items. Electronic devices, such as televisions and audio systems emit strong magnetic fields. Note that even a key chain can become magnetic.

Security System Alarm

The security system alarm activates when the trunk, hood or doors are forcibly opened. The alarm does not activate if the trunk or doors are opened with the key, remote transmitter or keyless access system.

Models with shift lever

However, the alarm activates if a door is opened with the key and then the transmission is taken out of **P** or the hood is opened before the power mode is set to ON.

Models with electronic gear selector

However, the alarm activates if a door is opened with the key and then the hood is opened before the power mode is set to ON.

■ When the security system alarm activates

The horn sounds intermittently and some exterior lights flash.

Immobilizer System

NOTICE

Leaving the key in the vehicle can result in theft or accidental movement of the vehicle. Always take the key with you whenever you leave the vehicle unattended.

Do not alter the system or add other devices to it. Doing so may damage the system and make your vehicle inoperable.

Security System Alarm

Do not alter the system or add other devices to it. Doing so may damage the system and make your vehicle inoperable.

The security alarm continues for a maximum of two minutes until the security system alarm deactivates.

■ To deactivate the security system alarm

Unlock the vehicle using the key, remote transmitter or keyless access system. The system, along with the horn and flashing lights, is deactivated.

■ Setting the security system alarm

The security system alarm automatically sets when the following conditions have been met:

- The power mode is set to VEHICLE OFF (LOCK).
- The hood is closed.
- All doors and the trunk are locked from outside with the key, remote transmitter or keyless access system.

■ When the security system alarm sets

The security system alarm indicator in the instrument panel blinks. When the blinking interval changes after about 15 seconds, the security system alarm is set.

■ To cancel the security system alarm

The security system alarm is canceled when the vehicle is unlocked using the remote transmitter or keyless access system, or the power mode is set to ON. The security system alarm indicator goes off at the same time.

» Security System Alarm

Do not set the security system alarm when someone is in the vehicle or a window is open. The system can accidentally activate when:

- Unlocking the door with the lock tab.
- Opening the trunk with the trunk opener or the emergency trunk opener.
- Opening the hood with the hood release.

Models with shift lever

- Taking the transmission out of **P**.

If the battery goes dead after you have set the security system alarm, the security alarm may go off once the battery is recharged or replaced.

If this occurs, deactivate the security system alarm by unlocking a door using the key, remote transmitter or keyless access system.

■ Panic Mode

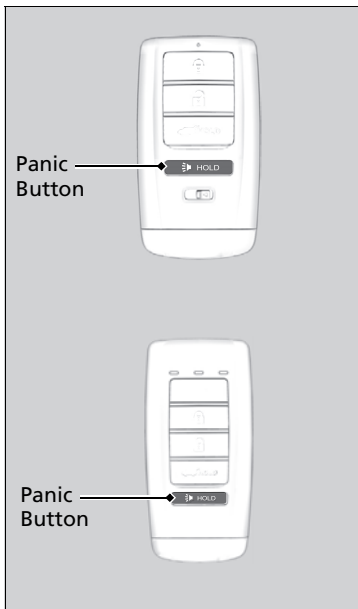

■ The panic button on the remote transmitter

If you press the panic button for approximately one second, the following will occur for about 30 seconds:

- The horn sounds.
- Some exterior lights flash.

■ Canceling panic mode

Press any button on the remote transmitter, or set the power mode to ON.

Opening/Closing the Power Windows

The power windows can be opened and closed when the power mode is in ON, using the switches on the doors.

The driver's side switches can be used to open and close all the windows. The power window lock button on the driver's side must be switched off (not pushed in, indicator off) to open and close the windows from anywhere other than the driver's seat.

When the power window lock button is pushed in, the indicator comes on and you can only operate the driver's window. Turn the power window lock button on if a child is in the vehicle.

Opening/Closing the Power Windows

WARNING

Closing a power window on someone's hands or fingers can cause serious injury.

Make sure your passengers are away from the windows before closing them.

The power windows can be operated for up to 10 minutes after you set the power mode to VEHICLE OFF (LOCK).
Opening either front door cancels this function.

Auto Reverse

If a power window senses resistance when closing automatically, it will stop closing and reverse direction.

The driver's window auto reverse function is disabled when you continuously pull up the switch.

The auto reverse function stops sensing when the window is almost closed to ensure that it fully closes.

Opening/Closing Windows with Auto-Open/Close Function

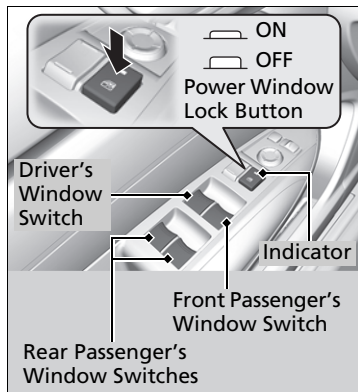

■ Manual operation

To open: Push the switch down lightly, and hold it until the desired position is reached.

To close: Pull the switch up lightly, and hold it until the desired position is reached.

■ Automatic operation

To open: Push the switch down firmly.

To close: Pull the switch up firmly.

The window opens or closes completely. To stop the window at any time, push or pull the switch briefly.

■ Opening the Windows and Moonroof with the Remote

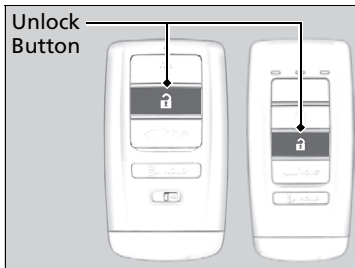

To open: Press the unlock button, and then within 10 seconds, press it again and hold it.

If the windows and moonroof stop midway, repeat the procedure.

■ Opening/Closing the Windows and Moonroof with the Key

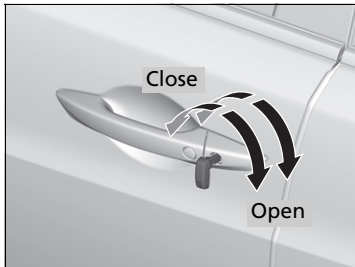

To open: Unlock the driver's door with the key. Within 10 seconds of returning the key to the central position, turn the key in the unlock direction and hold it there.

To close: Lock the driver's door with the key. Within 10 seconds of returning the key to the central position, turn the key in the lock direction and hold it there.

Release the key to stop the windows and moonroof at the desired position. If you want further adjustment, repeat the same operation.

■ Opening/Closing the Moonroof

You can only operate the moonroof when the power mode is in ON. Use the switch in the front of the ceiling to open and close the moonroof.

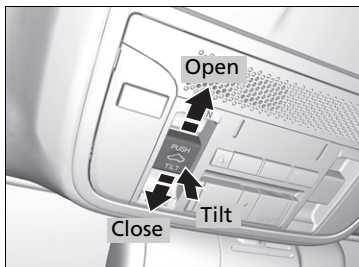

■ Automatic operation

To open: Pull the switch back firmly.

To close: Push the switch forward firmly.

The moonroof will automatically open or close all the way. To stop the moonroof midway, push the switch briefly.

■ Manual operation

To open: Pull the switch back lightly, and hold it until the desired position is reached.

To close: Push the switch forward lightly, and hold it until the desired position is reached.

■ Tilting the moonroof up

To tilt: Push on the center of the moonroof switch.

To close: Push the switch forward firmly, then release.

☞ Opening/Closing the Moonroof

⚠ WARNING

Opening or closing the moonroof on someone's hands or fingers can cause serious injury.

Make sure all hands and fingers are clear of the moonroof before opening or closing it.

NOTICE

Opening the moonroof in below freezing temperature or when it is covered with snow or ice can damage the moonroof panel or motor.

The power moonroof can be operated for up to 10 minutes after you set the power mode to VEHICLE OFF (LOCK).

Opening either front door cancels this function.

When resistance is detected, the auto reverse function causes the moonroof to change directions, then stop. Auto reverse stops sensing when the moonroof is almost closed to ensure that it fully closes. Make sure that all objects, including fingers, are clear of the moonroof.

You can use the remote transmitter or the key to operate the moonroof.

☞ **Opening the Windows and Moonroof with the Remote** P. 155

☞ **Opening/Closing the Windows and Moonroof with the Key** P. 155

ENGINE START/STOP Button

Changing the Power Mode

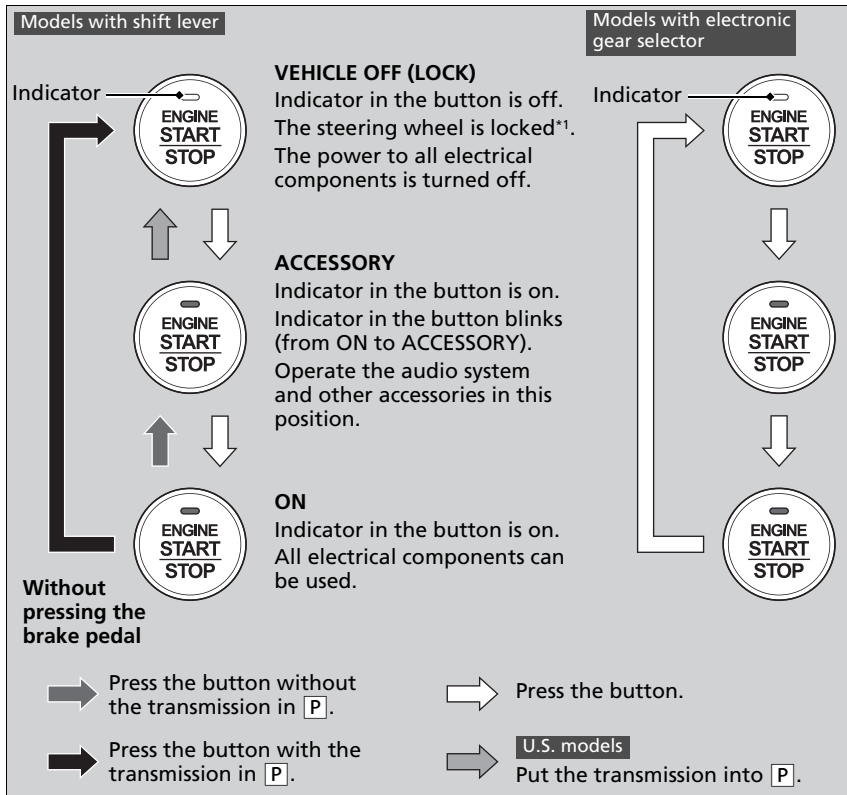

*1: Canadian models

ENGINE START/STOP Button

ENGINE START/STOP Button Operating Range

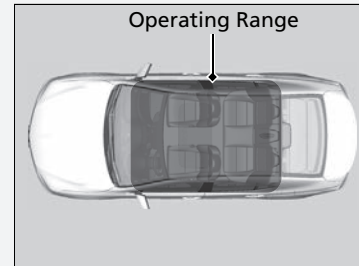

You can start the engine when the keyless access remote is inside the vehicle. The engine may also run if the keyless access remote is close to the door or window, even if it is outside the vehicle.

ON mode:
Indicator in the button is off, if the engine is running.

If the battery of the keyless access remote is getting low, the engine may not start when you press the **ENGINE START/STOP** button. If the engine does not start, refer to the following link.

➔ If the Keyless Access Remote Battery is Weak P. 540

Do not leave the power mode in ACCESSORY or ON when you get out.

■ Automatic Power Off

If you leave the vehicle for 30 to 60 minutes with the transmission in **P** and the power mode in ACCESSORY, the vehicle automatically goes into the mode similar to VEHICLE OFF (LOCK) to avoid draining the battery.

Canadian models

When in this mode:

The steering wheel does not lock.

You cannot lock or unlock doors with the remote transmitter or the keyless access system.

Press the **ENGINE START/STOP** button twice to switch the mode to VEHICLE OFF (LOCK).

■ Power Mode Reminder

If you open the driver's door when the power mode is set to ACCESSORY, a warning beep sounds.

■ Keyless Access Remote Reminder

Keyless Remote
Not Detected



Warning buzzers may sound from inside and/or outside the vehicle to remind you that the keyless access remote is out of the vehicle. If the buzzer continues even after the remote is put back inside, place it to be within its operational range.

■ When the power mode is in ON

If the keyless access remote is taken out of the vehicle, and the driver's door is closed, a warning buzzer sounds from both inside and outside the vehicle. A warning message on the multi-information display notifies the driver inside that the remote is outside of the vehicle.

■ When the power mode is in ACCESSORY

If the keyless access remote is taken out of the vehicle, and the driver's door is closed, a warning buzzer sounds from outside the vehicle.

⊠ Keyless Access Remote Reminder

When the keyless access remote is within the system's operational range, and the driver's door is closed, the warning function cancels.

If the keyless access remote is taken out of the vehicle after the engine has been started, you can no longer change the **ENGINE START/STOP** button mode or restart the engine. Always make sure if the remote is in your vehicle when you operate the **ENGINE START/STOP** button.

Removing the keyless access remote from the vehicle through a window does not activate the warning buzzer.

Do not put the keyless access remote on the dashboard or in the glove box. It may cause the warning buzzer to go off. Under some other conditions that can prevent the vehicle from locating the remote, the warning buzzer may also go off even if the remote is within the system's operational range.

Turn Signals

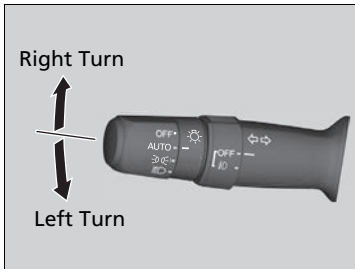

The turn signals can be used when the power mode is in ON.

■ One-touch turn signal

When you lightly push up or down and release the turn signal lever, the exterior turn signals and turn signal indicator blink three times.

This feature can be used when signaling for a lane change.

Light Switches

Manual Operation

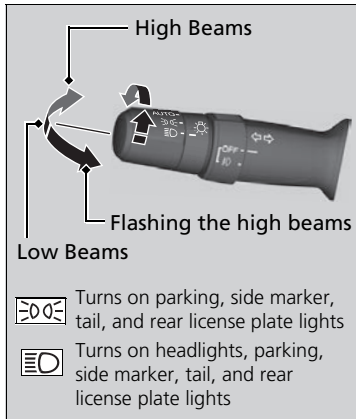

Rotating the light switch turns the lights on and off, regardless of the power mode setting.

High beams

Push the lever forward until you hear a click.

Low beams

When in high beams, pull the lever back to return to low beams.

Flashing the high beams

Pull the lever back, and release it.

Lights off

Turn the lever to **OFF** either when:

- The transmission is in **P**.
- The parking brake is applied.

To turn the lights on again, turn the lever to **OFF** to cancel the lights off mode. Even if you do not cancel the lights off mode, the lights come on automatically when:

- The transmission is taken out of **P** and the parking brake is released.
- The vehicle starts to move.

Light Switches

If you leave the power mode in VEHICLE OFF (LOCK) while the lights are on, a chime sounds when the driver's door is opened.

When the lights are on, the lights on indicator in the instrument panel will be on.

 **Lights On Indicator** P. 82

Do not leave the lights on when the engine is off because it will cause the battery to discharge.

If you sense that the level of the headlights is abnormal, have the vehicle inspected by a dealer.

■ Automatic Operation (automatic lighting control)



Automatic lighting control can be used when the power mode is in ON.

When the light switch is in **AUTO**, the headlights and other exterior lights will switch on and off automatically depending on the ambient brightness.

You can change the auto light sensitivity setting.

▶ **Customized Features** P. 120, 292

▶▶ Automatic Operation (automatic lighting control)

We recommend that you turn on the lights manually when driving at night, in a dense fog, or in dark areas such as long tunnels or parking facilities.

The light sensor is in the location shown below. Do not cover this light sensor with anything; otherwise, the automatic lighting system may not work properly.

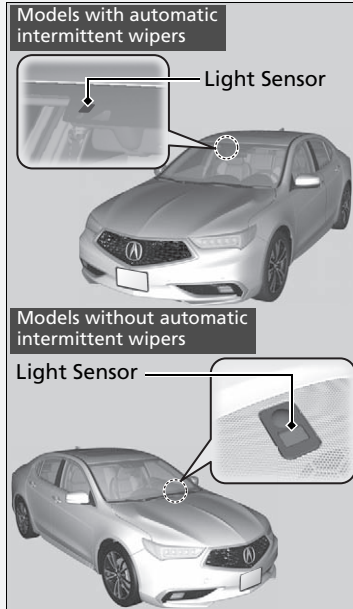

■ Headlight Integration with Wipers

The headlights automatically come on when the wipers are used several times within a certain number of intervals with the headlight switch in **AUTO**.

The headlights automatically go off a few minutes later if the wipers are stopped.

■ Automatic Lighting Off Feature

The headlights, all other exterior lights, and the instrument panel lights turn off 15 seconds after you set the power mode to VEHICLE OFF (LOCK), take the remote with you, and close the driver's door.

If you set the power mode to VEHICLE OFF (LOCK) with the headlight switch on, but do not open the door, the lights turn off after 10 minutes (3 minutes, if the switch is in the **AUTO** position).

The lights turn on again when you unlock or open the driver's door. If you unlock the door, but do not open it within 15 seconds, the lights go off. If you open the driver's door, you will hear a lights on reminder chime.

⌘ Automatic Operation (automatic lighting control)

Adjust the auto light sensitivity as follows:

| Setting | The exterior lights come on when the ambient light is at |
|---------|--|
| Max |  Bright |
| High | |
| Mid | |
| Low | |
| Min | |

➤ **Customized Features** P. 120, 292

⌘ Headlight Integration with Wipers

This feature activates while the headlights are off in **AUTO**.

The instrument panel brightness does not change when the headlights come on.

At dark ambient light levels, the automatic lighting control feature turns on the headlights, regardless of the number of wiper sweeps.

⌘ Automatic Lighting Off Feature

You can change the headlight auto off timer setting.

➤ **Customized Features** P. 120, 292

Fog Lights*

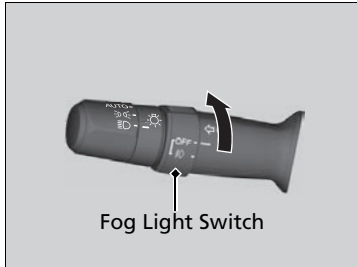

When the low beam headlights are on, turn the fog light switch on to use the fog lights.

Daytime Running Lights

The daytime running lights come on when the following conditions have been met:

- The power mode is in ON.
- The headlight switch is **AUTO** or .
- The parking brake is released.

The lights remain on even if you set the parking brake.

Setting the power mode to VEHICLE OFF (LOCK) will turn off the daytime running lights.

The daytime running lights are off once the headlight switch is turned on, or when the headlight switch is in **AUTO** and it is getting darker outside.

Auto High-Beam

Using a camera mounted to the inside of the windshield, this system detects light sources ahead of the vehicle. Depending on the light source, the system automatically switches the headlights to high beam for optimal visibility at night.

The system operates when:

- The headlight switch is in **AUTO**.
- The lever is in the low beam position.
- The low beams are on and the system recognizes that you are driving at night.
- The vehicle speed is above 45 mph (72 km/h).

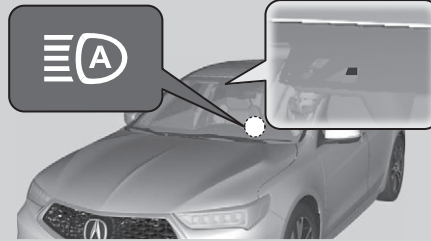

How it works

When the camera detects lights coming from a preceding or oncoming vehicle, the headlights remain in low beam.

When the camera detects no lights coming from a preceding or oncoming vehicle, the headlights change to high beam.

The view angle or distance that the camera can detect lights ahead differs depending on conditions, such as the brightness of the lights and the weather.

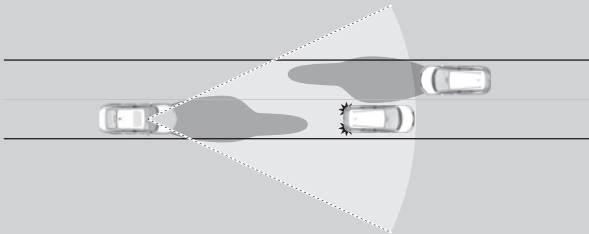

Auto High-Beam

The auto high-beam determines when to change the headlight beams by responding to the brightness of the lights ahead of your vehicle. In the following cases, the system may not respond to the lights properly:

- The brightness of the lights from the preceding or oncoming vehicle is intense or poor.
- Visibility is poor due to the weather (rain, snow, fog, windshield frost, etc.).
- Other light sources, such as street lights and electric billboards are illuminating the road ahead.
- The brightness level of the road ahead constantly changes.
- The road is bumpy or has many curves.
- A vehicle cuts in front of you, or a vehicle in front of you is not in the preceding or oncoming direction.
- Your vehicle is tilted with a heavy load in the rear.

If you find the timing of beam changes inconvenient for driving, change the headlight beams manually.

If you do not want the system to be activated at any time when the headlight switch is in **AUTO**, consult a dealer or disable the system.

▶ **Disabling or Re-enabling the System** P. 167

■ Operating the System

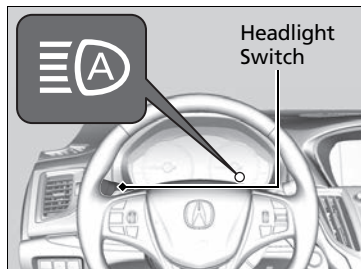

To activate the system, turn the headlight switch to **AUTO** and then set the headlights to low beam. The auto high-beam indicator will come on.

➤ **Light Switches** P. 161

The high beams remain on unless:

- You have been driving below 45 mph (72 km/h) for an extended amount of time.
- The speed of the vehicle drops below 30 mph (48 km/h).
- The windshield wipers have been running at a high speed for more than a few seconds.
- You enter a well lit location.

The high beams come back on once the condition that caused them to turn off no longer exists.

If needed, you can temporarily turn the high beams off manually. Turn on the high beams by pushing the lever forward until you hear a click, or flash the high beams once by pulling the lever towards you. To turn the high beams back on, repeat one of the procedures.

⌘ Operating the System

For the auto high-beam to work properly:

- Do not place an object that reflects light on the dashboard.
- Keep the windshield around the camera clean. When cleaning the windshield, be careful not to apply windshield cleanser to the camera lens.
- Do not attach an object, sticker or film to the area around the camera.
- Do not touch the camera lens.

If the camera receives a strong impact, or repairing of the area near the camera is required, consult a dealer.

If the **Some Driver Assist Systems Cannot Operate: Camera Temperature Too High** message appears:

- Use the climate control system to cool down the interior and, if necessary, also use defroster mode with the airflow directed towards the camera.
- Start driving the vehicle to lower the windshield temperature, which cools down the area around the camera.

If the **Some Driver Assist Systems Cannot Operate: Clean Front Windshield** message appears:

- Park your vehicle in a safe place, and clean the windshield. If the message does not disappear after you have cleaned the windshield and driven for a while, have your vehicle checked by a dealer.

Disabling or Re-enabling the System

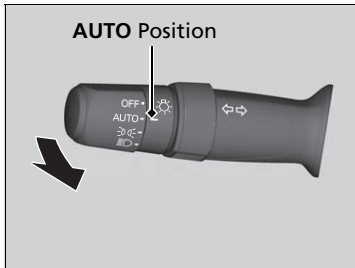

Disable or re-enable the system when the vehicle is parked and the power mode is in ON and the light switch is in the **AUTO** position.

Disabling the system: Pull the light switch lever towards you and hold it for at least 40 seconds. The auto high-beam indicator in the meter will blink twice.

Re-enabling the system: Pull the light switch lever towards you and hold it for at least 30 seconds. The auto high-beam indicator in the meter will blink once.

Enabling high sensitivity: Pull the light switch lever towards you and hold it for 2 minutes. The auto high-beam indicator in the meter will blink three times.

When the power mode is set to VEHICLE OFF (LOCK), sensitivity is returned to normal.

Disabling or Re-enabling the System

The auto high-beam is in the previously selected disabled or re-enabled setting each time you start the engine.

Wipers and Washers

■ Windshield Wipers/Washers



The windshield wipers and washers can be used when the power mode is in ON.

■ MIST

The wipers run at high speed until you release the lever.

■ Wiper switch (OFF, INT*¹/AUTO*², LO, HI)

Move the lever up or down to change the wiper settings.

■ Adjusting wiper operation*

Turn the adjustment ring to adjust the wiper operation.



Lower speed, fewer sweeps

Higher speed, more sweeps

■ Washer

Sprays while you pull the lever toward you. When you release the lever for more than one second, the spray stops, the wipers sweep two or three more times to clear the windshield, then stop.

▶▶ Wipers and Washers

NOTICE

Do not use the wipers when the windshield is dry. The windshield will get scratched, or the rubber blades will get damaged.

Turn the washers off if no washer fluid comes out. The pump may get damaged.

The wiper motor may stop motor operation temporarily to prevent an overload. Wiper operation will return to normal within a few minutes, once the circuit has returned to normal.

Models with intermittent time adjustment ring

If the vehicle speeds up while the wipers are operating intermittently, the length of the wipe interval shortens.

When the vehicle speeds up, the wiper operation's shortest delay setting  and the LO setting become the same.

NOTICE

In cold weather, the blades may freeze to the windshield.

Operating the wipers in this condition may damage the wipers. Use the defroster or heated windshield* to warm the windshield, then turn the wipers on.

*1: Models with manual intermittent operation

*2: Models with automatic intermittent operation

* Not available on all models

Automatic Intermittent Wipers*

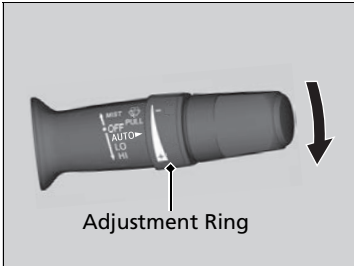

When you push the lever down to **AUTO**, the windshield wipers sweep once, and go into the automatic mode.

The wipers operate intermittently, at low speed, or at high speed and stops in accordance with the amount of rainfall the rainfall sensor detects.

AUTO sensitivity adjustment

When the wiper function is set to **AUTO**, you can adjust the sensitivity of the rainfall sensor (using the adjustment ring) so that wipers will operate in accordance with your preference.

Sensor sensitivity

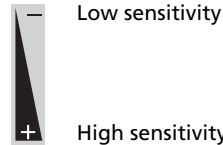

Wipers and Washers

If the wipers stop operating due to an obstacle such as the build-up of snow, park the vehicle in a safe place.

Rotate the wiper switch to **OFF**, and set the power mode to **ACCESSORY** or **VEHICLE OFF (LOCK)**, then remove the obstacle.

Automatic Intermittent Wipers*

The rainfall sensor is in the location shown below.

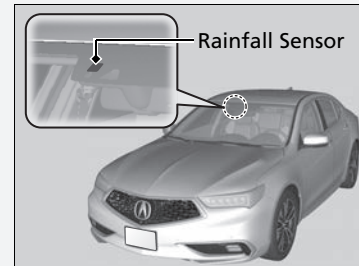

NOTICE

AUTO should always be turned **OFF** before the following situation in order to prevent severe damage to the wiper system:

- Cleaning the windshield
- Driving through a car wash
- No rain present

* Not available on all models

Canadian models

Headlight Washers*



Turn the headlights on and press the headlight washer button to operate. The headlight washers also operate when you turn the windshield washers for the first time after the power mode is set to ON.

Headlight Washers*

The headlight washers use the same fluid reservoir as the windshield washers.

Brightness Control

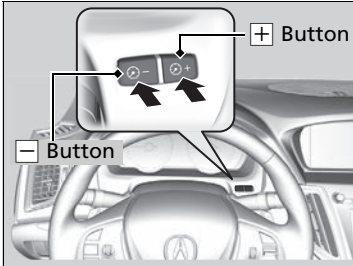

When the power mode is in ON, you can use the **+** or **-** button to adjust instrument panel brightness.

Brighten: Press the **+** button.

Dim: Press the **-** button.

You will hear a beep when the brightness reaches minimum or maximum. Several seconds after adjusting the brightness, you will be returned to the previous display.

■ Brightness level indicator

The brightness level is shown on the display while you are adjusting it.

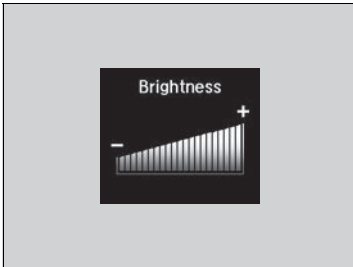

☒ Brightness Control

Instrument panel brightness varies, depending on whether the exterior lights are on or off. The instrument panel dims to reduce glare when they are on.

When it is bright outside and the headlight integration with the wiper is activated, the instrument panel brightness does not change.

To cancel the reduced instrument panel brightness when the exterior lights are on, press the **+** button until the brightness display is up to max, the beeper sounds.

The brightness can be set differently for when the exterior lights are on, and when they are off.

☒ Models with ambient light off switch

When the ambient light is ON, you can adjust the brightness level of the ambient light by pressing the **+** or **-** button.

☒ **Ambient Light Off Switch** * P. 190

* Not available on all models

Rear Defogger/Heated Door Mirror Button

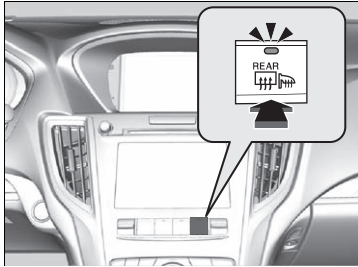

Press the rear defogger and heated door mirror button to defog the rear window and mirrors when the power mode is in ON.

The rear defogger and heated door mirrors automatically switch off after 10-30 minutes depending on the outside temperature.

⊗ Rear Defogger/Heated Door Mirror Button

NOTICE

When cleaning the inside of the rear window, be careful not to damage the heating wires. It is critical to wipe the window from side to side along the defogger heating wires.

This system consumes a lot of power, so turn it off when the window has been defogged. Also, do not use the system for a long time while the engine is idling. This may weaken the battery, making it difficult to start the engine.

When the outside temperature is below 41°F (5°C), the heated door mirror may activate automatically for 10 minutes when you set the power mode to ON.

Heated Windshield Button *

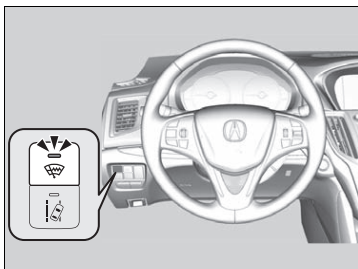

Press the heated windshield button to deice the windshield when the power mode is in ON.

⊗ Heated Windshield Button *

This system consumes a lot of power, so turn it off when the window has been deiced. Also, do not use the system for a long period when the engine is idling. This may weaken the battery, making it difficult to start the engine.

When the outside temperature is below 39°F (4°C), the heated windshield may automatically activate. The system deactivates itself once the outside temperature reaches 43°F (6°C).

Driving Position Memory System

You can store two driver's seat (except for power lumbar and thigh support*) and door mirror positions with the driving position memory system.

When you unlock and open the driver's door with a remote transmitter, or keyless access system, the seat and door mirrors adjust automatically to one of the two preset positions.

When you enter the vehicle, the multi-information display briefly shows you which remote transmitter you used to unlock the vehicle.

- **DRIVER 1** transmitter is linked to memory button 1.
- **DRIVER 2** transmitter is linked to memory button 2.

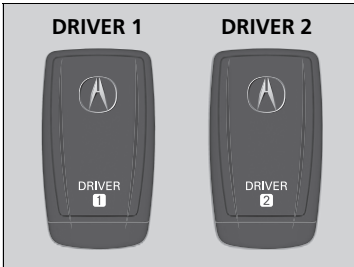

The driver's seat moves rearward depending on the set seating position once you

- Stop the vehicle.
- Put the transmission in **P**.
- Turn the engine off.
- Then open the driver's door.

Once the power mode is in the ACCESSORY position, the driver's seat moves forward to the **DRIVER 1** or **2** preset position.

Driving Position Memory System

Using the information screen or multi-information display, you can disable the automatic seat and door mirror adjustment function.

➤ **Customized Features** P. 120, 292

The driver's seat easy exit feature can be turned ON/OFF.

➤ **Customized Features** P. 120, 292

System Operation

The system will not operate if:

- The vehicle speed is above 3 mph (5 km/h).
- Either memory position button is pressed while the seat is in motion.
- The seat position is adjusted while in operation.
- The memory 1 or 2 position is set fully to the rear.

* Not available on all models

■ Storing a Position in Memory

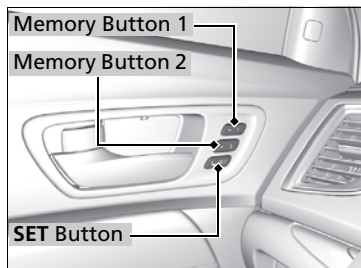

1. Set the power mode to ON. Adjust the driver's seat and door mirrors to the desired position.
2. Press the **SET** button.
 - ▶ You will hear the beeper, and the memory button indicator light will blink.
3. Press and hold memory button **[1]** or **[2]** within five seconds of pressing the **SET** button.
 - ▶ Once the seat and the door mirror positions have been memorized, the indicator light on the button you pressed stays on.

■ Recalling the Stored Position

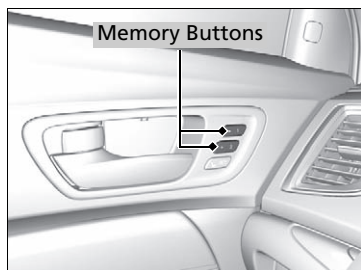

1. Put the transmission into **[P]**.
2. Apply the parking brake.
3. Press a memory button (**[1]** or **[2]**).
 - ▶ You will hear the beeper, and the indicator light will blink.

The seat and the door mirrors will automatically move to the memorized positions. When it has finished moving, you will hear the beeper, and the indicator light stays on.

▶▶ Storing a Position in Memory

After you press the **SET** button, the storing operation will be canceled when:

- You do not press the memory button within five seconds.
- You readjust the seat or the door mirror position before the double-beep.
- You set the power mode to any position except ON.

▶▶ Recalling the Stored Position

The seat and the door mirrors will stop moving if you:

- Press the **SET** button or memory button **[1]** or **[2]**.
- Adjust the seat position or door mirrors.
- Put the transmission into a position other than **[P]**.

Adjusting the Steering Wheel

The steering wheel height and distance from your body can be adjusted so that you can comfortably grip the steering wheel in an appropriate driving posture.

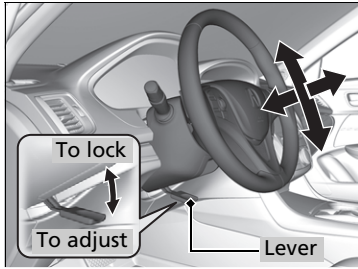

1. Push the steering wheel adjustment lever down.
 - ▶ The steering wheel adjustment lever is under the steering column.
2. Move the steering wheel up or down, and in or out.
 - ▶ Make sure you can see the instrument panel gauges and indicators.
3. Pull the steering wheel adjustment lever up to lock the steering wheel in position.
 - ▶ After adjusting the position, make sure you have securely locked the steering wheel in place by trying to move it up, down, in, and out.

Adjusting the Steering Wheel

⚠ WARNING

Adjusting the steering wheel position while driving may cause you to lose control of the vehicle and be seriously injured in a crash.

Adjust the steering wheel only when the vehicle is stopped.

Interior Rearview Mirror

Adjust the angle of the rearview mirror when you are sitting in the correct driving position.

Automatic Dimming Rearview Mirror and Power Door Mirrors*

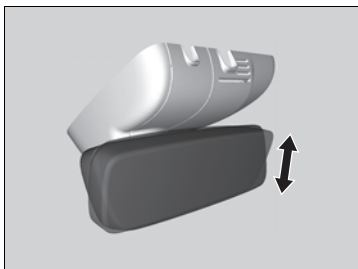

When you are driving after dark, the automatic dimming rearview mirror and power door mirrors* reduce the glare from headlights behind you, based on inputs from the mirror sensor. This feature is always active.

Adjusting the Mirrors

Keep the inside and outside mirrors clean and adjusted for best visibility.

Adjust the mirrors before you start driving.

➤ **Front Seats** P. 179

Automatic Dimming Rearview Mirror and Power Door Mirrors*

The auto dimming function cancels when the transmission is in **R**.

Power Door Mirrors

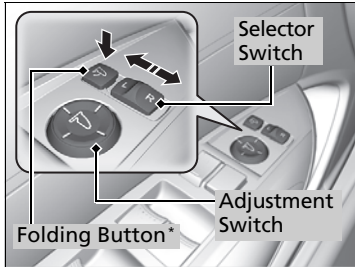

You can adjust the door mirrors when the power mode is in ON.

■ Mirror position adjustment

L/R selector switch: Select the left or right mirror. After adjusting the mirror, return the switch to the center position.

Mirror position adjustment switch: Press the switch left, right, up, or down to move the mirror.

■ Folding door mirrors*

Press the folding button to fold in and out the door mirrors.

■ Reverse Tilt Door Mirror



If activated, either side door mirror automatically tilts downward when you put the transmission into **[R]**; this improves close-in visibility on the selected side of the vehicle when backing up. The mirror automatically returns to its original position when you take the transmission out of **[R]**.

To activate this feature, set the power mode to ON and slide the selector switch to the left or right side.

* Not available on all models

■ Automatic Folding Door Mirror Function *

■ Folding in the door mirrors

Press the lock button on the remote transmitter, or press the door lock button on any door.

- ▶ The mirrors start folding in automatically.

■ Folding out the door mirrors

Unlock the driver's door using the remote transmitter or keyless access system.

- ▶ The mirrors start folding out automatically.

⌘ Automatic Folding Door Mirror Function *

You can turn the automatic folding door mirror function on and off.

- ⌘ **Customized Features** P. 120, 292

You cannot turn the automatic folding out automatically if they have been folded in using the folding button.

Door mirrors will not fold automatically when locking from inside the vehicle using lock tab or master door lock switch.

Adjusting the Seats

Front Seats

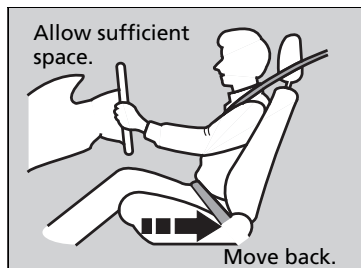

Adjust the driver's seat as far back as possible while allowing you to maintain full control of the vehicle. You should be able to sit upright, well back in the seat and be able to adequately press the pedals without leaning forward, and grip the steering wheel comfortably. The passenger's seat should be adjusted in a similar manner, so that it is as far back from the front airbag in the dashboard as possible.

Adjusting the Seats

⚠ WARNING

Sitting too close to a front airbag can result in serious injury or death if the front airbags inflate.

Always sit as far back from the front airbags as possible while maintaining control of the vehicle.

The National Highway Traffic Safety Administration and Transport Canada recommend that drivers allow at least 10 inches (25 cm) between the center of the steering wheel and the chest.

Always make seat adjustments before driving.

Adjusting the Seat Positions

Adjusting the front power seats

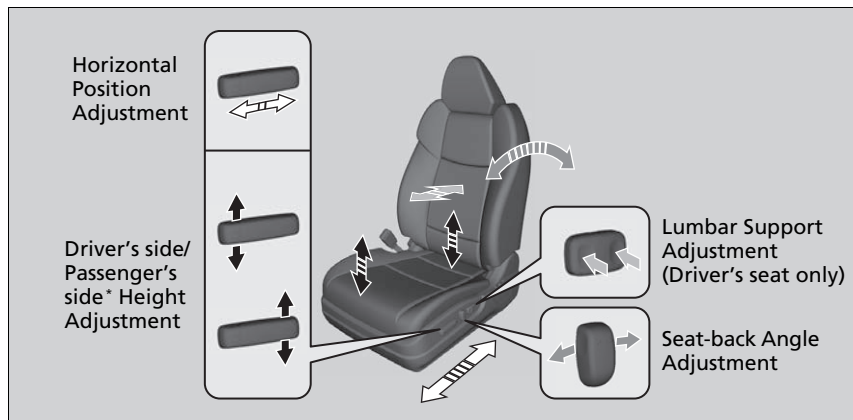

* Not available on all models

Continued

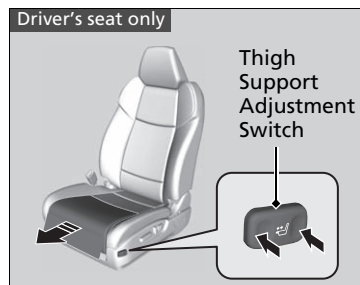

■ **Thigh support adjustment switch***

Press the front side: The tucked-down seat cushion end rolls out to support your thighs.

Press the rear side: The seat cushion returns to its original position.

■ Adjusting the Seat-Backs

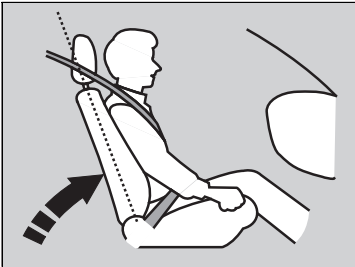

Adjust the driver's seat-back to a comfortable, upright position, leaving ample space between your chest and the airbag cover in the center of the steering wheel.

The front seat passenger should also adjust their seat-back to a comfortable, upright position.

Reclining a seat-back so that the shoulder part of the belt no longer rests against the occupant's chest reduces the protective capability of the belt. It also increases the chance of sliding under the belt in a crash and being seriously injured. The farther a seat-back is reclined, the greater the risk of injury.

⌘ Adjusting the Seat-Backs

⚠ WARNING

Reclining the seat-back too far can result in serious injury or death in a crash.

Adjust the seat-back to an upright position, and sit well back in the seat.

Do not put a cushion, or other object, between the seat-back and your back. Doing so may interfere with proper seat belt or airbag operation.

If you cannot get far enough away from the steering wheel and still reach the controls, we recommend that you investigate whether some type of adaptive equipment may help.

Head Restraints

Your vehicle is equipped with head restraints in all seating positions.

■ Adjusting the Front and Rear Outer Head Restraint Positions

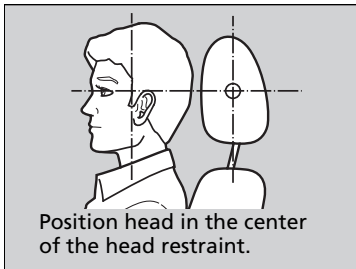

Head restraints are most effective for protection against whiplash and other rear-impact crash injuries when the center of the back of the occupant's head rests against the center of the restraint. The tops of the occupant's ears should be level with the center height of the restraint.

⌘ Head Restraints

⚠ WARNING

Improperly positioning head restraints reduces their effectiveness and increases the likelihood of serious injury in a crash.

Make sure head restraints are in place and positioned properly before driving.

In order for the head restraint system to work properly:

- Do not hang any items on the head restraints, or from the restraint legs.
- Do not place any objects between an occupant and the seat-back.
- Install each restraint in its proper location.

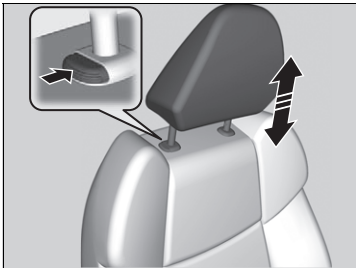

To raise the head restraint: Pull it upward.
To lower the head restraint: Push it down while pressing the release button.

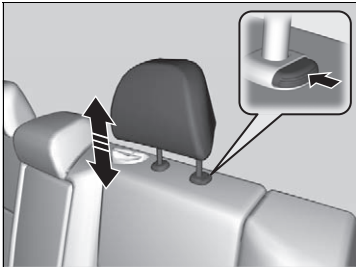

■ Changing the Rear Center Seat Head Restraint Positions

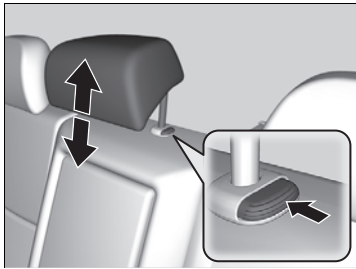

A passenger sitting in the center back seating position should adjust the height of their head restraint to an appropriate position before the vehicle begins moving.

To raise the head restraint:

Pull it upward.

To lower the head restraint:

Push it down while pressing the release button.

■ Removing and Reinstalling the Head Restraints

Head restraints can be removed for cleaning or repair.

To remove a head restraint:

Pull the restraint up as far as it will go. Then push the release button, and pull the restraint up and out.

To reinstall a head restraint:

Insert the legs back in place, then adjust the head restraint to an appropriate height while pressing the release button. Pull up on the restraint to make sure it is locked in position.

► Removing and Reinstalling the Head Restraints

⚠ WARNING

Failure to reinstall, or correctly reinstall, the head restraints can result in severe injury during a crash.

Always replace the head restraints before driving.

Maintain a Proper Sitting Position

After all occupants have adjusted their seats and head restraints, and put on their seat belts, it is very important that they continue to sit upright, well back in their seats, with their feet on the floor, until the vehicle is safely parked and the engine is off.

Sitting improperly can increase the chance of injury during a crash. For example, if an occupant slouches, lies down, turns sideways, sits forward, leans forward or sideways, or puts one or both feet up, the chance of injury during a crash is greatly increased.

In addition, an occupant who is out of position in the front seat can be seriously or fatally injured in a crash by striking interior parts of the vehicle or being struck by an inflating front airbag.

ⓘ Maintain a Proper Sitting Position

WARNING

Sitting improperly or out of position can result in serious injury or death in a crash.

Always sit upright, well back in the seat, with your feet on the floor.

Rear Seats

■ 60/40 Split Folding Down the Rear Seats

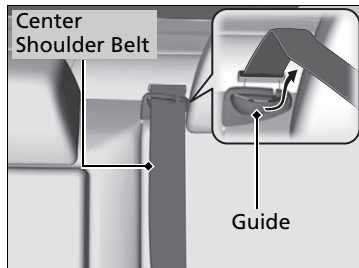

1. Remove the center shoulder belt from the guide.

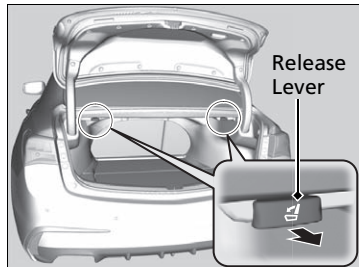

2. Pull the release lever in the trunk to release the lock.

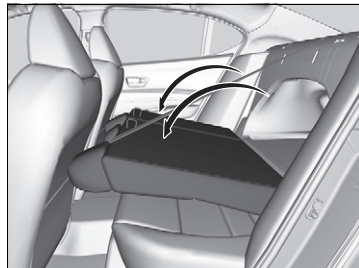

3. Fold the seat-back down.

If the rear head restraints get caught on the front seat-backs, remove the head restraints.

➤ **Removing and Reinstalling the Head Restraints** P. 184

⌘ 60/40 Split Folding Down the Rear Seats

The rear seat-backs can be folded down to accommodate bulkier items in the trunk.

Never drive with a seat-back folded down and the trunk lid open.

➤ **Exhaust Gas Hazard** P. 69

To lock the seat-back upright, push it backwards until it locks.

When returning a seat-back to its original position, push it firmly back. Also, make sure all rear shoulder belts are positioned in front of the seat-back, and the center shoulder belt is re-positioned in the guide.

Make sure that the folded seat-back does not press against the front passenger seat, as this can cause the weight sensors in the front passenger seat to work improperly.

➤ **Passenger Front Airbag Off Indicator** P. 54

Also make sure all items in the trunk or items extending through the opening into the rear seats are properly secured. Loose items can fly forward if you have to brake hard.

The front seat(s) must be far enough forward so they do not interfere with the rear seats as they fold down.

Armrest

■ Using the Rear Seat Armrest

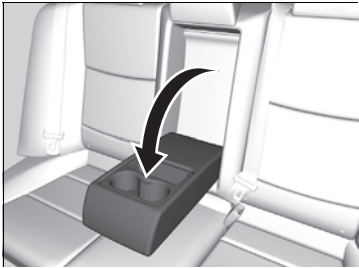

Pull down the armrest in the center backrest.

Interior Lights

Interior Light Switches

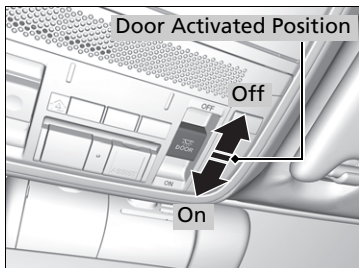

■ ON

The interior lights come on regardless of whether the doors are open or closed.

■ Door activated

The interior lights come on in the following situations:

- When any of the doors are opened.
- You unlock the driver's door.
- When the power mode is set to VEHICLE OFF (LOCK).

■ OFF

The interior lights remain off regardless of whether the doors are open or closed.

Interior Light Switches

In the door activated position, the interior lights fade out and go off about 30 seconds after the doors are closed.

The lights go off after 30 seconds in the following situations:

- When you unlock the driver's door but do not open it.
- When you set the power mode to VEHICLE OFF (LOCK) but do not open a door.

You can change the interior lights dimming time.

➤ **Customized Features** P. 120, 292

The interior lights go off immediately in the following situations:

- When you lock the driver's door.
- When you close the driver's door in ACCESSORY mode.
- When you set the power mode to ON.

If you leave any of the doors open in VEHICLE OFF (LOCK) mode, the interior lights go off after about 15 minutes.

Map Lights

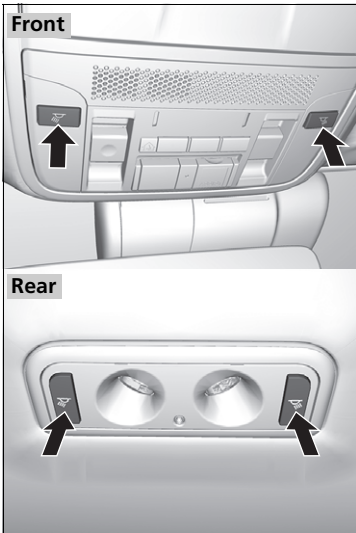

The map lights can be turned on and off by pressing the  (map light) button.

Map Lights

When the interior light switch is in the door activated position and any door is open, the map light will not go off when you press the  (map light) button.

■ Ambient Light Off Switch *

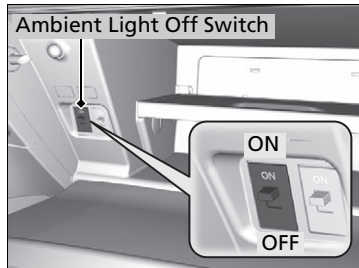

If the headlight switch is in **AUTO** and it is dark outside, the ambient lights come on when a door is opened. They also come on when the headlights or the parking lights are on.

If you want to turn off the ambient lights, set the ambient light off switch to OFF.

▣ Ambient Light Off Switch *

Any adjustments you make to the brightness of the ambient lights will affect the brightness of the meter lights.

▣ **Brightness Control** P. 171

Interior Convenience Items

■ Glove Box

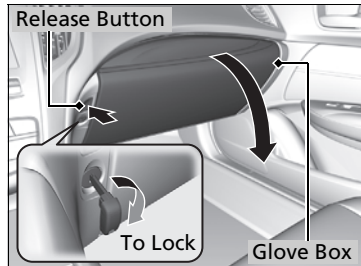

Press the button to open the glove box. You can lock the glove box with the built-in key.

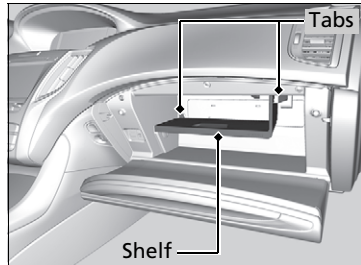

■ Removable shelf

The shelf in the glove box is detachable. To remove it, disengage the tabs.

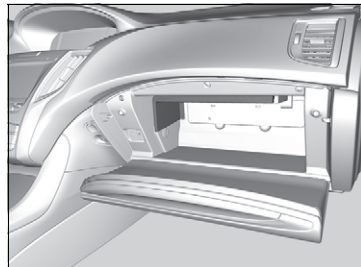

The removable shelf can be stored upside down in the glove box.

☒ Glove Box

⚠ WARNING

An open glove box can cause serious injury to your passenger in a crash, even if the passenger is wearing the seat belt.

Always keep the glove box closed while driving.

The glove box light comes on when the parking lights are on.

■ Console Compartment

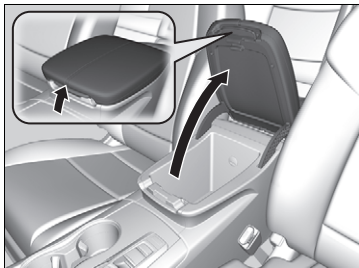

Pull the handle to open the console compartment.

☒ Console Compartment

The console compartment light comes on when the parking lights are on.

Center Pocket

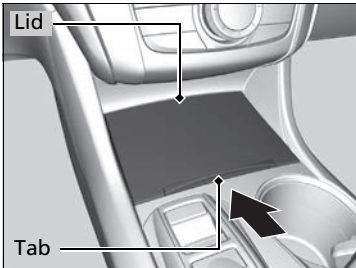

To access the center pocket, push the lid forward until the latch engages.
To close it, push forward on the tab until the latch releases, then allow the lid to slide to the fully closed position.

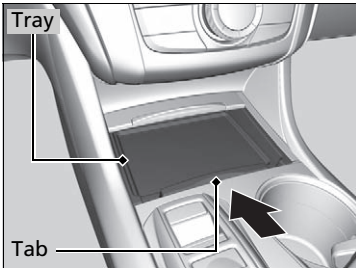

Models without wireless charger

To open the center pocket tray, push the tray forward until it latches.
To close it, push forward on the tab until the latch release, then pull the tray rearward to the fully closed position.

■ Beverage Holders

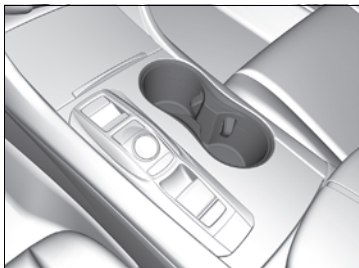

■ Front seat beverage holders

Are located in the console between the front seats.

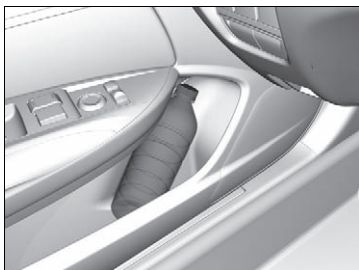

■ Front door side beverage holders

Are located on the both of the front door side pockets.

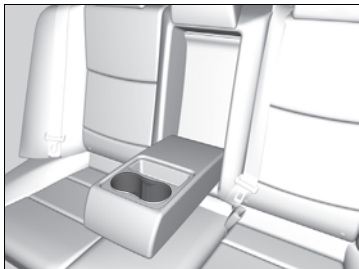

■ Rear seat beverage holders

Fold the armrest down to use the rear seat beverage holders.

☒ Beverage Holders

NOTICE

Spilled liquids can damage the upholstery, carpeting, and electrical components in the interior.

Be careful when you are using the beverage holders. Hot liquid can scald you.

■ Accessory Power Sockets

The accessory power sockets can be used when the power mode is in ACCESSORY or ON.

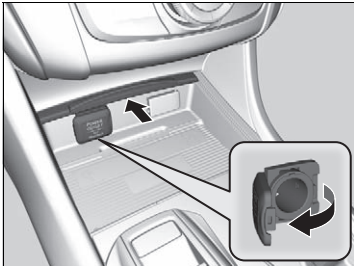

■ Accessory power socket (center pocket)

Open the lid and the tray* to access.

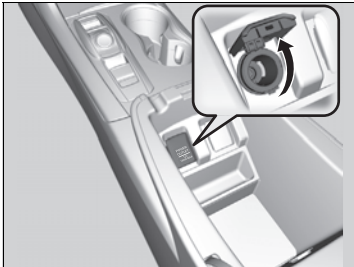

■ Accessory power socket (console compartment)

Open the console lid and the cover to access.

» Accessory Power Sockets

NOTICE

Do not insert an automotive type cigarette lighter element: The power socket can overheat.

The accessory power sockets are designed to supply power for 12-volt DC accessories that are rated 180 watts (15 amps) or less.

To prevent battery drain, use the power socket only when the engine is running.

* Not available on all models

■ Wireless Charger*

To use the wireless charger, the power mode must be in ACCESSORY or ON. Charge a compatible device on the area indicated by the  mark as follows:

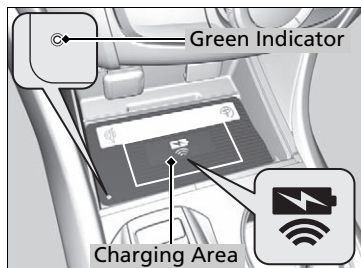

1. Open the center pocket.
 - ▶  **Center Pocket** P. 193
2. Place the device you want to charge on the charging area.
 - ▶ The system will automatically start charging the device, and the green indicator light will come on.
 - ▶ Make sure that the device is compatible with the system, and placed with the chargeable side in the center of the charging area.
3. When charging is completed, the green indicator light will go off.
 - ▶ If the device is not located on the charge area correctly, the green indicator light will blink.

ⓘ Wireless Charger*

CAUTION

Metal objects between the charge pad and the device to be charged will get hot and can burn you.

- Always remove foreign objects from the charge pad before charging the device.
- Be sure the surface is clear of dust and other debris before charging.
- Do not spill liquids (i. e. water, drinks, etc.) on the charger and the device.
- Do not use oil, grease, alcohol, benzine or thinner for cleaning the charge pad.
- Do not cover the system with towels, clothing, or other objects while charging etc.
- Avoid spraying aerosols which may come in contact with the change pad surface.

Using the information screen or multi-information display, you can disable the wireless charger function.

- ▶  **Customized Features** P. 120, 292

■ When charging does not start

Perform one of the solutions in the following table.

| Indicator | Cause | Solution |
|------------|---|--|
| Slow Blink | There is an obstacle(s) between the charging area and the device. | Remove the obstacle(s). |
| | The device is not within the charging area. | Move the device to the center of the charging area where  is located. |
| Fast Blink | The wireless charger is faulty. | Turn the vehicle off and back on. If the indicator still blinks, contact a dealer. |

⌘ Wireless Charger*

This system consumes a lot of power. Do not use the system for a long time when the engine is not running. This may weaken the battery, making it difficult to start the engine.

When using the wireless charger, check the user's manual that came with the compatible device you want to charge.

NOTICE

Do not place any magnetic recording media or precision machines within the charging area while charging. The data on your cards such as credit cards can be lost because of the magnetic effect. Also precision machines such as watches can go wrong.

"Qi" and  marks are the registered trademarks owned by Wireless Power Consortium (WPC).

 mark is the registered trademark owned by Power Matters Alliance (PMA).

* Not available on all models

Continued

🔌 Wireless Charger*

In the following cases, charging may stop or not start:

- The device is already fully charged.
- The temperature of the device is extremely high while charging.
- You are at a place that emits strong electromagnetic waves or noises, such as TV station, electric power plant, or gas station.

A device may not charge if the size or shape of its chargeable side is not appropriate for use with the charging area.

Not all devices are compatible with the system.

During the charging phase, it is normal for the charging area and device to heat up.

Charging may be briefly interrupted when:

- All the doors or the trunk are closed
 - to avoid interference with the proper functioning of the keyless access system.
- The position of the device is altered.
- The radio is scanning for AM stations.

Do not charge more than one device at a time on a charging area.

■ Coat Hooks



There are coat hooks on the rear grab handle of both sides. Pull it down to use it.



There are coat hooks on the door pillar of both sides.

☒ Coat Hooks

The coat hooks are not designed for large or heavy items.

■ Under-Floor Storage Area

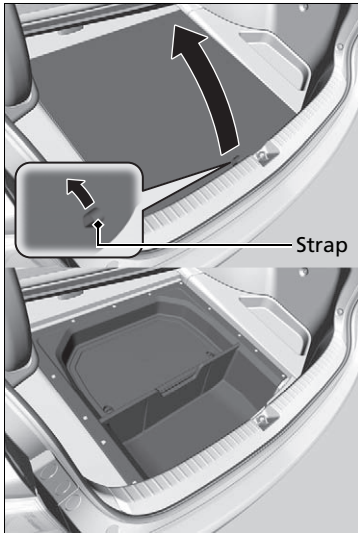

Pull the strap and open the lid.

The reverse side of the cargo floor lid is water resistant. Flip the lid to use the water resistant side.

▣ Under-Floor Storage Area

Do not leave water, soil, sand, or perishable foods in the storage area. Rotting food and dirt on the floor may cause the breakdown of electrical equipment.

■ Heated Steering Wheel*

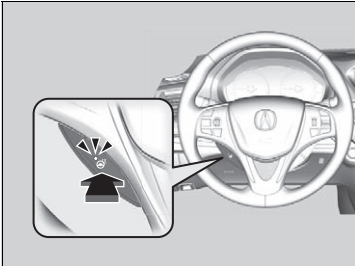

The power mode must be in ON to use the heated steering wheel.

Press the button on the left side of the steering wheel.

When a comfortable temperature is reached, press the button again to turn it off.

The heated steering wheel is turned off every time you start the engine, even if you turned it on the last time you drove the vehicle.

▣ Heated Steering Wheel*

Do not use the heated steering wheel continuously when the engine is off. Under such conditions, the battery may be weakened, making the engine difficult to start.

* Not available on all models

■ Front Seat Heaters and Seat Ventilation*



The power mode must be in ON to use the seat heaters and ventilators*.



1. Select .
2. Change the setting with one of the following:
 - The **Low** icon: The LO setting (one indicator on)
 - The **Mid** icon: The MID setting (two indicators on)
 - The **High** icon: The HI setting (three indicators on)
 - Auto**: The system automatically selects the setting most suitable to the ambient environment.
 - Off**: Turn off the system.

When the power mode is turned on after it is turned off, the previous setting of front seat heaters and ventilators is maintained.

▣ Front Seat Heaters and Seat Ventilation*

WARNING

Heat induced burns are possible when using seat heaters.

Persons with a diminished ability to sense temperature (e.g., persons with diabetes, lower-limb nerve damage, or paralysis) or with sensitive skin should not use seat heaters.

Do not use the seat heaters and the seat ventilation even in LO when the engine is off. Under such conditions, the battery may be weakened, making the engine difficult to start.

After a certain period of time, the strength setting for the front seat heaters will automatically be reduced by one level at a time until the front seat heaters shuts off. The elapsed time varies according to the interior environment.

Rear Seat Heaters*

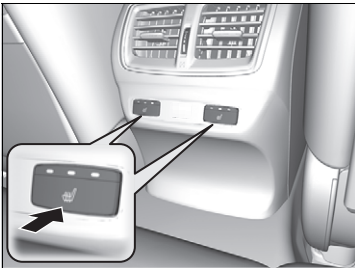

The power mode must be in ON to use the seat heaters.

There is no heater in the rear center seating position.

Press the seat heater button:

Once - The HI setting (three indicators on)

Twice - The MID setting (two indicators on)

Three times - The LO setting (one indicator on)

Four times - The OFF setting (no indicators on)

Sunglasses Holder

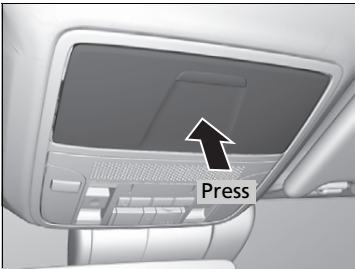

To open the sunglasses holder, press and release the indent. To close, press it again until it latches.

You can store eyeglasses and other small items in this holder.

ⓘ Rear Seat Heaters*

⚠ WARNING

Heat induced burns are possible when using seat heaters.

Persons with a diminished ability to sense temperature (e.g., persons with diabetes, lower-limb nerve damage, or paralysis) or with sensitive skin should not use seat heaters.

Do not use the seat heaters even in LO when the engine is off. Under such conditions, the battery may be weakened, making the engine difficult to start.

ⓘ Sunglasses Holder

Keep the holder closed while driving except when accessing stored items.

* Not available on all models

Using Automatic Climate Control

The automatic climate control system maintains the interior temperature you select. The system also selects the proper mix of heated or cooled air that raises or lowers the interior temperature to your preference as quickly as possible.

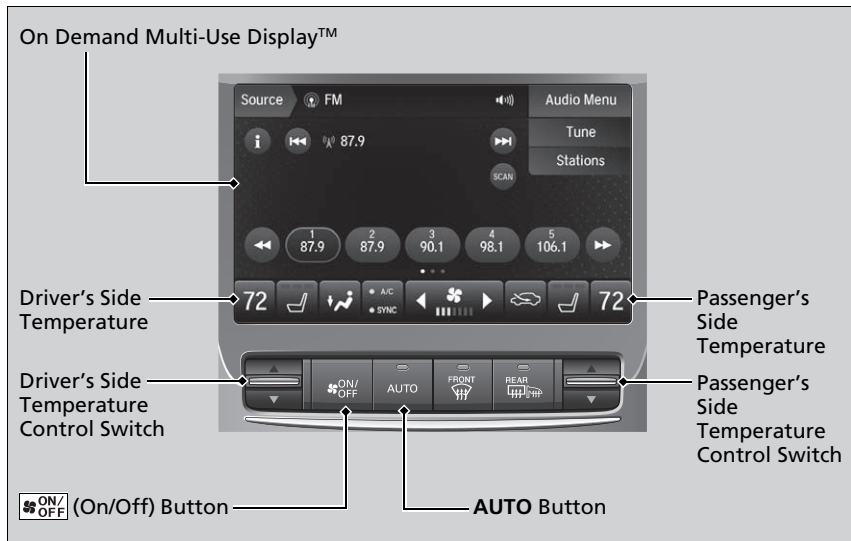

Use the system when the engine is running.

1. Press the **AUTO** button.
2. Adjust the interior temperature using the driver's side or passenger's side temperature control switch.
3. Press the **ON/OFF** (On/Off) button to cancel.

Using Automatic Climate Control

If any buttons/icons on the touch screen are pressed while using the climate control system in auto, the function of the button/icon that was pressed will take priority.

The AUTO indicator will go off, but functions unrelated to the button/icon that was pressed will be controlled automatically.

Models with Auto Idle Stop

During idle-stops, air-conditioning is suspended, and only the blower remains active.

If you do not want air-conditioning suspended, press **(A) OFF** to cancel idle-stop.

All models

To prevent cold air from blowing in from outside, the fan may operate at low speed for a while after the **AUTO** button has been pressed.

If the interior is very warm, you can cool it down more rapidly by partially opening the windows, turning the system on auto, and setting the temperature to low. Change the fresh air mode to recirculation mode until the temperature cools down.

When you set the temperature to the lower or upper limit, **Lo** or **Hi** is displayed.

■ Operating from the On Demand Multi-Use Display™

In addition to the button/switch controls, you can operate the climate control system from the On Demand Multi-Use Display™ touch screen.

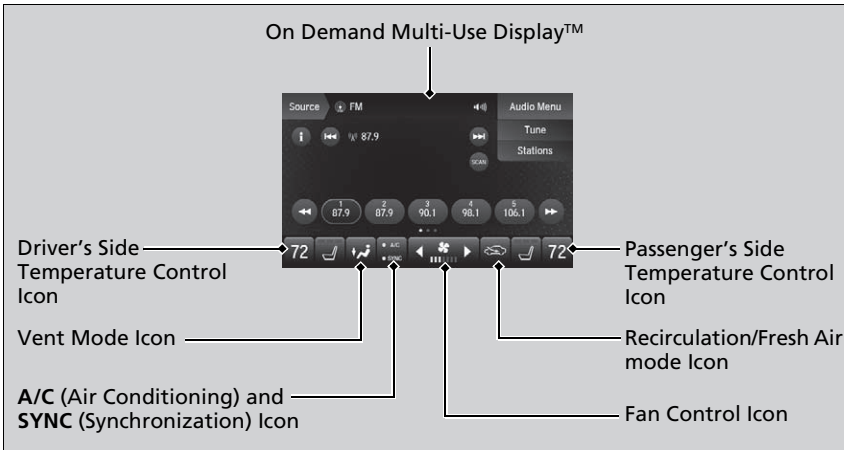

▣ Using Automatic Climate Control

Pressing the **ON/OFF** button switches the climate control system between on and off. When turned on, the system returns to your last selection.

When you unlock the doors with your remote, the driver's ID (**Driver 1** or **Driver 2**) is detected, and the climate control settings are turned to the respective mode automatically when you set the power mode to ON.

While Econ mode is active, the climate control system may have reduced cooling performance.

■ Changing the Interior Temperature Setting

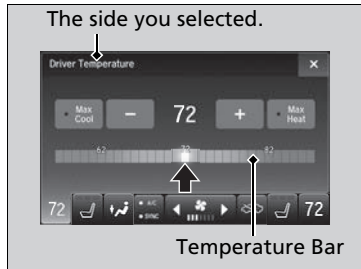

1. Select the driver's or passenger's side temperature control icon.
2. Change the temperature setting from the following:

Temperature bar: Select a point where your desired temperature setting is. Farther to the left is for a lower, and to the right for a higher setting.

+/-: To raise or lower the temperature setting one degree at a time. While you select and hold **+/-**, the temperature decreases or increases.

Max Cool: To rapidly cool down the interior.
► The AUTO indicator goes off. The setting returns to the previously selected value when you select it again.

Max Heat: To rapidly warm up the interior.
► The AUTO indicator goes off. The setting returns to the previously selected value when you select it again.

►► Using Automatic Climate Control

Models with Auto Idle Stop

If you select the **Max Cool** or **Max Heat** during Auto Idle Stop, the engine restarts automatically.

■ Switching the vent mode

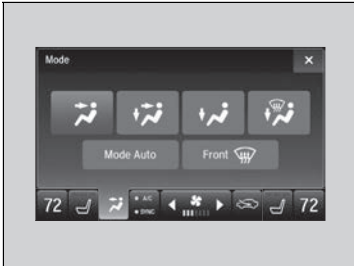

Select a desired vent mode icon, or **Mode Auto**: The system automatically selects the vent mode most suitable to the ambient environment.

Vent mode



: Dashboard vents and back of the center console



: Dashboard and floor vents, and back of the center console



: Floor vents



: Floor and defroster vents

■ A/C on and off

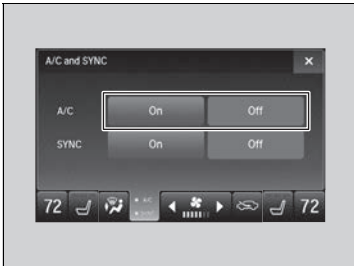

1. Select **A/C**.
2. Select **On** or **Off**.

Switching the vent mode

While the climate control system is in auto, **Mode Auto** is highlighted.

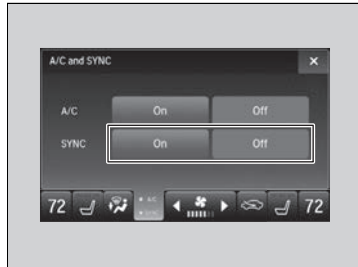

■ SYNC on and off

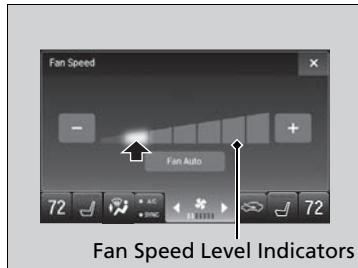

1. Select **SYNC**.
2. Select **On** for synchronization mode, and **Off** for dual mode.
 - When in synchronization mode, the passenger's side temperature becomes the same as the driver's side settings.
3. Adjust the temperature from the driver's side.

■ Changing the fan speed



1. Select .
 - When the left or right side of the  is selected, the fan speed level goes up or down one level at a time.
2. Change the fan speed with one of the following:

The fan speed level indicators: Select your desired speed level. The smaller indicator is for a slower speed, and the larger for a faster speed.

: To go up or down one level at a time.

Fan Auto: The system automatically selects the fan speed most suitable to the ambient environment.

» SYNC on and off

When the system is not in SYNC mode, the driver's side temperature and the front passenger's side temperature can be set separately.



You can also turn off SYNC mode by changing the front passenger's side temperature.





» Changing the fan speed

While the climate control system is in auto, **Fan Auto** is highlighted.

Switching between the Recirculation and Fresh Air Modes



Select  or  currently shown to switch between the modes depending on environmental conditions.

- Selecting  or  currently shown changes the display to the **Fresh Air/Recirculation** display. You can also switch the mode by selecting  or  icon appearing in the display.

 (Recirculation Mode): Recirculates air from the vehicle's interior through the system.

 (Fresh Air Mode): Maintains outside ventilation. Keep the system in fresh air mode in normal situations.

Switching between the Recirculation and Fresh Air Modes

While the climate control system is in auto, the recirculation mode and fresh air mode are automatically switched depending on environmental conditions.

■ Defrosting the Windshield and Windows



Pressing the **FRONT** button or selecting the **Front** icon appearing after the vent mode icon is selected turns the air conditioning system on and automatically switches the system to fresh air mode.

Press the **FRONT** button or select the **Front** icon again to turn off, the system returns to the previous settings.

■ To rapidly defrost the windows



1. Press the **FRONT** button, or select the vent mode icon and then the **Front** icon.
2. Select the recirculation mode.
 - **Switching between the Recirculation and Fresh Air Modes** P. 209

►► Defrosting the Windshield and Windows

For your safety, make sure you have a clear view through all the windows before driving.

Do not set the temperature near the upper or lower limit.

When cold air hits the windshield, the outside of the windshield may fog up.

If the side windows fog up, adjust the vents so that the air hits the side windows.

Models with Auto Idle Stop

If you press the **FRONT** button or select the **Front** icon during Auto Idle Stop, the engine restarts automatically.

►► To rapidly defrost the windows

After defrosting the windows, switch over to fresh air mode.

If you keep the system in recirculation mode, the windows may fog up from humidity. This impedes visibility.

Automatic Climate Control Sensors

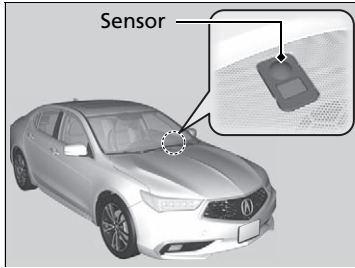

The automatic climate control system is equipped with sensors. Do not cover or spill any liquid on them.

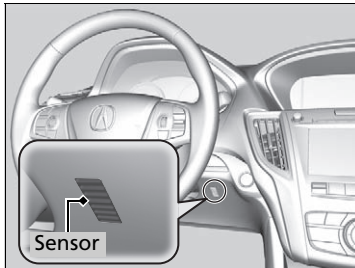

Features

This chapter describes how to operate technology features.

Audio System

| | |
|---|-----|
| About Your Audio System | 214 |
| USB Port | 215 |
| Auxiliary Input Jack | 216 |
| Audio System Theft Protection | 216 |
| Audio Remote Controls | 217 |
| Audio System Basic Operation | 219 |
| On Demand Multi-Use Display™ | 220 |
| Information Screen | 223 |
| Adjusting the Sound | 228 |
| Display Setup | 229 |
| Playing AM/FM Radio | 230 |

| | |
|--|-----|
| Playing SiriusXM® Radio | 233 |
| Playing a CD | 244 |
| Playing an iPod | 247 |
| Playing Pandora® | 250 |
| Playing a USB Flash Drive | 252 |
| Playing <i>Bluetooth</i> ® Audio | 255 |
| Siri Eyes Free | 257 |
| Apple CarPlay | 258 |
| Android Auto | 262 |
| Audio Error Messages | 267 |

General Information on the Audio

| | |
|---|-----|
| System | 274 |
| Customized Features | 292 |
| HomeLink® Universal Transceiver ... | 314 |
| <i>Bluetooth</i>® HandsFreeLink® | 317 |
| Compass* | 352 |

* Not available on all models

About Your Audio System

The audio system features AM/FM radio and the SiriusXM® Radio service. It can also play audio CDs, WMA/MP3/AAC files, USB flash drives, and iPod, iPhone and *Bluetooth*® devices.

You can operate the audio system from the remote controls on the steering wheel, or the icons on the On Demand Multi-Use Display™.

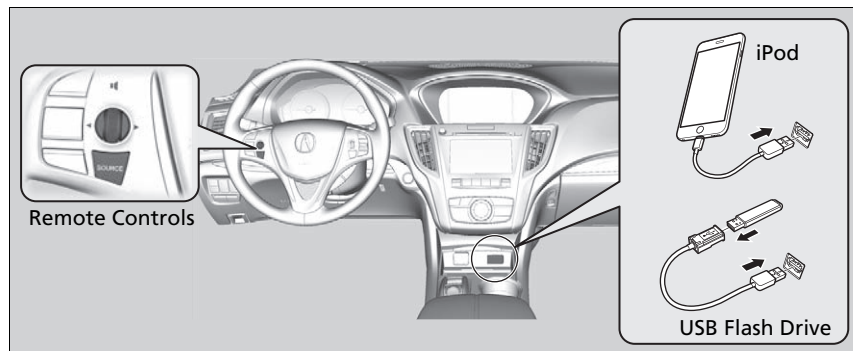

⌘ About Your Audio System

SiriusXM® Radio is available on a subscription basis only. For more information on SiriusXM® Radio, contact a dealer.

⌘ General Information on the Audio System P. 274

SiriusXM® Radio is available in the United States and Canada, except Hawaii, Alaska, and Puerto Rico.

SiriusXM® is a registered trademark of SiriusXM® Radio, Inc.

Video CDs, DVDs, and 3-inch (8-cm) mini CDs are not supported.

iPod, iPhone and iTunes are trademarks of Apple Inc.

State or local laws may prohibit the operation of handheld electronic devices while operating a vehicle.

When the screen is viewed through polarized sunglasses, a rainbow pattern may appear on the screen due to optical characteristics of the screen. If this is disturbing, please operate the screen without polarized sunglasses.

USB Port

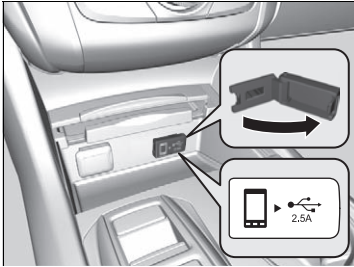

1. Open the center pocket and tray.
 ▶ **Center Pocket** P. 193
2. Open the cover.
3. Install the device USB connector or the USB flash drive to the USB port.
 ▶ The USB port (2.5A) is for charging devices, playing audio files and connecting compatible phones with Apple CarPlay or Android Auto.

USB Port

- Do not leave the iPod or USB flash drive in the vehicle. Direct sunlight and high temperatures may damage it.
- We recommend using an extension cable with the USB port.
- Do not connect the iPod or USB flash drive using a hub.
- Do not use a device such as a card reader or hard disk drive, as the device or your files may be damaged.
- We recommend backing up your data before using the device in your vehicle.
- Displayed messages may vary depending on the device model and software version.

If the audio system does not recognize the iPod, try reconnecting it a few times or reboot the device. To reboot, follow the manufacturer's instructions provided with the iPod or visit the following website:

- U.S.: www.apple.com/ipod.
- Canada: www.apple.com/calipod.

USB charge

The USB port can supply up to 2.5A of power. It does not output 2.5A unless requested by the device. For amperage details, read the operating manual of the device that needs to be charged. Set the power mode to ACCESSORY or ON first.

Under certain conditions, a device connected to the port may generate noise in the radio you are listening to.

Auxiliary Input Jack

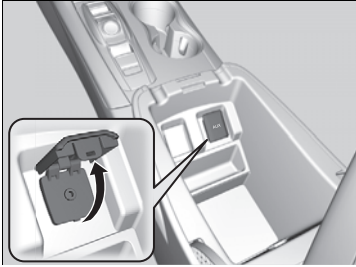

Use the jack to connect standard audio devices.

1. Open the **AUX** cover.
2. Connect a standard audio device to the input jack using a 1/8 inch (3.5 mm) stereo miniplug.
 - ▶ The audio system automatically switches to the AUX mode.

▶ Auxiliary Input Jack

You can return to the AUX mode by selecting **Source** on the On Demand Multi-Use Display™.

Audio System Theft Protection

The audio system is disabled when it is disconnected from the power source, such as when the battery is disconnected or goes dead. In certain conditions, the system may display a code entry screen. If this occurs, reactivate the audio system.

■ Reactivating the audio system

1. Set the power mode to ON.
2. Turn on the audio system.
3. Press and hold the audio system power button for more than two seconds.
 - ▶ The audio system is reactivated when the audio control unit establishes a connection with the vehicle control unit. If the control unit fails to recognize the audio unit, you must go to a dealer and have the audio unit checked.

Audio Remote Controls

Allow you to operate the audio system while driving. The information is shown on the multi-information display.

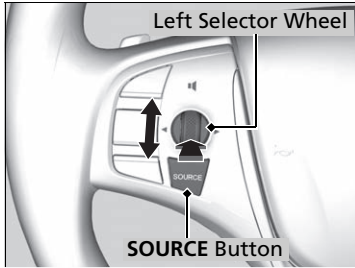

SOURCE Button

Cycles through the audio modes as follows:
 FM→AM→SiriusXM®→CD→USB/iPod/Apple
 CarPlay/Android Auto→*Bluetooth*®
 Audio→Pandora®*→AUX

Left Selector Wheel

Roll Up: To increase the volume.

Roll Down: To decrease the volume.

Push: To mute. Push again to unmute.

- When listening to the radio

Move to the right: To select the next preset radio station.

Move to the left: To select the previous preset radio station.

Move to the right and hold: To select the next strong station.

To select the next channel. (SiriusXM® only)

Move to the left and hold: To select the previous strong station.

To select the previous channel. (SiriusXM® only)

Audio Remote Controls

Some mode appears only when an appropriate device or medium is used.

- When listening to a CD, iPod, USB flash drive, or *Bluetooth*® Audio
 - Move to the right:** To skip to the next song.
 - Move to the left:** To go back to the beginning of the current or previous song.
 - Move to the right and hold:** To go to the next folder. (*Bluetooth*® Audio only)
 - Move to the left and hold:** To go to the previous folder. (*Bluetooth*® Audio only)
- When listening to a CD or USB flash drive
 - Move to the right and hold:** To skip to the next folder.
 - Move to the left and hold:** To go back to the previous folder.
- When listening to Pandora®*
 - Move to the right:** To skip to the next track.
 - Move to the right and hold:** To select the next station.
 - Move to the left and hold:** To select the previous station.

Audio System Basic Operation

To use the audio system, the power mode must be in ACCESSORY or ON.

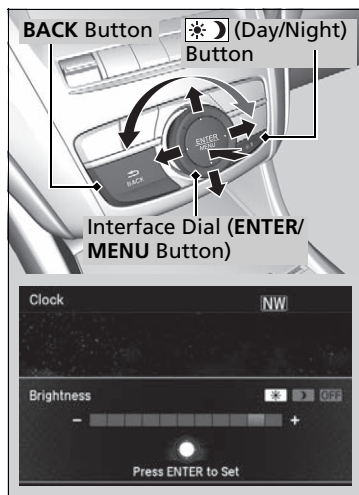

Use the interface dial or **ENTER/MENU** button to access phone, information or smartphone functions.

Interface dial (ENTER/MENU button):

Rotate left or right to scroll through the available choices. Press to set your selection. Move right, left, up or down to select a secondary menu.

Press to switch the display to the **Information Menu** screen while the trip computer screen or clock/wallpaper screen is displayed.

BACK button: Press to go back to the previous display.

(Day/Night) button: Press to change the information screen brightness. Press **(Day/Night)** once and make an adjustment using the interface dial.

- ▶ Each time you press **(Day/Night)**, the mode switches between the daytime mode, nighttime mode and off mode.

Audio System Basic Operation

These indications are used to show how to operate the interface dial.

Rotate to select.

Press to enter.

Move , , or to select a secondary menu.

Audio function items

- ▶ **Station List** P. 231
- ▶ **Save Preset** P. 231, 235
- ▶ **Radio Text** P. 232
- ▶ **Music Search** P. 245, 248, 253
- ▶ **Scan** P. 232, 243, 246, 254
- ▶ **Random/Repeat** P. 246, 249, 254

When you unlock the doors with your remote, the driver's ID (**Driver 1** or **Driver 2**) is detected, and the audio system settings and preset memory are turned to the respective mode automatically when you set the power mode to ON.

On Demand Multi-Use Display™

Use the On Demand Multi-Use Display™ to operate the audio system.

Selecting an Audio Source

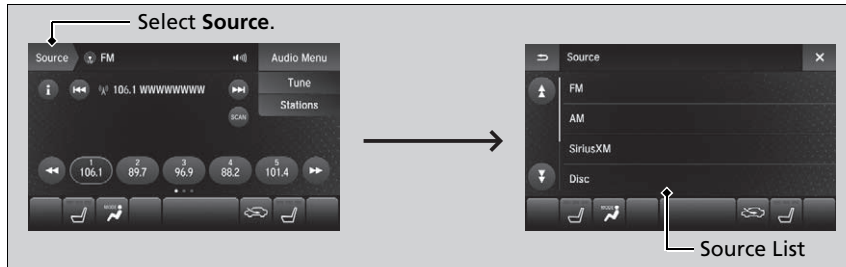

Select **Source**, then select an item on the source list to switch the audio source.

Displaying the Menu Items

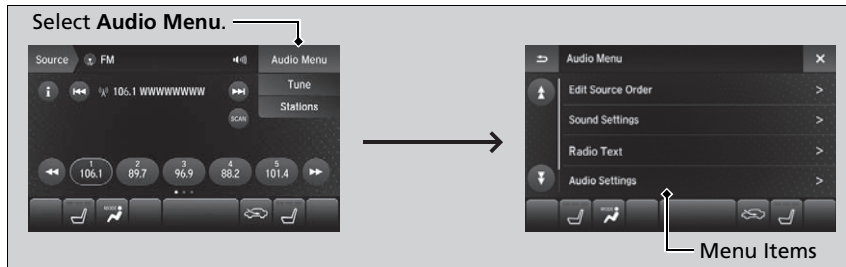

Select **Audio Menu** to display the menu items.

On Demand Multi-Use Display™

Icons that appear on the screen vary by the source selected.

Select or to go back to the previous screen.

Use the icons to turn the page.

Selecting an Audio Source

You can change the order of source list displayed.

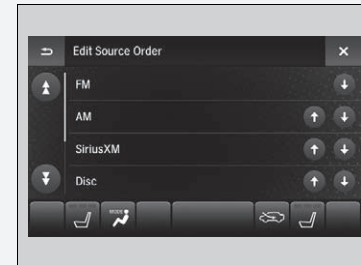

1. Select **Audio Menu**, then **Edit Source Order**.
2. Select or .

You can also change the source order by pressing and holding the source on the source list for two seconds.

The following items are available:

- **Edit Source Order**: Displays the **Edit Source Order** screen.
 - **Selecting an Audio Source** P. 220
- **Sound Settings**: Displays the **Sound Settings** screen.
 - **Adjusting the Sound** P. 228
- **Radio Text** (FM mode): Displays the text information broadcast by the current RDS station.
 - **Radio text** P. 232
- **SportsFlash** (SiriusXM® mode): Displays the SportsFlash™ list. If the favorite sport team is not registered, the setup screen of SportsFlash™ is displayed.
 - **Live Sports Alert** P. 239
 - **Customized Features** P. 292
- **Traffic & Weather Now** (SiriusXM® mode): Displays to the Traffic & Weather Now screen.
 - **Traffic and Weather Information** P. 241
- **View Channel Schedule** (SiriusXM® mode): Displays the SiriusXM® channel schedule.
- **Audio Settings**: Displays the **Audio Settings** screen.
 - **Customized Features** P. 292
- **Screen Settings**: Displays the **Screen Settings** screen.
 - **Changing the Screen Settings** P. 222

■ Changing the Screen Settings

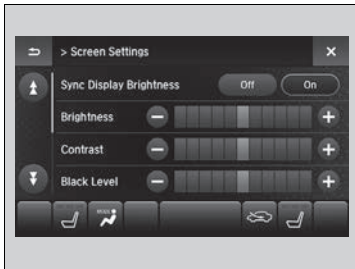

1. Select **Audio Menu**, then select **Screen Settings**.
2. Use **+**, **-** or other icons to adjust the setting.

☞ Changing the Screen Settings

The following are adjustable screen settings:

- **Sync Display Brightness**
Selects whether the screen brightness synchronizes with the instruments panel brightness.
- **Brightness**
- **Contrast**
- **Black Level**
- **Beep**
Mutes a beep that sounds every time you touch the screen.
- **Keyboard**
Changes the on-screen keyboard from the alphabetical order to the qwerty type.

Instead of using **+**, **-** or icons, you can also touch the point where your desired setting is.

Information Screen

Displays the clock/wallpaper, trip computer, Apple CarPlay and Android Auto. From this screen, you can go to various setup options.

Switching the Display

Press the **PHONE**, **INFO** and **SMARTPHONE** buttons to go to the corresponding display.



■ Phone

Shows the HFL information.  **Bluetooth® HandsFreeLink®** P. 317

■ Info

Shows the **Trip Computer** or **Clock/Wallpaper**. Press  to display the **Information Menu** screen.

Trip computer:

Current Drive



Shows the range and instant and average fuel economy of the current trip, as well as the average fuel economy from your last trip.

History of Trip A

Shows the range, average fuel economy and distances traveled for the current trip, as well as the average fuel economy and distances traveled during the last three driving cycles.

Each time you reset the trip meter A, the information on the display updates. The history of the previous three driving cycles is kept.

Deleting the history manually

1. Press  on the **History of Trip A** screen to select **Delete History**.
2. A confirmation message appears on the screen. Rotate  to select **Yes**, then press .

Clock/Wallpaper:

Shows a clock screen or an image you import.

■ Smartphone

Displays the Apple CarPlay or Android Auto.

📱 **Apple CarPlay** P. 258

📱 **Android Auto** P. 262

Wallpaper Setup

You can change, store, and delete the wallpaper on the information screen.

Import wallpaper

You can import up to three images, one at a time, for wallpaper from a USB flash drive.

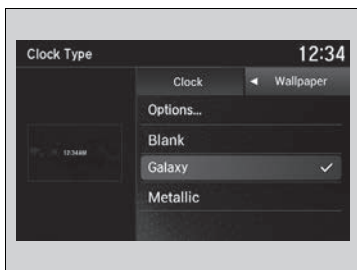



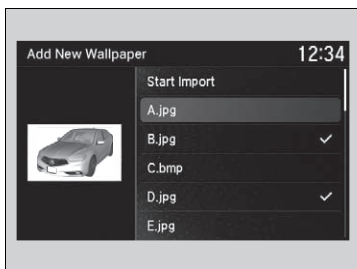



1. Connect the USB flash drive to the USB port.
▶ **USB Port** P. 215
2. Press the **SETTINGS** button.
3. Rotate to select **Clock Settings**, then press .
- ▶ Repeat the procedure to select **Clock/Wallpaper Type**.
4. Move to select **Wallpaper** tab.
▶ The screen will change to the wallpaper list.
5. Rotate to select **Options...**, then press .
- ▶ Repeat the procedure to select, **Add New Wallpaper**.
6. Rotate to select a desired picture.
▶ The preview is displayed on the left side on the screen.
7. Rotate to select **Start Import**, then press to save the data.
▶ The display will return to the wallpaper list.











Wallpaper Setup

- When importing wallpaper files, the image must be in the USB flash drive's root directory. Images in a folder cannot be imported.
- The file name must be fewer than 255 characters.
- The file format of the image that can be imported is BMP (bmp) or JPEG (jpg).
- The individual file size limit is 2 MB.
- The maximum image size is 1,680 x 936 pixels.
- If the USB flash drive does not have any pictures, the **No files detected** message appears.

■ Select wallpaper

1. Press the **SETTINGS** button.
2. Rotate  to select **Clock Settings**, then press .
 - ▶ Repeat the procedure to select **Clock/Wallpaper Type**.
3. Move  to select **Wallpaper**.
 - ▶ The screen changes to the wallpaper list.
4. Rotate  to select a desired wallpaper, then press .
 - ▶ The preview is displayed on the left side on the screen.
 - ▶ The pop-up menu appears on the screen.
5. Rotate  to select **Set**, then press .
 - ▶ The display will return to the **Clock Settings** screen.

■ Delete wallpaper

1. Press the **SETTINGS** button.
2. Rotate  to select **Clock Settings**, then press .
 - ▶ Repeat the procedure to select **Clock/Wallpaper Type**.
3. Move  to select **Wallpaper**.
 - ▶ The screen changes to the wallpaper list.
4. Rotate  to select a wallpaper that you want to delete, then press .
 - ▶ The preview is displayed on the left side on the screen.
 - ▶ The pop-up menu appears on the screen.
5. Rotate  to select **Delete**, then press .
 - ▶ The confirmation message will appear.
6. Rotate  to select **Yes**, then press  to delete completely.
 - ▶ The display will return to the wallpaper list.

Adjusting the Sound

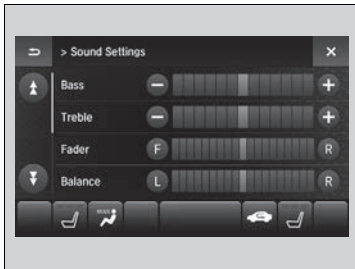

1. Select **Audio Menu**, then select **Sound Settings**.
2. Select the **Bass**, **Treble**, **Fader**, **Balance**, **Subwoofer** or **SVC** (Speed-sensitive Volume Compensation).
3. Use **+**, **-** or other icons to adjust the setting.

▶▶ Adjusting the Sound

The SVC has four modes: **Off**, **Low**, **Mid**, and **High**. SVC adjusts the volume level based on the vehicle speed. As you go faster, audio volume increases. As you slow down, audio volume decreases.

Instead of using **+**, **-** or icons, you can also touch the point where your desired setting is.







Display Setup

You can change the brightness of the information screen and On Demand Multi-Use Display™.

Changing the Screen Brightness



Information Screen

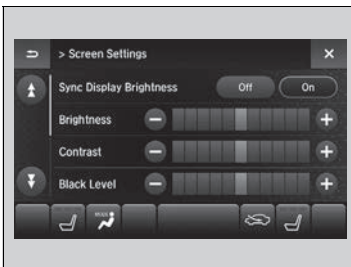

1. Press the **SETTINGS** button.
2. Rotate  to select **System Settings**, then press .
3. Rotate  to select **Brightness**, then press .
4. Rotate  to adjust the setting.
5. Press .
 - ▶ The display will return to the **System Settings** screen.

On Demand Multi-Use Display™



1. Select **Audio Menu**, then select **Screen Settings**.
2. Use ,  to adjust the setting.

Changing the Screen Brightness

You can change the **Contrast** and **Black Level** settings in the same manner.

Playing AM/FM Radio

Features

Skip/Seek Icons

Select **◀◀** or **▶▶** to search up and down the selected band for a station with a strong signal.

VOL/⏻ (Volume/Power) Knob

Press to turn the audio system on and off.
Turn to adjust the volume.

Source

Select to change a band or change an audio source.

i (Information) Icon

Select to displays the current station details.

Select **↶** to displays the previous screen.

Preset Icons

Tune the preset radio frequency. Select and hold the preset icon to store that station.
Select **◀◀** or **▶▶** to display preset 6 onwards.

Audio Menu

Select to display the menu items.

Tune Icon

Select to displays the manual input screen of radio frequency.

Stations Icon

Select to displays the station list screen.

SCAN

Select to sample each of the strongest stations on the selected band for 10 seconds.

On Demand Multi-Use Display™

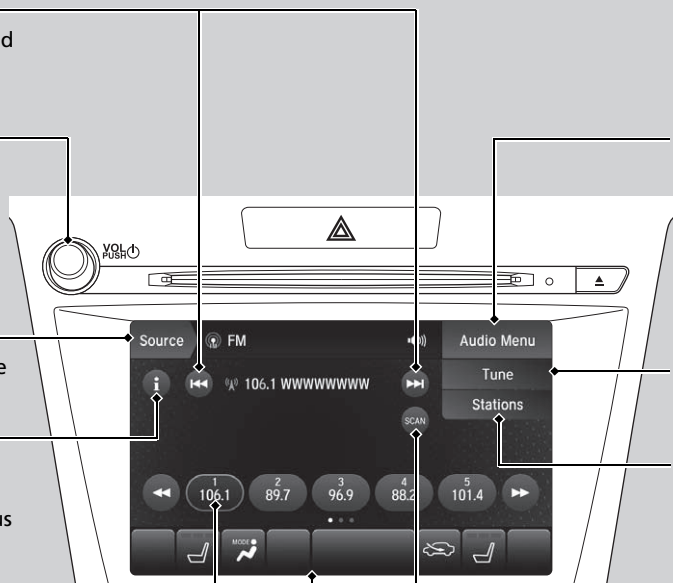

■ Preset Memory

To store a station:

1. Tune to the selected station.
2. Select and hold the preset number you want to store that station.

■ Radio Data System (RDS)

Provides text data information related to your selected RDS-capable FM station.

■ To find an RDS station from Station List

1. Select **Stations**.
2. Select station on the list.

■ Manual update

Updates your available station list at any time.

1. Select **Stations**.
2. Select **Refresh** on the list.

▶▶ Playing AM/FM Radio

The **ST** indicator appears on the display indicating stereo FM broadcasts.
Stereo reproduction in AM is not available.

Switching the Audio Mode

Press the **SOURCE** button on the steering wheel.

▶▶ **Audio Remote Controls** P. 217

You can store 6 AM stations and 12 FM stations into the preset memory.

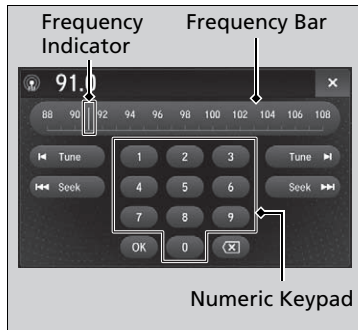

■ Radio frequency manual tune screen

1. Select **Tune**.
2. Enter the desired radio frequency using the numeric keypad.
3. Select **OK** to tune into the frequency.

You can also tune into the radio frequency of your choice following the procedures below instead of inputting its frequency value.

1. Touch the desired frequency value on the frequency bar.
2. Select and hold the frequency indicator, then slide it to the desired frequency value on the frequency bar.

■ Radio text

Display the radio text information of the selected RDS station.

1. Select **Audio Menu**.
2. Select **Radio Text**.

■ Scan

Samples each of the strongest stations on the selected band for 10 seconds.

Select **SCAN**.

To turn off scan, select **Stop Scan**.

▶▶ Radio frequency manual tune screen

You can tune the range of FM frequency between 87.7 to 107.9MHz and range of AM frequency between 530 to 1710kHz.

Tune icons:

Select or to tune the radio frequency.

Seek icons:

Select or to search the selected band up or down for a station with a strong signal.

▶▶ Radio text

The text indicator comes on when you received a text message. The indicator stays on until you read the message.

The radio text information is not updated automatically. If you want to display the latest information, return to the previous screen and select **Radio Text** again.

Playing SiriusXM® Radio

Category Up/Down Icons
Select ◀ or ▶ to display and select a SiriusXM® Radio category.

VOL/PUSH (Volume/Power) Knob
Press to turn the audio system on and off.
Turn to adjust the volume.

Source
Select to change an audio source.

Audio Menu
Select to display the menu items.

Source
Source: SiriusXM

Audio Menu
Audio Menu

Browse Icon
Select to displays the channel list of **Categories, Channels or Featured channels** types.

Pop
Pop

Tune Icon
Select to displays the channel number input screen.

CH 001
CH 001

Tune
Tune

Track AAA
Track AAA

Presets/Controls Icon
Select to changes between the **Presets** mode and **Controls** mode of the Replay function.

Presets/Controls
Presets Controls

Information Icon
Select to displays the current channel details.
Select ◀ to displays the previous screen.

Channel Up/Down Icons
Select ◀ or ▶ to the previous or next channel.
Select and hold to rapidly skip 10 channels at a time.

Presets
1 CH,001 2 3

On Demand Multi-Use Display™

■ To Play SiriusXM® Radio

1. Select the SiriusXM® mode.
 - ▶ **Audio Remote Controls** P. 217
 - ▶ **On Demand Multi-Use Display™** P. 220
2. Select a channel using the ◀, ▶ icons or the preset numbers (1-12) on the preset mode screen.

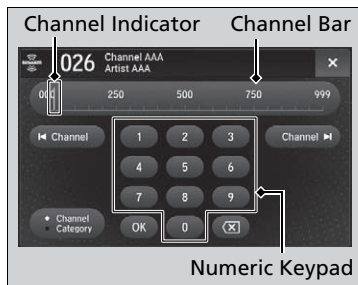

■ SiriusXM® channel manual tune screen

1. Select **Tune**.
2. Enter the desired channel number using the numeric keypad.
3. Select **OK** to tune into the channel.

You can also tune into the channel of your choice following the procedures below instead of inputting its channel number.

1. Touch the desired channel number on the channel bar.
2. Select and hold the channel indicator, then slide it to the desired channel number on the channel bar.

▶▶ Playing SiriusXM® Radio

In the channel mode, all available channels are selectable. In the category mode, you can select a channel within a category (Jazz, Rock, Classical, etc.).

There may be instances when SiriusXM® Radio does not broadcast all the data fields (artist name, title). This does not indicate a problem with your audio system.

SiriusXM® Radio stations load in ascending order, which can take about a minute. Once they have loaded you will be able to scroll up or down to make your selections.

Tune Start:

When you change a channel, a song being played on that channel restarts from the beginning with this function. This can be turned on or off from the **Play the Song from the Beginning** setting.

▶ **Customized Features** P. 292

▶▶ SiriusXM® channel manual tune screen

Channel icons:

Select ◀ or ▶ to the previous or next channel.
 Select and hold to rapidly skip 10 channels at a time.

To change the tune mode:



1. Select **Tune**.
2. Select **Channel/Category** icon.

Preset Memory

To store a station:

1. Tune to the selected channel.
2. Select **Presets/Controls** icon to set the **Presets**.
3. Select and hold the preset number you want to store that channel.

▶▶ Playing SiriusXM® Radio

You can store 12 SiriusXM® stations into the preset memory.

■ TuneMix™ (Multi-channel preset)

You can store up to 10 of your preferred music channels and listen to them randomly.



1. Tune a channel.
2. Select and hold the preset number you want to store that channel.
3. Select **Add**.
4. Select **Done** to return the previous screen.

To delete a multi-channel preset:

1. Select and hold the preset number you want to delete that channel.
2. Select the channel icon.
3. Select **Delete**.
4. Select **Done** to return the previous screen.

▶▶ TuneMix™ (Multi-channel preset)

TuneMix™ is registered trademarks of SiriusXM® Radio, Inc.

To store a multi-channel preset, you need to setup the **TuneMix** setting to **On**.

▶▶ **Customized Features** P. 292

TuneMix™ is available for music channels only.

■ Listening to Featured Channels

Suggested channel listing received from SiriusXM® can be displayed and selected.

1. Select **Browse**.
2. Select **Featured Channels**.
3. Select a channel.

■ Displaying a Channel Schedule

You can check a channel schedule by selected channel list on the On Demand Multi-Use Display™.

1. Select **Audio Menu**.
2. Select **View Channel Schedule**.

You can also check the other channel by the following procedure.

3. Select **Categories, Channels** or **Presets**.
4. Select a channel.

☒ Listening to Featured Channels

Up to three featured channels by SiriusXM® can be displayed.

■ Replay Function

The system constantly records up to the last 60 minutes of your currently tuned channel and all the preset channel broadcast, starting from the moment you turn the power mode to ON. You can rewind and replay the last 60 minutes of each broadcast.

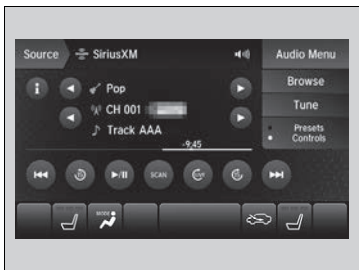

1. Select **Presets/Controls** icon to set the **Controls**.
2. Select an option.

The following items are available:

- : Pauses or plays a storing broadcast.
- : Returns to real-time broadcast.
- : Skips to the previously stored channel.
- : Skips to the next channel.
- : Select to skip back 15 seconds in the current selection. Select and hold to fast-rewind the current selection.
- : Select to skip forward 15 seconds in the current selection. Select and hold to fast-forward the current selection.

■ Returning to real-time broadcast

Select while listening to the playback channel.

▶▶ Replay Function

The system starts storing broadcast in memory when the power mode is turned ON. You can go back to the program from that point.

You can no longer replay any program once the power mode is turned OFF as it erases memory. You can check how long the program has been stored in memory from the On Demand Multi-Use Display™.

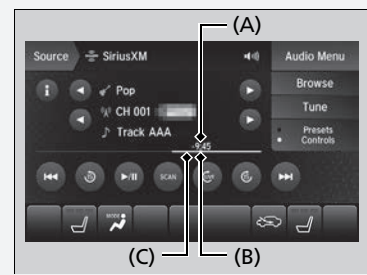

- (A): Shows how much time the replayed segment is behind the real-time broadcast
- (B): Replayed segment
- (C): Length stored in memory

■ Live Sports Alert

While listening to other channels you can receive sports alerts such as scores from your favorite teams.

■ To set up a sports alert

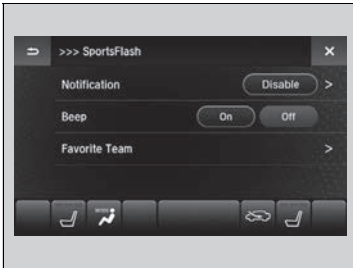

1. Select **Audio Menu**.
2. Select **Audio Settings**.
3. Select **SiriusXM**.
4. Select **SportsFlash**.
5. Select **Notification**, then select **Enable**.
6. Select **Favorite Teams**, then select a team.

⌘ Live Sports Alert

The sports alert function at SiriusXM® mode only.

⌘ To set up a sports alert

Sports alerts cut in only when SiriusXM® mode is on. Selecting **Enable once** from customized settings disables the alert feature next time you turn the power mode to ON.

➤ **Customized Features** P. 292

Traffic and Weather Information

You can receive the SiriusXM® traffic and weather information service in SiriusXM® mode.

To set up a traffic & weather information

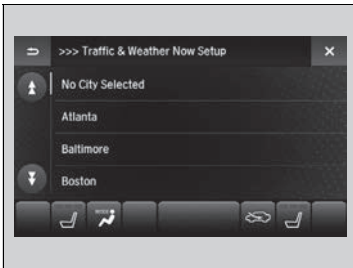

1. Select **Audio Menu**.
2. Select **Audio Settings**.
3. Select **SiriusXM**.
4. Select **Traffic & Weather Now Setup**.
5. Select the region.
 - ▶ When you do not want to receive the information, select **No City Selected**.

Traffic and Weather Information

The traffic and weather information function in SiriusXM® mode only.

Traffic & Weather Now are registered trademarks of SiriusXM® Radio, Inc.

To set up a traffic & weather information

When you listen to the traffic and weather information service, set up the applicable city using **Traffic & Weather Now Setup**.

Continued

■ Listening a traffic and weather information

1. Select **Audio Menu**.
2. Select **Traffic & Weather Now**.

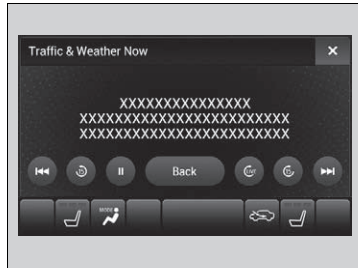

The following items are available:

: Pauses or plays a stored broadcast.

: Returns to real-time broadcast.

: Skips to the previously stored channel.

: Skips to the next channel.

: Select to skip back 15 seconds in the current broadcast. Select and hold to fast-rewind the current broadcast.

: Select to skip forward 15 seconds in the current broadcast. Select and hold to fast-forward the current broadcast.

Back: Returns to previous channel.

Scan

Sample each channel on the selected mode for 10 seconds.

1. Select **Presets/Controls** to set the **Controls**.
2. Select **SCAN**.
3. Select **Scan Channels** or **Scan Presets**.

To turn off scan, select **Stop Scan**.

Scan

You can select desired channel by songs using **Scan Presets**.



The "Scan Songs in Presets" function is based on TuneScan™ technology of SiriusXM®.

The "Featured Channels" function is based on Featured Favorites™ technology of SiriusXM®.

TuneScan™ and Featured Favorites™ are registered trademarks of SiriusXM® Radio, Inc.

Scan Mode Menu Items

Scan Channels: Scans for channels with a strong signal in the selected mode.

Scan Presets: Scans for desired preset channel by songs. Select  (skip up) or  (skip down) to skip to the next/previous stored selection.

Playing a CD

Your audio system supports audio CDs, CD-Rs and CD-RWs in either MP3, WMA, or AAC*1 format. With the CD loaded, select the CD mode.

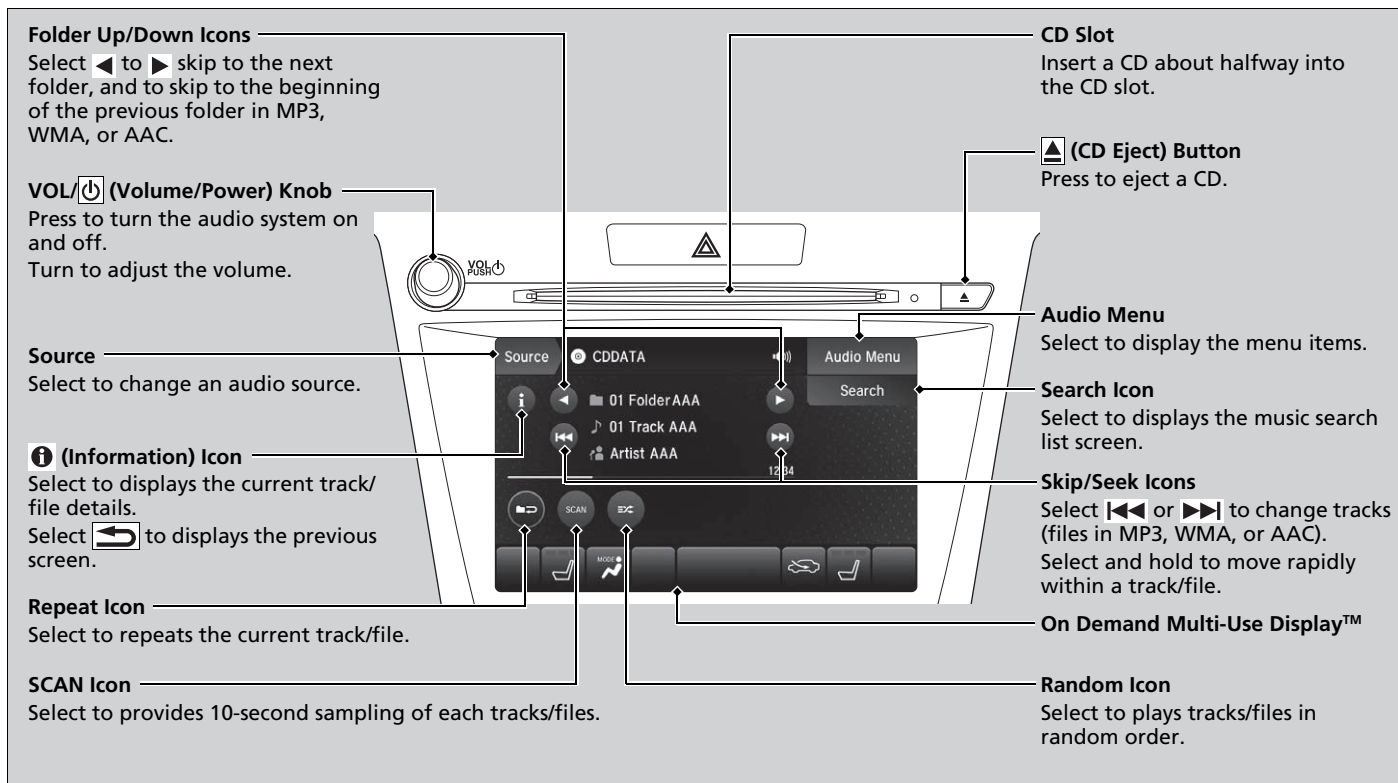

*1: Only AAC format files recorded with iTunes are playable on this unit.

How to Select a File from the Music Search List (MP3/WMA/AAC)

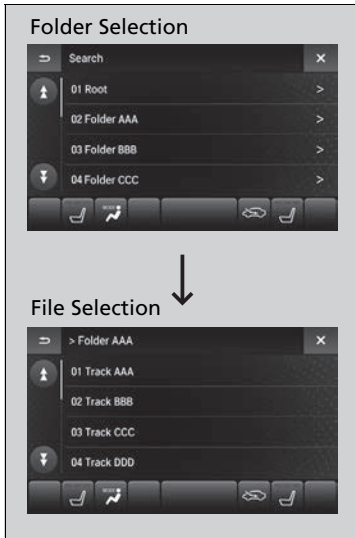

1. Select **Search**.
2. Select a folder.
3. Select a track.

▶▶▶ Playing a CD

NOTICE

Do not use CDs with adhesive labels. The label can cause the CD to jam in the unit.

WMA and AAC files protected by digital rights management (DRM) cannot be played. The audio system skips to the next file.

Text data appears on the display under the following circumstances:

- When you select a new folder, file, or track.
- When you change the audio mode to CD.
- When you insert a CD.

If you eject the CD but do not remove it from the slot, the system reloads the CD automatically after several seconds.

■ How to Select a Play Mode

You can select scan, repeat, and random modes when playing a track or file.

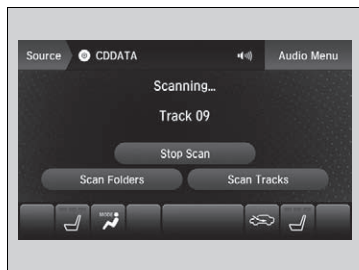

■ Scan

Select **SCAN** to provides 10-second sampling of each tracks/files.

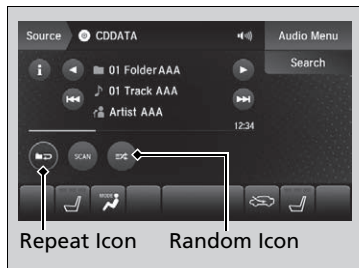

■ Random/Repeat

Select repeat or random icon repeatedly until a desired mode.

■ To turn off a play mode

To turn off scan, select **Stop Scan**.

To turn off random/repeat, select repeat or random icon repeatedly.

▶▶ How to Select a Play Mode

Play Mode Menu Items

SCAN

Scan Folders (MP3/WMA/AAC): Provides a 10-second sampling of the first file in each of the main folders.

Scan Tracks (MP3/WMA/AAC): Provides a 10-second sampling of all files in the current folder in MP3, WMA, or AAC.

Repeat



(repeat off): Repeat mode to off.



(repeat track): Repeats the current track/file.



(repeat folder) (MP3/WMA/AAC): Repeats all files in the current folder.

Random



(random off): Random mode to off.



(random in folder) (MP3/WMA/AAC): Plays all files in the current folder in random order.



(random all tracks): Plays all tracks/files in random order.

Playing an iPod

Connect the iPod using your USB connector to the USB port, then select the iPod mode.

 **USB Port** P. 215

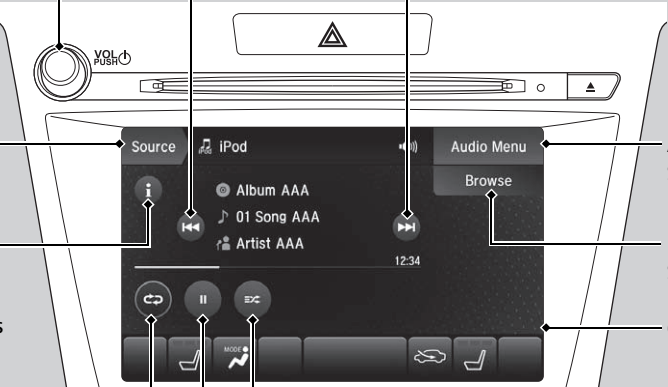



VOL/PUSH (Volume/Power) Knob
Press to turn the audio system on and off.
Turn to adjust the volume.

Source
Select to change an audio source.

Information Icon
Select to displays the current song details.
Select  to displays the previous screen.

Repeat Icon
Select to repeats the current song.

Play/Pause (Play/Pause) Icon
Select to resume or play a song.

Skip/Seek Icons
Select  or  to change songs.
Select and hold to move rapidly within a song.

Audio Menu
Select to display the menu items.

Browse Icon
Select to displays the music search list screen.

On Demand Multi-Use Display™

Shuffle Icon
Select to change a play mode in album shuffle or shuffle all songs.

How to Select a Song from the Music Search List

1. Select **Browse**.
2. Select the items on that menu.

How to Select a Song from the Music Search List

Available operating functions vary on models and/or versions. Some functions may not be available on the vehicle's audio system.

If there is a problem, you may see an error message on the On Demand Multi-Use Display™.

 **iPod/USB Flash Drive** P. 268

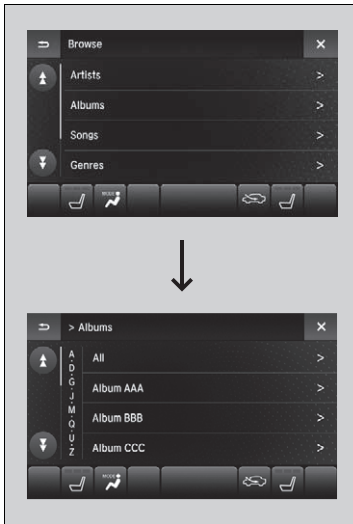

How to Select a Play Mode

You can select repeat and shuffle modes when playing a song.

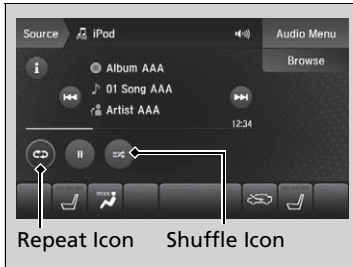

Shuffle/Repeat

Select shuffle or repeat icon repeatedly until a desired mode.

To turn off a play mode

To turn off the shuffle or repeat, select shuffle or repeat icon repeatedly.

How to Select a Play Mode

Play Mode Menu Items

Repeat



(repeat off)*1: Repeat mode to off.



(repeat song): Repeats the current song.



(repeat all): Repeats the all songs.

Shuffle



(shuffle off): shuffle mode to off.



(shuffle all songs): Plays all available songs in a selected list (playlists, artists, albums, songs, genres, or composers) in random order.



(shuffle albums): Plays all available albums in a selected list (playlists, artists, albums, songs, genres, or composers) in random order.

*1: Not available on all iPod.

U.S. models

Playing Pandora®

Your audio system allows you to listen to music from the Pandora® app on a compatible smartphone.

This function is available when the phone is paired and connected to the vehicle's *Bluetooth*® HandsFreeLink® (HFL) system, or with an iPhone, you can connect using your USB cable to the USB port.

▶ **Phone Setup** P. 325

▶ **USB Port** P. 215

▶▶ Playing Pandora®

Pandora®, the Pandora logo, and the Pandora trade dress are trademarks or registered trademarks of Pandora Media, Inc., used with permission. Pandora is currently available exclusively in the United States.

To find out if your phone is compatible with this feature, visit www.acura.com/handsfreelink, or call 1-888-528-7876.

Features

VOL/PUSH (Volume/Power) Knob
Press to turn the audio system on and off.
Turn to adjust the volume.

Source
Select to change an audio source.

(Information) Icon
Select to displays the current track details.
Select **↶** to displays the previous screen.

Like/Dislike Icons
Select to evaluate a track.

Play/Pause Icon
Select to resume or play a track.

Station Up/Down Icons
Select to change a station.

Audio Menu
Select to display the menu items.

Stations Icon
Select to displays the station list screen.

Bookmark Track Icon
Bookmarks the current track.

Bookmark Artist Icon
Bookmarks the current artist.

On Demand Multi-Use Display™

Skip Icon
Select to skip a track.

How to Select a Track from the Stations List

1. Select **Stations**.
2. Select a item to select a track.

Create Station

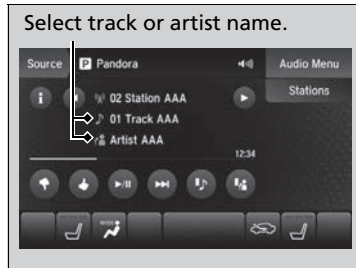

You can create a station by **Genre**, **Current Track** or **Current Artist**.

1. Select **Stations**.
2. Select **Create Station**.
3. Select the item you want to create a station.

You can also create a station by the following procedure.

1. Select track name or artist name.
2. Select **Yes**.

Select the connecting method

If the two devices that install Pandora app are connected via the USB and *Bluetooth*® connection separately, you can select the USB or *Bluetooth*® connection to use the Pandora®.

1. Select the **PANDORA** on the source list screen.
2. Select **USB** or **Bluetooth**.

▶▶ Playing Pandora®

Pandora® is a personalized Internet radio service that selects music based on an artist, track, or genre a user enters, and streams what is likely to be of interest.

To use this service in your vehicle, the Pandora® app must first be installed on your phone. Visit www.pandora.com. for more information.

If you cannot operate Pandora® through the audio system, it may be streaming through *Bluetooth*® Audio. Make sure Pandora® mode on your audio system is selected.

Available operating functions vary on software versions. Some functions may not be available on the vehicle's audio system.

If there is a problem, you may see an error message on the On Demand Multi-Use Display™.

▶ **Pandora®** P. 270

There are restrictions on the number of tracks you can skip or dislike in a given hour.

If your phone is connected to Android Auto, Pandora® is only available through the Android Auto interface.

Visit the Android Auto website to check compatibility.

Playing a USB Flash Drive

Your audio system reads and plays sound files on a USB flash drive in either MP3, WMA, or AAC*1 format.

Connect your USB flash drive to the USB port, then select the USB mode.

➤ **USB Port** P. 215

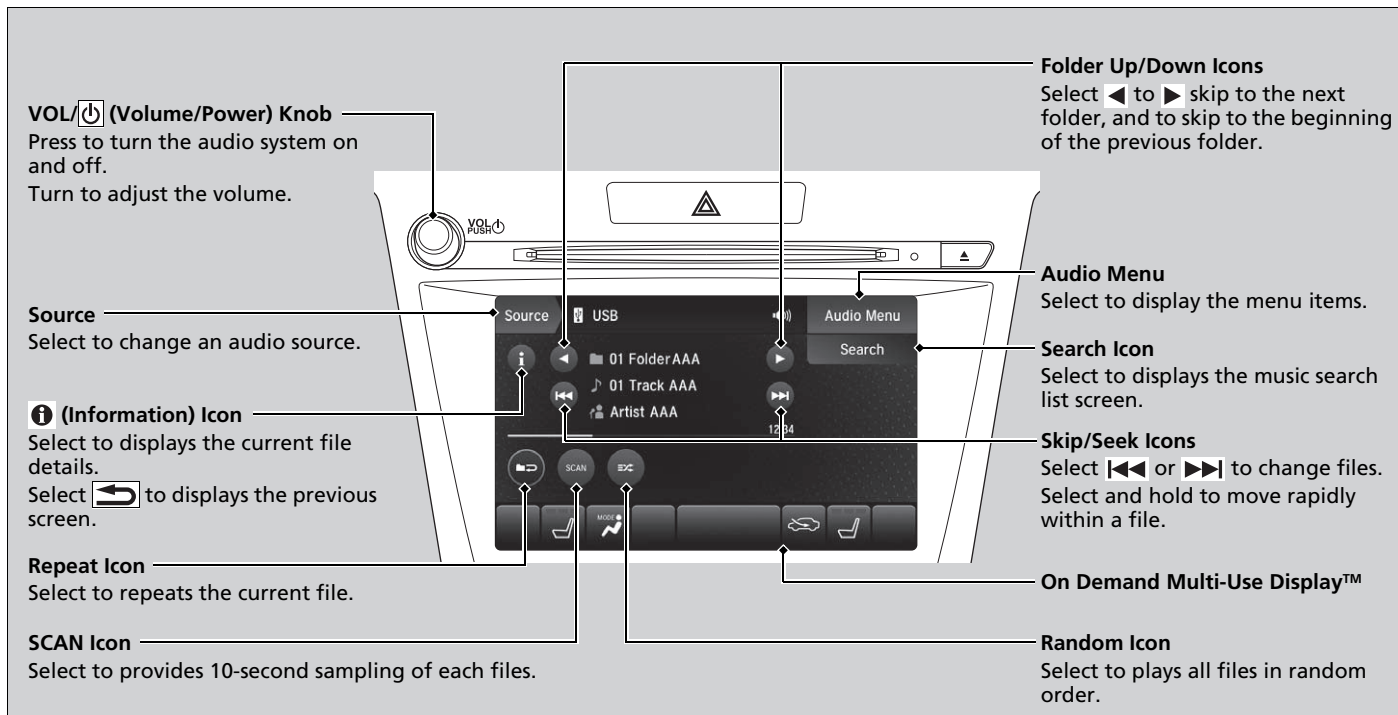

*1: Only AAC format files recorded with iTunes are playable on this unit.

How to Select a File from the Music Search List

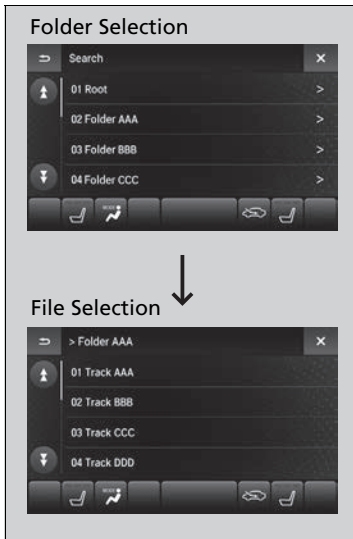

1. Select **Search**.
2. Select a folder.

3. Select a file.

▶▶ Playing a USB Flash Drive

Use the recommended USB flash drives.

▶ **General Information on the Audio System**
P. 274

Files in WMA/AAC format protected by digital rights management (DRM) are not played.
The audio system skips to the next file.

If there is a problem, you may see an error message on the On Demand Multi-Use Display™.

▶ **iPod/USB Flash Drive** P. 268

■ How to Select a Play Mode

You can select scan, repeat, and random modes when playing a file.

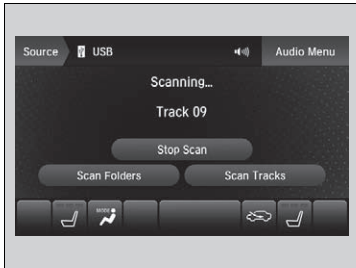

■ Scan

Select **SCAN** to provide a 10-second sampling of each file.

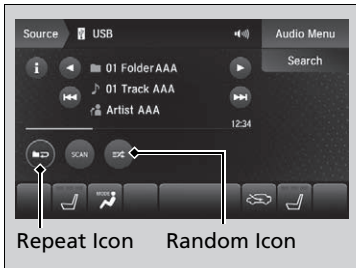

■ Random/Repeat

Select repeat or random icon repeatedly until a desired mode.

■ To turn off a play mode

To turn off scan, select **Stop Scan**.

To turn off random or repeat, select repeat or random icon repeatedly.

▶▶ How to Select a Play Mode

Play Mode Menu Items

SCAN

Scan Folders: Provides a 10-second sampling of the first file in each of the main folders.

Scan Tracks: Provides a 10-second sampling of all files in the current folder.

Repeat



(repeat off): Repeat mode to off.



(repeat track): Repeats the current file.



(repeat folder): Repeats all files in the current folder.

Random



(random off): Random mode to off.



(random in folder): Plays all files in the current folder in random order.



(random all tracks): Plays all files in random order.

Playing *Bluetooth*® Audio

Your audio system allows you to listen to music from your *Bluetooth*-compatible phone.

This function is available when the phone is paired and connected to the vehicle's *Bluetooth*® HandsFreeLink® (HFL) system.

🔧 **Phone Setup** P. 325

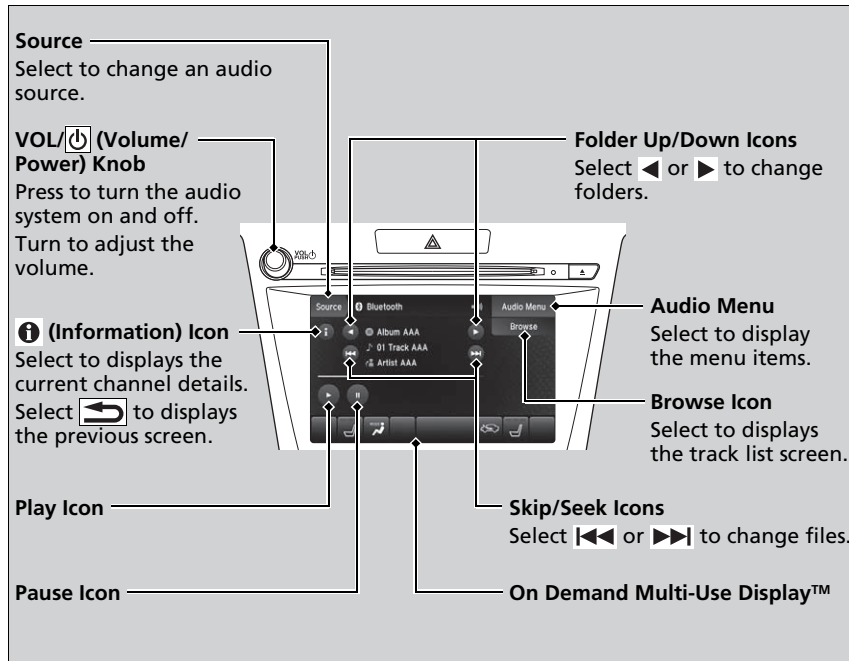

▶▶ Playing *Bluetooth*® Audio

Not all *Bluetooth*-enabled phones with streaming audio capabilities are compatible with the system.

For a list of compatible phones:

- U.S.: Visit www.acura.com/handsfreelink, or call 1-888-528-7876.
- Canada: Visit www.handsfreelink.ca, or call 1-888-528-7876.

In some states, it may be illegal to perform some data device functions while driving.

If more than one phone is paired to the HFL system, there will be a delay before the system begins to play.

Some functions may not be available on some devices.

If a phone is currently connected via Apple CarPlay or Android Auto, *Bluetooth*® Audio from that phone is unavailable. However, a second previously paired phone can stream *Bluetooth*® Audio by selecting **Connect to Audio** from the **Edit Bluetooth Device**.

🔧 **Phone Setup** P. 325

■ To Play *Bluetooth*® Audio Files

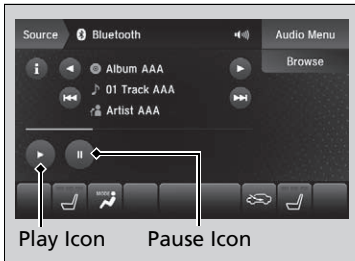

1. Make sure that your phone is paired and connected to HFL.
2. Select the *Bluetooth*® Audio mode.

If the phone is not recognized, another HFL-compatible phone, which is not compatible for *Bluetooth*® Audio, may already be connected.

■ To pause or resume a file

Select the play icon or pause icon.

■ Searching for Music

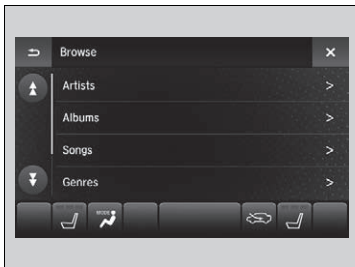

1. Select **Browse**.
2. Select a search category (e.g., Albums).
3. Select an item.
 - ▶ The selection begins playing.

▶▶ To Play *Bluetooth*® Audio Files

To play the audio files, you may need to operate your phone. If so, follow the phone maker's operating instructions.

The pause function may not be available on some phones.

Switching to another mode pauses the music playing from your phone. This function may not be available on some phones.

▶▶ Searching for Music

Depending on the *Bluetooth*® device you connect, some or all of the lists may not be displayed.

Siri Eyes Free

You can talk to Siri using the Talk button on the steering wheel when your compatible iPhone is paired to *Bluetooth*® HandsFreeLink®.

📱 **Phone Setup** P. 325

■ Using Siri Eyes Free

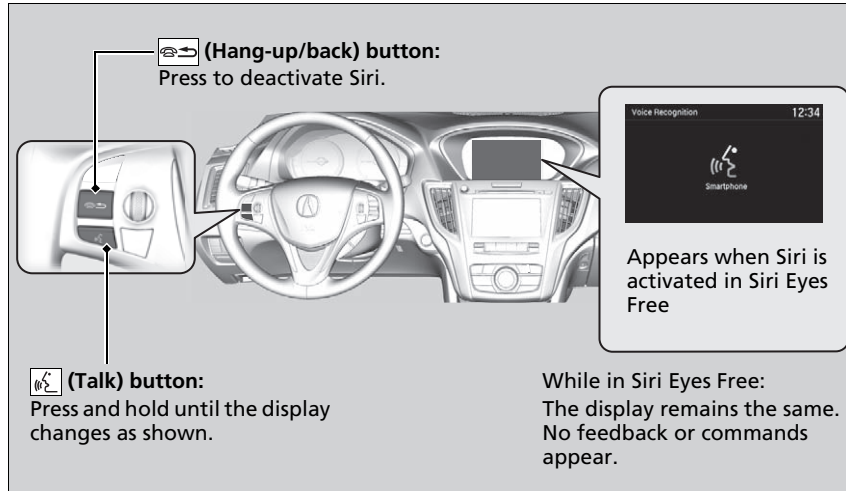

▶ Siri Eyes Free

Siri is a trademark of Apple Inc.

Check Apple Inc. website for features available for Siri.

We recommend against using Siri other than in Siri Eyes Free while operating a vehicle.

▶ Using Siri Eyes Free

Some commands work only on specific phone features or apps.

Apple CarPlay

If you connect an Apple CarPlay-compatible iPhone to the system via the 2.5A USB port, you can use the information screen, instead of the iPhone display, to make a phone call, listen to music, view maps (navigation), and access messages.

➤ **USB Port** P. 215

Apple CarPlay

Only iPhone 5 or newer versions with iOS 8.4 or later are compatible with Apple CarPlay.

Park in a safe place before connecting your iPhone to Apple CarPlay and when launching any compatible apps.

To use Apple CarPlay, connect the USB cable to the 2.5A USB port.

➤ **USB Port** P. 215

To directly access the Apple CarPlay phone function, press the **PHONE** button. While connected to Apple CarPlay, calls are only made through Apple CarPlay. If you want to make a call with *Bluetooth*® HandsFreeLink®, turn Apple CarPlay OFF or detach the USB cable from your iPhone.

➤ **Setting Up Apple CarPlay** P. 260

When your iPhone is connected to Apple CarPlay, it is not possible to use the *Bluetooth*® Audio or *Bluetooth*® HandsFreeLink®. However, other previously paired phones can stream audio via *Bluetooth*® while Apple CarPlay is connected.

➤ **Phone Setup** P. 325

For details on countries and regions where Apple CarPlay is available, as well as information pertaining to function, refer to the Apple homepage.

Apple CarPlay Menu

Information Screen

Apple CarPlay menu screen

12:34
•••••
LTE

Phone Music Maps Messages

Now Playing Acura Podcasts Audiobooks

Go back to the previous screen of this audio system.

Go back to the Apple CarPlay menu screen

SMARTPHONE Button
Press to display the Apple CarPlay menu screen.

Interface Dial (ENTER/MENU Button)*1
Move the interface dial to select the item.
Press to enter the item.

BACK Button*1
Press to go back to the previous display.

*1: The operation methods may differ from your connected iPhone.

■ Phone

Access the contact list, make phone calls, or listen to voice mail.

■ Messages

Check and reply to text messages, or have messages read to you.

■ Music

Play music stored on your iPhone.

■ Maps

Display Apple Maps and use the navigation function just as you would on your iPhone.

▶▶ Apple CarPlay**Apple CarPlay Operating Requirements & Limitations**

Apple CarPlay requires a compatible iPhone with an active cellular connection and data plan. Your carrier's rate plans will apply.

Changes in operating systems, hardware, software, and other technology integral to providing Apple CarPlay functionality, as well as new or revised governmental regulations, may result in a decrease or cessation of Apple CarPlay functionality and services. Acura cannot and does not provide any warranty or guarantee of future Apple CarPlay performance or functionality.

It is possible to use 3rd party apps if they are compatible with Apple CarPlay. Refer to the Apple homepage for information on compatible apps.

■ Setting Up Apple CarPlay

After you have connected your iPhone to the system via the 2.5A USB port, use the following procedure to set up Apple CarPlay. Use of Apple CarPlay will result in the transmission of certain user and vehicle information (such as vehicle location, speed, and status) to your iPhone to enhance the Apple CarPlay experience. You will need to consent to the sharing of this information on the information screen.

■ Enabling Apple CarPlay



Enable Once: Allows only once. (Prompt shows again next time.)

Always Enable: Allows anytime. (Prompt does not show again.)

Cancel: Does not allow this consent.

You may change the consent settings under the **Smartphone Settings** menu.

▶▶ Setting Up Apple CarPlay

You can also use the method below to set up Apple CarPlay:

Press the **SETTINGS**→**Select Smartphone Settings**→**Apple CarPlay Device List**

Use of user and vehicle information

The use and handling of user and vehicle information transmitted to/from your iPhone by Apple CarPlay is governed by the Apple iOS terms and conditions and Apple's Privacy Policy.

■ Operating Apple CarPlay with Siri

Press and hold the talk button to activate Siri.

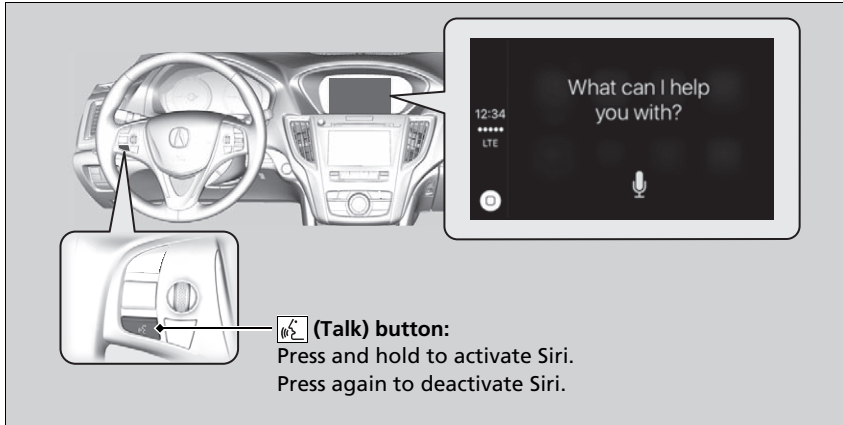

☒ Operating Apple CarPlay with Siri

Below are examples of questions and commands for Siri.

- What movies are playing today?
- Call dad at work.
- What song is this?
- How's the weather tomorrow?
- Read my latest email.
- Find a table for four tonight in Chicago.

For more information, please visit www.apple.com/ios/siri.

Android Auto

When you connect an Android phone to the audio system via the 2.5A USB port, Android Auto is automatically initiated. When connected via Android Auto, you can use the information screen to access the Phone, Google Maps (Navigation), Google Play Music, and Google Now functions. When you first use Android Auto, a tutorial will appear on the screen.

We recommend that you complete this tutorial while safely parked before using Android Auto.

➤ **USB Port** P. 215

➤ **Auto Pairing Connection** P. 265

Android Auto

To use Android Auto, you need to download the Android Auto app from Google Play to your smartphone.

Only Android 5.0 (Lollipop) or later versions are compatible with Android Auto.

Bluetooth A2DP cannot be used with Android Auto phone.

Park in a safe place before connecting your Android phone to Android Auto and when launching any compatible apps.

To use Android Auto, connect the USB cable to the 2.5A USB port.

➤ **USB Port** P. 215

When your Android phone is connected to Android Auto, it is not possible to use the *Bluetooth*® Audio. However, other previously paired phones can stream audio via *Bluetooth*® while Android Auto is connected.

➤ **Phone Setup** P. 325

Android Auto Menu

Information Screen

Android Auto menu screen

SMARTPHONE Button
Press to display the Android Auto menu screen.

Interface Dial (ENTER/MENU Button)*1
Move and rotate the interface dial to select the item.
Press to enter the item.

BACK Button*1
Press to go back to the previous display.

1 2 3 4 5 6

*1: The operation methods may differ from your connected Android phone.

Android Auto

For details on countries and regions where Android Auto is available, as well as information pertaining to function, refer to the Android Auto homepage.

Android Auto Operating Requirements & Limitations

Android Auto requires a compatible Android phone with an active cellular connection and data plan. Your carrier's rate plans will apply.

Changes in operating systems, hardware, software, and other technology integral to providing Android Auto functionality, as well as new or revised governmental regulations, may result in a decrease or cessation of Android Auto functionality and services. Acura cannot and does not provide any warranty or guarantee of future Android Auto performance or functionality.

It is possible to use 3rd party apps if they are compatible with Android Auto. Refer to the Android Auto homepage for information on compatible apps.

1 **Maps (Navigation)**

Display Google Maps and use the navigation function just as you would with your Android phone. When the vehicle is in motion, it is not possible to make keyboard entries. Stop the vehicle in a safe location to undertake a search or provide other inputs.

2 **Phone (Communication)**

Make and receive phone calls as well as listen to voicemail.

3 **Google Now (Home screen)**

Display useful information organized by Android Auto into simple cards that appear just when they're needed.

4 **Music and audio**

Play Google Play Music and music apps that are compatible with Android Auto.

To switch between music apps, press this icon.

5 **Go back to the previous screen of this audio system.**

6 **Voice**

Operate Android Auto with your voice.

■ Auto Pairing Connection

When you connect an Android phone to the unit via the 2.5A USB port, Android Auto is automatically initiated.

■ Enabling Android Auto

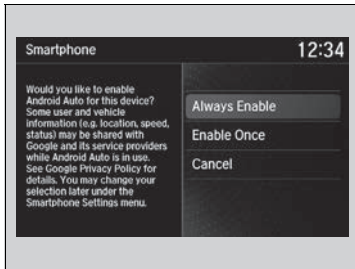

Enable Once: Allows only once. (Prompt shows again next time.)

Always Enable: Allows anytime. (Prompt does not show again.)

Cancel: Does not allow this consent.

You may change the consent settings under the **Smartphone Settings** menu.

▶▶ Enabling Android Auto

Only initialize Android Auto when you are safely parked. When Android Auto first detects your phone, you will need to set up your phone so that auto pairing is possible. Refer to the instruction manual that came with your phone.

You can use the method below to change Android Auto settings after you have completed the initial setup:

Press the **SETTINGS** → **Select Smartphone Settings** → **Android Auto Device List**

Use of user and vehicle information

The use and handling of user and vehicle information transmitted to/from your phone by Android Auto is governed by Google's Privacy Policy.

■ Operating Android Auto with Voice Recognition

Press and hold the talk button to operate Android Auto with your voice.



▶▶ Operating Android Auto with Voice Recognition

Below are examples of commands you can give with voice recognition:



- Reply to text.
- Call my wife.
- Navigate to Acura.
- Play my music.
- Send a text message to my wife.
- Call flower shop.

For more information, please refer to the Android Auto homepage.

You can also activate the voice recognition function by moving .

CD Player

If a disc error occurs, you may see the following error messages.

| Error Message | Cause | Solution |
|--|---------------------------------|---|
| This function is not available because the system has encountered a file error or a DRM protected file. | Track/file format not supported | <ul style="list-style-type: none"> • Current track/file will be skipped. The next supported track/file plays automatically. |
| This is a bad disc. Please see your owner's manual for more details. Push Eject. | Mechanical error | <ul style="list-style-type: none"> • Press the  (eject) button and remove the disc, and check that the error message is cleared. • Check that the disc is not damaged or deformed, and insert the disc again. <ul style="list-style-type: none"> ➤ Protecting CDs P. 275 |
| Mecha Error | | |
| This is a bad disc. Please see your owner's manual for more details. | Servo error | <ul style="list-style-type: none"> • If the error message reappears, press the  button, and pull out the disc. • Insert a different disc. If the new disc plays, there is a problem with the first disc. • If the error message repeats, or the disc cannot be removed, contact a dealer. Do not try to force the disc out of the player. |
| Check the disc | Disc error | <ul style="list-style-type: none"> • Check that the disc is not damaged or deformed. <ul style="list-style-type: none"> ➤ Protecting CDs P. 275 |
| Heat Error | High temperature | <ul style="list-style-type: none"> • Turn the audio system off and allow the player to cool down until the error message is cleared. |

iPod/USB Flash Drive

If an error occurs while playing an iPod or USB flash drive, you may see the following error messages. If you cannot clear the error message, contact a dealer.

| Error Message | Solution |
|--|---|
| Communication error detected. When safe, please reconnect your device. | Appears when there is a problem with the audio system. Check if the device is compatible with the audio system. |
| This USB device is incompatible. Please see your owner's manual for more details. | Appears when an incompatible device is connected. Disconnect the device. Then turn the audio system off, and turn it on again. Do not reconnect the device that caused the error. |
| This version of iOS is not supported. | Appears when an unsupported iPod is connected. If it appears when a supported iPod is connected, update the iPod software to the newer version. |
| There is an authentication error. When safe, please reconnect your device. | Appears when the system does not acknowledge the iPod. Reconnect the iPod. |
| This function is not available because the system has encountered a file error or a DRM protected file. | Appears when you select the grayed-out option on the screen while displaying the DRM or an unsupported format file. |

| Error Message | Solution |
|---|--|
| There is no data detected. When safe, please check your device and try again. | iPod Appears when the iPod is empty. USB flash drive Appears when the USB flash drive is empty or there are no MP3, WMA, or AAC files in the USB flash drive. iPod and USB flash drive Check that compatible files are stored on the device. |
| Unsupported | Appears when an unsupported device is connected. If it appears when a supported device is connected, reconnect the device. |
| USB hubs are not supported. To listen to audio, directly connect device to USB port. | Appears when the USB device is connected via the USB hubs. Disconnect the USB hubs and directly connect the device to the USB port. |

U.S. models

Pandora®

If an error occurs while playing Pandora®, you may see the following error messages.

If you cannot clear the error message, contact a dealer.

| Error Message | Solution |
|---|--|
| This USB device is incompatible. Please see your owner's manual for more details. | Appears when an incompatible device is connected. Disconnect the device. Then turn the audio system off, and turn it again. Do not reconnect the device that caused the error. |
| There is an unsupported device detected. When safe, please reconnect your device. | Appears when there is a problem with the audio system. Check if the device is compatible with the audio system. |
| No stations have been created. When safe, please create a station on the device. | |
| There is no active station. | Appears when there is no station list on the device. Use the device to create a station. |
| This PANDORA station is currently not available. Please select another station. | |
| Music licenses force us to limit the number of tracks you may skip each hour. | Appears when you try to skip a track over the predetermined number of times in an hour. |
| The system is unable to save rating. The system is unable to save bookmark. or The system is unable to skip. | Appears when the commanded operation is failed. Try again later. |
| There is no data available. | Appears when no data is available with Pandora® activated. Reboot the app and reconnect the device. |

| Error Message | Solution |
|--|--|
| The PANDORA app version on your device is not supported. When safe, please update the app and try again later. | Appears when Pandora® version is not supported. Update Pandora® to the latest version. |
| PANDORA is performing system maintenance. Please try again later. | Appears when the Pandora® server is in maintenance. Try again later. |
| The system cannot connect to PANDORA. When safe, please check your device. | Appears when Pandora® is unable to play music. Check your device. |
| The system is unable to play PANDORA. When safe, login to PANDORA. | |
| The maximum number of stations that can be created is 100. To create more, please delete one or more previously created stations. | Appears when the number of created stations reaches the limitation. Delete one or more created stations from Pandora® app on the connected device. |
| The system is unable to create a new station. Please try again. | Appears when there is a temporary error with the audio system. Try again later. |
| The system is unable to play PANDORA. Please try again later. | Appears when your connected device has network problems. Check your device. |
| When safe, please check your device. | Appears when your connected device has some kind of problem such as being out of the service area. Check that the connected device is within the service area, and then try again to play Pandora®. If the problem persists, consult a dealer. |
| The system is unable to play PANDORA. Music licensing restricts play in this area. | Appears when you try playing the Pandora® in the country where the service is not available. |

Apple CarPlay/Android Auto

If an error occurs while using the Apple CarPlay or Android Auto, you may see the following error messages. If you cannot clear the error message, contact a dealer.

| Error Message | Solution |
|--|---|
| <p>Information Screen</p> <p>A charging error has occurred with the connected device. When safe, please check the compatibility of the device and USB cable. Please see your owner's manual for more details.</p> <p>On Demand Multi-Use Display™</p> <p>This USB device is incompatible. Please see your owner's manual for more details.</p> | <p>Appears when an incompatible device is connected. Disconnect the device. Then turn the audio system off, and turn it again. Do not reconnect the device that caused the error.</p> |
| <p>Unable to start Apple CarPlay. When safe, please confirm the USB connection.</p> | <p>Appears when Apple CarPlay or Android Auto fails to recognize your device.</p> |
| <p>Unable to start Android Auto. When safe, please confirm the USB connection.</p> | <p>Check if your device is compatible with Apple CarPlay or Android Auto, or the latest version of the app is installed on your device.</p> |
| <p>Unable to start Apple CarPlay. When safe, please try again.</p> | <p>Appears when Apple CarPlay or Android Auto fails to recognize your device.</p> |
| <p>Unable to start Android Auto. When safe, please try again.</p> | <p>Reconnect your device and try again.</p> |
| <p>Unable to start Apple CarPlay with your device. Your device is connected in digital audio mode.</p> | <p>Appears when your connected device is incompatible with Apple CarPlay.</p> <p>Check if your device is compatible with Apple CarPlay.</p> |

| Error Message | Solution |
|---|---|
| This device is not compatible with Android Auto. | Appears when your connected device is incompatible with Android Auto. Check if your device is compatible with Android Auto or the latest version of the app is installed on your device. |
| Please update to the latest version of Android Auto. | Appears when your version of the Android Auto is not supported. Update Android Auto to the latest version. |
| Connection failed. Please confirm Bluetooth connection status and try again. | Appears when <i>Bluetooth</i> ® connection is failed. Check the <i>Bluetooth</i> ® connection of this audio system and your connected device. |

SiriusXM® Radio Service

Subscribing to SiriusXM® Radio

1. You need your radio ID ready before registering for subscription. To see the ID in the On Demand Multi-Use Display™, select channel up/down icons until **CH000** and the radio ID appears.
2. Have your radio ID and credit card number ready, and either call or visit the SiriusXM® website to subscribe.

Receiving SiriusXM® Radio

Switch to the SiriusXM® mode by pressing the **SOURCE** button on the steering wheel, or through the On Demand Multi-Use Display™, and stay in this mode for about 30 minutes until the service is activated. Make sure your vehicle is in an open area with good reception.

SiriusXM® Radio Display Messages

Loading...:

SiriusXM® is loading the audio or program information.

No Signal:

The signal is too weak in the current location.

Unsubscribed channel:

You are not subscribed to the channel selected.

Unavailable channel:

No such channel exists, the channel is not part of your subscription, or the artist or title information is unavailable.

Check the antenna, Disconnected antenna, Shorted antenna:

There is a problem with the SiriusXM® antenna. Contact a dealer.

Subscribing to SiriusXM® Radio

Contact Information for SiriusXM® Radio:

- U.S.: SiriusXM® Radio at www.siriusxm.com or 1-800-852-9696
- Canada: SiriusXM® Canada at www.siriusxm.ca or 1-877-438-9677

Receiving SiriusXM® Radio

The SiriusXM® satellites are in orbit over the equator; therefore, objects south of the vehicle may cause satellite reception interruptions. Satellite signals are more likely to be blocked by tall buildings and mountains the farther north you travel from the equator.

You may experience reception problems under the following circumstances:

- In a location with an obstruction to the south of your vehicle.
- In tunnels
- On the lower level of a multi-tiered road
- Large items carried on the roof rack

Recommended CDs

- Use only high-quality CD-R or CD-RW discs labeled for audio use.
- Use only CD-R or CD-RW discs on which the recordings are closed.
- Play only standard round-shaped CDs.

The CD packages or jackets should have one of these marks.



CDs with MP3, WMA or AAC files

- Some software files may not allow for audio play or text data display.
- Some versions of MP3, WMA or AAC formats may be unsupported.

Protecting CDs

Follow these precautions when handling or storing CDs:

- Store a CD in its case when it is not being played.
- When wiping a CD, use a soft clean cloth from the center to the outside edge.
- Handle a CD by its edge. Never touch either surface.
- Never insert foreign objects into the CD player.
- Keep CDs out of direct sunlight and extreme heat.
- Do not place stabilizer rings or labels on the CD.
- Avoid fingerprints, liquids, and felt-tip pens on the CD.

Recommended CDs

A Dual-disc cannot play on this audio unit. If recorded under certain conditions, a CD-R or CD-RW may not play either.

Protecting CDs

NOTICE

Do not insert a damaged CD. It may be stuck inside and damage the audio unit.

Examples:

- Bubbled, wrinkled, labeled, and excessively thick CDs

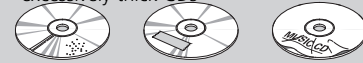

Bubbled/
Wrinkled

With Label/
Sticker

Using
Printer Label
Kit

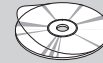

Sealed



With Plastic Ring

- Damaged CDs

- Poor quality CDs

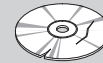

Chipped/
Cracked

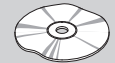

Warped

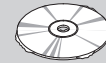

Burrs

- Small CDs



3-inch
(8-cm)
CD

Compatible iPod, iPhone, and USB Flash Drives

■ iPod and iPhone Model Compatibility

| Model |
|--|
| iPod (5th generation) |
| iPod classic 80GB/160GB (launch in 2007) |
| iPod classic 120GB (launch in 2008) |
| iPod classic 160GB (launch in 2009) |
| iPod nano (1st to 7th generation) released between 2005 and 2012 |
| iPod touch (1st to 5th generation) released between 2007 and 2012 |
| iPhone 3G/iPhone 3GS/iPhone 4/iPhone 4s/iPhone 5/iPhone 5c/iPhone 5s/iPhone 6/ iPhone 6s/iPhone 7 |

■ USB Flash Drives

- A USB flash drive of 256 MB or higher is recommended.
- Some digital audio players may not be compatible.
- Some USB flash drives (e.g., a device with security lockout) may not work.
- Some software files may not allow for audio play or text data display.
- Some versions of MP3, WMA, or AAC formats may be unsupported.

▶▶ iPod and iPhone Model Compatibility

This system may not work with all software versions of these devices.

▶▶ USB Flash Drives

Files on the USB flash drive are played in their stored order. This order may be different from the order displayed on your PC or device.

Honda App License Agreement

END USER LICENSE AGREEMENT

PLEASE CAREFULLY READ THIS END USER LICENSE AGREEMENT (THIS "AGREEMENT") WHICH GOVERNS YOUR USE OF THE SOFTWARE INSTALLED ON YOUR HONDA OR ACURA VEHICLE (YOUR "VEHICLE") AS WELL AS THE APPLICATIONS, SERVICES, FUNCTIONS, AND CONTENT PROVIDED THROUGH THE SOFTWARE (COLLECTIVELY, THE "SERVICES"). YOUR USE OF THE SOFTWARE OR SERVICES WILL SERVE AS YOUR CONSENT TO THE TERMS OF THIS AGREEMENT. THE SOFTWARE IS OWNED (OR LICENSED), PROVIDED, AND/OR OPERATED BY AMERICAN HONDA MOTOR CO. INC., ("HONDA," "US," "WE," OR "OUR"), WITH ITS BUSINESS ADDRESS AT 1919 TORRANCE BLVD., TORRANCE, CA 90501. REFERENCE TO "HONDA" IN THIS AGREEMENT INCLUDES HONDA'S PARENT COMPANY AND ITS AFFILIATES AND DESIGNATED AGENTS. THE SERVICES ARE OWNED (OR LICENSED), PROVIDED, AND/OR OPERATED BY HONDA OR A THIRD-PARTY SERVICE PROVIDER (A "PROVIDER"). REFERENCE TO A "PROVIDER" IN THIS AGREEMENT INCLUDES SUCH PROVIDER'S PARENT COMPANY, AFFILIATES, AND DESIGNATED AGENTS.

A. Description of the Software. The SOFTWARE includes the software, firmware and the like, installed and executing on your VEHICLE during manufacture, and thereafter updated from time to time by HONDA, you or an authorized HONDA dealer (a "DEALER"). The SOFTWARE allows you to access and use a variety of SERVICES, including but not limited to: (a) HONDA applications, services, and content provided through the SOFTWARE (together, "HONDA SERVICES"); and (b) PROVIDER applications, services, and content provided through the SOFTWARE (together, "PROVIDER SERVICES"), each of which may provide access to various information, media, content, and services.

B. SOFTWARE Licensing and Intellectual Property.

1. SOFTWARE. This AGREEMENT grants you a non-exclusive, limited, and revocable license to use the SOFTWARE and SERVICES solely (a) as installed on your VEHICLE by HONDA, (b) as updated on your Vehicle by HONDA, you (but only as and when directed by HONDA), or a DEALER and (c) as permitted under the terms of this AGREEMENT

2. HONDA Services. The SOFTWARE may provide you with access to various HONDA SERVICES. Installation, activation, or use of HONDA SERVICES may require your consent to additional terms, conditions, and privacy policies applicable to those HONDA SERVICES (the "HONDA TERMS"). You acknowledge and agree that any collection, use, sharing of data generated by your VEHICLE or your use of your VEHICLE, and your use of the HONDA SERVICES shall be subject to this AGREEMENT and any additional HONDA TERMS that may be specifically applicable to such HONDA SERVICES or data generation. The HONDA SERVICES may collect, use, and share such data while you are using the SOFTWARE.

3. Open-Source Software. The SOFTWARE and SERVICES may incorporate software licensed to HONDA under free or open-source licenses which govern HONDA's distribution and your use of such software. HONDA and the third-party authors, licensors, and distributors of such software disclaim all warranties and all liability arising from any and all use or distribution of the software. To the extent such software is provided under terms that differ from the applicable free or open-source licenses, those terms are offered by HONDA alone. Additional information regarding free and open-source software incorporated in the SOFTWARE and SERVICES is available in this manual or within the SOFTWARE.

4. Provider Services. The SOFTWARE may provide you with access to various PROVIDER SERVICES. Installation or use of such PROVIDER SERVICES may require your consent to additional terms, conditions, and privacy policies of the applicable PROVIDER (the "PROVIDER TERMS"). This AGREEMENT restricts the manner in which you can install and use PROVIDER SERVICES but does not grant you a license or permission to use such PROVIDER SERVICES. Your permission to use PROVIDER SERVICES is limited and subject to any license grants, conditions, and limitations included in the PROVIDER TERMS. You acknowledge that any collection, use, sharing of your information, targeted advertising practices by PROVIDERS, and your use of the PROVIDER SERVICES shall be subject to both this AGREEMENT and any applicable PROVIDER TERMS. The PROVIDER SERVICES may collect, use, and share such information while you are using the SOFTWARE.

5. License Limitations and Restrictions on Use.

(a) Limited License. You understand and agree that the SOFTWARE and SERVICES are licensed, not sold, to you solely for use in accordance with this AGREEMENT and any applicable PROVIDER TERMS, and any documentation for the VEHICLE made available to you by HONDA (any "DOCUMENTATION"). HONDA and its licensors reserve all rights in the SOFTWARE and HONDA SERVICES not expressly granted to you under this AGREEMENT. PROVIDERS and their licensors reserve all rights in the PROVIDER SERVICES not expressly granted to you under the applicable PROVIDER TERMS.

(b) Restrictions on Use. The licenses granted under this AGREEMENT do not permit you to use the SOFTWARE or SERVICES on a device other than your VEHICLE. As a condition of using the SOFTWARE and SERVICES, you agree that you may not and will not:

- (1) copy, download, distribute, modify, publish, sell, rent, lease, lend, license, sublicense, reuse, or create derivative works of the SOFTWARE or SERVICES or any of the content or other material within the SOFTWARE or SERVICES, including without limitation, HONDA or PROVIDER names, logos, or any other trademarks of HONDA or PROVIDERS or used in association with the SOFTWARE or any SERVICES, except as required to use the SOFTWARE or SERVICES in accordance with this AGREEMENT, any applicable PROVIDER TERMS, and the DOCUMENTATION;
- (2) access or use the SOFTWARE or SERVICES in any manner intended to damage or impair the operation of the SOFTWARE or SERVICES or interfere with anyone else's use and enjoyment of the SOFTWARE or SERVICES;
- (3) access or attempt to access any system or server on which the SOFTWARE or SERVICES is hosted or modify or alter the SOFTWARE or SERVICES in any way;
- (4) use the SOFTWARE or SERVICES for any unlawful purpose, or in violation of any third party rights;
- (5) use the SOFTWARE or SERVICES in violation of any applicable traffic regulations, rules or laws, including but not limited to any driver distraction laws, rules or regulations;
- (6) violate the terms of this AGREEMENT, any HONDA TERMS, any PROVIDER TERMS or other applicable third-party terms, conditions, and privacy policies; or
- (7) reverse engineer, decompile, disassemble, attempt to derive the source code of, nor permit others to reverse engineer, decompile, or disassemble, or attempt to derive the source code of the SOFTWARE or SERVICES, except and only to the extent that such activity is expressly permitted (a) by applicable law notwithstanding this limitation or (b) the terms of applicable free or opensource software licenses.

6. Intellectual Property Rights. All title and intellectual property rights in and to the SOFTWARE and SERVICES, the accompanying DOCUMENTATION, and all copies of the SOFTWARE or SERVICES are owned by HONDA, PROVIDERS, or their suppliers or licensors. This AGREEMENT does not grant you any rights in connection with any trademarks or service marks of HONDA, PROVIDERS, or their licensors, affiliates, or suppliers.

7. Export Restrictions: You acknowledge that the SOFTWARE and SERVICES are subject to U.S., European Union, and other export jurisdictions. You agree to comply with all applicable international and national laws that apply to the SOFTWARE and SERVICES, including the U.S. Export Administration Regulations, as well as end-user, end-use, and destination restrictions issued by the U.S. and other governments.

C. SOFTWARE Operation

1. HONDA reserves the right to suspend or terminate your access to and use of the SOFTWARE or SERVICES if you are found to be in violation of this AGREEMENT or as reasonably deemed necessary by HONDA.

2. Eligibility/Registration/Activation. The SOFTWARE is intended for and available to individuals who (a) are of legal age of majority in their jurisdiction of residence (and at least 18 years of age), or are younger than 18 years of age and possess a valid driver's license issued by their jurisdiction of residence, and (b) own or have permissive access to a compatible VEHICLE. We do not knowingly collect any information, including personal information, from children under 13. If we learn or are notified that we have collected personal information of a child under 13, we will immediately take steps to delete such information.

3. Use of PROVIDER SERVICES through the SOFTWARE. Certain PROVIDER SERVICES made available through the SOFTWARE may require that you register or otherwise have an account with the PROVIDER and agree to PROVIDER TERMS. Any use of any of such PROVIDER SERVICES within the SOFTWARE is subject to this AGREEMENT and the applicable PROVIDER TERMS. HONDA does not exercise control over such PROVIDER SERVICES and is not responsible or liable for the availability, security, or content of such PROVIDER SERVICES, and the inclusion of any PROVIDER SERVICES does not imply a referral from, the approval of, or the endorsement by HONDA of such PROVIDER SERVICES. HONDA is not responsible or liable, directly or indirectly, for any damage relating to or resulting from your use of the PROVIDER SERVICES.

4. Links to Third Party Sites: The SOFTWARE may provide you with the ability to access third-party sites and content through the use of the SOFTWARE or SERVICES. The third-party sites and content are not under the control of HONDA. HONDA is not responsible or liable, directly or indirectly, for such third-party websites and their content or for any damage relating to or resulting from your access or use of such websites and content.

5. Unauthorized Use and Abuse. You are responsible for ensuring your (and any authorized third parties') use of the SOFTWARE and SERVICES remains in compliance with this AGREEMENT and all other applicable HONDA TERMS and PROVIDER TERMS. You acknowledge and agree that any use of the SOFTWARE or SERVICES occurring through your VEHICLE will be deemed your actions and that HONDA and PROVIDERS may rely upon such actions. You agree to immediately notify us if you suspect fraudulent or abusive activity involving the SOFTWARE or SERVICES. If you so notify us or if we otherwise suspect fraudulent or abusive activity, you agree to cooperate with us in any fraud investigation and to use any fraud prevention measures we prescribe. Your failure to immediately notify us or cooperate to use such measures will result in your liability for all fraudulent usage or abusive activity associated with your VEHICLE.

6. SOFTWARE Updates. The SOFTWARE and SERVICES may be updated when your VEHICLE is serviced by a DEALER or remotely, over-the-air, by HONDA from time to time; such updates may occur with or without further notice or your future consent. The SOFTWARE may be updated at HONDA's discretion and for any purpose including, without limitation, to patch or otherwise improve the SOFTWARE or SERVICES functionality, security, or stability. All updates to the SOFTWARE and SERVICES are subject to this AGREEMENT and any other applicable HONDA TERMS and PROVIDER TERMS.

7. Uninstalling, Removing, and Replacing the SOFTWARE. Replacing SOFTWARE or HONDA SERVICES with software or firmware not provided and installed by HONDA or a DEALER will render all representations and warranties for the SOFTWARE, HONDA SERVICES, and VEHICLE functionality reliant upon the SOFTWARE or HONDA SERVICES null and void.

D. SOFTWARE Operational Notices and Warnings

1. Vehicle Geolocation Information. You acknowledge that your VEHICLE may be equipped with certain traffic and map features. The traffic feature will automatically collect and transmit, through GPS technology, your Vehicle's current location (longitude and latitude), travel direction and speed ("VEHICLE GEOLOCATION INFORMATION") to HONDA and PROVIDERS. The VEHICLE GEOLOCATION INFORMATION is used by HONDA and PROVIDERS to provide traffic and navigation-related information to you, but may also be used to provide other SERVICES or offers to you. HONDA will not use such VEHICLE GEOLOCATION INFORMATION for its own marketing efforts, or provide such information to unaffiliated third parties for their own purposes, without your express consent.

2. Potential Map Inaccuracy and Route Safety. Maps used by this system may be inaccurate because of changes in roads, traffic controls, routing, or driving conditions. Always use good judgment and common sense when following suggested routes. Do not follow the route suggestions if doing so would result in an unsafe or illegal driving maneuver, if you would be placed in an unsafe situation, or if you would be directed into an area that you consider unsafe. Do not rely on any navigation features included in the system to route you to emergency services. Not all emergency services such as police, fire stations, hospitals, or clinics are likely to be contained in the map database for such navigation features. Ask local authorities or an emergency services operator for such locations and routes. The driver is ultimately responsible for the safe operation of the vehicle and therefore, must evaluate whether it is safe to follow the suggested directions. Any navigation features are provided only as an aid. Make your driving decisions based on your observations of local conditions and existing traffic regulations. Navigation features are not a substitute for your personal judgment. Any route suggestions made by the SOFTWARE or SERVICES should never replace any local traffic regulations or your personal judgment or knowledge of safe driving practices.

3. Speech Recognition: You acknowledge and understand that HONDA and PROVIDERS may record, retain, and use voices commands when you use the speech recognition components of the SOFTWARE or SERVICES. You and all VEHICLE operators and passengers (a) consent to the recording and retention of voice commands in support of providing speech recognition components and (b) release HONDA and PROVIDERS from all claims, liabilities, and losses that may result from any use of such recorded voice commands. Recognition errors are inherent in speech recognition. It is your responsibility to monitor any speech recognition functions included in the system and address any errors. Neither HONDA nor PROVIDERS will be liable for any damages arising out of errors in the speech recognition process.

4. Distraction Hazards. Navigation features may require manual (non-verbal) input or setup. Attempting to perform such set-up or insert data while driving can seriously distract your attention and could cause a crash or other serious consequences; the ability to undertake such interactions may also be limited by state or local law, which laws you are responsible to know and follow. Even occasional short scans of the screen may be hazardous if your attention has been diverted away from your driving at a critical time. Pull over and stop the vehicle in a safe and legal manner before attempting to access a function of the system requiring prolonged attention. Do not raise the volume excessively. Keep the volume at a level where you can still hear outside traffic and emergency signals while driving. Driving while unable to hear these sounds could result in a crash.

E. Information Collection and Storage

1. Information Collection, Use, Transmission and Storage of Data. Consent to Use of Data: You agree that HONDA and PROVIDERS may collect and use your information gathered in any manner as part of product support services related to the SOFTWARE or related services. HONDA may share such information with third parties, including, without limitation, PROVIDERS, third party software and services suppliers, their affiliates and/or their designated agents, solely to improve their products or to provide services or technologies to you. HONDA, third party software and systems suppliers, their affiliates and/or their designated agent may disclose this information to others, but not in a form that personally identifies you.

2. Information Storage. Depending on the type of multimedia system you have in your VEHICLE, certain information may be stored for ease of use of the SOFTWARE including, without limitation, search history, location history in certain applications, previous and saved destinations, map locations within certain applications, and device numbers and contact information.

(a) Vehicle Health Information. Your VEHICLE may remotely transmit information regarding the status and health of your VEHICLE (“VEHICLE INFORMATION”) to HONDA without notification to you. VEHICLE INFORMATION may contain VEHICLE maintenance and malfunction status that is derived from VEHICLE diagnostic data and includes, but is not limited to, status of powered doors and windows, battery life data, battery charging data, VEHICLE speed, coolant temperature, air compressor revolution, output power, warning codes, diagnostic trouble codes, fuel injection volume, and engine rotations per minute. VEHICLE HEALTH INFORMATION may be used by HONDA for research and development, to deliver HONDA SERVICES and information to you, and to contact you, and is retained only for a period of time necessary to fulfill these goals.

(b) VEHICLE Geolocation Data (non-navigation/map based). If you opt-in to geolocation-based SERVICES, your vehicle’s geolocation data (latitude and longitude) will be automatically sent from your VEHICLE to HONDA and PROVIDERS.

(c) You understand that the inputting or uploading of information to your VEHICLE’s multimedia system or the SOFTWARE or SERVICES is at your own risk and that HONDA is not responsible for unauthorized access to or use of any personal or other information. All information uploaded to the SOFTWARE and SERVICES may be stored on your VEHICLES’s multimedia system and you understand that the security and safety of your VEHICLE’s multimedia system is your sole responsibility.

F. NO WARRANTY. You understand and agree that your use of the SOFTWARE and SERVICES are solely at your own risk and that you will be solely responsible for any damage to your VEHICLE's multimedia system or any other equipment or any loss of data that may result from your use of the SOFTWARE or SERVICES. THE SOFTWARE AND SERVICES ARE PROVIDED ON AN "AS IS" AND "AS AVAILABLE" BASIS WITHOUT ANY WARRANTY OF ANY KIND, EXPRESSED, IMPLIED OR STATUTORY. WE SPECIFICALLY DISCLAIM ANY IMPLIED WARRANTIES OF MERCHANTABILITY, FITNESS FOR A PARTICULAR PURPOSE, AND NON-INFRINGEMENT. HONDA makes no warranties that the SOFTWARE or SERVICES will meet your requirements, or that the SOFTWARE or SERVICES will be uninterrupted, timely, secure, non-infringing or error free. You understand and agree that you are responsible for any and all charges, costs or expenses associated with your use of the SOFTWARE or SERVICES. Advice or information, whether oral or written, obtained by you from us or through the SOFTWARE or SERVICES are provided for informational purposes only and will not create any warranty not expressly made herein. You should not rely on any such information or advice. We assume no liability or responsibility for any errors or omissions in the SOFTWARE or SERVICES. We do not make any warranty or representation that your use of the material displayed on, or obtained through, the SOFTWARE or SERVICES is non-infringing of any rights of any third party. Any decision or action taken by you on the basis of information or content provided via the application is at your sole discretion and risk. HONDA and PROVIDERS are not responsible or liable for any such decision, or for the accuracy, completeness, usefulness, or availability of any content or information displayed, transmitted, or otherwise made available via the SOFTWARE or SERVICES. To the extent jurisdictions do not allow the exclusion of certain warranties, some of the above exclusions may not apply to you.

G. LIMITATIONS ON LIABILITY. You and HONDA are each waiving important rights.

1. Limitations on YOUR liability. HONDA cannot recover from you any consequential, indirect, incidental, or special damages, or attorney's fees in connection with your use of the SOFTWARE or HONDA SERVICES. HONDA WAIVES TO THE FULLEST EXTENT ALLOWED BY LAW ANY CLAIM FOR DAMAGES OTHER THAN DIRECT, COMPENSATORY DAMAGES AS LIMITED IN THIS AGREEMENT.

2. Limitation on HONDA and PROVIDER liability. Neither HONDA nor PROVIDERS will be liable to you or any other party for consequential, indirect, incidental, special, or punitive damages (including without limitation lost profits) in connection with your use of the SOFTWARE or SERVICES, even if HONDA or PROVIDERS are aware of the possibility of such damages. These limitations apply to all claims, including, without limitation, claims in contract and tort (such as negligence, product liability and strict liability). To the extent that a jurisdiction does not permit the exclusion or limitation of liability as set forth herein our liability is limited to the maximum extent permitted by law in such states. If HONDA or PROVIDERS are found liable to you for any reason, you agree that the aggregate liability of all these parties to you for any claim is limited to ten U.S. dollars (US \$10.00). Neither HONDA nor any PROVIDER would have agreed to provide the SOFTWARE or SERVICES to you if you did not agree to this limitation. This amount is the sole and exclusive liability of HONDA and PROVIDERS to you, and is payable as liquidated damages and not as a penalty. Except where prohibited by law, you may not bring any claim against HONDA or any third-party beneficiary more than two (2) years after the claim arises. We do not have any liability for SOFTWARE or SERVICES interruptions of any length.

(a) **Release of HONDA and PROVIDERS** For yourself and anyone else claiming under you, you agree to release and discharge HONDA, PROVIDERS, their respective officers, directors, and employees, and each third-party beneficiary from all claims, liabilities and losses in connection with the SOFTWARE or SERVICES, including, but not limited to claims for personal injury or property damage arising from the total or partial failure of performance of the SOFTWARE or SERVICES, even if caused by or based upon the negligence, gross negligence, strict products liability, Deceptive Trade Practices Act violations, bad faith, or breach of warranty of us or the malfunction of the SOFTWARE or SOFTWARE SERVICES. YOU AGREE TO WAIVE TO THE FULLEST EXTENT ALLOWED BY LAW, ANY CLAIM FOR DAMAGES OTHER THAN DIRECT, COMPENSATORY DAMAGES AS LIMITED IN THIS AGREEMENT. YOU HEREBY RELEASE AND DISCHARGE HONDA AND ITS LICENSORS AND CONTRACTORS (INCLUDING ANY THIRD PARTIES PROVIDING ALL OR PART OF THE SOFTWARE OR SERVICES) FROM AND AGAINST ANY CLAIMS, DAMAGES, EXPENSES AND LIABILITY ARISING FROM OR RELATED TO ANY INJURIES, DAMAGES, OR LOSSES TO ANY PERSON (INCLUDING DEATH) OR PROPERTY OF ANY KIND RESULTING IN WHOLE OR PART, DIRECTLY OR INDIRECTLY, FROM YOUR USE OF THE SOFTWARE OR SERVICES.

H. Survival. You agree that the limitations of liability and indemnities in this AGREEMENT will survive even after the AGREEMENT has ended. These limitations of liability apply not only to you, but to anyone using the SOFTWARE or SERVICES via your VEHICLE, to anyone making a claim on your behalf, and to any claims made by your family, employees, customers, or others arising out of or relating to your VEHICLE, the SOFTWARE, or SERVICES.

I. Availability/Interruption. The SOFTWARE and certain SERVICES are made available through your VEHICLE's compatible multimedia system when the VEHICLE is turned on. Certain SERVICES may be available only through your compatible mobile device when it is within the operating range of the VEHICLE and a wireless carrier. The availability of the SOFTWARE and SERVICES may be subject to transmission limitation or interruption, including but not limited to technical obsolescence or sunset of the hardware, software or firmware, inside of or external to the Vehicle, required for data transmission or receipt. HONDA does not guarantee that the SOFTWARE, SERVICES, or any portion thereof will be available at all times or in all areas. You acknowledge and agree that HONDA is not responsible for performance degradation, interruption or delays. You acknowledge that HONDA shall not be liable to you if the SOFTWARE or SERVICES in a given location are not available. If the SOFTWARE or SERVICES are not available within your intended location, you agree that your sole remedy shall be to cease using the SOFTWARE and SERVICES.

J. PRODUCT SUPPORT: Product support for the SOFTWARE is provided by HONDA. For product support, please refer to HONDA instructions provided in the DOCUMENTATION. Should you have any questions concerning this AGREEMENT, or if you desire to contact HONDA for any other reason, please refer to the HONDA contact information provided in the DOCUMENTATION.

K. Termination and Transfer.

1. Termination. This AGREEMENT is effective until terminated by you or US. WE may terminate this AGREEMENT for any or no reason, and with or without notice to you. Your rights under this AGREEMENT will terminate automatically without notice from US if you fail to comply with any term of this AGREEMENT. Upon termination of this AGREEMENT, you shall cease all use of the SOFTWARE and SERVICES.

2. Transfer: You may permanently transfer your rights under this AGREEMENT only as part of a sale or transfer of the VEHICLE, provided you retain no copies, you transfer all of the SOFTWARE and HONDA SERVICES (including all component parts, the media and printed materials, and any upgrades), and the recipient agrees to the terms of this AGREEMENT. You agree to notify HONDA upon the sale or transfer of the VEHICLE. To contact HONDA, please refer to the HONDA contact information provided in the DOCUMENTATION.

L. Changes to the SOFTWARE or SERVICES. WE may change, modify, or update the SOFTWARE or SERVICES from time to time. Unless explicitly stated otherwise, any new features or services that augment or enhance the SOFTWARE or SERVICES in the future shall respectively be considered part of the SOFTWARE or SERVICES and subject to this AGREEMENT. WE reserve the right at any time and from time to time to interrupt, restrict, modify, suspend, discontinue, temporarily or permanently, the SOFTWARE or SERVICES (or any portion thereof), with or without notice to you, and you agree that HONDA shall not be liable to you or to any third party for any modification, suspension or discontinuance of the SOFTWARE or SERVICES.

M. ARBITRATION:

PLEASE READ THIS ARBITRATION PROVISION CAREFULLY TO UNDERSTAND YOUR RIGHTS. YOU AGREE THAT ANY CLAIM THAT YOU MAY HAVE IN THE FUTURE MUST BE RESOLVED THROUGH BINDING ARBITRATION. YOU WAIVE THE RIGHT TO HAVE YOUR DISPUTE HEARD IN COURT AND WAIVE THE RIGHT TO BRING CLASS CLAIMS. YOU UNDERSTAND THAT DISCOVERY AND APPEAL RIGHTS ARE MORE LIMITED IN ARBITRATION.

Arbitration is a method of resolving a claim, dispute or controversy without filing a lawsuit. By agreeing to arbitrate, the right to go to court is waived and instead claims, disputes or controversies are submitted to binding arbitration. This provision sets forth the terms and conditions of our agreement. YOU and HONDA agree and acknowledge that this Agreement affects interstate commerce and the Federal Arbitration Act ("FAA") applies. By using the Software, Vehicle, or Services, YOU elect to have disputes resolved by arbitration. YOU, HONDA or any involved third party may pursue a Claim. "Claim" means any dispute between YOU, HONDA, or any involved third party relating to your use of the Software, the Vehicle, or the Services, this Agreement, or our relationship, including any representations, omissions or warranties. "Claim" does not include personal injury or wrongful death claims. YOU or HONDA may seek remedies in small claims court or provisional judicial remedies without arbitrating. In addition, notwithstanding anything herein to the contrary, YOU or HONDA may seek equitable relief in a court of competent jurisdiction..

YOU or HONDA may select arbitration with American Arbitration Association, JAMS or National Arbitration and Mediation. Contact these sponsors for their rules. The hearing will be in the federal district where YOU reside. If agreed, it may be by telephone or written submissions. Filing and arbitrator fees to be paid per the sponsor rules. You may contact the sponsor for a fee waiver. If no fee waivers, HONDA will pay filing and arbitrator fees up to \$5,000, unless law requires more. Each party is responsible for other fees. Arbitrator may award costs or fees to prevailing party, if permitted by law. HONDA will not seek fees, unless the claims are frivolous.

Arbitrator shall be an attorney or current or retired judge familiar with automotive or consumer software. The arbitrator shall follow substantive law, statute of limitations and decide all issues relating to the interpretation, construction, enforceability and applicability of this provision. The arbitrator may order relief permitted by law. This provision is governed and enforceable by the FAA. An award shall include a written opinion and be final, subject to appeal by the FAA.

This provision survives termination of this Agreement or relationship, bankruptcy, assignment or transfer. If part of this provision is unenforceable, the remainder remains in effect. If unenforceability allows arbitration as a class action, then this provision is entirely unenforceable. YOU may opt out within 30 days of your initial use of the Software by sending a signed, written notice to HONDA at Honda Financial Services, P.O. Box 165007, Irving, TX 75016. HONDA reserves the right to make changes to this provision after providing written notice and an opportunity to opt out.

N. Miscellaneous: You may not assign this AGREEMENT without HONDA's prior written consent. This AGREEMENT and any additional HONDA TERMS and PROVIDER TERMS represents the entire agreement between you and US. HONDA may amend the terms of this AGREEMENT by providing you with notices of such updated terms. If you do not consent to be bound by the updated terms, your sole remedy will be to cease using the SOFTWARE and SERVICES. If any part of this AGREEMENT is found invalid, void, or unenforceable, the balance of the AGREEMENT will remain valid and enforceable according to its terms. To the fullest extent permitted by law, and except as explicitly provided otherwise, this AGREEMENT and any disputes arising out of or relating to it will be governed by the laws of the State of California, except that California laws concerning choice of law or conflicts shall not apply if they would cause the substantive law of another jurisdiction to apply. Notwithstanding, Section M shall be governed by the Federal Arbitration Act and the laws of the State of California, as applicable, as set forth therein. The failure to enforce any term of this AGREEMENT on one occasion shall not prevent enforcement on any other occasion or the enforcement of any other term. Headings and captions shall not be considered included for purposes of interpretation or application hereof, but are for convenience only.

Legal Information on Apple CarPlay/Android Auto

■ OWNER'S MANUAL LICENSE/LIABILITY STATEMENTS

USE OF APPLE CARPLAY IS SUBJECT TO YOUR AGREEMENT TO THE CARPLAY TERMS OF USE, WHICH ARE INCLUDED AS PART OF THE APPLE iOS TERMS OF USE. IN SUMMARY, THE CARPLAY TERMS OF USE DISCLAIM APPLE AND ITS SERVICE PROVIDERS' LIABILITY IF THE SERVICES FAIL TO PERFORM CORRECTLY OR ARE DISCONTINUED, STRICTLY LIMIT APPLE AND ITS SERVICE PROVIDERS' OTHER LIABILITIES, DESCRIBE THE KINDS OF USER INFORMATION (INCLUDING, FOR EXAMPLE, VEHICLE LOCATION, VEHICLE SPEED, AND VEHICLE STATUS) BEING GATHERED AND STORED BY APPLE AND ITS SERVICE PROVIDERS, AND DISCLOSE CERTAIN POSSIBLE RISKS ASSOCIATED WITH THE USE OF CARPLAY, INCLUDING THE POTENTIAL FOR DRIVER DISTRACTION. SEE APPLE'S PRIVACY POLICY FOR DETAILS REGARDING APPLE'S USE AND HANDLING OF DATA UPLOADED BY CARPLAY.

USE OF ANDROID AUTO IS SUBJECT TO YOUR AGREEMENT TO THE ANDROID AUTO TERMS OF USE WHICH MUST BE AGREED TO WHEN THE ANDROID AUTO APPLICATION IS DOWNLOADED TO YOUR ANDROID PHONE. IN SUMMARY, THE ANDROID AUTO TERMS OF USE DISCLAIM GOOGLE AND ITS SERVICE PROVIDERS' LIABILITY IF THE SERVICES FAIL TO PERFORM CORRECTLY OR ARE DISCONTINUED, STRICTLY LIMIT GOOGLE AND ITS SERVICE PROVIDERS' OTHER LIABILITIES, DESCRIBE THE KINDS OF USER INFORMATION (INCLUDING, FOR EXAMPLE, VEHICLE LOCATION, VEHICLE SPEED, AND VEHICLE STATUS) BEING GATHERED AND STORED BY GOOGLE AND ITS SERVICE PROVIDERS, AND DISCLOSE CERTAIN POSSIBLE RISKS ASSOCIATED WITH THE USE OF ANDROID AUTO, INCLUDING THE POTENTIAL FOR DRIVER DISTRACTION. SEE GOOGLE'S PRIVACY POLICY FOR DETAILS REGARDING GOOGLE'S USE AND HANDLING OF DATA UPLOADED BY ANDROID AUTO.

DISCLAIMER OF WARRANTIES; LIMITATION ON LIABILITY

YOU EXPRESSLY ACKNOWLEDGE AND AGREE THAT USE OF APPLE CARPLAY OR ANDROID AUTO (“THE APPLICATIONS”) IS AT YOUR SOLE RISK AND THAT THE ENTIRE RISK AS TO SATISFACTORY QUALITY, PERFORMANCE, ACCURACY AND EFFORT IS WITH YOU TO THE MAXIMUM EXTENT PERMITTED BY APPLICABLE LAW, AND THAT THE APPLICATIONS AND INFORMATION ON THE APPLICATIONS IS PROVIDED “AS IS” AND “AS AVAILABLE,” WITH ALL FAULTS AND WITHOUT WARRANTY OF ANY KIND, AND HONDA HEREBY DISCLAIMS ALL WARRANTIES AND CONDITIONS WITH RESPECT TO THE APPLICATIONS AND INFORMATION ON THE APPLICATIONS, EITHER EXPRESS, IMPLIED OR STATUTORY, INCLUDING, BUT NOT LIMITED TO, THE IMPLIED WARRANTIES AND/OR CONDITIONS OF MERCHANTABILITY, SATISFACTORY QUALITY, FITNESS FOR A PARTICULAR PURPOSE, ACCURACY, QUIET ENJOYMENT, AND NON-INFRINGEMENT OF THIRD PARTY RIGHTS. NO ORAL OR WRITTEN INFORMATION OR ADVICE GIVEN BY HONDA OR AN AUTHORIZED REPRESENTATIVE SHALL CREATE A WARRANTY. AS EXAMPLES, AND WITHOUT LIMITATION, HONDA DISCLAIMS ANY WARRANTY REGARDING THE ACCURACY OF DATA PROVIDED BY THE APPLICATIONS, SUCH AS THE ACCURACY OF DIRECTIONS, ESTIMATED TRAVEL TIME, SPEED LIMITS, ROAD CONDITIONS, NEWS, WEATHER, TRAFFIC, OR OTHER CONTENT PROVIDED BY APPLE, GOOGLE, THEIR AFFILIATES, OR THIRD PARTY PROVIDERS; HONDA DOES NOT GUARANTEE AGAINST LOSS OF APPLICATION DATA, WHICH MAY BE LOST AT ANY TIME; HONDA DOES NOT GUARANTEE THAT THE APPLICATIONS OR ANY SERVICES PROVIDED THROUGH THEM WILL BE PROVIDED AT ALL TIMES OR THAT ANY OR ALL SERVICES WILL BE AVAILABLE AT ANY PARTICULAR TIME OR LOCATION. FOR EXAMPLE, SERVICES MAY BE SUSPENDED OR INTERRUPTED WITHOUT NOTICE FOR REPAIR, MAINTENANCE, SECURITY FIXES, UPDATES, ETC., SERVICES MAY BE UNAVAILABLE IN YOUR AREA OR LOCATION, ETC. IN ADDITION, YOU UNDERSTAND THAT CHANGES IN THIRD PARTY TECHNOLOGY OR GOVERNMENT REGULATION MAY RENDER THE SERVICES AND/OR APPLICATIONS OBSOLETE AND/OR UNUSABLE.

TO THE EXTENT NOT PROHIBITED BY LAW, IN NO EVENT SHALL HONDA OR ITS AFFILIATES BE LIABLE FOR PERSONAL INJURY, OR ANY INCIDENTAL, SPECIAL, INDIRECT OR CONSEQUENTIAL DAMAGES WHATSOEVER, INCLUDING, WITHOUT LIMITATION, DAMAGES FOR LOSS OF PROFITS, CORRUPTION OR LOSS OF DATA, FAILURE TO TRANSMIT OR RECEIVE ANY DATA, BUSINESS INTERRUPTION OR ANY OTHER COMMERCIAL DAMAGES OR LOSSES, ARISING OUT OF OR RELATED TO THE APPLICATIONS OR YOUR USE OF OR INABILITY TO USE THE APPLICATIONS OR INFORMATION ON THE APPLICATIONS, HOWEVER CAUSED, REGARDLESS OF THE THEORY OF LIABILITY (CONTRACT, TORT OR OTHERWISE) AND EVEN IF HONDA WERE ADVISED OF THE POSSIBILITY OF SUCH DAMAGES. SOME STATES AND JURISDICTIONS DISALLOW THE EXCLUSION OR LIMITATION OF LIABILITY FOR DAMAGES, SO THESE LIMITATIONS AND EXCLUSIONS MAY NOT APPLY TO YOU. IN NO EVENT SHALL HONDA’S TOTAL LIABILITY TO YOU FOR ALL DAMAGES (OTHER THAN AS MAY BE REQUIRED BY APPLICABLE LAW IN CASES INVOLVING PERSONAL INJURY) EXCEED THE AMOUNT OF FIVE DOLLARS (\$5.00). THE FOREGOING LIMITATIONS WILL APPLY EVEN IF THE ABOVE STATED REMEDY FAILS OF ITS ESSENTIAL PURPOSE.

About Open Source Licenses

■ Important information on the software

About the software license of the product

The software installed in the product contains open source software.

See the following Alpine website for details on the open source software.

<http://www.alpine.com/h/e/oss/download/>

Models with navigation system



See the Navigation System Manual for the customized features except for the **Vehicle Settings**.

Models without navigation system

Use the information screen and On Demand Multi-Use Display™ to customize certain features.

Information Screen

■ How to customize



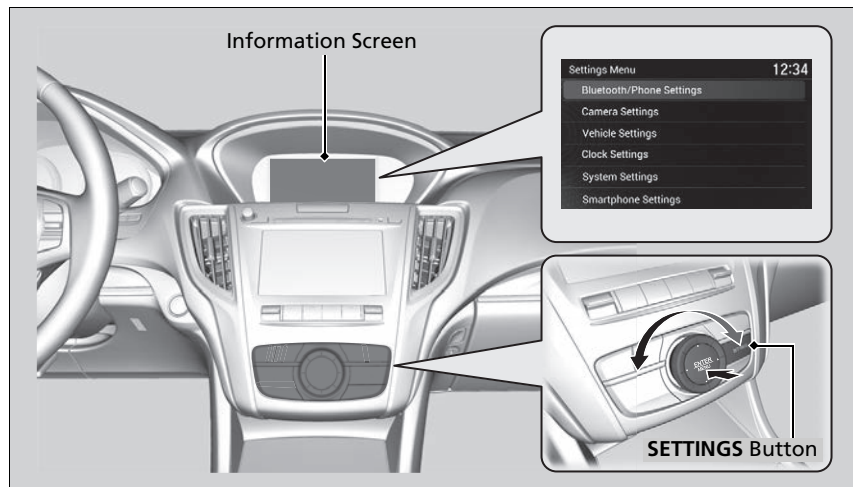



Select your desired setting item by pressing the **SETTINGS** button, then rotating  while the power mode is ON and the vehicle is at a complete stop. Press .



Customized Features

When you customize settings, make sure that the vehicle is at a complete stop and shift to **P**.

Information Screen

To customize other features, rotate , move , , , or , and press .

 **List of customizable options** P. 297

How to customize

The following settings can be customized on the On Demand Multi-Use Display™.

- **Edit Source Order**
- **Sound Settings**
- **Audio Settings**
- **Screen Settings**

 **How to customize** P. 309

Information Screen

■ Customization flow

Press the **SETTINGS** button.

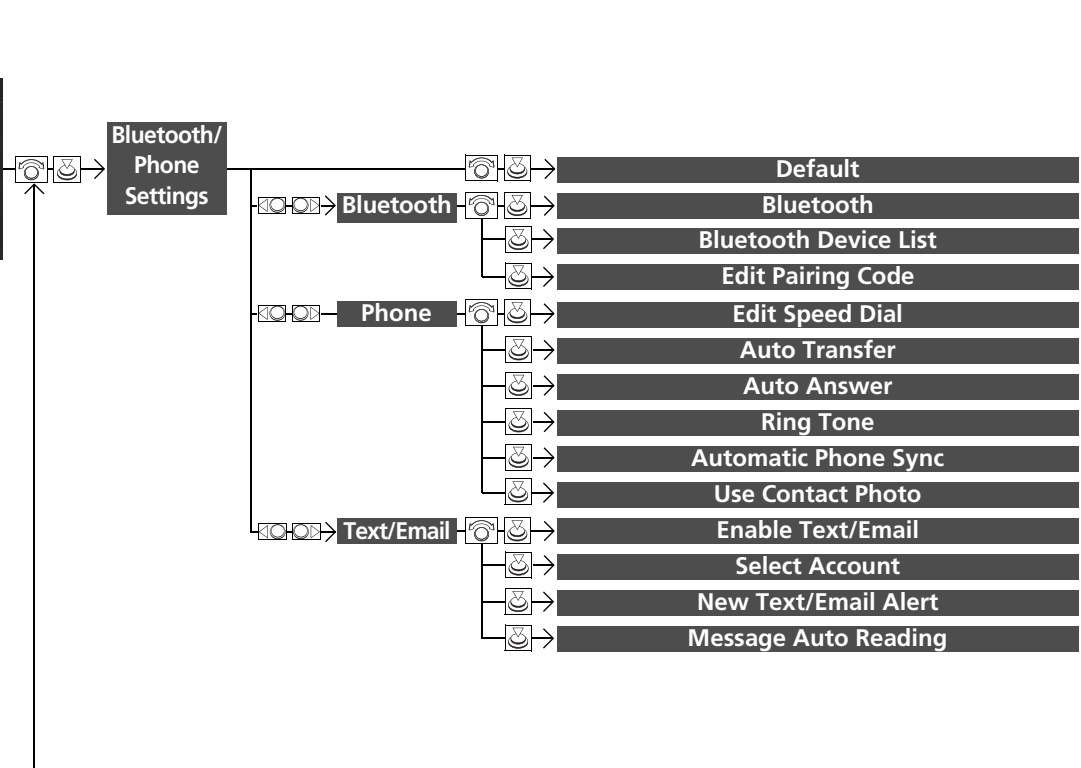
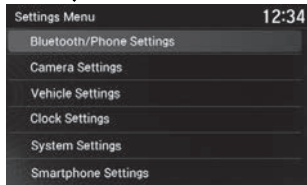

Features

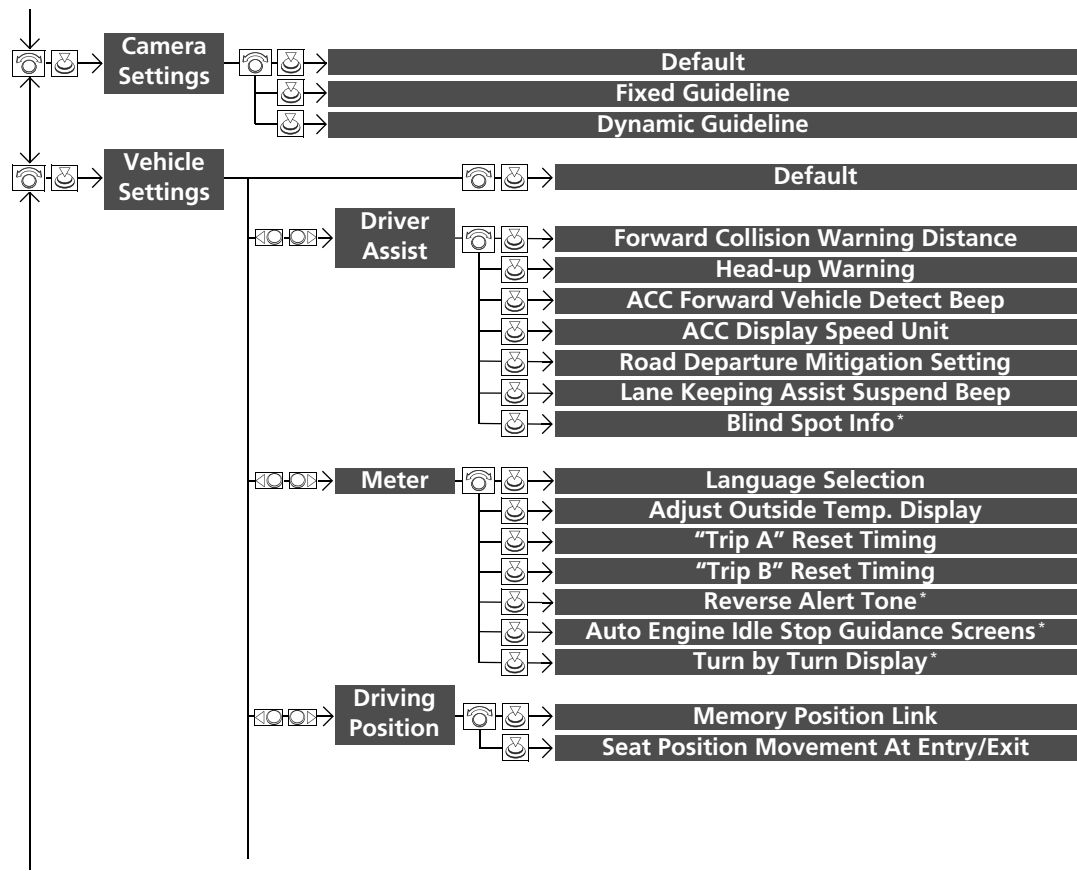

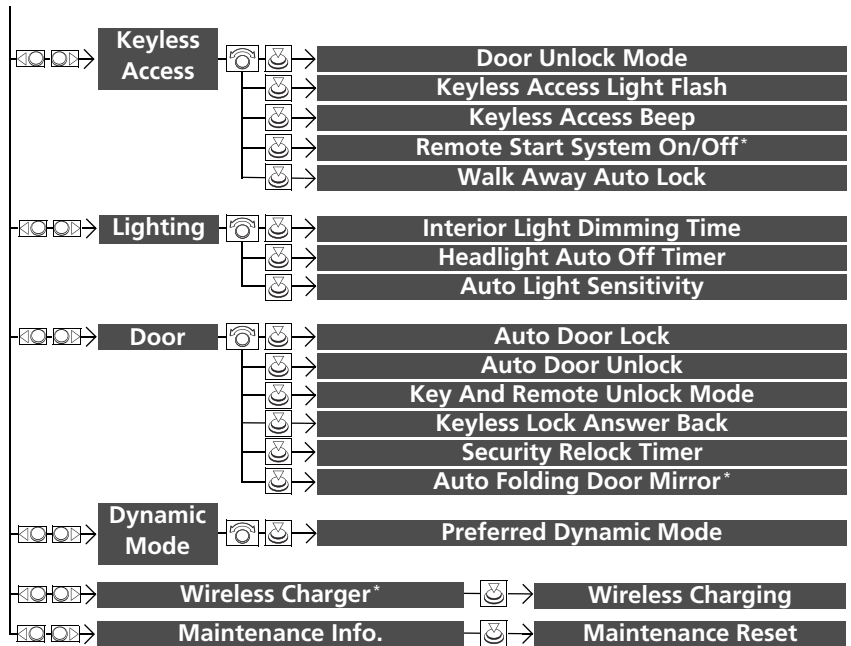

* Not available on all models

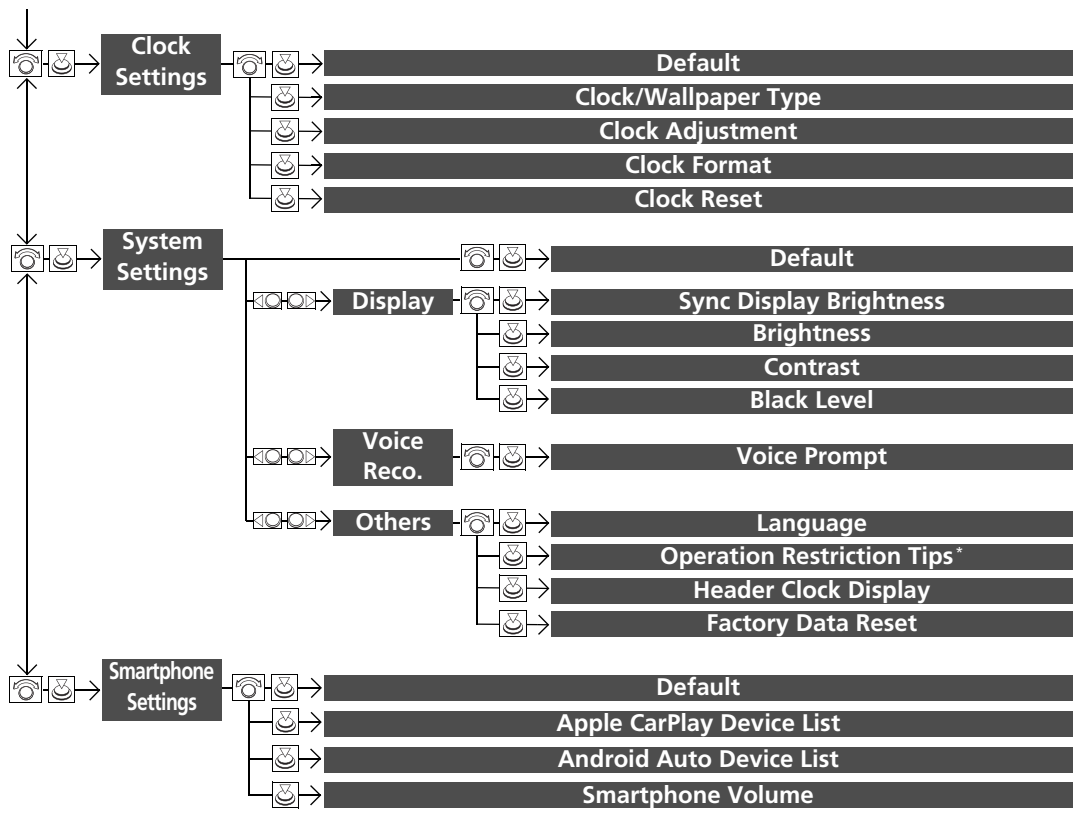

Information Screen

■ List of customizable options

| Setup Group | Customizable Features | Description | Selectable Settings | |
|---------------------------------|-----------------------|--|--|----------------------------------|
| Bluetooth/ Phone Settings | Default | Cancels/Resets all customized items in the Bluetooth/Phone Settings group as default. | Yes/No | |
| | Bluetooth | Bluetooth | Turns the <i>Bluetooth</i> ® on and off. | On*¹/Off |
| | | Bluetooth Device List | Pairs a new phone to HFL, edits or deletes a paired phone, or creates a security PIN. ➤ Phone Setup P. 325 | — |
| | | Edit Pairing Code | Changes a pairing code. ➤ To change the pairing code setting P. 327 | Random/Fixed*¹ |
| | Phone | Edit Speed Dial | Edits, adds or deletes a speed dial entry. ➤ Phone Setup P. 325 | — |
| | | Auto Transfer | Sets calls to automatically transfer from your phone to HFL when you enter the vehicle. | On*¹/Off |
| | | Auto Answer | Sets whether to automatically answer an incoming call after about four seconds. | On/Off*¹ |

*1:Default Setting

| Setup Group | Customizable Features | Description | Selectable Settings |
|--|-----------------------------|---|--|
| Bluetooth/ Phone Settings | Ring Tone | Selects the ring tone. | Fixed/Mobile Phone*¹/Off |
| | Phone | | |
| | Automatic Phone Sync | Sets a phonebook data to be automatically imported when a phone is paired to HFL. | On/Off |
| | Use Contact Photo | Displays a caller's picture on an incoming call screen. | On*¹/Off |
| | Text/ Email | | |
| | Enable Text/Email | Turns the text/e-mail message function on and off. | On*¹/Off |
| | Select Account | Selects a mail or text message account. | — |
| | New Text/Email Alert | Selects whether a pop-up alert comes on the screen when HFL receives a new text message/E-mail. | — |
| | Message Auto Reading | Selects whether the system automatically reads out messages, and, if selected, whether only when driving. | On*¹/Off |

*1:Default Setting

| Setup Group | Customizable Features | Description | Selectable Settings |
|------------------------|--------------------------|---|----------------------------|
| Camera Settings | Default | Cancels/Resets all customized items in the Camera Settings group as default. | Yes/No |
| | Fixed Guideline | Selects whether the fixed guidelines come on the rear camera monitor. | On^{*1}/Off |
| | Dynamic Guideline | Selects whether the dynamic guidelines come on the rear camera monitor. | On^{*1}/Off |

*1:Default Setting

| Setup Group | Customizable Features | Description | Selectable Settings | |
|-------------------------|---|--|---|--|
| Vehicle Settings | Default | Cancels/Resets all customized items in the Vehicle Settings group as default. | Yes/No | |
| | Forward Collision Warning Distance | Changes at which distance CMBS™ alerts. | Long/Normal*¹/Short | |
| | Head-up Warning | Turns the head-up warning on and off. | On*¹/Off | |
| | ACC Forward Vehicle Detect Beep | Causes the system to beep when the system detects a vehicle, or when the vehicle goes out of the ACC with LSF range. | On/Off*¹ | |
| | Driver Assist | ACC Display Speed Unit | Changes the speed unit for ACC with LSF on the multi-information display. | mph*¹/km/h (U.S.) mph/km/h*¹ (Canada) |
| | Road Departure Mitigation Setting | Changes the setting for the road departure mitigation system. | Normal*¹/Wide/ Warning Only | |
| | Lane Keeping Assist Suspend Beep | Causes the system to beep when the LKAS is suspended. | On/Off*¹ | |
| | Blind Spot Info* | Changes the setting for the blind spot information. | Audible And Visual Alert*¹/Visual Alert/ Off | |

*1:Default Setting

| Setup Group | Customizable Features | Description | Selectable Settings | |
|------------------|-----------------------|---|--|--|
| Vehicle Settings | Meter | Language Selection | Changes the displayed language on the multi-information display. | English^{*1}/Français/ Español |
| | | Adjust Outside Temp. Display | Adjusts the temperature reading by a few degrees. | -5°F ~ ±0°F^{*1} ~ +5°F (U.S.) -3°C ~ ±0°C^{*1} ~ +3°C (Canada) |
| | | “Trip A” Reset Timing | Changes the setting of how to reset trip meter A, average fuel economy A, average speed A, and elapsed time A. | When Refueled/IGN Off/Manually Reset^{*1} |
| | | “Trip B” Reset Timing | Changes the setting of how to reset trip meter B, average fuel economy B, average speed B, and elapsed time B. | When Refueled/IGN Off/Manually Reset^{*1} |
| | | Reverse Alert Tone[*] | Causes the beeper to sound once when the transmission is put into R . | On^{*1}/Off |
| | | Auto Engine Idle Stop Guidance Screens[*] | Selects whether the Auto Idle Stop display comes on. | On/Off^{*1} |
| | | Turn by Turn Display[*] | Selects whether the turn-by-turn display comes on during the route guidance. | On^{*1}/Off |

*1:Default Setting

* Not available on all models

| Setup Group | Customizable Features | Description | Selectable Settings |
|-------------------------|-------------------------|---|--|
| Vehicle Settings | Driving Position | Memory Position Link | Turns the driving position memory system on and off. On^{*1}/Off |
| | | Seat Position Movement At Entry/Exit | Depending on the set seating position the driver seat may move forward or rearward when entering/exiting the vehicle. On^{*1}/Off |
| | | Door Unlock Mode | Changes which doors unlock when you grab the driver's door handle. Driver Door Only^{*1}/ All Doors |
| | | Keyless Access Light Flash | Causes some exterior lights to flash when you unlock/lock the doors. On^{*1}/Off |
| | Keyless Access | Keyless Access Beep | Causes the beeper to sound when you unlock/lock the doors. On^{*1}/Off |
| | | Remote Start System On/Off[*] | Turns the remote engine start feature on and off. On^{*1}/Off |
| | | Walk Away Auto Lock | Changes the settings for the automatic locking the doors when you walk away from the vehicle while carrying the keyless access remote. On/Off^{*1} |

*1:Default Setting

| Setup Group | Customizable Features | Description | Selectable Settings |
|-------------------------|------------------------------------|---|---|
| Vehicle Settings | Lighting | | |
| | Interior Light Dimming Time | Changes the length of time the interior lights stay on after you close the doors. | 60seconds/ 30seconds*¹/ 15seconds |
| | Headlight Auto Off Timer | Changes the length of time the exterior lights stay on after you close the driver's door. | 60seconds/ 30seconds/ 15seconds*¹/ 0seconds |
| | Auto Light Sensitivity | Changes the timing for the headlights to come on. | Max/High/Mid*¹/ Low/Min |

*1:Default Setting

| Setup Group | Customizable Features | Description | Selectable Settings | |
|-------------------------|-----------------------|---|---|--|
| Vehicle Settings | Door | Auto Door Lock | Changes the setting for when the doors automatically lock. | With Vehicle Speed^{*1}/Shift from P/Off |
| | | Auto Door Unlock | Changes the setting for when the doors unlock automatically. | All Doors When Driver's Door Opens^{*1}/All Doors When Shifted to Park/All Doors When Ignition Switched Off/Off |
| | | Key And Remote Unlock Mode | Sets up either the driver's door or all doors to unlock on the first push of the remote or built-in key. | Driver Door^{*1}/All Doors |
| | | Keyless Lock Answer Back | LOCK/UNLOCK- The exterior lights flash. LOCK (2nd push)- The beeper sounds. | On^{*1}/Off |
| | | Security Relock Timer | Changes the time it takes for the doors to relock and the security system to set after you unlock the vehicle without opening any door. | 90seconds/ 60seconds/ 30seconds^{*1} |
| | | Auto Folding Door Mirror[*] | Changes how you can fold the door mirrors. | Auto Fold With Keyless^{*1}/Manual Only |

*1:Default Setting

| Setup Group | Customizable Features | | Description | Selectable Settings |
|------------------|-------------------------------------|-------------------------------|---|---|
| Vehicle Settings | Dynamic Mode | Preferred Dynamic Mode | Changes the dynamic mode setting for when you set the power mode to ON. | Last Used^{*1}/Econ/Normal/Sport |
| | Wireless Charger[*] | Wireless Charging | Turns the wireless charging feature on and off. | On^{*1}/Off |
| | Maintenance Info. | Maintenance Reset | Resets the engine oil life display when you have performed the maintenance service. | — |

*1:Default Setting

| Setup Group | Customizable Features | Description | Selectable Settings |
|-----------------------|-----------------------------|---|--|
| Clock Settings | Default | Cancels/Resets all customized items in the Clock Settings group as default. | Yes/No |
| | Clock | Changes the clock display type. | Analog/Digital*1/ Small Digital/Off |
| | Clock/Wallpaper Type | <ul style="list-style-type: none"> • Changes the wallpaper type. • Imports an image file for a new wallpaper. • Deletes an image file for a wallpaper. ▶ Wallpaper Setup P. 226 | Blank/Galaxy*1/ Metallic/Options... |
| | Clock Adjustment | Adjusts Clock. ▶ Clock P. 132 | — |
| | Clock Format | Selects the digital clock display from 12H to 24H. | 12H*1/24H |
| | Clock Reset | Resets the clock settings to the factory default. | Yes/No |

*1:Default Setting

| Setup Group | Customizable Features | Description | Selectable Settings | |
|------------------------|-----------------------|---|---|-------------------------------------|
| System Settings | Default | Cancels/Resets all customized items in the System Settings group as default. | Yes/No | |
| | Display | Sync Display Brightness | Selects whether the display brightness synchronizes with the instrument panel brightness. | On^{*1}/Off |
| | | Brightness | Changes the brightness of the information screen. | — |
| | | Contrast | Changes the contrast of the information screen. | — |
| | | Black Level | Changes the black level of the information screen. | — |
| | Voice Reco. | Voice Prompt | <ul style="list-style-type: none"> • Beginner: Explains each option. • Expert: Turns off voice prompts. | Beginner^{*1}/Expert |

*1:Default Setting

| Setup Group | Customizable Features | Description | Selectable Settings | |
|----------------------------|----------------------------------|---|--|--|
| System Settings | Others | Language | Changes the display language. | English^{*1}/Français/Español |
| | | Operation Restriction Tips[*] | Alerts you when manual control of the system is disabled to prevent distraction while driving. Only voice commands are available. | On^{*1}/Off |
| | | Header Clock Display | Selects whether the clock display comes on. | On^{*1}/Off |
| | | Factory Data Reset | Resets all the settings to their factory default.  Defaulting All the Settings P. 313 | — |
| Smartphone Settings | Default | Cancels/Resets all customized items in the Smartphone Settings group as default. | Yes/No | |
| | Apple CarPlay Device List | Sets up the Apple CarPlay connection. | — | |
| | Android Auto Device List | Sets up the Android Auto connection. | — | |
| | Smartphone Volume | Adjusts the volume of the smartphone function. | 1~8^{*1}~11 | |
| | Version | Shows software version of Apple CarPlay and Android Auto unit. | — | |

*1:Default Setting

On Demand Multi-Use Display™**■ How to customize**

While the vehicle is at a complete stop with the power mode in ON, select **Audio Menu**, then select a setting item.



On Demand Multi-Use Display™

■ Customization flow

Select **Audio Menu**.

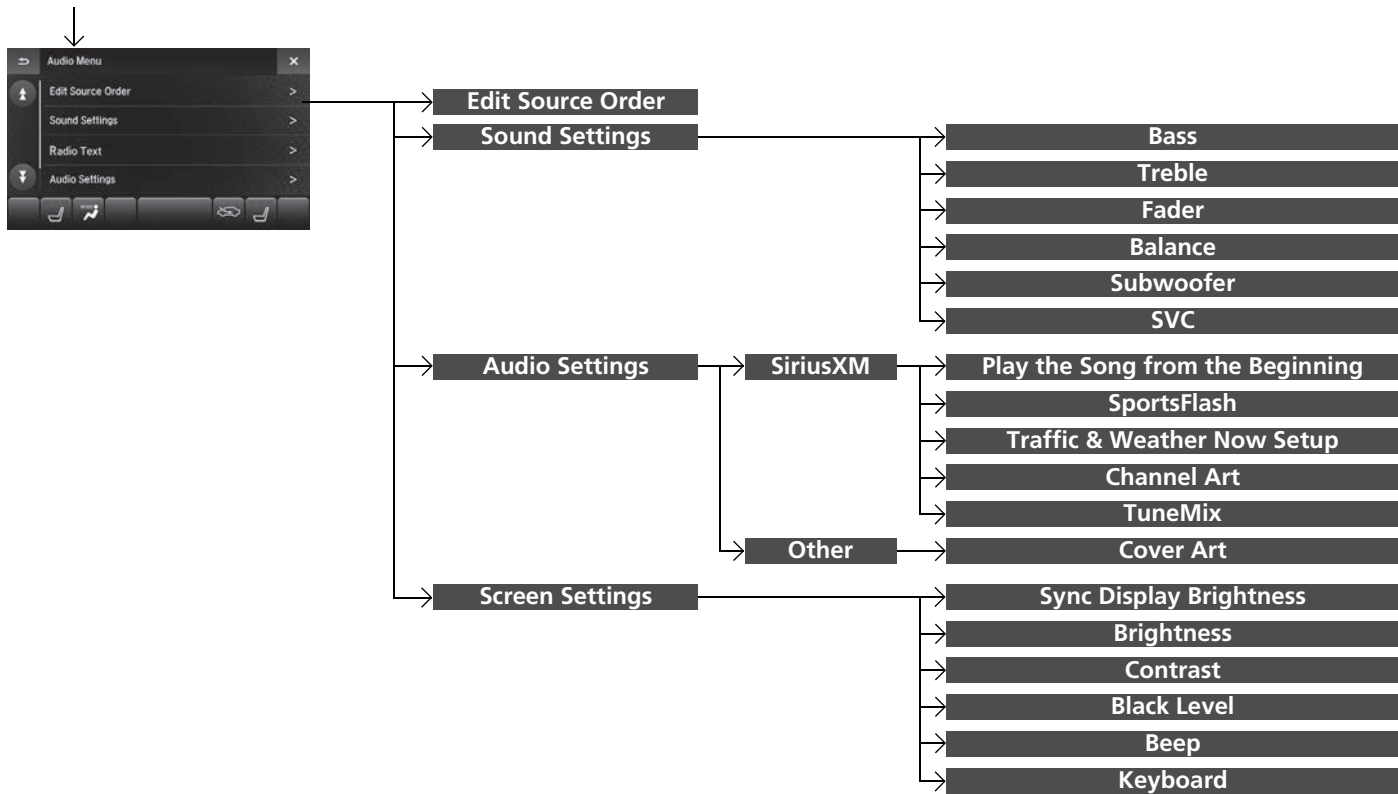

On Demand Multi-Use Display™

■ List of customizable options

| Setup Group | Customizable Features | Description | Selectable Settings |
|----------------|--------------------------|---|---|
| Sound Settings | Edit Source Order | Changes the order of source list. ▶ Selecting an Audio Source P. 220 | — |
| | Bass | | |
| | Treble | | |
| | Fader | Adjusts the settings of the audio speaker's sound. ▶ Adjusting the Sound P. 228 | — |
| | Balance | | |
| | Subwoofer | | |
| SVC | | | |
| Audio Settings | SiriusXM | Play the Song from the Beginning | Turns on and off the Tune Start function. On*¹/Off |
| | | Notification | Turns on and off the sports alert function. Disable*¹/Enable once/Enable |
| | SportsFlash | Beep | Causes the system to beep when the sports alert is notified. On*¹/Off |
| | | Favorite Teams | Selects your favorite sport teams. — |

*1:Default Setting

| Setup Group | Customizable Features | Description | Selectable Settings | |
|------------------------|-----------------------|--|---|-------------------------------------|
| Audio Settings | SiriusXM | Traffic & Weather Now Setup | Selects a city for using the SiriusXM® traffic and weather information. | — |
| | | Channel Art | Turns on and off the channel art display. | On*¹/Off |
| | | TuneMix | Turns multiple channel mix preset on and off. | On/Off*¹ |
| | Other | Cover Art | Turns on and off the cover art display. | On*¹/Off |
| Screen Settings | | Sync Display Brightness | Selects whether the screen brightness synchronizes with the instruments panel brightness. | Off/On*¹ |
| | | Brightness | Changes the brightness of the On Demand Multi-Use Display™. | — |
| | | Contrast | Changes the contrast of the On Demand Multi-Use Display™. | — |
| | | Black Level | Changes the black level of the On Demand Multi-Use Display™. | — |
| | | Beep | Mutes a beep that sounds every time you touch the screen. | Off/On*¹ |
| | | Keyboard | Changes the on-screen keyboard from the alphabetical order to the qwerty type. | Alphabet/QWERTY*¹ |

*1:Default Setting

Defaulting All the Settings

You can reset all the menu and customized settings as the factory defaults.

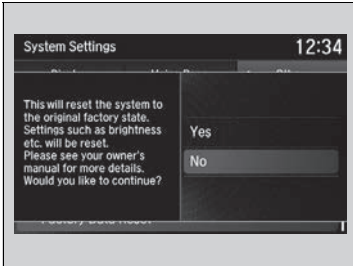

1. Press the **SETTINGS** button.
2. Rotate to select **System Settings**, then press .
3. Rotate to select **Factory Data Reset**, then press .
 - The pop-up menu appears on the screen.
4. Rotate to select **Yes**, then press .
 - The confirmation message will appear.
5. Rotate to select **Yes**, then press again to reset the settings.
 - The confirmation message will appear. Press to select **OK**.

Defaulting All the Settings

When you transfer the vehicle to a third party, reset all settings to default and delete all personal data.

The following settings will be reset:

- Audio preset settings
- Phonebook entries
- Other display and each item settings

The HomeLink® Universal Transceiver can be programmed to operate up to three remote controlled devices around your home, such as garage doors, lighting, or home security systems.

■ Important Safety Precautions

Refer to the safety information that came with your garage door opener to test that the safety features are functioning properly. If you do not have the safety information, contact the manufacturer.

Before programming HomeLink, make sure that people and objects are out of the way of the garage or gate to prevent potential injury or damage.

When programming a garage door opener, park just outside the garage door's path.

⌘ HomeLink® Universal Transceiver

Before programming HomeLink to operate a garage door opener, confirm that the opener has an external entrapment protection system, such as an "electronic eye," or other safety and reverse stop features. If it does not, HomeLink may not be able to operate it.

Training HomeLink

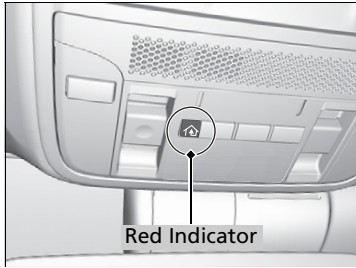

If it is necessary to erase a previously entered learned code:

- Press and hold the two outside buttons for about 20 seconds, until the red indicator blinks. Release the buttons, and proceed to step 1.
- If you are training the second or third button, go directly to step 1.

The instructions on the next page should work for most gate or garage openers, but may not work for all. For detailed instructions about your specific remote opener, visit <http://www.homelink.com> or call (800) 355-3515.

■ Training a Button

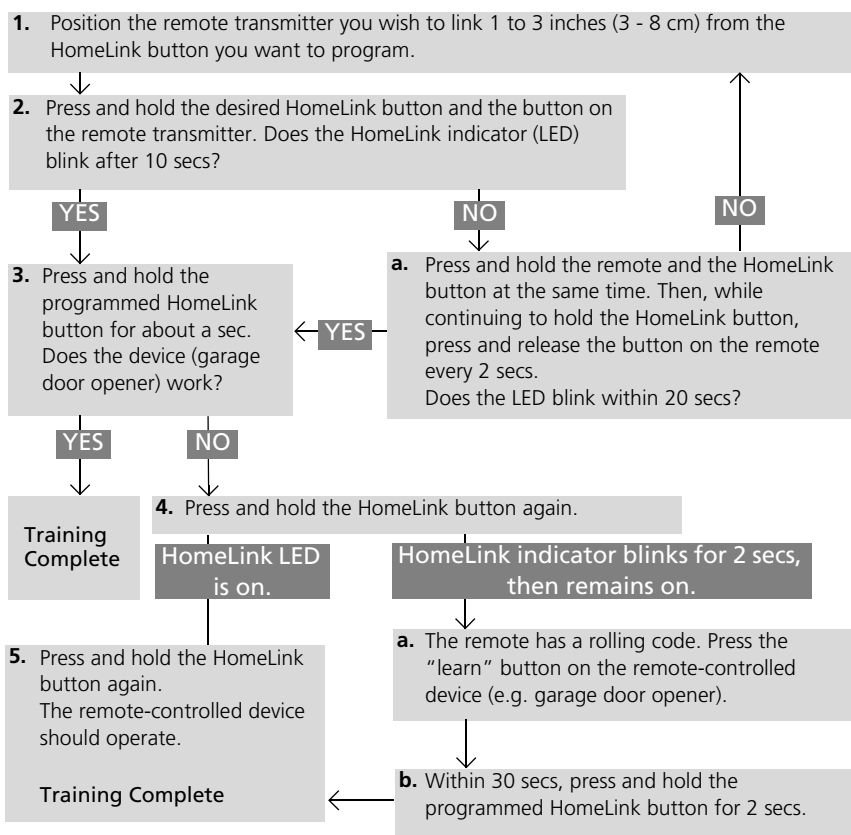

▶▶ Training HomeLink

Retraining a Button
 If you want to retrain a programmed button for a new device, you do not have to erase all button memory. You can replace the existing memory code using this procedure:

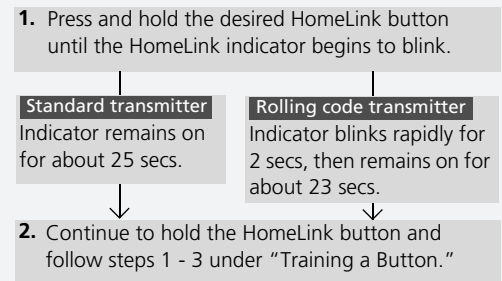

Erasing Codes
 To erase all the codes, press and hold the two outside buttons until the HomeLink indicator begins to blink (about 10 to 20 secs). You should erase all codes before selling the vehicle.

If you have any problems, see the device's instructions, visit www.homelink.com, or call HomeLink at (800) 355-3515.

HomeLink® is a registered trademark of Gentex Corporation.

Bluetooth® HandsFreeLink® (HFL) allows you to place and receive phone calls using your vehicle's audio system, without handling your cell phone.

Using HFL

HFL Buttons

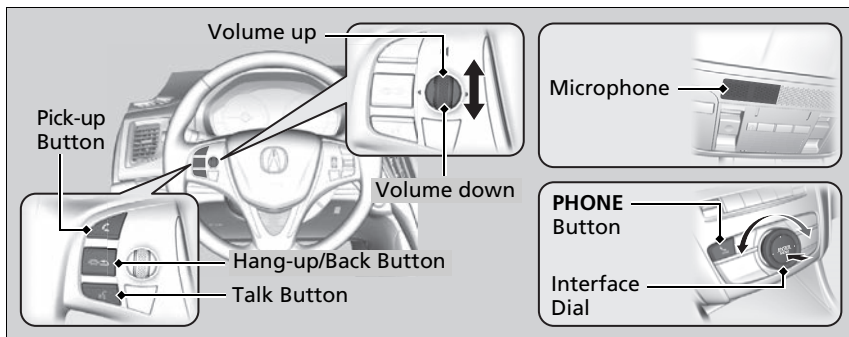

(Pick-up) button: Press to go to the **Speed Dial/Call History** on the multi-information display or to answer an incoming call.

(Hang-up/back) button: Press to end a call, to cancel a command or to clear the phone information on the multi-information display.

(Talk) button: Press to give HFL voice commands.

PHONE button: Press to go directly to the phone menu screen.

Interface dial (ENTER/MENU button): Rotate to select an item on the screen, then press . Move , , or to select secondary menu.

Bluetooth® HandsFreeLink®

Place your phone where you can get good reception. To use HFL, you need a *Bluetooth*-compatible cell phone. For a list of compatible phones, pairing procedures, and special feature capabilities:

- U.S.: Visit www.acura.com/handsfreelink, or call 1-888-528-7876.
- Canada: Visit www.handsfreelink.ca, or call 1-888-528-7876.

To use HFL, the **Bluetooth** setting must be **On**. If there is an active connection to Apple CarPlay, HFL is unavailable.

Customized Features P. 292

Voice control tips:

- Aim the vents away from the ceiling and close the windows, as noise coming from them may interfere with the microphone.
- Press and release the button when you want to call a number using a stored voice tag, a phonebook name, or a number. Speak clearly and naturally after a beep.
- If the microphone picks up voices other than yours, the command may be misinterpreted.
- To change the volume level, use the audio system's volume knob or the remote audio controls on the steering wheel.

State or local laws may prohibit the operation of handheld electronic devices while operating a vehicle.

■ HFL Status Display

The On Demand Multi-Use Display™ notifies you when there is an incoming call.

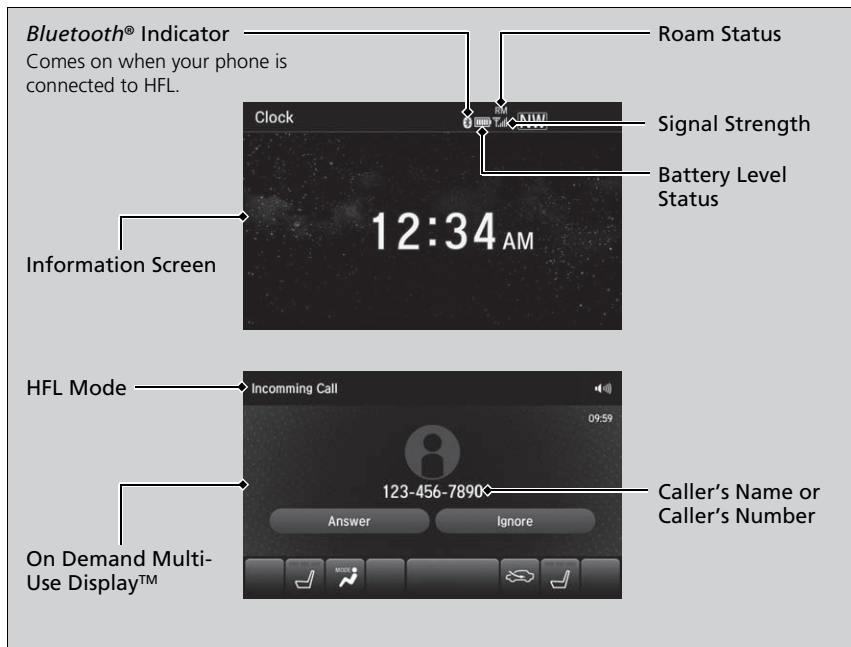

▶▶ Bluetooth® HandsFreeLink®

If you receive a call while using the audio system, the system resumes its operation after ending the call.

Bluetooth® Wireless Technology
The *Bluetooth®* word mark and logos are registered trademarks owned by Bluetooth SIG, Inc., and any use of such marks by Honda Motor Co., Ltd., is under license. Other trademarks and trade names are those of their respective owners.

HFL Limitations
An incoming call on HFL will interrupt the audio system when it is playing. It will resume when the call is ended.

▶▶ HFL Status Display

The information that appears on the information screen varies between phone models.

You can change the system language.
▶ **Customized Features** P. 292

Limitations for Manual Operation

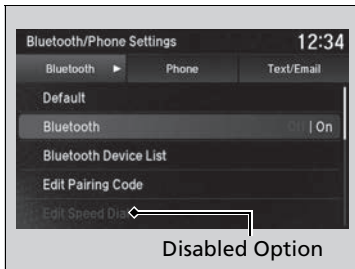

Certain manual functions are disabled or inoperable while the vehicle is in motion. You cannot select a grayed-out option until the vehicle is stopped.

Only previously stored speed dial entries with voice tags, phonebook names, or numbers can be called using voice commands while the vehicle is in motion.

▶ **Speed Dial** P. 336

HFL Menu

The power mode must be in ACCESSORY or ON to use HFL.

■ Bluetooth/Phone Settings screen

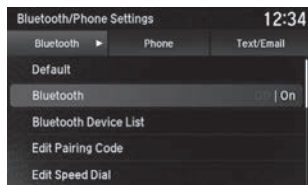

1. Press the **SETTINGS** button.
2. Rotate to select **Bluetooth/Phone Settings**, then press .

▶ HFL Menu

To use HFL, you must first pair your *Bluetooth*-compatible cell phone to the system while the vehicle is parked.

Some functions are limited while driving. A message appears on the screen when the vehicle is moving and the operation is canceled.

Features

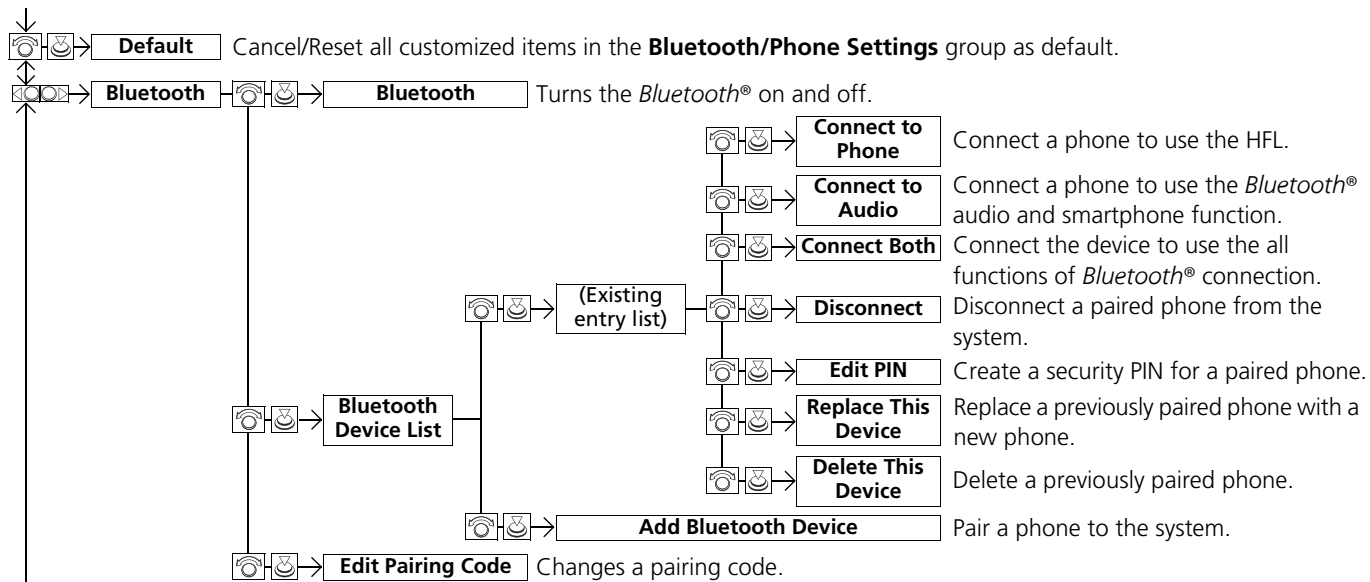

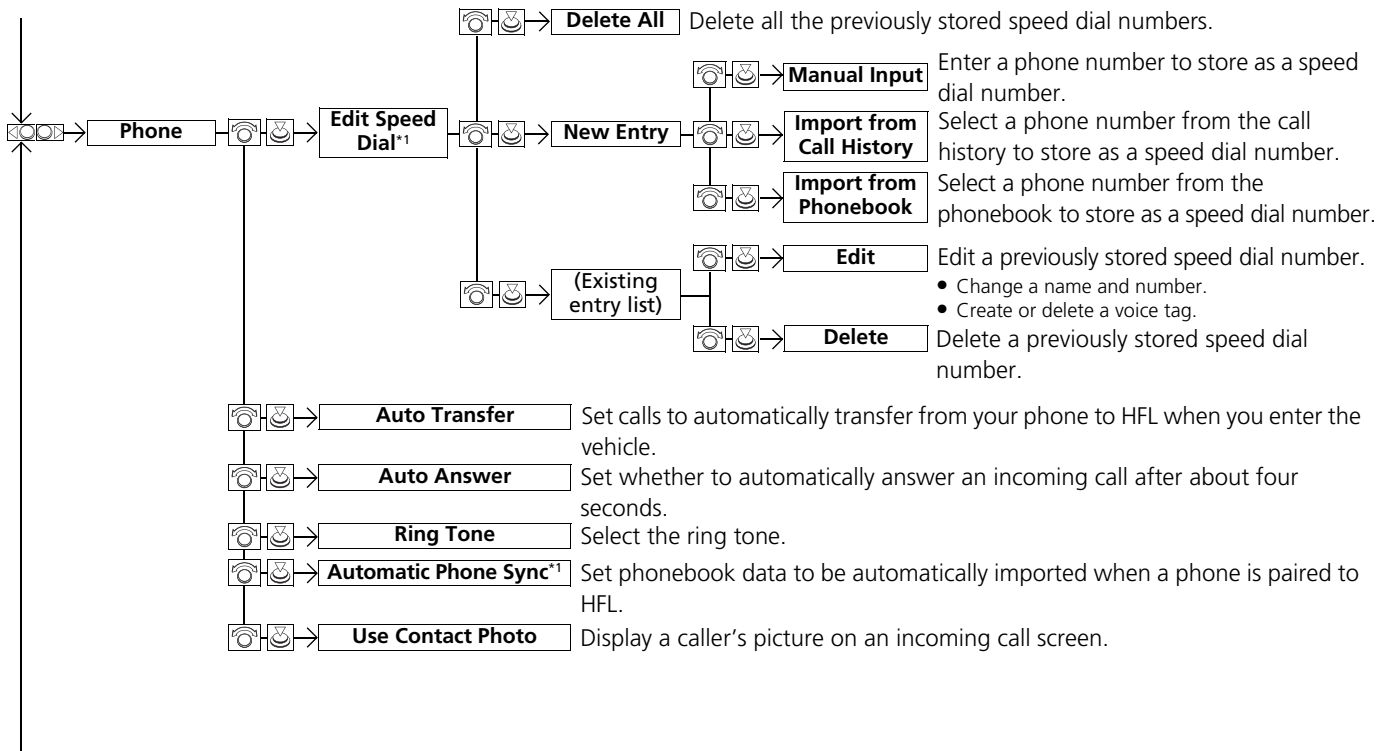

*1: Appears only when a phone is connected to HFL.

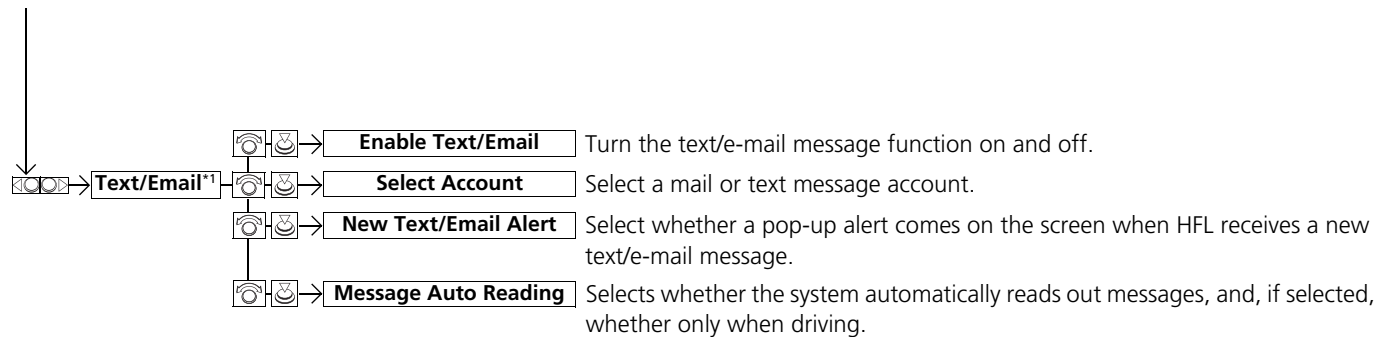

*1: Appears only when a phone is connected to HFL.

Phone Menu screen

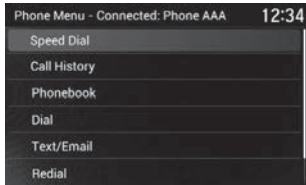

Press the **PHONE** button to display the menu items.

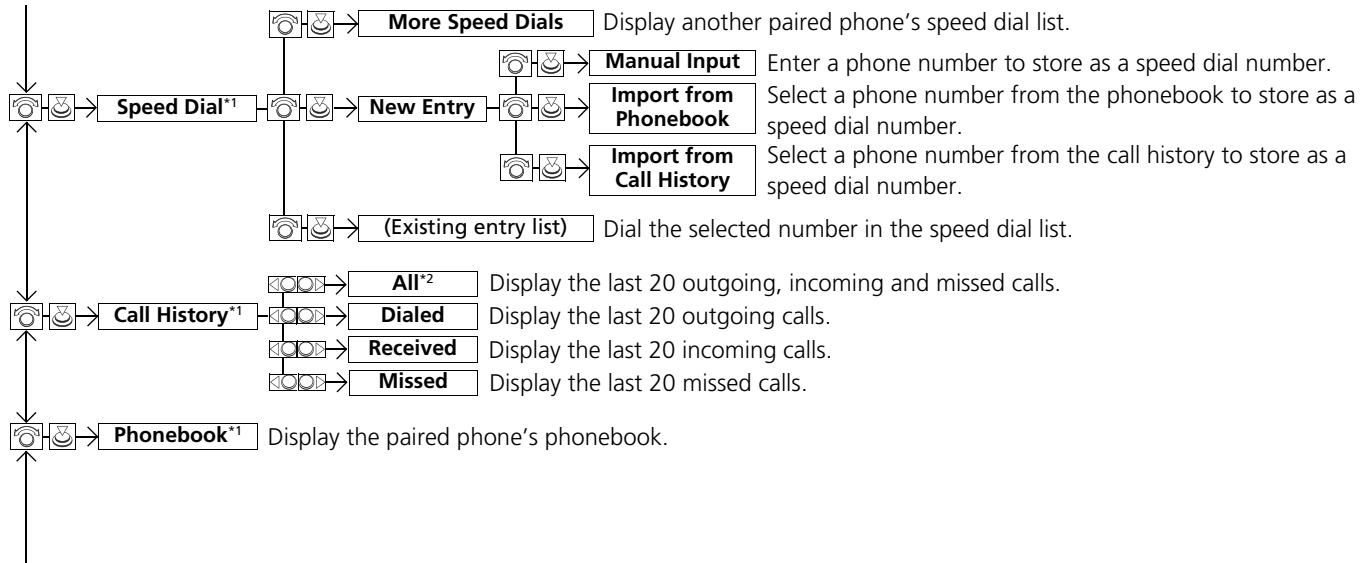

*1: Appears only when a phone is connected to HFL.

*2: This function is not available if your phone is not supported.

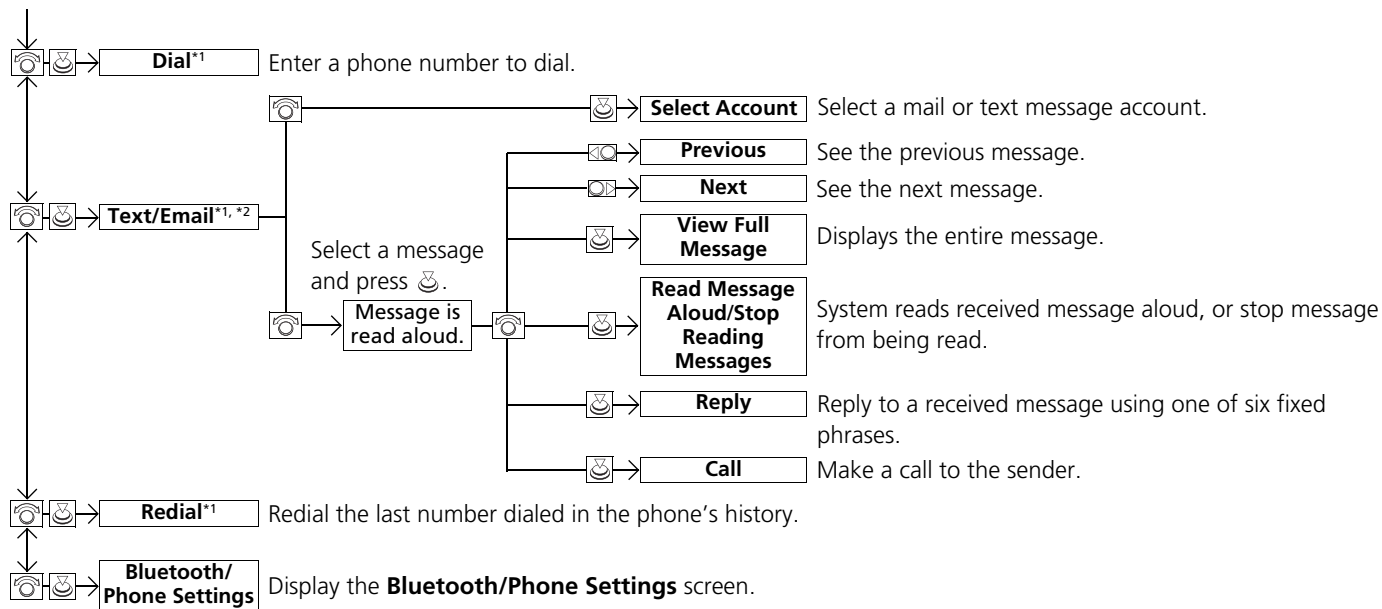

*1: Appears only when a phone is connected to HFL.

*2: This function is not available if your phone is not supported.

Phone Setup

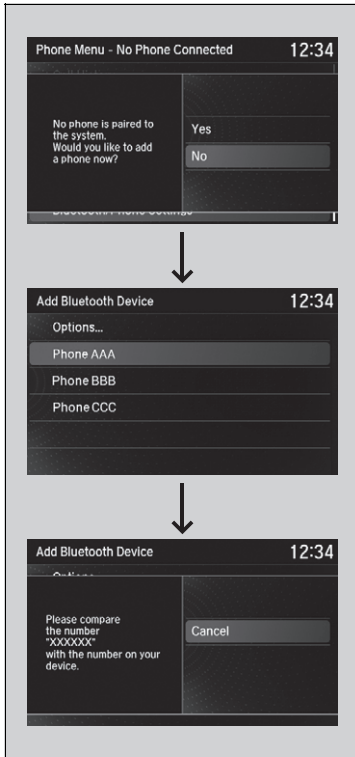

■ To pair a cell phone (when there is no phone paired to the system)

1. Press the **PHONE** button.
2. Rotate to select **Yes**, then press .
3. Make sure your phone is search or discoverable mode, then press .
 - ▶ HFL automatically searches for a *Bluetooth* device.
4. When your phone appears on the list, select it by pressing .
 - ▶ If your phone does not appear, you can select **Options...** and **Refresh** to search again.
 - ▶ If your phone still does not appear, select **Options...** to select **Device Not Found?** and search for *Bluetooth* devices using your phone. From your phone, select **HandsFreeLink**.
5. HFL gives you a pairing code on the information screen.
 - ▶ Confirm if the pairing code on the screen and your phone match. This may vary by phone.
6. A notification appears on the screen if pairing is successful.

☒ Phone Setup

Your *Bluetooth*-compatible phone must be paired to HFL before you can make and receive hands-free calls.

Phone Pairing Tips:

- You cannot pair your phone while the vehicle is moving.
- Up to six phones can be paired.
- Your phone's battery may drain faster when it is connected to HFL.
- If your phone is not ready for pairing or not found by the system within three minutes, the system will time out and returns to idle.

Once you have paired a phone, you can see it displayed on the screen with one or two icons on the right side.

These icons indicate the following:

: The phone can be used with HFL.

: The phone is compatible with *Bluetooth*® Audio.

When pairing is completed, an **Automatic Phone Sync** prompt appears. Select **On** if you want your call history and phonebook automatically imported to HFL.

▶ **Changing the Automatic Phone Sync setting** P. 335

If there is an active connection to Apple CarPlay, pairing of additional *Bluetooth*-compatible devices is unavailable.

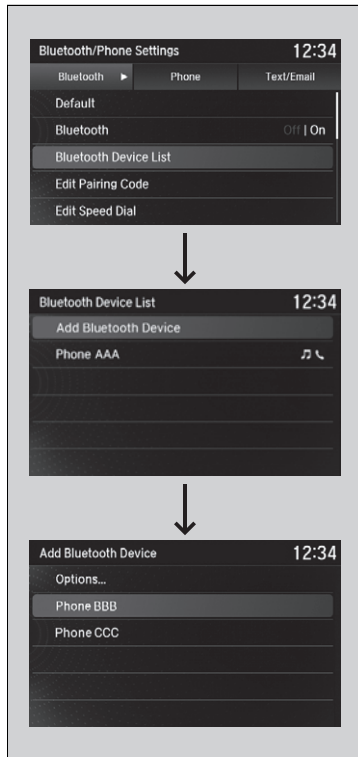

■ **To pair a cell phone (when a phone has already been paired to the system)**

1. Press the **SETTINGS** button.
2. Rotate to select **Bluetooth/Phone Settings**, then press .
- ▶ Repeat the procedure to select **Bluetooth Device List**, then **Add Bluetooth Device**.
3. Make sure your phone is in search or discoverable mode, then press .
- ▶ HFL automatically searches for a *Bluetooth* device.
4. When your phone appears on the list, select it by pressing .
- ▶ If your phone does not appear, you can select **Options...** and **Refresh** to search again.
- ▶ If your phone still does not appear, select **Options...** to select **Device Not Found?** and search for *Bluetooth* devices using your phone. From your phone, select **HandsFreeLink**.
5. HFL gives you a pairing code on the information screen.
- ▶ Confirm if the pairing code on the screen and your phone match.
This may vary by phone.
6. A notification appears on the screen if pairing is successful.

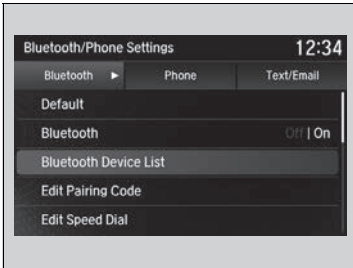

■ **To change the currently paired phone**

1. Press the **SETTINGS** button.
2. Rotate to select **Bluetooth/Phone Settings**, then press .
- ▶ Repeat the procedure to select **Bluetooth Device List**.
3. Select a phone to connect.
 - ▶ HFL disconnects the connected phone and starts searching for another paired phone.
4. Select **Connect to Phone**, **Connect to Audio**, or **Connect Both**.

■ **To change the pairing code setting**

1. Press the **SETTINGS** button.
2. Rotate to select **Bluetooth/Phone Settings**, then press .
 - ▶ Repeat the procedure to select **Edit Pairing Code**.
3. Rotate to select **Fixed** or **Random**, then press .

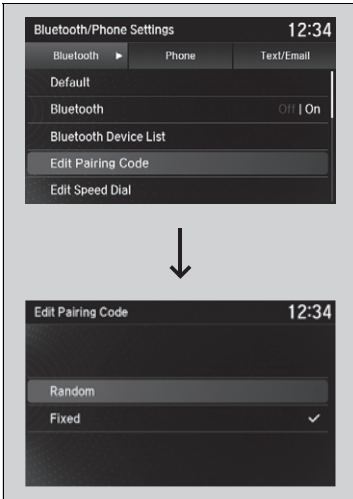

☒ **To change the pairing code setting**

The pairing code may be six or four digits depending on your phone.

The default pairing code is **0000** until you change the setting.

To create your own, select **Fixed**, and delete the current code, then enter a new one.

For a randomly generated pairing code each time you pair a phone, select **Random**.

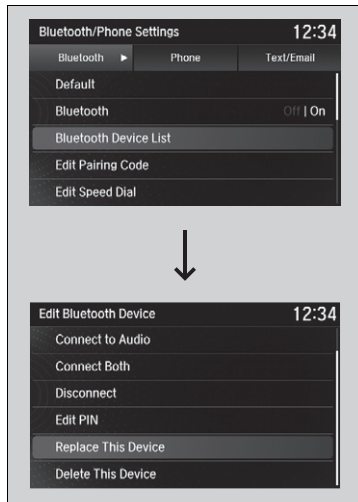

■ **To replace an already-paired phone with a new phone**

1. Press the **SETTINGS** button.
2. Rotate to select **Bluetooth/Phone Settings**, then press .
 - ▶ Repeat the procedure to select **Bluetooth Device List**.
3. Rotate to select a paired phone you want to replace, then press .
4. Rotate to select **Replace This Device**, then press .
5. HFL enters the pairing process and searches a new phone.
 - ▶ Follow the prompts to pair a new phone.
6. A notification appears on the screen if pairing is successful.

▶▶ To replace an already-paired phone with a new phone

The replaced phone will keep the same speed dial entries, and security PIN information from the previously paired phone.

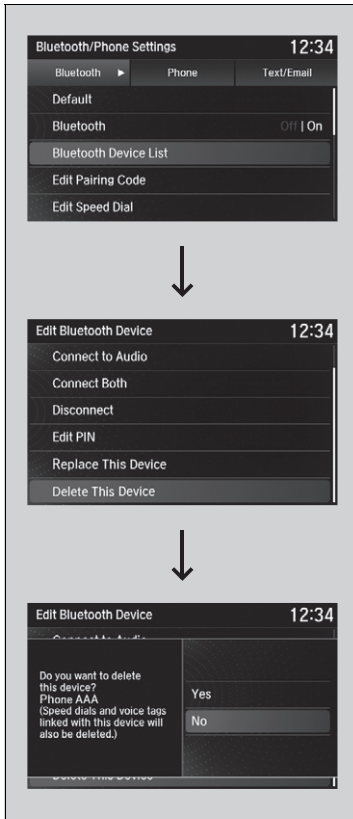

■ **To delete a paired phone**

1. Press the **SETTINGS** button.
2. Rotate to select **Bluetooth/Phone Settings**, then press .
- ▶ Repeat the procedure to select **Bluetooth Device List**.
3. Rotate to select a phone you want to delete, then press .
4. Rotate to select **Delete This Device**, then press .
5. A confirmation message appears on the screen. Rotate to select **Yes**, then press .
6. A notification appears on the screen if pairing is successful.

■ To Set Up a Text/e-mail Message Option

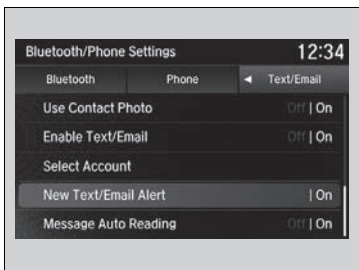
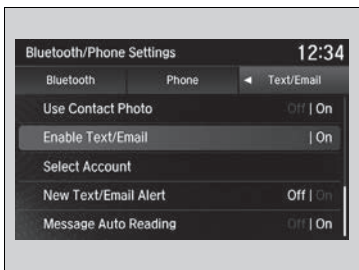

■ To turn on or off the text/e-mail message function

1. Press the **SETTINGS** button.
2. Rotate to select **Bluetooth/Phone Settings**, then press .
3. Rotate to select **Enable Text/Email**.
4. Press to select **On** or **Off**.

■ To turn on or off the text/e-mail message notice

1. Press the **SETTINGS** button.
2. Rotate to select **Bluetooth/Phone Settings**, then press .
3. Rotate to select **New Text/Email Alert**.
4. Press to select **On** or **Off**.

▶▶ To Set Up a Text/e-mail Message Option

To use the text/e-mail message function, you need a *Bluetooth*-compatible cell phone. For a list of compatible phones, pairing procedures, and special feature capabilities:

- U.S.: Visit www.acura.com/handsfreelink, or call 1-888-528-7876.
- Canada: Visit www.handsfreelink.ca, or call 1-888-528-7876.



Some text/e-mail features may not be available depending on a cellular phone.

▶▶ To turn on or off the text/e-mail message notice

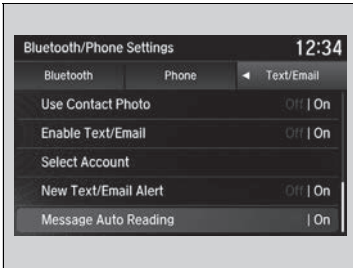
- On:** A pop-up notification comes on every time you receive a new text message.
- Off:** The message you receive is stored in the system without notification.



■ **To set up the auto reading option**

1. Press the **SETTINGS** button.
2. Rotate  to select **Bluetooth/Phone Settings**, then press .
3. Rotate  to select **Message Auto Reading**.
4. Press  to select **On** or **Off**.

☒ To set up the auto reading option

On: A text/e-mail message is always read aloud.
Off: A text/e-mail message is not read aloud.

Continued

■ To Create a Security PIN

You can protect each of the six cell phones with a security PIN.

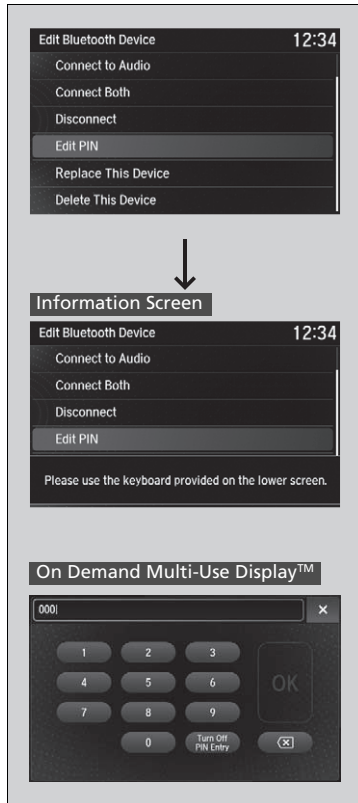

1. Press the **SETTINGS** button.
2. Rotate to select **Bluetooth/Phone Settings**, then press .
- ▶ Repeat the procedure to select **Bluetooth Device List**.
3. Rotate to select a phone you want to add a security PIN to, then press .
4. Rotate to select **Edit PIN**, then press .
5. Enter a new four-digit number.
 - ▶ Select to delete. Select of the right side upper screen, the screen returns to the previous screen.
6. Select **OK** to enter the security PIN.
7. Re-enter the four-digit number.
 - ▶ The screen returns to the screen in step 4.





▶▶ To Create a Security PIN

If the phone is already security PIN protected, you need to enter the current security PIN before clearing the PIN or creating a new one.

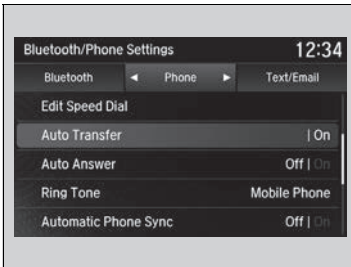
Automatic Transferring

If you get into the vehicle while you are on the phone, the call can be automatically transferred to HFL.





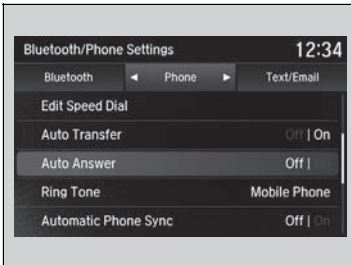

1. Press the **SETTINGS** button.
2. Rotate  to select **Bluetooth/Phone Settings**, then press .
3. Rotate  to select **Auto Transfer**.
4. Press  to select **On** or **Off**.

Auto Answer

You can set HFL to automatically answer an incoming call in four seconds.



1. Press the **SETTINGS** button.
2. Rotate  to select **Bluetooth/Phone Settings**, then press .
3. Rotate  to select **Auto Answer**.
4. Press  to select **On** or **Off**.

Ring Tone

You can change the ring tone setting.

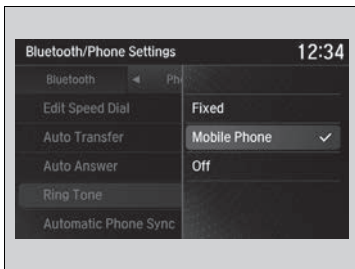

1. Press the **SETTINGS** button.
2. Rotate to select **Bluetooth/Phone Settings**, then press .
- ▶ Repeat the procedure to select **Ring Tone**.
3. Rotate to select **Fixed, Mobile Phone** or **Off**, then press .

Use Contact Photo

You can display a caller's picture on an incoming call screen.

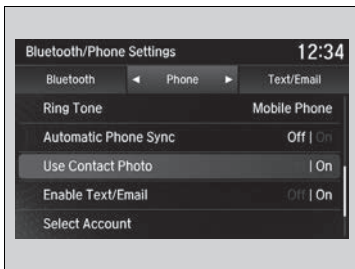

1. Press the **SETTINGS** button.
2. Rotate to select **Bluetooth/Phone Settings**, then press .
3. Rotate to select **Use Contact Photo**.
4. Press to select **On** or **Off**.

Ring Tone

Fixed: The fixed ring tone sounds from the speaker.

Mobile Phone: The ring tone stored in the connected cell phone sounds from the speaker.

Off: No ring tones sound from the speaker.

Automatic Import of Cellular Phonebook and Call History

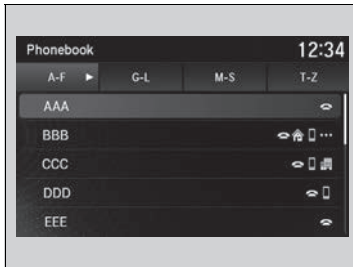

■ When Automatic Phone Sync is set to On:

When your phone is paired, the contents of its phonebook and call history are automatically imported to HFL.

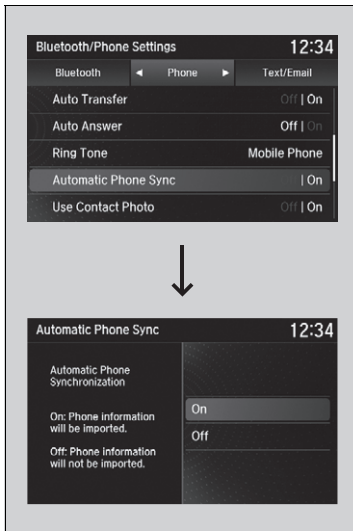

■ Changing the Automatic Phone Sync setting

1. Press the **SETTINGS** button.
2. Rotate to select **Bluetooth/Phone Settings**, then press .
- ▶ Repeat the procedure to select **Automatic Phone Sync**.
3. Rotate to select **On** or **Off**, then press .

⊠ Automatic Import of Cellular Phonebook and Call History

When you select a person from the list in the cellular phonebook, you can see up to three category icons. The icons indicate what types of numbers are stored for that name.

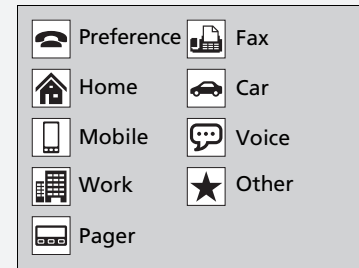

On some phones, it may not be possible to import the category icons to HFL.

The phonebook is updated after every connection. Call history is updated after every connection or call.

Continued

Speed Dial

Up to 20 speed dial numbers can be stored per phone.

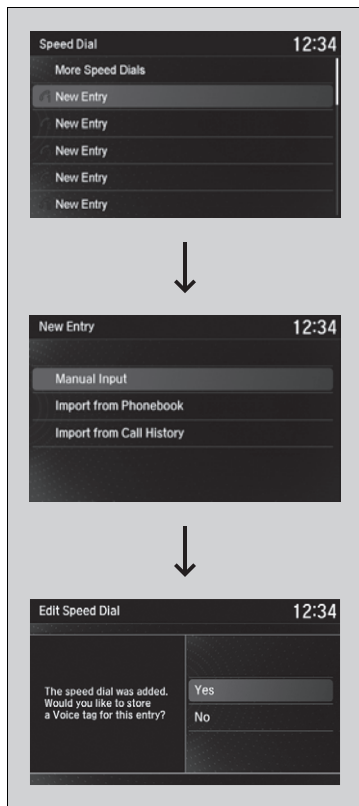

To store a speed dial number:

1. Press the **PHONE** button.
2. Rotate to select **Speed Dial**, then press .
 - ▶ Repeat the procedure to select **New Entry**.
3. Rotate to select a place to choose a number from, then press .
 - From **Import from Call History**:
 - ▶ Select a number from the call history.
 - From **Manual Input**:
 - ▶ Input the number manually.
 - From **Import from Phonebook**:
 - ▶ Select a number from the linked cell phone's imported phonebook.
4. When the speed dial is successfully stored from **Import from Call History** or **Import from Phonebook**, you are asked to create a voice tag for the number. Rotate to select **Yes** or **No**, then press .
5. Using the button, follow the prompts to store a voice tag for the speed dial entry.

Speed Dial

When a voice tag is stored, press the button to call the number using the voice tag. Say "Call" and the voice tag name.

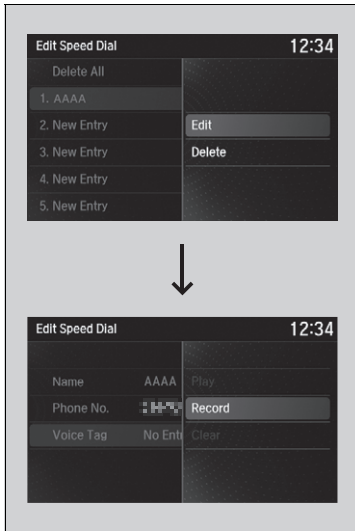

■ **To add a voice tag to a stored speed dial number**

1. Press the **SETTINGS** button.
2. Rotate to select **Bluetooth/Phone Settings**, then press .
 - ▶ Repeat the procedure to select **Edit Speed Dial**.
3. Select an existing speed dial entry.
 - ▶ From the pop-up menu, rotate to select **Edit**, then press .
4. Rotate to select **Voice Tag**, then press .
 - ▶ From the pop-up menu, rotate to select **Record**, then press .
5. Using the button, follow the prompts to complete the voice tag.

☒ Speed Dial

Avoid using duplicate voice tags.
 Avoid using “home” as a voice tag.
 It is easier for HFL to recognize a longer name. For example, use “John Smith” instead of “John.”

Continued

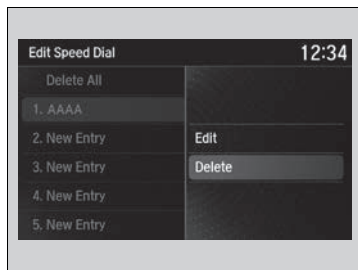
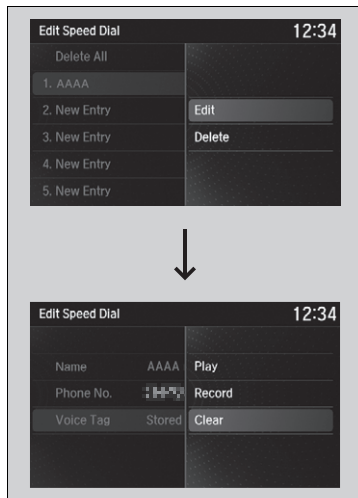

■ **To delete a voice tag**

1. Press the **SETTINGS** button.
2. Rotate to select **Bluetooth/Phone Settings**, then press .
 - ▶ Repeat the procedure to select **Edit Speed Dial**.
3. Select an existing speed dial entry.
 - ▶ From the pop-up menu, rotate to select **Edit**, then press .
4. Rotate to select **Voice Tag**, then press .
 - ▶ From the pop-up menu, rotate to select **Clear**, then press .
5. A confirmation message appears on the screen. Rotate to select **Yes**, then press .

■ **To delete a speed dial**

1. Press the **SETTINGS** button.
2. Rotate to select **Bluetooth/Phone Settings**, then press .
 - ▶ Repeat the procedure to select **Edit Speed Dial**.
3. Select an existing speed dial entry.
 - ▶ From the pop-up menu, rotate to select **Delete**, then press .
4. A confirmation message appears on the screen. Rotate to select **Yes**, then press .

Making a Call

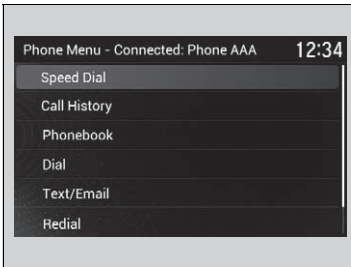

You can make calls by inputting any phone number, or by using the imported phonebook, call history, speed dial entries, or redial.

☒ Making a Call

Any voice-tagged speed dial entry, phonebook name, or number can be dialed by voice from most screens. Press the  button and say “Call” and the voice tag name, “Call by name” and the phonebook name, or “Call” and the phone number.

The maximum range between your phone and vehicles is 30 feet (10 meters).

Once a call is connected, you can hear the voice of the person you are calling through the audio speakers.

While there is an active connection with Apple CarPlay, phone calls cannot be made with HandsFreeLink® and are only made from Apple CarPlay.

Continued

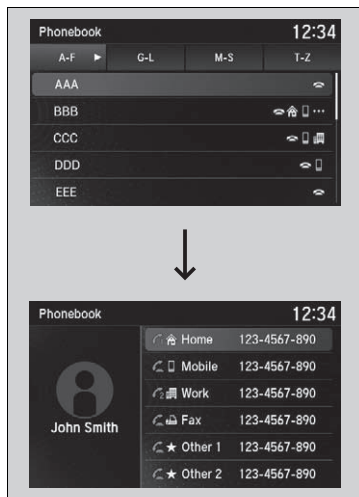

■ **To make a call using the imported phonebook**

1. Press the **PHONE** button.
2. Rotate to select **Phonebook**, then press .
3. Rotate to select a contact name, then press .
 - ▶ The phonebook is stored alphabetically.
4. Rotate to select a number, then press .

▶ Dialing starts automatically.

▶▶ To make a call using the imported phonebook

You can call a stored voice-tagged speed dial number, phonebook name, or number using voice commands.

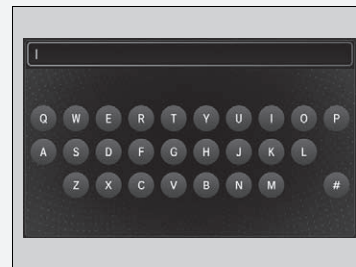

▶ **Speed Dial P. 336**

You can use the keyboard on the On Demand Multi-Use Display™ for an alphabetical search.





■ To make a call using a phone number

1. Press the **PHONE** button.
2. Rotate  to select **Dial**, then press .
3. Select a number.
 - ▶ Use the keyboard on the On Demand Multi-Use Display™ for entering numbers.
4. Select .

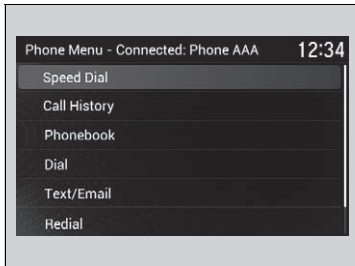

■ To make a call using redial

1. Press the **PHONE** button.
2. Rotate  to select **Redial**, then press .
 - ▶ Dialing starts automatically.

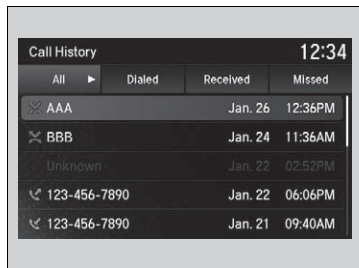

■ To make a call using the call history

Call history is stored by **All**^{*1}, **Dialed**, **Received**, and **Missed**.

1. Press the **PHONE** button.
2. Rotate to select **Call History**, then press .
3. Move or to select **All**^{*1}, **Dialed**, **Received**, and **Missed**.
4. Rotate to select a number, then press .
 - ▶ Dialing starts automatically.

▶▶ To make a call using the call history

The call history displays the last 20 dialed, received, or missed calls.
(Appears only when a phone is connected to HFL.)

These icons next to the number indicate the following:

- : Dialed calls.
- : Received calls.
- : Missed calls.

▶▶ Steering switches

The call history displays the last 12 dialed, received, or missed calls.

On Multi-Information Display

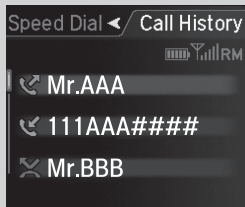

▶▶ Steering switches

1. Press the button.
2. Move the left selector wheel right to select **Call History**.
3. Roll the left selector wheel to select a number.
4. Push the left selector wheel or the button.
 - ▶ Dialing starts automatically.

*1: This function may not be available depending on a cellular phone.

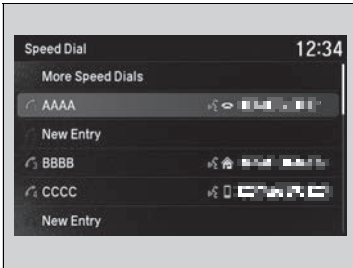

■ To make a call using a speed dial entry

1. Press the **PHONE** button.
2. Rotate to select **Speed Dial**, then press .
3. Rotate to select a number, then press .
 - ▶ Dialing starts automatically.

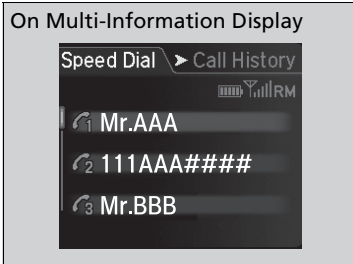

Steering switches

1. Press the button.
2. Move the left selector wheel left to select **Speed Dial**.
3. Roll the left selector wheel to select a number.
4. Push the left selector wheel or the button.
 - ▶ Dialing starts automatically.

▶▶ To make a call using a speed dial entry

Rotate to select **More Speed Dials** to view another paired phone's speed dial list. You can make a call from that list using the currently connected phone.

When a voice tag is stored, press the button to call the number using the voice tag.

Speed Dial P. 336

Any voice-tagged speed dial entry, phonebook name or number can be dialed by voice from any screen. Press the button and follow the prompts.



Steering switches

The speed dial displays the 20 speed dial entries.

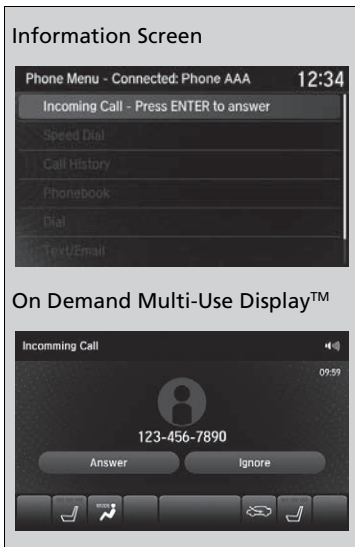

■ Receiving a Call



When there is an incoming call, an audible notification sounds (if activated) and the **Incoming Call** screen appears.

Press the  button to answer the call.
Press the  button to decline or end the call.

▶▶ Receiving a Call

Call Waiting
Press the  button to put the current call on hold to answer the incoming call.
Press the  button again to return to the current call.
Ignore the incoming call if you do not want to answer it.
Press the  button if you want to hang up the current call.

Options During a Call

The following options are available during a call.



Information Screen

Phone Call Active - Transfer to Mobile:

Transfer a call from HFL to your phone.

On Demand Multi-Use Display™

Mute: Mute your voice.

Transfer to Mobile: Transfer a call from HFL to your phone.

Touch Tones: Send numbers during a call. This is useful when you call a menu-driven phone system.

The available options are shown on the On Demand Multi-Use Display™.

Select the option.

- ▶ The **Mute** icon is checked when **Mute** is selected. Select **Mute** again to turn it off.



Options During a Call

Touch Tones: Available on some phones.

■ Receiving a Text/E-mail Message

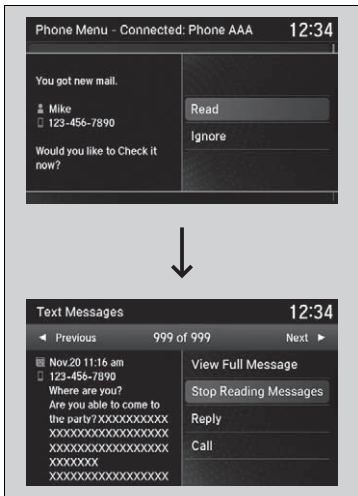
HFL can display newly received text and e-mail messages as well as 20 of the most recently received messages on a linked cell phone. Each received message can be read aloud and replied to using a fixed common phrase.



1. A pop-up appears and notifies you of a new text or e-mail message.
2. Rotate  to select **Read** to listen to the message, then press .
 - ▶ The text or e-mail message is displayed. The system automatically starts reading out the message.
3. To discontinue the message read-out, press .

▣ Receiving a Text/E-mail Message

The system does not display any received messages while you are driving. You can only hear them read aloud.

With some phones, you may be able to display up to 20 most recent text and e-mail messages.

State or local laws may limit your use of the HFL text/e-mail message feature. Only use the text/e-mail message feature when conditions allow you to do so safely.

When you receive a text or e-mail message for the first time since the phone is paired to HFL, you are asked to turn the **New Text/Email Alert** setting to **On**.

▶ **To turn on or off the text/e-mail message notice** P. 330

Selecting a Mail Account

If a paired phone has text message or mail accounts, you can select one of them to be active and receive notifications.

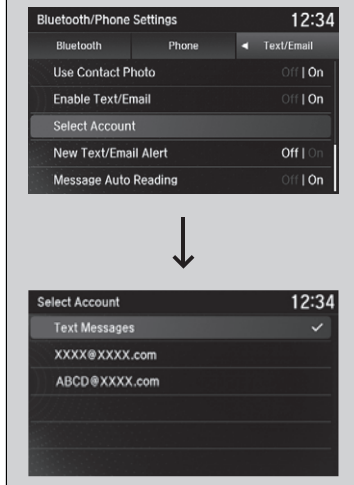

1. Press the **SETTINGS** button.
2. Rotate to select **Bluetooth/Phone Settings**, then press .
 - ▶ Repeat the procedure to select **Select Account**.
3. Rotate to select **Text Messages** or an e-mail account you want, then press .

Selecting a Mail Account

You can also select a mail account from the folder list screen or the message list screen. Rotate to select **Select Account**, then press .

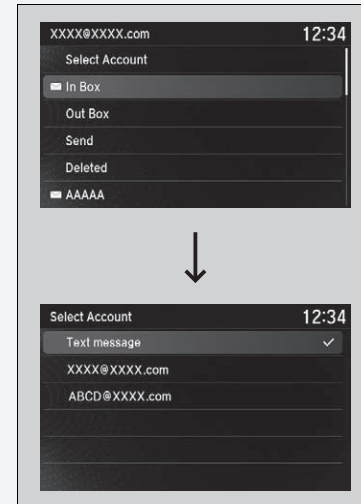

You can only receive notifications from one text message or mail account at a time.

■ Displaying Messages

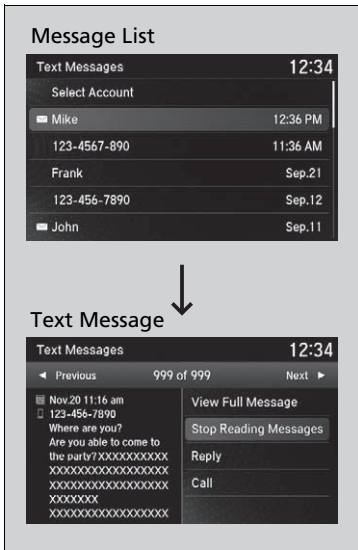

■ Displaying text messages

1. Press the **PHONE** button.
2. Rotate to select **Text/Email**, then press .
- ▶ Select account if necessary.
3. Rotate to select a message, then press .
- ▶ The text message is displayed. The system automatically starts reading the message aloud.
4. Rotate to select **View Full Message**.
5. Press to displays the full text of the message.

» Displaying Messages

The icon appears next to an unread message.

If you delete a message on the phone, the message will also be deleted from the system. If you send a message from the system, the message goes to your phone's outbox.

To see the previous or next message, move or on the text message screen.

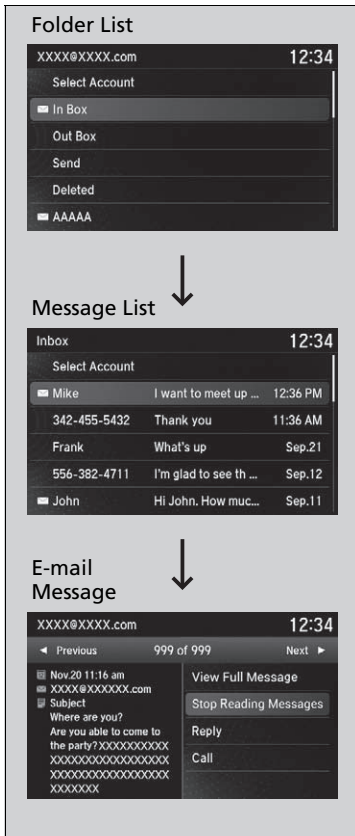

■ Displaying e-mail messages

1. Press the **PHONE** button.
2. Rotate to select **Text/Email**, then press .
3. Rotate to select a folder, then press .
4. Rotate to select a message, then press .
 - ▶ The e-mail is displayed. The system automatically starts reading the message aloud.
5. Rotate to select **View Full Message**.
6. Press to displays the full text of the message.

⌘ Displaying e-mail messages

Received text and e-mail messages may appear in the message list screen at the same time. In this case, text messages are titled **No Subject**.

Continued

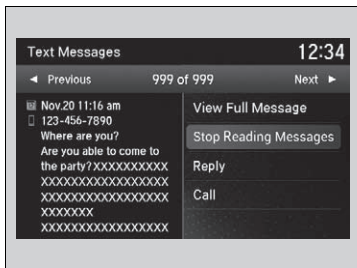

■ Read or stop reading a message

1. Go to the text or e-mail message screen.
 - ▶ The system automatically starts reading the message aloud.
 - ☑ **Displaying Messages** P. 348
2. Rotate to select **Stop Reading Messages**.
3. Press to stop reading. Press again to start reading the message from the beginning.

■ Reply to a message

1. Go to the text or e-mail message screen.
 - ▶ The system automatically starts reading the message aloud.
 - ☑ **Displaying Messages** P. 348
2. Rotate to select **Reply**, then press .
3. Rotate to select the reply message, then press .
 - ▶ **Message sent** appears on the screen when the reply message was successfully sent.

☒ Reply to a message

The available fixed reply messages are as follows:

- **Talk to you later, I'm driving.**
- **I'm on my way.**
- **I'm running late.**
- **OK**
- **Yes**
- **No**



You cannot add, edit, or delete reply messages.

Only certain phones receive and send messages when paired and connected. For a list of compatible phones:

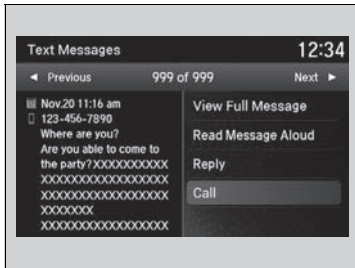
- U.S.: Visit www.acura.com/handsfreelink, or call 1-888-528-7876.
- Canada: Visit www.handsfreelink.ca, or call 1-888-528-7876.







■ Making a call to a sender

1. Go to the text message screen.
 - ▶ The system automatically starts reading the message aloud.
 - **Displaying text messages** P. 348
2. Rotate  to select **Call**, then press .

When you set the power mode to ON, the compass self-calibrates, and the compass display appears.

Compass Calibration

If the compass indicates the wrong direction, or the **CAL** indicator blinks, you need to manually calibrate the system.

1. Set the power mode to ON.
2. On the top screen of any source, press and hold  for five seconds.
 - ▶ The display switches to the **Compass Settings** screen.
3. Rotate  to select **Calibration**, then press .
4. When the display changes to **Calibration Start**, press .
5. Drive the vehicle slowly in two circles.
 - ▶ The compass starts to show a direction after the calibration. The **CAL** indicator goes off.

Compass*

Compass operation can be affected under the following conditions:

- Driving near power lines or stations
- Crossing a bridge
- Passing a large vehicle, or driving near a large object that can cause a magnetic disturbance
- When accessories such as antennas and roof racks are mounted by magnets

Compass Calibration

Calibrate the compass in an open area.





While setting the compass, press the **BACK** button to cancel the setting mode and return to the previous screen.

Models with navigation system

Models with navigation self-calibrate using GPS. The compass in the multi-information display and the direction arrow on the map screen (when Heading-Up view selected) may not be in sync when first starting the vehicle, but should correct themselves as you drive.

If the compass in the multi-information display continues to indicate an incorrect direction, please see your Acura dealer.

Compass Zone Selection

1. Set the power mode to ON.
2. On the top screen of any source, press and hold  for five seconds.
 - ▶ The display switches to the **Compass Settings** screen.
3. Rotate  to select **Zone Adjust**, then press .
 - ▶ The display shows the current zone number the system is set to.
4. To change the zone, rotate  to select the zone number of your area (See Zone Map), then press .

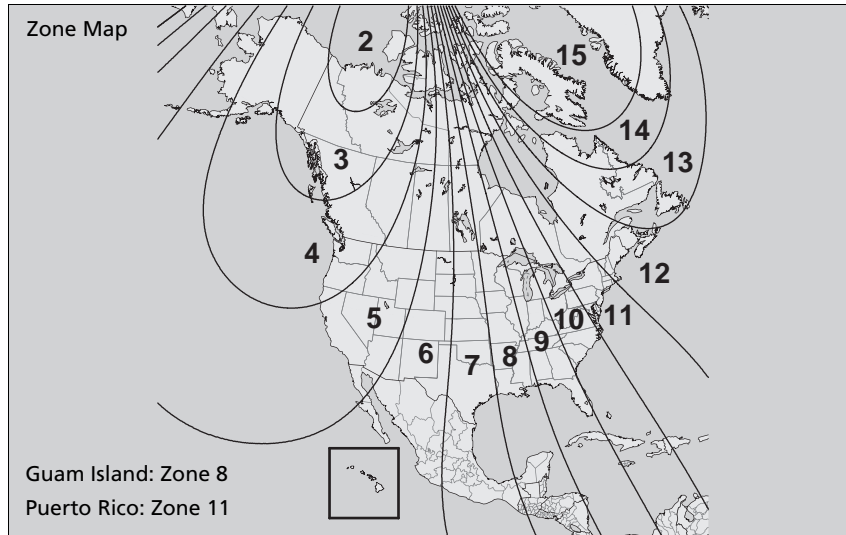

☒ Compass Zone Selection

The zone selection is done to compensate the variation between magnetic north and true north.

If the calibration starts while the audio system is in use, the display returns to normal after the calibration is completed.

Driving

This chapter discusses driving and refueling.



| | |
|---|-----|
| Before Driving | 356 |
| Towing a Trailer | 361 |
| When Driving | |
| Starting the Engine | 362 |
| Precautions While Driving..... | 369 |
| Automatic Transmission * | 370 |
| Dual Clutch Transmission * | 370 |
| Models with electronic gear selector | |
| Shifting | 371 |
| Models with shift lever | |
| Shifting | 378 |
| Auto Idle Stop * | 382 |
| Integrated Dynamics System..... | 388 |

| | |
|--|-----|
| Front Sensor Camera | 389 |
| Adaptive Cruise Control (ACC) with Low Speed Follow (LSF) | 391 |
| Road Departure Mitigation (RDM) System ... | 405 |
| Lane Keeping Assist System (LKAS) .. | 410 |
| Vehicle Stability Assist (VSA®), aka Electronic Stability Control (ESC), System | 418 |
| Agile Handling Assist | 420 |
| Precision All-Wheel Steer™ (P-AWS®) System * | 420 |
| Blind spot information (BSI) System* | 421 |
| Super Handling-All Wheel Drive™ (SH- AWD®)* | 424 |

| | |
|--|-----|
| Tire Pressure Monitoring System (TPMS) with Tire Fill Assist..... | 425 |
| Tire Pressure Monitoring System (TPMS) - Required Federal Explanation | 427 |
| Braking | 429 |
| Parking Your Vehicle | 446 |
| Multi-View Rear Camera* | 457 |
| Surround View Camera System* | 459 |
| Refueling | 460 |
| Fuel Economy and CO₂ Emissions | 463 |

* Not available on all models

Driving Preparation

Check the following items before you start driving.

Exterior Checks

- Make sure there are no obstructions on the windows, door mirrors, exterior lights, or other parts of the vehicle.
 - ▶ Remove any frost, snow, or ice.
 - ▶ Remove any snow on the roof, as this can slip down and obstruct your field of vision while driving. If frozen solid, remove ice once it has softened.
 - ▶ When removing ice from around the wheels, be sure not to damage the wheel or wheel components.
- Make sure the hood is securely closed.
 - ▶ If the hood opens while driving, your front view will be blocked.
- Make sure the tires are in good condition.
 - ▶ Check air pressures, and check for damage and excessive wear.
 - 🔧 **Checking and Maintaining Tires** P. 495
- Make sure there are no people or objects behind or around the vehicle.
 - ▶ There are blind spots from the inside.

Exterior Checks

NOTICE

When doors are frozen shut, use warm water around the door edges to melt any ice. Do not try to force them open, as this can damage the rubber trim around the doors. When done, wipe dry to avoid further freezing.

Do not pour warm water into the key cylinder. You will be unable to insert the key if the water freezes in the hole.

Heat from the engine and exhaust can ignite flammable materials left under the hood, causing a fire. If you've parked your vehicle for an extended period, inspect and remove any debris that may have collected, such as dried grass and leaves that have fallen or have been carried in for use as a nest by a small animal. Also check under the hood for leftover flammable materials after you or someone else has performed maintenance on your vehicle.

Interior Checks

- Store or secure all items on board properly.
 - ▶ Carrying too much cargo, or improperly storing it, can affect your vehicle's handling, stability, stopping distance, and tires, and make it unsafe.
 - ✦ **Maximum Load Limit** P. 359
- Do not pile items higher than the seat height.
 - ▶ They can block your view and may be thrown forward in the event of sudden braking.
- Do not place anything in the front seat footwells. Make sure to secure the floor mat.
 - ▶ An object or unsecured floor mat can interfere with your brake and accelerator pedal operation while driving.
- If you have any animals on board, do not let them move around in the vehicle.
 - ▶ They may interfere with driving and a crash could occur.
- Securely close and lock all doors and the trunk.
 - ✦ **Locking/Unlocking the Doors from the Inside** P. 144
- Adjust your seating position properly.
 - ▶ Adjust the head restraint, too.
 - ✦ **Adjusting the Seats** P. 179
 - ✦ **Adjusting the Front and Rear Outer Head Restraint Positions** P. 182
- Adjust the mirrors and steering wheel properly for your driving.
 - ▶ Adjust them while sitting in the proper driving position.
 - ✦ **Adjusting the Mirrors** P. 176
 - ✦ **Adjusting the Steering Wheel** P. 175

Interior Checks

The headlight aim is set by the factory, and does not need to be adjusted. However, if you regularly carry heavy items in the trunk have the aiming readjusted at a dealer or by a qualified technician.

- Be sure items placed on the floor behind the front seats cannot roll under the seats.
 - ▶ They can interfere with the driver's ability to operate the pedals, the operation of the seats, or the operation of the sensors under the seats.
- Everyone in the vehicle must fasten their seat belt.
 - 📄 **Fastening a Seat Belt** P. 37
- Make sure that the indicators in the instrument panel come on when you start the vehicle, and go off soon after.
 - ▶ Always have a dealer check the vehicle if a problem is indicated.
 - 📄 **Indicators** P. 72

Maximum Load Limit

The maximum load for your vehicle is 850 lbs (385 kg). See the Tire and Loading Information label attached to the driver's doorjamb.

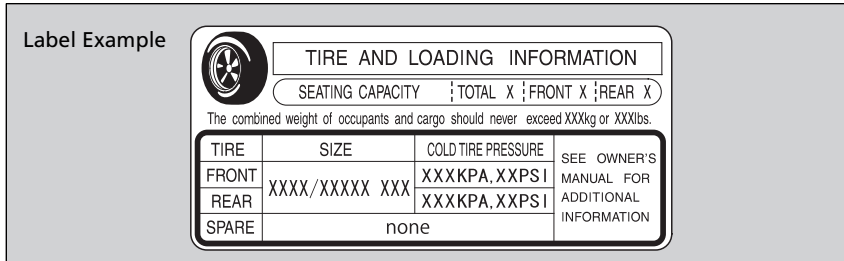

This figure includes the total weight of all occupants, cargo, and accessories, and the tongue load if you are towing a trailer.

Steps for Determining Correct Load Limit -

- (1) Locate the statement "The combined weight of occupants and cargo should never exceed XXX kg or XXX lbs." on your vehicle's placard.
- (2) Determine the combined weight of the driver and passengers that will be riding in your vehicle.
- (3) Subtract the combined weight of the driver and passengers from XXX kg or XXX lbs.
- (4) The resulting figure equals the available amount of cargo and luggage load capacity. For example, if the "XXX" amount equals 1,400 lbs. and there will be five 150 lb. passengers in your vehicle, the amount of available cargo and luggage load capacity is 650 lbs.
(1,400 - 750 (5 x 150) = 650 lbs.)

Continued

Maximum Load Limit

⚠ WARNING

Overloading or improper loading can affect handling and stability and cause a crash in which you can be hurt or killed.

Follow all load limits and other loading guidelines in this manual.

Gross Vehicle Weight Rating (GVWR):

The maximum allowable weight of the vehicle, all occupants, all accessories and all cargo.

➤ **Specifications** P. 566, 566

Gross Axle Weight Rating (GAWR):



The maximum allowable weight of the vehicle axle.



➤ **Specifications** P. 566, 566

- (5) Determine the combined weight of luggage and cargo being loaded on the vehicle. That weight may not safely exceed the available cargo and luggage load capacity calculated in step 4.
- (6) If your vehicle will be towing a trailer, load from your trailer will be transferred to your vehicle. Consult this manual to determine how this reduces the available cargo and luggage load capacity of your vehicle.

In addition, the total weight of the vehicle, all occupants, accessories, cargo, and trailer tongue load must not exceed the Gross Vehicle Weight Rating (GVWR) or the Gross Axle Weight Rating (GAWR). Both are on a label on the driver's doorjamb.

Load Limits Example

| | | | | |
|---|--------|---|----------|---|
| <p>Example 1</p>  <p>Max Load 850 lbs (385 kg)</p> | \geq |  | <p>+</p> |  |
| | | <p>Passenger Weight 150 lbs x 2 = 300 lbs (68 kg x 2 = 136 kg)</p> | | <p>Cargo Weight 550 lbs (249 kg)</p> |

| | | | | |
|---|--------|---|----------|---|
| <p>Example 2</p>  <p>Max Load 850 lbs (385 kg)</p> | \geq |  | <p>+</p> |  |
| | | <p>Passenger Weight 150 lbs x 5 = 750 lbs (68 kg x 5 = 340 kg)</p> | | <p>Cargo Weight 100 lbs (45 kg)</p> |

Your vehicle is not designed to tow a trailer. Attempting to do so can void your warranties.

Towing Your Vehicle

Your vehicle is not designed to be towed behind a motor home. If your vehicle needs to be towed in an emergency, refer to the emergency towing information.

📄 **Emergency Towing** P. 560

Starting the Engine

Models with electronic gear selector



1. Make sure the parking brake is applied.
 - ▶ The electric parking brake indicator comes on for 15 seconds when you pull up the electric parking brake switch.

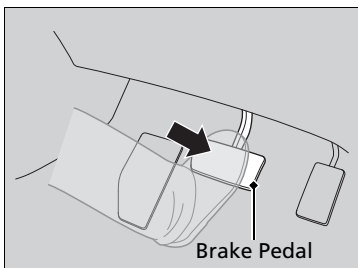

2. Depress the brake pedal.

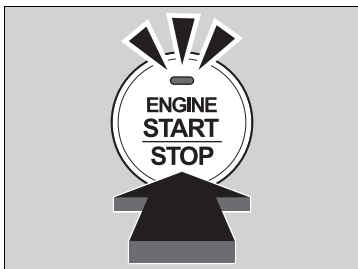

3. Press the **ENGINE START/STOP** button without depressing the accelerator pedal.

Starting the Engine

Keep your foot firmly on the brake pedal when starting the engine.

The engine is harder to start in cold weather and in thinner air found at altitudes above 8,000 feet (2,400 meters).

When starting the engine in cold weather, turn off all electrical accessories such as the lights, climate control system, and rear defogger in order to reduce battery drain.

If you live in a region where winter is extremely cold, an engine block heater will improve starting and warming of the engine. Consult a dealer for details.

If the exhaust system sounds abnormal or you can smell exhaust gas inside the vehicle, have your vehicle checked by a dealer. There may be a problem with the engine or exhaust system.

Models with shift lever

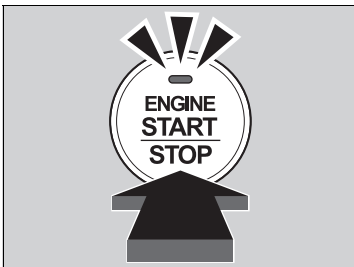
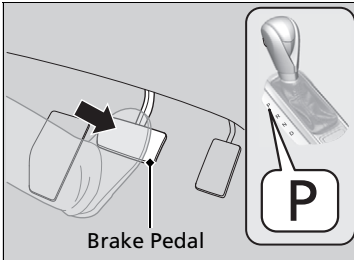
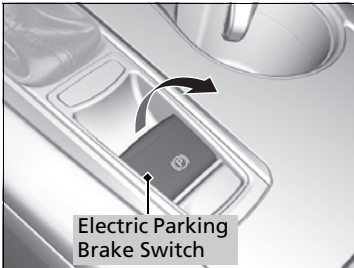

1. Make sure the parking brake is applied.
 - ▶ The electric parking brake indicator comes on for 15 seconds when you pull up the electric parking brake switch.

2. Check that the transmission is in **P**, then depress the brake pedal.
 - ▶ Although it is possible to start the vehicle in **N**, it is safer to start it in **P**.

3. Press the **ENGINE START/STOP** button without depressing the accelerator pedal.

▶▶ Starting the Engine

The immobilizer system protects your vehicle from theft.

If an improperly coded device is used, the engine's fuel system is disabled.

▶ **Immobilizer System** P. 151

Bring the keyless access remote close to the **ENGINE START/STOP** button if the battery in the keyless access remote is weak.

▶ **If the Keyless Access Remote Battery is Weak** P. 540

The engine may not start if the keyless access remote is subjected to strong radio waves.

■ Stopping the Engine

You can turn the engine off when the vehicle is completely stopped.

1. Put the transmission into **P**.
2. Press the **ENGINE START/STOP** button.

Remote Engine Start with Vehicle Feedback *

You can remotely start the engine using the two-way keyless access remote from extended distances.

To start the engine

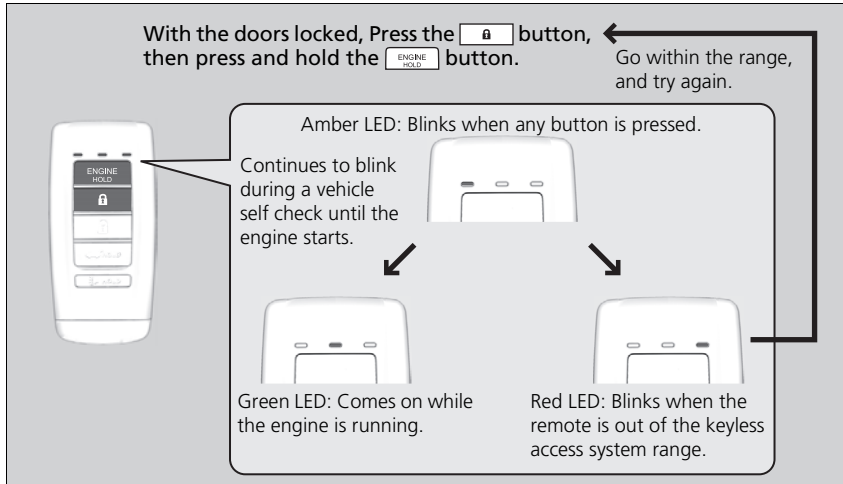

The engine runs for up to 10 minutes without you starting the vehicle. To extend the run time for another 10 minutes during the first run, press the **[a]** button, then press and hold the **[ENGINE HOLD]** button.

- ▶ The amber LED blinks, then the green LED comes back on if a 10-minute extension request was transmitted successfully.

After pressing the (lock) button, wait for the green LED to blink. This indicates that the all the doors and the trunk are locked.

* Not available on all models

Continued

Remote Engine Start with Vehicle Feedback *

WARNING: Carbon monoxide gas is toxic and can rapidly accumulate in closed or even partly enclosed areas.

Breathing it can cause unconsciousness and even kill you.

Never use the remote engine starter with the vehicle parked in a garage or other areas with limited ventilation.

If there are buildings and obstacles between your vehicle and the remote, the range will be reduced. This distance may vary by external electrical interference.

The engine may not start by the remote engine start if:

- You have disabled a remote engine start setting using the multi-information display.
- The power mode is not in VEHICLE OFF (LOCK).
- The transmission is in a position other than **[P]**.
- The hood is open, or any door or the trunk is unlocked.
- You have already used the remote twice to start the engine.
- Another registered keyless access remote is in the vehicle.

■ To stop the engine

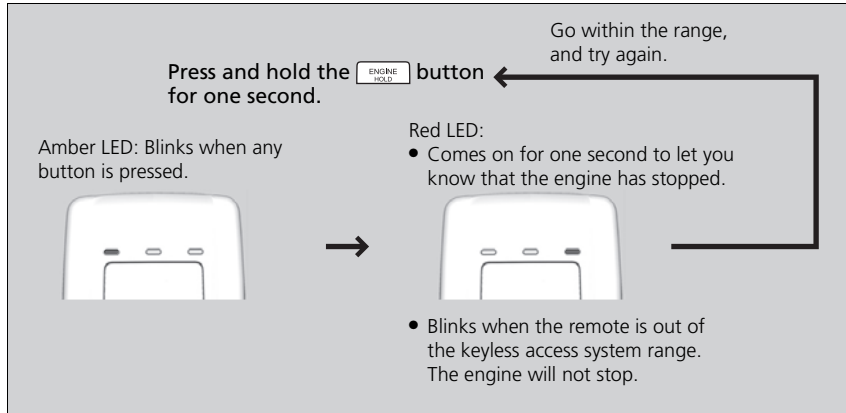

⊠ Remote Engine Start with Vehicle Feedback*

- There is any antenna failure.
- Door is unlocked with the built-in key.
- The engine oil pressure is low.
- The engine coolant temperature is extremely high.
- The telematics unit malfunctions.
- The security system alarm is not set.

Before starting the engine, make sure to check the door lock status using the remote. When you press the  button, wait for the green LED to blink. If the red LED turns on, the doors and trunk did not lock, and the engine does not start.

While the engine is running, the vehicle will automatically precondition inside the vehicle. When it is warm outside:

- The air conditioning is activated in recirculation mode.
- The seat ventilation is activated*.

When it is cold outside:

- The defroster is activated at a moderately warm temperature.
- The rear defogger and door mirror heaters are activated.
- The seat heaters and heated steering wheel are activated*.

⊠ **Heated Steering Wheel*** P. 201

⊠ **Front Seat Heaters and Seat Ventilation*** P. 202

Starting to Drive

When the engine was started using the two-way keyless access remote*

1. While depressing the brake pedal, press the **ENGINE START/STOP** button.

When the engine was started in any case

2. Keeping your right foot on the brake pedal, change the gear position to **[D]** button. Select **[R]** when reversing.
3. With the parking brake applied, release the brake pedal and gently depress the accelerator pedal.
 - ▶ Make sure the electric parking brake indicator goes off.
 - ✦ **Parking Brake** P. 429
 - ✦ **If the Transmission System Indicator Blinks along with the Warning Message** P. 554

Starting to Drive

You can also release the parking brake by pressing the electric parking brake switch while depressing the brake pedal.

When facing downhill, you can start your vehicle more smoothly by manually releasing it with the electric parking brake switch than by releasing it with the accelerator pedal.

When the engine was started using the two-way keyless access remote*

The engine stops when the gear position is changed from **[P]** before the **ENGINE START/STOP** button is pressed. Follow the step 1 when starting to drive.

■ Hill Start Assist System

Hill start assist keeps the brake engaged briefly to help prevent the vehicle from rolling on inclines as you move your foot from the brake pedal to the accelerator.

Change the gear position to **D** when facing uphill, or **R** when facing downhill, then release the brake pedal.

ⓘ Hill Start Assist System

Hill start assist may not prevent the vehicle from rolling downhill on a very steep or slippery slope, and does not operate on small inclines.

Hill start assist is not a replacement for the parking brake.

Hill start assist will operate even when VSA® is switched off.

Precautions While Driving

In Rain

Avoid driving in deep water and on flooded roads. This can damage the engine or driveline, or cause electrical component failure.

⌘ Precautions While Driving

NOTICE

Do not change the gear position while pressing the accelerator pedal. You could damage the transmission.

NOTICE

If you repeatedly turn the steering wheel at an extremely low speed, or hold the steering wheel in the full left or right position for a while, the electric power steering (EPS) system heats up. The system goes into a protective mode, and limits its performance. The steering wheel becomes harder and harder to operate. Once the system cools down, the EPS system is restored. Repeated operation under these conditions can eventually damage the system.

If the power mode is set to ACCESSORY while driving, the engine will shut down and all steering and brake power assist functions will stop, making it difficult to control the vehicle.

■ Other Precautions

If there is a strong impact with something under the vehicle, stop in a safe location. Check the underside of the vehicle for damage or any fluid leaks.

Automatic Transmission *

■ Creeping

The engine runs at a higher idle speed and creeping increases. Keep the brake pedal firmly depressed when stopped.

■ Kickdown

Quickly depressing the accelerator pedal while driving uphill may cause the transmission to drop to a lower gear, unexpectedly increasing vehicle speed. Depress the accelerator pedal carefully, especially on slippery roads and curves.

Dual Clutch Transmission *

■ Creeping

As with a conventional automatic transmission, this vehicle will creep. Keep the brake pedal firmly depressed when stopped.

■ Kickdown

Quickly depressing the accelerator pedal while driving uphill may cause the transmission to drop to a lower gear, unexpectedly increasing vehicle speed. Depress the accelerator pedal carefully, especially on slippery roads and curves.

⌘ Precautions While Driving

Do not change the gear position to **[N]**, as you will lose engine braking (and acceleration) performance.

During the first 600 miles (1,000 km) of operation, avoid sudden acceleration or full throttle operation so as not to damage the engine or powertrain.

Avoid hard braking for the first 200 miles (300 km). You should also follow this when the brake pads are replaced.

Models with electronic gear selector

Shifting

Change the gear position in accordance with your driving needs.

■ Shift button positions

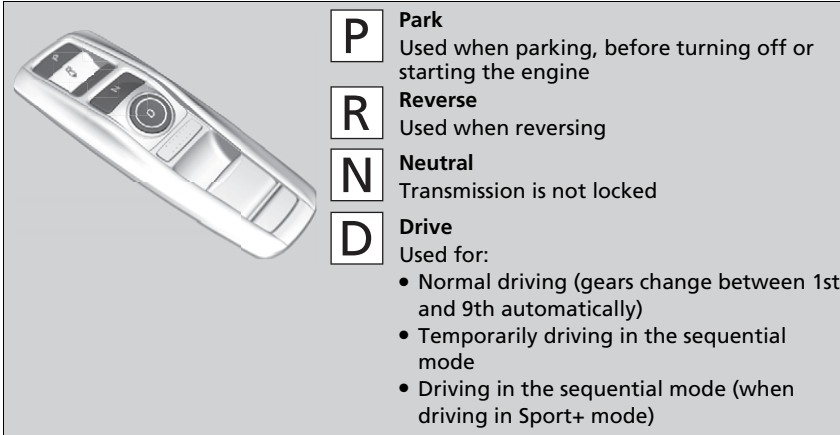

■ **P** (park) button

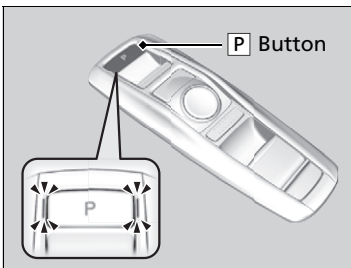

The gear position changes to **P** when you press the **P** button while the vehicle is parked with the power mode in ON. The indicators on the sides of the **P** button come on.

▶ Shifting

To prevent malfunction and unintended engagement:

- Do not spill any liquids on or around shift buttons.
- Do not place or drop any objects on or around shift buttons.
- Do not let passengers or children operate the shift buttons.

⚠ WARNING

The vehicle can roll away if left unattended without confirming that Park is engaged.

A vehicle that rolls away could cause a crash resulting in serious injury or death.

Always keep your foot on the brake pedal until you have confirmed that **P** is shown on the gear position Indicator.

The beeper sounds when you depress the accelerator pedal with the gear position in **N**. Change the gear position to **D** or **R** with the brake pedal depressed.

When shifting gears in extremely low temperatures (–22°F/–30°C), there may be a short delay before the shift is indicated in the display. Always confirm you are in the correct gear before driving.

Continued

■ Shift Operation

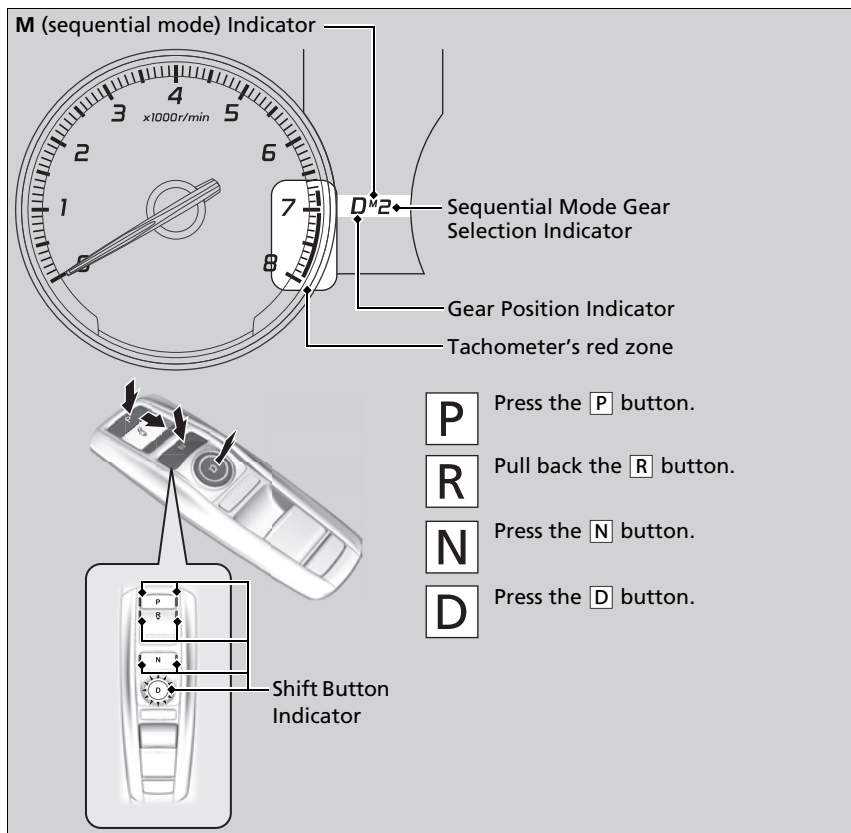

▶ Shift Operation

NOTICE

When you change **D** to **R** and vice versa, come to a complete stop and keep the brake pedal depressed. Operating the shift button before the vehicle has come to a complete standstill can damage the transmission.

Use the gear position indicator and the shift button indicator to check the gear position before selecting a shift button.

If the indicator of the currently selected gear position, or all the gear position indicators are blinking simultaneously, there is a problem with the transmission.

Avoid sudden acceleration and have the transmission checked by a dealer as soon as possible.

The fuel supply may be cut off if you drive at engine speeds in or over the tachometer's red zone (engine speed limit). If this happens, you may experience a slight jolt.

When the engine speed is increased while the transmission is in **N**, **P** or **R**, the fuel supply may be cut off even without the engine speed entering the tachometer's red zone.

The beeper sounds once when you change to **R**.

In freezing or sub-freezing conditions, the gear selection response may be slow. Always depress the brake pedal before changing the gear position to **P**, and confirm that **P** is shown on the gear position indicator before releasing the brake.

■ When opening the driver's door

If you open the driver's door under the following conditions, the gear position automatically changes to **P**.

- The vehicle is in stationary with the engine running, or moving at 1 mph (2 km/h) or slower.
- The transmission is in other than **P**.
- You have unfastened the driver side seat belt.

▶ If you manually change the gear position from **P** with the brake pedal depressed, the gear position will automatically return to **P** once you release the brake pedal.

■ When turning off the power mode

If you turn the engine off while the vehicle is stationary, and the transmission is in other than **P**, the gear position automatically changes to **P**.

▣ When opening the driver's door

While the system is designed to automatically change the gear position to **P** under the described conditions, in the interest of safety you should always select **P** before opening the driver's door. Make sure to park the vehicle in a safe place.

➤ **When Stopped** P. 446

If you want to drive the vehicle after the gear position has automatically changed to **P** under the described conditions, close the door, fasten the seat belt, depress the brake pedal, then change the gear position.

If you leave the vehicle, turn off the engine and lock the doors.

■ **If you want to keep the transmission in **N** position [car wash mode]**

With the engine running:

1. Press and hold the brake pedal.
2. Select **N**, then release the button to display **N** (Neutral) hold mode on the multi-information display.
3. Press and hold **N** again for two seconds.
 - ▶ This puts the vehicle in car wash mode which must be used when your vehicle is pulled through a conveyor type automatic car wash where you or an attendant do not remain in the vehicle.

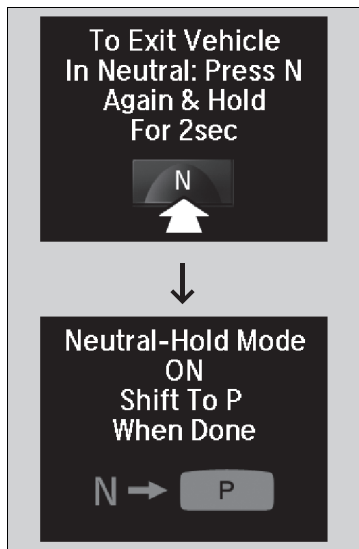

If the **ENGINE STOP/START** button is pressed after car wash mode has been activated, the power mode will change to ACCESSORY and a message will be displayed on the multi-information display.

- ▶ The gear position remains in **N** with the power mode in ACCESSORY for 15 minutes, then, it automatically changes to **P** and the power mode changes to OFF.
- ▶ Manually changing to **P** cancels ACCESSORY mode. The **P** indicator comes on and the power mode changes to OFF. You must always shift to **P** when car wash mode is no longer needed.

⌘ If you want to keep the transmission in **N** position [car wash mode]

The transmission may not stay in **N** position while the following indicators are on or when the message below appears:

- Malfunction indicator lamp
- Transmission system indicator
- Charging system indicator
- The **Charging System Problem** message on the multi-information display.

■ Restriction on selecting a gear position

You cannot select a gear position under certain circumstances that may lead to a crash.

| When the transmission is in: | 1. Under the circumstances of that: | 2. You cannot select: | 3. The gear position remains in/changes to: | How to change the gear position | | |
|-----------------------------------|--|-----------------------|---|--|----------|---|
| P | The brake pedal is not depressed. | Other gear position | P | Release the accelerator pedal and depress the brake pedal. | | |
| | The accelerator pedal is depressed. | | | | | |
| N | The vehicle is moving at low speed without the brake pedal depressed. | | N | | | |
| | The vehicle is moving at low speed with the accelerator pedal depressed. | | | | | |
| N or D | The vehicle is moving forward. | | R | | N | Stop your vehicle in a safe place, depress the brake pedal, and select the appropriate gear position. |
| R or N | The vehicle is moving backward. | | D | | | |
| R , N , or D | The vehicle is moving. | P | | | | |

■ Sequential Mode

Use the paddle shifters to change between 1st and 9th gears without releasing your hands from the steering wheel. The transmission will switch to the sequential mode.

■ When the transmission is in **[D]**:

The vehicle will go into the sequential mode momentarily, and the sequential mode gear selection indicator will come on.

When the vehicle goes into the sequential mode by **[−]** paddle shifter and the lower gear is available, the transmission properly selects single or double gear change.

Once you start traveling at a constant speed, the sequential mode will automatically switch off, and the sequential mode gear selection indicator will go off.

Hold the **[+]** paddle shifter for two seconds or push the **[D]** button to return to normal drive.

■ When the transmission is in **[D]** with Sport+ mode:

The vehicle will go into the sequential mode, and the **M** (sequential mode) indicator and sequential mode gear selection indicator will come on.

If the vehicle speed increases and the engine speed reaches near the tachometer's red zone, the transmission automatically shifts up to the next gear.

You can cancel this mode by pressing **Dynamic Mode** button to select other than Sport+ mode or push the **[D]** button to return to normal drive Sport+ mode. When the sequential mode is canceled, the sequential mode indicator and sequential mode gear selection indicator will turn off.

Sequential Mode Operation

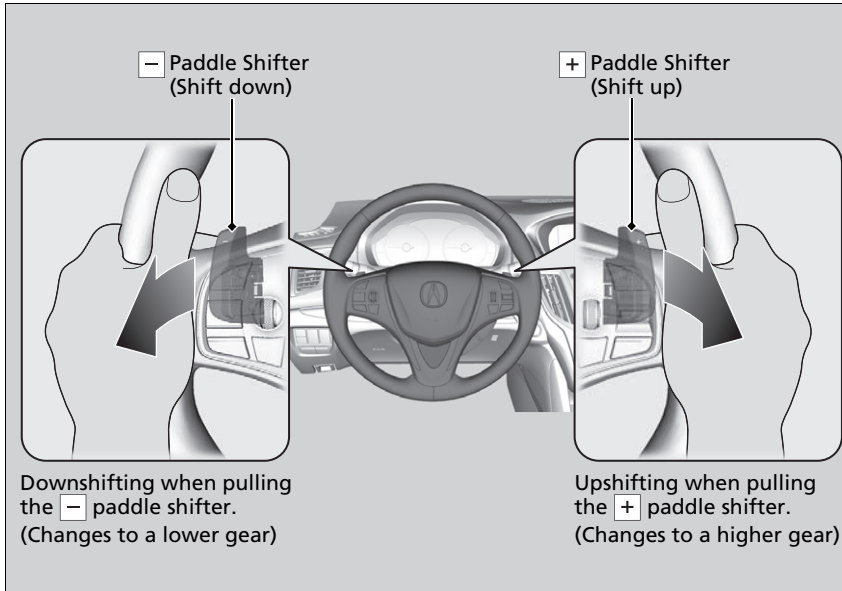

Sequential Mode Operation

Each paddle shift operation makes a single gear change.

To change gears continuously, release the paddle shifter before pulling it again for the next gear.

If the sequential mode gear selection indicator blinks when you try to shift up or down, this means your vehicle speed is not in its allowable gear range. Slightly accelerate to shift up and decelerate to shift down while the indicator is blinking.

Models with shift lever

Shifting

Change the shift position in accordance with your driving needs.

■ Shift lever positions

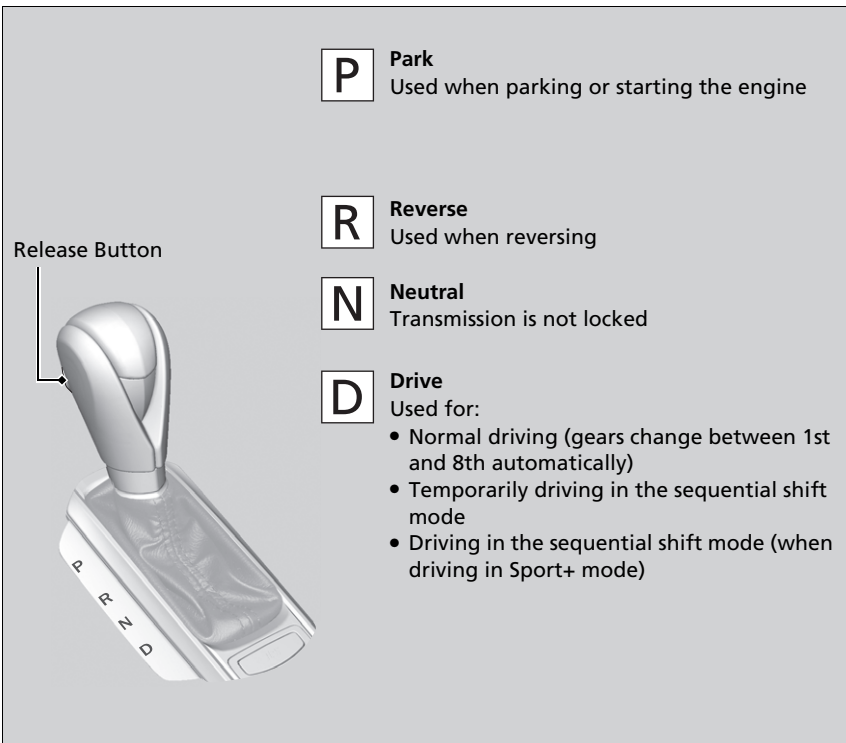

▶ Shift lever positions

You cannot change the power mode from ON to VEHICLE OFF (LOCK) unless the shift lever is in **P**.

The vehicle may move very slightly even in **N** while the engine is cold.

Depress the brake pedal firmly and, when necessary, apply the parking brake.

When shifting gears in extremely low temperatures (-22°F/-30°C), there may be a short delay before the shift is indicated in the display. Always confirm you are in the correct gear before driving.

Shift Lever Operation

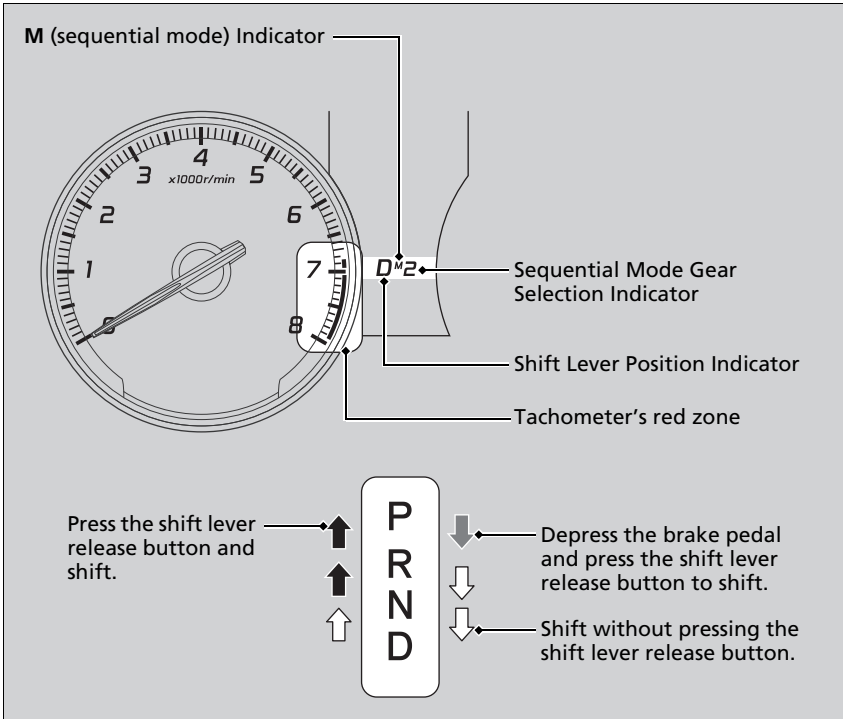

Shift Lever Operation

NOTICE

When you change the shift lever from **[D]** to **[R]** and vice versa, come to a complete stop and keep the brake pedal depressed. Operating the shift lever before the vehicle has come to a complete standstill can damage the transmission.

Use the shift lever position indicator to check the lever position before pulling away.

Whichever position the shift lever is in when driving, a blinking transmission system indicator indicates a transmission problem. Avoid sudden acceleration and have the transmission checked by a dealer as soon as possible.

The fuel supply may be cut off if you drive at engine speeds in or over the tachometer's red zone (engine speed limit). If this happens, you may experience a slight jolt.

When the engine speed is increased while the shift lever is in **[N]**, **[P]** or **[R]**, the fuel supply may be cut off even without the engine speed entering the tachometer's red zone.

It may not be possible to operate the shift lever if the brake pedal is applied while the shift lever release button is held down. Depress the brake pedal first.

■ Sequential Shift Mode

Use the paddle shifters to change between 1st and 8th gears without releasing your hands from the steering wheel. The transmission will switch to the sequential shift mode.

■ When the shift lever is in **D**:

The vehicle will go into the sequential shift mode momentarily, and the sequential mode gear selection indicator will come on.

Once you start traveling at a constant speed, the sequential shift mode will automatically switch off, and the sequential mode gear selection indicator will go off.

Hold the **+** paddle shifter for two seconds to return to normal drive.

■ When the shift lever is in **D** with Sport+ mode:

The vehicle goes into sequential shift mode and the **M** (sequential shift) indicator comes on. At speeds of 2 mph (4 km/h) or less, the vehicle automatically shifts down into 1st gear.

If you are in 1st through 6th gears and do not operate the paddle shifters as engine speed increases approaches the tachometer red zone, the transmission automatically shifts up to the next gear.

You can cancel Sport+ mode by either:

- Pressing the **Dynamic Mode** button.
- Or holding the **+** paddle shifter for two seconds.

When the mode is canceled the sequential mode and sequential mode gear indicators will turn off.

■ Second gear lock mode

If you pull the **+** paddle shifter while stopped or driving at 6 mph (10 km/h) or less, the gear position will be locked in 2nd gear. This makes it easier to pull away on slippery surfaces such as snow covered roads.

To cancel the 2nd gear lock mode, pull the **-** paddle shifter.

■ Sequential Shift Mode Operation

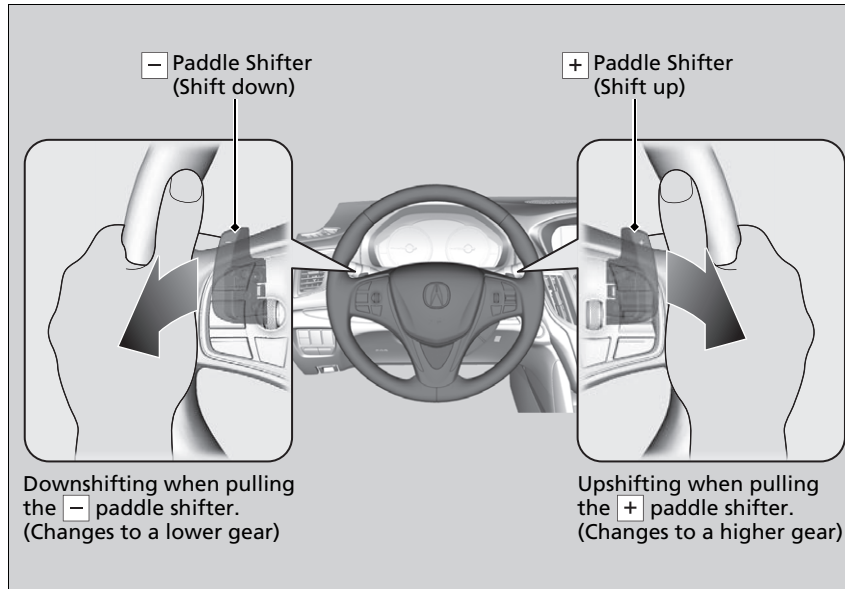

▣ Sequential Shift Mode Operation

Each paddle shift operation makes a single gear change.

To change gears continuously, release the paddle shifter before pulling it again for the next gear.

If the gear position indicator blinks when you try to shift up or down, this means your vehicle speed is not in its allowable gear range.

Slightly accelerate to shift up and decelerate to shift down while the indicator is blinking.

Auto Idle Stop*

To help maximize fuel economy, the engine automatically stops when the vehicle comes to a stop, depending on environmental and vehicle operating conditions. The indicator (green) comes on.

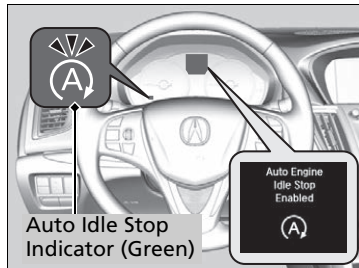

The engine then restarts once the vehicle is about to move again, or depending on environmental and vehicle conditions, and the indicator (green) goes off.

➤ The Engine Automatically Restarts When:

P. 386

A message associated with Auto Idle Stop appears on the multi-information display.

➤ Indicators P. 89

➤ Customized Features P. 124, 301

If the driver's door is opened while the indicator (green) comes on, a buzzer sounds to notify you that the Auto Idle Stop function is in operation.

➤ Auto Idle Stop*

The 12-volt battery installed in this vehicle is specifically designed for a model with Auto Idle Stop. Using a 12-volt battery other than this specified type may shorten the battery life, and prevent Auto Idle Stop from activating. If you need to replace the battery, make sure to select the specified type. Ask a dealer for more details.

The duration of the Auto Idle Stop operation:

- **Increase** in the ECON mode, compared to when the ECON mode is off, with climate control in use.

Auto Idle Stop may activate less frequently in such conditions as a traffic jam.

■ Auto Idle Stop System ON/OFF

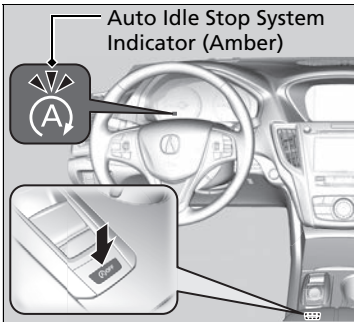

To turn the Auto Idle Stop system off, press this button. The Auto Idle Stop system stops.

- ▶ Auto Idle Stop system will stop and the Indicator (amber) will come on.

The Auto Idle Stop system is turned on every time you start the engine, even if you turned it off the last time you drove the vehicle.



☒ Auto Idle Stop System ON/OFF

Pressing the Auto Idle Stop **OFF** button restarts the engine during the Auto Idle Stop activated.

■ Auto Idle Stop Activates When:

The vehicle stops with the gear position in **D** and the brake pedal depressed.

■ Auto Idle Stop does not activate when:

- The driver's seat belt is not fastened.
- The engine coolant temperature is low or high.
- The transmission fluid temperature is low or high.
- The vehicle comes to a stop again before the vehicle speed reaches 3 mph (5 km/h) after the engine starts.
- Stopped on a steep incline.
- The transmission is in a position other than **D** or Sport+.
- The engine is started with the hood open.
 - ▶ Turn off the engine. Close the hood before you restart the engine to activate Auto Idle Stop.
-  is on (indicator (amber) on).
- The battery charge is low.
- The internal temperature of the battery is 14°F (-10°C) or less.
- The climate control system is in use, and the outside temperature is below -4°F (-20°C) or over 104°F (40°C).
- The climate control system is in use, and the temperature is set to **Hi** or **Lo**.
-  is ON (indicator on).

⌘ Auto Idle Stop Activates When:

When ACC with LSF is in operation, the vehicle stops without depressing the brake pedal and Auto Idle Stop may activate.

Do not open the hood while the Auto Idle Stop function is activated. If the hood is opened, the engine will not restart automatically.

In this case, restart the engine with the **ENGINE START/STOP** button.

▶ **Starting the Engine** P. 362

Pressing the **ENGINE START/STOP** button changes the power mode to ACCESSORY even while Auto Idle Stop is in operation. Once in ACCESSORY, the engine no longer restarts automatically. Follow the standard procedure to start the engine.

▶ **Starting the Engine** P. 362

■ Auto Idle Stop may not activate when:

- The vehicle is stopped by braking suddenly.
- The steering wheel is operated.
- The fan speed is high.
- Altitude is high.
- The vehicle is repeatedly accelerated and decelerated at a low speed.
- The climate control system is in use, and there is a significant difference between the set temperature and the actual interior temperature.
- Humidity in the interior is high.

■ The Engine Automatically Restarts When:

- The brake pedal is released (without the automatic brake hold system activated).
- The accelerator pedal is depressed (with the automatic brake hold system activated).

➤ **Automatic Brake Hold** P. 433

■ The engine restarts even if the brake pedal is depressed*1 when:

- The Auto Idle Stop **OFF** button is pressed.
- A steering wheel is operated.
- The transmission is in a position other than **D** or Sport+.
- The pressure on the brake pedal is reduced and the vehicle starts moving while stopped on an incline.
- The pressure on the brake pedal is repeatedly applied and released slightly during a stop.
- The battery charge becomes low.
- The accelerator pedal is depressed.
- The driver's seat belt is unlatched.
- **PRNTP** is ON (indicator on).
- The climate control system is in use, and the difference between the set temperature and actual interior temperature becomes significant.
- The climate control system is being used to dehumidify the interior.
- The vehicle ahead of you starts again when your vehicle stops automatically with ACC with LSF.

⌘ The Engine Automatically Restarts When:

If you are using an electronic device during Auto Idle Stop, the device may temporarily be turned off when the engine restarts.

⌘ The engine restarts even if the brake pedal is depressed*1 when:

*1: With the automatic brake hold system activated, you can release the brake pedal during Auto Idle Stop is in operation.

■ **The engine restarts even if the automatic brake hold system is activated when:**

- The automatic brake hold system is canceled and the electric parking brake is applied automatically.
The automatic brake hold system has a problem.

■ **Starting Assist Brake Function**

Briefly keeps the brake applied after releasing the brake pedal to restart the engine. This can keep your vehicle from unexpectedly moving while on an incline.

Integrated Dynamics System

Modifies the dynamic character of the vehicle. There are four modes to select from: **Econ**, **Normal**, **Sport**, and **Sport+**. Press the **Dynamic Mode** button to select a mode. The mode you have selected appears on the multi-information display. You can customize the mode default setting using the multi-information display.

📄 **Customized Features** P. 120, 292

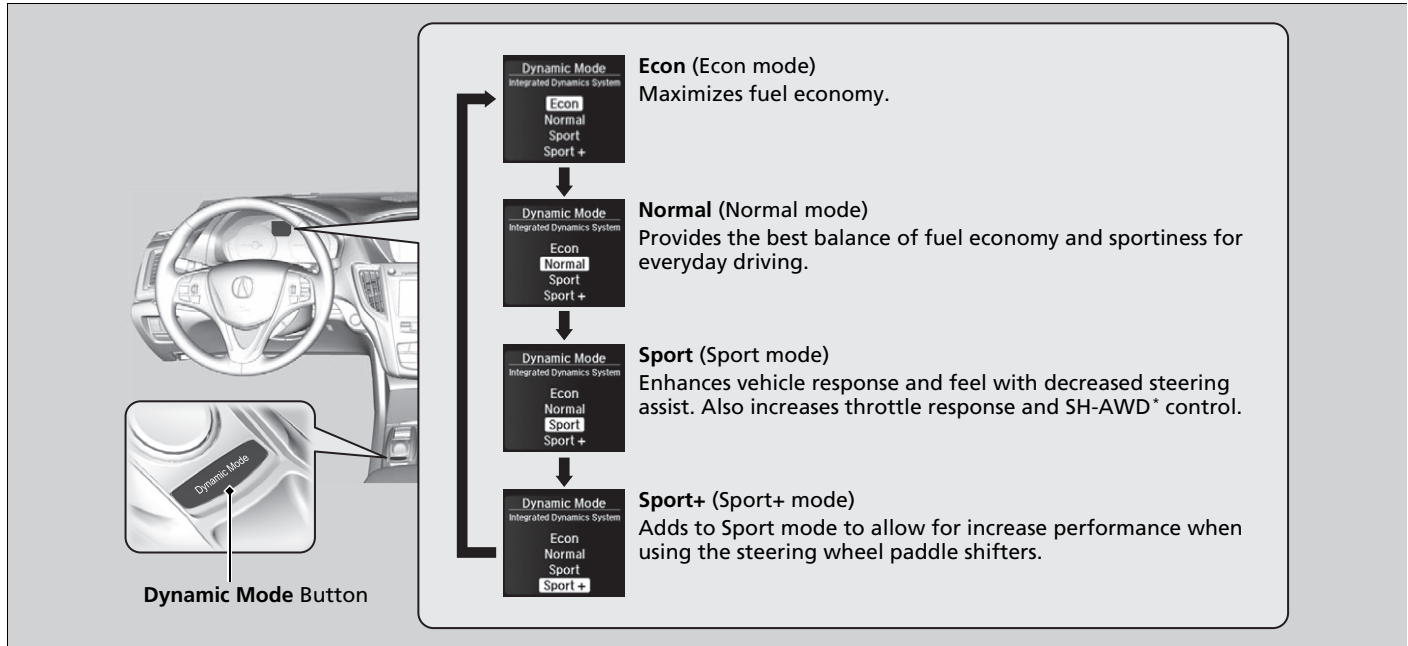

When you restart the engine with **Sport+** mode, the mode is changed to **Sport** automatically.

Front Sensor Camera

The camera, used in systems such as LKAS, RDM, ACC with LSF, CMBS™, and auto high-beam, is designed to detect an object that triggers any of the systems to operate its functions.

Camera Location and Handling Tips

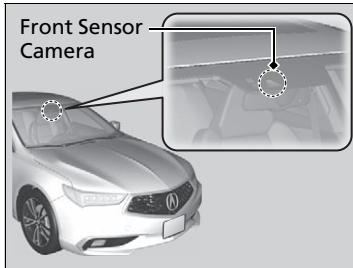

This camera is located behind the rearview mirror.

To help reduce the likelihood that high interior temperatures will cause the camera's sensing system to shut off, when parking, find a shady area or face the front of the vehicle away from the sun. If you use a reflective sun shade, do not allow it to cover the camera housing. Covering the camera can concentrate heat on it.

Front Sensor Camera

Never apply a film or attach any objects to windshield, hood, or front grill that could obstruct the camera's field of vision and cause the system to operate abnormally.

Scratches, nicks, and other damage to the windshield within the camera's field of vision can cause the system to operate abnormally. If this occurs, we recommend that you replace the windshield with a genuine Acura replacement windshield. Making even minor repairs within the camera's field of vision or installing an aftermarket replacement windshield may also cause the system to operate abnormally. After replacing the windshield, have a dealer recalibrate the camera. Proper calibration of the camera is necessary for the system to operate properly.

Do not place an object on the top of the instrument panel. It may reflect onto the windshield and prevent the system from detecting lane lines properly.

Front Sensor Camera

If the **Some Driver Assist Systems Cannot Operate: Camera Temperature Too High** message appears:

- Use the climate control system to cool down the interior and, if necessary, also use defroster mode with the airflow directed towards the camera.
- Start driving the vehicle to lower the windshield temperature, which cools down the area around the camera.

If the **Some Driver Assist Systems Cannot Operate: Clean Front Windshield** message appears:

- Park your vehicle in a safe place, and clean the windshield. If the message does not disappear after you have cleaned the windshield and driven for a while, have your vehicle checked by a dealer.

Adaptive Cruise Control (ACC) with Low Speed Follow (LSF)

Helps maintain a constant vehicle speed and a set following-interval behind a vehicle detected ahead of yours and, if the detected vehicle comes to a stop, can decelerate and stop your vehicle, without you having to keep your foot on the brake or the accelerator.

When ACC with LSF slows your vehicle by applying the brakes, your vehicle's brake lights will illuminate.

When to use

The camera is located behind the rearview mirror.

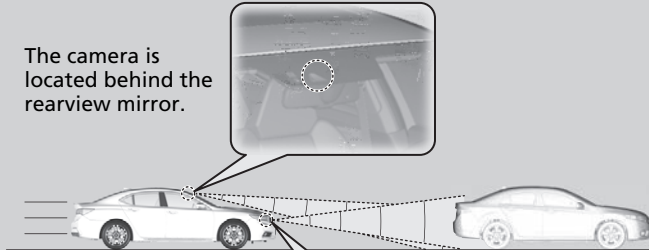

The radar sensor is in the front grille.

■ Vehicle speed for ACC with LSF: **A vehicle is detected ahead within ACC with LSF range** – ACC with LSF operates at speeds up to 90 mph (145 km/h).

No vehicle is detected within ACC with LSF range – ACC with LSF operates at the speed of about 25 mph (40 km/h) or above.

■ Gear position for ACC with LSF: In **D**.

⚠ Adaptive Cruise Control (ACC) with Low Speed Follow (LSF)

⚠ WARNING

Improper use of ACC with LSF can lead to a crash.

Use ACC with LSF only when driving on expressways or freeways and in good weather conditions.

⚠ WARNING

ACC with LSF has limited braking capability and may not stop your vehicle in time to avoid a collision with a vehicle that quickly stops in front of you.

Always be prepared to apply the brake pedal if the conditions require.

Important Reminder

As with any system, there are limits to ACC with LSF. Use the brake pedal whenever necessary, and always keep a safe interval between your vehicle and other vehicles.

■ How to activate the system

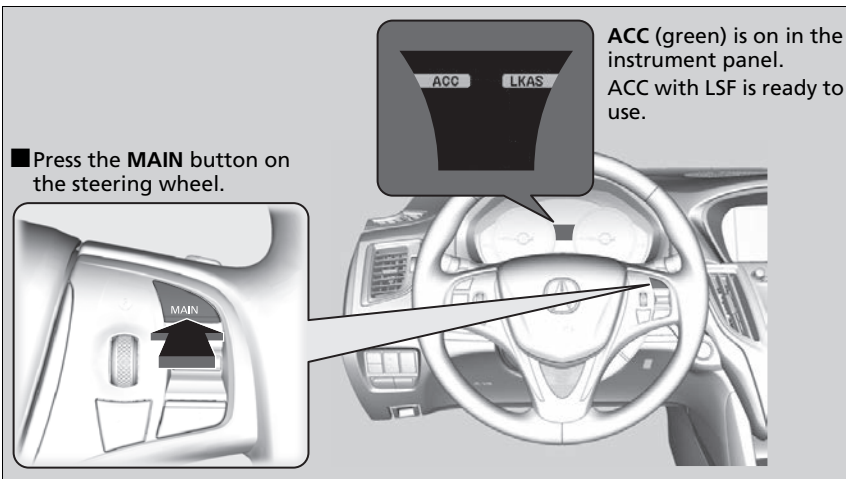

▶ Adaptive Cruise Control (ACC) with Low Speed Follow (LSF)

When the **MAIN** button is pressed, both ACC with LSF and the Lane Keeping Assist System (LKAS) are either turned on or off.

ACC with LSF may not work properly under certain conditions.

▶ **ACC with LSF Conditions and Limitations**
P. 396

When not using ACC with LSF: Turn off adaptive cruise by pressing the **MAIN** button. This also will turn off the Lane Keeping Assist System (LKAS).

Do not use ACC with LSF under the following conditions.

- On roads with heavy traffic or while driving in continuous stop and go traffic.
- On roads with sharp turns.
- On roads with steep downhill sections, as the set vehicle speed can be exceeded by coasting. In such cases, ACC with LSF will not apply the brakes to maintain the set speed.
- On roads with toll collection facilities or other objects between lanes of traffic, or in parking areas, or facilities with drive through access.

■ To Set the Vehicle Speed

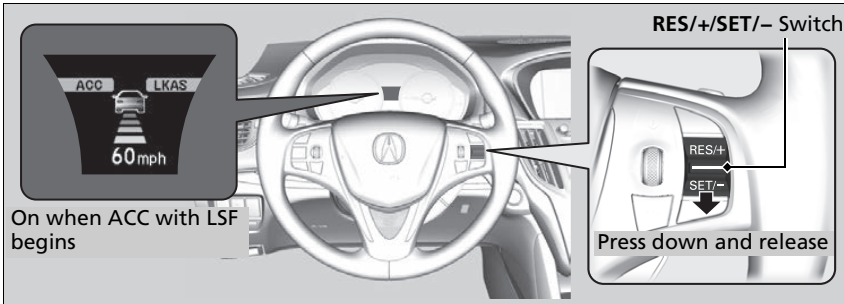

When driving at about 25 mph (40 km/h) or above: Take your foot off the pedal and press down the **RES/+ / SET/-** switch when you reach the desired speed. The moment you release the switch, the set speed is fixed, and ACC with LSF begins.

When driving at slower than about 25 mph (40 km/h): If the vehicle is moving and the brake pedal is not depressed, pressing the switch fixes the set speed to about 25 mph (40 km/h) regardless of current vehicle speed. If your vehicle is stationary, you can set the vehicle speed even with the brake pedal depressed.

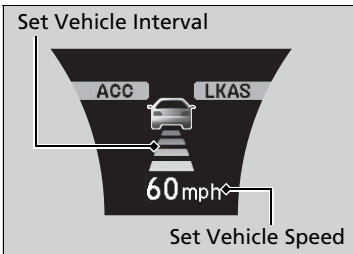

When ACC with LSF starts operating, the vehicle icon, interval bars and set speed appear on the multi-information display.

■ When in Operation

■ There is a vehicle ahead

ACC with LSF monitors if a vehicle ahead of you enters the ACC with LSF range. If a vehicle is detected doing so, the ACC with LSF system maintains or decelerates your vehicle's set speed in order to keep the vehicle's set following-interval from the vehicle ahead.

➤ **To Set or Change Following-interval** P. 399

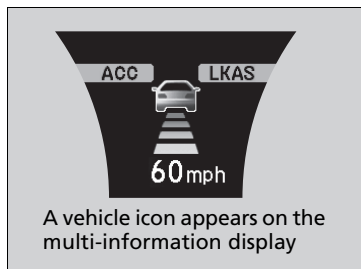
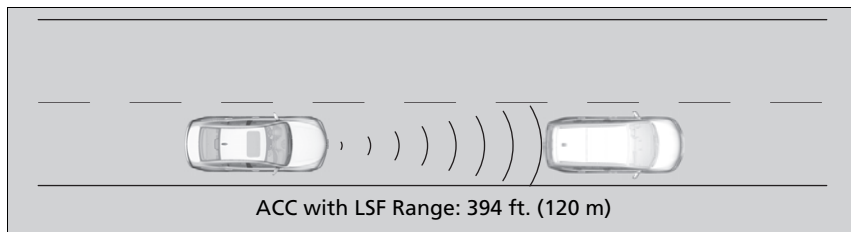

A vehicle icon appears on the multi-information display

When a vehicle whose speed is slower than your set speed is detected in front of you, your vehicle starts to slow down.

⌘ When in Operation

If the vehicle detected ahead of you slows down abruptly, or if another vehicle is detected cutting in front of you, the beeper sounds and a message appears on the multi-information display, and the head-up warning lights come on. Depress the brake pedal, and keep an appropriate interval from the vehicle ahead.

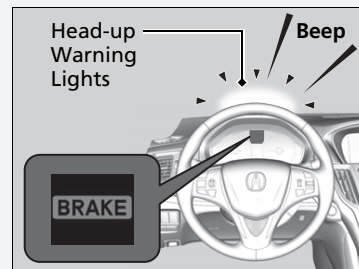

Even if the interval between your vehicle and the vehicle detected ahead is short, ACC with LSF may start accelerating your vehicle under the following circumstances:

- The vehicle ahead of you is going at almost the same speed as, or faster than, your vehicle.
- A vehicle that cuts in front of you is going faster than your vehicle, gradually increasing the interval between the vehicles.

You can also set the system to beep when a vehicle detected in front of you comes in and goes out of the ACC with LSF detecting range. Change the **ACC Forward Vehicle Detect Beep*** setting.

➤ **Customized Features** P. 120, 292

■ **There is no vehicle ahead**

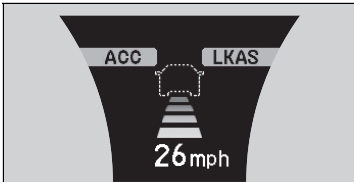

A vehicle icon with dotted-line contour appears on the multi-information display

Your vehicle maintains the set speed without having to keep your foot on the brake or accelerator pedal.

If there previously was a vehicle detected ahead that kept your vehicle from traveling at the set speed, ACC with LSF accelerates your vehicle to the set speed, and then maintains it.

■ **When you depress the accelerator pedal**

You can temporarily increase the vehicle speed. In this case, there is no audible or visual alert even if a vehicle is in the ACC with LSF range.

ACC with LSF stays on unless you cancel it. Once you release the accelerator pedal, the system resumes the set speed.

There are times when the vehicle speed will decrease when the accelerator pedal is lightly applied.

■ **A vehicle detected ahead is within ACC with LSF range and slows to a stop**



Your vehicle also stops, automatically. The **Stopped** message appears on the multi-information display.

When the vehicle ahead of you starts again, the vehicle icon on the multi-information display blinks. If you press the **RES/+/SET/-** switch up or down, or depress the accelerator pedal, ACC with LSF operates again within the prior set speed.

⌘When in Operation

Limitations

You may need to use the brake to maintain a safe interval when using ACC with LSF. Additionally, ACC with LSF may not work properly under certain conditions.

⌘ **ACC with LSF Conditions and Limitations**
P. 396

⌘A vehicle detected ahead is within ACC with LSF range and slows to a stop

⚠WARNING

Exiting a vehicle that has been stopped while the ACC with LSF system is operating can result in the vehicle moving without operator control.

A vehicle that moves without operator control can cause a crash, resulting in serious injury or death.

Never exit a vehicle when the vehicle is stopped by ACC with LSF.

■ ACC with LSF Conditions and Limitations

The system may automatically shut off and the **ACC** indicator will come on under certain conditions. Some examples of these conditions are listed below. Other conditions may reduce some of the ACC functions.

➤ **Front Sensor Camera** P. 389

■ Environmental conditions

Driving in bad weather (rain, fog, snow, etc.).

■ Roadway conditions

Driving on a snowy or wet roadway (obscured lane marking, vehicle tracks, reflected lights, road spray, high contrast).

■ Vehicle conditions

- The outside of the windshield is blocked by dirt, mud, leaves, wet snow, etc.
- An abnormal tire or wheel condition (Wrong sized, varied size or construction, improperly inflated, compact spare tire*, etc.).
- The camera temperature gets too high.
- The parking brake is applied.
- When the front grille is dirty.
- The vehicle is tilted due to a heavy load or suspension modifications.
- When tire chains are installed.

➤ ACC with LSF Conditions and Limitations

The radar sensor for ACC with LSF is shared with the Collision Mitigation Braking System™ (CMBS™).

➤ **Collision Mitigation Braking System™ (CMBS™)** P. 437

You can read about handling information for the camera equipped with this system.

➤ **Front Sensor Camera** P. 389

Always keep the radar sensor cover clean.

Never use chemical solvents or polishing powder for cleaning the sensor cover. Clean it with water or a mild detergent.

Do not put a sticker on the radar sensor cover or replace the radar sensor cover.

If you need the radar sensor to be repaired, or removed, or the radar sensor cover is strongly impacted, turn off the system by pressing the **MAIN** button and take your vehicle to a dealer.

Have your vehicle checked by a dealer if you find any unusual behavior of the system (e.g., the warning message appears too frequently).

■ Detection limitations

- A vehicle suddenly crosses in front of you.
- The interval between your vehicle and the vehicle ahead of you is too short.
- A vehicle cuts in front of you at a slow speed, and it brakes suddenly.
- When you accelerate rapidly and approach the vehicle ahead of you at high speed.
- The vehicle ahead of you is a motorcycle, bicycle, mobility scooter, or other small vehicle.
- When there are animals in front of your vehicle.
- When you drive on a curved or winding or undulating road that makes it difficult for the sensor to properly detect a vehicle in front of you.
- The speed difference between your vehicle and a vehicle in front of you is significantly large.
- An oncoming vehicle suddenly comes in front of you.
- Your vehicle abruptly crosses over in front of an oncoming vehicle.
- When driving through a narrow iron bridge.
- When the vehicle ahead of you brakes suddenly.
- When the vehicle ahead of you has a unique shape.
- When your vehicle or the vehicle ahead of you is driving on one edge of the lane.

⊠ ACC with LSF Conditions and Limitations

If the front of the vehicle is impacted in any of the following situations, the radar sensor may not work properly. Have your vehicle checked by a dealer:

- The vehicle mounted onto a bump, curb, chock, embankment, etc.
- You drive the vehicle where the water is deep.
- Your vehicle has a frontal collision.

Continued

■ To Adjust the Vehicle Speed

Increase or decrease the vehicle speed using the **RES/+**/**SET/-** switch on the steering wheel.

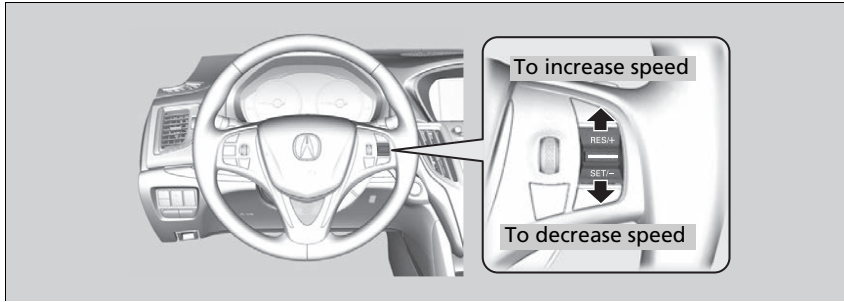

- Each time you press the switch up or down, the vehicle speed is increased or decreased by about 1 mph or 1 km/h accordingly.
- If you keep the switch pressed up or down, the vehicle speed increases or decreases by about 5 mph or 5 km/h accordingly.

▶▶ To Adjust the Vehicle Speed

If a vehicle detected ahead is going at a speed slower than your increased set speed, ACC with LSF may not accelerate your vehicle. This is to maintain the set interval between your vehicle and the vehicle ahead.

You can switch the displayed set speed measurements on the multi-information display between mph and km/h.

▶ **Customized Features** P. 120



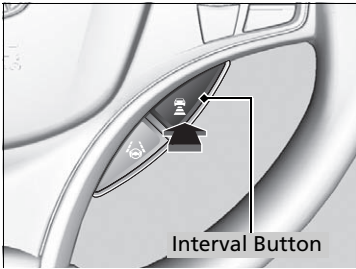

■ To Set or Change Following-interval



Press the  (interval) button to change the ACC with LSF following-interval. Each time you press the button, the following-interval (the interval behind a vehicle detected ahead of you) setting cycles through short, middle, long, and extra long following-intervals.

Determine the most appropriate following-interval setting based on your specific driving conditions. Be sure to adhere to any following-interval requirements set by local regulation.

The higher your vehicle's following-speed is, the longer the short, middle, long or extra long following-interval becomes. See the following examples for your reference.

| Following-interval | | When the Set Speed is: | |
|--------------------|---|----------------------------------|----------------------------------|
| | | 50 mph (80 km/h) | 65 mph (104 km/h) |
| Short |  | 83 feet 25 meters 1.1 sec | 100 feet 31 meters 1.1 sec |
| Middle |  | 110 feet 33 meters 1.5 sec | 137 feet 42 meters 1.5 sec |
| Long |  | 154 feet 47 meters 2.1 sec | 200 feet 61 meters 2.1 sec |
| Extra Long |  | 204 feet 62 meters 2.8 sec | 265 feet 81 meters 2.8 sec |

When your vehicle stops automatically because a vehicle detected ahead of you has stopped, the interval between the two vehicles will vary based on the ACC with LSF interval setting.

■ To Cancel

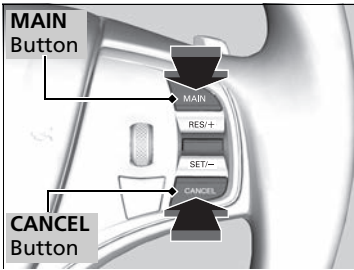

To cancel ACC with LSF, do any of the following:

- Press the **CANCEL** button.
- Press the **MAIN** button.
 - ▶ ACC with LSF indicator goes off.
- Depress the brake pedal.
 - ▶ When the LSF function has stopped the vehicle, you cannot cancel ACC with LSF by depressing the brake pedal.

☒ To Cancel

Resuming the prior set speed: After you have canceled ACC with LSF, you can resume the prior set speed while it is still displayed. Press the **RES/+ / SET / -** switch up or down.

The set speed cannot be set or resumed when ACC with LSF has been turned off using the **MAIN** button. Press the **MAIN** button to activate the system, then set the desired speed.

■ Automatic cancellation

The beeper sounds and a message appears on the multi-information display when ACC with LSF is automatically canceled. Any of these conditions may cause the ACC with LSF to automatically cancel:

- Bad weather (rain, fog, snow, etc.)
- When the radar sensor in the front grille gets dirty.
- The vehicle ahead of you cannot be detected.
- An abnormal tire condition is detected, or the tires are skidding.
- Driving on a mountainous road, or driving off road for extended periods.
- Abrupt steering wheel movement.
- When the ABS, VSA® or CMBS™ is activated.
- When the ABS or VSA® system indicator comes on.
- When the vehicle is stopped on a very steep slope.
- When you manually apply the parking brake.
- When the detected vehicle within the ACC with LSF range is too close to your vehicle.
- The camera behind the rearview mirror, or the area around the camera, including the windshield, gets dirty.

The ACC with LSF automatic cancellation can be also triggered by the following causes. In these cases, the parking brake will be automatically applied.

- The driver's seat belt is unfastened when the vehicle is stationary.
- The vehicle stops for more than 10 minutes.
- The engine is turned off.

▶▶ Automatic cancellation

Even though ACC with LSF has been automatically canceled, you can still resume the prior set speed. Wait until the condition that caused ACC with LSF to cancel improves, then press the **RES/+SET/-** switch up or down.

■ To Switch ACC with LSF to Cruise Control

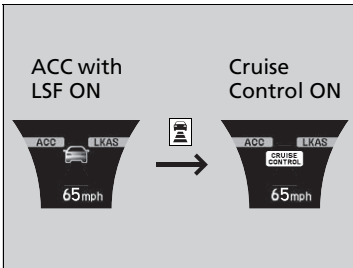

Press and hold the  (interval) button for one second. **Cruise Mode Selected** appears on the multi-information display for two seconds, and then the mode switches to Cruise.

To switch back to ACC with LSF, press and hold the  button again for one second. **ACC Mode Selected** appears on the multi-information display for two seconds.

■ When to use

Desired speed in a range above roughly 25 mph (40 km/h) ~.

■ To Set the Vehicle Speed

Take your foot off the pedal and press the **RES/+ / SET/-** switch down when you reach the desired speed.

The moment you release the **RES/+ / SET/-** switch, the set speed is fixed, and cruise control begins. The **CRUISE CONTROL** indicator comes on.

■ To Adjust the Vehicle Speed

Each time you press the **RES/+ / SET/-** switch up or down, the vehicle speed is increased or decreased by about 1 mph (1.6 km/h).

If you keep the **RES/+ / SET/-** switch pressed up or down, the vehicle speed increases or decreases until you release it. This speed is then set.

▶▶ To Switch ACC with LSF to Cruise Control

Always be aware which mode you are in. When you are driving in Cruise mode, the system will not assist you to maintain a following-interval from a vehicle ahead of you.

You can switch the displayed set speed measurements on the multi-information display between mph and km/h.

▶ **Customized Features** P. 120

■ To Cancel

To cancel cruise control, do any of the following:

- Press the **CANCEL** button.
- Press the **MAIN** button.
- Depress the brake pedal.

The **CRUISE CONTROL** indicator goes off.

☞ To Cancel

Resuming the prior set speed:

After cruise control has been canceled, you can still resume the prior set speed by pressing the **RES/+ / SET/-** switch up while driving at a speed of at least 25 mph (40 km/h) or more.

You cannot set or resume in the following situations:

- When vehicle speed is less than 25 mph (40 km/h).
- When the **MAIN** button is turned off.

At vehicle speeds of 22 mph (35 km/h) or less, cruise control canceled automatically.

Road Departure Mitigation (RDM) System

Alerts and helps to assist you when the system detects a possibility of your vehicle unintentionally crossing over detected lane markings.

How the System Works

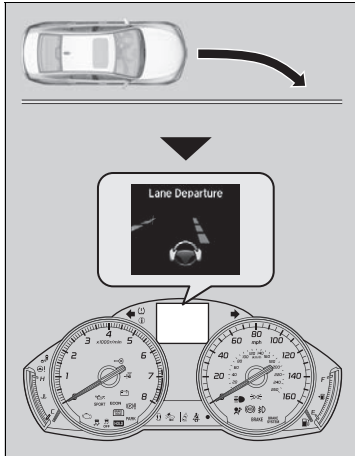

The front camera behind the rearview mirror monitors left and right lane markings (in white or yellow). If your vehicle is getting too close to detected lane markings without a turn signal activated, the system, in addition to a visual alert, applies steering torque and alerts you with rapid vibrations on the steering wheel, to help you remain within the detected lane.

▶ **Customized Features** P. 120, 292

As a visual alert, the **Lane Departure** message appears on the multi-information display.

If the system determines that its steering input is insufficient to keep your vehicle on the roadway, it may apply braking.

▶ Braking is applied only when the lane markings are solid continuous lines.

The system cancels assisting operations when you turn the steering wheel to avoid crossing over detected lane markings.

If the system operates several times without detecting driver response, the system beeps to alert you.

⚠ Road Departure Mitigation (RDM) System

Important Safety Reminder

Like all assistance systems, the RDM system has limitations.

Over-reliance on the RDM system may result in a collision. It is always your responsibility to keep the vehicle within your driving lane.

The RDM system only alerts you when lane drift is detected without a turn signal in use. The RDM system may not detect all lane markings or lane or roadway departures; accuracy will vary based on weather, speed and lane marker condition. It is always your responsibility to safely operate the vehicle and avoid collisions.

You can read about handling information for the camera equipped with this system.

▶ **Front Sensor Camera** P. 389

The RDM system may not work properly or may work improperly under the certain conditions:

▶ **RDM Conditions and Limitations** P. 408

There are times when you may not notice RDM functions due to your operation of the vehicle, or road surface conditions.

■ How the System Activates

The system becomes ready to start searching for lane markings when all the following conditions are met:

- The vehicle is traveling between about 45 and 90 mph (72 and 145 km/h).
- The vehicle is on a straight or slightly curved road.
- The turn signals are off.
- The brake pedal is not depressed.
- The wipers are not in continuous operation.
- The vehicle is not accelerating or braking, and the steering wheel is not being turned.
- The system makes a determination that the driver is not actively accelerating, braking or steering.

▣ How the System Activates

The RDM system may automatically shut off and the  indicator comes and stays on.

▣ **Indicators** P. 84

RDM system function can be impacted when the vehicle is:

- Not driven within a traffic lane.
- Driven on the inside edge of a curve, or outside of a lane.
- Driven in a narrow lane.

RDM On and Off

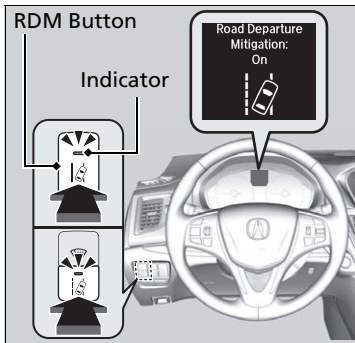

Press the RDM button to turn the system on and off.

- ▶ The indicator in the button comes on and the message appears on the multi-information display when the system is on.

RDM On and Off

When you have selected **Warning Only** from the customized options using the multi-information display, the system does not operate the steering wheel and braking.

■ RDM Conditions and Limitations

The system may not properly detect lane markings and the position of your vehicle under certain conditions. Some examples of these conditions are listed below.

■ Environmental conditions

- Driving in bad weather (rain, fog, snow, etc.).
- Sudden changes between light and dark, such as an entrance or exit of a tunnel.
- There is little contrast between lane lines and the roadway surface.
- Driving into low sunlight (e.g., at dawn or dusk).
- Strong light is reflected onto the roadway.
- Driving in the shadows of trees, buildings, etc.
- Shadows of adjacent objects are parallel to lane markings.
- Roadway objects or structures are misinterpreted as lane markers.
- Reflections on the interior of the windshield.
- Driving at night or in a dark condition such as a tunnel.

■ Roadway conditions

- Driving on a snowy or wet roadway (obscured lane marking, vehicle tracks, reflected lights, road spray, high contrast).
- Driving on a road with temporary lane markings.
- Faint, multiple, or varied lane markings are visible on the roadway due to road repairs or old lane markings.
- The roadway has merging, split, or crossing lines (e.g., such as at an intersection or crosswalk).
- The lane markings are extremely narrow, wide, or changing.
- The vehicle in front of you is driving near the lane lines.
- The road is hilly or the vehicle is approaching the crest of a hill.
- Driving on rough or unpaved roads, or over bumpy surfaces.
- When objects on the road (curb, guard rail, pylons, etc.) are recognized as white lines (or yellow lines).
- Driving on roads with double lines.

■ Vehicle conditions

- Headlight lenses are dirty or the headlights are not properly adjusted.
- The outside of the windshield is streaked or blocked by dirt, mud, leaves, wet snow, etc.
- The inside of the windshield is fogged.
- The camera temperature gets too high.
- An abnormal tire or wheel condition (wrong sized, varied size or construction, improperly inflated, compact spare tire*, etc.).
- The vehicle is tilted due to a heavy load or suspension modifications.
- When tire chains are installed.

* Not available on all models

Lane Keeping Assist System (LKAS)

Provides steering input to help keep the vehicle in the middle of a detected lane and provides tactile and visual alerts if the vehicle is detected drifting out of its lane.

■ Steering input assist

The system applies torque to the steering to keep the vehicle between the left and right lane lines. The applied torque becomes stronger as the vehicle gets closer to either of the lane lines.



■ LKAS camera
Monitors the lane lines

■ Tactile and visual alerts

Rapid vibrations on the steering wheel and a warning display alert you that the vehicle is drifting out of a detected lane.

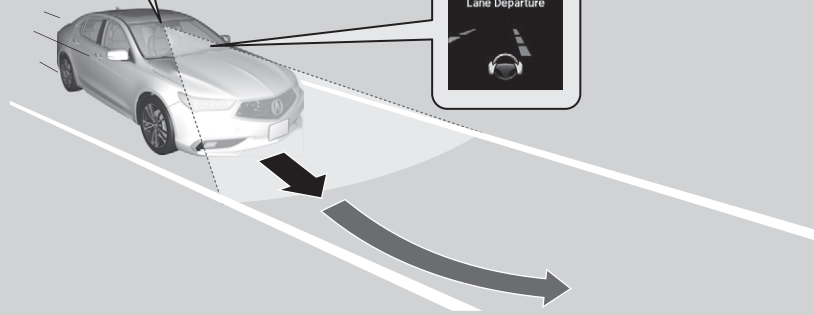

When you operate the turn signals to change lanes, the system is suspended, and resumes after the signals are off.

If you make a lane change without operating the turn signals, the LKAS alerts activate, and torque is applied to the steering.

▶ Lane Keeping Assist System (LKAS)

Important Safety Reminders

The LKAS is for your convenience only. It is not a substitute for your vehicle control. The system does not work if you take your hands off the steering wheel or fail to steer the vehicle.

▶ Multi-Information Display Warning and Information Messages P. 105

Do not place objects on the instrument panel. Objects may reflect on the front windshield and prevent correct detection of the traffic lanes.

The LKAS only alerts you when lane drift is detected without a turn signal in use. The LKAS may not detect all lane markings or lane departures; accuracy will vary based on weather, speed, and lane marker condition. It is always your responsibility to safely operate the vehicle and avoid collisions.

The LKAS is convenient when it is used on freeways.

The LKAS may not work properly or may work improperly under the certain conditions:

▶ LKAS Conditions and Limitations P. 416

The LKAS may not function as designed while driving in frequent stop and go traffic, or on roads with sharp curves.

You can read about handling information for the camera equipped with this system.

▶ Front Sensor Camera P. 389

■ Lane Keep Support Function

Provides assistance to keep the vehicle in the center of the lane. When the vehicle nears a white or yellow line, steering force of the electric power steering will become stronger.

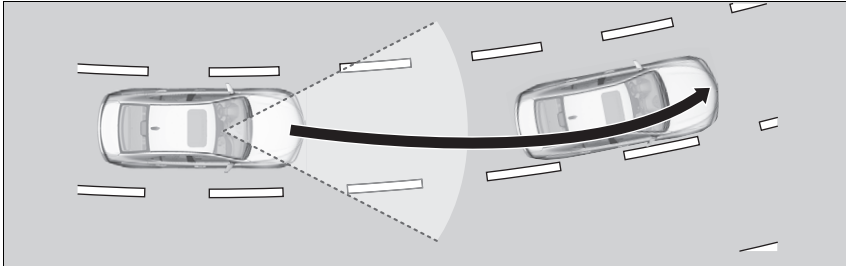

■ Lane Departure Warning Function

When the vehicle enters the warning area, the LKAS alerts you with slight steering wheel vibration as well as a warning display.

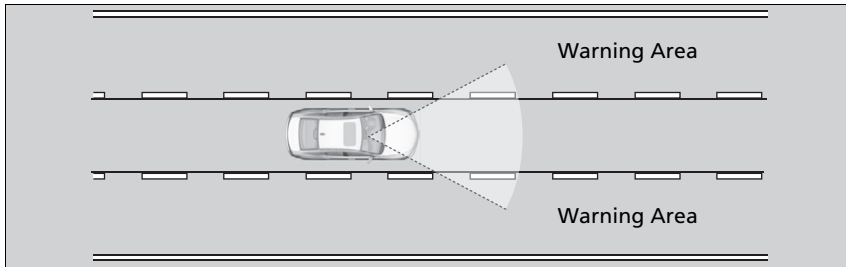

☒ Lane Keeping Assist System (LKAS)

When it fails to detect lanes, the system will temporarily be canceled. When lane is detected, system will recover automatically.

■ When the System can be Used

The system can be used when the following conditions are met.

- The lane in which you are driving has detectable lane markers on both sides, and your vehicle is in the center of the lane.
- The vehicle speed is between about 45 and 90 mph (72 and 145 km/h).
- You are driving on a straight or slightly curved road.
- The turn signals are off.
- The brake pedal is not depressed.
- The wipers are not in continuous operation.

■ How to activate the system

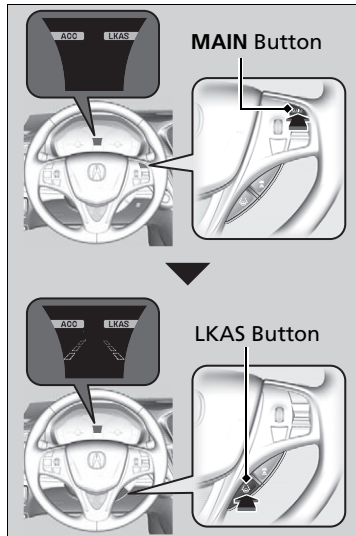

1. Press the **MAIN** button.

- ▶ The LKAS is on in the multi-information display.
The system is ready to use.

2. Press the LKAS button.

- ▶ Lane outlines appear on the multi-information display.
The system is activated.

▣ Lane Keeping Assist System (LKAS)

If the vehicle drifts toward either left or right lane line due to the system applying torque, turn off the LKAS and have your vehicle checked by a dealer.

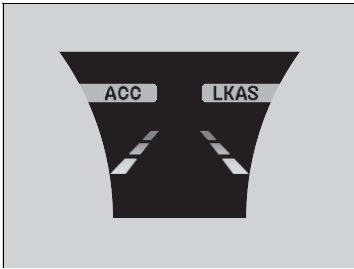

3. Keep your vehicle near the center of the lane while driving.
 - ▶ The dotted outer lines change to solid ones once the system starts operating after detecting the left and right lane markings.

■ To Cancel

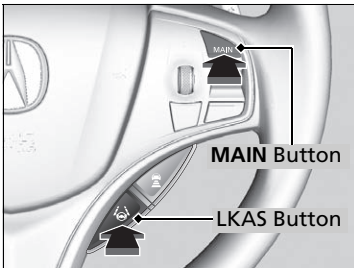

To cancel the LKAS:
Press the **MAIN** or LKAS button.

The LKAS is turned off every time you stop the engine, even if you turned it on the last time you drove the vehicle.

☒ To Cancel

Pressing the **MAIN** button also turns ACC with LSF on and off.

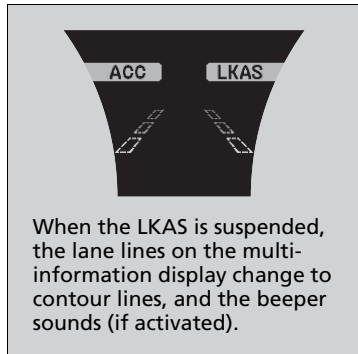

■ **The system operation is suspended if you:**

- Set the wipers to continuous operation.
 - ▶ Turning the wipers off resumes the LKAS.

Models with automatic intermittent wipers

- Set the wiper switch to **AUTO** and the wipers operate continuously.
 - ▶ The LKAS resumes when the wipers stop or operate intermittently.

All models

- Decrease the vehicle speed to about 40 mph (64 km/h) or less.
 - ▶ Increasing the vehicle speed to about 45 mph (72 km/h) or more resumes the LKAS.
- Depress the brake pedal.
 - ▶ The LKAS resumes and starts detecting the lane lines again once you release the brake pedal.

■ **The LKAS may automatically be suspended when:**

- The system fails to detect lane lines.
- The steering wheel is quickly turned.
- You fail to steer the vehicle.
- Driving through a sharp curve.
- Driving at a speed in excess of approximately 90 mph (145 km/h).
- The vehicle runs on a curved road over the speed limit.

Once these conditions no longer exist, the LKAS automatically resumes.

■ **The LKAS may automatically be canceled when:**

- The camera temperature gets extremely high or low.
- The camera behind the rearview mirror, or the area around the camera, including the windshield, gets dirty.
- The ABS or VSA® system engages.

The beeper sounds if the LKAS is automatically canceled.

■ LKAS Conditions and Limitations

The system may not detect lane markings and therefore may not keep the vehicle in the middle of a lane under certain conditions, including the following:

■ Environmental conditions

- Driving in bad weather (rain, fog, snow, etc.).
- Sudden changes between light and dark, such as an entrance or exit of a tunnel.
- There is little contrast between lane lines and the roadway surface.
- Driving into low sunlight (e.g., at dawn or dusk).
- Strong light is reflected onto the roadway.
- Driving in the shadows of trees, buildings, etc.
- Shadows of adjacent objects are parallel to lane markings.
- Roadway objects or structures are misinterpreted as lane markers.
- Reflections on the interior of the windshield.
- Driving at night or in a dark condition such as a tunnel.

■ Roadway conditions

- Driving on a snowy or wet roadway (obscured lane marking, vehicle tracks, reflected lights, road spray, high contrast).
- Driving on a road with temporary lane markings.
- Faint, multiple, or varied lane markings are visible on the roadway due to road repairs or old lane markings.
- The roadway has merging, split, or crossing lines (e.g., such as at an intersection or crosswalk).
- The lane markings are extremely narrow, wide, or changing.
- The vehicle in front of you is driving near the lane lines.
- The road is hilly or the vehicle is approaching the crest of a hill.
- Driving on rough or unpaved roads, or over bumpy surfaces.
- When objects on the road (curb, guard rail, pylons, etc.) are recognized as white lines (or yellow lines).
- Driving on roads with double lines.

■ Vehicle conditions

- Headlight lenses are dirty or the headlights are not properly adjusted.
- The outside of the windshield is streaked or blocked by dirt, mud, leaves, wet snow, etc.
- The inside of the windshield is fogged.
- The camera temperature gets too high.
- An abnormal tire or wheel condition (wrong sized, varied size or construction, improperly inflated, compact spare tire*, etc.).
- The vehicle is tilted due to a heavy load or suspension modifications.

* Not available on all models

Vehicle Stability Assist (VSA®), aka Electronic Stability Control (ESC), System

VSA® helps to stabilize the vehicle during cornering if the vehicle turns more or less than what was intended. It also assists in maintaining traction on slippery surfaces. It does so by regulating engine output and selectively applying the brakes.

▶▶ Vehicle Stability Assist (VSA®), aka Electronic Stability Control (ESC), System

The VSA® may not function properly if tire type and size are mixed. Make sure to use the same size and type of tire, and the air pressures as specified.

When the VSA® system indicator comes on and stays on while driving, there may be a problem with the system. While this may not interfere with normal driving, have your vehicle checked by a dealer immediately.

VSA® cannot enhance stability in all driving situations and does not control the entire braking system. You still need to drive and corner at speeds appropriate for the conditions and always leave a sufficient margin of safety.

The main function of the VSA® system is generally known as Electronic Stability Control (ESC). The system also includes a traction control function.

■ VSA® Operation

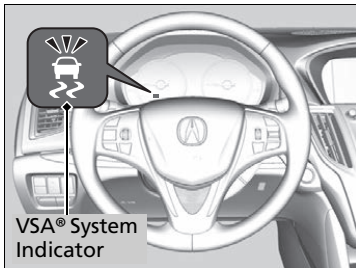

When VSA® activates, you may notice that the engine does not respond to the accelerator. You may also notice some noise from the hydraulic system. You will also see the indicator blink.

VSA® On and Off

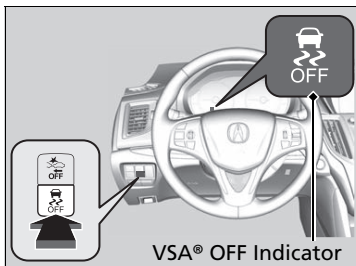

This button is on the driver side control panel. To partially disable VSA® functionality/features, press and hold it until you hear a beep.

Your vehicle will have normal braking and cornering ability, but traction control function will be less effective.

To restore VSA® functionality/features, press the  (VSA® OFF) button until you hear a beep.

VSA® is turned on every time you start the engine, even if you turned it off the last time you drove the vehicle.

Vehicle Stability Assist (VSA®), aka Electronic Stability Control (ESC), System

In certain unusual conditions when your vehicle gets stuck in shallow mud or fresh snow, it may be easier to free it with the VSA® temporarily switched off.

When the  button is pressed, the traction control function becomes less effective. This allows for the wheels to spin more freely at low speed. You should only attempt to free your vehicle with the VSA® off if you are not able to free it when the VSA® is on.

Immediately after freeing your vehicle, be sure to switch VSA® on again. We do not recommend driving your vehicle with the VSA® system switched off.

You may hear a motor sound coming from the engine compartment while system checks are being performed immediately after starting the engine or while driving. This is normal.

Agile Handling Assist

Lightly brakes each of the front and rear wheels, as needed, when you turn the steering wheel, and helps support the vehicle's stability and performance during cornering.

ⓘ Agile Handling Assist

The agile handling assist cannot enhance stability in all driving situations. You still need to drive and corner at speeds appropriate for the conditions and always leave a sufficient margin of safety.

When the VSA® system indicator comes on and stays on while driving, the agile handling assist does not activate.

You may hear a sound coming from the engine compartment while the agile handling assist is activated. This is normal.

ⓘ Precision All-Wheel Steer™ (P-AWS®) System *

Precision All-Wheel Steer™ (P-AWS®) System *

Monitors road conditions while you are driving. In response to current driving conditions, the system automatically makes slight adjustment to the relative rear wheel toe settings to help enhance vehicle control and stability.

The Precision All-Wheel Steer™ (P-AWS®) system cannot enhance vehicle control and stability in all driving situations. You still need to drive and corner at speeds appropriate for the conditions and always leave a sufficient margin of safety.

The toe setting of the rear wheels may get stuck in a non-centered setting if the system malfunctions while driving. This can cause the vehicle to pull to a side even as you keep the steering wheel in the center position. If this occurs, the system automatically limits the vehicle speed to a maximum of 50 mph (80 km/h). Reduce your speed and be extra cautious, as handling may be difficult. Go to a dealer immediately.

Blind spot information (BSI) System*

Is designed to detect vehicles in specified alert zones adjacent to your vehicle, particularly in harder to see areas commonly known as “blind spots.”

When the system detects vehicles approaching from behind in adjacent lanes, the appropriate indicator comes on for a few seconds, providing assistance when you change lanes.

■ How the system works

- The transmission is in **D** or **S**.

- Your vehicle speed is between 20 mph (32 km/h) and 100 mph (160 km/h)

Alert zone range

- A: Approx. 1.6 ft. (0.5 m)
- B: Approx. 10 ft. (3 m)
- C: Approx. 10 ft. (3 m)

Radar Sensors:
underneath the
rear bumper
corners

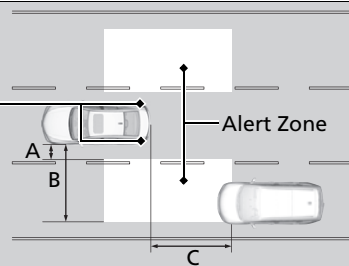

⚠ Blind spot information (BSI) System*

⚠ WARNING

Failure to visually confirm that it is safe to change lanes before doing so may result in a crash and serious injury or death. Do not rely only on the blind spot information system when changing lanes.

Always look in your mirrors, to either side of your vehicle, and behind you for other vehicles before changing lanes.

Important Safety Reminder

Like all assistance systems, BSI has limitations. Over reliance on BSI may result in a collision.

The system is for your convenience only. Even if an object is within the alert zone, the following situations may occur.

- The BSI alert indicator may not come on due to obstruction (splashes, etc.) even without the **Blind Spot Info Not Available** multi-information display appearing.
- The BSI alert indicator may come on even with the message appearing.

* Not available on all models

■ When the system detects a vehicle

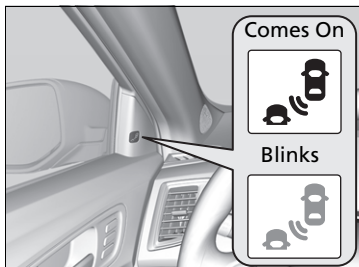

BSI Alert Indicator: Located near the outside rearview mirror on both sides.

Comes on when:

- A vehicle enters the alert zone from behind to overtake you with a speed difference of no more than 31 mph (50 km/h) from your vehicle.
- You pass a vehicle with a speed difference of no more than 12 mph (20 km/h).

Blinks and a beeper sounds when:

You move the turn signal lever in the direction of the detected vehicle. The beeper sounds three times.

▣ Blind spot information (BSI) System*

The BSI alert indicator may not come on under the following conditions:

- A vehicle does not stay in the alert zone for more than two seconds.
- A vehicle is parked in a side lane.
- The speed difference between your vehicle and the vehicle you are passing is greater than 6 mph (10 km/h).
- An object not detected by the radar sensors approaches or passes your vehicle.
- A vehicle running in the adjacent lane is a motorcycle or other small vehicle.

You can turn off the audible alert, or all the BSI alert using the information screen or multi-information display.

▣ **Customized Features** P. 120, 292

BSI may be adversely affected when:

- Objects (guard rails, poles, trees, etc.,) are detected.
- An object that does not reflect radio waves well, such as a motorcycle, is in the alert zone.
- Driving on a curved road.
- A vehicle is moving from a far lane to the adjacent lane.
- The system picks up external electrical interference.
- The rear bumper or the sensors have been improperly repaired or the rear bumper has been deformed.
- The orientation of the sensors has been changed.
- In bad weather (Heavy rain, snow, and fog).

▣ Blind spot information (BSI) System*

For a proper BSI use:

- Always keep the rear bumper corner area clean.
- Do not cover the rear bumper corner area with labels or stickers of any kind.
- Take your vehicle to a dealer if you need the rear bumper corner area or the radar sensors to be repaired, or the rear bumper corner area is strongly impacted.

The system does not operate when in **R**.

Super Handling-All Wheel Drive™ (SH-AWD®)*

The system controls and transfers varying amounts of engine torque to each wheel in accordance with the driving conditions.

SH-AWD® helps to enhance driving stability, and lets you handle situations like slippery surfaces, such as on wet, icy, or snowy roads, better than when driving with two wheel drive. However, the system does not help to enhance braking. Be precautious about the following:

- It is still your responsibility to drive safely when you steer, accelerate, and apply brakes.
- Leave a sufficient margin when braking on slippery surfaces.

ⓘ Super Handling-All Wheel Drive™ (SH-AWD®)*

The SH-AWD® system may not function properly if tire type and size are mixed.

Make sure to use the same size and type of tire, and the air pressures as specified.

🔧 Tire and Wheel Replacement P. 501

Do not continuously spin the front tires of your vehicle. Continuously spinning the front tires can cause damage to the transmission and SH-AWD® unit.

If the **SH-AWD** indicator blinks while driving, it indicates the differential temperature is too high. If this happens, pull to the side of the road when it is safe, change the gear position to **[P]**, and idle the engine until the indicator goes out.

Tire Pressure Monitoring System (TPMS) with Tire Fill Assist

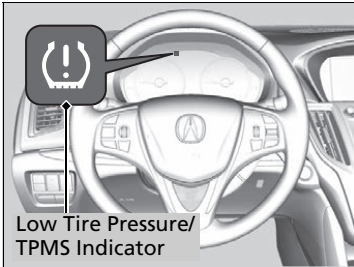

Monitors the tire pressure while you are driving. If your vehicle's tire pressure becomes significantly low, the low tire pressure/TPMS indicator comes on and a message appears on the multi-information display.

☒ Tire Pressure Monitoring System (TPMS) with Tire Fill Assist

Conditions such as low ambient temperature and altitude change directly affect tire pressure and can trigger the low tire pressure/TPMS indicator to come on.

☒ If the Low Tire Pressure/TPMS Indicator Comes On or Blinks P. 553

Tire pressure checked and inflated in:

- Warm weather can become under-inflated in colder weather.
- Cold weather can become over-inflated in warmer weather.

The low tire pressure/TPMS indicator will not come on as a result of over inflation.

The TPMS audibly and visually informs you of changes in tire pressure of the individual tire that you are adjusting using audible and visual indications.

If a change in tire pressure has been significant, the system beeps and the hazard lights flash continuously for five seconds when the specified tire pressure is reached. Stop filling the tire.

■ Tire Pressure Monitor

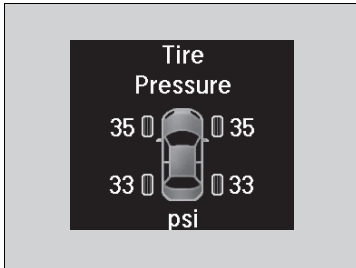

To select the tire pressure monitor, set the power mode to ON, and roll the right selector wheel until you see the tire pressure screen.

The pressure for each tire is displayed in PSI (U.S.) or kPa (Canada).

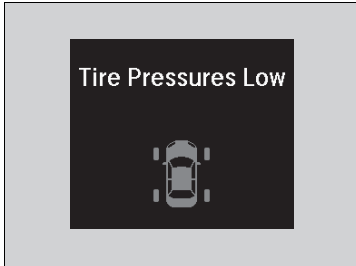

Tire Pressures Low is displayed when a tire has significantly low pressure. The specific tire is displayed on the screen.

▶ Tire Pressure Monitor

The pressure displayed on the multi-information display can be slightly different from the actual pressure as measured by a gauge. If there is a significant difference between the two values, or if the low tire pressure/TPMS indicator and the message on the multi-information display do not go off after you have inflated the tire to the specified pressure, have the system checked by a dealer.

Tire Pressure Monitor Problem may appear if you drive with the compact spare tire*, or there is a problem with the TPMS.

Tire Pressure Monitoring System (TPMS) - Required Federal Explanation

Each tire, including the spare (if provided), should be checked monthly when cold and inflated to the inflation pressure recommended by the vehicle manufacturer on the vehicle placard or tire inflation pressure label.

(If your vehicle has tires of a different size than the size indicated on the vehicle placard or tire inflation pressure label, you should determine the proper tire inflation pressure for those tires.)

As an added safety feature, your vehicle has been equipped with a tire pressure monitoring system (TPMS) that illuminates a low tire pressure telltale



when one or more of your tires is significantly under-inflated.

Accordingly, when the low tire pressure telltale illuminates, you should stop and check your tires as soon as possible, and inflate them to the proper pressure.

Driving on a significantly under-inflated tire causes the tire to overheat and can lead to tire failure. Under-inflation also reduces fuel efficiency and tire tread life, and may affect the vehicle's handling and stopping ability.

Please note that the TPMS is not a substitute for proper tire maintenance, and it is the driver's responsibility to maintain correct tire pressure, even if under-inflation has not reached the level to trigger illumination of the TPMS low tire pressure telltale.

Your vehicle has also been equipped with a TPMS malfunction indicator to indicate when the system is not operating properly. The TPMS malfunction indicator is combined with the low tire pressure telltale. When the system detects a malfunction, the telltale will flash for approximately one minute and then remain continuously illuminated. This sequence will continue upon subsequent vehicle start-ups as long as the malfunction exists.

When the malfunction indicator is illuminated, the system may not be able to detect or signal low tire pressure as intended.

TPMS malfunctions may occur for a variety of reasons, including the installation of replacement or alternate tires or wheels on the vehicle that prevent the TPMS from functioning properly.

Always check the TPMS malfunction telltale after replacing one or more tires or wheels on your vehicle to ensure that the replacement or alternate tires and wheels allow the TPMS to continue to function properly.

Brake System

■ Parking Brake

Use the parking brake to keep the vehicle stationary when parked. When the parking brake is applied, you can manually or automatically release it.

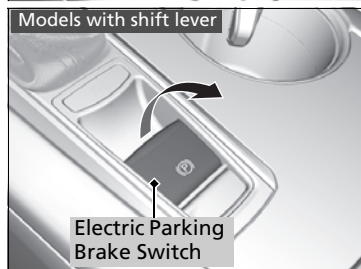
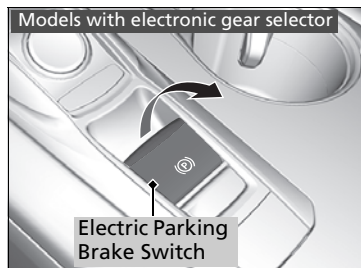

■ To apply

Pull the electric parking brake switch up gently and securely.

- ▶ The electric parking brake indicator comes on.

⊠ Parking Brake

You may hear the electric parking brake system motor operating from the rear wheel area when you apply or release the parking brake, or set the power mode to OFF. This is normal.

The brake pedal may slightly move due to the electric parking brake system operation when you apply or release the parking brake. This is normal.

You cannot apply or release the parking brake if the battery goes dead.

➤ **Jump Starting** P. 542

If you pull up and hold the electric parking brake switch while driving, the brakes on all four wheels are applied by the VSA® system until the vehicle come to a stop. The electric parking brake then applies, and the switch should be released.

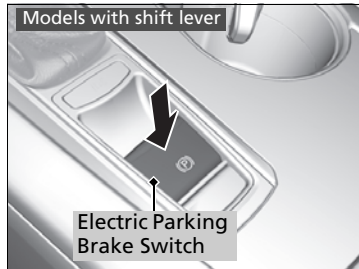
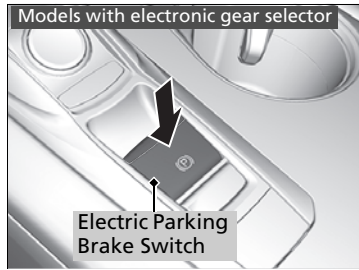

■ To release

1. Depress the brake pedal fully.
2. Press the electric parking brake switch.
 - The electric parking brake indicator goes off.

Manually releasing the parking brake using the switch helps your vehicle start slowly and smoothly when facing down hill on steep hills.

►► Parking Brake

In the following situations, the parking brake automatically operates.

- When the vehicle stops more than 10 minutes while ACC with LSF is activated.
- When the driver's seat belt is unfastened while your vehicle is stopped automatically by ACC with LSF.
- When the engine is turned off while ACC with LSF is activated.
- When the vehicle stops with the automatic brake hold system activated for more than 10 minutes.
- When the driver's seat belt is unfastened while your vehicle is stopped and brake hold is applied.
- When the engine is turned off while brake hold is applied.
- When there is a problem with the Brake Hold System.

■ To release automatically

Depressing the accelerator pedal releases the parking brake. Use the accelerator pedal to release the brake when you are starting the vehicle facing uphill, or in a traffic jam.

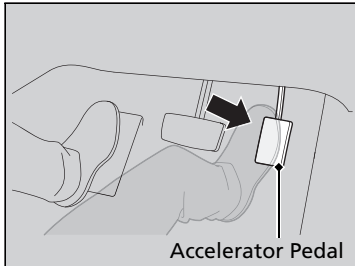

Gently depress the accelerator pedal. When on a hill, it may require more accelerator input to release.

- ▶ The electric parking brake indicator goes off.

You can release the parking brake automatically when:

- You are wearing the driver's seat belt.
- The engine is running.
- The transmission is not in **P** or **N**.

⊠ Parking Brake

If the parking brake cannot be released automatically, release it manually.

The parking brake cannot be released automatically while the following indicators are on:

- Malfunction indicator lamp
- Transmission System indicator

The parking brake may not be released automatically while the following indicators are on:

- Electric parking brake system indicator
- VSA® system indicator
- **ABS** indicator
- Supplemental restraint system indicator

■ Foot Brake

Your vehicle is equipped with disc brakes at all four wheels. A vacuum power assist helps to reduce the effort needed on the brake pedal. The brake assist system increases the stopping force when you depress the brake pedal hard in an emergency situation. The anti-lock brake system (ABS) helps you retain steering control when braking very hard.

➤ **Brake Assist System** P. 436

➤ **Anti-lock Brake System (ABS)** P. 435

☒ Foot Brake

Check the brakes after driving through deep water, or if there is a buildup of road surface water. If necessary, dry the brakes by lightly depressing the pedal several times.

If you hear a continuous metallic friction sound when applying the brakes, this is caused by the brake wear indicator rubbing on the brake rotor and indicates that the brake pads need to be replaced. Have the vehicle checked by a dealer. If you hear only an occasional squeak or squeal when you initially apply the brake pedal, this may be normal and caused by high frequency vibration of the brake pads against the rotating brake disc.

Constantly using the brake pedal while going down a long hill builds up heat, which reduces the brake effectiveness. Apply engine braking by taking your foot off the accelerator pedal and downshifting to a lower gear.

Do not rest your foot on the brake pedal while driving, as it will lightly apply the brakes and cause them to lose effectiveness over time and reduce pad life. It will also confuse drivers behind you.

Automatic Brake Hold

Keeps the brake applied after releasing the brake pedal until the accelerator pedal is pressed. You can use this system while the vehicle is temporarily stopped, like at traffic lights and in heavy traffic.

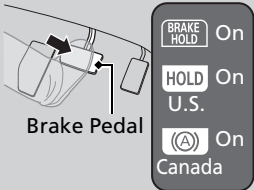
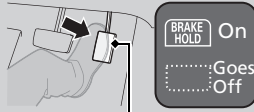
| | | |
|---|---|---|
| <p>■ Turning on the system</p>  <p>Automatic Brake Hold Button</p> <p>Fasten your seat belt properly, then start the engine. Press the automatic brake hold button.</p> <ul style="list-style-type: none"> • The automatic brake hold system indicator comes on. The system is turned on. | <p>■ Activating the system</p>  <p>Brake Pedal</p> <p>Depress the brake pedal to come to a complete stop. The transmission must be in D or N.</p> <ul style="list-style-type: none"> • The automatic brake hold indicator comes on. Braking is kept for up to 10 minutes. • Release the brake pedal after the automatic brake hold indicator comes on. | <p>■ Canceling the system</p>  <p>Accelerator Pedal</p> <p>Depress the accelerator pedal while the transmission is in D. The system is canceled and the vehicle starts to move.</p> <ul style="list-style-type: none"> • The automatic brake hold indicator goes off. The system continues to be on. |
|---|---|---|

Automatic Brake Hold

⚠ WARNING

Activating the automatic brake hold system on steep hills or slippery roads may still allow the vehicle to move if you remove your foot from the brake pedal.

If a vehicle unexpectedly moves, it may cause a crash resulting in serious injury or death.

Never activate the automatic brake hold system or rely on it to keep a vehicle from moving when stopped on a steep hill or slippery roads.

⚠ WARNING

Using the automatic brake hold system to park the vehicle may result in the vehicle unexpectedly moving.

If a vehicle moves unexpectedly, it may cause a crash, resulting in serious injury or death.

Never leave the vehicle when braking is temporarily kept by automatic brake hold and always park the vehicle by putting the transmission in **P** and applying the parking brake.

■ **The system automatically cancels when:**

- You depress the brake pedal and change to **P** or **R**.
- You engage the parking brake.

Under the following conditions, the system automatically cancels, and the parking brake is applied:

- Braking is kept for more than 10 minutes.
- The driver's seat belt is unfastened.
- The engine is turned off.
- **Brake Hold System Problem** appears on the multi-information display.

■ **Turning off the automatic brake hold system**

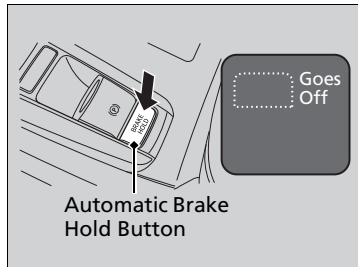

While the system is on, press the automatic brake hold button again.

- The automatic brake hold system indicator goes off.

If you want to turn off automatic brake hold while the system is in operation, press the automatic brake hold button with the brake pedal depressed.

⌘ Automatic Brake Hold

While the system is activated, you can turn off the engine or park the vehicle through the same procedure as you normally do.

⌘ **When Stopped** P. 446

Whether the system is on, or the system is activated, the automatic brake hold turns off once the engine is off.

⌘ Turning on the system

Make sure to turn off the automatic brake hold system before using an automated car wash.

You may hear an operating noise if the vehicle moves while the automatic brake hold system is in operation. The system generates sound while holding the vehicle and it moves.

Anti-lock Brake System (ABS)

■ ABS

Helps prevent the wheels from locking up, and helps you retain steering control by pumping the brakes rapidly, much faster than you.

The electronic brake distribution (EBD) system, which is part of the ABS, also balances the front-to-rear braking distribution according to vehicle loading.

You should never pump the brake pedal. Let the ABS work for you by always keeping firm, steady pressure on the brake pedal. This is sometimes referred to as “stomp and steer.”

■ ABS operation

The brake pedal may pulsate slightly when the ABS is working. Keep holding the pedal firmly down. On dry pavement, you will need to press on the brake pedal very hard before the ABS activates. However, you may feel the ABS activate immediately if you are trying to stop on snow or ice.

ABS may activate when you depress the brake pedal when driving on:

- Wet or snow covered roads.
- Roads paved with stone.
- Roads with uneven surfaces, such as potholes, cracks, manholes, etc.

When the vehicle speed goes under 6 mph (10 km/h), the ABS stops.

▶▶ Anti-lock Brake System (ABS)

NOTICE

The ABS may not function correctly if you use a tire of the wrong size or type.

If the **ABS** indicator comes on while driving, there may be a problem with the system. While normal braking will not be affected, there is a possibility that the ABS will not operating. Have your vehicle checked by a dealer immediately.

The ABS is not designed for the purpose of reducing the time or distance it takes for a vehicle to stop: It is designed to limit brake lockup which can lead to skidding and loss of steering control.

In the following cases, your vehicle may need more distance to stop than a vehicle without the ABS:

- You are driving on rough or uneven road surfaces, such as gravel or snow.
- The tires are equipped with snow chains.

The following may be observed with the ABS system:

- Motor sounds coming from the engine compartment when the brakes are applied, or when system checks are being performed after the engine has been started and while vehicle is accelerates.
- Brake pedal and/or the vehicle body vibration when ABS activates.

These vibrations and sounds are normal to ABS systems and are no cause for concern.

Brake Assist System

■ Brake Assist System

Designed to assist the driver by generating greater braking force when you depress the brake pedal hard during emergency braking.

■ Brake assist system operation

Press the brake pedal firmly for more powerful braking.

When brake assist operates, the pedal may wiggle slightly and an operating noise may be heard. This is normal. Keep holding the brake pedal firmly down.

Collision Mitigation Braking System™ (CMBS™)

Can assist you when there is a possibility of your vehicle colliding with a vehicle or a pedestrian detected in front of yours. The CMBS™ is designed to alert you when a potential collision is determined, as well as to reduce your vehicle speed to help minimize collision severity when a collision is deemed unavoidable.

■ How the system works

When to use

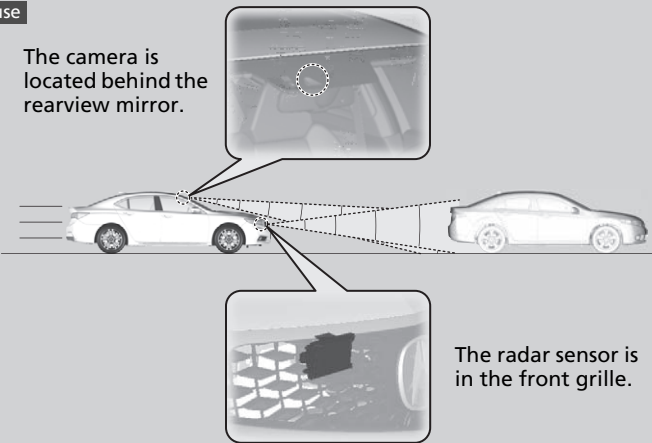

The camera is located behind the rearview mirror.

The radar sensor is in the front grille.

The system starts monitoring the roadway ahead when your vehicle speed is about 3 mph (5 km/h) and there is a vehicle in front of you.

The CMBS™ activates when:

- The speed difference between your vehicle and a vehicle or pedestrian detected in front of you becomes about 3 mph (5 km/h) and over with a chance of a collision.
- Your vehicle speed is about 62 mph (100 km/h) or less and there is a chance of a collision with an oncoming detected vehicle or a pedestrian in front of you.

Continued

⊗ Collision Mitigation Braking System™ (CMBS™)

Important Safety Reminder

The CMBS™ is designed to reduce the severity of an unavoidable collision. It does not prevent a collision nor stop the vehicle automatically. It is still your responsibility to operate the brake pedal and steering wheel appropriately according to the driving conditions.

The CMBS™ may not activate or may not detect a vehicle in front of your vehicle under certain conditions:

➤ **CMBS™ Conditions and Limitations** P. 441

You can read about handling information for the camera equipped with this system.

➤ **Front Sensor Camera** P. 389

Be careful not to have the radar sensor cover strongly impacted.

⊗ How the system works

Rapid vibrations on the steering wheel alert you when your vehicle speed is between 19 and 62 mph (30 and 100 km/h) with an oncoming vehicle detected in front of you.

When the CMBS™ activates, it may automatically apply the brake. It will be canceled when your vehicle stops or a potential collision is not determined.

■ When the system activates

The system provides visual, audible and tactile alerts of a possible collision, and stops if the collision is avoided.

- ▶ Take appropriate action to prevent a collision (apply the brakes, change lanes, etc.)

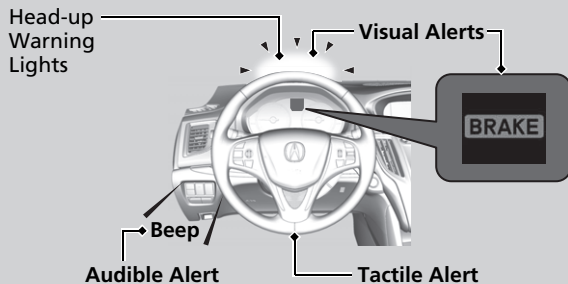

At system's earliest collision alert stage, you can change the distance (**Long/Normal/Short**) between vehicles at which alerts will come on through multi-information display setting options.

- ▶ **List of customizable options** P. 123, 300

■ Vibration alert on the steering wheel

When a potential collision to an oncoming detected vehicle is determined, the system alerts you with rapid vibration on the steering wheel, in addition to visual and audible alerts.

- ▶ Take appropriate action to prevent a collision (apply the brakes, operate the steering wheel, etc.).

▶ When the system activates

The camera in the CMBS™ is also designed to detect pedestrians.

However, this pedestrian detection feature may not activate or may not detect a pedestrian in front of your vehicle under certain conditions.

Refer to the ones indicating the pedestrian detection limitations from the list.

- ▶ **CMBS™ Conditions and Limitations** P. 441

The head-up warning uses a lens located at the front end of the dashboard.

Do not cover the lens or spill any liquid on it.

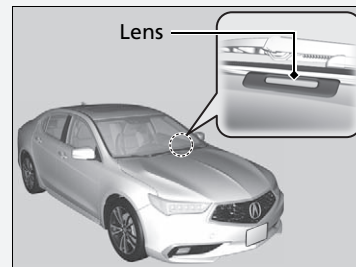

▶ Vibration alert on the steering wheel

Vibration alert function is disabled when the electric power steering (EPS) system indicator comes on.

- ▶ **Electric Power Steering (EPS) System Indicator** P. 79

Collision Alert Stages

The system has three alert stages for a possible collision. However, depending on circumstances, the CMBS™ may not go through all of the stages before initiating the last stage.

| Distance between vehicles | | CMBS™ | | | |
|---------------------------|--|--|--|---|--------------------|
| | | The radar sensor detects a vehicle | Audible & Visual WARNINGS | Steering Wheel | Braking |
| Stage one | | There is a risk of a collision with the vehicle ahead of you. | When in Long, visual and audible alerts come on at a longer distance from a vehicle ahead than in Normal setting, and in Short , at a shorter distance than in Normal . | In case of an oncoming vehicle detected, rapid vibration is provided. | — |
| Stage two | | The risk of a collision has increased, time to respond is reduced. | Visual and audible alerts. | — | Lightly applied |
| Stage three | | The CMBS™ determines that a collision is unavoidable. | | | Forcefully applied |

■ CMBS™ On and Off

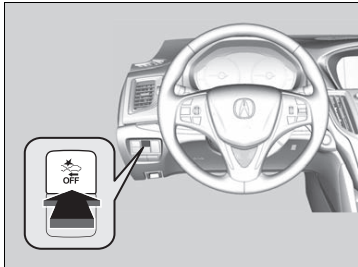

Press and hold the button until the beeper sounds to switch the system on or off.

When the CMBS™ is off:

- The CMBS™ indicator in the instrument panel comes on.
- A message on the multi-information display reminds you that the system is off.

The CMBS™ is turned on every time you start the engine, even if you turned it off the last time you drove the vehicle.

▣ Collision Mitigation Braking System™ (CMBS™)

The CMBS™ may automatically shut off, and the CMBS™ indicator will come and stay on under certain conditions:

▣ **CMBS™ Conditions and Limitations** P. 441

CMBS™ Conditions and Limitations

The system may automatically shut off and the CMBS™ indicator will come on under certain conditions. Some examples of these conditions are listed below. Other conditions may reduce some of the CMBS™ functions.

📷 Front Sensor Camera P. 389

■ Environmental conditions

- Driving in bad weather (rain, fog, snow, etc.).
- Sudden changes between light and dark, such as an entrance or exit of a tunnel.
- There is little contrast between objects and the background.
- Driving into low sunlight (e.g., at dawn or dusk).
- Strong light is reflected onto the roadway.
- Driving in the shadows of trees, buildings, etc.
- Roadway objects or structures are misinterpreted as vehicles and pedestrians.
- Reflections on the interior of the front windshield.
- Driving at night or in a dark condition such as a tunnel.

■ Roadway conditions

- Driving on a snowy or wet roadway (obscured lane marking, vehicle tracks, reflected lights, road spray, high contrast).
- Driving on curvy, winding, or undulating roads.
- The road is hilly or the vehicle is approaching the crest of a hill.

📷 CMBS™ Conditions and Limitations

Do not paint, or apply any coverings or paint to the radar sensor area. This can impact CMBS™ operation.

Have your vehicle checked by a dealer if you find any unusual behavior of the system (e.g., the warning message appears too frequently).

If the front of the vehicle is impacted in any of the following situations, the radar sensor may not work properly. Have your vehicle checked by a dealer:

- The vehicle mounted onto a bump, curb, chock, embankment, etc.
- You drive the vehicle where the water is deep.
- Your vehicle has a frontal collision.

If you need the radar sensor to be repaired, or removed, or the radar sensor cover is strongly impacted, turn off the system by pressing the CMBS™ off button and take your vehicle to a dealer.

■ **Vehicle conditions**

- Headlight lenses are dirty or the headlights are not properly adjusted.
- The outside of the windshield is blocked by dirt, mud, leaves, wet snow, etc.
- The inside of the windshield is fogged.
- An abnormal tire or wheel condition (wrong sized, varied size or construction, improperly inflated, compact spare tire*, etc.).
- When tire chains are installed.
- The vehicle is tilted due to a heavy load or suspension modifications.
- The camera temperature gets too high.
- Driving with the parking brake applied.
- When the radar sensor in the front grille gets dirty.

■ Detection limitations

- A vehicle or pedestrian suddenly crosses in front of you.
- The distance between your vehicle and the vehicle or pedestrian ahead of you is too short.
- A vehicle cuts in front of you at a slow speed, and it brakes suddenly.
- When you accelerate rapidly and approach the vehicle or pedestrian ahead of you at high speed.
- The vehicle ahead of you is a motorcycle, bicycle, mobility scooter or other small vehicle.
- When there are animals in front of your vehicle.
- When you drive on a curved, winding or undulating road that makes it difficult for the sensor to properly detect a vehicle in front of you.
- The speed difference between your vehicle and a vehicle in front of you is significantly large.
- An oncoming vehicle suddenly comes in front of you.
- Another vehicle suddenly comes in front of you at an intersection, etc.
- Your vehicle abruptly crosses over in front of an oncoming vehicle.
- When driving through a narrow iron bridge.
- When the lead vehicle suddenly slows down.

Limitations applicable to pedestrian detection only

- When there is a group of people in front of your vehicle walking together side by side.
- Surrounding conditions or belongings of the pedestrian alter the pedestrian's shape, preventing the system from recognizing that the person is a pedestrian.
- When the pedestrian is shorter than about 3 feet (1 meter) or taller than about 7 feet (2 meter) in height.
- When a pedestrian blends in with the background.
- When a pedestrian is bent over or squatting, or when their hands are raised or they are running.
- When several pedestrians are walking ahead in a group.
- When the camera cannot correctly identify that a pedestrian is present due to an unusual shape (holding luggage, body position, size).

■ Automatic shutoff

The CMBS™ may automatically shut itself off and the CMBS™ indicator comes and stays on when:

- The temperature inside the system is high.
- You drive off-road or on a mountain road, or curved and winding road for an extended period.
- An abnormal tire condition is detected (wrong tire size, flat tire, etc.).
- The camera behind the rearview mirror, or the area around the camera, including the windshield, gets dirty.

Once the conditions that caused the CMBS™ to shut off improve or are addressed (e.g., cleaning), the system comes back on.

■ With Little Chance of a Collision

The CMBS™ may activate even when you are aware of a vehicle ahead of you, or when there is no vehicle ahead. Some examples of this are:

■ When Passing

Your vehicle approaches another vehicle ahead of you and you change lanes to pass.

■ At an intersection

Your vehicle approaches or passes another vehicle that is making a left or right turn.

■ On a curve

When driving through curves, your vehicle comes to a point where an oncoming vehicle is right in front of you.

■ Through a low bridge at high speed

You drive under a low or narrow bridge at high speed.

■ Speed bumps, road work sites, train tracks, roadside objects, etc.

You drive over speed bumps, steel road plates, etc., or your vehicle approaches train tracks or roadside objects [such as a traffic sign and guard rail] on a curve or, when parking, stationary vehicles and walls.

⌘ Collision Mitigation Braking System™ (CMBS™)

For the CMBS™ to work properly:

Always keep the radar sensor cover clean.

Never use chemical solvents or polishing powder for cleaning the sensor cover. Clean it with water or a mild detergent.

When Stopped

1. Depress the brake pedal firmly.
2. With the brake pedal depressed, pull up the electric parking brake switch slowly, but fully.
3. Change the gear position to **P**.
4. Turn off the engine.
 - ▶ The electric parking brake indicator goes off in about 15 seconds.

⌘ Parking Your Vehicle

Do not park your vehicle near flammable objects, such as dry grass, oil, or timber. Heat from the exhaust can cause a fire.

⌘ When Stopped

NOTICE

The following can damage the transmission:

- Depressing the accelerator and brake pedals simultaneously.
- Changing into **P** before the vehicle stops completely.

In extremely cold temperatures, the parking brake may freeze up if applied. If such temperatures are expected, do not apply the parking brake but, if parking on a slope, either turn the front wheels so they will contact the curb if the vehicle rolls down the slope or block the wheels to keep the vehicle from moving. If you do not take either precaution, the vehicle may roll unexpectedly, leading to a crash.

Always confirm the electric parking brake is set, particularly if you are parked on an incline.

When Stopped

When facing uphill, do not hold the vehicle by depressing the accelerator pedal. Doing so may cause the items to malfunction or a fire inside the vehicle.

 WARNING

The vehicle can roll away if left unattended without confirming that Park is engaged.

A vehicle that rolls away could cause a crash resulting in serious injury or death.

Always keep your foot on the brake pedal until you have confirmed that **P** is shown on the gear position Indicator.

Parking Sensor System*

The corner and center sensors monitor obstacles around your vehicle. The beeper and information screen lets you know the approximate distance between your vehicle and the obstacle.

■ The sensor location and range

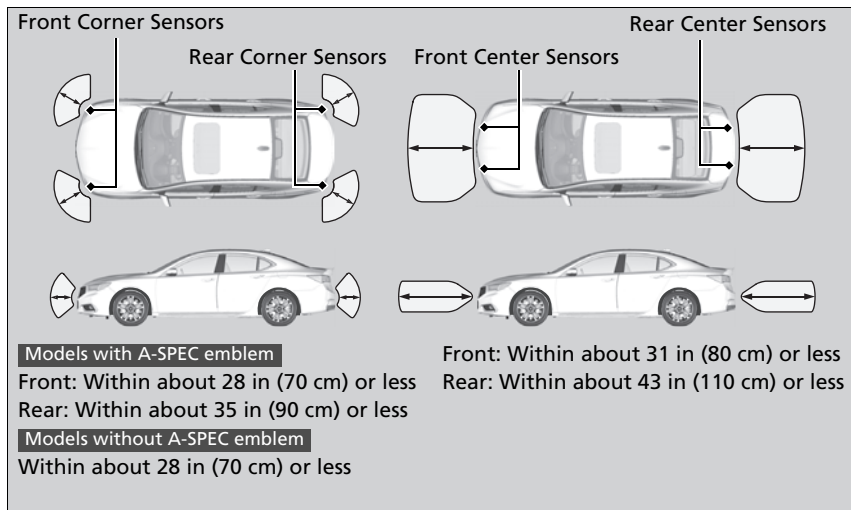

▣ Parking Sensor System*

Even when the system is on, always confirm if there is no obstacle near your vehicle before parking.

The system may not work properly when:

- The sensors are covered with snow, ice, mud or dirt.
- The vehicle is on uneven surface, such as grass, bumps, or a hill.
- The vehicle has been out in hot or cold weather.
- The system is affected by devices that emit ultrasonic waves.
- Driving in bad weather.

The system may not sense:

- Thin or low objects.
- Sonic-absorptive materials, such as snow, cotton, or sponge.
- Objects directly under the bumper.

Do not put any accessories on or around the sensors.

■ Parking sensor system on and off

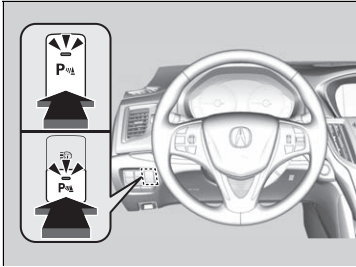

With the power mode in ON, press the parking sensor system button to turn the system on or off. The indicator in the button comes on when the system is on.

The rear center and corner sensors start to detect an obstacle when the transmission is in **R**, and the vehicle speed is less than 5 mph (8 km/h).

The front corner sensors start to detect an obstacle when the transmission is not in **P**, and the vehicle speed is less than 5 mph (8 km/h).

■ When the distance between your vehicle and obstacles behind becomes shorter

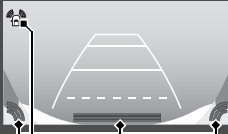
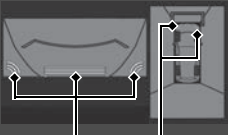
| Length of the intermittent beep | Distance between the Bumper and Obstacle | | Indicator | Information Screen |
|---------------------------------|--|--|--------------------|--|
| | Corner Sensors | Center Sensors | | |
| Moderate | Rear*1: About 35-28 in (90-70 cm) | Front: About 31-28 in (80-70 cm) Rear: About 43-28 in (110-70 cm) | Blinks in Yellow*2 | <div data-bbox="1187 300 1458 348" data-label="Text"> <p>Models with multi-view rear camera system</p> </div>  <div data-bbox="1177 527 1445 572" data-label="Text"> <p>Indicators light where the sensor detects an obstacle.</p> </div> |
| Short | About 28-18 in (70-45 cm) | About 28-18 in (70-45 cm) | Blinks in Amber | <div data-bbox="1187 602 1458 650" data-label="Text"> <p>Models with surround view camera system</p> </div>  <div data-bbox="1177 829 1445 874" data-label="Text"> <p>Indicators light where the sensor detects an obstacle.</p> </div> |
| Very short | About 18-14 in (45-35 cm) | About 18-14 in (45-35 cm) | | |
| Continuous | About 14 in (35 cm) or less | About 14 in (35 cm) or less | Blinks in Red | |

*1: Models with A-SPEC emblem

*2: At this stage, only the center sensors detect obstacles.

■ Turning off All Rear Sensors

1. Make sure that the parking sensor system is not activated. Set the power mode to VEHICLE OFF (LOCK).
2. Press and hold the parking sensor system button, and set the power mode to ON.
3. Keep pressing the button for 10 seconds. Release the button when the indicator in the button flashes.
4. Press the button again. The indicator in the button goes off.
 - ▶ The beeper sounds twice. The rear sensors are now turned off.

To turn the rear sensors on again, follow the above procedure. The beeper sounds three times when the rear sensors come back on.

☒ Turning off All Rear Sensors

When you set the gear position to **[R]**, the indicator in the parking sensor system button blinks as a reminder that the rear sensors have been turned off.

Cross Traffic Monitor*

Monitors the rear corner areas using the radar sensors when reversing, and alerts you if a vehicle approaching from a rear corner is detected.

The system is convenient when you are backing out of a parking space.

ⓘ Cross Traffic Monitor*

CAUTION

Cross Traffic Monitor cannot detect all approaching vehicles and may not detect an approaching vehicle at all.

Failure to visually confirm that it is safe to back up the vehicle before doing so may result in a collision.

Do not solely rely on the system when reversing; always also use your mirrors, and look behind and to the sides of your vehicle before reversing.

How the System Works

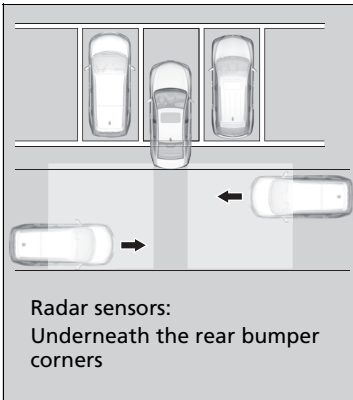

The system activates when:

- The power mode is in ON.
- The Cross Traffic Monitor is turned on.
 - ▶ **Cross Traffic Monitor On and Off** P. 456
 - ▶ **Customized Features** P. 292
- The transmission is in **R**.
- Your vehicle is moving at 3 mph (5 km/h) or lower.

When a vehicle is detected approaching from a rear corner, Cross Traffic Monitor alerts you with a buzzer and a displayed warning.

The system will not detect a vehicle that approaches from directly behind your vehicle, nor will it provide alerts about a detected vehicle when it moves directly behind your vehicle.

The system does not detect or provide alerts for a vehicle that is moving away from your vehicle, and it may not detect or alert for pedestrians, bicycles, or stationary objects.

⚠ Cross Traffic Monitor*

Cross Traffic Monitor may not detect or may delay alerting an approaching vehicle, or may alert without an approaching vehicle under the following conditions:

- An obstacle, such as another vehicle and a wall, near your vehicle's rear bumper, is blocking the radar sensor's scope.
- Your vehicle is moving at the speed of about 3 mph (5 km/h) or higher.
- A vehicle is approaching at the speed other than between about 6 mph (10 km/h) and 16 mph (25 km/h).
- The system picks up external interference such as other radar sensors from another vehicle or strong radio wave transmitted from a facility nearby.
- Either corner of the rear bumper is covered with snow, ice, mud or dirt.
- When there is bad weather.
- Your vehicle is on an incline.
- Your vehicle is tilted due to a heavy load in the rear.
- Your vehicle is reversing towards a wall, a pole, a vehicle, and so on.
- The rear bumper or the sensors have been improperly repaired or the rear bumper has been deformed. Have your vehicle checked by a dealer.

* Not available on all models

» Cross Traffic Monitor*

For proper operation, always keep the rear bumper corner area clean.
Do not cover the rear bumper corner area with labels or stickers of any kind.

Models with parking sensor system

The parking sensor system's alerting buzzer overrides the Cross Traffic Monitor buzzer when the sensors are detecting obstacles at the closest range.

When the System Detects a Vehicle

Models with multi-view rear camera system

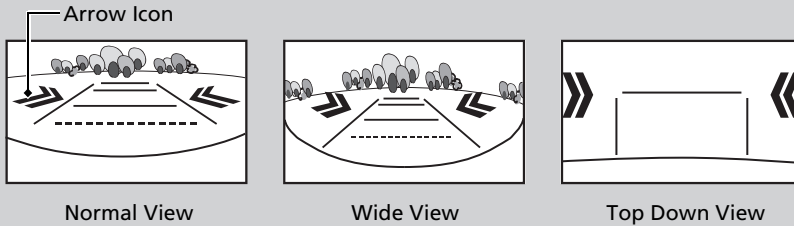

Models with surround view camera system

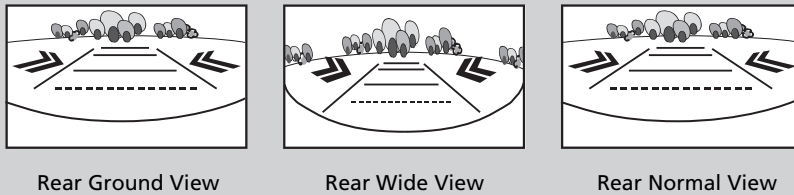

An arrow icon appears on the side a vehicle is approaching on the information screen.

When the System Detects a Vehicle

If the on the lower right changes to in amber when the transmission is in **R**, mud snow or ice, etc. may have accumulated in the vicinity of the sensor. The system is temporarily canceled. Check the bumper corners for any obstructions, and thoroughly clean the area if necessary.

If the comes on when the transmission is in **R**, there may be a problem with the Cross Traffic Monitor system. Do not use the system and have your vehicle checked by a dealer.

If the display remains the same with the transmission in **R**, there may be a problem with the rear camera system and the Cross Traffic Monitor system. Do not use the system and have your vehicle checked by a dealer.

■ Cross Traffic Monitor On and Off

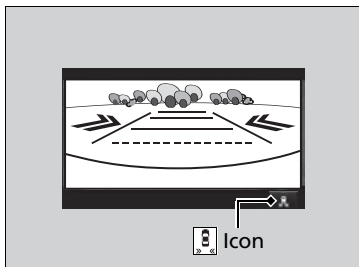

You can switch on and off the system using the information screen.

▶ **Customized Features** P. 292

About Your Multi-View Rear Camera

The information screen can display your vehicle's rear view. The display automatically changes to the rear view when the transmission is put into **R**.

Multi-View Rear Camera Display Area

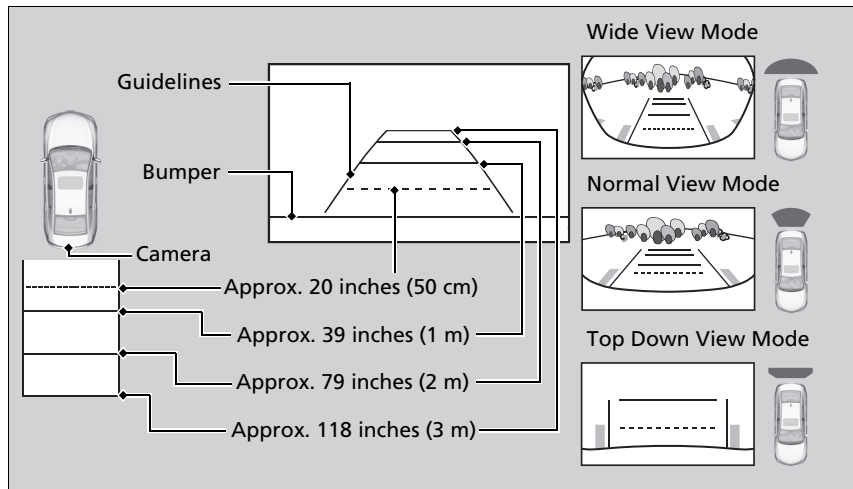

You can view three different camera angles on the rearview display. Press the interface dial to switch the angle.

About Your Multi-View Rear Camera

The rear camera view is restricted. You cannot see the corner ends of the bumper or what is underneath the bumper. Its unique lens also makes objects appear closer or farther than they actually are.

Visually confirm that it is safe to drive before backing up. Certain conditions (such as weather, lighting, and high temperatures) may also restrict the rear view. Do not rely on the rearview display which does not give you all information about conditions at the back of your vehicle.

If the camera lens is covered with dirt or moisture, use a soft, moist cloth to keep the lens clean and free of debris.

You can change the **Fixed Guideline** and **Dynamic Guideline** settings.

➤ **Customized Features** P. 292

Fixed Guideline

On: Guidelines appear when you put the transmission into **R**.

Off: Guidelines do not appear.

Dynamic Guideline

On: Guidelines move according to the steering wheel direction.

Off: Guidelines do not move.

- If the last used viewing mode was Wide or Normal, the same mode is selected the next time you put the transmission into **R**.
- If Top down view was last used before you turned the power mode to ON, Wide View mode is selected next time you set the power mode to ON and put the transmission into **R**.
- If Top down view was last used more than 10 seconds after you change from **R**, Wide View mode is selected the next time you put the transmission into **R**.

See the Navigation System Manual.

Fuel Information

■ Fuel recommendation

Unleaded premium gasoline, pump octane number 91 or higher

Use of lower octane gasoline can cause occasional metallic knocking noise in the engine and will result in decreased engine performance.

Use of gasoline with a pump octane less than 87 can lead to engine damage.

■ Top tier detergent gasoline

Because the level of detergency and additives in gasoline vary in the market, Acura endorses the use of "TOP TIER Detergent Gasoline" where available to help maintain the performance and reliability of your vehicle. TOP TIER Detergent Gasoline meets a new gasoline standard jointly established by leading automotive manufacturers to meet the needs of today's advanced engines.

Qualifying gasoline retailers will, in most cases, identify their gasoline as having met "TOP TIER Detergent Gasoline" standards at the retail location. This fuel is guaranteed to contain the proper level of detergent additives and be free of metallic additives. The proper level of detergent additives, and absence of harmful metallic additives in gasoline, help avoid build-up of deposits in your engine and emission control system.

For further important fuel-related information for your vehicle, or on information on gasoline that does not contain MMT, visit Acura Owners at owners.acura.com. In Canada, visit www.acura.ca for additional information on gasoline. For more information on top tier gasoline, visit www.toptiergas.com.

■ Fuel tank capacity: 17.2 US gal (65 liters)

☞ Fuel Information

NOTICE

We recommend quality gasoline containing detergent additives that help prevent fuel system and engine deposits. In addition, in order to maintain good performance, fuel economy, and emissions control, we strongly recommend the use of gasoline that does NOT contain harmful manganese-based fuel additives such as MMT, if such gasoline is available.

Use of gasoline with these additives may adversely affect performance, and cause the malfunction indicator lamp on your instrument panel to come on. If this happens, contact a dealer for service. Some gasoline today is blended with oxygenates such as ethanol. Your vehicle is designed to operate on oxygenated gasoline containing up to 15% ethanol by volume. Do not use gasoline containing methanol. If you notice any undesirable operating symptoms, try another service station or switch to another brand of gasoline.

How to Refuel

Your fuel tank is not equipped with a fuel filler cap. You can insert the filler nozzle directly into the filler neck. The tank seals itself again when you pull out the filler nozzle.

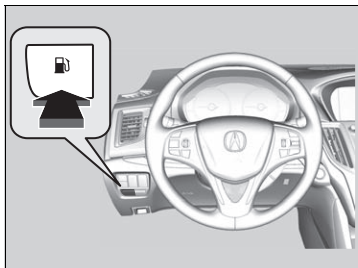

1. Stop your vehicle with the service station pump on the left side of the vehicle in the rear.
2. Turn off the engine.
3. Press the fuel fill door release button.
 - ▶ The fuel fill door opens.

How to Refuel

⚠ WARNING

Gasoline is highly flammable and explosive. You can be burned or seriously injured when handling fuel.

- Stop the engine, and keep heat, sparks, and flame away.
- Handle fuel only outdoors.
- Wipe up spills immediately.

The fuel filler opening is designed to accept only service station filler nozzles for refueling. Use of smaller diameter tubes (e.g., those used to siphon fuel for other uses) or other non-service station devices can damage the area in and around the filler opening.

The filler nozzle automatically stops to leave space in the fuel tank so that fuel does not overflow as a result of changes in air temperature.

If the filler nozzle keeps turning off when the tank is not full, there may be a problem with the pump's fuel vapor recovery system. Try filling at another pump. If this does not fix the problem, consult a dealer.

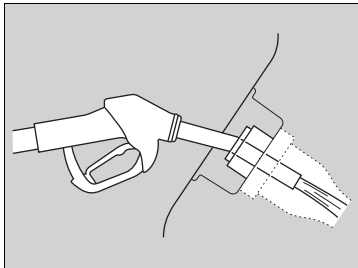

4. Place the end of the filler nozzle on the lower part of filler opening, then insert it slowly and fully.
 - ▶ Make sure that the end of the filler nozzle goes down along with the filler pipe.
 - ▶ Keep the filler nozzle level.
 - ▶ When the tank is full, the filler nozzle will click off automatically.
 - ▶ After filling, wait about five seconds before removing the filler nozzle.
5. Shut the fuel fill door by hand.

How to Refuel

Do not continue to add fuel after the filler nozzle has automatically stopped. Additional fuel can exceed the full tank capacity.

If you have to refuel your vehicle from a portable container, use the funnel provided with your vehicle.

▶ Refueling From a Portable Fuel Container

P. 563

Improving Fuel Economy and Reducing CO₂ Emissions

Achieving fuel economy and reducing CO₂ emissions is dependent on several factors, including driving conditions, load weight, idling time, driving habits, and vehicle condition. Depending on these and other factors, you may not achieve the rated fuel economy of this vehicle.

Maintenance and Fuel Economy

You can optimize your fuel economy with proper maintenance of your vehicle. Always maintain your vehicle in accordance with the messages displayed on the multi-information display.

- Use the recommended viscosity engine oil, displaying the API Certification Seal.
- Maintain the specified tire pressure.
- Do not load the vehicle with excess cargo.
- Keep your vehicle clean. A buildup of snow or mud on your vehicle's underside adds weight and increases wind resistance.

Improving Fuel Economy and Reducing CO₂ Emissions

Direct calculation is the recommended method to determine actual fuel consumed while driving.

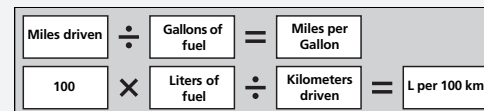

In Canada, posted fuel economy numbers are established following a simulated test. For more information on how this test is performed, please visit <http://oee.nrcan.gc.ca/>

Maintenance

This chapter discusses basic maintenance.



Before Performing Maintenance

| | |
|---|-----|
| Inspection and Maintenance | 466 |
| Safety When Performing Maintenance..... | 467 |
| Parts and Fluids Used in Maintenance | |
| Service | 468 |

Maintenance Minder™

469

Maintenance Under the Hood

| | |
|--|-----|
| Maintenance Items Under the Hood..... | 474 |
| Opening the Hood | 476 |
| Recommended Engine Oil | 477 |
| Oil Check | 478 |
| Adding Engine Oil | 480 |
| Changing the Engine Oil and Oil Filter.. | 481 |

| | |
|---|------------|
| Engine Coolant | 484 |
| Transmission Fluid | 486 |
| Brake Fluid | 487 |
| Refilling Window Washer Fluid..... | 487 |
| Replacing Light Bulbs | 488 |
| Checking and Maintaining Wiper | |
| Blades | 493 |
| Checking and Maintaining Tires | |
| Checking Tires | 495 |
| Tire and Loading Information Label..... | 496 |
| Tire Labeling | 496 |
| DOT Tire Quality Grading (U.S. Vehicles) .. | 498 |
| Wear Indicators..... | 500 |

| | |
|---|------------|
| Tire Service Life | 500 |
| Tire and Wheel Replacement | 501 |
| Tire Rotation | 502 |
| Winter Tires | 503 |
| Battery | 504 |
| Remote Transmitter Care | |
| Replacing the Button Battery | 506 |
| Climate Control System Maintenance | 508 |
| Cleaning | |
| Interior Care | 509 |
| Exterior Care..... | 511 |
| Accessories and Modifications | 514 |

Inspection and Maintenance

For your safety, perform all listed inspections and maintenance to keep your vehicle in good condition. If you become aware of any abnormality (noise, smell, insufficient brake fluid, oil residue on the ground, etc.), have your vehicle inspected by a dealer. (Note, however, that service at a dealer is not mandatory to keep your warranties in effect.) Refer to the separate maintenance booklet for detailed maintenance and inspection information.

Types of Inspection and Maintenance

■ Daily inspections

Perform inspections before long distance trips, when washing the vehicle, or when refueling.

■ Periodic inspections

- Check the brake fluid level monthly.
 - **Brake Fluid** P. 487
- Check the tire pressure monthly. Examine the tread for wear and foreign objects.
 - **Checking and Maintaining Tires** P. 495
- Check the operation of the exterior lights monthly.
 - **Replacing Light Bulbs** P. 488
- Check the condition of the wiper blades at least every six months.
 - **Checking and Maintaining Wiper Blades** P. 493

Inspection and Maintenance

U.S. models

Maintenance, replacement, or repair of emissions control devices and systems may be done by any automotive repair establishment or individuals using parts that are "certified" to EPA standards.

According to state and federal regulations, failure to perform maintenance on the maintenance main items marked with # will not void your emissions warranties. However, all maintenance services should be performed in accordance with the intervals indicated by the multi-information display (MID).

➤ **Maintenance Service Items** P. 472

If you want to perform complex maintenance tasks that require more skills and tools, you can purchase a subscription to the Service Express website at www.techinfo.honda.com.

➤ **Authorized Manuals** P. 576

If you want to perform maintenance yourself, make sure that you have the necessary tools and skills first. After performing maintenance, update the records in the separate maintenance booklet.

Safety When Performing Maintenance

Some of the most important safety precautions are given here. However, we cannot warn you of every conceivable hazard that can arise in performing maintenance. Only you can decide whether you should perform a given task.

Maintenance Safety

- To reduce the possibility of fire or explosion, keep cigarettes, sparks, and flames away from the battery and all fuel related parts.
- Never leave rags, towels, or other flammable objects under the hood.
 - ▶ Heat from the engine and exhaust can ignite them, causing a fire.
- To clean parts, use a commercially available degreaser or parts cleaner, not gasoline.
- Wear eye protection and protective clothing when working with the battery or compressed air.
- Engine exhaust contains carbon monoxide, which is poisonous and can kill you.
 - ▶ Only operate the engine if there is sufficient ventilation.

Vehicle Safety

- The vehicle must be in a stationary condition.
 - ▶ Make sure your vehicle is parked on level ground, the parking brake is set, and the engine is off.
- Be aware that hot parts can burn you.
 - ▶ Make sure to let the engine and exhaust system cool thoroughly before touching vehicle parts.
- Be aware that moving parts can injure you.
 - ▶ Do not start the engine unless instructed, and keep your hands and limbs away from moving parts.
 - ▶ Do not open the hood while the Auto Idle Stop function* is activated.

* Not available on all models

⚠ Safety When Performing Maintenance

⚠ WARNING

Improperly maintaining this vehicle or failing to correct a problem before driving can cause a crash in which you can be seriously hurt or killed.

Always follow the inspection and maintenance recommendations according to the schedules in this owner's manual.

⚠ WARNING

Failure to properly follow maintenance instructions and precautions can cause you to be seriously hurt or killed.

Always follow the procedures and precautions in this owner's manual.

Parts and Fluids Used in Maintenance Service

The use of Acura genuine parts and fluids is recommended when maintaining and servicing your vehicle. Acura genuine parts are manufactured according to the same high quality standards used in Acura vehicles.

▶▶ Parts and Fluids Used in Maintenance Service

6-cylinder models

Do not press the engine cover forcibly. This may damage the engine cover and component parts.

If the engine oil life is less than 15%, you will see the Maintenance Minder messages appear on the multi-information display every time you set the power mode to ON. The messages notify you when to change the engine oil, or when to bring your vehicle to a dealer for indicated maintenance services.

To Use Maintenance Minder™

■ Displaying the Maintenance Minder Information

Maintenance items, which should be serviced at the same time that you replace the engine oil, appear on the multi-information display.

You can view them on the engine oil life screen at any time.

1. Set the power mode to ON.
2. Roll the right selector wheel until the engine oil life appears on the multi-information display.

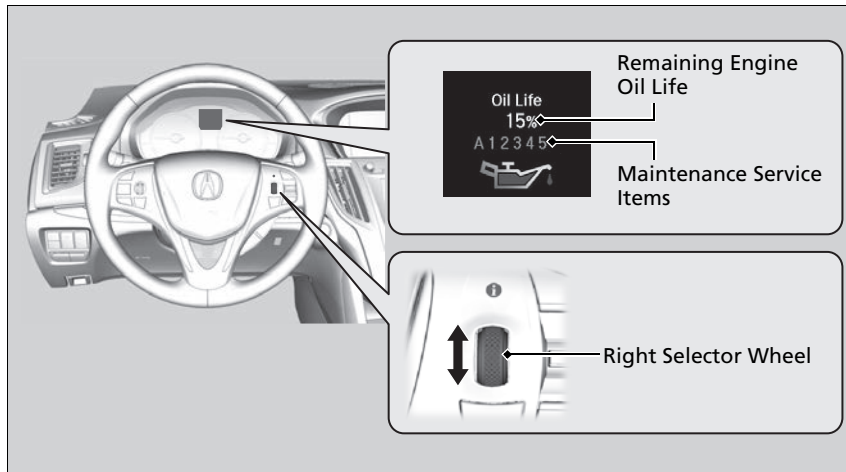

►► Displaying the Maintenance Minder Information





Based on the engine operating conditions, the remaining engine oil life is calculated and displayed as a percentage.

| Displayed Engine Oil Life (%) | Calculated Engine Oil Life (%) |
|-------------------------------|--------------------------------|
| 100 | 100 to 91 |
| 90 | 90 to 81 |
| 80 | 80 to 71 |
| 70 | 70 to 61 |
| 60 | 60 to 51 |
| 50 | 50 to 41 |
| 40 | 40 to 31 |
| 30 | 30 to 21 |
| 20 | 20 to 16 |
| 15 | 15 to 11 |
| 10 | 10 to 6 |
| 5 | 5 to 1 |
| 0 | 0 |

There is a list of maintenance main and sub items you can view on the multi-information display.

► **Maintenance Service Items** P. 472

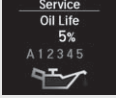
Maintenance Minder Messages on the Multi-Information Display

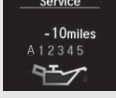
| Maintenance Message | Oil Life Display | Explanation | Information |
|--|--|--|--|
| Maintenance Due Soon  | 15 %  | The remaining engine oil life is 15 to 6 percent. Once you switch the display by rolling the right selector wheel, this message will go off. | The engine oil is approaching the end of its service life, and the maintenance items should be inspected and serviced soon. |
| Maintenance Due Now  | 5 %  | The remaining engine oil life is 5 to 1 percent. Roll the right selector wheel to switch to another display. | The engine oil has almost reached the end of its service life, and the maintenance items should be inspected and serviced as soon as possible. |
| Maintenance Past Due  | Negative Distance  | The remaining engine oil life has passed its service life, and a negative distance appears after driving over 10 miles (U.S. models) or 10 km (Canadian models). Roll the right selector wheel to switch to another display. | The engine oil life has passed. The maintenance items must be inspected and serviced immediately. |

The system message indicator (ⓘ) comes on along with the Maintenance Minder message.

Maintenance Service Items

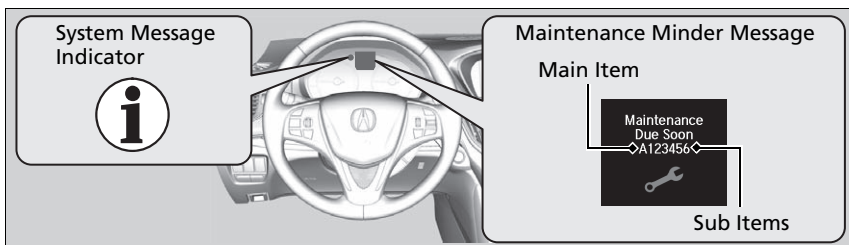

Maintenance Service Items

- Independent of the Maintenance Minder information, replace the brake fluid every 3 years.
- Adjust the valves during services A, B, 1, 2, or 3 if they are noisy.

| CODE | Maintenance Main Items |
|------|---|
| A | <ul style="list-style-type: none"> • Replace engine oil*¹ |
| B | <ul style="list-style-type: none"> • Replace engine oil*¹ and oil filter • Inspect front and rear brakes • Check expiration date for Temporary Tire Repair Kit bottle (If equipped) • Inspect tie rod ends, steering gear box, and boots • Inspect suspension components • Inspect driveshaft boots • Inspect brake hoses and lines (Including ABS/VSA) • Inspect all fluid levels and condition of fluids • Inspect exhaust system[#] • Inspect fuel lines and connections[#] |

| CODE | Maintenance Sub Items |
|------|---|
| 1 | <ul style="list-style-type: none"> • Rotate tires |
| 2 | <ul style="list-style-type: none"> • Replace air cleaner element*² • Replace dust and pollen filter*³ • Inspect drive belt |
| 3 | <ul style="list-style-type: none"> • Replace transmission and transfer* fluid*⁴ |
| 4 | <ul style="list-style-type: none"> • Replace spark plugs • Replace timing belt and inspect water pump*^{5, *6} • Inspect valve clearance |
| 5 | <ul style="list-style-type: none"> • Replace engine coolant |
| 6 | <ul style="list-style-type: none"> • Replace rear differential fluid*⁷ |

*1: If a message **Maintenance Due Now** does not appear more than 12 months after the display is reset, change the engine oil every year.

#: See information on maintenance and emissions warranty.

*2: If you drive in dusty conditions, replace the air cleaner element every 15,000 miles (24,000 km).

*3: If you drive primarily in urban areas that have high concentrations of soot in the air from industry and from diesel-powered vehicles, replace the dust and pollen filter every 15,000 miles (24,000 km).

*4: Driving in mountainous areas at very low vehicle speeds results in higher transmission temperature. This requires transmission fluid changes more frequently than recommended by the Maintenance Minder. If you regularly drive your vehicle under these conditions, have the transmission fluid changed at 40,000 miles (64,000 km), then every 30,000 miles (48,000 km).

*5: If you drive regularly in very high temperatures (over 110°F, 43°C), in very low temperatures (under -20°F, -29°C), replace every 60,000 miles/100,000 km.

*6: 6-cylinder models

*7: Driving in mountainous areas at very low vehicle speeds results in higher level of mechanical (shear) stress to fluid. This requires differential fluid changes more frequently than recommended by the Maintenance Minder. If you regularly drive your vehicle under these conditions, have the differential fluid changed at 7,500 miles (12,000 km), then every 15,000 miles (24,000 km).

■ Resetting the Display

Reset the engine oil life display if you have performed the maintenance service.

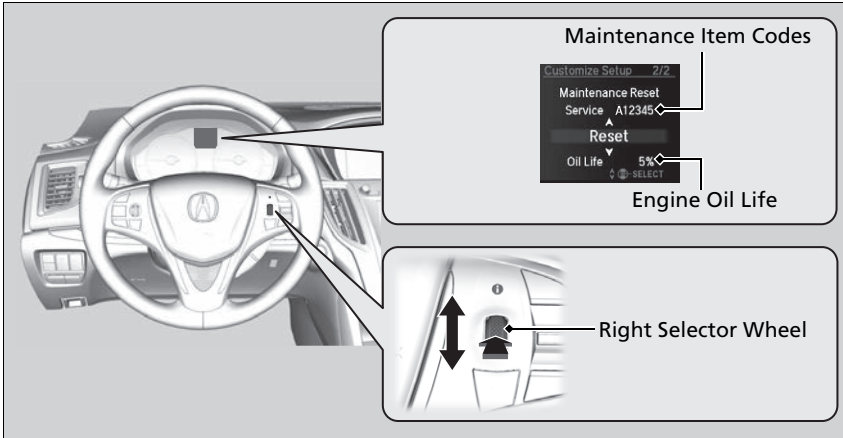

1. Set the power mode to ON.
2. Go to the **Maintenance Info.** group.
 - ▶ **Customized Features** P. 120, 292
3. Push the right selector wheel.
 - ▶ The oil life reset mode is displayed on the multi-information display.
4. Select **Reset** with the right selector wheel, then push the right selector wheel.
 - ▶ The displayed maintenance items disappear, and the engine oil life display returns to **100%**.

To cancel the oil life reset mode, select **Cancel**, then push the right selector wheel.

⌘ Resetting the Display

NOTICE

Failure to reset the engine oil life after a maintenance service results in the system showing incorrect maintenance intervals, which can lead to serious mechanical problems.

The dealer will reset the engine oil life display after completing the required maintenance service. If someone other than a dealer performs maintenance service, reset the engine oil life display yourself.

You can reset the engine oil life display using the information screen.

▶ **Customized Features** P. 292

Maintenance Items Under the Hood

4-cylinder models

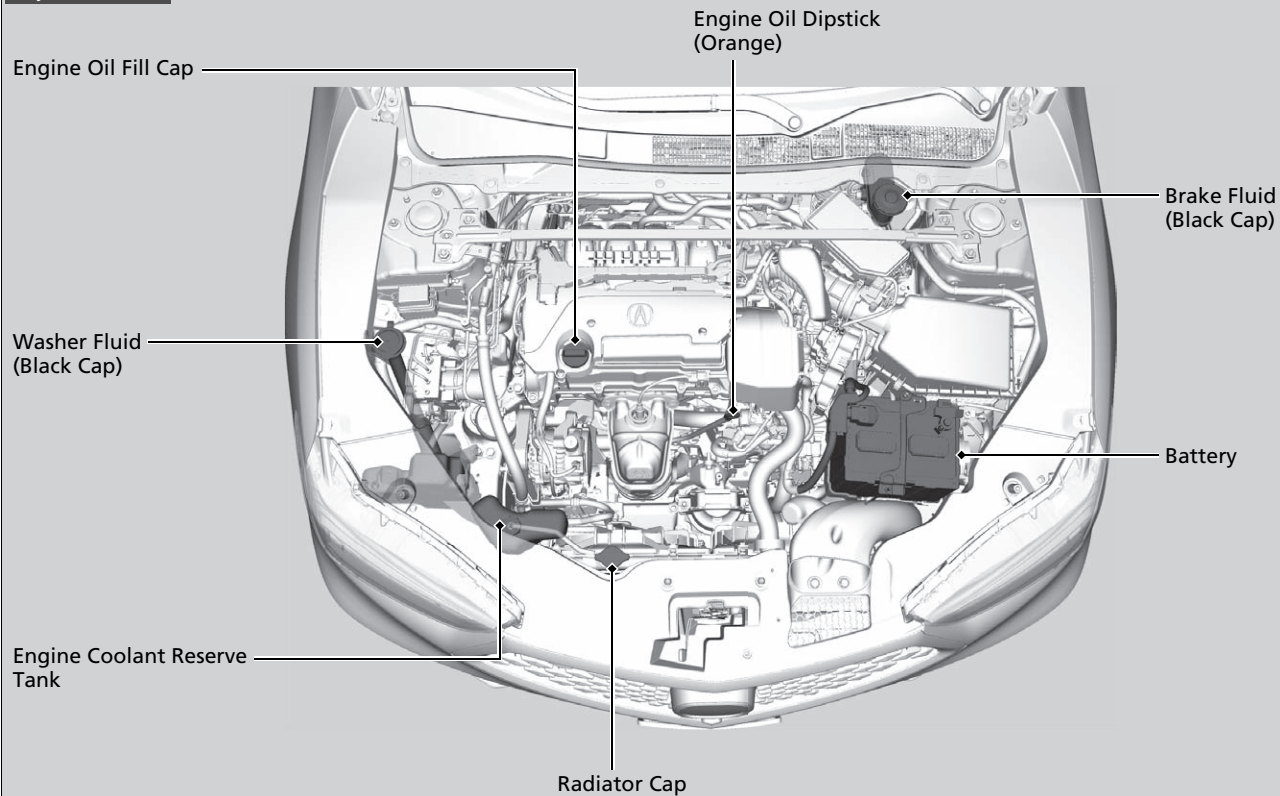

6-cylinder models

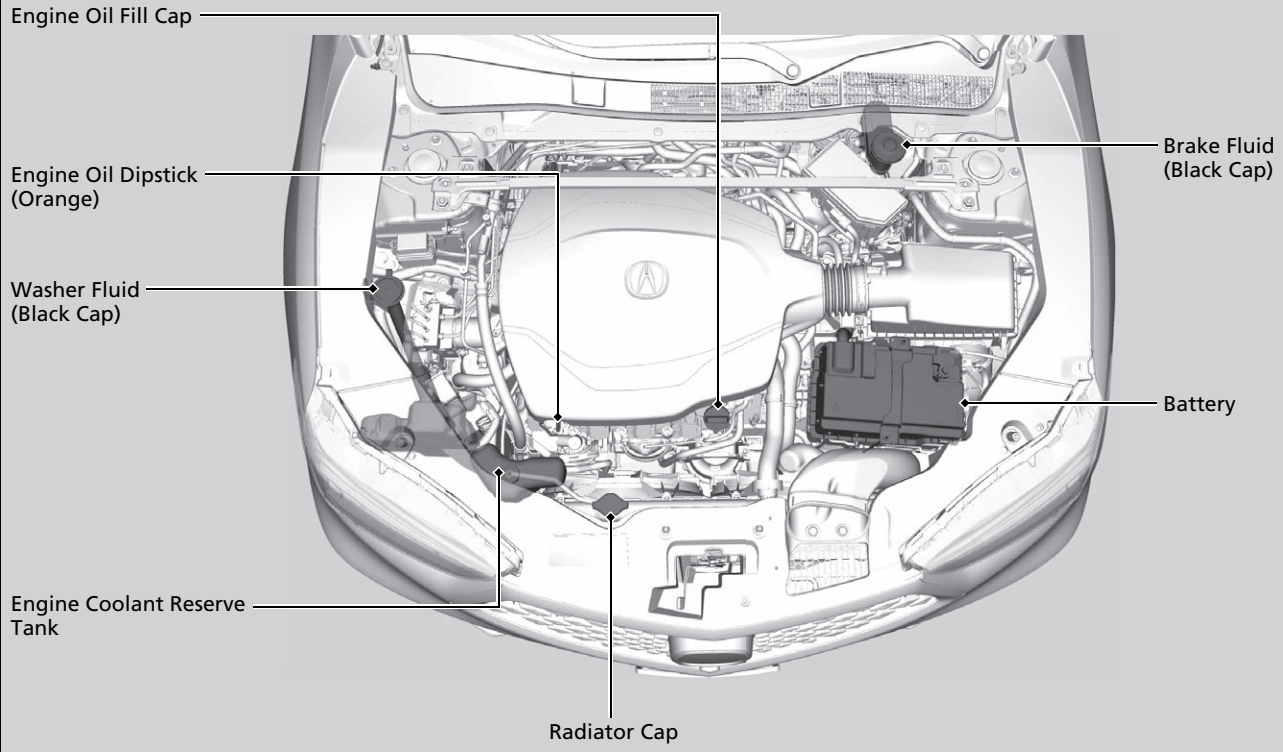

Opening the Hood

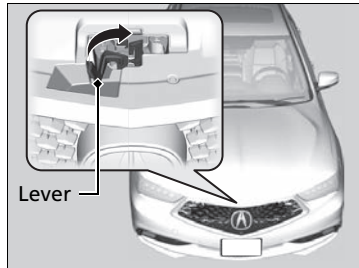
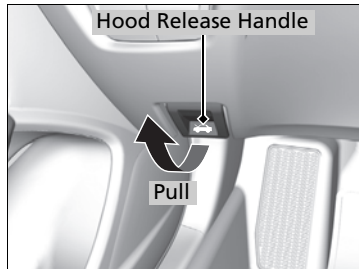

1. Park the vehicle on a level surface, and set the parking brake.
 2. Pull the hood release handle under the driver's side lower corner of the dashboard.
 - The hood will pop up slightly.
 3. Pull up the hood latch lever (located under the front edge of the hood to the center) and raise the hood. Once you have raised the hood slightly, you can release the lever.
 4. Lift the hood up most of the way.
 - The hydraulic support will lift it up the rest of the way and hold it up.

When closing, lower it to approximately 12 inches (30 cm), then press down firmly with your hands.

►► Opening the Hood

NOTICE

Do not open the hood when the wiper arms are raised: The hood will strike the wipers, resulting in possible damage to the hood and/or the wipers.

6-cylinder models

Do not press the engine cover forcibly. This may damage the engine cover and component parts.

When closing the hood, check that the hood is securely latched.

If the hood latch lever moves stiffly, or if you can open the hood without lifting the lever, the latch mechanism should be cleaned and lubricated.

Models with Auto Idle Stop

Do not open the hood while the Auto Idle Stop function is activated.

Recommended Engine Oil

- **Genuine Acura Motor Oil**
- **Premium-grade 0W-20 detergent oil with an API Certification Seal on the container.**



Oil is a major contributor to your engine's performance and longevity. If you drive the vehicle with insufficient or deteriorated oil, the engine may fail or be damaged.

This seal indicates the oil is energy conserving and that it meets the American Petroleum Institute's latest requirements.

Use a Genuine Acura Motor Oil or another commercial engine oil of suitable viscosity for the ambient temperature as shown.

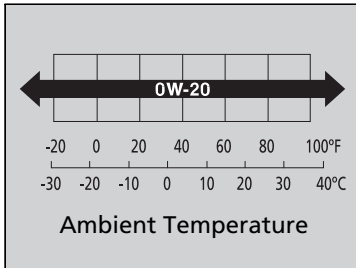

■ Synthetic oil

You may also use synthetic motor oil if it is labeled with the API Certification Seal and is the specified viscosity grade.

☒ Recommended Engine Oil

Engine Oil Additives

Your vehicle does not require oil additives. In fact, they may adversely affect the engine performance and durability.

Oil Check

We recommend that you check the engine oil level every time you refuel.

Park the vehicle on level ground.

Wait approximately three minutes after turning the engine off before you check the oil.

4-cylinder models

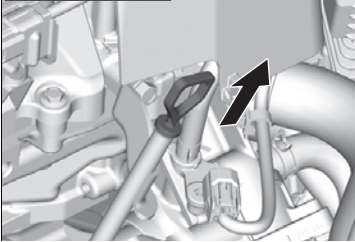

6-cylinder models

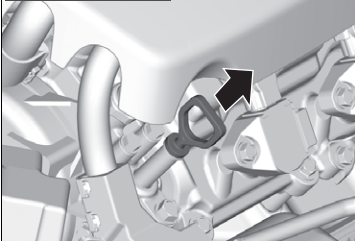

1. Remove the dipstick (orange).
2. Wipe the dipstick with a clean cloth or paper towel.
3. Insert the dipstick back all the way into its hole.

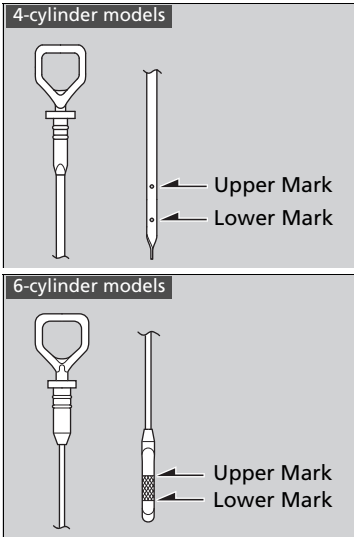

4. Remove the dipstick again, and check the level. It should be between the upper and lower marks. Add oil if necessary.

Oil Check

If the oil level is near or below the lower mark, slowly add oil, being careful not to overfill.

Adding Engine Oil

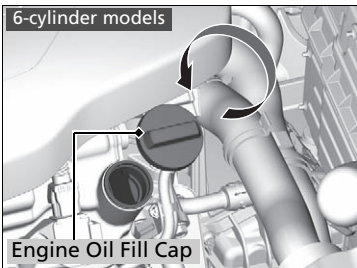
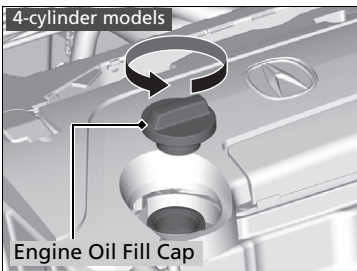

1. Unscrew and remove the engine oil fill cap.
2. Add oil slowly.
3. Reinstall the engine oil fill cap, and tighten it securely.
4. Wait for three minutes and recheck the engine oil dipstick.

►► Adding Engine Oil

NOTICE

Do not fill the engine oil above the upper mark. Overfilling the engine oil can result in leaks and engine damage.

If any oil spills, wipe it away immediately. Spilled oil may damage the engine compartment components.

Changing the Engine Oil and Oil Filter

You must change the engine oil and oil filter regularly in order to maintain the engine's lubrication. The engine may be damaged if they are not changed regularly.

Change the oil and filter in accordance with the maintenance message on the multi-information display.

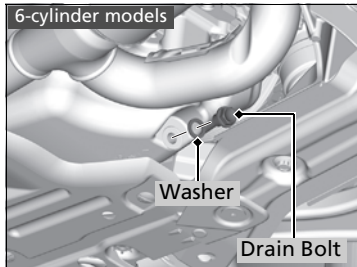
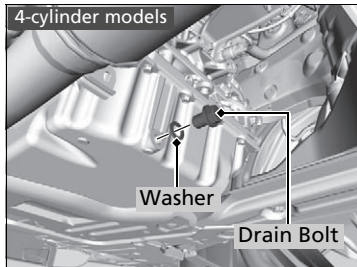

1. Run the engine until it reaches normal operating temperature, and then turn the engine off.
2. Open the hood and remove the engine oil fill cap.
3. Remove the drain bolt and washer from the bottom of the engine, and drain the oil into a suitable container.

Changing the Engine Oil and Oil Filter

NOTICE

You may damage the environment if you do not dispose of the oil in a suitable way. If you are changing the oil by yourself, appropriately dispose of the used oil. Put the oil in a sealed container and take it to a recycling center. Do not throw the oil away into a garbage can or onto the ground.

You will need a special wrench to replace the oil filter. You can buy this wrench from a dealer.

When installing the new oil filter, follow the instructions supplied with the oil filter.

Reinstall the engine oil fill cap. Start the engine. The low oil pressure indicator should go off within five seconds. If it does not, turn off the engine, and check your work.

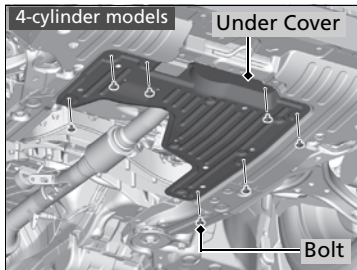

4-cylinder models

4. Remove the bolts on the undercarriage by turning to the left and remove the under cover.

All models

5. Remove the oil filter and dispose of the remaining oil.
6. Check that the filter gasket is not stuck to the engine contact surface.
 - If it is stuck, you must detach it.
7. Wipe away dirt and dust adhering to the contact surface of the engine block, and install a new oil filter.
 - Apply a light coat of new engine oil to the filter gasket.

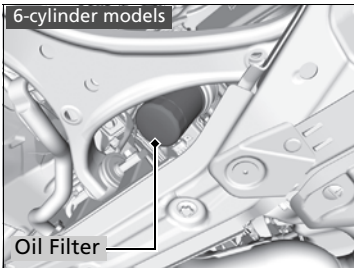
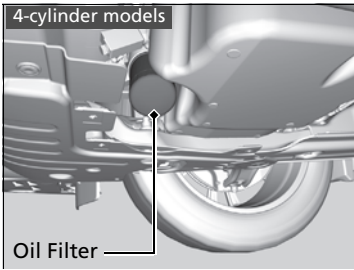

8. Put a new washer on the drain bolt, then reinstall the drain bolt.

► Tightening torque:
30 lbf·ft (40 N·m, 4.0 kgf·m)

9. Pour the recommended engine oil into the engine.

► Engine oil change capacity (including filter):

4-cylinder models

4.4 US qt (4.2 L)

6-cylinder models

4.5 US qt (4.3 L)

10. Reinstall the engine oil fill cap securely and start the engine.

11. Run the engine for a few minutes, and then check that there is no leak from the drain bolt or oil filter.

12. Stop the engine, wait for three minutes, and then check the oil level on the dipstick.

► If necessary, add more engine oil.

Engine Coolant

Specified coolant: Acura Long Life Antifreeze/Coolant Type 2

This coolant is premixed with 50% antifreeze and 50% water. Do not add any straight antifreeze or water.

We recommend you check the engine coolant level every time you refuel. Check the reserve tank first. If it is completely empty, also check the coolant level in the radiator. Add the engine coolant accordingly.

Reserve Tank

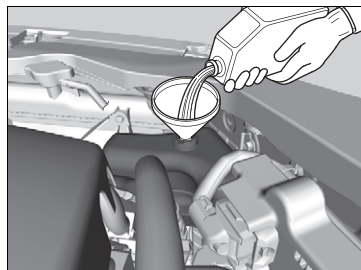
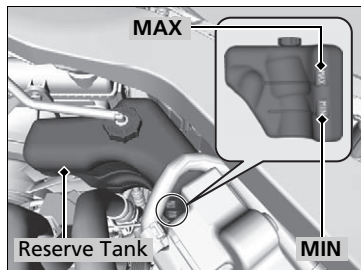

1. **Make sure the engine and radiator are cool.**
2. Check the amount of coolant in the reserve tank.
 - If the coolant level is below the **MIN** mark, add the specified coolant until it reaches the **MAX** mark.
3. Inspect the cooling system for leaks.

Engine Coolant

⚠ WARNING

Removing the radiator cap while the engine is hot can cause the coolant to spray out, seriously scalding you.

Always let the engine and radiator cool down before removing the radiator cap.

NOTICE

Genuine Acura engine coolant is a 50/50 mixture of antifreeze and water that can withstand freezing at temperatures as low as about -31°F (-35°C). If your vehicle is consistently subjected to temperatures below this, the concentration of antifreeze in the coolant should be increased. Consult a dealer for details.

If Acura antifreeze/coolant is not available, you may use another major brand of non-silicate coolant as a temporary replacement. Check that it is a high quality coolant recommended for aluminum engines. Continued use of any non-Acura coolant can result in corrosion, causing the cooling system to malfunction or fail. Have the cooling system flushed and refilled with Acura antifreeze/coolant as soon as possible.

Do not add rust inhibitors or other additives to your vehicle's cooling system. They may not be compatible with the coolant or with the engine components.

Radiator

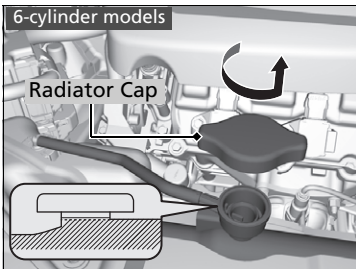
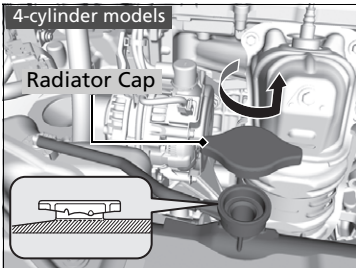

1. **Make sure the engine and radiator are cool.**
2. Turn the radiator cap 1/8 turn counter-clockwise and relieve any pressure in the coolant system.
3. Push down and turn the radiator cap counter-clockwise to remove it.
4. The coolant level should be up to the base of the filler neck. Add coolant if it is low.
5. Put the radiator cap back on, and tighten it fully.

►► Radiator

NOTICE

Pour the fluid slowly and carefully so you do not spill any. Clean up any spills immediately; they can damage components in the engine compartment.

Transmission Fluid

■ Dual Clutch Transmission Fluid*

Specified fluid: Acura Automatic Transmission Fluid ATF-TYPE 2

Have a dealer check the fluid level and replace if necessary.

Do not attempt to check or change the dual clutch transmission fluid yourself.

■ Automatic Transmission Fluid*

Specified fluid: Acura Automatic Transmission Fluid ATF-TYPE 3

Have a dealer check the fluid level and replace if necessary.

Do not attempt to check or change the automatic transmission fluid yourself.

» Dual Clutch Transmission Fluid*

NOTICE

Do not mix Acura ATF-TYPE 2 with other transmission fluids.

Using a transmission fluid other than Acura ATF-TYPE 2 may adversely affect the operation and durability of your vehicle's transmission, and damage the transmission.

Any damage caused by using a transmission fluid that is not equivalent to Acura ATF-TYPE 2 is not covered by Acura's new vehicle limited warranty.

» Automatic Transmission Fluid*

NOTICE

Do not mix Acura ATF-TYPE 3 with other transmission fluids.

Using a transmission fluid other than Acura ATF-TYPE 3 may adversely affect the operation and durability of your vehicle's transmission, and damage the transmission.

Any damage caused by using a transmission fluid that is not equivalent to Acura ATF-TYPE 3 is not covered by Acura's new vehicle limited warranty.

Brake Fluid

Specified fluid: Acura Heavy Duty Brake Fluid DOT 3

Checking the Brake Fluid

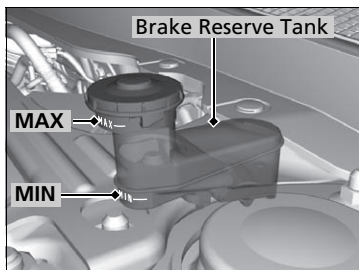

The fluid level should be between the **MIN** and **MAX** marks on the side of the reserve tank.

Refilling Window Washer Fluid

Check the amount of window washer fluid by looking at the reservoir.

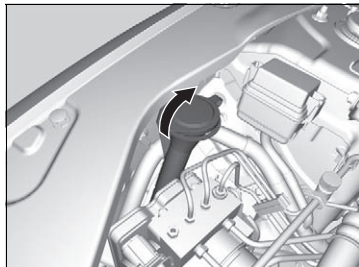

If the level is low, fill the washer reservoir.

Canadian models

If the washer fluid is low, a message appears on the multi-information display.

Pour the washer fluid carefully. Do not overflow the reservoir.

Brake Fluid

NOTICE

Brake fluid marked DOT 5 is not compatible with your vehicle's braking system and can cause extensive damage.

If the specified brake fluid is not available, you should use only DOT 3 or DOT 4 fluid from a sealed container as a temporary replacement.

Using any non-Acura brake fluid can cause corrosion and decrease the longevity of the system. Have the brake system flushed and refilled with Acura Heavy Duty Brake Fluid DOT 3 as soon as possible.

If the brake fluid level is at or below the **MIN** mark, have a dealer inspect the vehicle for leaks or worn brake pads as soon as possible.

Refilling Window Washer Fluid

NOTICE

Do not use engine antifreeze or a vinegar/water solution in the windshield washer reservoir. Antifreeze can damage your vehicle's paint. A vinegar/water solution can damage the windshield washer pump.

Use only commercially available windshield washer fluid.

Avoid prolonged use of hard water to prevent lime scale build up.

Headlights

Headlights are LED type. Have an authorized Acura dealer inspect and replace the light assembly.

Fog Lights*

Fog lights are LED type. Have an authorized Acura dealer inspect and replace the light assembly.

Front Turn Signal/Parking, Front Side Marker and Daytime Running Lights

Front turn signal/parking, front side marker and daytime running lights are LED type. Have an authorized Acura dealer inspect and replace the light assembly.

Side Turn Signal/Emergency Indicator Lights

Door mirror side turn lights are LED type. Have an authorized Acura dealer inspect and replace the light assembly.

Headlights

The headlight aim is set by the factory, and does not need to be adjusted. However, if you regularly carry heavy items in the trunk, have the aiming readjusted at a dealer or by a qualified technician.

Rear Turn Signal Light Bulbs

When replacing, use the following bulbs.

Rear Turn Signal Light: 21 W

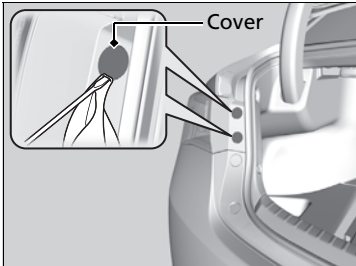

1. Pry on the edge of the cover using a flat-tip screwdriver to remove the covers.
 - ▶ Wrap the flat-tip screwdriver with a cloth to prevent scratches.

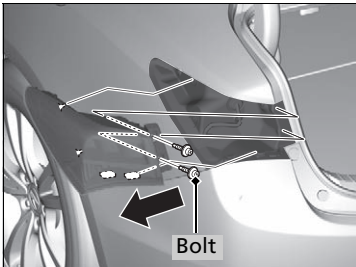

2. Remove the mounting bolts.
3. Pull the light assembly out of the rear pillar.

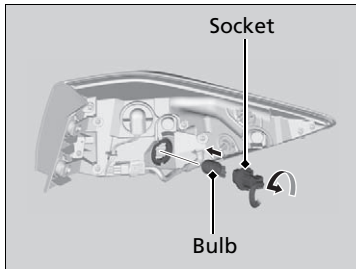

4. Turn the socket counter-clockwise and remove it. Remove the old bulb.
5. Insert a new bulb.

Brake and Taillight/Rear Side Marker Lights

Brake and taillight/rear side marker lights are LED type. Have an authorized Acura dealer inspect and replace the light assembly.

Brake Lights and Taillights

Brake lights and taillights are LED type. Have an authorized Acura dealer inspect and replace the light assembly.

Back-Up Light Bulbs

When replacing, use the following bulbs.

Back-Up Light: 21 W

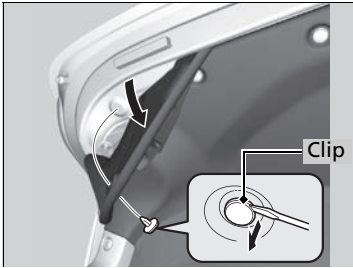

1. Remove the holding clip using a flat-tip screwdriver, then pull the lining back.

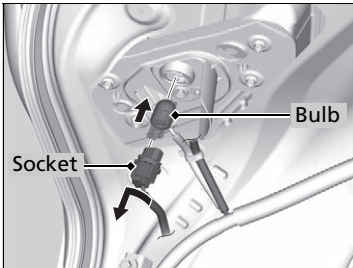

2. Turn the socket counter-clockwise and remove it, then remove the old bulb.
3. Insert a new bulb.

Rear License Plate Lights

Rear license plate lights are LED type. Have an authorized Acura dealer inspect and replace the light assembly.

High-Mount Brake Light

High-mount brake light is LED type. Have an authorized Acura dealer inspect and replace the light assembly.

Puddle Lights*

Puddle lights are LED type. Have an authorized Acura dealer inspect and replace the light assembly.

Checking Wiper Blades

If the wiper blade rubber has deteriorated, it will leave streaks and the hard surfaces of the blade may scratch the window glass.

Changing the Wiper Blade Rubber

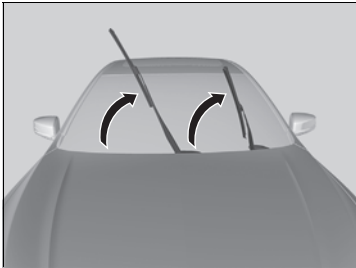

1. Lift the driver side wiper arm first, then the passenger side.

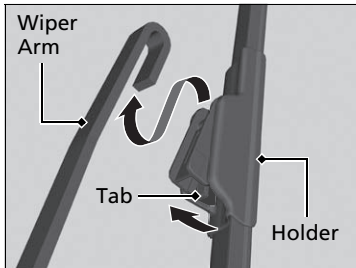

2. Press and hold the tab, then slide the holder off the wiper arm.

Changing the Wiper Blade Rubber

NOTICE

Avoid dropping the wiper arm onto the windshield, it may damage the wiper arm and/or the windshield.

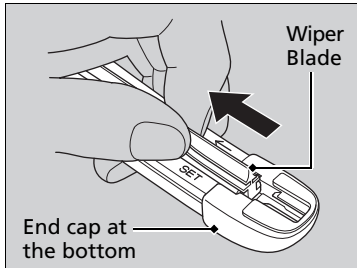

3. Pull the end of the wiper blade in the direction of the arrow in the image until it is out of the holder's end cap.

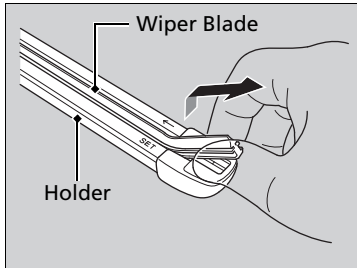

4. Pull the wiper blade in the opposite direction to slide it out of the holder.

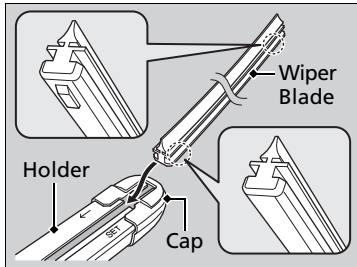

5. Insert the flat side of the new wiper blade onto the bottom part of the holder. Insert the blade all the way.
6. Install the end of the wiper blade into the cap.
7. Slide the holder onto the wiper arm until it locks.
8. Lower the passenger side wiper arm first, then the driver side.

Checking Tires

To safely operate your vehicle, your tires must be of the proper type and size, in good condition with adequate tread, and properly inflated.

■ Inflation guidelines

Properly inflated tires provide the best combination of handling, tread life, and comfort. Refer to the driver's doorjamb label or specifications page for the specified pressure.

Underinflated tires wear unevenly, adversely affect handling and fuel economy, and are more likely to fail from overheating.

Overinflated tires make your vehicle ride harshly, are more prone to road hazards, and wear unevenly.

Every day before you drive, look at each of the tires. If one looks lower than the others, check the pressure with a tire gauge.

At least once a month or before long trips, use a gauge to measure the pressure in all tires, including the spare*. Even tires in good condition can lose 1 – 2 psi (10 – 20 kPa, 0.1 – 0.2 kgf/cm²) per month.

■ Inspection guidelines

Every time you check inflation, also examine the tires and valve stems. Look for:

- Bumps or bulges on the side or in the tread. Replace the tire if you find any cuts, splits, or cracks in the side of the tire. Replace it if you see fabric or cord.
- Remove any foreign objects and inspect for air leaks.
- Uneven tread wear. Have a dealer check the wheel alignment.
- Excessive tread wear.

➤ **Wear Indicators** P. 500

- Cracks or other damage around valve stem.

* Not available on all models

ⓘ Checking Tires

⚠ WARNING

Using tires that are excessively worn or improperly inflated can cause a crash in which you can be seriously hurt or killed.

Follow all instructions in this owner's manual regarding tire inflation and maintenance.

Measure the air pressure when tires are cold. This means the vehicle has been parked for at least three hours, or driven less than 1 mile (1.6 km). If necessary, add or release air until the specified pressure is reached.

If checked when hot, tire pressure can be as much as 4 – 6 psi (30 – 40 kPa, 0.3 – 0.4 kgf/cm²) higher than if checked when cold.

➤ **Tire Fill Assist** P. 425

Have a dealer check the tires if you feel a consistent vibration while driving. New tires and any that have been removed and reinstalled should be properly balanced.

Vehicles with optional spare tire

Check the spare tire pressure once a month or before long trips.

Tire and Loading Information Label

The label attached to the driver's doorjamb provides necessary tire and loading information.

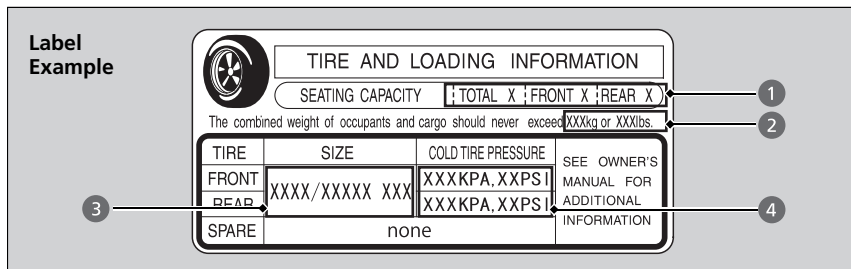

▶▶ Tire and Loading Information Label

The tire and loading information label attached to the driver's doorjamb contains:

- 1 The number of people your vehicle can carry.
- 2 The total weight your vehicle can carry. Do not exceed this weight.
- 3 The original tire sizes for front, rear, and spare, if equipped.
- 4 The proper cold tire pressure for front, rear, and spare, if equipped.

Tire Labeling

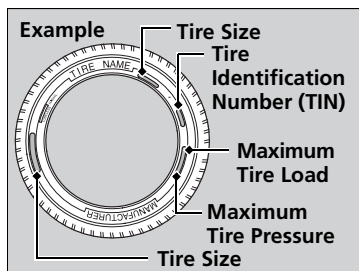

The tires that came on your vehicle have a number of markings. Those you should be aware of are described below.

▶▶ Tire Sizes

Following is an example of tire size with an explanation of what each component means.

225/50R18 95H

225: Tire width in millimeters.

50: Aspect ratio (the tire's section height as a percentage of its width).

R: Tire construction code (R indicates radial).

18: Rim diameter in inches.

95: Load index (a numerical code associated with the maximum load the tire can carry).

H: Speed symbol (an alphabetical code indicating the maximum speed rating).

Tire Sizes

Whenever tires are replaced, they should be replaced with tires of the same size.

■ Tire Identification Number (TIN)

The tire identification number (TIN) is a group of numbers and letters that look like the example in the side column. TIN is located on the sidewall of the tire.

■ Glossary of Tire Terminology

Cold Tire Pressure – The tire air pressure when the vehicle has been parked for at least three hours or driven less than 1 mile (1.6 km).

Load Rating – Means the maximum load that a tire is rated to carry for a given inflation pressure.

Maximum Inflation Pressure – The maximum tire air pressure that the tire can hold.

Maximum Load Rating – Means the load rating for a tire at the maximum permissible inflation pressure for that tire.

Recommended Inflation Pressure – The cold tire inflation pressure recommended by the manufacturer.

Treadwear Indicators (TWI) – Means the projections within the principal grooves designed to give a visual indication of the degrees of wear of the tread.

☒ Tire Identification Number (TIN)

DOT B97R FW6X 2209

DOT: This indicates that the tire meets all requirements of the U.S. Department of Transportation.

B97R: Manufacturer's identification mark.

FW6X: Tire type code.

22 09: Date of manufacture.

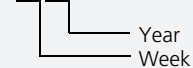

DOT Tire Quality Grading (U.S. Vehicles)

The tires on your vehicle meet all U.S. Federal Safety Requirements. All tires are also graded for treadwear, traction, and temperature performance according to Department of Transportation (DOT) standards. The following explains these gradings.

■ Uniform Tire Quality Grading

Quality grades can be found where applicable on the tire sidewall between tread shoulder and maximum section width.

■ Treadwear

The treadwear grade is a comparative rating based on the wear rate of the tire when tested under controlled conditions on a specified government test course. For example, a tire graded 150 would wear one and one-half (1 1/2) times as well on the government course as a tire graded 100. The relative performance of tires depends upon the actual conditions of their use, however, and may depart significantly from the norm due to variations in driving habits, service practices and differences in road characteristics and climate.

▣ Uniform Tire Quality Grading

For example:

Treadwear 200
Traction AA
Temperature A

All passenger car tires must conform to Federal Safety Requirements in addition to these grades.

■ Traction

The traction grades, from highest to lowest, are AA, A, B, and C. Those grades represent the tire's ability to stop on wet pavement as measured under controlled conditions on specified government test surfaces of asphalt and concrete. A tire marked C may have poor traction performance.

■ Temperature

The temperature grades are A (the highest), B, and C, representing the tire's resistance to the generation of heat and its ability to dissipate heat when tested under controlled conditions on a specified indoor laboratory test wheel. Sustained high temperature can cause the material of the tire to degenerate and reduce tire life, and excessive temperature can lead to sudden tire failure. The grade C corresponds to a level of performance which all passenger car tires must meet under the Federal Motor Vehicle Safety Standard No. 109. Grades B and A represent higher levels of performance on the laboratory test wheel than the minimum required by law.

⌘ Traction

Warning: The traction grade assigned to this tire is based on straight-ahead braking traction tests, and does not include acceleration, cornering, hydroplaning, or peak traction characteristics.

⌘ Temperature

Warning: The temperature grade for this tire is established for a tire that is properly inflated and not overloaded. Excessive speed, underinflation, or excessive loading, either separately or in combination, can cause heat buildup and possible tire failure.

Wear Indicators

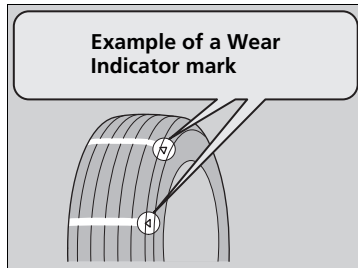

The groove where the wear indicator is located is 1/16 inch (1.6 mm) shallower than elsewhere on the tire. If the tread has worn so that the indicator is exposed, replace the tire.

Worn out tires have poor traction on wet roads.

Tire Service Life

The life of your tires is dependent on many factors, including driving habits, road conditions, vehicle loading, inflation pressure, maintenance history, speed, and environmental conditions (even when the tires are not in use).

In addition to regular inspections and inflation pressure maintenance, it is recommended that you have annual inspections performed once the tires reach five years old. All tires, including the spare*, should be removed from service after 10 years from the date of manufacture, regardless of their condition or state of wear.

Checking Tires

High speed driving

We recommend that you do not drive faster than the posted speed limits and conditions allow. If you drive at sustained high speeds (over 99 mph or 160 km/h), adjust the cold tire pressures as shown below to avoid excessive heat build up and sudden tire failure.

| | |
|-----------|---|
| Tire Size | 225/50R18 95H |
| Pressure | Front: 33 psi (230 kPa, 2.3 kgf/cm ²) |

| | |
|-----------|---|
| Tire Size | 245/40R19 94V |
| Pressure | Front: 35 psi (240 kPa, 2.4 kgf/cm ²) |

Tire and Wheel Replacement

Replace your tires with radials of the same size, load range, speed rating, and maximum cold tire pressure rating (as shown on the tire's sidewall). Using tires of a different size or construction can cause certain vehicle systems such as the ABS and Vehicle Stability Assist (VSA®) system to work incorrectly.

It is best to replace all four tires at the same time. If that isn't possible, replace the front or rear tires in pairs.

If you replace a wheel, only use TPMS specified wheels approved for your vehicle. Make sure that the wheel's specifications match those of the original wheels.

⚠ Tire and Wheel Replacement

⚠ WARNING

Installing improper tires on your vehicle can affect handling and stability. This can cause a crash in which you can be seriously hurt or killed.

Always use the size and type of tires recommended in this owner's manual.

Tire Rotation

Rotating tires according to the maintenance messages on the multi-information display helps to distribute wear more evenly and increase tire life.

■ Tires without rotation marks

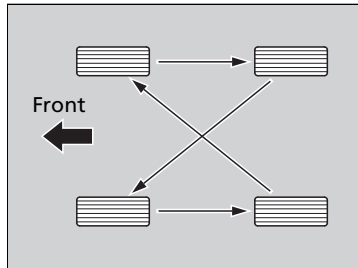

Rotate the tires as shown here.

■ Tires with rotation marks

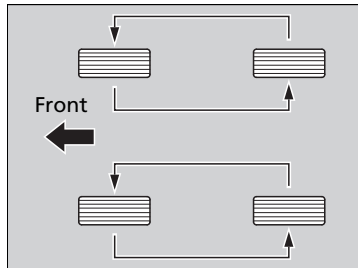

Rotate the tires as shown here.

▶▶ Tire Rotation

Tires with directional tread patterns should only be rotated front to back (not from one side to the other). Directional tires should be mounted with the rotation indication mark facing forward, as shown below.

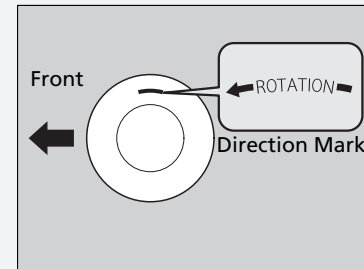

Winter Tires

If driving on snowy or frozen roads, mount all season marked **M+S** tires, snow tires, or tire chains; reduce speed; and maintain sufficient distance between vehicles when driving.

Be particularly careful when operating the steering wheel or brakes to prevent skidding.

Use tire chains, snow tires, or all season tires when necessary or according to the law.

When mounting, refer to the following points.

For winter tires:

- Select the size and load ranges that are the same as the original tires.
- Mount the tires to all four wheels.

For tire chains:

- Install them on the front tires only.
- Because your vehicle has limited tire clearance, we strongly recommend using the chains listed below:

Cable-type: QCC Premium Cobra 1042P with tensioner 0212

- Follow the chain manufacturer's instruction when installing. Mount them as tightly as you can.
- Check that the chains do not touch the brake lines or suspension.
- Drive slowly.

❧ Winter Tires

⚠ WARNING

Using the wrong chains, or not properly installing chains, can damage the brake lines and cause a crash in which you can be seriously injured or killed.

Follow all instructions in this owner's manual regarding the selection and use of tire chains.

NOTICE

Traction devices that are the wrong size or improperly installed can damage your vehicle's brake lines, suspension, body, and wheels. Stop driving if they are hitting any part of the vehicle.

When tire chains are mounted, follow the chain manufacturer's instructions regarding vehicle operational limits.

If your vehicle is equipped with summer tires, be aware that these tires are not designed for winter driving conditions. For more information, contact a dealer.

Checking the Battery

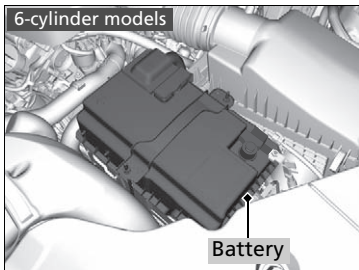
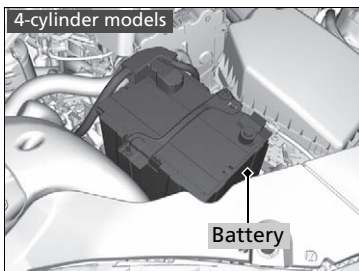

The condition of the battery is monitored by a sensor located on the negative terminal of the battery. If there is a problem with this sensor, the multi-information display will display a warning message. If this happens, have your vehicle inspected by a dealer.

Check the battery terminals for corrosion monthly.

If your vehicle's battery is disconnected or goes dead:

- The audio system is disabled.
 - **Reactivating the audio system** P. 216
- The clock resets.
 - **Clock** P. 132
- The navigation system* is disabled.
 - **Refer to the Navigation System Manual**

ⓘ Battery

⚠ WARNING

The battery gives off explosive hydrogen gas during normal operation.

A spark or flame can cause the battery to explode with enough force to kill or seriously hurt you.

When conducting any battery maintenance, wear protective clothing and a face shield, or have a skilled technician do it.

WARNING: Battery post, terminals, and related accessories contain lead and lead compounds.

Wash your hands after handling.

When you find corrosion, clean the battery terminals by applying a baking powder and water solution. Clean the terminals with a damp towel. Cloth/towel dry the battery. Coat the terminals with grease to help prevent future corrosion.

When replacing the battery, the replacement must be of the same specifications.

Consult a dealer for more information.

Charging the Battery*

Disconnect both battery cables to prevent damaging your vehicle's electrical system. Always disconnect the negative (-) cable first, and reconnect it last.

Charging the AGM Battery*

AGM labeled batteries like those installed in your vehicle require a compatible charger to be properly charged. Damage to the battery can result if the battery is charged improperly or with the wrong equipment. For more information on how to charge your vehicle's AGM battery, consult a dealer.

▶▶ Battery

Models with Auto Idle Stop

The battery installed in this vehicle is specifically designed for a model with Auto Idle Stop. Using a battery other than this specified type may shorten the battery life, and prevent Auto Idle Stop from activating. If you need to replace the battery, make sure to select the specified type. Ask a dealer for more details.

* Not available on all models

Replacing the Button Battery

Models without remote control engine start system

If the indicator does not come on when the button is pressed, replace the battery.

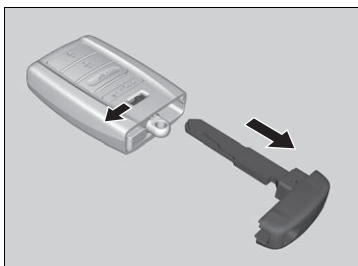

Battery type: CR2032

1. Remove the built-in key.
2. Remove the upper half of the cover by carefully prying on the edge with a coin.
 - ▶ Remove carefully to avoid losing the buttons.
 - ▶ Wrap a coin with a cloth to prevent scratching the keyless access remote.
3. Make sure to replace the battery with the correct polarity.

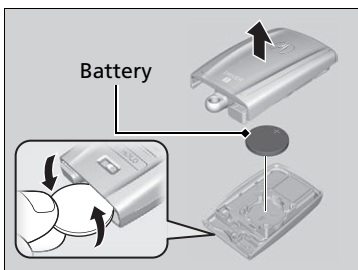

Replacing the Button Battery

NOTICE

An improperly disposed of battery can damage the environment. Always confirm local regulations for battery disposal.

Replacement batteries are commercially available or at a dealer.

Models with remote control engine start system

If the indicator does not come on when the button is pressed, replace the battery.

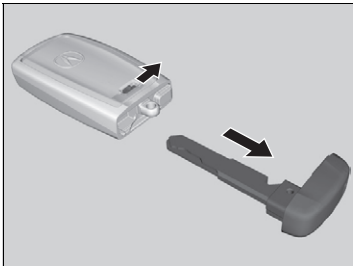

Battery type: CR2032

1. Remove the built-in key.
 - ▶ As a convenience, lightly place masking tape over the remote buttons to hold them in place.
2. Remove the upper half by carefully prying on the edge with a coin.
 - ▶ Wrap a coin with a cloth to prevent scratching the transmitter.
3. Press down on the center of the assembly and remove the battery.
 - ▶ When removing the button battery, be careful not to touch parts around it.
4. Make sure to replace the battery with the correct polarity.

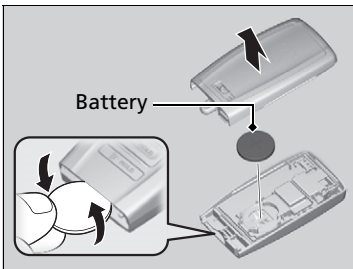

▶▶ Replacing the Button Battery

Models with remote control engine start system

NOTICE

The Remote transmitter is equipped with two batteries: A standard replaceable CR2032 coin button battery and an integral non-replaceable rechargeable battery. To prevent permanent damage to the rechargeable battery, replace the CR2032 battery every three to four years.

Dust and Pollen Filter

The climate control system is equipped with a dust and pollen filter that collects pollen, dust, and other debris in the air. The Maintenance Minder™ messages will let you know when to replace the filter.

We recommend that you replace the dust and pollen filter sooner when using your vehicle in areas with high concentrations of dust.

» Dust and Pollen Filter

If the airflow from the climate control system deteriorates noticeably, and the windows fog up easily, the filter may need to be replaced. Please contact a dealer for replacement.

Interior Care

Use a damp cloth with a mixture of mild detergent and warm water to remove dirt. Use a clean cloth to remove detergent residue.

Cleaning Seat Belts

Use a soft brush with a mixture of mild soap and warm water to clean the seat belts. Let the belts air dry. Wipe the openings of the seat belt anchors using a clean cloth.

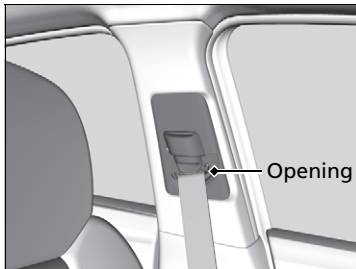

Interior Care

Do not spill liquids inside the vehicle. Electrical devices and systems may malfunction if liquids are splashed on them.

Do not use silicone based sprays on electrical devices such as audio devices and switches. Doing so may cause the items to malfunction or cause a fire inside the vehicle.

If a silicone based spray is inadvertently used on electrical devices, consult a dealer.

Depending on their composition, chemicals and liquid aromatics may cause discoloration, wrinkles, and cracking to resin-based parts and textiles. Do not use alkali solvents or organic solvents such as benzene or gasoline.

After using chemicals, make sure to gently wipe them away using a dry cloth.

Do not place used cloths on top of resin based parts or textiles for long periods of time without washing.

■ Cleaning the Window

Wipe using a glass cleaner.

▣ Cleaning the Window

Wires are mounted to the inside of the rear window. Wipe along the same direction as the wires with a soft cloth so as not to damage them.

Be careful not to spill fluids, such as water or glass cleaner, on or around the cover of both the front sensor camera and the rainfall/light sensor*.

➤ **Automatic Operation (automatic lighting control)** P. 162

➤ **Automatic Intermittent Wipers*** P. 169

➤ **Front Sensor Camera** P. 389

▣ Floor Mats

If you use any floor mats that were not originally provided with your vehicle, make sure they are designed for your specific vehicle, fit correctly, and are securely anchored by the floor anchors. Position the rear seat floor mat properly. If they are not properly positioned, the floor mat can interfere with the front seat functions.

■ Floor Mats

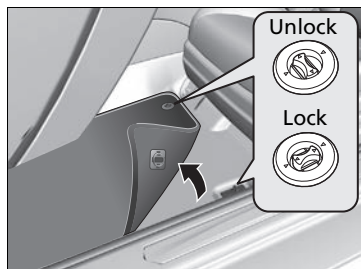

The front and rear floor mats hook over floor anchors, which keep them from sliding forward. To remove a mat for cleaning, turn the anchor knobs to the unlock position. When reinstalling the mat after cleaning, turn the knobs to the lock position.

Do not put additional floor mats on top of the anchored mats.

▣ Maintaining Genuine Leather

It is important to clean or wipe away dirt or dust as soon as possible. Spills can soak into leather resulting in stains. Dirt or dust can cause abrasions in the leather. In addition, please note that some dark colored clothing can rub onto the leather seats resulting in discoloration or stains.

■ Maintaining Genuine Leather

To properly clean leather:

1. Use a vacuum or soft dry cloth first to remove any dirt or dust.
2. Clean the leather with a soft cloth dampened with a solution comprised of 90% water and 10% neutral soap.
3. Wipe away any soap residue with a clean damp cloth.
4. Wipe away residual water and allow leather to air dry in the shade.

* Not available on all models

Exterior Care

Dust off the vehicle body after you drive. Regularly inspect your vehicle for scratches on painted surfaces. A scratch on a painted surface can result in body rust. If you find a scratch, promptly repair it.

Washing the Vehicle

Wash the vehicle regularly. Wash more frequently when driving in the following conditions:

- If driving on roads with road salt.
- If driving in coastal areas.
- If tar, soot, bird droppings, insects, or tree sap are stuck to painted surfaces.

Using an Automated Car Wash

- Make sure to follow the instructions indicated on the automated car wash.
- Fold in the door mirrors.
- Automatic intermittent wiper equipment vehicles, wipers switch to OFF.

Using High Pressure Cleaners

- Keep sufficient distance between the cleaning nozzle and the vehicle body.
- Take particular care around the windows. Standing too close may cause water to enter the vehicle interior.
- Do not spray high pressure water directly into the engine compartment. Instead, use low pressure water and a mild detergent.

Washing the Vehicle

Do not spray water into the air intake vents. It can cause a malfunction.

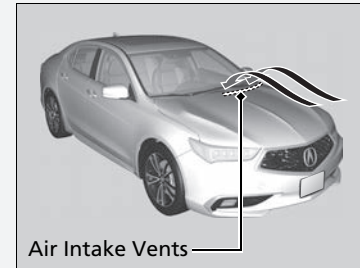

Do not spray water onto the capless unit when the fuel fill door is open. It can cause damage to the fuel system or engine.

Using an Automated Car Wash

Models with electronic gear selector

When using an automated car wash that pulls the vehicle through with a conveyor, make sure vehicle is in car wash mode.

➤ **If you want to keep the transmission in **N** position [car wash mode] P. 374**

■ Applying Wax

A good coat of automotive body wax helps protect your vehicle's paint from the elements. Wax will wear off over time and expose your vehicle's paint to the elements, so reapply as necessary.

■ Maintaining the Bumpers and Other Resin Coated Parts

If you get gasoline, oil, engine coolant, or battery fluid on resin coated parts, they may be stained or the coating may peel. Promptly wipe it away using a soft cloth and clean water.

■ Cleaning the Window

Wipe using a glass cleaner.

■ Maintaining Aluminum Wheels

Aluminum is susceptible to deterioration caused by salt and other road contaminants. When necessary, as early as possible use a sponge and mild detergent to wipe away these contaminants. Do not use a stiff brush or harsh chemicals (including some commercial wheel cleaners). These can damage the protective finish on aluminum alloy wheels, resulting in corrosion. Depending on the type of finish, the wheels also may lose their luster or appear burnished. To avoid water stains, wipe the wheels dry with a cloth while they are still wet.

▶▶ Applying Wax

NOTICE

Chemical solvents and strong cleaners can damage the paint, metal, and plastic on your vehicle. Wipe away spills immediately.

▶▶ Maintaining the Bumpers and Other Resin Coated Parts

Ask a dealer about the correct coating material when you want to repair the painted surface of the parts made of resin.

■ Fogged Exterior Light Lenses

The inside lenses of exterior lights (headlights, brake lights, etc.) may fog temporarily if you have driven in the rain, or after the vehicle has been run through a car wash. Dew condensation also may build up inside the lenses when there is a significant enough difference between the ambient and inside lens temperatures (similar to vehicle windows fogging up in rainy conditions). These conditions are natural processes, not structural design problems in the exterior lights.

Lens design characteristics may result in moisture developing on the light lens frame surfaces. This also is not a malfunction.

However, if you see large amounts of water accumulation, or large water drops building up inside the lenses, have your vehicle inspected by a dealer.

Accessories

When installing accessories, check the following:

- Do not install accessories on the windshield. They can obstruct your view and delay your reaction to driving conditions.
- Do not install any accessories over areas marked SRS Airbag, on the sides or backs of the front seats, on front or side pillars, or near the side windows. Accessories installed in these areas may interfere with proper operation of the vehicle's airbags or may be propelled into you or another occupant if the airbags deploy.
- Be sure electronic accessories do not overload electrical circuits or interfere with proper operation of your vehicle.
 - **Fuses** P. 555
- Before installing any electronic accessory, have the installer contact a dealer for assistance. If possible, have a dealer inspect the final installation.

Accessories and Modifications

WARNING

Improper accessories or modifications can affect your vehicle's handling, stability, and performance, and cause a crash in which you can be seriously hurt or killed.

Follow all instructions in this owner's manual regarding accessories and modifications.

Acura Genuine accessories are recommended to ensure proper operation on your vehicle.

Modifications

Do not modify your vehicle in a manner that may affect its handling, stability, or reliability, or install non-genuine Acura parts or accessories that may have a similar effect.

Even minor modifications to vehicle systems can affect overall vehicle performance. Always make sure all equipment is properly installed and maintained, and do not make any modification to your vehicle or its systems that might cause your vehicle to no longer meet federal, state, province, territory, and local regulations.

The on-board diagnostic port (OBD-II/J2534 connector) installed on this vehicle is intended to be used only with automobile system diagnostic devices. Use of any other type of device may adversely affect the vehicle's electronic systems or allow them to be compromised, and could result in a system malfunction, drained battery, or other unexpected problems.

Do not modify or attempt to repair any of the electrical components.

Handling the Unexpected

This chapter explains how to handle unexpected troubles.

Tools

Types of Tools..... 518

If a Tire Goes Flat

Temporarily Repairing a Flat Tire..... 519

Changing a Flat Tire..... 532

Engine Does Not Start

Checking the Engine..... 539

If the Keyless Access Remote Battery is

Weak 540

Emergency Engine Stop 541

Jump Starting 542

Shift Lever Does Not Move 546

Overheating

How to Handle Overheating..... 547

Indicator, Coming On/Blinking

If the Low Oil Pressure Indicator Comes On.. 549

If the Charging System Indicator Comes

On 549

If the Malfunction Indicator Lamp Comes

On or Blinks 550

If the Brake System Indicator (Red) Comes On.. 550

If the Electric Power Steering (EPS) System

Indicator Comes On 551

If the Electric Parking Brake System

Indicator Comes On 552

If the Low Tire Pressure/TPMS Indicator

Comes On or Blinks 553

If the Transmission System Indicator Blinks

along with the Warning Message 554

Fuses

Fuse Locations 555

Inspecting and Changing Fuses..... 559

Emergency Towing..... 560

When You Cannot Unlock the Fuel Fill

Door..... 561

When You Cannot Open the Trunk 562

Refueling

Refueling From a Portable Fuel Container ... 563

Types of Tools

Types of Tools

The tools are stored in the trunk.

Vehicles with temporary tire repair kit

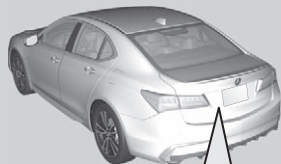

Models with plastic storage bin

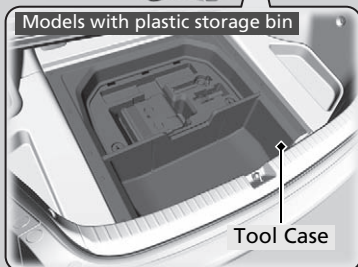

Tool Case



Towing Hook



Funnel

Vehicles with optional spare tire

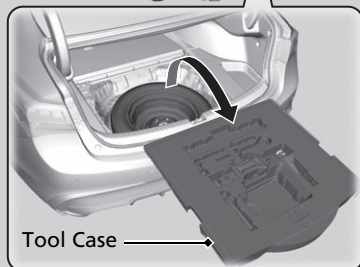
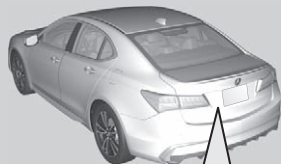

Tool Case



Wheel Nut Wrench/
Jack Handle



Funnel

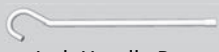

Jack Handle Bar



Towing Hook



Jack

Temporarily Repairing a Flat Tire

If the tire has a large cut or is otherwise severely damaged, you will need to have the vehicle towed. If the tire only has a small puncture, from a nail for instance, you can use the temporary tire repair kit so that you can drive to the nearest service station for a more permanent repair.

If a tire goes flat while driving, grasp the steering wheel firmly, and brake gradually to reduce speed. Then stop in a safe place.

1. Park the vehicle on a firm, level, and non-slippery surface, and apply the parking brake.
2. Change the gear position to **P**.
3. Turn on the hazard warning lights and set the power mode to VEHICLE OFF (LOCK).

Temporarily Repairing a Flat Tire

The kit should not be used in the following situations (Instead, contact a dealer or roadside assistance to have the vehicle towed):

- The tire sealant has expired.
- More than one tire is punctured.
- The puncture or cut is larger than 3/16 inch (4 mm).
- The tire side wall is damaged or the puncture is outside the contact area.



| When the puncture is: | Use Kit |
|-------------------------------|---------|
| Smaller than 3/16 inch (4 mm) | Yes |
| Larger than 3/16 inch (4 mm) | No |

- Damage has been caused by driving with the tire extremely under inflated.
- The tire bead is no longer seated.
- The rim is damaged.

Do not remove a nail or screw that punctured the tire. If you remove it from the tire, you may not be able to repair the puncture using the kit.

NOTICE

Do not use a puncture-repairing agent other than the one provided in the kit that came with your vehicle. If a different agent is used, you may permanently damage the tire pressure sensor.

■ Getting Ready to Temporarily Repair the Flat Tire

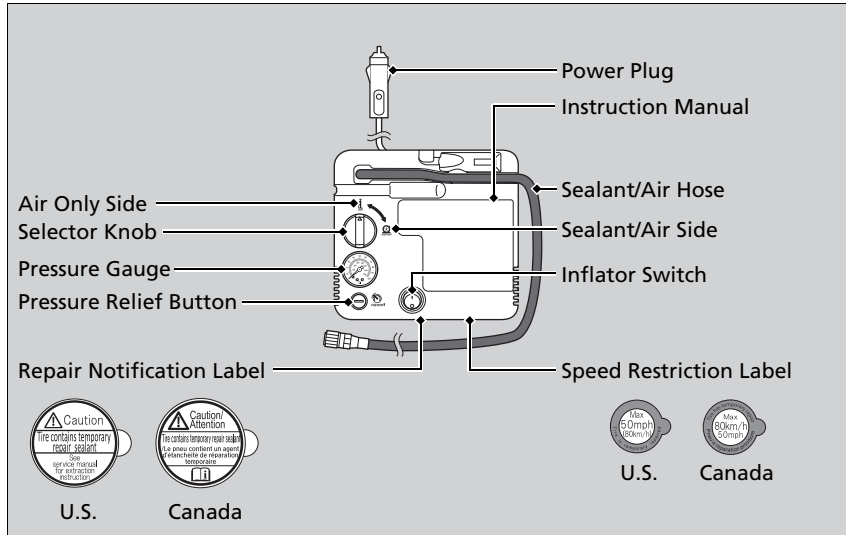

▶▶ Getting Ready to Temporarily Repair the Flat Tire

Repair notification label and speed restriction label are applied to the side of temporary tire repair kit.

When making a temporary repair, carefully read the instruction manual provided with the kit.

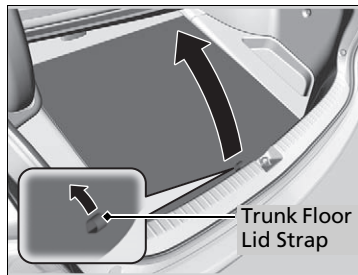

1. Pull up on the trunk floor lid strap until it is completely open.

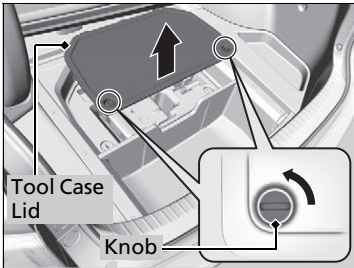

2. Turn the knob counterclockwise and remove the tool case lid.

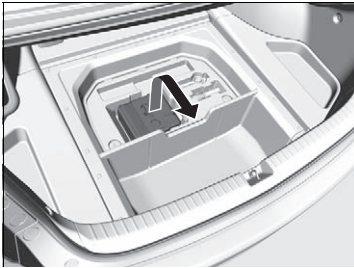

3. Remove the kit.
4. Place the kit face up, on flat ground near the flat tire, and away from traffic. Do not place the kit on its side.

■ Injecting Sealant and Air

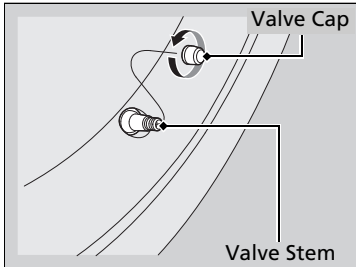

1. Remove the valve cap from the tire valve stem.

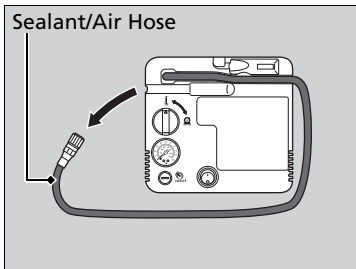

2. Remove the sealant/air hose from the packaging.

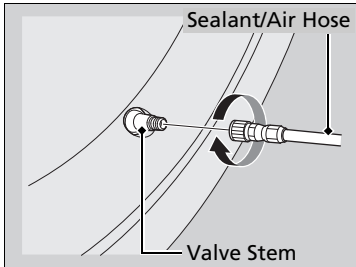

3. Attach the sealant/air hose onto the tire valve stem. Screw it until it is tight.

▶▶ Injecting Sealant and Air

⚠ WARNING

Tire sealant contains substances that are harmful and can be fatal if swallowed.

If accidentally swallowed, do not induce vomiting. Drink plenty of water and get medical attention immediately.

For skin or eye contact, flush with cool water and get medical attention if necessary.

In cold temperatures, the sealant may not flow easily. In this situation, warm it up for five minutes before using.

The sealant can permanently stain clothing and other materials. Be careful during handling and wipe away any spills immediately.

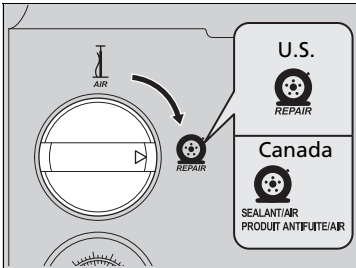
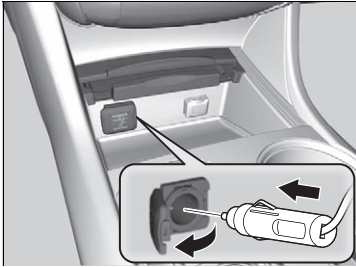

4. Plug in the compressor to the accessory power socket.

- ▶ Be careful not to pinch the cord in a door or window.
- ▶ Do not plug any other electronic devices into other accessory power sockets.

➤ **Accessory Power Sockets** P. 195

5. Start the engine.

- ▶ Keep the engine running while injecting sealant and air.

➤ **Carbon Monoxide Gas** P. 69

6. Turn the selector knob to **REPAIR**^{*1}, **SEALANT/AIR**^{*2}, **PRODUIT ANTIFUITE/AIR**^{*2}.

⊠ Injecting Sealant and Air

⚠ WARNING

Running the engine with the vehicle in an enclosed or even partly enclosed area can cause a rapid build-up of toxic carbon monoxide.

Breathing this colorless, odorless gas can cause unconsciousness and even death. Only run the engine to power the air compressor with the vehicle outdoors.

NOTICE

Do not operate the temporary tire repair kit compressor for more than 15 minutes. The compressor can overheat and become permanently damaged.

There are two accessory power sockets:

- In the console compartment
- In the front of the center pocket

➤ **Accessory Power Sockets** P. 195

Until the sealant injection is complete, the pressure shown on the pressure gauge will appear higher than actual. After the sealant injection is complete the pressure will drop and then begin to rise again as the tire is inflated with air. This is normal. To accurately measure the air pressure using the gauge, turn the air compressor off only after the sealant injection is complete.

*1: U.S. models

*2: Canadian models

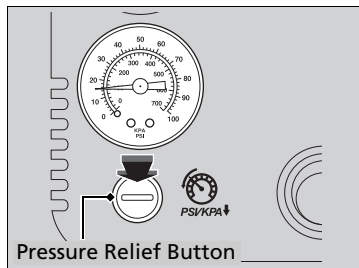
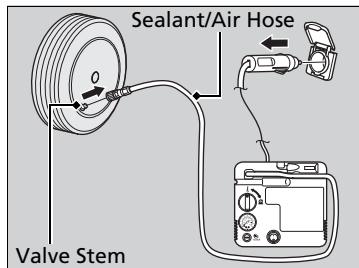
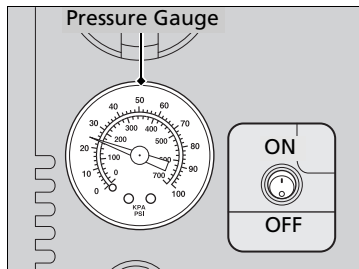

7. Press the inflator switch to turn on the compressor.
 - ▶ The compressor starts injecting sealant and air into the tire.
 - ▶ When the sealant injection is complete, continue to add air.
8. After the air pressure reaches 32 psi (220 kPa), turn off the kit.
 - ▶ To check the pressure, occasionally turn off the compressor and read the gauge.
9. Unplug the power plug from the accessory power socket.
10. Unscrew the sealant/air hose from the tire valve stem. Reinstall the valve cap.

11. Press the pressure relief button until the gauge returns to 0 psi (0 kPa).

▶▶ Injecting Sealant and Air

If the required air pressure is not reached within 10 minutes, the tire may be too severely damaged for the kit to provide the necessary seal, and your vehicle will need to be towed.

See an Acura dealer for a replacement sealant bottle and proper disposal of an empty bottle.

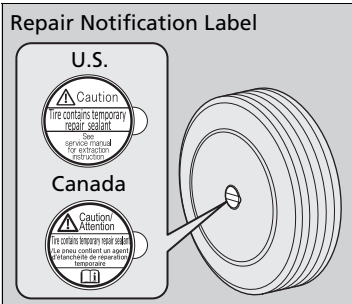

12. Apply the repair notification label to the flat surface of the wheel.
 - The wheel surface must be clean to ensure the label adheres properly.

■ Distributing the Sealant in the Tire

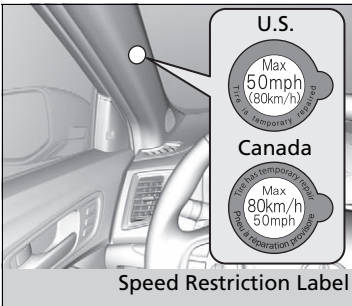

1. Apply the speed restriction label to the location as shown.
2. Drive the vehicle for about 10 minutes.
 - Do not exceed 50 mph (80 km/h).
3. Stop the vehicle in a safe place.

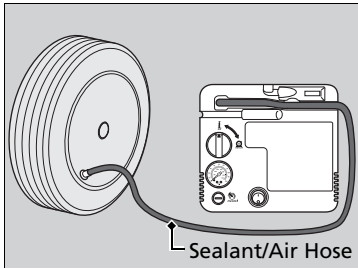

4. Recheck the air pressure using the sealant/air hose on the compressor.

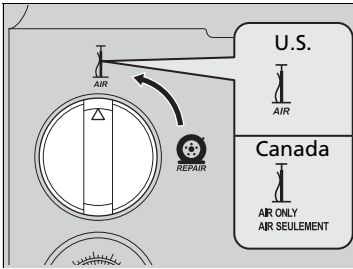

5. Turn the selector knob to **AIR***¹, **AIR ONLY***², **AIR SEULEMENT***².

▶ Do not turn the air compressor on to check the pressure.

➤ **Inflating an Under-inflated Tire** P. 529

6. If the air pressure is

- Less than 25 psi (175 kPa):

Do not add air or continue driving. The leak is too severe. Call for help and have your vehicle towed.

➤ **Emergency Towing** P. 560

- 32 psi (220 kPa) or more:

Continue driving for another 10 minutes or until you reach the nearest service station, whichever is sooner. Do not exceed 50 mph (80 km/h). If you have not reached a service station, stop and check the tire pressure.

▶ If the air pressure does not go down after 10 minutes of driving, you do not need to check the tire pressure again.

*1: U.S. models

*2: Canadian models

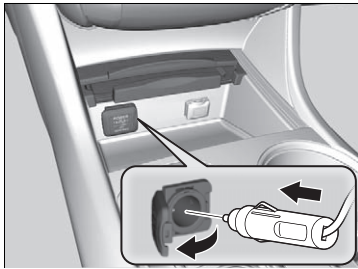

- Greater than 25 psi (175 kPa), but less than 32 psi (220 kPa):

Turn the air compressor on to inflate the tire until the tire pressure reaches 32 psi (220 kPa).

▶ **Inflating an Under-inflated Tire** P. 529

Then drive carefully for 10 more minutes or until you reach the nearest service station, whichever is sooner. Do not exceed 50 mph (80 km/h). If you have not reached a service station, stop and check the tire pressure.

▶ You should repeat this procedure as long as the air pressure is within this range.

7. Unscrew the sealant/air hose from the tire valve stem. Reinstall the valve cap.
8. Press the pressure relief button until the gauge returns to 0 psi (0 kPa).
9. Repackage and properly stow the kit.

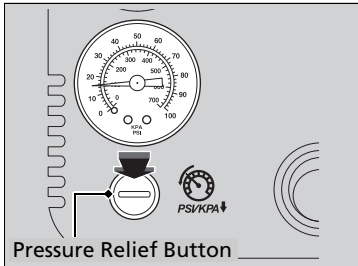

▶▶ Distributing the Sealant in the Tire

WARNING

Running the engine with the vehicle in an enclosed or even partly enclosed area can cause a rapid build-up of toxic carbon monoxide.

Breathing this colorless, odorless gas can cause unconsciousness and even death. Only run the engine to power the air compressor with the vehicle outdoors.

■ Inflating an Under-inflated Tire

You can use the kit to inflate a non-punctured, under-inflated tire.

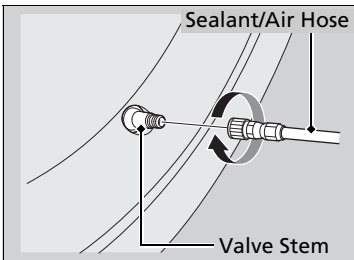
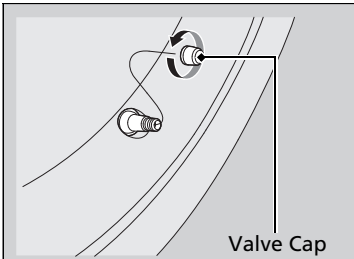
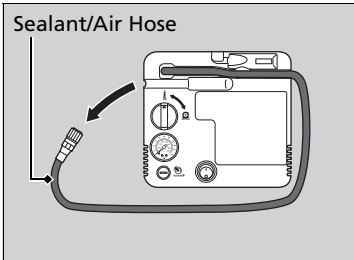

1. Open the trunk floor lid.
 - **Getting Ready to Temporarily Repair the Flat Tire** P. 520
2. Remove the kit from the case.
3. Place the kit, face up, on flat ground near the flat tire, away from traffic. Do not place the kit on its side.
4. Remove the sealant/air hose from the kit.
5. Remove the valve cap.

6. Attach the sealant/air hose onto the tire valve stem. Screw it until it is tight.

▣ Inflating an Under-inflated Tire

NOTICE

Do not operate the temporary tire repair kit compressor for more than 15 minutes. The compressor can overheat and become permanently damaged.

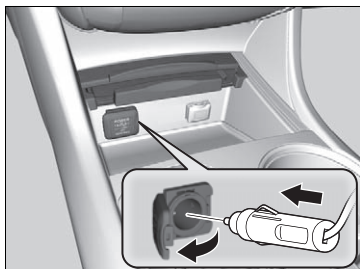

7. Plug in the kit to the accessory power socket.

- ▶ Be careful not to pinch the cord in a door or window.
- ▶ Do not plug any other electronic devices into other accessory power sockets.

🔧 **Accessory Power Sockets** P. 195

8. Start the engine.

- ▶ Keep the engine running while injecting air.

🔧 **Carbon Monoxide Gas** P. 69

9. Turn the selector knob to **AIR***1, **AIR ONLY***2, **AIR SEULEMENT***2.

10. Press the inflator switch to turn on the kit.

- ▶ The compressor starts to inject air into the tire.

11. Inflate the tire to the specified air pressure.

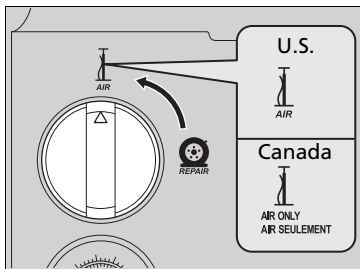

🔧 **Inflating an Under-inflated Tire**

⚠️ WARNING

Running the engine with the vehicle in an enclosed or even partly enclosed area can cause a rapid build-up of toxic carbon monoxide.

Breathing this colorless, odorless gas can cause unconsciousness and even death. Only run the engine to power the air compressor with the vehicle outdoors.

*1: U.S. models

*2: Canadian models

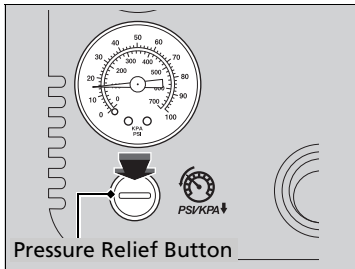

- 12.** Turn off the kit.
 - Check the pressure gauge on the air compressor.
 - If overinflated, press the pressure relief button.
- 13.** Unplug the kit from the accessory power socket.
- 14.** Unscrew the sealant/air hose from the tire valve stem. Reinstall the valve cap.
- 15.** Press the pressure relief button until the gauge returns to 0 psi (0 kPa).
- 16.** Repackage and properly stow the kit.

Vehicles with optional spare tire

Changing a Flat Tire

If a tire goes flat while driving, grasp the steering wheel firmly, and brake gradually to reduce speed. Then, stop in a safe place. Replace the flat tire with a compact spare tire. Go to a dealer as soon as possible to have the full-size tire repaired or replaced.

1. Park the vehicle on firm, level, non-slippery surface, and apply the parking brake.
2. Change the gear position to **P**.
3. Turn on the hazard warning lights and set the power mode to VEHICLE OFF (LOCK).

✎ Changing a Flat Tire

Follow compact spare precautions:

Periodically check the tire pressure of the compact spare. It should be set to the specified pressure.
Specified Pressure: 60 psi (420 kPa, 4.2 kgf/cm²)

When driving with the compact spare tire, keep the vehicle speed under 50 mph (80 km/h). Replace with a full-size tire as soon as possible.

The compact spare tire and wheel in your vehicle are specifically for this model. Do not use them with another vehicle. Do not use another type of compact spare tire or wheel with your vehicle.

Do not mount tire chains on a compact spare tire. If a chain-mounted front tire goes flat, remove one of the full-size rear tires and replace it with the compact spare tire. Remove the flat front tire and replace it with the full-size tire that was removed from the rear. Mount the tire chains on the front tire.

Do not use a puncture-repairing agent other than the Tire Repair Kit provided with your vehicle, as some tire repair agents can cause damage to the pressure sensors.

■ Getting Ready to Replace the Flat Tire

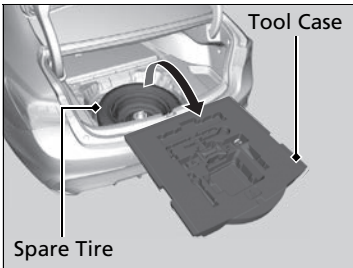

1. Open the trunk floor lid.
 ✎ **Temporarily Repairing a Flat Tire** P. 519
2. Take the tool case out of the trunk. Take the jack and wheel nut wrench, and jack handle bar out of the tool case.
3. Unscrew the wing bolt, and remove the spacer cone. Then, remove the spare tire.
4. Place a wheel block or rock in front and rear of the wheel diagonal to the flat tire.

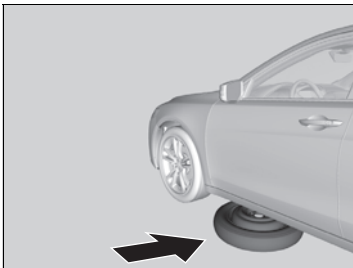
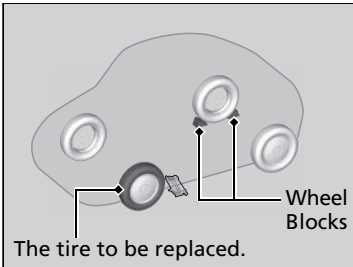

5. Place the compact spare tire (wheel side up) under the vehicle body, near the tire that needs to be replaced.

✎ Changing a Flat Tire

Do not use the jack if it doesn't work properly. Call your dealer or a professional towing service.



6. Loosen each wheel nut about one turn using the wheel nut wrench.

How to Set Up the Jack

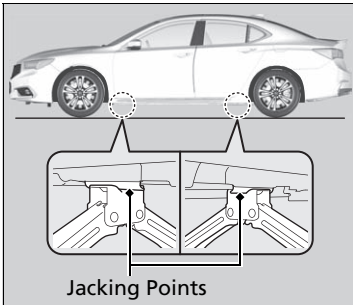

1. Place the jack under the jacking point closest to the tire to be changed.



2. Turn the end bracket (as shown in the image) clockwise until the top of the jack contacts the jacking point.
 - ▶ Make sure that the jacking point tab is resting in the jack notch.

How to Set Up the Jack

⚠ WARNING

The vehicle can easily roll off the jack, seriously injuring anyone underneath.

Follow the directions for changing a tire exactly, and never get under the vehicle when it is supported only by the jack.

Do not use the jack with people or luggage in the vehicle.

Use the jack provided in your vehicle. Other jacks may not support the weight ("load") or may not fit the jacking point.

The following instructions must be followed to use the jack safely:

- Do not use while the engine is running.
- Use only where the ground is firm and level.
- Use only at the jacking points.
- Do not get in the vehicle while using the jack.
- Do not put anything on top of or underneath the jack.

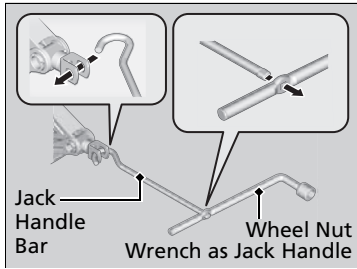

3. Raise the vehicle, using the jack handle bar and the jack handle, until the tire is off the ground.

■ Replacing the Flat Tire

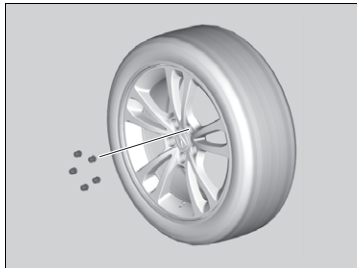

1. Remove the wheel nuts and flat tire.

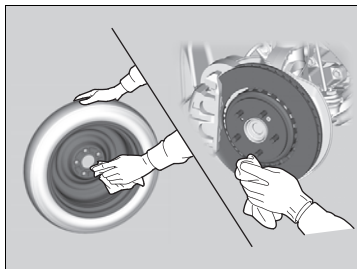

2. Wipe the mounting surfaces of the wheel with a clean cloth.
3. Mount the compact spare tire.
4. Screw the wheel nuts until they touch the lips around the mounting holes, then stop rotating.

▣ Replacing the Flat Tire

Do not over tighten the wheel nuts by applying extra torque using your foot or a pipe.

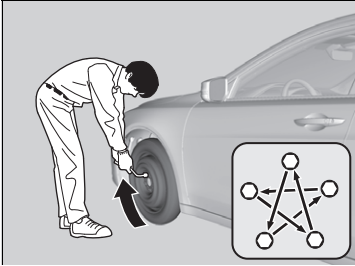

5. Lower the vehicle and remove the jack. Tighten the wheel nuts in the order indicated in the image. Go around, tightening the nuts, two to three times in this order.

Wheel nut torque:

80 lbf·ft (108 N·m, 11 kgf·m)

Storing the Flat Tire

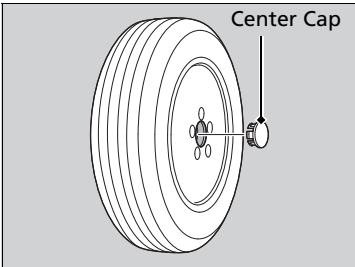

1. Remove the center cap.

Storing the Flat Tire

⚠ WARNING

Loose items can fly around the interior in a crash and can seriously injure the occupants. Store the wheel, jack, and tools securely before driving.

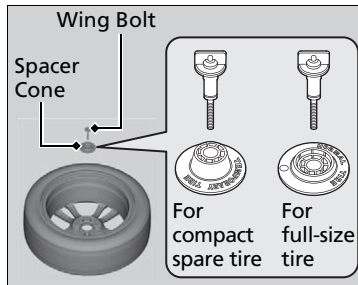

2. Place the flat tire face down in the spare tire well.
3. Remove the spacer cone from the wing bolt, flip it over, and insert it back on the bolt. Secure the flat tire with the wing bolt.
4. Securely put the jack, wheel nut wrench and jack handle bar back in the tool case. Store the case in the trunk.

■ TPMS and the Spare Tire

If you replace a flat tire with the spare tire, the low tire pressure/TPMS indicator comes on while you are driving. After driving for a few miles (kilometers), the indicator will start blinking for a short time and then stay on. **Tire Pressure Monitor Problem** appears on the multi-information display, but this is normal.

If you replace the tire with a full-size tire, the warning message on the multi-information display and the low tire pressure/TPMS indicator will go off after a few miles (kilometers).

▣ TPMS and the Spare Tire

The system cannot monitor the pressure of the spare tire. Manually check the spare tire pressure to be sure that it is correct.

Use the TPMS specific wheels. Each is equipped with a tire pressure sensor mounted inside the tire behind the valve stem.

Checking the Engine

If the engine does not start, check the starter.

☒ Checking the Engine

If you must start the vehicle immediately, use an assisting vehicle or booster battery to jump start it.

☒ **Jump Starting** P. 542

| Starter condition | Checklist |
|--|--|
| <p>Starter doesn't turn or turns over slowly.</p> <p>The battery may be dead. Check each of the items on the right and respond accordingly.</p> | <p>Check for a message on the multi-information display.</p> <ul style="list-style-type: none">• If the To Start, Hold Remote Near Start Button message appears<ul style="list-style-type: none">☒ If the Keyless Access Remote Battery is Weak P. 540▶ Make sure the keyless access remote is in its operating range.<ul style="list-style-type: none">☒ ENGINE START/STOP Button Operating Range P. 157 |
| <p>The starter turns over normally but the engine doesn't start.</p> <p>There may be a problem with the fuse. Check each of the items on the right and respond accordingly.</p> | <p>Check the brightness of the interior lights.</p> <p>Turn on the interior lights and check the brightness.</p> <ul style="list-style-type: none">• If the interior lights are dim or do not come on at all<ul style="list-style-type: none">☒ Battery P. 504• If the interior lights come on normally ☒ Fuses P. 555 |
| <p>The starter turns over normally but the engine doesn't start.</p> <p>There may be a problem with the fuse. Check each of the items on the right and respond accordingly.</p> | <p>Review the engine start procedure.</p> <p>Follow its instructions, and try to start the engine again. ☒ Starting the Engine P. 362</p> <p>Check the immobilizer system indicator.</p> <p>When the immobilizer system indicator is blinking, the engine cannot be started. ☒ Immobilizer System P. 151</p> |
| <p>The starter turns over normally but the engine doesn't start.</p> <p>There may be a problem with the fuse. Check each of the items on the right and respond accordingly.</p> | <p>Check the fuel level.</p> <p>There should be enough fuel in the tank. ☒ Fuel Gauge P. 113</p> |
| <p>The starter turns over normally but the engine doesn't start.</p> <p>There may be a problem with the fuse. Check each of the items on the right and respond accordingly.</p> | <p>Check the fuse.</p> <p>Check all fuses, or have the vehicle checked by a dealer. ☒ Inspecting and Changing Fuses P. 559</p> |
| <p>The starter turns over normally but the engine doesn't start.</p> <p>There may be a problem with the fuse. Check each of the items on the right and respond accordingly.</p> | <p>If the problem continues:</p> <ul style="list-style-type: none">☒ Emergency Towing P. 560 |

If the Keyless Access Remote Battery is Weak

If the beeper sounds, the **To Start, Hold Remote Near Start Button** message appears on the multi-information display, and the indicator on the **ENGINE START/STOP** button flashes, and the engine won't start.

Start the engine as follows:

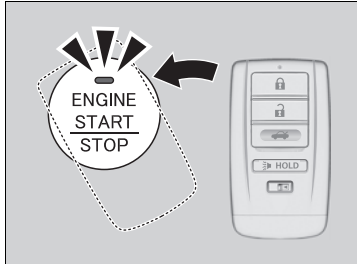

1. Touch the center of the **ENGINE START/STOP** button with the **A** logo on the keyless access remote while the indicator on the **ENGINE START/STOP** button is flashing. The buttons on the keyless access remote should be facing you.
 - ▶ The indicator flashes for about 30 seconds.

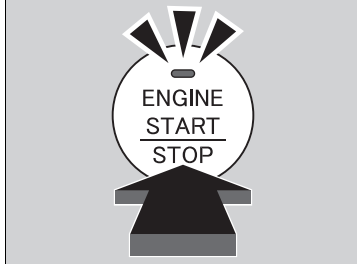

2. Depress the brake pedal and press the **ENGINE START/STOP** button within 10 seconds after the beeper sounds while the indicator stays on.
 - ▶ If you don't depress the pedal, the mode will change to ACCESSORY.

Emergency Engine Stop

The **ENGINE START/STOP** button may be used to stop the engine due to an emergency situation even while driving. If you must stop the engine, do either of the following operations:

- Press and hold the **ENGINE START/STOP** button for about two seconds.
- Firmly press the **ENGINE START/STOP** button three times.

The steering wheel will not lock. However, because turning off the engine disables the power assist the engine provides to the steering and braking systems, it will require significantly more physical effort and time to steer and slow the vehicle. Use both feet on the brake pedal to slow down the vehicle and stop immediately in a safe place.

Automatic transmission models with electronic gear selector for U.S. models

The gear position automatically changes to **P** after the vehicle comes to a complete stop. Then, the power mode changes to VEHICLE OFF.

Automatic transmission models with electronic gear selector for Canadian models

The gear position automatically changes to **P** after the vehicle comes to a complete stop. Then press the **ENGINE START/STOP** button twice without depressing the brake pedal to change the mode VEHICLE OFF.

Automatic transmission models with shift lever for U.S. models

The power mode is in ACCESSORY when the engine is stopped. To change the mode to VEHICLE OFF, move the shift position to **P** after the vehicle comes to a complete stop.

Automatic transmission models with shift lever for Canadian models

Then press the **ENGINE START/STOP** button twice without depressing the brake pedal.

Emergency Engine Stop

Do not press the button while driving unless it is absolutely necessary for the engine to be turned off.

Jump Starting Procedure

Turn off the power to electric devices, such as audio and lights. Turn off the engine, then open the hood.

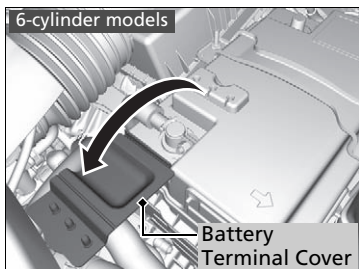

6-cylinder models

1. Open the battery terminal cover.

Jump Starting

⚠ WARNING

A battery can explode if you do not follow the correct procedure, seriously injuring anyone nearby.

Keep all sparks, open flames, and smoking materials away from the battery.

Securely attach the jumper cable clips so that they do not come off when the engine vibrates. Also be careful not to tangle the jumper cables or allow the cable ends to touch each other while attaching or detaching the jumper cables.

Battery performance degrades in cold conditions and may prevent the engine from starting.

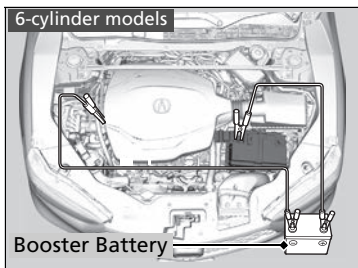
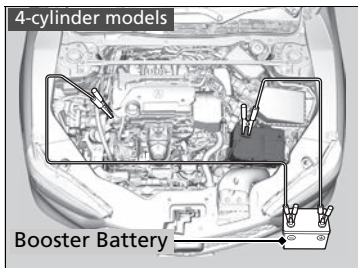
**All models**

2. Connect the first jumper cable to your vehicle's battery \oplus terminal.
3. Connect the other end of the first jumper cable to the booster battery \oplus terminal.
 - ▶ Use a 12-volt booster battery only.
 - ▶ When using an automotive battery charger to boost your 12-volt battery, select a lower charging voltage than 15 volts. Check the charger manual for the proper setting.
4. Connect the second jumper cable to the booster battery \ominus terminal.

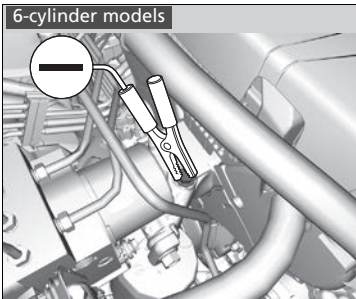
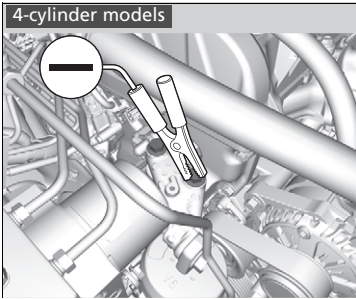

5. Connect the other end of the second jumper cable to the mounting bolt as shown. Do not connect this jumper cable to any other part.
6. If your vehicle is connected to another vehicle, start the assisting vehicle's engine and increase its rpm slightly.
7. Attempt to start your vehicle's engine. If it turns over slowly, check that the jumper cables have good metal-to-metal contact.

■ What to Do After the Engine Starts

Once your vehicle's engine has started, remove the jumper cables in the following order:

1. Disconnect the jumper cable from your vehicle's ground.
2. Disconnect the other end of the jumper cable from the booster battery \ominus terminal.
3. Disconnect the jumper cable from your vehicle's battery \oplus terminal.
4. Disconnect the other end of the jumper cable from the booster battery \oplus terminal.

Have your vehicle inspected by a nearby service station or a dealer.

Shift Lever Does Not Move

Models with shift lever

Follow the procedure below if you cannot move the shift lever out of the **P** position.

Releasing the Lock

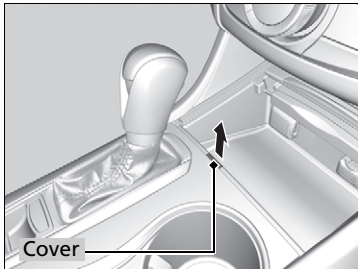

1. Set the parking brake.
2. Remove the built-in key from the keyless access remote.
3. Pull up the bottom edge of the cover with your finger, then remove it.

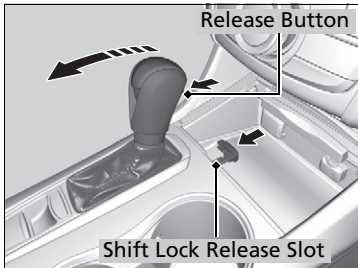

4. Insert the key into the shift lock release slot.
5. While pushing the key, press the shift lever release button, and place the shift lever into **N**.
 - ▶ The lock is now released. Have the shift lever checked by a dealer as soon as possible.

How to Handle Overheating

Overheating symptoms are as follows:

- The temperature gauge needle is at the **H** mark or the engine suddenly loses power.
- The **Stop Driving When Safe. Engine Temperature Too Hot** message appears on the multi-information display.
- Steam or spray comes out of the engine compartment.

■ First thing to do

1. Immediately park the vehicle in a safe place.
2. Turn off all accessories and turn on the hazard warning lights.
 - ▶ **No steam or spray present:** Keep the engine running and open the hood.
 - ▶ **Steam or spray is present:** Turn off the engine and wait until it subsides. Then, open the hood.

☒ How to Handle Overheating

⚠ WARNING

Steam and spray from an overheated engine can seriously scald you.

Do not open the hood if steam is coming out.

NOTICE

Continuing to drive with the temperature gauge needle at the **H** mark may damage the engine.

■ Next thing to do

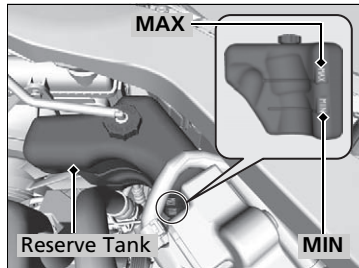

1. Check that the cooling fan is operating and stop the engine once the **Stop Driving When Safe. Engine Temperature Too Hot** message on the multi-information display goes off.
 - If the cooling fan is not operating, immediately stop the engine.
2. Once the engine has cooled down, inspect the coolant level and check the cooling system components for leaks.
 - If the coolant level in the reserve tank is low, add coolant until it reaches the **MAX** mark.
 - If there is no coolant in the reserve tank, check that the radiator is cool. Cover the radiator cap with a heavy cloth and open the cap. If necessary, add coolant up to the base of the filler neck, and put the cap back on.

■ Last thing to do

Once the engine has cooled sufficiently, restart it and check the temperature gauge. If the temperature gauge needle has gone down, resume driving. If it has not gone down, contact a dealer for repairs.

► How to Handle Overheating

⚠ WARNING

Removing the radiator cap while the engine is hot can cause the coolant to spray out, seriously scalding you.

Always let the engine and radiator cool down before removing the radiator cap.

If the coolant is leaking, contact a dealer for repairs.

Use water as an emergency/temporary measure only. Have a dealer flush the system with proper antifreeze as soon as possible.

If the Low Oil Pressure Indicator Comes On



■ Reasons for the indicator to come on

Comes on when the engine oil pressure is low.

■ What to do as soon as the indicator comes on

1. Immediately park the vehicle on level ground in a safe place.
2. If necessary, turn the hazard warning lights on.

■ What to do after parking the vehicle

1. Stop the engine and let it sit for about three minutes.
2. Open the hood and check the oil level.
 - ▶ **Oil Check** P. 478
3. Start the engine and check the low oil pressure indicator.
 - ▶ The indicator goes off: Start driving again.
 - ▶ The indicator does not go off within 10 seconds: Stop the engine and contact a dealer for repairs immediately.

If the Charging System Indicator Comes On



■ Reasons for the indicator to come on

Comes on when the battery is not being charged.

■ What to do when the indicator comes on

Turn off the climate control system, rear defogger, and other electrical systems, and immediately contact a dealer for repairs.

☒ If the Low Oil Pressure Indicator Comes On

NOTICE

Running the engine with low oil pressure can cause serious mechanical damage almost immediately.

☒ If the Charging System Indicator Comes On

If you need to stop temporarily, do not turn off the engine. Restarting the engine may rapidly discharge the battery.

If the Malfunction Indicator Lamp Comes On or Blinks



■ Reasons for the indicator lamp to come on or blink

- Comes on if there is a problem with the engine emissions control system.
- Blinks when engine misfiring is detected.

■ What to do when the indicator lamp comes on

Avoid high speeds and immediately get your vehicle inspected at a dealer.

■ What to do when the indicator lamp blinks

Park the vehicle in a safe place with no flammable items and wait at least 10 minutes or more with the engine stopped until it cools.

If the Brake System Indicator (Red) Comes On

U.S.



Canada



■ Reasons for the indicator to come on

- The brake fluid is low.
- There is a malfunction in the brake system.

■ What to do when the indicator comes on while driving

Depress the brake pedal lightly to check pedal pressure.

- If normal, check the brake fluid level the next time you stop.
- If abnormal, take immediate action. If necessary, downshift the transmission to slow the vehicle using engine braking.

▶▶ If the Malfunction Indicator Lamp Comes On or Blinks

NOTICE

If you drive with the malfunction indicator lamp on, the emissions control system and the engine could be damaged.

If the malfunction indicator lamp blinks again when restarting the engine, drive to the nearest dealer at 31 mph (50 km/h) or less. Have your vehicle inspected.

▶▶ If the Brake System Indicator (Red) Comes On

Have your vehicle repaired immediately. It is dangerous to drive with low brake fluid. If there is no resistance from the brake pedal, stop immediately in a safe place. If necessary downshift the gears.

If the brake system indicator and **ABS** indicator come on simultaneously, the electronic brake distribution system is not working. This can result in vehicle instability under sudden braking. Have your vehicle inspected by a dealer immediately.

If the Electric Power Steering (EPS) System Indicator Comes On



■ Reasons for the indicator to come on

- Comes on when there is a problem with the EPS system.
- If you depress the accelerator pedal repeatedly to increase the engine speed while the engine is idling, the indicator comes on, and sometimes the steering wheel becomes harder to operate.

■ What to do when the indicator comes on

Stop the vehicle in a safe place and restart the engine.

If the indicator comes on and stays on, immediately have your vehicle inspected by a dealer.

If the Electric Parking Brake System Indicator Comes On



■ Reasons for the indicator to come on

Comes on if there is a problem with the electric parking brake system.

■ What to do when the indicator comes on

Avoid using the parking brake and immediately get your vehicle inspected at a dealer.

■ What to do when the electric parking brake indicator comes on or blinks at the same time

Release the parking brake.

🔧 **Parking Brake** P. 429

- If the electric parking brake indicator remains on or blinks, even after releasing the parking brake, immediately stop the vehicle in a safe place, and call a dealer.
 - ▶ Preventing the vehicle from moving, the transmission is in **P**.
- If only the electric parking brake indicator goes off, immediately get your vehicle inspected at a dealer.

🔧 If the Electric Parking Brake System Indicator Comes On

If you apply parking brake, it may not release.

If the electric parking brake indicator also turns on, the parking brake is still applied.

When the electric parking brake indicator blinks at the same time as the electric parking brake system indicator, the system must be checked. The parking brake may not operate under these conditions.

If the Low Tire Pressure/TPMS Indicator Comes On or Blinks



■ Reasons for the indicator to come on or blink

A tire pressure is significantly low. If there is a problem with the TPMS with Tire Fill Assist or the compact spare tire* is installed, the indicator blinks for about one minute, and then stays on.

■ What to do when the indicator comes on

Drive carefully and avoid abrupt cornering and hard braking.

Stop your vehicle in a safe place. Check the tire pressure and adjust the pressure to the specified level. The specified tire pressure is on a label on the driver's side doorjamb.

▶ Calibrate the TPMS after the tire pressure is adjusted.

■ What to do when the indicator blinks

Have the tire inspected by a dealer as soon as possible. If the compact spare tire* causes the indicator to blink, change the tire to a full-size tire. The indicator goes off after driving for a few miles (kilometers).

▶▶ If the Low Tire Pressure/TPMS Indicator Comes On or Blinks

NOTICE

Driving on an extremely underinflated tire can cause it to overheat. An overheated tire can fail. Always inflate your tires to the prescribed level.

TPMS Fill Assist provides visual and audible assistance during tire pressure adjustment. With the power mode in ON, while you adjust tire pressure up or down, the system alerts you as follows:

Below recommended pressure: The beeper sounds and exterior lights flash once every five seconds.

At recommended pressure: The beeper sounds and exterior lights flash rapidly for ~ five seconds.

Above recommended pressure: The beeper sounds and lights flash twice every three seconds.

* Not available on all models

Models with electronic gear selector

If the Transmission System Indicator Blinks along with the Warning Message



■ Reasons for the indicator to blink

The transmission is malfunctioned.



■ What to do when the indicator blinks

- Immediately have your vehicle inspected by a dealer.
- Change to **N** after starting the engine.
 - ▶ Check if the **N** position on the instrument panel and the indicator on the **N** button light/blink.
 - ▶ The engine cannot be turned on unless the parking brake is set.
 - **Starting the Engine** P. 362

⚠ If the Transmission System Indicator Blinks along with the Warning Message

You may not be able to start the engine.

Make sure to set the parking brake when parking your vehicle.

Call a professional towing service if you need to tow your vehicle.

➤ **Emergency Towing** P. 560

Fuse Locations

If any electrical devices are not working, set the power mode to VEHICLE OFF (LOCK) and check to see if any applicable fuse is blown.

Engine Compartment Fuse Box Type A

Fuse locations are shown on the fuse box cover. Locate the fuse in question by the fuse number and box cover number.

Located near the brake fluid reservoir. Push the tabs to open the box.

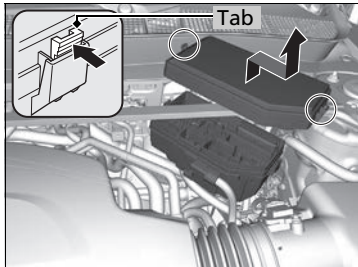

■ Circuit protected and fuse rating

| | Circuit Protected | Amps |
|--------------|----------------------------|-------|
| 1 | EPS | 70 A |
| | Sub Fuse Box | 60 A |
| | ABS/VSA Motor | 40 A |
| | ABS/VSA FSR | 20 A |
| | Main Fan ^{*2, *3} | 30 A |
| | Main Fuse | 125 A |
| | IG Main | 30 A |
| 2 | F/B Main | 60 A |
| | F/B Main 2 | 60 A |
| | Headlight Main | 30 A |
| | IG Main 2 | 30 A |
| | Starter Cut 1 | 40 A |
| | Injector ^{*2, *3} | 20 A |
| | Sub Fan ^{*1} | 20 A |
| | Rear Defroster | 40 A |
| | Main Fan ^{*1} | 30 A |
| | Sub Fan ^{*2, *3} | 30 A |
| Wiper | 30 A | |
| Heater Motor | 40 A | |

| | Circuit Protected | Amps |
|----|------------------------------------|---------|
| 3 | Headlight Washer ^{*2, *3} | (30 A) |
| | Left Electric Parking Brake | 30 A |
| | Right Electric Parking Brake | 30 A |
| | Driver Thigh Support [*] | (30 A) |
| 4 | – | – |
| 5 | – | – |
| 6 | – | – |
| 7 | – | – |
| 8 | STRLD ^{*1, *2} | 7.5 A |
| 9 | Interior Lights ^{*1, *2} | 5 A |
| 10 | Headlight Low/High Main | 20 A |
| 11 | Oil Level | 7.5 A |
| 12 | Front Fog Lights [*] | (7.5 A) |
| 13 | Passenger's Power Seat Reclining | 20 A |
| 14 | Hazard | 15 A |
| 15 | IGP2 | 15 A |
| 16 | IG Coil | 15 A |
| 17 | Stop ^{*1, *2} | 10 A |
| | SH-AWD ^{*3} | 20 A |

*1:4-cylinder models

*2:6-cylinder models with 2WD

*3:6-cylinder models with AWD

| | Circuit Protected | Amps |
|----|---|-------|
| 18 | Horn | 10 A |
| 19 | Audio* ¹ , * ² | 20 A |
| | Interior Light* ³ | 5 A |
| 20 | ACM* ² , * ³ | 20 A |
| | Injector* ¹ | |
| 21 | FI Main | 15 A |
| 22 | DBW | 15 A |
| 23 | TCU/SBW* ² , * ³ | 10 A |
| 24 | Premium AMP | 30 A |
| 25 | MG Clutch | 7.5 A |
| 26 | Passenger's Power Seat Sliding | 20 A |
| 27 | Parking Lights* ¹ , * ² | 15 A |
| 28 | BMS | 7.5 A |
| 29 | Back Up | 10 A |

*1: 4-cylinder models
 *2: 6-cylinder models with 2WD
 *3: 6-cylinder models with AWD

■ Engine Compartment Fuse Box Type B

Located near the washer fluid cap. Push the tabs to open the box.

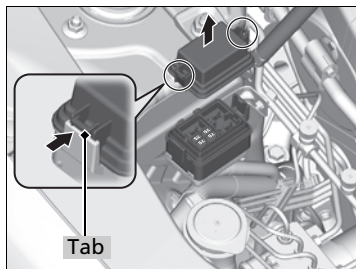

■ Circuit protected and fuse rating

| | Circuit Protected | Amps |
|---|---------------------------|-------|
| 1 | Left Headlight Low Beam | 7.5 A |
| 2 | Right Headlight Low Beam | 7.5 A |
| 3 | Right Headlight High Beam | 7.5 A |
| 4 | Left Headlight High Beam | 7.5 A |

■ Driver's Side Interior Fuse Box Type A

Located under the dashboard.

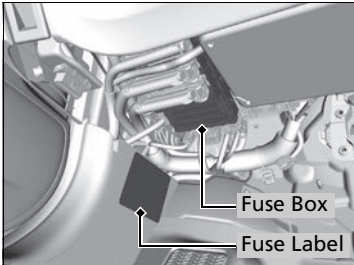

Fuse locations are shown on the label on the under panel.

Locate the fuse in question by the fuse number and label number.

■ Circuit protected and fuse rating

| | Circuit Protected | Amps |
|---|--|---------|
| 1 | A/C | 7.5 A |
| 2 | DRL | 7.5 A |
| 3 | ST Motor | (7.5 A) |
| 4 | – | – |
| 5 | Meter* ¹ Auto Dimming Mirror* ² | 7.5 A |
| 6 | SRS | (7.5 A) |

| | Circuit Protected | Amps |
|----|---|---------|
| 7 | Option | 7.5 A |
| 8 | MISS SOL* ³ | (15 A) |
| 9 | Fuel Pump | 20 A |
| 10 | ABS/VSA* ¹ Smart* ² | (7.5 A) |
| 11 | Spare Fuse | 30 A |
| 12 | Wiper | 7.5 A |
| 13 | ACG | 15 A |
| 14 | Accessory Power Socket (Console Compartment) | 20 A |
| 15 | Driver's Power Seat Reclining | 20 A |
| 16 | Moonroof | 20 A |
| 17 | AVS/Seat Heaters | 20 A |
| 18 | – | – |
| 19 | Passenger's Side Door Unlock | 10 A |
| 20 | Driver's Side Rear Door Unlock | 10 A |
| 21 | Driver's Side Door Lock | (10 A) |
| 22 | Passenger's Side Door Lock | 10 A |
| 23 | Driver's Side Door Unlock | (10 A) |
| 24 | SRS | 10 A |
| 25 | Instrument Panel Lights | 7.5 A |
| 26 | ACC Key Lock | 7.5 A |

| | Circuit Protected | Amps |
|----|---|-------|
| 27 | Parking Lights | 7.5 A |
| 28 | Lumbar Support | 10 A |
| 29 | Right DRL | 7.5 A |
| 30 | Washer | 20 A |
| 31 | SMART | 10 A |
| 32 | Driver's Side Power Window | 20 A |
| 33 | Passenger's Side Power Window | 20 A |
| 34 | Rear Driver's Side Power Window | 20 A |
| 35 | Rear Passenger's Side Power Window | 20 A |
| 36 | Driver's Power Seat Sliding | 20 A |
| 37 | ACCESSORY | 7.5 A |
| 38 | – | – |
| 39 | Left DRL | 7.5 A |
| 40 | Accessory Power Socket (Center Pocket) | 20 A |
| 41 | Rear Driver's Side Door Lock | 10 A |
| 42 | Door Lock | 20 A |

*1:2WD models

*2:AWD models

*3:4-cylinder models

| | Circuit Protected | Amps |
|---|------------------------------------|--------|
| A | – | – |
| B | – | – |
| C | Meter* ² | 7.5 A |
| D | Back Up* ² | 10 A |
| E | Stop* ² | 7.5 A |
| F | Parking Lights* ² | 15 A |
| G | Audio ACC* ² | 7.5 A |
| | Rear Seat Heater*, *1, *2, *3 | (15 A) |
| A | ABS/VSA* ² | 7.5 A |
| B | MICU* ² | 7.5 A |
| C | – | – |
| D | – | – |
| E | STRLD* ² | 7.5 A |
| F | Audio* ² | 20 A |
| G | ACM* ² | 7.5 A |
| | Heated Steering Wheel*, *1, *2, *3 | (10 A) |

*1:2WD models

*2:AWD models

*3:Have a dealer replace the fuse.

■ Driver's Side Interior Fuse Box Type B

Located inside the driver's side outer panel. When you remove the outer panel, use the following procedure.

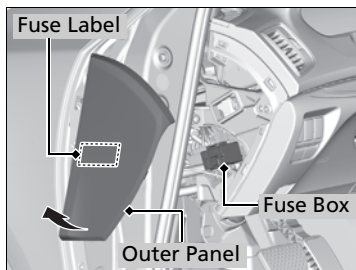

1. Grasp the bottom edge of the outer panel.
2. Pull the panel towards you, then remove it.

Fuse locations are shown on the outer panel.

■ Circuit protected and fuse rating

| | Circuit Protected | Amps |
|---|-------------------------|--------|
| 1 | P-AWS L | (40 A) |
| 2 | – | – |
| 3 | – | – |
| 4 | ACC Radar | (10 A) |
| 5 | Idle Stop* ¹ | (30 A) |
| 6 | P-AWS R | (40 A) |
| 7 | FR DE-ICE* | (15 A) |
| 8 | Idle Stop* ¹ | (30 A) |

*1:AWD models

Inspecting and Changing Fuses

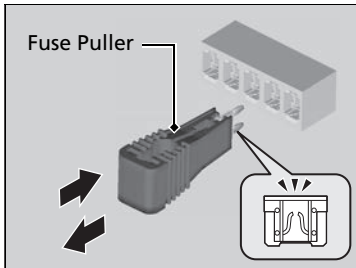
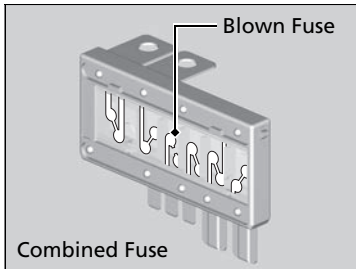

1. Set the power mode to VEHICLE OFF (LOCK). Turn headlights and all accessories off.
2. Remove the fuse box cover.
3. Check the large fuse in the engine compartment.
 - If the fuse is blown, use a Phillips-head screwdriver to remove the screw and replace it with a new one.
4. Inspect the small fuses in the engine compartment and the vehicle interior.
 - If there is a blown fuse, remove it with the fuse puller and replace it with a new one.

Inspecting and Changing Fuses

NOTICE

Replacing a fuse with one that has a higher rating greatly increases the chances of damaging the electrical system.

Replace fuse with a spare fuse of the same specified amperage.

Confirm the specified amperage using the charts on P. 555 to 558.

There is a fuse puller on the back of the engine compartment fuse box cover.

Call a professional towing service if you need to tow your vehicle.

All models

■ Flat bed equipment

The operator loads your vehicle on the back of a truck.

This is the best way you can safely transport your vehicle.

2WD models

■ Wheel lift equipment

The tow truck uses two pivoting arms that go under the front tires and lift them off the ground. The rear tires remain on the ground.

This is an acceptable way to tow your vehicle.

» Emergency Towing

NOTICE

Trying to lift or tow your vehicle by the bumpers will cause serious damage. The bumpers are not designed to support the vehicle's weight.

NOTICE

Improper towing such as towing behind a motorhome or other motor vehicle can damage the transmission.

Never tow your vehicle with just a rope or chain. It is very dangerous since ropes or chains may shift from side to side or break.

What to Do When Unable to Unlock the Fuel Fill Door

If you cannot unlock the fuel fill door, use the following procedure:

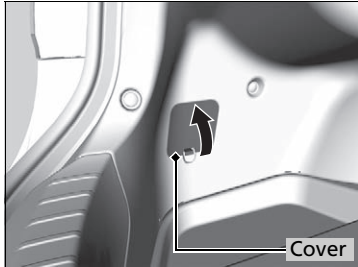

1. Open the trunk and remove the cover.

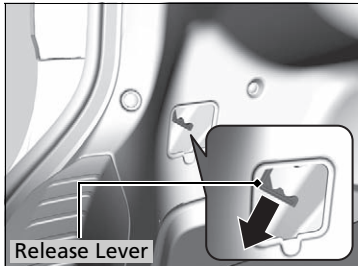

2. Pull the release lever toward you.
 - ▶ The release lever unlocks the fuel fill door when it is pulled.

When You Cannot Unlock the Fuel Fill Door

After taking these steps, contact a dealer to have the vehicle checked.

■ What to Do When Unable to Open the Trunk

If you cannot open the trunk, use the following procedure:

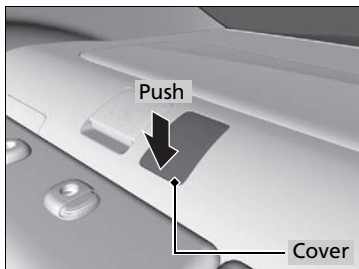

1. Remove the cover.

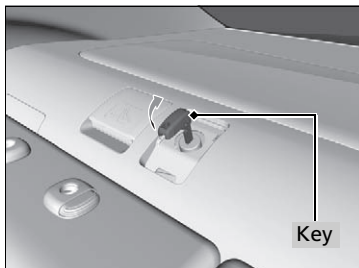

2. Insert the key into the cylinder and turn the key to the right.
▶ The trunk unlocks and opens.

▣ When You Cannot Open the Trunk

Following up:

After taking these steps, contact a dealer to have the vehicle checked.

Refueling From a Portable Fuel Container

If you have run out of fuel and need to refuel your vehicle from a portable fuel container, use the funnel provided with your vehicle.

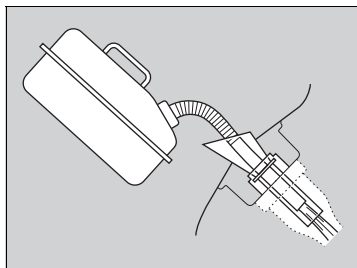
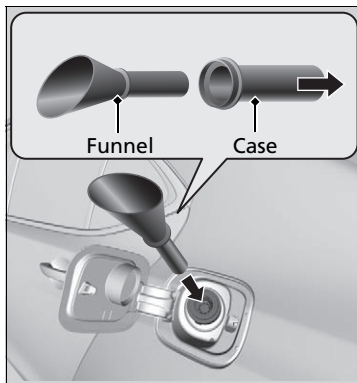

1. Turn off the engine.
2. Press the fuel fill door release button.
 - ▶ The fuel fill door opens.
3. Take the funnel out of the tool case in the trunk.
 - ▶ **Types of Tools** P. 518
4. Remove the **funnel from the case**.
5. Place the end of the funnel on the lower part of filler opening, then insert it slowly and fully.
 - ▶ Make sure that the end of the funnel goes down along with the filler pipe.
6. Fill the tank with fuel from the portable fuel container.
 - ▶ Pour fuel carefully so you do not spill any.
7. Remove the funnel from the filler neck.
 - ▶ Wipe up any fuel from the funnel before storing it.
8. Shut the fuel fill door by hand.

Refueling From a Portable Fuel Container

WARNING

Gasoline is highly flammable and explosive. You can be burned or seriously injured when handling fuel.

- Stop the engine, and keep heat, sparks, and flame away.
- Handle fuel only outdoors.
- Wipe up spills immediately.

NOTICE

Do not insert the nozzle of a portable fuel container or any funnel other than the one provided with your vehicle. Doing so can damage the fuel system. Do not try to pry open or push open the sealed fuel tank with foreign objects. This can damage the fuel system and its seal.

Make sure the fuel in the portable fuel container is gasoline before you refuel.

Information

This chapter includes your vehicle's specifications, locations of identification numbers, and other information required by regulation.

| | |
|---|-----|
| Specifications | 566 |
| Identification Numbers | |
| Vehicle Identification Number (VIN), Engine Number, and Transmission Number | 568 |
| Devices that Emit Radio Waves | 569 |
| Reporting Safety Defects | 571 |
| Emissions Testing | |
| Testing of Readiness Codes | 572 |
| Warranty Coverages | 574 |
| Authorized Manuals | 576 |
| Client Service Information | 577 |

■ Vehicle Specifications

| | |
|----------------------------------|--|
| Model | Acura TLX |
| No. of Passengers: | |
| Front | 2 |
| Rear | 3 |
| Total | 5 |
| Weights: | |
| Gross Vehicle Weight Rating | U.S.: 4,497 lbs (2,040 kg) ^{*1} U.S.: 4,619 lbs (2,095 kg) ^{*2} U.S.: 4,762 lbs (2,160 kg) ^{*3} Canada: 2,055 kg ^{*1} Canada: 2,170 kg ^{*3} |
| Gross Axle Weight Rating (Front) | U.S.: 2,370 lbs (1,075 kg) ^{*1} U.S.: 2,535 lbs (1,150 kg) ^{*2} U.S.: 2,579 lbs (1,170 kg) ^{*3} Canada: 1,120 kg ^{*1} Canada: 1,180 kg ^{*3} |
| Gross Axle Weight Rating (Rear) | U.S.: 2,161 lbs (980 kg) ^{*1, *2} U.S.: 2,227 lbs (1,010 kg) ^{*3} Canada: 980 kg ^{*1} Canada: 1,015 kg ^{*3} |

*1: 4-cylinder models

*2: 6-cylinder models with 2WD

*3: 6-cylinder models with AWD

■ Air Conditioning

| | |
|------------------|--|
| Refrigerant Type | HFC-134a (R-134a) |
| Charge Quantity | 16.7 – 18.5 oz (475 – 525 g) |
| Lubricant Type | ND-OIL 8 |
| Quantity | 4.27 – 5.19 cu-in (70 – 85 cm ³) |

■ Engine Specifications

| | |
|--------------|--|
| Displacement | 144 cu-in (2,356 cm ³) ^{*1} |
| | 212 cu-in (3,471 cm ³) ^{*2} |
| Spark Plugs | DILKAR7H11GS ^{*1} |
| | DILKAR7G11GS ^{*1} |
| | DILZKR7B11G ^{*2} |
| | DENSO DXE22HQR-D11S ^{*1} |

*1: 4-cylinder models

*2: 6-cylinder models

■ Fuel

| | |
|--------------------|---|
| Type | Unleaded premium gasoline, Pump octane number of 91 or higher |
| Fuel Tank Capacity | 17.2 US gal (65 L) |

■ Washer Fluid

| | |
|---------------|---------------------------|
| Tank Capacity | U.S.: 2.6 US qt (2.5 L) |
| | Canada: 5.7 US qt (5.4 L) |

■ Light Bulbs

| | |
|---|-------|
| Headlights (High/Low Beam) | LED |
| Fog Lights* | LED |
| Front Turn Signal/Parking Lights | LED |
| Front Side Marker Lights | LED |
| Side Turn Signal Lights (on Door Mirrors) | LED |
| Brake/Taillights/Rear Side Marker Lights | LED |
| Brake/Taillights | LED |
| Back-Up Lights | 21 W |
| Rear Turn Signal Lights | 21 W |
| High-Mount Brake Light | LED |
| Rear License Plate Lights | LED |
| Puddle Lights* | LED |
| Interior Lights | |
| Front and Rear Map Lights | LED |
| Front and Rear Ambient Lights | LED |
| Vanity Mirror Lights | 1.4 W |
| Door Courtesy Lights | 3.4 W |
| Console Compartment Light | 1.4 W |
| Glove Box Light | 1.4 W |
| Door Inner Handle Lights | LED |
| Trunk Light | 5 W |

■ Brake Fluid

| | |
|-----------|------------------------------------|
| Specified | Acura Heavy Duty Brake Fluid DOT 3 |
|-----------|------------------------------------|

■ Dual Clutch Transmission Fluid *

| | | |
|-----------|---|-------------------|
| Specified | Acura Automatic Transmission Fluid ATF-TYPE 2 | |
| Capacity | Change | 4.1 US qt (3.9 L) |

■ Automatic Transmission Fluid *

| | | |
|-----------|---|-------------------|
| Specified | Acura Automatic Transmission Fluid ATF-TYPE 3 | |
| Capacity | Change | 3.5 US qt (3.3 L) |

■ Rear Differential Fluid *

| | | |
|-----------|---------------|---------------------|
| Specified | Acura DPSF-II | |
| Capacity | Change | 1.92 US qt (1.82 L) |

■ Transfer Assembly Fluid *

| | | |
|-----------|--|---------------------|
| Specified | -Acura Hypoid Gear Oil HGO-1 -Hypoid gear oil SAE 75W-85 or SAE 90 (API grade GL4 or GL5) | |
| Capacity | Change | 0.45 US qt (0.43 L) |

■ Engine Oil

| | | |
|-------------|--|--|
| Recommended | -Genuine Acura Motor Oil 0W-20 -API Premium-grade 0W-20 detergent oil | |
| Change | 4.2 US qt (4.0 L) | |
| Capacity | Change including filter | 4.4 US qt (4.2 L) ^{*1} 4.5 US qt (4.3 L) ^{*2} |

*1: 4-cylinder models
*2: 6-cylinder models

■ Engine Coolant

| | | |
|-----------|--|--|
| Specified | Acura Long Life Antifreeze/Coolant Type2 | |
| Ratio | 50/50 with distilled water | |
| Capacity | 1.66 US gal (6.3 L) ^{*1} 2.22 US gal (8.4 L) ^{*2} (change including the remaining 0.21 US gal (0.8 L) in the reserve tank) | |

*1: 4-cylinder models
*2: 6-cylinder models

■ Tire

| | | |
|-----------------------------|--|---|
| Regular | Size | 225/55R17 97H ^{*1} 225/50R18 95H ^{*2} 245/40R19 94V ^{*3} |
| | Pressure psi (kPa [kgf/cm ²]) | 32 (220 [2.2]) |
| Compact Spare ^{*4} | Size | T135/80D17 103M |
| | Pressure psi (kPa [kgf/cm ²]) | 60 (420 [4.2]) |
| Wheel Size | Regular | 17 x 7 1/2J ^{*1} 18 x 7 1/2J ^{*2} 19 x 8J ^{*3} |
| | Compact Spare ^{*4} | 17 x 4T |

*1: Models with 17 inch wheel
*2: Models with 18 inch wheel
*3: Models with 19 inch wheel
*4: Vehicles with optional spare tire

* Not available on all models

Vehicle Identification Number (VIN), Engine Number, and Transmission Number

Your vehicle has a 17-digit vehicle identification number (VIN) used to register your vehicle for warranty purposes, for licensing, and insuring your vehicle. The locations of your vehicle's VIN, engine number, and transmission number are shown as follows:

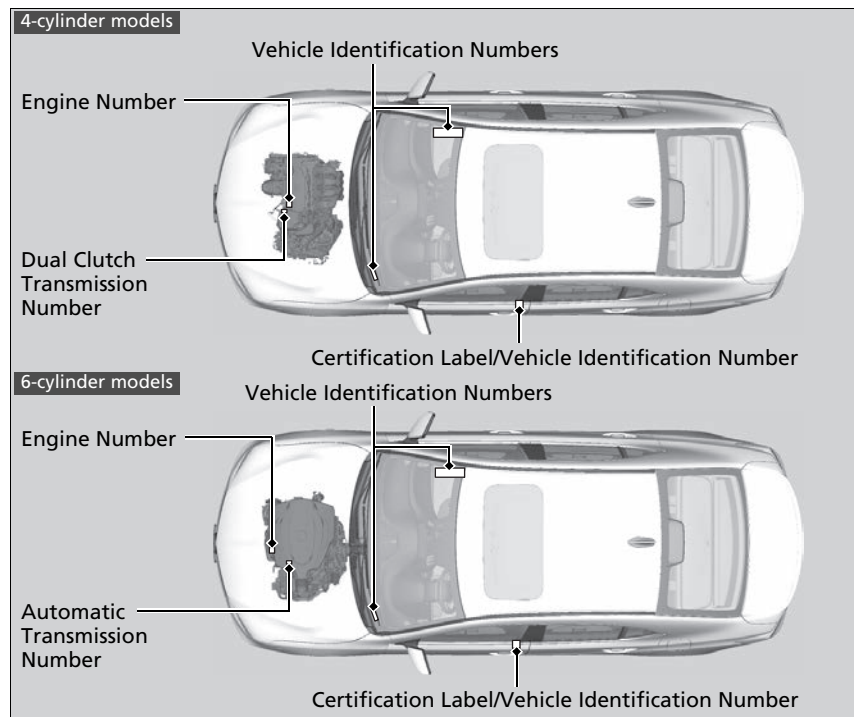

Vehicle Identification Number (VIN), Engine Number, and Transmission Number

The vehicle identification number (VIN) is located under the cover.

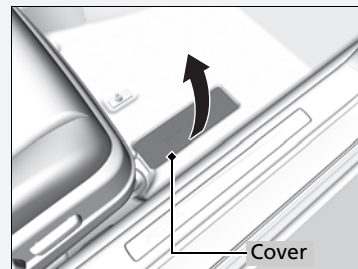

Devices that Emit Radio Waves

The following products and systems on your vehicle emit radio waves when in operation.

AcuraLink*

Audio System

Blind Spot Information System*

Bluetooth® Audio

Bluetooth® HandsFreeLink®

Collision Mitigation Braking System™

HomeLink® Universal Transceiver

Immobilizer System

Keyless Access System

Tire Pressure Monitoring System (TPMS)

Remote Engine Start with Vehicle Feedback*

Wireless charger*

Each of the above complies with the appropriate requirements or the required standards of FCC (Federal Communications Commission) and Industry Canada Standard, described below:

As required by the FCC:

This device complies with Part 15 of the FCC rules. Operation is subject to the following two conditions: (1) This device may not cause harmful interference, and (2) this device must accept any interference received, including interference that may cause undesired operation.

Changes or modifications not expressly approved by the party responsible for compliance could void the user's authority to operate the equipment.

* Not available on all models

This device complies with industry Canada licence-exempt RSS standard(s). Operation is subject to the following two conditions: (1) this device may not cause interference, and (2) this device must accept any interference, including interference that may cause undesired operation of the device.

In the U.S.

If you believe that your vehicle has a defect which could cause a crash or could cause injury or death, you should immediately inform the National Highway Traffic Safety Administration (NHTSA) in addition to notifying American Honda Motor Co., Inc.

If NHTSA receives similar complaints, it may open an investigation, and if it finds that a safety defect exists in a group of vehicles, it may order a recall and remedy campaign. However, NHTSA cannot become involved in individual problems between you, your dealer, or American Honda Motor Co., Inc.

To contact NHTSA, you may call the Vehicle Safety Hotline toll-free at 1-888-327-4236 (TTY: 1-800-424-9153); go to <http://www.safercar.gov>; or write to: Administrator, NHTSA, 1200 New Jersey Avenue, SE., Washington, DC 20590. You can also obtain other information about motor vehicle safety from <http://www.safercar.gov>.

In Canada

If you believe that your vehicle has a defect which could cause a crash or could cause injury or death, you should immediately inform Honda Canada Inc. and you may also inform Transport Canada.

If Transport Canada receives similar complaints, it may open an investigation, and if it finds that a safety defect exists in a group of vehicles, it may lead to a recall and remedy campaign. However, Transport Canada cannot become involved in individual problems between you, your dealer, or Honda Canada Inc.

To contact Transport Canada's Defect Investigations and Recalls Division, you may call 1-800-333-0510. For more information on reporting safety defects or about motor vehicle safety, go to <http://www.tc.gc.ca/roadsafety>.

Testing of Readiness Codes

Your vehicle has readiness code as part of the onboard self diagnostic system. Some States use these codes for testing to verify whether your vehicle's emissions components are working properly. The codes may not be read properly if testing is performed just after the battery has gone dead or been disconnected.

To check if they are set, set the power mode to ON, without starting the engine. The malfunction indicator lamp will come on for several seconds. If it then goes off, the readiness codes are set. If it blinks five times, the readiness codes are not set.

If you are required to have your vehicle tested before the readiness codes are ready, prepare the vehicle for retesting by doing the following:

1. Fill the gas tank to approximately 3/4 full.
2. Park the vehicle and leave the engine off for 6 hours or more.
3. Make sure the ambient temperature is between 40°F and 95°F (4°C and 35°C).
4. Start the engine without touching the accelerator pedal, and let it idle for 20 seconds.
5. Keep the vehicle in **P**.
Increase the engine speed to 2,000 rpm, and hold it there for about 3 minutes.
6. Let the engine idle with your foot off the accelerator for 20 seconds.

Testing of Readiness Codes

The readiness codes are erased when the battery is disconnected, and set again only after several days of driving under a variety of conditions.

If a testing facility determines that the readiness codes are not set, you may be requested to return at a later date to complete the test.

If the testing facility determines the readiness codes are still not set, see a dealer.

7. Select a nearby, lightly traveled major highway where you can maintain a speed of 50 to 60 mph (80 to 97 km/h) for at least 20 minutes. Drive on the highway in **D**. Do not use cruise control. When traffic allows, drive for 90 seconds without moving the accelerator pedal. (Vehicle speed may vary slightly; this is okay.) If you cannot do this for a continuous 90 seconds because of traffic conditions, drive for at least 30 seconds, then repeat it two more times (for a total of 90 seconds).
8. Drive in city or suburban traffic for at least 10 minutes. When traffic conditions allow, let the vehicle coast for several seconds without using the accelerator pedal or the brake pedal.
9. Park the vehicle and leave the engine off for 30 minutes.

■ U.S. Owners

Your new vehicle is covered by these warranties:

New Vehicle Limited Warranty – covers your new vehicle, except for the emissions control systems and accessories, against defects in materials and workmanship.

Emissions Control Systems Defects Warranty and Emissions Performance Warranty – these two warranties cover your vehicle's emissions control systems. Time, mileage, and coverage are conditional. Please read your warranty booklet for exact information.

Seat Belt Limited Warranty – a seat belt that fails to function properly is covered by a limited warranty. Please read your warranty booklet for details.

Rust Perforation Limited Warranty – all exterior body panels are covered against rusting from the inside out for the specified time period, regardless of mileage.

Accessory Limited Warranty – Acura accessories are covered under this warranty. Time and mileage limits depend on the type of accessory and other factors. Please read your warranty booklet for details.

Replacement Parts Limited Warranty – covers all Acura replacement parts against defects in materials and workmanship.

Replacement Battery Limited Warranty – provides prorated coverage for a replacement battery purchased from your dealer.

Replacement Muffler Lifetime Limited Warranty – provides coverage for as long as the purchaser of the muffler owns the vehicle.

Restrictions and exclusions apply to all these warranties. Please read the Acura warranty information booklet that came with your vehicle for precise information on warranty coverages. Your vehicle's original tires are covered by their manufacturer. Tire warranty information is in a separate booklet.

■ Canadian Owners

Please refer to the warranty manual that came with your vehicle.

■ EPA Contact Information

An owner may obtain further information concerning emission warranties or report violations of the terms of the emission warranties by contacting:

U.S. Environmental Protection Agency
Office of Transportation and Air Quality
Compliance Division, Light-Duty Vehicle Group
Attn: Warranty Complaints
2000 Traverwood Drive
Ann Arbor, MI 48105
Email: complianceinfo@epa.gov

■ Service Express

For electronic copies of service publications, you can purchase a subscription to Service Express. Visit www.techinfo.honda.com for pricing and options.

■ For U.S. Owners

Manuals can be purchased from Helm Incorporated. You can order a manual by phone at 1 (800) 782-4356 (credit card orders only), or online at www.helminc.com.

■ For Canadian Owners

Please contact a dealer to order any manuals that you may require.

Acura dealership personnel are trained professionals who should be able to deal with any problems you may encounter with your vehicle. If, however, you are faced with a problem that they cannot resolve to your satisfaction, contact Acura Client Relations/Services.

U.S. Owners

American Honda Motor Co., Inc.
Acura Client Relations
1919 Torrance Blvd.
Mail Stop 100-5E-8F
Torrance, CA. 90501-2746
Tel: 1 (800) 382-2238

Canadian Owners

Honda Canada Inc.
Acura Client Services
180 Honda Boulevard Markham, ON
L6C 0H9
Tel: 1-888-9-ACURA-9
Fax: 1-877-939-0909
E-mail: acura_cr@ch.honda.com

In Puerto Rico and the U.S. Virgin Islands

Bella International
P.O. Box 190816
San Juan, PR 00919-0816
Tel: 1 (787) 620-7546

Client Service Information

When you call or write, please give us the following information:

- Vehicle Identification Number
 - ▣ **Vehicle Identification Number (VIN), Engine Number, and Transmission Number** P. 568
- Date of purchase
- Odometer reading of your vehicle
- Your name, address, and telephone number
- A detailed description of the problem
- Name of the dealer who sold the vehicle to you

■ Disclaimer of Pandora®

Requirements to access Pandora®

- Latest version of the Pandora app installed on your Android, Blackberry, or iPhone.
- Registered Pandora account (you can create a free account at www.pandora.com <<http://www.pandora.com/>> or on your smartphone)
- Connection to the internet via Wi-Fi or cellular data network.

Limitations

- Access to Pandora requires an active internet connection
- Ability to access Pandora through this system is subject to change without notice
- Certain functionality of Pandora service is not available when accessing the service through this system including, but not limited to, creating new stations, deleting stations, emailing current stations, buying tracks, viewing additional text information, logging in to Pandora, and adjusting Cell Network Audio Quality. Pandora internet radio is a music service not affiliated with HONDA. More information is available at <http://www.pandora.com> <<http://www.pandora.com/>>. Pandora, the Pandora logo, and the Pandora trade dress are trademarks or registered trademarks of Pandora Media, Inc., used with permission.
- Mobile access requires a smartphone with an active data plan. Standard data rates may apply.
- Pandora is only available in the United States.

A

- AAC 244, 252
- ABS (Anti-lock Brake System) 435
- Accessories and Modifications 514
- Accessory Power Sockets 195
- AcuraWatch™ 22
- Adaptive Cruise Control (ACC) with Low Speed Follow (LSF) 391
- Additives
 - Coolant 484
 - Engine Oil 477
 - Washer 487
- Additives, Engine Oil 477
- Adjusting
 - Armrest 187
 - Front Seats 179
 - Head Restraints 182
 - Mirrors 176
 - Steering Wheel 175
 - Temperature 117
- Agile Handling Assist 420
- Air Conditioning System (Climate Control System) 204
 - Changing the Mode 207
 - Defrosting the Windshield and Windows 210
 - Dust and Pollen Filter 508
 - Sensors 211
 - Synchronized Mode 208
 - Using Automatic Climate Control 204
- Air Pressure 496, 567
- Airbags 41
 - Advanced Airbags 47
 - Airbag Care 55
 - Driver's Knee Airbag 48
 - Event Data Recorder 0
 - Front Airbags (SRS) 44
 - Indicator 53, 79
 - Passenger Airbag Off Indicator 54
 - Sensors 41
 - Side Airbags 50
 - Side Curtain Airbags 52
- AM/FM Radio 230
- Ambient Light Off Switch 190
- Android Auto 262
- Anti-lock Brake System (ABS) 435
 - Indicator 79
- Apple CarPlay 258
- Armrest 187
- Audio Remote Controls 217
- Audio System 214
 - Adjusting the Sound 228
 - Auxiliary Input Jack 216
 - Error Messages 267
 - General Information 274
 - Internet Radio 250
 - iPhone 250, 276
 - iPod 247
 - MP3/WMA/AAC 244, 252
 - Reactivating 216
 - Recommended CDs 275
 - Recommended Devices 276
- Remote Controls 217
- Security Code 216
- Theft Protection 216
- USB Flash Drives 276
- USB Port 215
- Authorized Manuals 576
- Auto Door Locking/Unlocking 147
 - Customize 126, 304
- Auto High-Beam 165
- Auto Idle Stop 382
 - OFF Button 383
- Auto Idle Stop Indicator (Green) 89
- Auto Idle Stop System Indicator (Amber) 89
- Automatic Brake Hold 433
 - Indicator 74, 433
- Automatic Brake Hold System Indicator 74, 433
- Automatic Folding Door Mirror 178
- Automatic Lighting 162
- Automatic Transmission 370
 - Creeping 370
 - Kickdown 370
 - Operating the Shift Button 18, 372
 - Shifting 371
- Auxiliary Input Jack 216
- Average Fuel Economy 117
- Average Speed 118

B**Battery**

| | |
|--|---------|
| Charging (Battery) | 505 |
| Charging System Indicator | 75, 549 |
| Jump Starting | 542 |
| Maintenance (Checking the Battery) | 504 |

Belts (Seat) 34**Beverage Holders.....** 194**Blind Spot Information (BSI) System.....** 421**Bluetooth® Audio** 255**Bluetooth® HandsFreeLink®** 317**Booster Seats (For Children).....** 68**Brake System.....** 429

| | |
|-----------------------------------|-----|
| Anti-lock Brake System (ABS)..... | 435 |
| Automatic Brake Hold..... | 433 |
| Brake Assist System | 436 |
| Fluid | 487 |
| Foot Brake | 432 |
| Parking Brake | 429 |

Brake System (Amber)

| | |
|-----------------|----|
| Indicator | 72 |
|-----------------|----|

Brake System (Red)

| | |
|----------------|---------|
| Indicator..... | 72, 550 |
|----------------|---------|

Brightness Control (Instrument Panel) 171**BSI (Blind Spot Information) System.....** 421**Bulb Replacement.....** 488

| | |
|--|-----|
| Back-Up Lights..... | 491 |
| Brake/Taillights | 490 |
| Brake/Taillights and Rear Side Marker Lights..... | 490 |
| Fog Lights..... | 488 |

Front Side Marker/Parking Lights

Headlights.....

High-Mount Brake Light

Puddle Lights.....

Rear License Plate Lights.....

Rear Turn Signal Lights.....

Side Turn Signal/Emergency Indicator
Lights**Bulb Specifications** 566**C****Carbon Monoxide Gas** 69**Carrying Cargo** 357, 359**CD Player.....** 244**Center Pocket** 193**Certification Label.....** 568**Changing Bulbs** 488**Charging System Indicator.....** 75, 549**Child Safety.....** 56

Childproof Door Locks.....

Child Seat..... 56

Booster Seats

Child Seat for Infants.....

Child Seat for Small Children.....

Installing a Child Seat with a Lap/Shoulder
Seat Belt.....

Larger Children

Rear-facing Child Seat.....

Selecting a Child Seat.....

Using a Tether.....

Childproof Door Locks.....

Cleaning the Exterior.....

Cleaning the Interior

Client Service Information.....

Climate Control System 204

Changing the Mode.....

Defrosting the Windshield and
Windows

Dust and Pollen Filter

Sensors

Synchronized Mode

Using Automatic Climate Control.....

Clock 132**CMBS™ (Collision Mitigation Braking
System™)** 437**Coat Hooks** 199**Collision Mitigation Braking System™
(CMBS™)** 437**Compact Spare Tire (Optional)** 532, 567**Compass.....** 352**Console Compartment.....** 192**Controls** 131**Coolant (Engine)** 484

Adding to the Radiator

Adding to the Reserve Tank

Overheating.....

Creeping (Automatic Transmission)..... 370**Creeping (Dual Clutch Transmission).....** 370**Cross Traffic Monitor** 452**Cup Holders** 194**Customized Features** 120, 292

D

| | |
|---|----------|
| Daytime Running Lights | 164 |
| Dead Battery | 542 |
| Defrosting the Windshield and Windows | 210 |
| Devices that Emit Radio Waves | 569 |
| Dimming | |
| Headlights | 161 |
| Rearview Mirror | 176 |
| Dipstick (Engine Oil) | 478 |
| Directional Signals (Turn Signal) | 160 |
| Door Mirrors | 177 |
| Doors | 133 |
| Auto Door Locking | 147 |
| Auto Door Unlocking | 147 |
| Door Open Indicator | 33 |
| Door Open Message | 97 |
| Keys | 133 |
| Locking/Unlocking the Doors from the Inside | 13, 144 |
| Locking/Unlocking the Doors from the Outside | 136 |
| Lockout Prevention System | 142 |
| DOT Tire Quality Grading | 498 |
| Driver's Knee Airbag | 48 |
| Driving | 355 |
| Automatic Transmission | 370 |
| Braking | 429 |
| Dual Clutch Transmission | 370 |
| Shifting Gear | 371, 378 |
| Starting the Engine | 362 |

| | |
|--------------------------------------|---------|
| Driving Position Memory System | 173 |
| Dual Clutch Transmission | 370 |
| Creeping | 370 |
| Fluid | 486 |
| Kickdown | 370 |
| Operating the Shift Lever | 20, 379 |
| Shift Lever Does Not Move | 546 |
| Shifting | 378 |
| Dust and Pollen Filter | 508 |

E

| | |
|---|---------|
| ECON (Econ mode) Indicator | 85 |
| Elapsed Time | 118 |
| Electric Parking Brake | |
| Indicator | 73 |
| Electric Parking Brake System | |
| Indicator | 73, 552 |
| Electric Power Steering (EPS) System | |
| Indicator | 79, 551 |
| Electronic Stability Control (ESC) | 418 |
| Emergency | 560 |
| Emissions Testing (Readiness Codes) | 572 |
| Engine | 568 |
| Coolant | 484 |
| Jump Starting | 542 |
| Oil | 477 |
| Remote Engine Start | 365 |
| Starting | 362 |
| Engine Coolant | 484 |
| Adding to the Radiator | 485 |

| | |
|--|---------|
| Adding to the Reserve Tank | 484 |
| Overheating | 547 |
| Temperature Gauge | 113 |
| Engine Oil | 477 |
| Adding | 480 |
| Checking | 478 |
| Displaying Oil Life | 470 |
| Low Oil Pressure Indicator | 74, 549 |
| Recommended Engine Oil | 477 |
| ENGINE START/STOP Button | 157 |
| EPS (Electric Power Steering) System | 79 |
| Exhaust Gas Hazard (Carbon Monoxide) .. | 69 |
| Exterior Care (Cleaning) | 511 |
| Exterior Mirrors | 177 |

F

| | |
|--------------------------------|-----|
| Features | 213 |
| Filters | |
| Dust and Pollen | 508 |
| Oil | 481 |
| Flat Tire | 519 |
| Floor Mats | 510 |
| Fluids | |
| Automatic Transmission | 486 |
| Brake | 487 |
| Dual Clutch Transmission | 486 |
| Engine Coolant | 484 |
| Windshield Washer | 487 |
| Fog Lights | 164 |
| Foot Brake | 432 |

- Front Airbags (SRS)** 44
Front Seat Heaters and Ventilation 202
Front Seats 179
 Adjusting 179
Front Sensor Camera 389
Fuel 21, 460
 Economy 463
 Gauge 113
 Instant Fuel Economy 118
 Low Fuel Indicator 78
 Range 118
 Recommendation 460, 566
 Refueling 460
Fuel Economy 463
Fuel Fill Door 21, 461
Fuses 555
 Inspecting and Changing 559
 Locations 555, 556, 557, 558
- G**
- Gasoline (Fuel)**
 Economy 463
 Gauge 113
 Information 460
 Instant Fuel Economy 118
 Low Fuel Indicator 78
 Refueling 460
Gauges 113
Gear Position Indicator 75, 372
- Gear Shift Lever Positions**
 Dual Clutch Transmission 378
- Gear Shift Positions**
 Automatic Transmission 371
- Glass (care)** 510, 512
Glove Box 191
- H**
- Handling the Unexpected** 517
HandsFreeLink® (HFL) 317
 Auto Answer 333
 Automatic Import of Cellular Phonebook
 and Call History 335
 Automatic Transferring 333
 Displaying Messages 348
 HFL Buttons 317
 HFL Menu 320
 HFL Status Display 318
 Limitations for Manual Operation 319
 Making a Call 339
 Options During a Call 345
 Phone Setup 325
 Receiving a Call 344
 Receiving a Text/E-mail Message 346
 Ring Tone 334
 Selecting a Mail Account 347
 Speed Dial 336
 To Create a Security PIN 332
 To Set Up a Text/E-mail Message
 Option 330
- Use Contact Photo 334
Hazard Warning Button 4
Head Restraints 182
Headlight Washers 170
Headlights 161
 Aiming 488
 Auto High-Beam System 165
 Automatic Operation 162
 Dimming 161, 164
 Operating 161
Heated Steering Wheel 201
Heaters (Seat) 202, 203
HFL (HandsFreeLink®) 317
High Beam Indicator 82
Hill Start Assist System 368
HomeLink® Universal Transceiver 314
Honda App License Agreement 277
- I**
- Identification Numbers** 568
 Vehicle Identification Number (VIN),
 Engine Number and Transmission
 Number 568
Illumination Control 171
Immobilizer System 151
 Indicator 83
Indicators 72
 Adaptive Cruise Control (ACC)
 with Low Speed Follow (LSF) 85, 86, 391
 Anti-lock Brake System (ABS) 79

| | |
|--|--------------|
| Auto High-Beam..... | 82 |
| Auto Idle Stop (Green)..... | 89 |
| Auto Idle Stop System (Amber)..... | 89 |
| Automatic Brake Hold..... | 74, 433 |
| Automatic Brake Hold System..... | 74, 433 |
| Blind Spot Information (BSI)..... | 88 |
| Brake System (Amber)..... | 72 |
| Brake System (Red)..... | 72, 550 |
| Charging System..... | 75, 549 |
| Collision Mitigation Braking System™ (CMBS™)..... | 90, 91 |
| Door and Trunk Open..... | 33 |
| ECON (Econ mode)..... | 85 |
| Electric Parking Brake..... | 73 |
| Electric Parking Brake System..... | 73, 552 |
| Electric Power Steering (EPS) System..... | 79, 551 |
| Fog Lights..... | 82 |
| Gear Position..... | 75 |
| High Beam..... | 82 |
| Immobilizer System..... | 83 |
| Keyless Access System..... | 83 |
| Lane Keeping Assist System (LKAS) ... | 87, 412 |
| Lights On..... | 82 |
| Low Fuel..... | 78 |
| Low Oil Pressure..... | 74, 549 |
| Low Tire Pressure/TPMS..... | 81, 425, 427 |
| M (sequential mode) Indicator/Sequential Mode Gear Selection..... | 78 |
| Malfunction Indicator Lamp..... | 75, 550 |

| | |
|--|----------|
| Precision All-Wheel Steer™ (P-AWS®) System..... | 85 |
| Road Departure Mitigation (RDM)..... | 84 |
| Seat Belt Reminder..... | 35, 78 |
| Security System Alarm..... | 83 |
| Shift Lever Position..... | 75 |
| SPORT (Sport mode)..... | 85 |
| Super Handling-All Wheel Drive™ (SH-AWD®)..... | 89 |
| Supplemental Restraint System..... | 53, 79 |
| System Message..... | 81 |
| Transmission System..... | 76, 77 |
| Turn Signal..... | 82 |
| Vehicle Stability Assist (VSA®) System..... | 80, 418 |
| VSA® OFF..... | 80, 419 |
| Information | 565 |
| Information Screen | 223 |
| Instant Fuel Economy | 118 |
| Instrument Panel | 71 |
| Brightness Control..... | 171 |
| Integrated Dynamics System | 388 |
| Dynamic Mode Button..... | 388 |
| Interface Dial | 219 |
| Interior Lights | 188 |
| Interior Rearview Mirror | 176 |
| Internet Radio | 250 |
| iPhone | 250, 276 |
| iPod | 247, 276 |

J

| | |
|--------------------------------------|-----|
| Jack (Wheel Nut Wrench) | 535 |
| Jump Starting | 542 |

K

| | |
|--|----------|
| Key Number Tag | 135 |
| Keyless Access System | 136 |
| Keyless Lockout Prevention | 142 |
| Keys | 133 |
| Lockout Prevention..... | 142 |
| Number Tag..... | 135 |
| Rear Door Won't Open..... | 146 |
| Remote Transmitter..... | 141 |
| Two-way Keyless Access Remote..... | 143, 365 |
| Types and Functions..... | 133 |
| Kickdown (Automatic Transmission) | 370 |
| Kickdown (Dual Clutch Transmission) | 370 |

L

| | |
|---|-----|
| Lane Keeping Assist System (LKAS) | 410 |
| Language (HFL) | 318 |
| LATCH (Child Seats) | 61 |
| Legal Information on Apple CarPlay/ Android Auto | 289 |

| | |
|--|----------|
| Lights | 161, 488 |
| Automatic | 162 |
| Bulb Replacement | 488 |
| Daytime Running Lights | 164 |
| Fog Lights | 164 |
| High Beam Indicator | 82 |
| Interior | 188 |
| Light Switches | 161 |
| Lights On Indicator | 82 |
| Turn Signals | 160 |
| Load Limits | 359 |
| Locking/Unlocking | 133 |
| Auto Door Locking/Unlocking | 147 |
| Childproof Door Locks | 146 |
| From Inside | 144 |
| From Outside | 136 |
| Keys | 133 |
| Using a Key | 142 |
| Lockout Prevention System | 142 |
| Low Battery Charge | 549 |
| Low Fuel Indicator | 78 |
| Low Keyless Access Remote Signal Strength | 135 |
| Low Oil Pressure Indicator | 74, 549 |
| Lower Anchors | 61 |
| Lubricant Specifications Chart | 567 |
| Luggage (Maximum Load Limit) | 359 |
| Lumbar Support | 179 |

M

| | |
|---------------------------------------|----------|
| Maintenance | 465 |
| Battery | 504 |
| Brake Fluid | 487 |
| Cleaning | 509 |
| Climate Control System | 508 |
| Coolant | 484 |
| Maintenance Minder™ | 469 |
| Oil | 478 |
| Precautions | 466 |
| Radiator | 485 |
| Remote Transmitter | 506, 507 |
| Replacing Light Bulbs | 488 |
| Safety | 467 |
| Service Items | 472 |
| Tires | 495 |
| Transmission Fluid | 486 |
| Under the Hood | 474, 475 |
| Malfunction Indicator Lamp | 75, 550 |
| Map Lights | 189 |
| Maximum Load Limit | 359 |
| Meters, Gauges | 113 |
| Mirrors | 176 |
| Adjusting | 176 |
| Door | 177 |
| Exterior | 177 |
| Interior Rearview | 176 |
| Modifications (and Accessories) | 514 |
| Moonroof | 156 |
| MP3 | 244, 252 |
| Multi-Information Display | 114 |

| | |
|------------------------------|-----|
| Multi-View Rear Camera | 457 |
|------------------------------|-----|

N

| | |
|--------------------------------|-----|
| Numbers (Identification) | 568 |
|--------------------------------|-----|

O

| | |
|---|----------|
| Odometer | 117 |
| Oil (Engine) | 477, 567 |
| Adding | 480 |
| Checking | 478 |
| Displaying Oil Life | 470 |
| Low Oil Pressure Indicator | 74, 549 |
| Recommended Engine Oil | 477, 567 |
| Viscosity | 477, 567 |
| On Demand Multi-Use Display™ | 220 |
| Open Source Licenses | 291 |
| Opening | |
| Trunk | 562 |
| Opening/Closing | |
| Hood | 476 |
| Moonroof | 156 |
| Power Windows | 154 |
| Trunk | 148 |
| Operating the Switches Around the Steering Wheel | 157 |
| Outside Temperature | 117 |
| Adjusting | 117 |
| Overheating | 547 |

P

| | |
|---|-----|
| Paddle Shifters (Sequential Mode) | 377 |
| Paddle Shifters (Sequential Shift Mode) | 381 |
| Panic Mode | 153 |
| Parking | 446 |
| Parking Brake | 429 |
| Parking Sensor System | 448 |
| Passenger Airbag Off Indicator | 54 |
| Passing Indicators | 161 |
| Power Windows | 154 |
| Precautions While Driving | 369 |
| Rain | 369 |
| Pregnant Women | 39 |
| Puncture (Tire) | 519 |

R

| | |
|---|-----|
| Radiator | 485 |
| Radio (AM/FM) | 230 |
| Radio (SiriusXM®) | 233 |
| Radio Data System (RDS) | 231 |
| Range | 118 |
| RDS (Radio Data System) | 231 |
| Readiness Codes (Emissions Testing) | 572 |
| Rear Defogger/Heated Door Mirror Button | 172 |
| Rear Seats | 186 |
| Seat Heaters | 203 |
| Rearview Mirror | 176 |

| | |
|---|--------------------|
| Refueling | 460 |
| Fuel Gauge | 113 |
| Gasoline | 460, 566 |
| Low Fuel Indicator | 78 |
| Regulations | 427, 498, 569 |
| Remote Engine Start with Vehicle Feedback | 365 |
| Remote Transmitter | 141 |
| Maintenance (Replacing) | 506 |
| Replacement | |
| Battery | 506, 507 |
| Bulbs | 488 |
| Fuses | 555, 556, 557, 558 |
| Tires | 501 |
| Wiper Blade Rubber | 493 |
| Reporting Safety Defects | 571 |
| Resetting a Trip Meter | 117 |
| Reverse Tilt Door Mirror | 177 |
| Right Selector Wheel | 115, 120 |
| Road Departure Mitigation (RDM) | 405 |
| On and Off | 407 |

S

| | |
|--------------------------------------|----|
| Safe Driving | 29 |
| Safety Labels | 70 |
| Safety Message | 1 |
| Seat Belts | 34 |
| Adjusting the Shoulder Anchor | 38 |
| Automatic Seat Belt Tensioners | 36 |
| Checking | 40 |

| | |
|---|----------|
| Fastening | 37 |
| Installing a Child Seat with a Lap/Shoulder Seat Belt | 63 |
| Pregnant Women | 39 |
| Reminder | 35, 78 |
| Warning Indicator | 35, 78 |
| Seat Heaters | 202, 203 |
| Seats | 179 |
| Adjusting | 179 |
| Driver's Seat Lumbar Support | 179 |
| Front Seats | 179 |
| Rear Seats | 186 |
| Seat Heaters | 202, 203 |
| Seat Ventilation | 202 |
| Thigh support | 180 |
| Security System | 151 |
| Immobilizer System Indicator | 83 |
| Security System Alarm Indicator | 83 |
| Select Button | 371 |
| Operation | 372 |
| Select Lever | 20, 378 |
| Operation | 20, 379 |
| Releasing | 546 |
| Won't Move | 546 |
| Selecting a Child Seat | 60 |
| Sequential Mode | 376 |
| Sequential Mode Operation | 377 |
| Sequential Shift Mode | 380 |
| Sequential Shift Mode Operation | 381 |
| Setting the Clock | 132 |

| | |
|--|------------------|
| SH-AWD® (Super Handling-All Wheel Drive™)..... | 424 |
| SH-AWD® Torque Distribution Monitor .. | 119 |
| Shift Button..... | 18, 371 |
| Shift Lever | 20, 378 |
| Shift Lever Position Indicator..... | 379 |
| Shifting (Transmission) | 18, 20, 371, 378 |
| Shoulder Anchor..... | 38 |
| Side Airbags | 50 |
| Side Curtain Airbags..... | 52 |
| SiriusXM® Radio | 233 |
| Snow Tires..... | 503 |
| Spare Tire (Optional) | 532, 567 |
| Spark Plugs..... | 566 |
| Specifications | 566 |
| Specified Fuel..... | 460, 566 |
| SPORT (Sport mode) Indicator | 85 |
| Sport Mode | 388 |
| Sport+ Mode | 388 |
| SRS Airbags (Airbags) | 44 |
| Starting Assist Brake Function | 387 |
| Starting the Engine | 362 |
| Does Not Start..... | 539 |
| Engine Switch Buzzer..... | 159 |
| Jump Starting | 542 |
| Remote Engine Start | 365 |
| Steering Wheel | 175 |
| Adjusting..... | 175 |
| Stopping | 446 |
| Summer Tires | 503 |

| | |
|---|-----------|
| Super Handling-All Wheel Drive™ (SH-AWD®) | 424 |
| Indicator..... | 89 |
| Supplemental Restraint System (SRS)..... | 44 |
| Surround View Camera System | 459 |
| Switches (Around the Steering Wheel) | 4, 5, 157 |
| System Message Indicator..... | 81 |

T

| | |
|---|----------|
| Temperature Gauge | 113 |
| Temperature Sensor..... | 211 |
| Temporary Tire Repair Kit | 520 |
| Text Message | 346, 348 |
| Time (Setting)..... | 132 |
| Tire Fill Assist | 425 |
| Tire Pressure Monitoring System (TPMS) with Tire Fill Assist..... | 425 |
| Indicator..... | 81, 553 |
| Tire Fill Assist..... | 425 |
| Tire Repair Kit..... | 519 |
| Tires..... | 495 |
| Air Pressure | 496, 567 |
| Chains..... | 503 |
| Checking and Maintaining | 495 |
| Flat Tire (Puncture) | 519, 532 |
| Inspection | 495 |
| Labeling | 496 |
| Puncture (Flat Tire) | 519, 532 |
| Regulations | 498 |

| | |
|--|--------------------|
| Rotation..... | 502 |
| Spare (Optional)..... | 532, 567 |
| Summer..... | 503 |
| Temporary Tire Repair Kit..... | 520 |
| Wear Indicators..... | 500 |
| Winter | 503 |
| Tools | 518 |
| Towing a Trailer..... | 361 |
| Towing Your Vehicle | 361 |
| Emergency..... | 560 |
| TPMS (Tire Pressure Monitoring System) with Tire Fill Assist | 425 |
| Indicator | 81, 553 |
| Tire Fill Assist | 425 |
| Transmission..... | 18, 20, 371, 378 |
| Automatic..... | 18, 370, 371 |
| Dual Clutch..... | 20, 370, 378 |
| Fluid | 486 |
| Gear Position Indicator..... | 75, 372 |
| Number | 568 |
| Sequential Mode..... | 376 |
| Sequential Shift Mode..... | 380 |
| Shift Lever Position Indicator | 379 |
| TRIP Button | 116 |
| Trip Meter | 117 |
| Troubleshooting | 517 |
| Blown Fuse | 555, 556, 557, 558 |
| Brake Pedal Vibrates | 25 |
| Buzzer Sounds When Opening Door | 26 |
| Emergency Towing | 560 |
| Engine Won't Start | 539 |

| | |
|---|----------|
| Flat Tire/Puncture | 519 |
| Noise When Braking | 27 |
| Overheating | 547 |
| Premium Gasoline..... | 460, 566 |
| Puncture/Flat Tire | 519, 532 |
| Rear Door Won't Open | 25, 146 |
| Select Lever Won't Move | 546 |
| Warning Indicators..... | 72 |
| Trunk | 148 |
| Lid | 148 |
| Light Bulbs..... | 566 |
| Main Switch..... | 150 |
| Open Message..... | 97 |
| Unable to Open | 562 |
| Turn Signals | 160 |
| Indicators (Instrument Panel) | 82 |
| Turn-by-Turn Directions | 118 |
| Two-way Keyless Access Remote | 143, 365 |

U

| | |
|---|---------|
| Under-Floor Storage Area | 200 |
| Unlocking the Doors..... | 136 |
| Unlocking the Front Doors from the Inside..... | 13, 144 |
| USB Flash Drives | 276 |
| USB Port..... | 215 |
| Using the Keyless Access System | 136 |

V

| | |
|--|----------|
| Valet Mode | 150 |
| Vanity Mirrors | 7 |
| Vehicle Identification Number | 568 |
| Vehicle Stability Assist (VSA®) | 418 |
| Off Button | 419 |
| Off Indicator | 80, 419 |
| System Indicator | 80, 418 |
| Viscosity (Oil) | 477, 567 |
| VSA® (Vehicle Stability Assist) | 418 |

W

| | |
|---|----------|
| Wallpaper | 226 |
| Warning and Information Messages | 92 |
| Warning Indicator On/Blinking | 549 |
| Warning Labels | 70 |
| Warranties (Warranty Manual provided separately) | 574 |
| Watts | 566 |
| Wear Indicators (Tire) | 500 |
| Wheel Nut Wrench (Jack Handle) | 535 |
| Window Washers | 168 |
| Adding/Refilling Fluid..... | 487 |
| Switch | 168 |
| Windows (Opening and Closing) | 154 |
| Windshield | |
| Cleaning..... | 510, 512 |
| Defrosting/Defogging | 210 |
| Washer Fluid | 487 |
| Wiper Blades | 493 |

| | |
|--|----------|
| Wipers and Washers..... | 168 |
| Winter Tires | 503 |
| Snow Tires | 503 |
| Tire Chains..... | 503 |
| Wipers and Washers | 168 |
| Checking and Replacing Wiper Blades..... | 493 |
| Wireless Charger | 196 |
| WMA | 244, 252 |
| Worn Tires | 495 |



31TZ3630
OM-05652
00X31-TZ3-6300

owners.acura.com

2018 Acura TLX Owner's Manual
©2017 Honda Motor Co., Ltd. — All Rights Reserved

Printed in U.S.A.