

2014 ILX

Online Reference Owner's Manual

This owner's manual should be considered a permanent part of the vehicle and should remain with the vehicle when it is sold.





This owner's manual covers all models of your vehicle. You may find descriptions of equipment and features that are not on your particular model.

Images throughout this owner's manual (including the front cover) represent features and equipment that are available on some, but not all, models. Your particular model may not have some of these features.

This owner's manual is for vehicles sold in the United States and Canada.

The information and specifications included in this publication were in effect at the time of approval for printing. Honda Motor Co., Ltd. reserves the right, however, to discontinue or change specifications or design at any time without notice and without incurring any obligation.

Navigation Key

	Quick Reference Guide
	Chapter Table of Contents
	Index
	Book Table of Contents

➤ Safe Driving P. 21

For Safe Driving P. 22

Seat Belts P. 26

Airbags P. 33

➤ Instrument Panel P. 63

Indicators P. 64

Gauges and Multi-Information Display P. 78

➤ Controls P. 91

Setting the Clock P. 92

Locking and Unlocking the Doors P. 93

Opening and Closing the Moonroof P. 111

Adjusting the Seats P. 123

➤ Features P. 141

Audio System P. 142

Audio System Basic Operation P. 145

HomeLink® Universal Transceiver* P. 177

➤ Driving P. 209

Before Driving P. 210

Towing a Trailer P. 215

Multi-View Rear Camera P. 242

Refueling P. 243

➤ Maintenance P. 247

Before Performing Maintenance P. 248

Maintenance Minder™ P. 251

Checking and Maintaining Wiper Blades P. 284

Climate Control System Maintenance P. 297

➤ Handling the Unexpected P. 303

Tools P. 304

If a Tire Goes Flat P. 305

Overheating P. 318

Indicator, Coming On/Blinking P. 320

➤ Information P. 329

Specifications P. 330

Identification Numbers P. 334

Emissions Testing P. 337

Warranty Coverages P. 339

Contents

2014 ILX

Child Safety [P. 48](#)

Exhaust Gas Hazard [P. 60](#)

Safety Labels [P. 61](#)

Opening and Closing the Trunk [P. 102](#)

Security System [P. 106](#)

Opening and Closing the Windows [P. 108](#)

Operating the Switches Around the Steering Wheel [P. 112](#)

Adjusting the Mirrors [P. 121](#)

Interior Lights/Interior Convenience Items [P. 131](#)

Climate Control System [P. 136](#)

Audio Error Messages* [P. 170](#)

General Information on the Audio System [P. 173](#)

Bluetooth® HandsFreeLink® [P. 179](#)

When Driving [P. 216](#)

Braking [P. 237](#)

Parking Your Vehicle [P. 241](#)

Fuel Economy [P. 245](#)

Accessories and Modifications [P. 246](#)

Maintenance Under the Hood [P. 256](#)

Replacing Light Bulbs [P. 274](#)

Checking and Maintaining Tires [P. 286](#)

Battery [P. 295](#)

Remote Transmitter Care [P. 296](#)

Cleaning [P. 298](#)

Engine Does Not Start [P. 311](#)

Jump Starting [P. 314](#)

Shift Lever Does Not Move [P. 317](#)

Fuses [P. 324](#)

Emergency Towing [P. 327](#)

Devices that Emit Radio Waves [P. 335](#)

Reporting Safety Defects [P. 336](#)

Authorized Manuals [P. 341](#)

Client Service Information [P. 342](#)

Quick Reference Guide [P. 2](#)

Safe Driving [P. 21](#)

Instrument Panel [P. 63](#)

Controls [P. 91](#)

Features [P. 141](#)

Driving [P. 209](#)

Maintenance [P. 247](#)

Handling the Unexpected [P. 303](#)

Information [P. 329](#)

Index [P. 343](#)

Navigation Key

QRG

Quick Reference Guide

Index

Index

TOC

Chapter Table of Contents

Home

Book Table of Contents

Visual Index

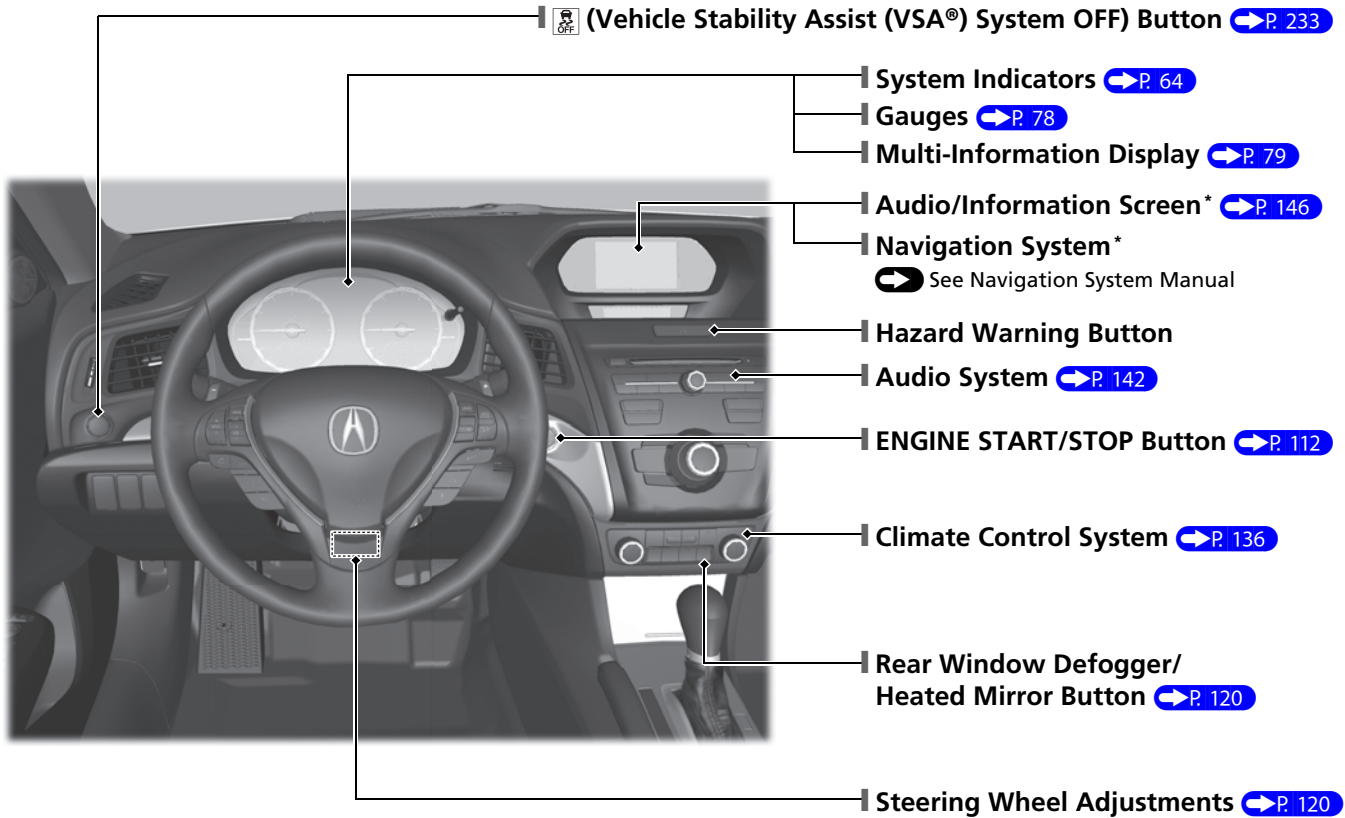

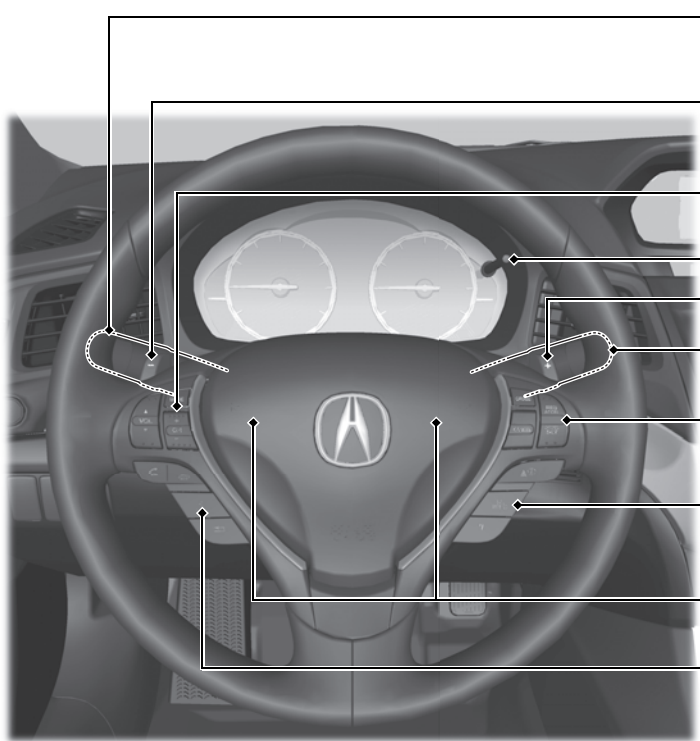

- Headlights/Turn Signals ➔ P. 114
- Fog Lights* ➔ P. 117
- Paddle Shifter (Shift down)* ➔ P. 225
- Remote Audio Control Buttons ➔ P. 149
- Brightness Control ➔ P. 119
- Paddle Shifter (Shift up)* ➔ P. 225
- Wipers/Washers ➔ P. 118
- Cruise Control Buttons ➔ P. 229
- SEL/RESET Button ➔ P. 79
- ▲ ⓘ / ▼ (Information) Button ➔ P. 79
- Horn (Press an area around 📢.)
- Navigation System Voice Control Buttons*
➔ See Navigation System Manual
- Bluetooth® HandsFreeLink® System
Voice Control Buttons ➔ P. 179

Visual Index

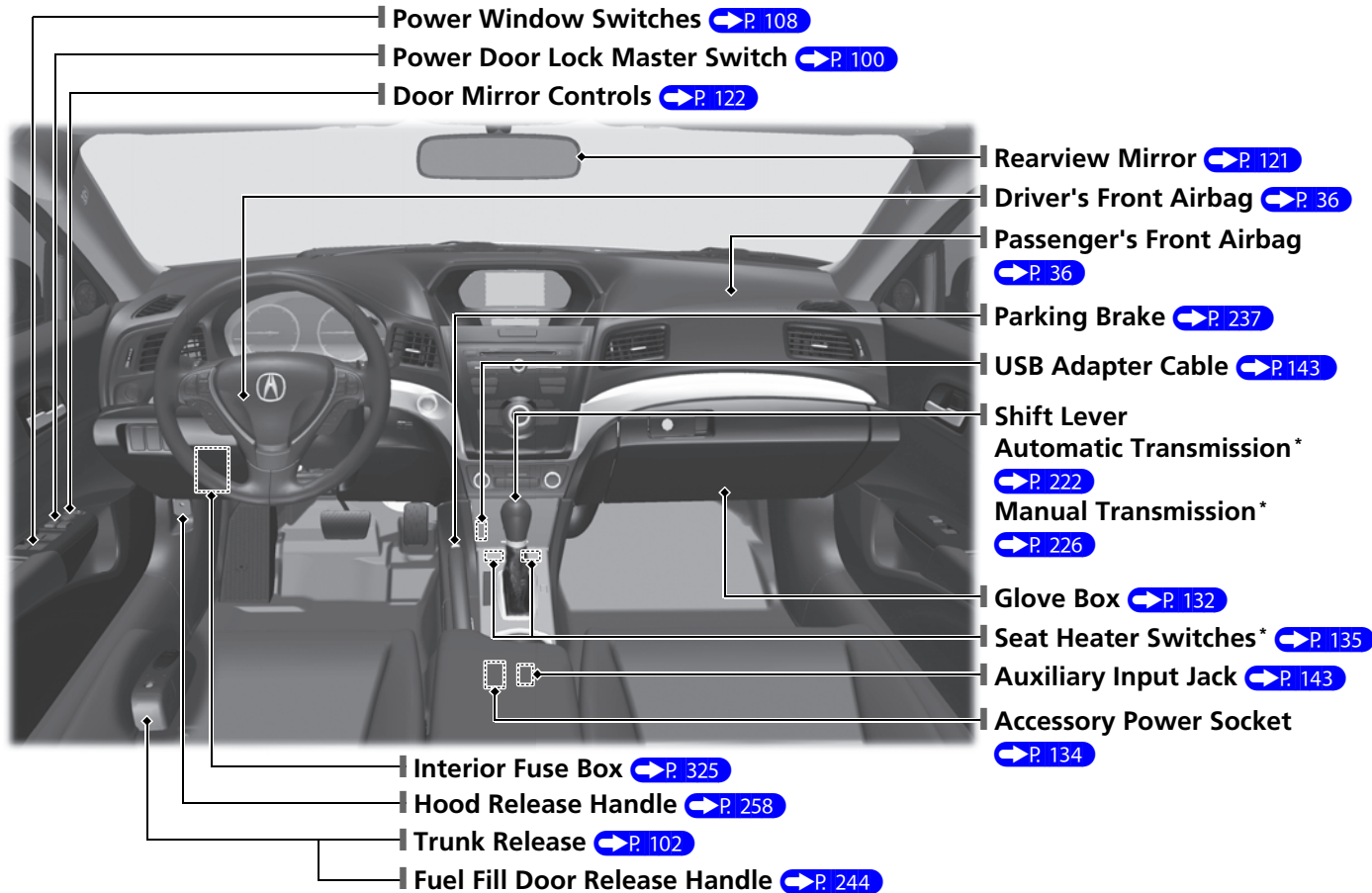

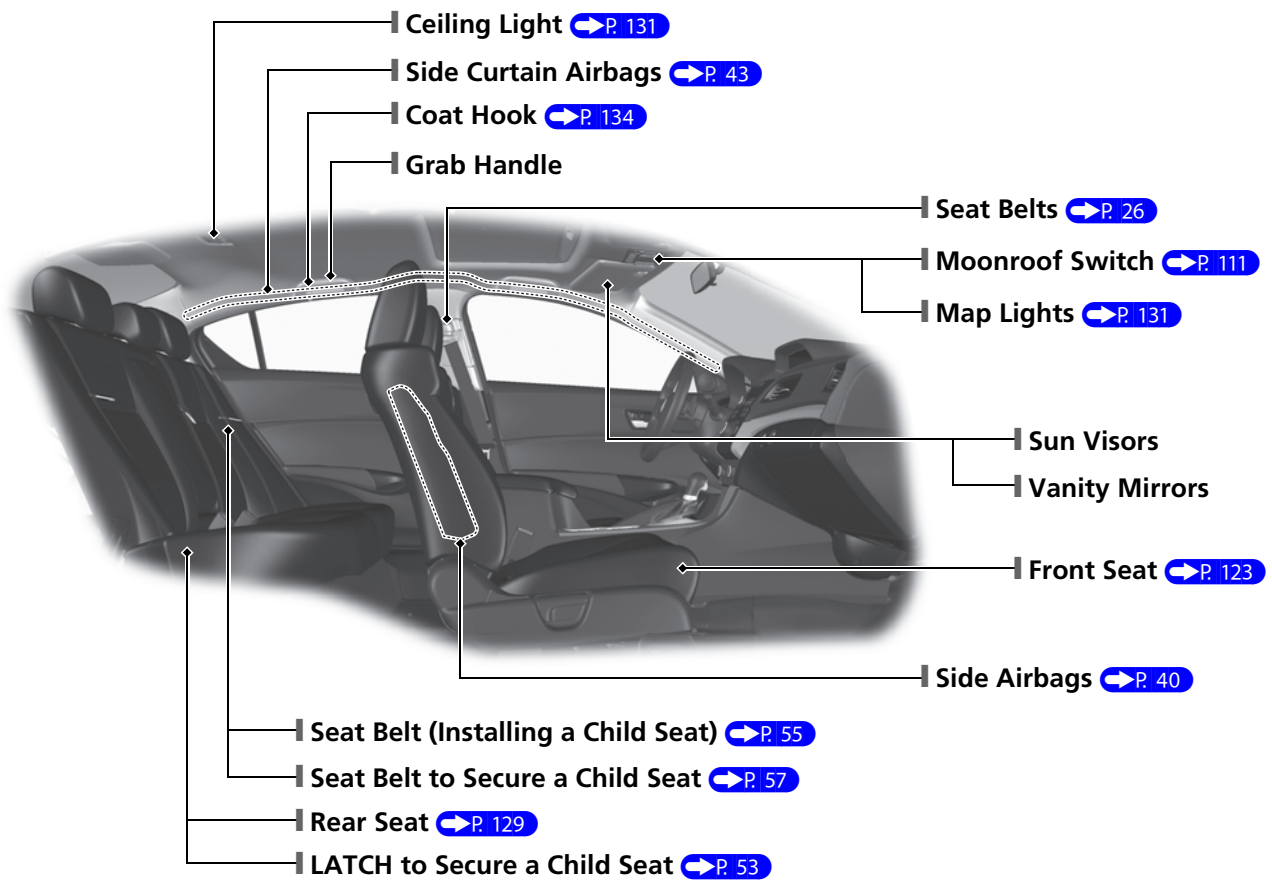

Visual Index

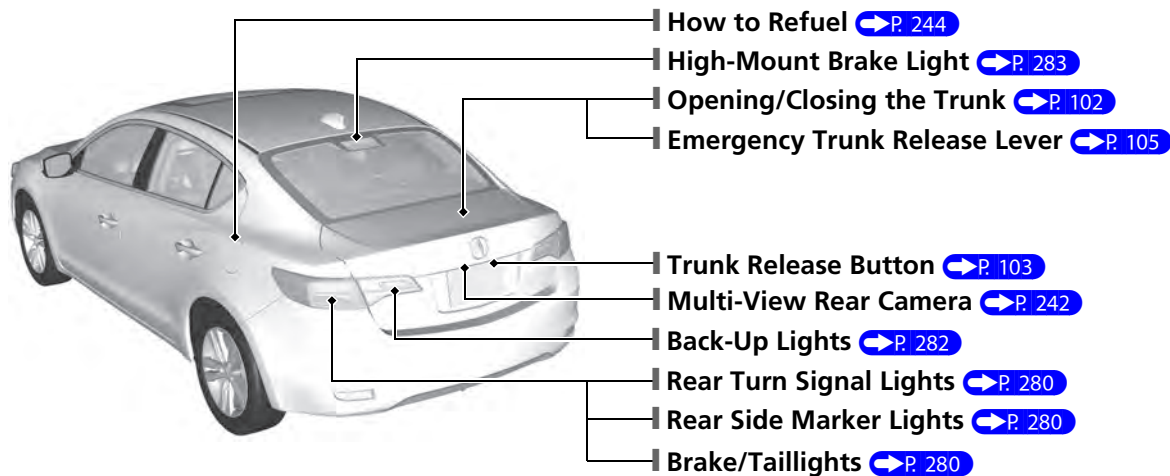
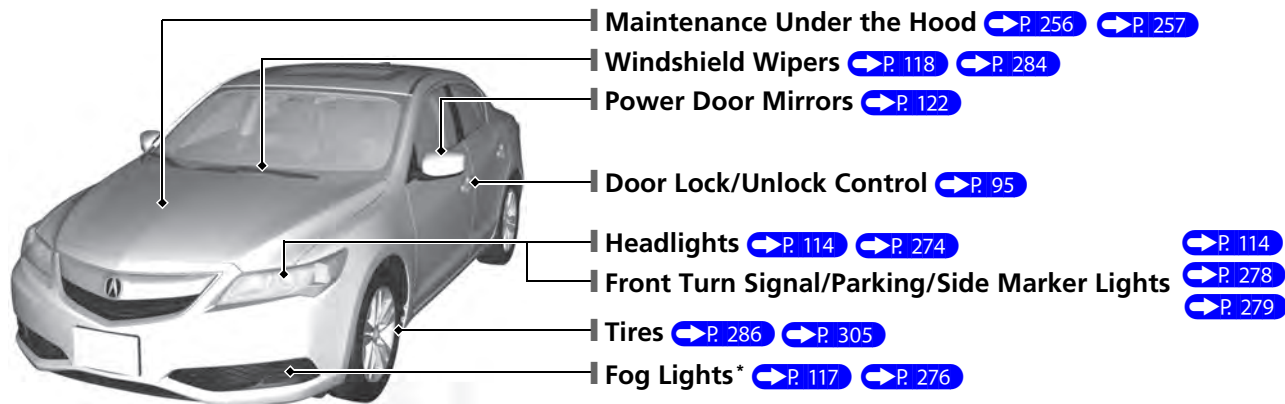

Safe Driving [P. 21](#)

QRG

Quick Reference Guide - 2014 LX

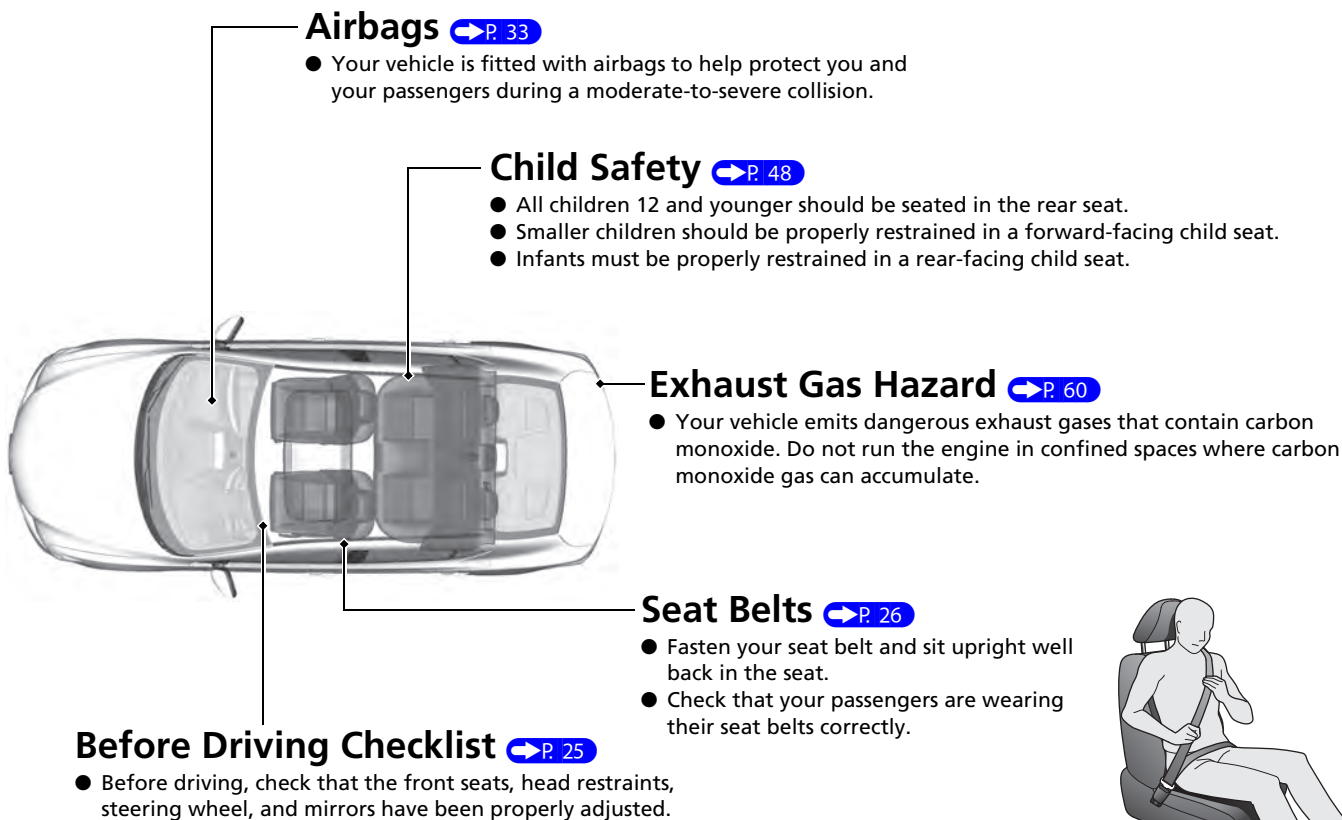

Fasten your lap belt as low as possible.











Index

Home

Instrument Panel ➔ P. 63



Gauges ➔ P. 78 / Multi-Information Display ➔ P. 79 / System Indicators ➔ P. 64

System Indicators

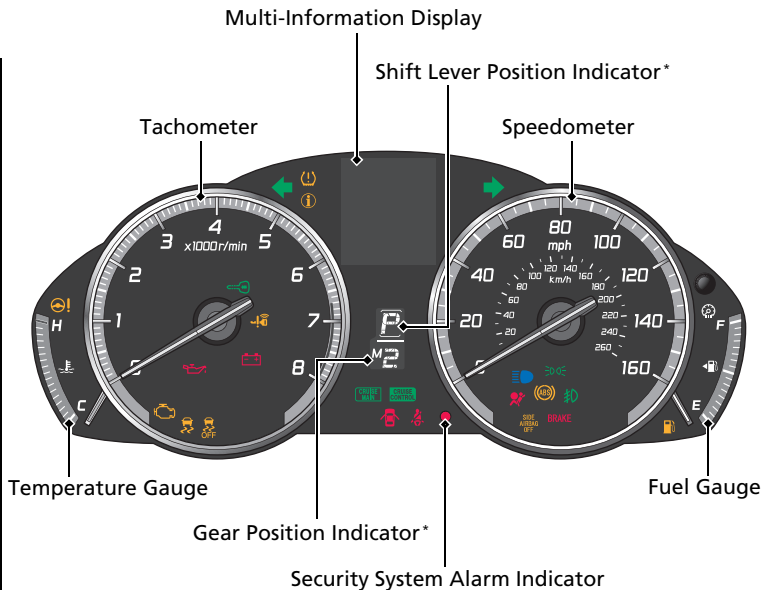









-  Malfunction Indicator Lamp
-  Low Oil Pressure Indicator
-  Charging System Indicator
-  Anti-lock Brake System (ABS) Indicator
-  Vehicle Stability Assist (VSA®) System Indicator
-  VSA® OFF Indicator
-  Door and Trunk Open Indicator
-  Immobilizer System Indicator
-  **BRAKE**
U.S. Parking Brake and Brake System Indicator
-  **BRAKE**
Canada Parking Brake and Brake System Indicator
-  Low Tire Pressure/TPMS Indicator



Lights Reminders

-  Lights On Indicator
-  High Beam Indicator
-  Fog Light Indicator*

System Indicators

-  Keyless Access System Indicator
-  Turn Signal and Hazard Warning Indicators
-  Electric Power Steering (EPS) System Indicator
-  Low Fuel Indicator
-  Seat Belt Reminder Indicator
-  Supplemental Restraint System Indicator
-  **SIDE AIRBAG OFF**
U.S. Side Airbag Off Indicator
-  **SIDE AIRBAG OFF**
Canada Side Airbag Off Indicator
-  **CRUISE MAIN** Indicator
-  **CRUISE CONTROL** Indicator
-  System Message Indicator

* Not available on all models

Controls ➔ P. 91

ENGINE START/STOP Button ➔ P. 112

Press the button to changes the vehicle's power mode.

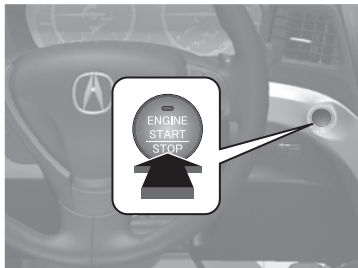

Turn Signals ➔ P. 114

Turn Signal Control Lever



Lights ➔ P. 114

Light Control Switches

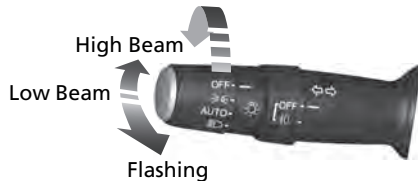

Wipers and Washers ➔ P. 118

Wiper/Washer Control Lever

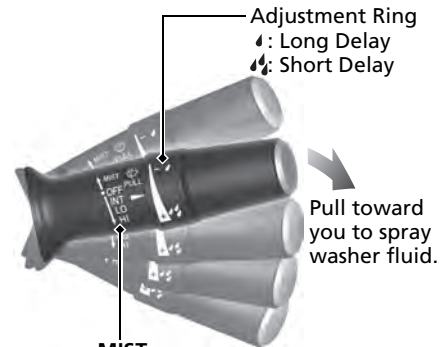

**MIST
OFF**

INT: Low speed with intermittent
LO: Low speed wipe
HI: High speed wipe

Steering Wheel ➔ P. 120

- To adjust, pull the adjustment lever towards you, adjust to the desired position, then lock the lever back in place.

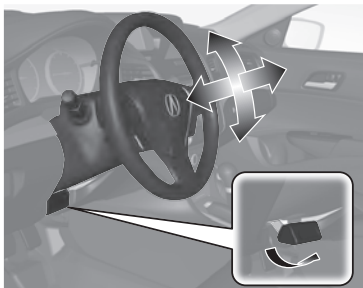

Unlocking the Front Doors from the Inside

➔ P. 99

- Pull either front door inner handle to unlock and open it at the same time.



Trunk ➔ P. 102

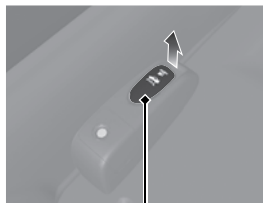

Trunk Release

- To unlock and open the trunk:
 - Pull the trunk release.
 - Press the trunk release button on the keyless access remote.
 - Press the trunk release button on the trunk lid.

Power Door Mirrors

➔ P. 122

- With the power mode in ON, move the selector switch to L or R.
- Push the appropriate edge of the adjustment switch to adjust the mirror.

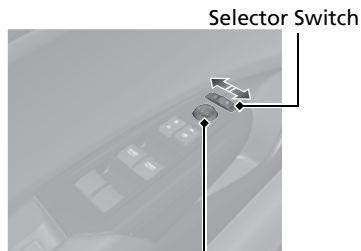

Selector Switch

Adjustment Switch

Power Windows ➔ P. 108

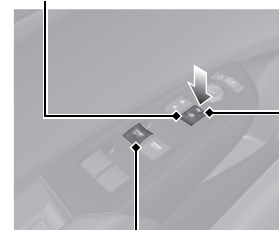

- With the power mode in ON, open and close the power windows.
- If the power window lock button is in the off position, each passenger's window can be opened and closed with its own switch.
- If the power window lock button is in the on position (indicator is on), each passenger's window switch is disabled.

Power Window Lock Button Indicator



Window Switch





Climate Control System P. 136

- Press the **AUTO** button to activate the climate control system.
- Press the  button to turn the system on or off.
- Press the  button to defrost the windshield.

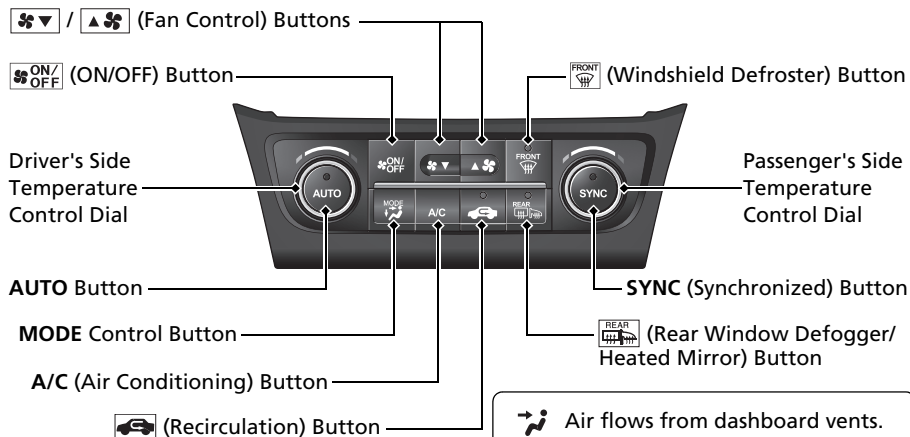
On models with navigation system

The climate control system is voice operable. See Navigation System Manual for complete details.



-  Air flows from dashboard vents.
-  Air flows from floor and dashboard vents.
-  Air flows from floor vents.
-  Air flows from floor and windshield defroster vents.

Clock P. 92

Models without navigation system

- 1 Press the **CLOCK (AUX)** button until the displayed time begins flashing.
- 2 Press Preset **[4]** (Hour) or **[5]** (Minute) to set the time. Press Preset **[6]** (Reset) to set the time to the nearest hour.
- 3 Press the **CLOCK** button again to set the time.

Models with navigation system

The navigation system receives signals from GPS satellites, updating the clock automatically.

Features [P. 141](#)

Audio system [P. 142](#) For navigation system operation

See Navigation System Manual

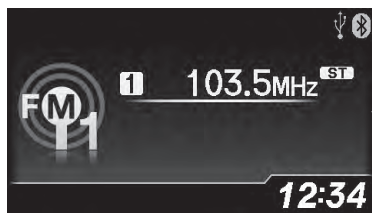

Audio/
Information Screen

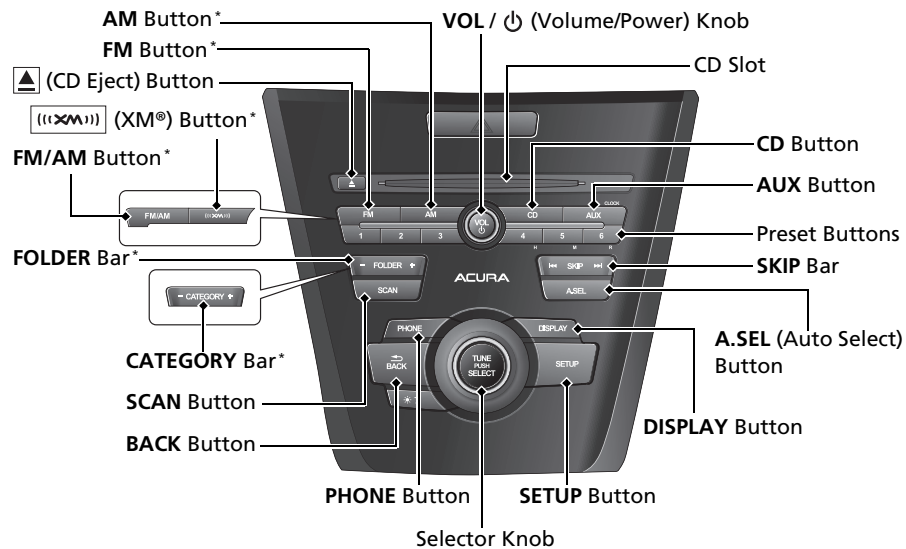

● Audio Remote Controls [P. 149](#)

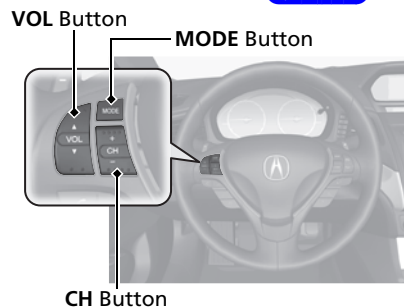

● VOL (Volume) Button

Press ▲ / ▼ to adjust the volume up/down.

● MODE Button

Press and release to change the audio mode: FM1/FM2/AM/XM1*/XM2*/CD/AUX.

● CH (Channel) Button

Radio: Press and release to change the preset station.
Press and hold to select the next or previous strong station.

CD/USB device:

Press and release to skip to the beginning of the next song or return to the beginning of the current song.
Press and hold to change a folder.

Driving → P. 209

Manual Transmission → P. 226

Automatic Transmission → P. 222

- Shift to **P** and depress the brake pedal when starting the engine.
- **Shifting**

P **Park**
Turn off or start the engine.
Transmission is locked.

R **Reverse**

N **Neutral**
Transmission is not locked.

D **Drive**
Normal driving. D-paddle shift mode can be used.

S **S Position**
Sequential shift mode can be used.

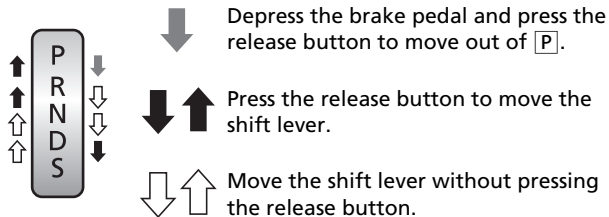

Paddle Shifters → P. 225

- Paddle shifters allow you to shift gears much like a manual transmission (1st through 5th). This is useful for engine braking.

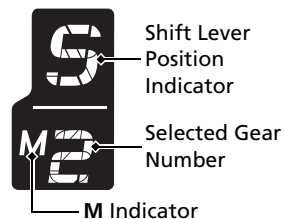

- **D-paddle shift mode:** The transmission will shift back to automatic mode once the system detects that the vehicle is cruising.
- **Sequential shift mode:** Holds the selected gear, and the **M** indicator comes on.
- The selected gear position is shown in the instrument panel.

Shift Down **-**
Paddle Shifter



Shift Up **+**
Paddle Shifter



VSA® OFF Button P. 233

- The vehicle stability assist (VSA®) system helps stabilize the vehicle during cornering, and helps maintain traction while accelerating on loose or slippery road surfaces.
- VSA® comes on automatically every time you start the engine.
- To turn VSA® on or off, press and hold the button until you hear a beep.

Cruise Control P. 229

- Cruise control allows you to maintain a set speed without keeping your foot on the accelerator pedal.
- To use cruise control, press the **CRUISE** button, then press **DECEL/SET** once you have achieved the desired speed (above 25 mph or 40 km/h).

Tire Pressure Monitoring System (TPMS) P. 234

U.S. models only

- TPMS monitors tire pressure.
- TPMS is turned on automatically every time you start the engine.

Refueling P. 243

Fuel recommendation: Unleaded premium gasoline with a pump octane number 91 or higher recommended

Fuel tank capacity: 13.2 US gal (50 L)

- 1** Push the fuel fill door release handle.

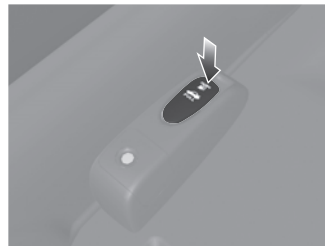

- 2** Turn the fuel fill cap slowly to remove the cap.

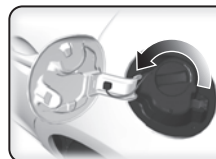

- 3** Place the cap in the holder on the fuel fill door.

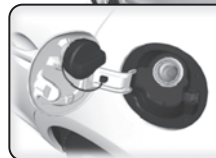

- 4** After refueling, screw the cap back on until it clicks at least once.



Maintenance [↔ P. 247](#)

Under the Hood [↔ P. 256](#) [↔ P. 257](#)

- Check engine oil, engine coolant, and windshield washer fluid. Add when necessary.
- Check brake fluid and clutch fluid.
- Check the battery condition monthly.

- 1 Pull the hood release handle under the corner of the dashboard.

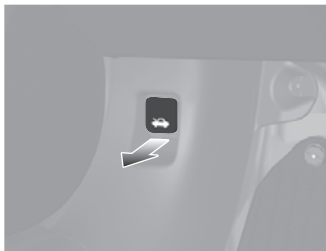

- 2 Locate the hood latch lever, slide the lever and lift the hood.



- 3 When finished, close the hood and make sure it is firmly locked in place.

Wiper Blades [↔ P. 284](#)

- Replace blades if they leave streaks across the windshield.



Tires [↔ P. 286](#)

- Inspect tires and wheels regularly.
- Check tire pressures regularly.
- Install snow tires for winter driving.

Lights [↔ P. 274](#)

- Inspect all lights regularly.

Handling the Unexpected ➔ P. 303

Flat Tire ➔ P. 305

- Park in a safe location and replace the flat tire with the compact spare tire in the trunk.



Engine Won't Start ➔ P. 311

- If the battery is dead, jump start using a booster battery.

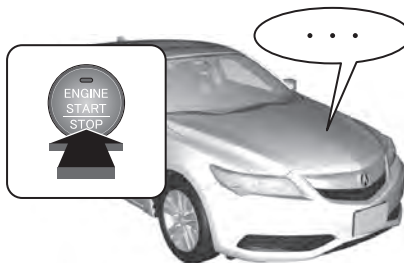

Overheating ➔ P. 318

- Park in a safe location. If you do not see steam under the hood, open the hood, and let the engine cool down.



Indicators Come On

➔ P. 320

- Identify the indicator and consult the owner's manual.



Blown Fuse ➔ P. 324

- Check for a blown fuse if an electrical device does not operate.

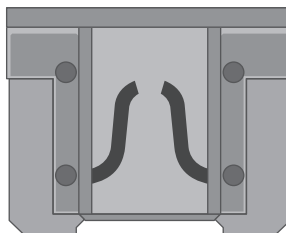

Emergency Towing

➔ P. 327

- Call a professional towing service if you need to tow your vehicle.



What to Do If

Q The power mode does not change from **VEHICLE OFF (LOCK)** to **ACCESSORY**. Why?

A

- The steering wheel may be locked.
- Move the steering wheel left and right after pressing the **ENGINE START/STOP** button.



Q The power mode does not change from **ON** to **VEHICLE OFF (LOCK)**. Why?

A The shift lever should be moved to **P**.



Q Why does the brake pedal pulsate slightly when applying the brakes?

A This can occur when the ABS activates, and does not indicate a problem. Apply firm, steady pressure on the brake pedal. Never pump the brake pedal.

Q The rear door cannot be opened from inside the vehicle. Why?

A Check if the childproof lock is in the **LOCK** position. If so, open the rear door with the outside door handle. To cancel this function, push the lever to the **UNLOCK** position.

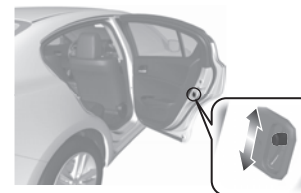

Q Why do the doors lock after I unlocked the doors using a remote transmitter?

A If you do not open the doors within 30 seconds, the doors are relocked automatically for security.

Q Why does the beeper sound when I open the driver's door?

A The beeper sounds when:

- The power mode is in ACCESSORY.
- The exterior lights are left on.

Q Why does the beeper sound when I start driving?

A The beeper sounds when:

- Driver and/or front passenger are not wearing their seat belts.
- The parking brake lever is not fully released.

Q Why do I hear a screeching sound when I apply the brake pedal?

A The brake pads may need to be replaced. Have your vehicle inspected by a dealer.

Q Is it possible to use unleaded gasoline with a Pump Octane Number (PON) of 87 or higher on this vehicle?

A Unleaded gasoline with a Pump Octane Number (PON) of 91 or higher is recommended. Use of lower octane gasoline can cause occasional metallic knocking noise in the engine and will result in decreased engine performance. Use of gasoline with a pump octane less than 87 can lead to engine damage.

California Proposition 65 Warning

WARNING: This product contains or emits chemicals known to the state of California to cause cancer and birth defects or other reproductive harm.

Event Data Recorders

This vehicle is equipped with an event data recorder (EDR).

The main purpose of an EDR is to record, in certain crash or near crash-like situations, such as an air bag deployment or hitting a road obstacle, data that will assist in understanding how a vehicle's systems performed. **The EDR is designed to record data related to vehicle dynamics and safety systems for a short period of time, typically 30 seconds or less. The EDR in this vehicle is designed to record such data as:**

- **How various systems in your vehicle were operating;**
- **Whether or not the driver and passenger safety belts were buckled/fastened;**
- **How far (if at all) the driver was depressing the accelerator and/or brake pedal; and,**
- **How fast the vehicle was traveling.**

These data can help provide a better understanding of the circumstances in which crashes and injuries occur. NOTE: EDR data are recorded by your vehicle only if a non-trivial crash situation occurs; no data are recorded by the EDR under normal driving conditions and no personal data (e.g., name, gender, age, and crash location) are recorded. However, other parties, such as law enforcement, could combine the EDR data with the type of personally identifying data routinely acquired during a crash investigation.

To read data recorded by an EDR, special equipment is required, and access to the vehicle or the EDR is needed. In addition to the vehicle manufacturer, other parties, such as law enforcement, that have the special equipment, can read the information if they have access to the vehicle or the EDR.

The data belongs to the vehicle owner and may not be accessed by anyone else except as legally required or with the permission of the vehicle owner.

Service Diagnostic Recorders

This vehicle is equipped with service-related devices that record information about powertrain performance. The data can be used to verify emissions law requirements and/or help technicians diagnose and solve service problems. It may also be combined with data from other sources for research purposes, but it remains confidential.

California Perchlorate Contamination Prevention Act

The airbags, seat belt tensioners, and CR type batteries in this vehicle may contain perchlorate materials - special handling may apply. See www.dtsc.ca.gov/hazardouswaste/perchlorate/

As you read this manual, you will find information that is preceded by a **NOTICE** symbol. This information is intended to help you avoid damage to your vehicle, other property, or the environment.

A Few Words About Safety

Your safety, and the safety of others, is very important. And operating this vehicle safely is an important responsibility.

To help you make informed decisions about safety, we have provided operating procedures and other information on labels and in this manual. This information alerts you to potential hazards that could hurt you or others.

Of course, it is not practical or possible to warn you about all the hazards associated with operating or maintaining your vehicle. You must use your own good judgement.

You will find this important safety information in a variety of forms, including:

- **Safety Labels** - on the vehicle.
- **Safety Messages** - preceded by a safety alert symbol  and one of three signal words: **DANGER**, **WARNING**, or **CAUTION**. These signal words mean:

 **DANGER**

You **WILL** be **KILLED** or **SERIOUSLY HURT** if you don't follow instructions.

 **WARNING**

You **CAN** be **KILLED** or **SERIOUSLY HURT** if you don't follow instructions.

 **CAUTION**

You **CAN** be **HURT** if you don't follow instructions.

- **Safety Headings** - such as Important Safety Precautions.
- **Safety Section** - such as Safe Driving.
- **Instructions** - how to use this vehicle correctly and safely.

This entire book is filled with important safety information - please read it carefully.

Safe Driving

You can find many safety recommendations throughout this chapter, and throughout this manual.

For Safe Driving

Important Safety Precautions	22
Your Vehicle's Safety Features.....	24

Seat Belts

About Your Seat Belts.....	26
Fastening a Seat Belt.....	29
Seat Belt Inspection.....	32

Airbags

Airbag System Components.....	33
Types of Airbags	36
Front Airbags (SRS)	36
Side Airbags.....	40

Side Curtain Airbags	43
Airbag System Indicators.....	44
Airbag Care	47

Child Safety

Protecting Child Passengers	48
Safety of Infants and Small Children	50
Safety of Larger Children	58

Exhaust Gas Hazard

Carbon Monoxide Gas.....	60
--------------------------	----

Safety Labels

Label Locations	61
-----------------------	----

The following pages explain your vehicle's safety features and how to use them properly. The safety precautions below are ones that we consider to be among the most important.

Important Safety Precautions

■ Always wear your seat belt

A seat belt is your best protection in all types of collisions. Airbags are designed to supplement seat belts, not replace them. So even though your vehicle is equipped with airbags, make sure you and your passengers always wear your seat belts, and wear them properly.

■ Restrain all children

Children age 12 and under should ride properly restrained in a back seat, not the front seat. Infants and small children should be restrained in a child seat. Larger children should use a booster seat and a lap/shoulder seat belt until they can use the belt properly without a booster seat.

■ Be aware of airbag hazards

While airbags can save lives, they can cause serious or fatal injuries to occupants who sit too close to them, or are not properly restrained. Infants, young children, and short adults are at the greatest risk. Be sure to follow all instructions and warnings in this manual.

■ Don't drink and drive

Alcohol and driving don't mix. Even one drink can reduce your ability to respond to changing conditions, and your reaction time gets worse with every additional drink. So don't drink and drive, and don't let your friends drink and drive, either.

▣ Important Safety Precautions

Some states, provinces and territories prohibit the use of cell phones other than hands-free devices by the driver while driving.

■ Pay appropriate attention to the task of driving safely

Engaging in cell phone conversation or other activities that keep you from paying close attention to the road, other vehicles, and pedestrians could lead to a crash. Remember, situations can change quickly, and only you can decide when it is safe to divert some attention away from driving.

■ Control your speed

Excessive speed is a major factor in crash injuries and deaths. Generally, the higher the speed, the greater the risk, but serious injuries can also occur at lower speeds. Never drive faster than is safe for current conditions, regardless of the maximum speed posted.

■ Keep your vehicle in safe condition

Having a tire blowout or a mechanical failure can be extremely hazardous. To reduce the possibility of such problems, check your tire pressures and condition frequently, and perform all regularly scheduled maintenance.

Your Vehicle's Safety Features

Your Vehicle's Safety Features

Your vehicle is equipped with many features that work together to help protect you and your passengers during a crash.

Some features do not require any action on your part. These include a strong steel framework that forms a safety cage around the passenger compartment, front and rear crush zones, a collapsible steering column, and tensioners that tighten the front seat belts in a sufficient crash.

However, you and your passengers cannot take full advantage of these features unless you remain seated in the correct position and always wear your seat belts. In fact, some safety features can contribute to injuries if they are not used properly.

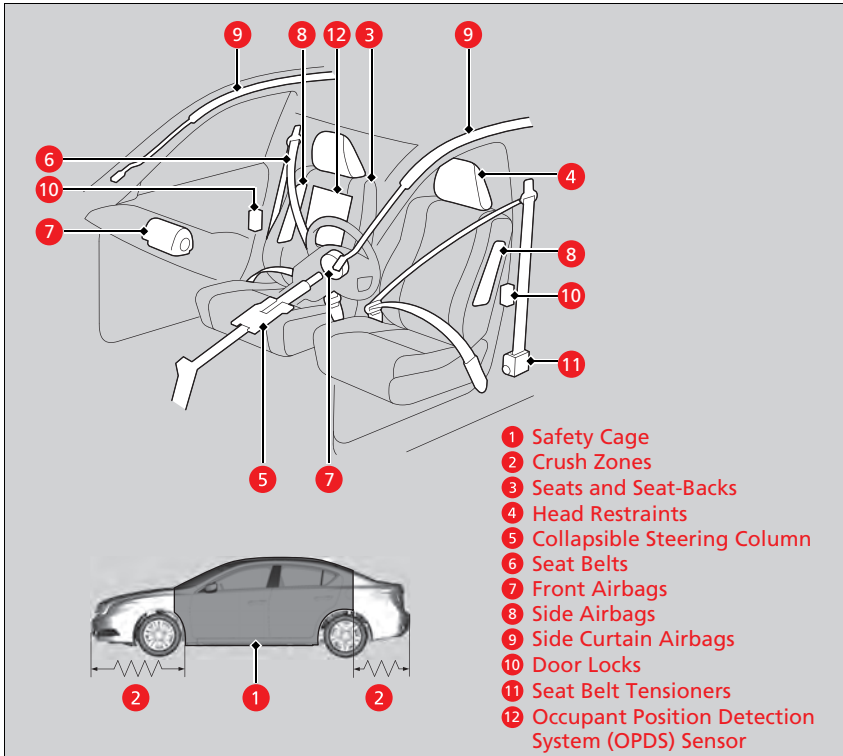

The following checklist will help you take an active role in protecting yourself and your passengers.

QRG

TOC

Safe Driving

Index

Home

Safety Checklist

For the safety of you and your passengers, make a habit of checking these items each time before you drive.

- After everyone has entered the vehicle, be sure all doors are closed and locked. Locking the doors helps prevent an occupant from being ejected and an outsider from unexpectedly opening a door.
 - [Locking/Unlocking the Doors from the Inside P. 99](#)
- Adjust your seat to a position suitable for driving. Be sure the front seats are adjusted as far to the rear as possible while allowing the driver to control the vehicle. Sitting too close to a front airbag can result in serious or fatal injury in a crash.
 - [Adjusting the Seats P. 123](#)
- Adjust head restraints to the proper position. Head restraints are most effective when the center of the head restraint aligns with the center of your head. Taller persons should adjust their head restraint to the highest position.
 - [Adjusting the Head Restraints P. 126](#)
- Always wear your seat belt, and make sure you wear it properly. Confirm that any passengers are properly belted as well.
 - [Fastening a Seat Belt P. 29](#)
- Protect children by using seat belts or child seats according to a child's age, height and weight.
 - [Child Safety P. 48](#)

☒ Safety Checklist

If the door and trunk open indicator is on, a door and/or the trunk is not completely closed. Close all doors and the trunk tightly until the indicator goes off.

➤ [Door and Trunk Open Indicator P. 69](#)

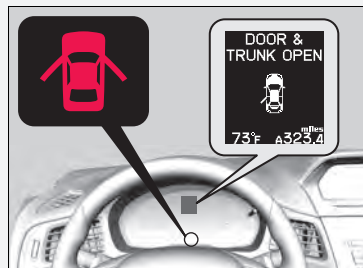

About Your Seat Belts

Seat belts are the single most effective safety device because they keep you connected to the vehicle so that you can take advantage of many built-in safety features. They also help keep you from being thrown against the inside of the vehicle, against other passengers, or out of the vehicle. When worn properly, seat belts also keep your body properly positioned in a crash so that you can take full advantage of the additional protection provided by the airbags.

In addition, seat belts help protect you in almost every type of crash, including:

- frontal impacts
- side impacts
- rear impacts
- rollovers

■ Lap/shoulder seat belts

All five seating positions are equipped with lap/shoulder seat belts with emergency locking retractors. In normal driving the retractor lets you move freely while keeping some tension on the belt. During a collision or sudden stop the retractor locks to restrain your body. The front passenger's and rear seat belts also have a lockable retractor for use with child seats.

➤ [Installing a Child Seat with a Lap/Shoulder Seat Belt](#) P. 55

⌘ About Your Seat Belts

WARNING

Not wearing a seat belt properly increases the chance of serious injury or death in a crash, even though your vehicle has airbags.

Be sure you and your passengers always wear seat belts and wear them properly.

Seat belts cannot completely protect you in every crash. But in most cases, seat belts can reduce your risk of serious injury.

Most states and all Canadian provinces and territories require you to wear seat belts.

■ Proper use of seat belts

Follow these guidelines for proper use:

- All occupants should sit upright, well back in the seat, and remain in that position for the duration of the trip. Slouching and leaning reduces the effectiveness of the belt and can increase the chance of serious injury in a crash.
- Never place the shoulder part of a lap/shoulder seat belt under your arm or behind your back. This could cause very serious injuries in a crash.
- Two people should never use the same seat belt. If they do, they could be very seriously injured in a crash.
- Do not put any accessories on the seat belts. Devices intended to improve comfort or reposition the shoulder part of a seat belt can reduce the protective capability and increase the chance of serious injury in a crash.

■ Seat Belt Reminder



Your vehicle monitors front seat belt use. If the power mode is set to ON before the driver's seat belt is fastened, a beeper will sound and the indicator will blink. If the driver does not fasten the belt before the beeper stops, the indicator will remain on.

The beeper will also periodically sound and the indicator will blink while driving until the driver's and front passenger's seat belts are fastened.

▣ About Your Seat Belts

If a rear seat passenger moves around and extends the seat belt, the lockable retractor may activate. If this happens, release the retractor by unfastening the seat belt and allow the belt to retract completely. Then refasten the belt.

▣ Seat Belt Reminder

The indicator will also come on if a front passenger does not fasten their seat belt within 6 seconds after the power mode is set to ON.

When no one is sitting in the front passenger's seat, or a child or small adult is riding there, the indicator will not come on.

This is because the weight sensors in the seat cannot detect their presence.

Automatic Seat Belt Tensioners

The front seats are equipped with automatic seat belt tensioners to enhance safety.

The tensioners automatically tighten the front seat belts during a moderate-to-severe frontal collision, sometimes even if the collision is not severe enough to inflate the front airbags.

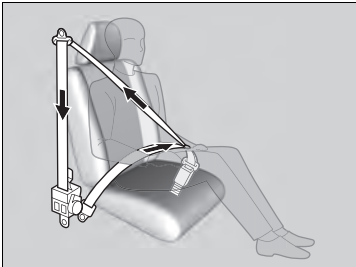

Automatic Seat Belt Tensioners

The seat belt tensioners can only operate once. If a tensioner is activated, the SRS indicator will come on. Have a dealer replace the tensioner and thoroughly inspect the seat belt system as it may not offer protection in a subsequent crash.

During a moderate-to-severe side impact, the tensioner on that side of the vehicle also activates.

Fastening a Seat Belt

After adjusting a front seat to the proper position, and while sitting upright and well back in the seat:

▶ [Adjusting the Seats P. 123](#)

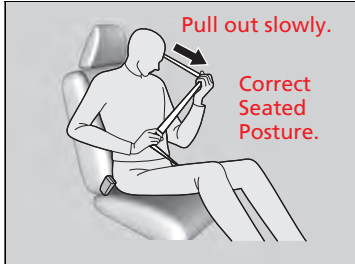

1. Pull the seat belt out slowly.

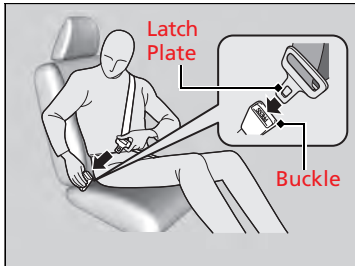

2. Insert the latch plate into the buckle, then tug on the belt to make sure the buckle is secure.

▶ Make sure that the belt is not twisted or caught on anything.

Fastening a Seat Belt

No one should sit in a seat with an inoperative seat belt or one that does not appear to be working correctly. Using a seat belt that is not working properly may not protect the occupant in a crash. Have a dealer check the belt as soon as possible.

Never insert any foreign objects into the buckle or retractor mechanism.

Continued

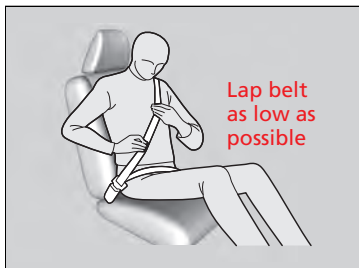

3. Position the lap part of the belt as low as possible across your hips, then pull up on the shoulder part of the belt so the lap part fits snugly. This lets your strong pelvic bones take the force of a crash and reduces the chance of internal injuries.
4. If necessary, pull up on the belt again to remove any slack, then check that the belt rests across the center of your chest and over your shoulder. This spreads the forces of a crash over the strongest bones in your upper body.

▶▶ Fastening a Seat Belt

⚠ WARNING

Improperly positioning the seat belts can cause serious injury or death in a crash.

Make sure all seat belts are properly positioned before driving.

To release the belt, push the red **PRESS** button then guide the belt by hand until it has retracted completely.

When exiting the vehicle, be sure the belt is out of the way and will not get caught by closing the door.

▶▶ Adjusting the Shoulder Anchor

The shoulder anchor height can be adjusted to four levels. If the belt contacts your neck, lower the height one level at a time.

After an adjustment, make sure that the shoulder anchor position is secure.

■ Adjusting the Shoulder Anchor

The front seats have adjustable shoulder anchors to accommodate taller and shorter occupants.

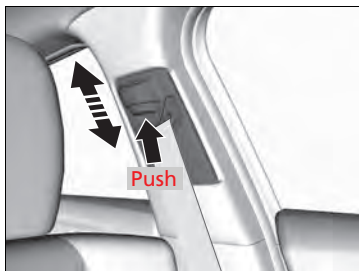

1. Move the anchor up and down while holding the release button.
2. Position the anchor so that the belt rests across the center of your chest and over your shoulder.

Advice for Pregnant Women

If you are pregnant, the best way to protect yourself and your unborn child when driving or riding in a vehicle is to always wear a seat belt and keep the lap part of the belt as low as possible across the hips.

Wear the shoulder belt
across the chest avoiding
the abdomen.



Wear the lap part of the
belt as low as possible
across the hips.

Advice for Pregnant Women

Each time you have a checkup, ask your doctor if it is okay for you to drive.

To reduce the risk of injuries to both you and your unborn child that can be caused by an inflating front airbag:

- When driving, sit upright and adjust the seat as far back as possible while allowing full control of the vehicle.
- When sitting in the front passenger's seat, adjust the seat as far back as possible.

Seat Belt Inspection

Regularly check the condition of your seat belts as follows:

- Pull each belt out fully, and look for frays, cuts, burns, and wear.
- Check that the latches work smoothly and the belts retract easily.
 - ▶ If a belt does not retract easily, cleaning the belt may correct the problem. Only use a mild soap and warm water. Do not use bleach or cleaning solvents. Make sure the belt is completely dry before allowing it to retract.

Any belt that is not in good condition or working properly will not provide proper protection and should be replaced as soon as possible.

A belt that has been worn during a crash may not provide the same level of protection in a subsequent crash. Have your seat belts inspected by a dealer after any collision.

Seat Belt Inspection

WARNING

Not checking or maintaining seat belts can result in serious injury or death if the seat belts do not work properly when needed.

Check your seat belts regularly and have any problem corrected as soon as possible.

Airbag System Components

QRG

TOC

Safe Driving

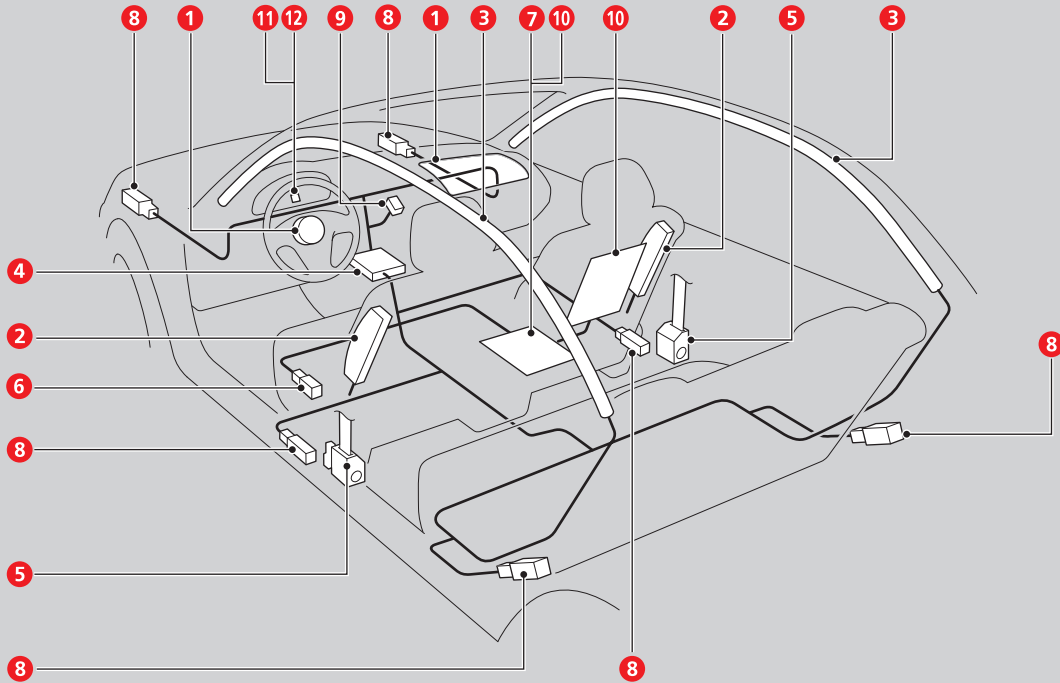

Index



The front, front side, and side curtain airbags are deployed according to the direction and severity of impact. The airbag system includes:

- 1 Two SRS (Supplemental Restraint System) front airbags. The driver's airbag is stored in the center of the steering wheel; the front passenger's airbag is stored in the dashboard. Both are marked **SRS AIRBAG**.
- 2 Two side airbags, one for the driver and one for a front passenger. The airbags are stored in the outer edges of the seat-backs. Both are marked **SIDE AIRBAG**.
- 3 Two side curtain airbags, one for each side of the vehicle. The airbags are stored in the ceiling, above the side windows. The front and rear pillars are marked **SIDE CURTAIN AIRBAG**.

- 4 An electronic control unit that continually monitors and records information about the sensors, the airbag activators, the seat belt tensioners, and driver and front passenger seat belt use when the power mode is in ON.
- 5 Automatic front seat belt tensioners. The driver's and front passenger's seat belts incorporate sensors that detect whether or not they are fastened.
- 6 A driver's seat position sensor. If the seat is too far forward, the airbag will inflate with less force.
- 7 Weight sensors in the front passenger's seat. The front passenger's airbag will be turned off if the weight on the seat is 65 lbs (29 kg) or less (the weight of an infant or small child).

- 8 Impact sensors that can detect a moderate to severe front or side collision.
- 9 An indicator on the dashboard that alerts you that the front passenger's front airbag has been turned off.
- 10 Sensors that can detect if a child or small statured adult is in the deployment path of the front passenger's side airbag.
- 11 An indicator on the instrument panel that alerts you to a possible problem with your airbag system or seat belt tensioners.
- 12 An indicator on the instrument panel that alerts you that the front passenger's side airbag has been turned off.

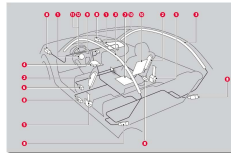

Important Facts About Your Airbags

Airbags can pose serious hazards. To do their job, airbags must inflate with tremendous force. So, while airbags help save lives, they can cause minor injuries, sometimes even fatal ones if occupants are not wearing their seat belts properly and sitting correctly.

What you should do: Always wear your seat belt properly, and sit upright and as far back from the steering wheel as possible while allowing full control of the vehicle. A front passenger should move their seat as far back from the dashboard as possible.

Remember, however, that no safety system can prevent all injuries or deaths that can occur in a severe crash, even when seat belts are properly worn and the airbags deploy.

Do not place hard or sharp objects between yourself and a front airbag.

Carrying hard or sharp objects on your lap, or driving with a pipe or other sharp object in your mouth, can result in injuries if your front airbag inflates.

Do not attach or place objects on the front airbag covers. Objects on the covers marked **SRS AIRBAG** could interfere with the proper operation of the airbags or be propelled inside the vehicle and hurt someone if the airbags inflate.

Important Facts About Your Airbags

Do not attempt to deactivate your airbags. Together, airbags and seat belts provide the best protection.

When driving, keep hands and arms out of the deployment path of the front airbag by holding each side of the steering wheel. Do not cross an arm over the airbag cover.

Types of Airbags

Your vehicle is equipped with three types of airbags:

- **Front airbags:** Airbags in front of the driver's and front passenger's seats.
- **Side airbags:** Airbags in the driver's and front passenger's seat-backs.
- **Side curtain airbags:** Airbags above the side windows.

Each is discussed in the following pages.

Front Airbags (SRS)

The front SRS airbags inflate in a moderate to severe frontal collision to help protect the head and chest of the driver and/or front passenger.

SRS (Supplemental Restraint System) indicates that the airbags are designed to supplement seat belts, not replace them. Seat belts are the occupant's primary restraint system.

Housing Locations

The front airbags are housed in the center of the steering wheel for the driver, and in the dashboard for the front passenger. Both airbags are marked **SRS AIRBAG**.

Types of Airbags

The airbags can inflate whenever the power mode is in ON.

Front Airbags (SRS)

Dual-Stage, Multiple-Threshold Front Airbags (SRS)

Your vehicle is equipped with dual-stage, multiple-threshold front airbags (SRS).

During a frontal crash severe enough to cause one or both front airbags to deploy, the airbags can inflate at different rates, depending on the severity of the crash, whether or not the seat belts are latched, and/or other factors. Frontal airbags are designed to supplement the seat belts to help reduce the likelihood of head and chest injuries in frontal crashes.

■ Operation

Front airbags are designed to inflate during moderate-to-severe frontal collisions. When the vehicle decelerates suddenly, the sensors send information to the control unit which signals one or both front airbags to inflate.

A frontal collision can be either head-on or angled between two vehicles, or when a vehicle crashes into a stationary object, such as a concrete wall.

■ How the Front Airbags Work

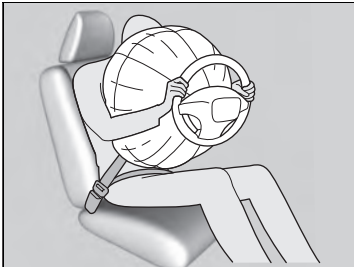

While your seat belt restrains your torso, the front airbag provides supplemental protection for your head and chest.

The front airbags deflate immediately so that they won't interfere with the driver's visibility or the ability to steer or operate other controls.

The total time for inflation and deflation is so fast that most occupants are not aware that the airbags deployed until they see them lying in front of them.

☒ How the Front Airbags Work

After a front airbag inflates in a crash, you may see what looks like smoke. This is actually powder from the airbag's surface. Although the powder is not harmful, people with respiratory problems may experience some temporary discomfort. If this occurs, get out of the vehicle as soon as it is safe to do so.

Although the driver's and front passenger's airbags normally inflate within a split second of each other, it is possible for only one airbag to deploy. This can happen if the severity of a collision is at the margin, or threshold, that determines whether or not the airbags will deploy. In such cases, the seat belt will provide sufficient protection, and the supplemental protection offered by the airbag would be minimal.

■ When front airbags should not deploy

Minor frontal crashes: Front airbags were designed to supplement seat belts and help save lives, not to prevent minor scrapes, or even broken bones that might occur during a less than moderate-to-severe frontal crash.

Side impacts: Front airbags can provide protection when a sudden deceleration causes a driver or front passenger to move towards the front of the vehicle. Side airbags and side curtain airbags have been specifically designed to help reduce the severity of injuries that can occur during a moderate-to-severe side impact which can cause the driver or passenger to move towards the side of the vehicle.

Rear impacts: Head restraints and seat belts are your best protection during a rear impact. Front airbags cannot provide any significant protection and are not designed to deploy in such collisions.

Rollovers: Seat belts and, in vehicles equipped with a rollover sensor, side airbags and side curtain airbags offer the best protection in a rollover. Because front airbags could provide little if any protection, they are not designed to deploy during a rollover.

■ When front airbags deploy with little or no visible damage

Because the airbag system senses sudden deceleration, a strong impact to the vehicle framework or suspension might cause one or more of the airbags to deploy. Examples include running into a curb, the edge of a hole, or other low fixed object that causes a sudden deceleration in the vehicle chassis. Since the impact is underneath the vehicle, damage may not be readily apparent.

■ When front airbags may not deploy, even though exterior damage appears severe

Since crushable body parts absorb crash energy during an impact, the amount of visible damage does not always indicate proper airbag operation. In fact, some collisions can result in severe damage but no airbag deployment because the airbags would not have been needed or would not have provided protection even if they had deployed.

Advanced Airbags

Your front airbags have advanced features to help reduce the likelihood of airbag related injuries to smaller occupants.

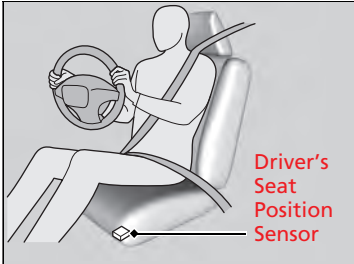

The driver's advanced front airbag system includes a seat position sensor.

If the seat is too far forward, the airbag inflates with less force, regardless of the severity of the impact.

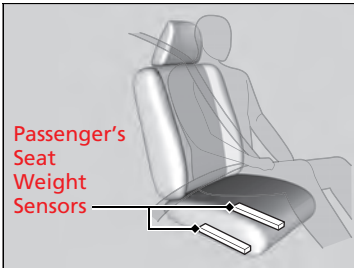

The passenger's advanced front airbag system has weight sensors.

Although we recommend against carrying an infant or small child in front, if the sensors detect the weight of a child (up to about 65 lbs or 29 kg), the system will automatically turn off the passenger's front airbag.

Advanced Airbags

If there is a problem with the driver's seat position sensor, the SRS indicator will come on and the airbag will inflate with full (normal) force, regardless of the driver's seating position.

For both advanced front airbags to work properly:

- Do not spill any liquid on or under the seats.
- Do not put any object under the passenger's seat.
- Make sure any objects are positioned properly on the floor. Improperly positioned objects can interfere with the advanced airbag sensors.
- All occupants should sit upright and wear their seat belts properly.
- Do not place any cover over the passenger side dashboard.

Make sure the floor mat behind the front passenger's seat is hooked to the floor mat anchor. An improperly placed mat can interfere with the advanced airbag sensors.

[▶ Floor Mats P. 299](#)

Side Airbags

The side airbags help protect the upper torso of the driver or a front passenger during a moderate to severe side impact.

Housing Locations

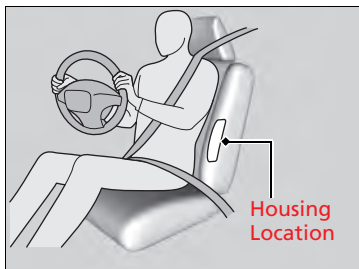

The side airbags are housed in the outside edge of the driver's and passenger's seat-backs.

Both are marked **SIDE AIRBAG**.

Operation

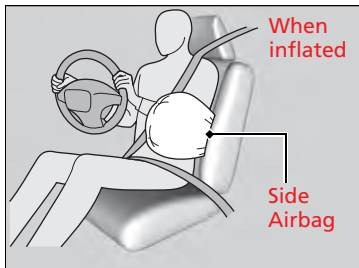

When the sensors detect a moderate-to-severe side impact, the control unit signals the side airbag on the impact side to immediately inflate.

Side Airbags

Do not attach accessories on or near the side airbags. They can interfere with the proper operation of the airbags, or hurt someone if an airbag inflates.

If the impact is on the passenger side, the airbag deploys even if there is no passenger's in the passenger seat.

Do not cover or replace the front seat-back covers without consulting a dealer.

Improperly replacing or covering front seat-back covers can prevent your side airbags from properly deploying during a side impact.

■ When a side airbag deploys with little or no visible damage

Because the airbag system senses sudden acceleration, a strong impact to the side of the vehicle's framework can cause a side airbag to deploy. In such cases, there may be little or no damage, but the side impact sensors detected a severe enough impact to deploy the airbag.

■ When a side airbag may not deploy, even though visible damage appears severe

It is possible for a side airbag to not deploy during an impact that results in apparently severe damage. This can occur when the point of impact was towards the far front or rear of the vehicle, or when the vehicle's crushable body parts absorbed most of the crash energy. In either case, the side airbag would not have been needed nor provided protection even if it had deployed.

Side Airbag Cutoff System

To reduce the likelihood that a front passenger may be injured by an inflating side airbag, the passenger side airbag is automatically turned off when:

- The height sensors detect a child or short-statured adult is seated in the front passenger seat.
- The position sensor detects that the front passenger is leaning into the deployment path of the side airbag.

When the side airbag cutoff system is activated, the side airbag off indicator comes on.

➤ [Side Airbag Off Indicator P. 46](#)

Side Airbag Off Indicator

If the side airbag off indicator comes on, have the passenger sit upright. A few seconds after the passenger is sitting properly, the side airbag will automatically be turned on, and the indicator will go off.

If the front passenger is a child, stop when it is safe to do so, and have the child sit properly restrained in a rear seat.

Side Airbag Cutoff System

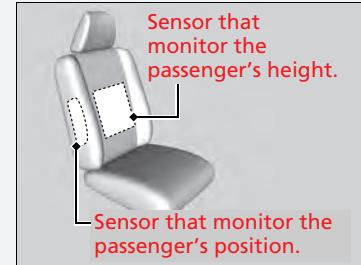

The sensors that monitor the front passenger's height and body position may not work if:

- The seat-back is wet
- The passenger is touching a metal or other electrical conductive object
- A seat cushion is on the seat
- The passenger is wearing excessively thick clothing

Side Curtain Airbags

The side curtain airbags help protect the heads of the driver and passengers in outer seating positions during a moderate-to-severe side impact.

Housing Locations

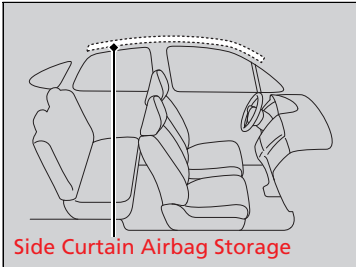

Side Curtain Airbag Storage

The side curtain airbags are located in the ceiling above the side windows on both sides of the vehicle.

Operation

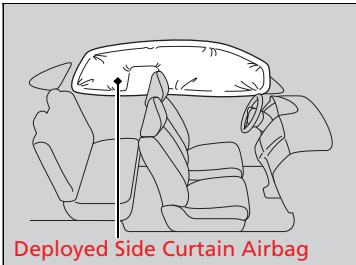

Deployed Side Curtain Airbag

The side curtain airbag is designed to deploy in a moderate-to-severe side impact.

When side curtain airbags deploy in a frontal collision

One or both side curtain airbags may inflate in a moderate to severe angled frontal collision.

In this case, the side curtain airbags will deploy slightly after the front airbags.

Side Curtain Airbags

The side curtain airbags are most effective when an occupant is wearing their seat belt properly and sitting upright, well back in their seat.

Do not attach any objects to the side windows or roof pillars as they can interfere with the proper operation of the side curtain airbags.

Airbag System Indicators

If a problem occurs in the airbag system, the SRS indicator will come on and a message appears on the multi-information display.

■ SRS (Supplemental Restraint System) Indicator

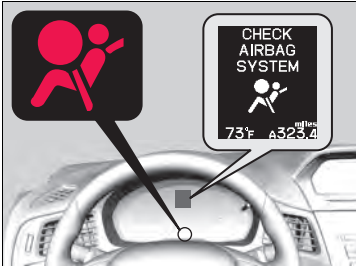

■ When the power mode is set to ON

The indicator comes on for a few seconds, then goes off. This tells you the system is working properly.

If the indicator comes on at any other time, or does not come on at all, have the system checked by a dealer as soon as possible. If you don't, your airbags and seat belt tensioners may not work properly when they are needed.

⚠ SRS (Supplemental Restraint System) Indicator

⚠ WARNING

Ignoring the SRS indicator can result in serious injury or death if the airbag systems or tensioners do not work properly.

Have your vehicle checked by a dealer as soon as possible if the SRS indicator alerts you to a possible problem.

Passenger Airbag Off Indicator

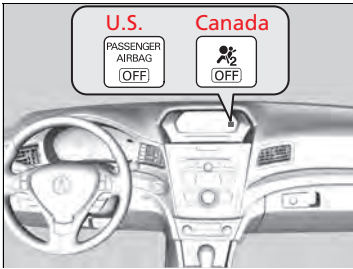

■ When the passenger airbag off indicator comes on

The indicator comes on to alert you that the passenger's front airbag has been turned off. This occurs when the front passenger's weight sensors detect 65 lbs (29 kg) or less, the weight of an infant or small child, on the seat.

Infants and small children should always ride properly restrained in a back seat.

➤ [Child Safety P. 48](#)

Objects placed on the seat can also cause the indicator to come on.

If the front passenger seat is empty, the passenger's front airbag will not deploy and the indicator will not come on.

▣ Passenger Airbag Off Indicator

If the indicator comes on with no front passenger and no objects on the passenger's seat, or with an adult riding there, something may be interfering with the weight sensors. Such as:

- An object hanging on the seat or in the seat-back pocket.
- A child seat or other object pressing against the rear of the seat-back.
- A rear passenger pushing or pulling on the back of the front passenger's seat.
- The front seat or seat-back is forced back against an object on the seat or floor behind it.
- An object placed under the front passenger's seat.

If none of these conditions exist, have your vehicle checked by a dealer as soon as possible.

The passenger airbag off indicator may come on and goes off repeatedly if the total weight on the seat is near the airbag cutoff threshold.

QRG

TOC

Safe Driving

■ Side Airbag Off Indicator

■ When the side airbag off indicator comes on

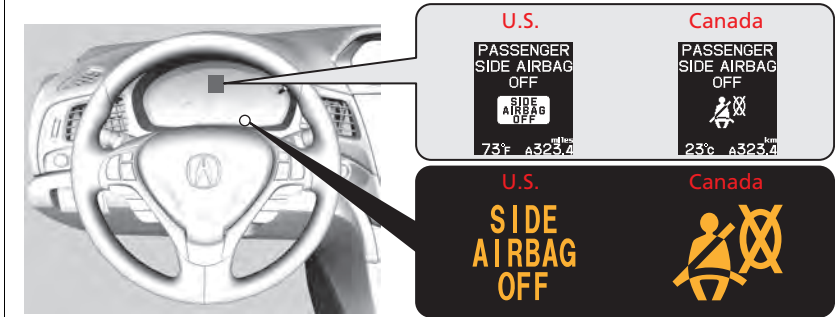

This indicator comes on if the passenger's side airbag has been turned off because the passenger is too small to be sitting in the front seat, is slouching or not sitting upright, or has leaned into the airbag's deployment path.

Unless the passenger is a smaller statured adult or a child, the indicator should go off when the passenger returns to a proper upright sitting position.

▶▶ Side Airbag Off Indicator

When you set the power mode to ON, the indicator should come on for a few seconds and then go out. If it doesn't come on, stays on, or comes on while driving without a passenger in the front seat, have the system checked by a dealer as soon as possible.

Index

Home

Airbag Care

You do not need to, and should not, perform any maintenance on or replace any airbag system components yourself. However, you should have your vehicle inspected by a dealer in the following situations:

■ When the airbags have deployed

If an airbag has inflated, the control unit and other related parts must be replaced. Similarly, once an automatic seat belt tensioner has been activated, it must be replaced.

■ When the vehicle has been in a moderate-to-severe collision

Even if the airbags did not inflate, have your dealer inspect the following: the driver's seat position sensor, weight sensors in the passenger's seat, front seat belt tensioners, and each seat belt that was worn during the crash.

■ Do not remove or modify a front seat without consulting a dealer

This would likely disable the driver's seat position sensor or the passenger's weight sensors. If it is necessary to remove or modify a front seat to accommodate a person with disabilities, contact an Acura dealer, or for U.S. vehicles, Acura Client Relations at 1-800-382-2238 and for Canadian vehicles, Canadian Acura Client Service at 1-888-9-ACURA-9.

✕ Airbag Care

We recommend against the use of salvaged airbag system components, including the airbag, tensioners, sensors, and control unit.

Protecting Child Passengers

Each year, many children are injured or killed in vehicle crashes because they are either unrestrained or not properly restrained. In fact, vehicle accidents are the number one cause of death of children age 12 and under.

To reduce the number of child deaths and injuries, every state, Canadian province and territory requires that infants and children be properly restrained when they ride in a vehicle.

Children should sit properly restrained in a rear seat. This is because:

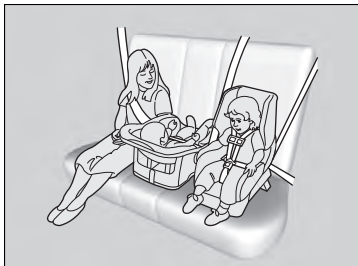

- An inflating front or side airbag can injure or kill a child sitting in the front seat.
- A child in the front seat is more likely to interfere with the driver's ability to safely control the vehicle.
- Statistics show that children of all sizes and ages are safer when they are properly restrained in a rear seat.

Protecting Child Passengers

⚠ WARNING

Children who are unrestrained or improperly restrained can be seriously injured or killed in a crash.

Any child too small for a seat belt should be properly restrained in a child seat. A larger child should be properly restrained with a seat belt, using a booster seat if necessary.

The National Highway Traffic Safety Administration and Transport Canada recommend that all children age 12 and under be properly restrained in a rear seat. Some states or provinces/territories have laws restricting where children may ride.

- Any child who is too small to wear a seat belt correctly must be restrained in an approved child seat that is properly secured to the vehicle using either the lap belt portion of the lap/shoulder belt or the lower anchors of the LATCH system.
- Never hold a child on your lap because it is impossible to protect them in the event of a collision.
- Never put a seat belt over yourself and a child. During a crash, the belt would likely press deep into the child and cause serious or fatal injuries.
- Never let two children use the same seat belt. Both children could be very seriously injured in a crash.
- Do not allow children to operate the doors, windows or seat adjustments.
- Do not leave children in the vehicle unattended, especially in hot weather when the inside of the vehicle can get hot enough to kill them. They could also activate vehicle controls causing it to move unexpectedly.

Protecting Child Passengers

⚠ WARNING

Allowing a child to play with a seat belt or wrap one around their neck can result in serious injury or death.

Instruct children not to play with any seat belt and make sure any unused seat belt a child can reach is buckled, fully retracted, and locked.

To deactivate a lockable retractor, release the buckle and allow the seat belt to wind up all the way.

To remind you of the passenger's front airbag hazards and child safety, your vehicle has warning labels on the dashboard (U.S. models) and on the front visors. Please read and follow the instructions on these labels.

[➤ Safety Labels P. 61](#)

Safety of Infants and Small Children

■ Protecting Infants

An infant must be properly restrained in a rear-facing, reclining child seat until the infant reaches the seat maker's weight or height limit for the seat, and the infant is at least one year old.

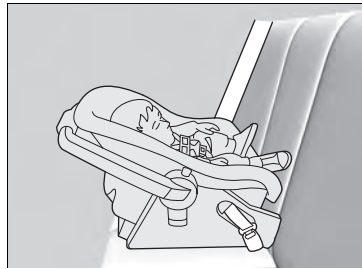

■ **Positioning a rear-facing child seat**
Child seats must be placed and secured in a rear seating position.

When properly installed, a rear-facing child seat may prevent the driver or a front passenger from moving their seat all the way back, or from locking their seat-back in the desired position.

It can also interfere with proper operation of the passenger's advanced front airbag system.

➤ [Airbags P. 33](#)

If this occurs, we recommend that you install the child seat directly behind the front passenger's seat, move the seat as far forward as needed, and leave it unoccupied. Or, you may wish to get a smaller rear-facing child seat.

▶▶ Protecting Infants

⚠ WARNING

Placing a rear-facing child seat in the front seat can result in serious injury or death during a crash.

Always place a rear-facing child seat in the rear seat, not the front.

Rear-facing child seats should never be installed in a forward facing position.

Always refer to the child seat manufacturer's instructions before installation.

Protecting Smaller Children

If a child is at least one year old and within the weight range indicated by the child seat manufacturer, the child should be properly restrained in a firmly secured forward-facing child seat.

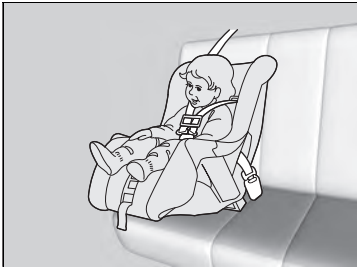

Forward-facing child seat placement

We strongly recommend placing a forward-facing child seat in a rear seating position.

Placing a forward-facing child seat in the front seat can be hazardous, even with advanced front airbags that automatically turn the passenger's front airbag off. A rear seat is the safest place for a child.

Protecting Smaller Children

WARNING

Placing a forward-facing child seat in the front seat can result in serious injury or death if the front airbag inflates.

If you must place a forward-facing child seat in front, move the vehicle seat as far back as possible, and properly restrain the child.

Educate yourself about the laws and regulations regarding child seat use where you are driving, and follow the child seat manufacturer's instructions.

Many experts recommend use of a rear-facing seat up to age two, if the child's height and weight are appropriate for a rear-facing seat.

■ Selecting a Child Seat

Most child seats are LATCH-compatible (Lower Anchors and Tethers for Children). Some have a rigid-type connector, while others have a flexible-type connector. Both are equally easy to use. Some existing and previously owned child seats can only be installed using the seat belt. Whichever type you choose, follow the child seat manufacturer's use and care instructions as well as the instructions in this manual. Proper installation is key to maximizing your child's safety.

In seating positions and vehicles not equipped with LATCH, a LATCH compatible child seat can be installed using the seat belt and a top tether for added security. This is because all child seats are required to be designed so that they can be secured with a lap belt or the lap part of a lap/shoulder belt. In addition, the child seat manufacturer may advise that a seat belt be used to attach a LATCH-compatible seat once a child reaches a specified weight. Please read the child seat owner's manual for proper installation instructions.

■ Important consideration when selecting a child seat

Make sure the child seat meets the following three requirements:

- The child seat is the correct type and size for the child.
- The child seat is the correct type for the seating position.
- The child seat is compliant with Federal Motor Vehicle Safety Standard 213 or Canadian Motor Vehicle Safety Standard 213.

▶▶ Selecting a Child Seat

Installation of a LATCH-compatible child seat is simple.

LATCH-compatible child seats have been developed to simplify the installation process and reduce the likelihood of injuries caused by incorrect installation.

■ Installing a LATCH-Compatible Child Seat

A LATCH-compatible child seat can be installed in either of the two outer rear seats. A child seat is attached to the lower anchors with either the rigid or flexible type of connectors.

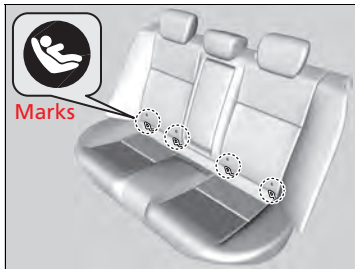

1. Locate the lower anchors under the marks.

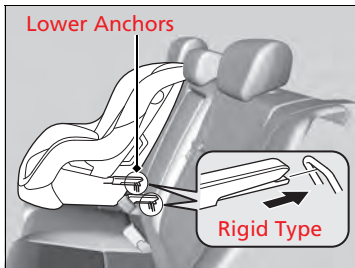

2. Place the child seat on the vehicle seat then attach the child seat to the lower anchors according to the instructions that came with the child seat.

▶ When installing the child seat, make sure that the lower anchors are not obstructed by the seat belt or any other object.

QRG

TOC

Safe Driving

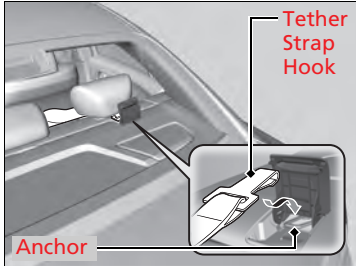
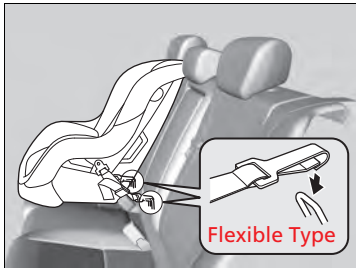

3. Open the tether anchor cover behind the head restraint.
4. Raise the head restraint to its highest position, then route the tether strap between the head restraint legs, and secure the tether strap hook onto the anchor.
5. Tighten the tether strap as instructed by the child seat maker.
6. Make sure the child seat is firmly secured by rocking it forward and back and side to side; little movement should be felt.
7. Make sure any unused seat belt that a child can reach is buckled, the lockable retractor is activated, and the belt is fully retracted and locked.

▶▶ Installing a LATCH-Compatible Child Seat

For your child's safety, when using a child seat installed using the LATCH system, make sure that the seat is properly secured to the vehicle. A child seat that is not properly secured will not adequately protect a child in a crash and may cause injury to the child or other vehicle occupants.

Index

Home

Installing a Child Seat with a Lap/Shoulder Seat Belt

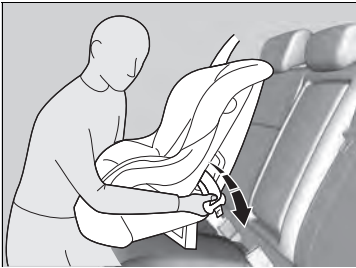

1. Place the child seat on the vehicle seat.
2. Route the seat belt through the child seat according to the seat maker's instructions, and insert the latch plate into the buckle.
 - Insert the latch plate fully until it clicks.

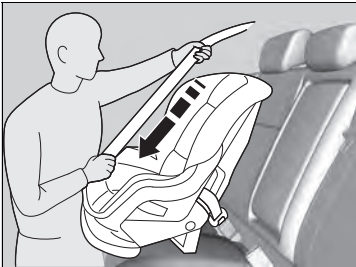

3. Slowly pull the shoulder part of the belt all the way out until it stops. This activates the lockable retractor.
4. Let the seat belt completely wind up into the retractor, then try to pull it out to make sure the retractor is locked.
 - If you are able to pull the shoulder belt out, the lockable retractor is not activated. Pull the seat belt all the way out, and repeat steps 2 – 4.



5. Grab the shoulder part of the seat belt near the buckle, and pull up to remove any slack from the lap part of the belt.
 - When doing this, place your weight on the child seat and push it into the vehicle seat.

Installing a Child Seat with a Lap/Shoulder Seat Belt

A child seat that is not properly secured will not adequately protect a child in a crash and may cause injury to the child or other vehicle occupants.

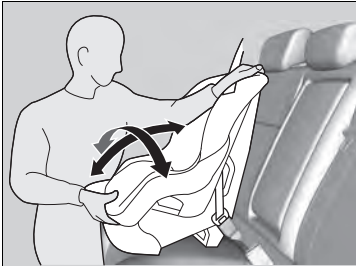

6. Make sure the child seat is firmly secured by rocking it forward and back and side to side; little movement should be felt.
7. Make sure any unused seat belt that a child can reach is buckled, the lockable retractor is activated, and the belt is fully retracted and locked.

► Installing a Child Seat with a Lap/Shoulder Seat Belt

To deactivate a lockable retractor, release the buckle and allow the seat belt to wind up all the way.

■ Adding Security with a Tether

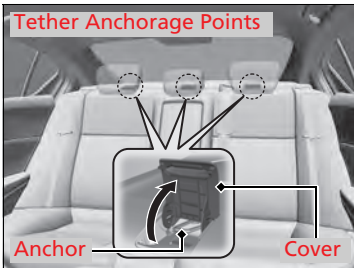

A tether anchorage point is provided behind each rear seating position. A child seat that is installed with a seat belt and comes with a tether can use the tether for additional security.

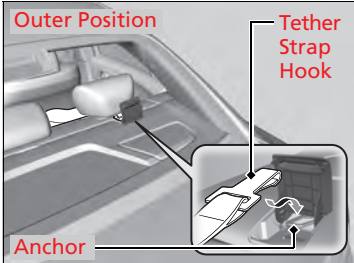

1. Locate the appropriate tether anchorage point and lift the cover.
2. Raise the head restraint to its highest position, then route the tether strap through the head restraint legs. Make sure the strap is not twisted.

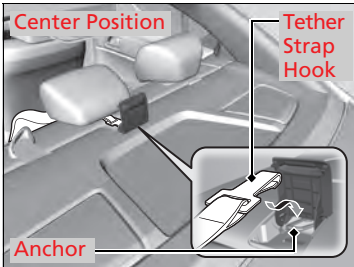

3. Secure the tether strap hook onto the anchor.
4. Tighten the tether strap as instructed by the child seat manufacturer.

▣ Adding Security with a Tether

Since a tether can provide additional security to the lap/shoulder seat belt installation, we recommend using a tether whenever one is available.

Safety of Larger Children

■ Protecting Larger Children

The following pages give instructions on how to check proper seat belt fit, what kind of booster seat to use if one is needed, and important precautions for a child who must sit in front.

■ Checking Seat Belt Fit

When a child is too big for a child seat, secure the child in a rear seat using the lap/shoulder seat belt. Have the child sit upright and all the way back, then answer the following questions.



■ Checklist

- Do the child's knees bend comfortably over the edge of the seat?
- Does the shoulder belt cross between the child's neck and arm?
- Is the lap part of the seat belt as low as possible, touching the child's thighs?
- Will the child be able to stay seated like this for the whole trip?

If you answer yes to all these questions, the child is ready to wear the lap/shoulder seat belt correctly. If you answer no to any question, the child needs to ride on a booster seat until the seat belt fits properly without a booster seat.

▶ Safety of Larger Children

⚠ WARNING

Allowing a child age 12 or under to sit in front can result in injury or death if the passenger's front airbag inflates.

If a larger child must ride in front, move the vehicle seat as far to the rear as possible, have the child sit up properly and wear the seat belt properly, using a booster seat if needed.

Booster Seats



If a lap/shoulder seat belt cannot be used properly, position the child in a booster seat in a rear seating position. For the child's safety, check that the child meets the booster seat manufacturer's recommendations.

Protecting Larger Children-Final Checks

Your vehicle has a rear seat where children can be properly restrained. If you ever have to carry a group of children, and a child must ride in front:

- Make sure you read and fully understand the instructions and safety information in this manual.
- Move the front passenger seat as far back as possible.
- Have the child sit upright and well back in the seat.
- Check that the seat belt is properly positioned so that the child is secure in the seat.

Monitoring child passengers

We strongly recommend that you keep an eye on child passengers. Even older, more mature children sometimes need to be reminded to fasten their seat belts and sit up properly.

Booster Seats

When installing a booster seat, make sure to read the instructions that came with it, and install the seat accordingly.

There are high- and low-type booster seats. Choose a booster seat that allows the child to wear the seat belt correctly.

Some U.S. states and Canadian provinces and territories require children to use a booster seat until they reach a given age or weight (e.g. 6 years or 60 lbs). Be sure to check current laws in the state or province, or territory where you intend to drive.

Protecting Larger Children-Final Checks

⚠ WARNING

Allowing a child age 12 or under to sit in front can result in injury or death if the passenger's front airbag inflates.

If a larger child must ride in front, move the vehicle seat as far to the rear as possible, have the child sit up properly and wear the seat belt properly, using a booster seat if needed.

Carbon Monoxide Gas

The engine exhaust from this vehicle contains carbon monoxide, a colorless, odorless, and highly toxic gas. As long as you properly maintain your vehicle, carbon monoxide gas will not get into the interior.

■ Have the exhaust system inspected for leaks whenever

- The exhaust system is making an unusual noise.
- The exhaust system may have been damaged.
- The vehicle is raised for an oil change.

When you operate a vehicle with the trunk open, airflow can pull exhaust gas into the interior and create a hazardous condition. If you must drive with the trunk open, open all the windows and set the climate control system as shown below.

1. Select the fresh air mode.
2. Select the  mode.
3. Set the fan speed to high.
4. Set the temperature control to a comfortable setting.

Adjust the climate control system in the same manner if you sit in your parked vehicle with the engine running.

☒ Carbon Monoxide Gas

WARNING

Carbon monoxide gas is toxic. Breathing it can cause unconsciousness and even kill you.

Avoid any enclosed areas or activities that expose you to carbon monoxide.

An enclosed area such as a garage can quickly fill up with carbon monoxide gas. Do not run the engine with the garage door closed. Even when the garage door is open, drive out of the garage immediately after starting the engine.

Label Locations

These labels are in the locations shown. They warn you of potential hazards that can cause serious injury or death. Read these labels carefully.

If a label comes off or becomes hard to read (except for the U.S. dashboard label which may be removed by the owner), contact a dealer for a replacement.

Sun Visor

WARNING

EVEN WITH ADVANCED AIR BAGS

- Children can be killed or seriously injured by the air bag.
- The back seat is the safest place for children.
- Never put a child-facing child seat in the front.
- Always use seat belts and child restraints.
- See owner's manual for more information about air bags.

U.S. models

CAUTION

TO AVOID SERIOUS INJURY:

- FOR MAXIMUM SAFETY PROTECTION IN ALL TYPES OF CRASHES YOU MUST ALWAYS WEAR YOUR SAFETY BELT.
- DO NOT INSTALL REARWARD-FACING CHILD SEATS IN ANY FRONT PASSENGER SEAT POSITION.
- DO NOT SIT OR LEAN UNNECESSARILY CLOSE TO THE AIR BAG.
- DO NOT PLACE ANY OBJECTS OVER THE AIR BAG OR BETWEEN THE AIR BAG AND YOURSELF.
- SEE THE OWNER'S MANUAL FOR FURTHER INFORMATION AND EXPLANATIONS.

Canadian models

PRECAUTIONS:

- POUR ÉVITER DES BLESSURES GRAVES:
- POUR PROFITER D'UNE PROTECTION MAXIMALE EN UN COLLISION, BOUCLEZ TOUJOURS VOTRE CEINTURE DE SÉCURITÉ.
- N'INSTALLEZ JAMAIS UN SIÈGE POUR ENFANTS FAISANT FACE À L'ARRIÈRE SUR LE SIÈGE DU PASSAGER AVANT.
- NE VOUS APPUYEZ PAS ET NE VOUS ASSOYEZ PAS PRÈS DU COUSSIN GONFLABLE.
- NE DÉPOSEZ AUCUN OBJET SUR LE COUSSIN GONFLABLE OU ENTRE LE COUSSIN GONFLABLE ET VOUS.
- LISEZ LE GUIDE UTILISATEUR POUR DE PLUS AMPLES RENSEIGNEMENTS.

Dashboard

U.S. models only

This Vehicle is Equipped with Advanced Air Bags

Even with Advanced Air Bags

Children can be killed or seriously injured by the air bag. The back seat is the safest place for children. Never put a child-facing child seat in the front. Always use seat belts and child restraints. See owner's manual for more information about air bags.

©2013 GM Corp. Buckle up, America!

Radiator Cap

DANGER WARNING

危險 危險

NEVER OPEN WHEN HOT

Hot coolant will scald you.

NE VOUS OUVRIEZ PAS QUAND CHAUD

Le liquide de refroidissement est très chaud.

NE PAS OUVRIER QUAND CHAUD

熱い冷却液は湯傷を負います。

1, 1

Doorjamb

U.S. models

SIDE AIRBAG

- This car is equipped with side airbags in the front seats and side curtain airbags.
- Do not lean against the door.
- Do not lean against the side curtain airbags.
- See owner's manual for more information.

Canadian models

COUSSIN GONFLABLE LATÉRAL

- Cette automobile est équipée de coussins gonflables latéraux dans les sièges avant et des coussins gonflables latéraux de type rideau.
- Ne vous appuyez pas sur la porte.
- Consultez le Manuel du propriétaire pour en savoir plus.

Instrument Panel

This chapter describes the buttons, indicators, and gauges that are used while driving.









- Indicators** 64
 - Multi-Information Display Warning and Information Messages..... 73
- Gauges and Multi-Information Display**
 - Gauges..... 78
 - Multi-Information Display 79

QRG

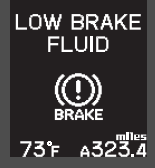
TOC

Instrument Panel

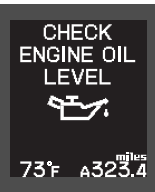
Indicator	Name	On/Blinking	Explanation	Message
 <p>U.S. BRAKE Canada </p>	Parking Brake and Brake System Indicator	<ul style="list-style-type: none"> • Comes on for a few seconds when you set the power mode to ON, then goes off. • Comes on when the parking brake is applied, and goes off when it is released. • Comes on when the brake fluid level is low. • Comes on if there is a problem with the brake system. • The beeper sounds and the indicator comes on if you drive with the parking brake not fully released. 	<ul style="list-style-type: none"> • Comes on while driving - Make sure the parking brake is released. Check the brake fluid level. <ul style="list-style-type: none"> ➤ What to do when the indicator comes on while driving P. 322 • Comes on along with the ABS indicator - Have the vehicle checked by a dealer. <ul style="list-style-type: none"> ➤ If the Brake System Indicator Comes On P. 322 	  
 <p></p>	Low Oil Pressure Indicator	<ul style="list-style-type: none"> • Comes on when you set the power mode to ON, and goes off when the engine starts. • Comes on when the engine oil pressure is low. 	<ul style="list-style-type: none"> • Comes on while driving - Immediately stop in a safe place. <ul style="list-style-type: none"> ➤ If the Low Oil Pressure Indicator Comes On P. 320 	

Index

[Home](#)







QRG

TOC

Instrument Panel

Index



Indicator	Name	On/Blinking	Explanation	Message
	Malfunction Indicator Lamp	<ul style="list-style-type: none"> • Comes on when you set the power mode to ON, and goes off either when the engine starts or after several seconds if the engine is not started. If “readiness codes” have not been set, it blinks five times before it goes off. • Comes on if there is a problem with the emissions control system. • Blinks when a misfire in the engine's cylinders is detected. 	<ul style="list-style-type: none"> • Readiness codes are part of the on board diagnostics for the emissions control systems. <ul style="list-style-type: none"> ► Testing of Readiness Codes P. 337 • Comes on while driving - Have the vehicle checked by a dealer. • Blinks while driving - Stop in a safe place where there are no flammable objects. Stop the engine for 10 minutes or more, and wait for it to cool down. Then, take the vehicle to a dealer. <ul style="list-style-type: none"> ► If the Malfunction Indicator Lamp Comes On or Blinks P. 321 	
	Charging System Indicator	<ul style="list-style-type: none"> • Comes on when you set the power mode to ON, and goes off when the engine starts. • Comes on when the battery is not charging. 	<ul style="list-style-type: none"> • Comes on while driving - Turn off the climate control system and rear defogger in order to reduce electricity consumption. <ul style="list-style-type: none"> ► If the Charging System Indicator Comes On P. 320 	
	Shift Lever Position Indicator*	<ul style="list-style-type: none"> • Indicates current shift lever position. 	<ul style="list-style-type: none"> ► Shifting P. 222 	

* Not available on all models







QRG



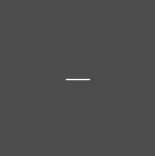

TOC





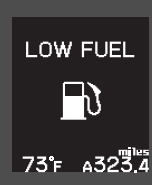

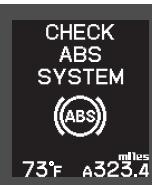
Instrument Panel



Index





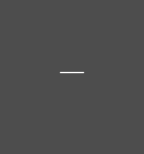



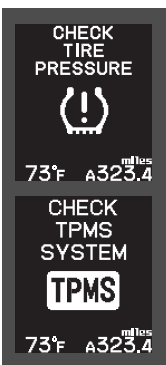





Indicator	Name	On/Blinking	Explanation	Message
	Transmission Indicator*	<ul style="list-style-type: none"> Blinks if the transmission system has a problem. 	<ul style="list-style-type: none"> Blinks while driving - Avoid sudden starts and acceleration and have the vehicle checked by a dealer immediately. 	
	M (sequential shift mode) Indicator/Gear Position Indicator*	<ul style="list-style-type: none"> Comes on when the manual sequential shift mode is applied. 	<p>Sequential Shift Mode P. 224</p>	
	Seat Belt Reminder Indicator	<ul style="list-style-type: none"> Comes on and the beeper sounds if you are not wearing a seat belt when you set the power mode to ON. If the front passenger is not wearing a seat belt, the indicator comes on about a few seconds later. Blinks while driving if either you or the front passenger has not fastened a seat belt. The beeper sounds and the indicator blinks at regular intervals. 	<ul style="list-style-type: none"> The beeper stops and the indicator goes off when you and the front passenger fasten their seat belts. Stays on after you or the front passenger has fastened the seat belt - A detection error may have occurred in the sensor. Have the vehicle checked by a dealer. <ul style="list-style-type: none"> Seat Belt Reminder P. 27 	 



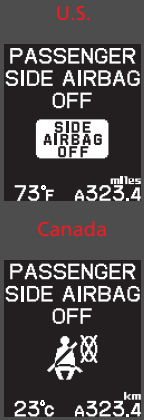

Indicator	Name	On/Blinking	Explanation	Message
	<p>Low Fuel Indicator</p>	<ul style="list-style-type: none"> • Comes on when the fuel reserve is running low (approximately 1.9 U.S. gal./7.5 Liter left). • Blinks if there is a problem with the fuel gauge. 	<ul style="list-style-type: none"> • Comes on - Refuel your vehicle as soon as possible. • Blinks - Have the vehicle checked by a dealer. 	
	<p>ABS (Anti-lock Brake System) Indicator</p>	<ul style="list-style-type: none"> • Comes on for a few seconds when you set the power mode to ON, then goes off. • If it comes on at any other time, there is a problem with the ABS. 	<ul style="list-style-type: none"> • Stays on constantly - Have the vehicle checked by a dealer. With this indicator on, your vehicle still has normal braking ability but no anti-lock function. ➤ ABS (Anti-lock Brake System) P. 239 	
	<p>Supplemental Restraint System Indicator</p>	<ul style="list-style-type: none"> • Comes on for a few seconds when you set the power mode to ON, then goes off. • Comes on if a problem with any of the following is detected: <ul style="list-style-type: none"> - Supplemental restraint system - Side airbag system - Side curtain airbag system - Seat belt tensioner 	<ul style="list-style-type: none"> • Stays on constantly or does not come on at all - Have the vehicle checked by a dealer. 	

Indicator	Name	On/Blinking	Explanation	Message
	Electric Power Steering (EPS) System Indicator	<ul style="list-style-type: none"> Comes on when you set the power mode to ON, and goes off when the engine starts. Comes on if there is a problem with the EPS system. 	<ul style="list-style-type: none"> Stays on constantly or does not come on at all - Have the vehicle checked by a dealer. <ul style="list-style-type: none"> ► If the Electric Power Steering (EPS) System Indicator Comes On P. 322 	
	VSA® (Vehicle Stability Assist) System Indicator	<ul style="list-style-type: none"> Comes on for a few seconds when you set the power mode to ON, then goes off. Blinks when VSA® is active. Comes on if there is a problem with the VSA system or hill start assist system. 	<ul style="list-style-type: none"> Stays on constantly - Have the vehicle checked by a dealer. <ul style="list-style-type: none"> ► VSA® (Vehicle Stability Assist), aka ESC (Electronic Stability Control), System P. 232 	 
	VSA® (Vehicle Stability Assist) OFF Indicator	<ul style="list-style-type: none"> Comes on for a few seconds when you set the power mode to ON, then goes off. Comes on when you deactivate VSA®. 	<ul style="list-style-type: none"> ► VSA® (Vehicle Stability Assist), aka ESC (Electronic Stability Control), System P. 232 	

Indicator	Name	On/Blinking	Explanation	Message
	Door and Trunk Open Indicator	<ul style="list-style-type: none"> Comes on for a few seconds if you set the power mode to ON, then goes off. Comes on if any door or the trunk is not completely closed. 	<ul style="list-style-type: none"> Goes off when all doors and the trunk are closed. 	
U.S. models only 	Low Tire Pressure/TPMS Indicator	<ul style="list-style-type: none"> Comes on for a few seconds when you set the power mode to ON. Comes on if the tire pressure of any of the tires becomes significantly low. Blinks for about one minute, and then stays on if there is a problem with the TPMS, or when a compact spare tire is temporarily installed. 	<ul style="list-style-type: none"> Comes on while driving - Stop in a safe place, check tire pressures, and inflate the tire(s) if necessary. Blinks and remains on - Have the vehicle checked by a dealer. If the vehicle is fitted with a compact spare, get your regular tire repaired or replaced and put back on your vehicle as soon as you can. 	

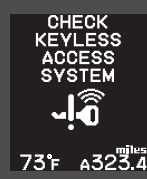
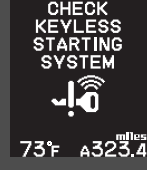

Indicator	Name	On/Blinking	Explanation	Message
	System Message Indicator	<ul style="list-style-type: none"> Comes on for a few seconds when you set the power mode to ON, then goes off. Comes on along with a beep when a problem is detected. A system message on the multi-information display appears at the same time. 	<ul style="list-style-type: none"> While the indicator is on, press the /  (information) button to see the message again. Refer to the Indicators information in this chapter when a system message appears on the multi-information display. Take the appropriate action for the message. The multi-information display does not return to the normal screen unless the warning is canceled, or the /  button is pressed. 	—
	Turn Signal Indicators	<ul style="list-style-type: none"> The turn signal indicators blink when you operate the turn signal lever. If you press the hazard warning button, both indicators and all turn signals blink at the same time. 	<ul style="list-style-type: none"> Does not blink or blinks rapidly - A turn signal light bulb has blown. Change the bulb immediately.  Replacing Light Bulbs P. 278 P. 280 	—
	High-Beam Indicator	<ul style="list-style-type: none"> Comes on when the high beam headlights are on. 	—	—
	Lights On Indicator	<ul style="list-style-type: none"> Comes on whenever the light switch is on, or in AUTO when the exterior lights are on. 	<ul style="list-style-type: none"> If you set the power mode to ACCESSORY or VEHICLE OFF (LOCK) while the exterior lights are on, a chime sounds when the driver's door is opened. 	—
	Fog Light Indicator*	<ul style="list-style-type: none"> Comes on when the fog lights are on. 	—	—

Indicator	Name	On/Blinking	Explanation	Message
 <p>U.S. SIDE AIRBAG OFF Canada</p>	<p>Side Airbag Off Indicator</p>	<ul style="list-style-type: none"> • Comes on for a few seconds when you set the power mode to ON, then goes off. • Comes on when the passenger side airbag system is automatically shut off. 	<ul style="list-style-type: none"> • It does not mean there is a problem with your side airbags. • Comes on when nobody is sitting in the passenger seat - Have the vehicle checked by a dealer. • Comes on when someone is sitting in the seat - Have the passenger sit properly. 	
	<p>Immobilizer System Indicator</p>	<ul style="list-style-type: none"> • Comes on briefly when you set the power mode to ON, then goes off. • Comes on if the immobilizer system cannot recognize the key information. 	<ul style="list-style-type: none"> • Blinks - You cannot start the engine. Set the power mode to VEHICLE OFF (LOCK), then select the ON mode again. • Repeatedly blinks - The system may be malfunctioning. Have the vehicle checked by a dealer. • Do not attempt to alter this system or add other devices to it. Electrical problems can occur. 	<p>—</p>

Indicator	Name	On/Blinking	Explanation	Message
	Security System Alarm Indicator	<ul style="list-style-type: none"> Blinks when the Security System Alarm has been set. 	<p>Security System Alarm P. 106</p>	—
	Keyless Access System Indicator	<ul style="list-style-type: none"> Comes on for a few seconds when you set the power mode to ON. Comes on as soon as a problem is detected in the keyless access system or keyless starting system. 	<ul style="list-style-type: none"> Have your vehicle checked by a dealer. 	 
	CRUISE MAIN Indicator	<ul style="list-style-type: none"> Comes on when you press the CRUISE button. 	<p>Cruise Control P. 229</p>	—
	CRUISE CONTROL Indicator	<ul style="list-style-type: none"> Comes on if you have set a speed for cruise control. 	<p>Cruise Control P. 229</p>	—

Multi-Information Display Warning and Information Messages

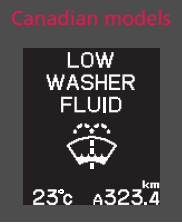

The following messages appear only on the multi-information display. Press the  (information) button to see the message again with the system message indicator on.

Message	Condition	Explanation
	<ul style="list-style-type: none"> Appears when the fuel fill cap is loose or is not installed. 	<p>➤ Check/Tighten Fuel Cap Message P. 321</p>
<p>Canadian models</p> 	<ul style="list-style-type: none"> Appears when the washer fluid is low. 	<ul style="list-style-type: none"> Refill washer fluid. <ul style="list-style-type: none"> ➤ Refilling Window Washer Fluid P. 273
	<ul style="list-style-type: none"> Appears when the scheduled maintenance is due soon. Consequently, SERVICE DUE NOW and SERVICE PAST DUE follow. 	<p>➤ Maintenance Minder Messages on the Multi-Information Display P. 253</p>

QRG

TOC

Instrument Panel

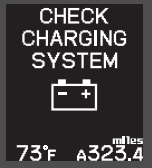
Message	Condition	Explanation
	<ul style="list-style-type: none"> Appears when the engine coolant temperature gets abnormally high. 	<ul style="list-style-type: none"> Overheating P. 318
	<ul style="list-style-type: none"> Appears when the engine coolant temperature gets high. 	<ul style="list-style-type: none"> Drive slowly to prevent overheating.
	<ul style="list-style-type: none"> Appears when there is a problem with the sensor on the battery. Appears when the battery is not charging. 	<ul style="list-style-type: none"> Have your vehicle checked by a dealer. <ul style="list-style-type: none"> Checking the Battery P. 295 Appears along with the battery charging system indicator - Turn off the climate control system and rear defogger to reduce electricity consumption. <ul style="list-style-type: none"> If the Charging System Indicator Comes On P. 320

Index





QRG

TOC

Instrument Panel

Index

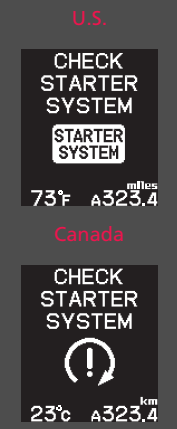
Home

Message	Condition	Explanation
 <p>The image shows two views of the instrument panel. The top view is for the U.S. market, displaying 'CHECK STARTER SYSTEM' and 'STARTER SYSTEM' with a temperature of 73°F and a range of 323.4 miles. The bottom view is for the Canada market, displaying 'CHECK STARTER SYSTEM' with a temperature of 23°C and a range of 323.4 km. Both views include a warning icon of an exclamation mark inside a circle.</p>	<ul style="list-style-type: none"> • Appears when the starting system has a problem. 	<ul style="list-style-type: none"> • As a temporary measure, press and hold the ENGINE START/STOP button for 15 seconds while pressing the brake pedal and manually start the engine. Have the vehicle checked by a dealer.
 <p>The image shows the instrument panel displaying the instruction 'TO START, HOLD REMOTE NEAR START BUTTON' with an icon of a hand holding a key fob near the start button.</p>	<ul style="list-style-type: none"> • Appears if the keyless access remote battery is too weak to start the engine or the key is not with you to start the engine. A beeper sounds six times. 	<p>➤ If the Keyless Access Remote Battery is Weak P. 312</p>
 <p>The image shows the instrument panel displaying the instruction 'TO TURN VEHICLE OFF: PUSH TWICE' with an icon of a hand pushing a button.</p>	<ul style="list-style-type: none"> • Appears after the driver's door is opened when the power mode is in ACCESSORY. 	<ul style="list-style-type: none"> • Press the ENGINE START/STOP button twice with your foot off the brake pedal (automatic transmission) or the clutch pedal (manual transmission) to change the power mode to VEHICLE OFF (LOCK).





QRG





TOC

Instrument Panel

Index

Home

Message	Condition	Explanation
 <p>ACCESSORY MODE</p>	<ul style="list-style-type: none"> Appears when the power mode is in ACCESSORY. 	<p>—</p>
 <p>KEYLESS REMOTE NOT DETECTED</p> <p>73°F A323.4 <small>mi/100s</small></p>	<ul style="list-style-type: none"> Appears when you close the door with the power mode in ON without the keyless access remote inside the vehicle. 	<ul style="list-style-type: none"> Disappears when you bring the keyless access remote back inside the vehicle and close the door. <ul style="list-style-type: none"> ➤ Keyless Access Remote Reminder P. 113
 <p>CHANGE KEYLESS REMOTE BATTERY</p> <p>73°F A323.4 <small>mi/100s</small></p>	<ul style="list-style-type: none"> Appears when the keyless access remote battery becomes weak. 	<ul style="list-style-type: none"> Replace the battery as soon as possible. <ul style="list-style-type: none"> ➤ Replacing the Button Battery P. 296
 <p>TO TURN ACCESSORY ON:PUSH</p>	<ul style="list-style-type: none"> Appears three seconds after the TO START ENGINE message appears. 	<ul style="list-style-type: none"> ➤ Starting the Engine P. 216

Message	Condition	Explanation
<p>TO START ENGINE: BRAKE + PUSH</p>  <p>TO START ENGINE: CLUTCH+PUSH</p> 	<ul style="list-style-type: none"> Appears after you unlock and open the driver's door. 	<p>▶ Starting the Engine P. 216</p>
<p>TO UNLOCK WHEEL: PUSH+ROTATE</p> 	<ul style="list-style-type: none"> Appears when the steering wheel is locked. 	<ul style="list-style-type: none"> Move the steering wheel left and right after pressing the ENGINE START/STOP button.
<p>SHIFT TO PARK</p> 	<ul style="list-style-type: none"> Appears if you push the ENGINE START/STOP button to turn the engine off without the shift lever in P. 	<ul style="list-style-type: none"> Push the ENGINE START/STOP button twice after moving the shift lever to P.

Gauges

Gauges include the speedometer, tachometer, fuel gauge, and related indicators. They are displayed when the power mode is in ON.

■ Speedometer

Displays your driving speed in mph (U.S.) or km/h (Canada).

■ Tachometer

Shows the number of engine revolutions per minute.

■ Fuel Gauge

Displays the amount of fuel left in the fuel tank.

■ Temperature Gauge

Displays the temperature of the engine coolant.

» Fuel Gauge

NOTICE

You should refuel when the needle approaches **E**. Running out of fuel can cause the engine to misfire, damaging the catalytic converter.

The actual amount of remaining fuel may differ from the fuel gauge reading.

» Temperature Gauge

NOTICE

Driving with the temperature gauge pointer in the upper zone can cause serious engine damage. Pull safely to the side of the road and allow engine temperature to return to normal.

[Overheating P. 318](#)

Multi-Information Display

The multi-information display shows the odometer, trip meter, outside temperature indicator, and other gauges. It also displays important messages such as warnings and other helpful information.

Switching the Display

Press the (information) button or the **SEL/RESET** button to change the display.

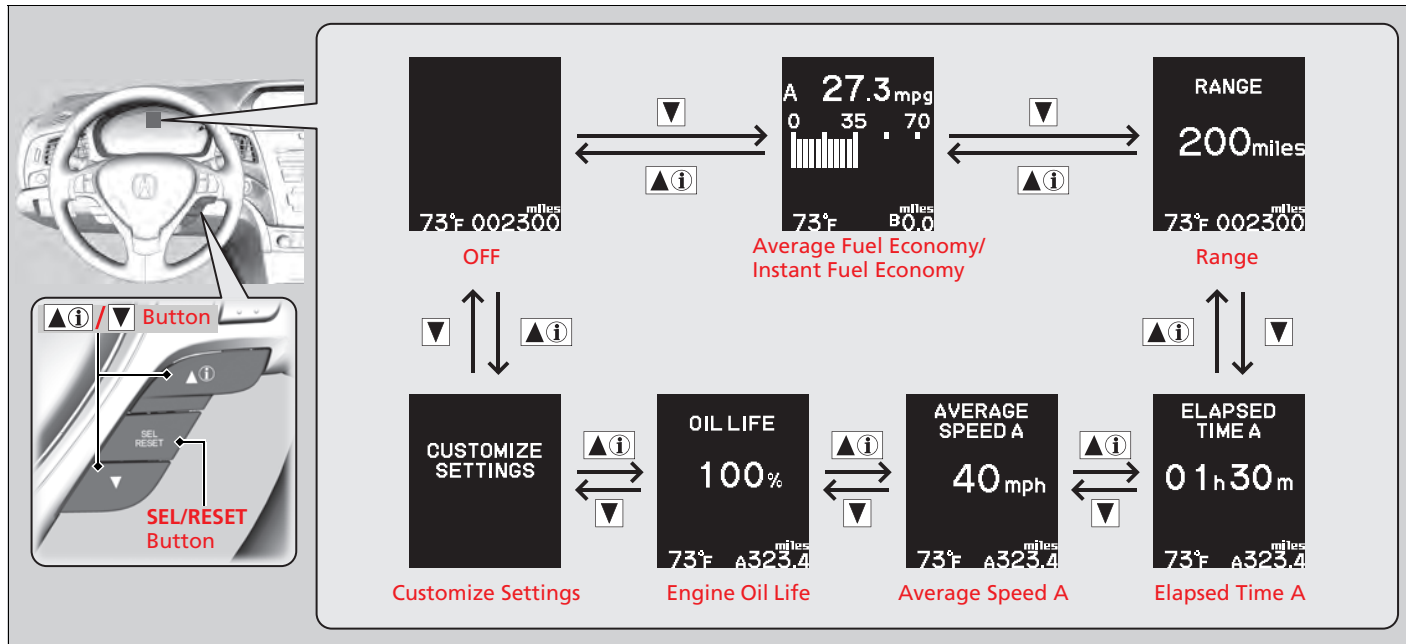

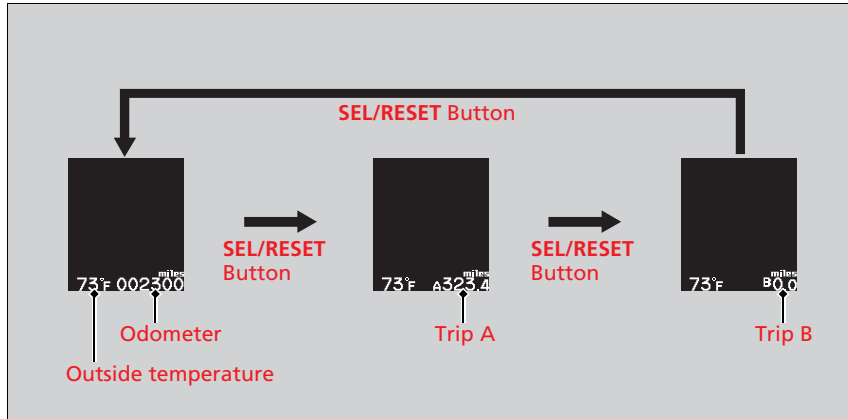

■ Odometer

Shows the total number of miles or kilometers that your vehicle has accumulated.

■ Trip Meter

Shows the total number of miles or kilometers driven since the last reset. Meters A and B can be used to measure two separate trips.

■ Resetting a trip meter

To reset a trip meter, display it, then press and hold the **SEL/RESET** button. The trip meter is reset to **0.0**.

☒ Trip Meter

Switch between trip meter A and trip meter B by pressing the **SEL/RESET** button.

■ Outside Temperature

Shows the outside temperature in Fahrenheit (U.S.) or Celsius (Canada).

■ Adjusting the outside temperature display

Adjust the temperature reading up to $\pm 5^{\circ}\text{F}$ or $\pm 3^{\circ}\text{C}$ if the temperature reading seems incorrect.

■ Average Fuel Economy

Shows the estimated average fuel economy of each trip meter in mpg (U.S.) or l/100 km (Canada). The display is updated at set intervals. When a trip meter is reset, the average fuel economy is also reset.

■ Instant Fuel Economy

Shows the instant fuel economy as a bar graph in mpg or l/100 km.

■ Range

Shows the estimated distance you can travel on the remaining fuel. This distance is estimated from the fuel economy of your trips in the past.

■ Elapsed Time

Shows the time elapsed since the last time Trip A or Trip B was reset.

⌘ Outside Temperature

The temperature sensor is in the front bumper. Road heat and exhaust from another vehicle can affect the temperature reading when your vehicle speed is less than 19 mph (30 km/h).

It may take several minutes for the display to be updated after the temperature reading has stabilized.

Use the multi-information display's customized features to correct the temperature.

➤ [Customized Features P. 83](#)

⌘ Average Fuel Economy

You can change the way the average fuel economy is reset.

➤ [Customized Features P. 83](#)

QRG

■ Average Speed

Shows the average speed in mph or km/h since the last time Trip A or Trip B was reset.

TOC

■ Engine Oil Life

Shows the remaining oil life and Maintenance Minder™.

➤ [Maintenance Minder™ P. 251](#)

Instrument Panel

Index

Home

■ Customized Features

Use the multi-information display to customize certain features.

■ How to customize

Press the button to select **CUSTOMIZE SETTINGS** while the power mode is in ON.

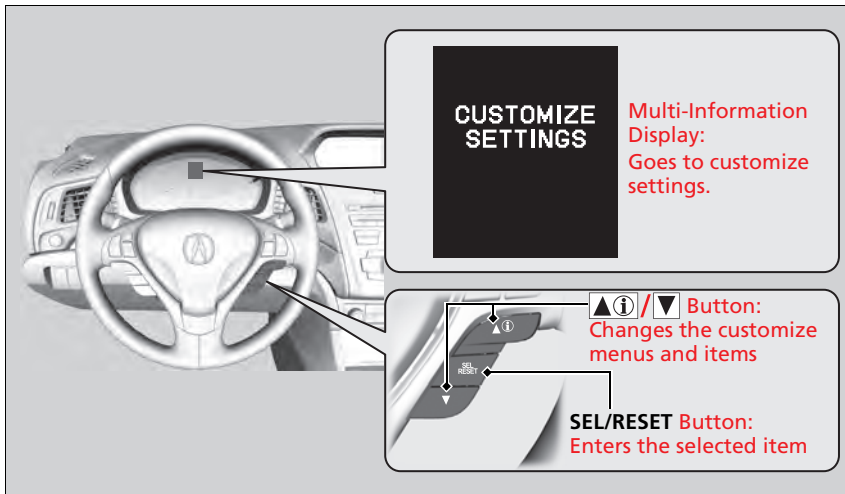

Customized Features

To customize other features, press the button.

[▶ List of customizable options P. 85](#)

When you customize settings:

Automatic transmission models

Shift to **P**

Manual transmission models

Set the parking brake

■ Customization flow

Press the button to select **CUSTOMIZE SETTINGS** and press the **SEL/RESET** button.

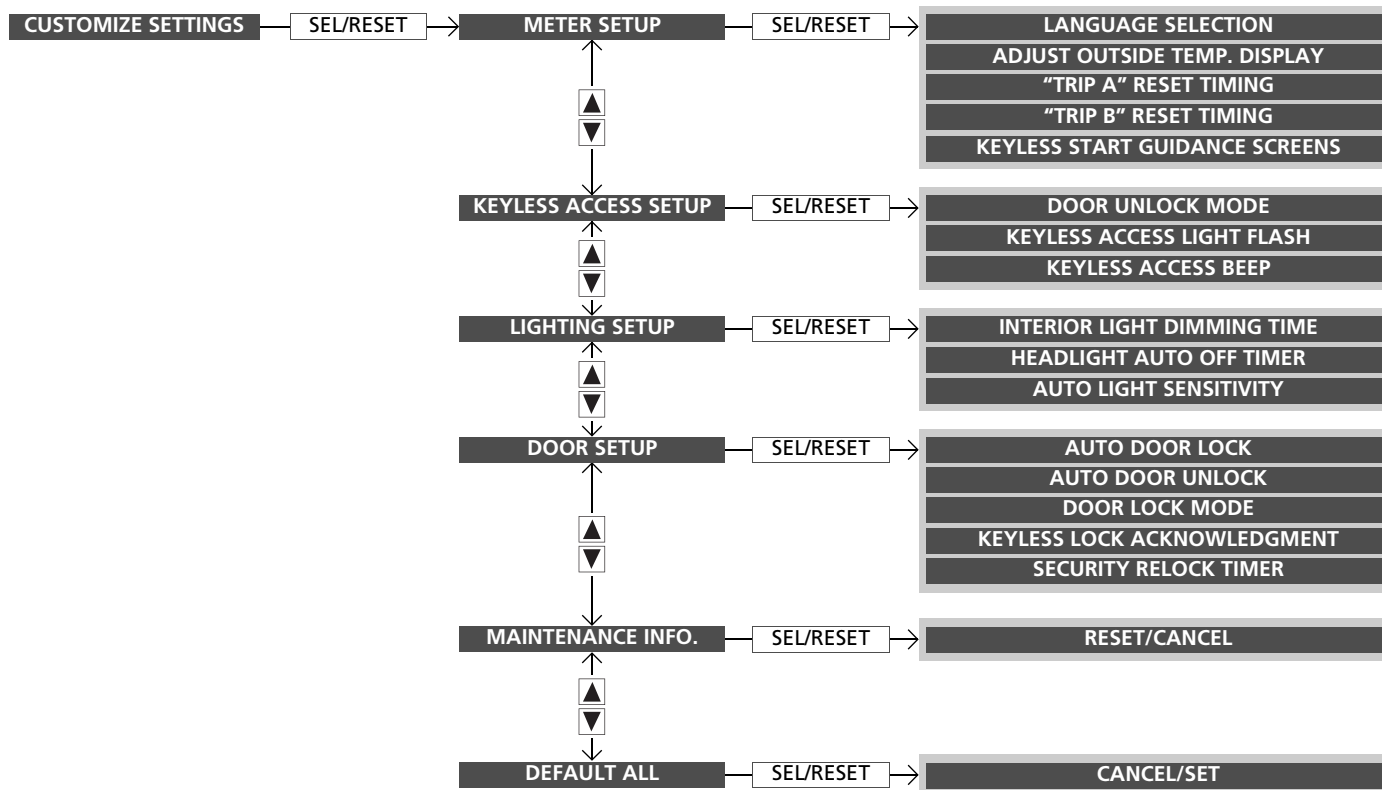

■ List of customizable options

Setup Group	Customizable Features	Description	Selectable settings
METER SETUP	LANGUAGE SELECTION	Changes the displayed language.	ENGLISH*¹/FRENCH/SPANISH
	ADJUST OUTSIDE TEMP. DISPLAY	Adjust the temperature reading by a few degrees.	-5°F ~ ±0°F*¹ ~ +5°F (U.S.) -3°C ~ ±0°C*¹ ~ +3°C (Canada)
	"TRIP A" RESET TIMING	Changes the setting of how to reset trip meter A, average fuel economy A, average speed A, and elapsed time A.	WITH REFUEL/IGN OFF/MANUALLY RESET*¹
	"TRIP B" RESET TIMING	Changes the setting of how to reset trip meter B, average fuel economy B, average speed B, and elapsed time B.	WITH REFUEL/IGN OFF/MANUALLY RESET*¹
	KEYLESS START GUIDANCE SCREENS	Changes the display of the keyless start guidance screens.	ON*¹/OFF
KEYLESS ACCESS SETUP	DOOR UNLOCK MODE	Changes which doors unlock when you grab the driver's door handle.	DRIVER DOOR ONLY*¹/ALL DOORS
	KEYLESS ACCESS LIGHT FLASH	Causes some exterior lights to blink when you unlock/lock the doors.	ON*¹/OFF
	KEYLESS ACCESS BEEP	Causes the beeper to sound when you unlock/lock the doors.	ON*¹/OFF

*1: Default Setting





Setup Group	Customizable Features	Description	Selectable settings
LIGHTING SETUP	INTERIOR LIGHT DIMMING TIME	Changes the length of time the interior lights stay on after you close the doors.	60sec/30sec^{*1}/15sec
	HEADLIGHT AUTO OFF TIMER	Changes the length of time the exterior lights stay on after you close the driver's door.	60sec/30sec/15sec^{*1}/0sec
	AUTO LIGHT SENSITIVITY	Changes the timing for the headlights to come on.	MAX/HIGH/MID^{*1}/LOW/MIN
DOOR SETUP	AUTO DOOR LOCK	Changes the setting for the automatic locking feature.	OFF/WITH VEH SPD^{*1}/SHIFT FROM (A/T only)
	AUTO DOOR UNLOCK	Changes the setting for when the doors unlock automatically.	OFF/DRIVER DOOR with SHIFT to ^{*2} (A/T only)/ALL DOORS with SHIFT to (A/T only)/DRIVER DOOR with IGN OFF^{*3}/ALL DOORS with IGN OFF
	DOOR LOCK MODE	Sets up either the driver's door or all doors to unlock on the first operation of the remote or built-in key.	DRIVER DOOR^{*1}/ALL DOORS
	KEYLESS LOCK ACKNOWLEDGMENT	LOCK/UNLOCK - The exterior lights flash LOCK (2nd push) - The beeper sounds	ON^{*1}/OFF
	SECURITY RELOCK TIMER	Changes the time it takes for the doors to relock and the security system to set after you unlock the vehicle without opening any door.	90sec/60sec/30sec^{*1}

*1:Default Setting

*2:Default Setting for automatic transmission

*3:Default Setting for manual transmission

QRG

Setup Group	Customizable Features	Description	Selectable settings
MAINTENANCE INFO.		Reset the Maintenance Minder™.	RESET/CANCEL
DEFAULT ALL		Sets/Cancel all the customized settings as default.	CANCEL/SET

TOC

Instrument Panel

Index



■ Example of customization settings

The steps for changing the **"TRIP A" RESET TIMING** setting to **ON** are shown below. The default setting for **"TRIP A" RESET TIMING** is **MANUALLY RESET**.

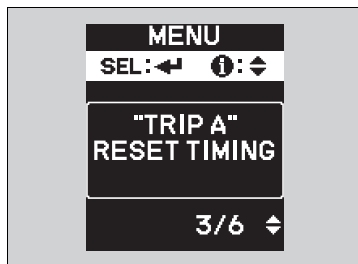
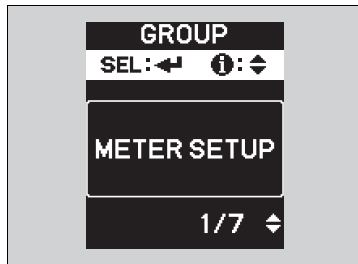
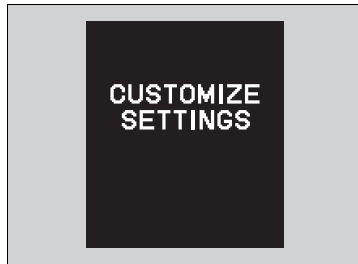

1. Press and release the /▼ button until **CUSTOMIZE SETTINGS** appears on the display.

2. Press the **SEL/RESET** button to go into the **METER SETUP** group.

3. Press the **SEL/RESET** button again.
 - **LANGUAGE SELECTION** appears first on the display.

4. Press the /▼ button until **"TRIP A" RESET TIMING** appears on the display, then press the **SEL/RESET** button.
 - The display switches to the **SETUP** screen, where you can select **WITH REFUEL**, **IGN OFF**, **MANUALLY RESET**, or **EXIT**.



5. Press the button and select **MANUALLY RESET**, then press the **SEL/RESET** button.
 - The **MANUALLY RESET** setup screen appears, then the display returns to the customize item screen.

6. Press the button until **EXIT** appears on the display, then press the **SEL/RESET** button.

7. Repeat Step 6 until you return to the normal screen.

Controls

This chapter explains how to operate the various controls necessary for driving.



- Setting the Clock** 92
- Locking and Unlocking the Doors**
 - Key Types and Functions 93
 - Low Keyless Access Remote Signal Strength 94
 - Locking/Unlocking the Doors from the Outside 95
 - Locking/Unlocking the Doors from the Inside 99
 - Childproof Door Locks 100
 - Auto Door Locking/Unlocking 101
- Opening and Closing the Trunk** 102
- Security System** 106
 - Immobilizer System 106

- Security System Alarm 106
- Opening and Closing the Windows** 108
- Opening and Closing the Moonroof** 111
- Operating the Switches Around the Steering Wheel**
 - ENGINE START/STOP Button 112
 - Turn Signals 114
 - Light Switches 114
 - Fog Lights* 117
 - Daytime Running Lights 117
 - Wipers and Washers 118
 - Brightness Control 119
 - Rear Defogger/Heated Door Mirror Button 120
 - Adjusting the Steering Wheel 120

- Adjusting the Mirrors** 121
 - Interior Rearview Mirror 121
 - Power Door Mirrors 122
- Adjusting the Seats** 123
 - Adjusting the Seat Positions 123
- Interior Lights/Interior Convenience Items** 131
 - Interior Lights 131
 - Interior Convenience Items 132
- Climate Control System** 136
 - Using Automatic Climate Control 136
 - Synchronized Mode 138
 - Automatic Climate Control Sensors 139



* Not available on all models

Clock

Models without navigation system

You can adjust the time in the clock display, with the power mode in ON.

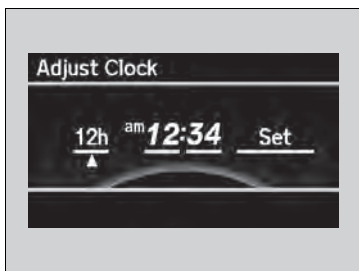
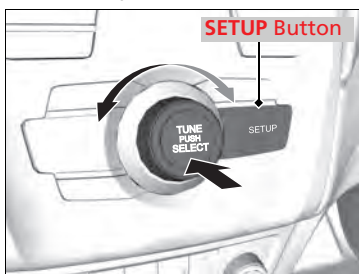

1. Press the **SETUP** button.
2. Rotate to select **Adjust Clock** on the screen.
3. Press . **Adjust Clock** appears.
4. Rotate to select the item you want to adjust (12/24 hour mode, hour, minute). Then press .
5. Rotate to make the adjustment.
6. Press to enter your selection. The display returns to **Adjust Clock**. Repeat steps 4 to 6 to adjust other items.
7. To enter the selection, rotate and select **Set**, then press .

⌂ Clock

These indications are used to show how to operate the selector knob. Rotate to select. Press to enter.

Models with navigation system

The clock is automatically updated through the navigation system, so the time does not need to be adjusted.

Key Types and Functions

This vehicle comes with the following keys:

Keys

Keyless access remote



Use the keyless access remote to start and stop the engine, to lock and unlock the doors and to open the trunk.

There is a **PANIC** button in the remote transmitter.

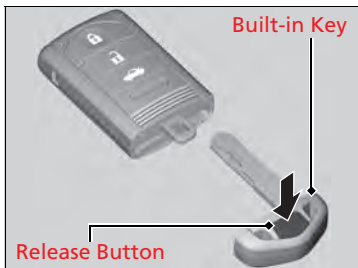

The built-in key can be used to lock/unlock the doors when the keyless access remote battery becomes weak and the power door lock/unlock operation is disabled.

To remove the built-in key, pull it out while pressing the release button. To reinstall the built-in key, push the built-in key into the keyless access remote until it clicks.

Key Types and Functions

All of the keys have an immobilizer system. The immobilizer system helps to protect against vehicle theft.

[Immobilizer System P. 106](#)

The keys contain precision electronics. Adhere to the following advice to prevent damage to the electronics:

- Do not leave the keys in direct sunlight, or in locations with high temperature or high humidity.
- Do not drop the keys or set heavy objects on them.
- Keep the keys away from liquids.
- Do not take the keys apart except for replacing the battery.

If the circuits in the keys are damaged, the engine may not start, and the keyless access system may not work.

If the keys do not work properly, have them inspected by a dealer.

■ Key Number Tag

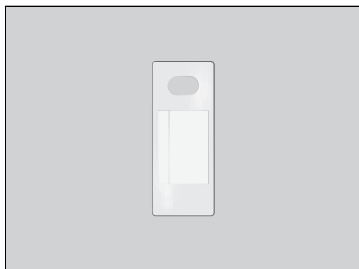

Contains a number that you will need if you purchase a replacement key.

Low Keyless Access Remote Signal Strength

The vehicle transmits radio waves to locate the keyless access remote when locking/unlocking the doors, opening the trunk, or to start the engine.

In the following cases, locking/unlocking the doors, opening the trunk, or starting the engine may be inhibited or operation may be unstable:

- Strong radio waves are being transmitted by nearby equipment.
- You are carrying the keyless access remote together with telecommunications equipment, laptop computers, cell phones, or wireless devices.
- A metallic object is touching or covering the keyless access remote.

☒ Key Number Tag

Keep the key number tag separate from the key in a safe place outside of your vehicle. If you wish to purchase an additional key, contact a dealer.

If you lose your key and you cannot start the engine, contact a dealer.

☒ Low Keyless Access Remote Signal Strength

Communication between the keyless access remote and the vehicle consumes the keyless access remote's battery.

Battery life is about two years, but this varies depending on regularity of use.

The battery is consumed whenever the keyless access remote is receiving strong radio waves. Avoid placing it near electrical appliances such as televisions and personal computers.

Locking/Unlocking the Doors from the Outside

■ Using the Remote Transmitter



■ Locking the doors

Press the LOCK button.

Once:

- ▶ Some exterior lights flash, all the doors lock, and the security system sets.

Twice (within five seconds after the first push):

- ▶ A beeper sounds and verifies the security system is set.

■ Unlocking the doors

Press the UNLOCK button.

Once:

- ▶ Some exterior lights flash twice, and the driver's door unlocks.

Twice:

- ▶ The remaining doors unlock.

☒ Locking/Unlocking the Doors from the Outside

You can lock or unlock doors using the remote transmitter or keyless access system only when the power mode is in VEHICLE OFF.

☒ Using the Remote Transmitter

If you do not open a door within 30 seconds of unlocking the vehicle with the remote transmitter, the doors will automatically relock.

You can change the relock timer setting.

➤ [Customized Features P. 83](#)

If the interior light switch is in the door activated position, the interior lights come on when you press the UNLOCK button.

No doors opened: The lights fade out after 30 seconds.

Doors relocked with the remote: The lights go off immediately.

➤ [Interior Lights P. 131](#)

The remote transmitter uses low-power signals, so the operating range may vary depending on the surroundings.

The remote will not lock the vehicle when a door is open.

■ Using the Keyless Access System

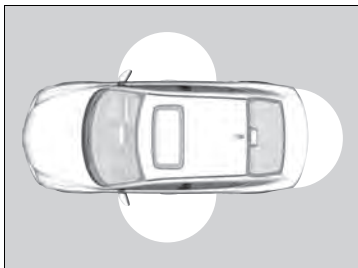

When you carry the keyless access remote, you can lock/unlock the doors and open the trunk.

You can lock/unlock the doors within a radius of about 32 inches (80 cm) of the outside door handle. You can open the trunk within about 32 inches (80 cm) radius from the trunk release button.

■ Locking the vehicle

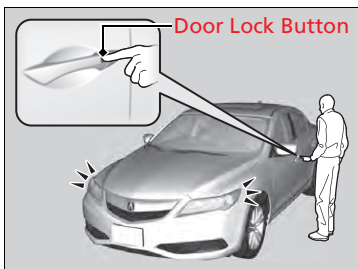

Press the door lock button on the front door.

- ▶ Some exterior lights flash; the beeper sounds; all the doors lock; and the security system sets.

▣ Using the Keyless Access System

- Do not leave the keyless access remote in the vehicle when you get out. Carry it with you.
- A person who is not carrying the keyless access remote can lock/unlock the doors if a person who is carrying it is within range.
- The door may be unlocked if the door handle is covered with water in heavy rain or in a car wash if the keyless access remote is within range.
- If you grip a front door handle wearing gloves, the door sensor may be slow to respond or may not respond by unlocking the doors.
- The door might not open if you pull it immediately after gripping the door handle. Grip the handle again and confirm that the door is unlocked before pulling the handle.

If the distance at which it works varies, the battery is probably low.

If the LED does not come on when you press a button, the battery is dead.

[▶ Replacing the Button Battery P. 296](#)

You can customize the door lock mode and keyless lock acknowledgement setting.

[▶ Customized Features P. 83](#)

■ **Unlocking the vehicle**

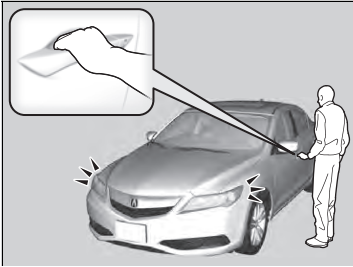

- Grab the driver's door handle:
- ▶ The driver's door unlocks.
 - ▶ Some exterior lights flash twice and the beeper sounds twice.

- Grab the front passenger's door handle:
- ▶ All the doors unlock.
 - ▶ Some exterior lights flash twice and the beeper sounds twice.

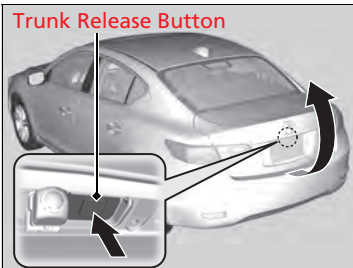

- Press the trunk release button:
- ▶ The trunk unlocks and opens.
 - ▶ A beeper will sound.
- [Using the Trunk Release Button P. 103](#)

⌘ **Using the Keyless Access System**

- Even within the 32 inches (80 cm) radius, you may not be able to lock/unlock the doors with the keyless access remote if it is above or below the outside handle.
- The keyless access remote may not operate if it is too close to the door and door glass.

If you do not open a door within 30 seconds of unlocking the vehicle, the doors will automatically relock.

The light flash, beep and unlock settings can be customized using the multi-information display.

➤ [Customized Features P. 83](#)

■ Locking/Unlocking the Doors Using a Key



Fully insert the key and turn it.

▶▶ Locking/Unlocking the Doors Using a Key

When you lock the driver's door with a key, all the other doors lock at the same time. When unlocking, the driver's door unlocks first. Turn the key a second time within a few seconds to unlock the remaining doors.

You can customize the door unlock mode setting.

[▶▶ Customized Features P. 83](#)

■ Locking a Door Without Using a Key

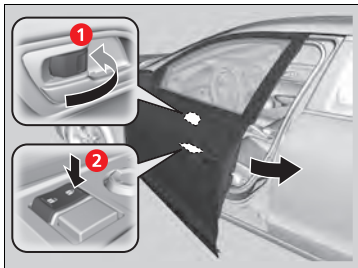

■ Locking the front doors

Push the lock tab forward **1** or push the master door lock switch in the lock direction **2**, and close the door.

■ Locking the rear doors

Push the lock tab forward and close the door.

▶▶ Locking a Door Without Using a Key

When you lock the driver's door, all the other doors lock at the same time.

Make sure you have the key in your hand before locking the door to prevent it from being locked in the vehicle.

■ Lockout prevention system

The doors cannot be locked when the keyless access remote is inside the vehicle, and any door is open.

Locking/Unlocking the Doors from the Inside

■ Using the Lock Tab

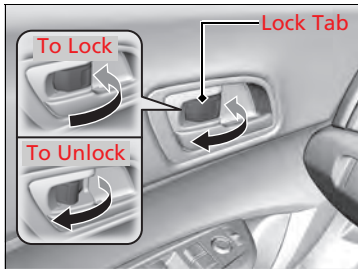

■ **Locking a door**
Push the lock tab forward.

■ **Unlocking a door**
Pull the lock tab rearward.

■ Unlocking Using the Inner Handle of Front Doors

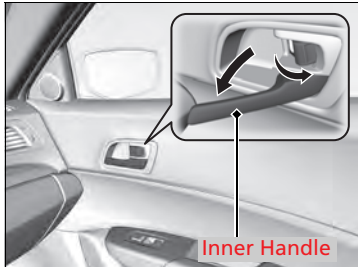

Pull the front door inner handle.
▶ The door unlocks and opens in one motion.

☒ Using the Lock Tab

When you lock the door using the lock tab on the driver's door, all the other doors lock at the same time.

When you unlock the door using the lock tab on the driver's door, only the driver's door will unlock.

☒ Unlocking Using the Inner Handle of Front Doors

The inner front door handles are designed to allow front seat occupants to open the door in one motion. However this feature requires that front seat occupants never pull a front door inner handle while the vehicle is in motion.

Children should always ride in a rear seat where childproof door locks are provided.

▶ [Childproof Door Locks P. 100](#)

■ Using the Master Door Lock Switch

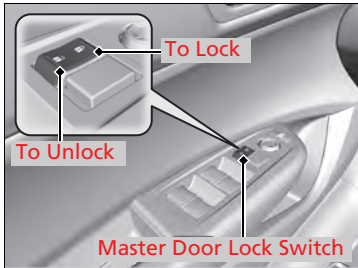

Press the master door lock switch in as shown to lock or unlock all doors.

Childproof Door Locks

The childproof door locks prevent the rear doors from being opened from the inside regardless of the position of the lock tab.

■ Setting the Childproof Door Locks

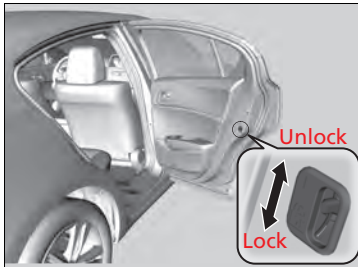

Slide the lever in the rear door to the lock position, and close the door.

■ **When opening the door**
Open the door using the outside door handle.

☒ Using the Master Door Lock Switch

When you lock/unlock either front door using the master door lock switch, all the other doors lock/unlock at the same time.

☒ Childproof Door Locks

To open the door from the inside when the childproof door lock is on, put the lock tab in the unlock position, lower the rear window, put your hand out of the window, and pull the outside door handle.

Auto Door Locking/Unlocking

Your vehicle locks all doors and unlocks the driver's door automatically when a certain condition is met.

Auto Door Locking

Drive lock mode

All doors lock when the vehicle's speed reaches about 10 mph (15 km/h).

Auto Door Unlocking

Models with automatic transmission

Park unlock mode

The driver's door unlocks when the shift lever is moved into **P** with the brake pedal depressed.

Models with manual transmission

Power mode unlock mode

The driver's door unlocks when the power mode is changed from ON.

The settings can be changed to unlock all doors.

Auto Door Locking/Unlocking

You can turn off or change to another auto door locking/unlocking setting using the multi-information display.

[▶ Customized Features P. 83](#)

Precautions for Opening/Closing the Trunk

■ Opening the trunk

Open the trunk all the way.

- ▶ If it is not fully opened, the trunk lid may begin to close under its own weight.

■ Closing the trunk

Keep the trunk lid closed while driving to:

- ▶ Avoid possible damage.
- ▶ Prevent exhaust gas from leaking into the vehicle.

➤ [Exhaust Gas Hazard P. 60](#)

Using the Trunk Opener



Pulling the trunk release to the lower left of the driver's seat unlocks and opens the trunk.

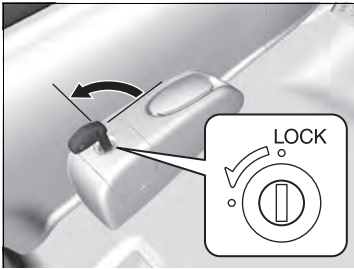

■ Locking the trunk opener

You can lock the trunk release with the built-in key.

Using the Trunk Release Button

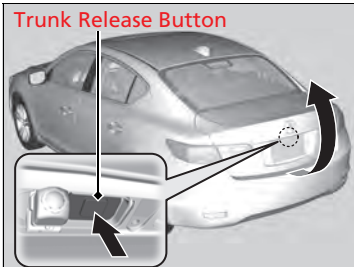

Push up the release button on the trunk lid after the doors are unlocked.

Even if the trunk is locked, you can open the trunk if you carry the keyless access remote.

▶ A beeper will sound.

▣ Using the Trunk Release Button

- Do not leave the keyless access remote in the vehicle when you get out. Carry it with you.
- A person who is not carrying the keyless access remote can unlock the trunk if a person who is carrying it is within range.
- Do not leave the keyless access remote inside the trunk and close the lid. The beeper sounds and the trunk cannot be closed.

Using the Remote Transmitter

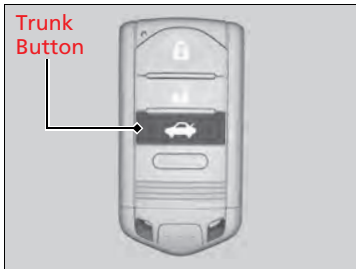

Press the trunk release button for approximately one second to unlock and open the trunk.

Trunk Main Switch

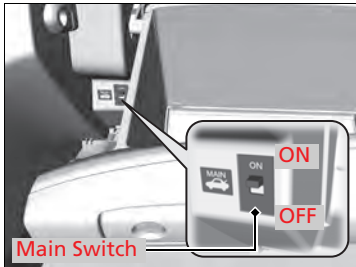

The trunk main switch disables the trunk release button on the remote transmitter and the trunk release button on the trunk lid to protect luggage in the trunk.

1. Make sure the rear seat-back is not folded down.
2. Turn off the trunk main switch in the glove box.
3. Lock the glove box.
4. Lock the trunk release.

[▶ Using the Trunk Opener P. 102](#)

▶▶ Trunk Main Switch

If you need to give the key to someone else, remove the built-in key from the keyless access remote by pressing the release button, and give the remote as a valet key.

QRG

Emergency Trunk Opener

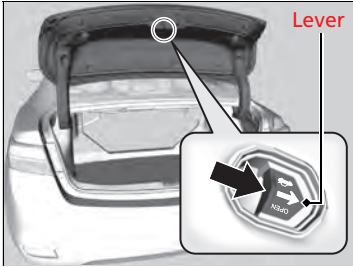

The trunk release lever allows you to open the trunk from inside for your safety.

Slide the release lever in the direction of the arrow.

Emergency Trunk Opener

Parents should decide if their children should be shown how to use this feature.

TOC

Controls

Index

Home

Immobilizer System

The immobilizer system prevents a key that has not been pre-registered from starting the engine. Each key contains electronic transmitters that use electronic signals to verify the key.

Pay attention to the following when pressing the **ENGINE START/STOP** button:

- Do not allow objects that emit strong radio waves near the **ENGINE START/STOP** button.
- Make sure the key is not covered by or touching a metal object.
- Do not bring a key from another vehicle's immobilizer system with the keyless access remote.

Security System Alarm

The security system alarm activates when the trunk, hood, or doors are opened without the key, or remote transmitter, or keyless access system.

■ When the security system alarm activates

The horn sounds intermittently and all of the exterior lights flash.

■ To deactivate the security system alarm

Unlock the vehicle using the key, remote transmitter or keyless access remote. The system, along with the horn and flashing lights, is deactivated.

☞ Immobilizer System

NOTICE

Leaving the keyless access remote in the vehicle can result in theft or accidental movement of the vehicle. Always take the key with you whenever you leave the vehicle unattended.

Do not alter the system or add other devices to it. Doing so may damage the system and make your vehicle inoperable.

☞ Security System Alarm

The security alarm continues for a maximum of two minutes until the security system deactivates.

■ Setting the security system alarm

The security system alarm automatically sets when the following conditions have been met:

- The power mode is set to VEHICLE OFF (LOCK).
- The hood and trunk are closed.
- All doors are locked from outside with the key, remote transmitter or keyless access system.

■ When the security system alarm sets

The security system indicator in the instrument panel blinks. When the blinking interval changes after about 15 seconds, the security system is set.

■ To cancel the security system alarm

The security system is canceled when the vehicle is unlocked using the key or remote transmitter, or you grab either front door handle while carrying the keyless access remote. The security system indicator goes off at the same time.

▣ Security System Alarm

Do not set the security system alarm when someone is in the vehicle or a window is open. The system can accidentally activate when:

- Unlocking the door with the lock tab.
- Opening the trunk with the trunk release or the emergency trunk opener.

If the battery goes dead after you have set the security system alarm, the security alarm may go off once the battery is recharged or replaced.

If this occurs, deactivate the security system alarm by unlocking a door using the key, remote transmitter, or keyless access system.

Do not attempt to alter this system or add another device to it.

■ Panic Mode



■ The PANIC button on the remote transmitter

If you press the **PANIC** button for approximately one second, the following will occur for about 30 seconds:

- The horn sounds.
- Some exterior lights flash.

■ Canceling panic mode

Press any button on the remote transmitter, or set the power mode to ON.

Opening/Closing the Power Windows

The power windows can be opened and closed when the power mode is in ON, using the switches on the doors. The driver's side switches can be used to open and close all of the windows.

The power window lock button on the driver's side must be switched off (not pushed in, indicator off) to open and close the windows from anywhere other than the driver's seat.

When the power window lock button is pushed in, the indicator comes on and you can only operate the driver's window. Turn the power window lock button on when children are in the vehicle.

Opening/Closing Windows with Auto-Open/Close Function

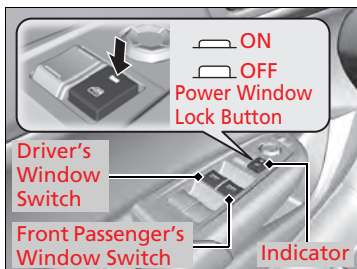

Automatic operation

To open: Push the switch down firmly.

To close: Pull the switch up firmly.

The window opens or closes completely. To stop the window at any time, push or pull the switch briefly.

Manual operation

To open: Push the switch down lightly.

To close: Pull the switch up lightly.

Release the switch when the window reaches the desired position.

Opening/Closing the Power Windows

WARNING

Closing a power window on someone's hands or fingers can cause serious injury.

Make sure your passengers are away from the windows before closing them.

The power windows can be operated for up to 10 minutes after you set the power mode to VEHICLE OFF (LOCK).
Opening either front door cancels this function.

Auto Reverse

If a power window senses resistance when closing automatically, it will stop closing and reverse direction.

The driver's window auto reverse function is disabled when you continuously pull up the switch.

The auto reverse function stops sensing when the window is almost closed to ensure that it fully closes.

■ Opening/Closing Windows without Auto-Open/Close Function

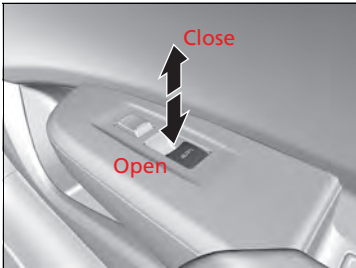

To open: Push the switch down.

To close: Pull the switch up.

Release the switch when the window reaches the desired position.

■ Opening Windows and Moonroof with the Remote

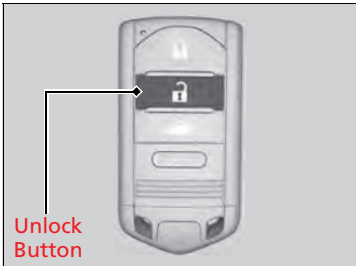

To open: Press the UNLOCK button twice within 10 seconds and hold it down for the second time. If the windows stop midway, repeat the procedure.

■ Opening/Closing the Windows/Moonroof with the Key

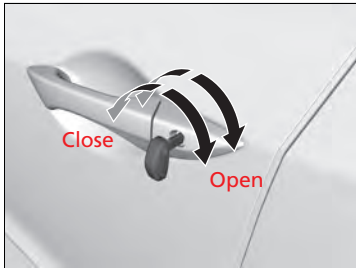

To open: Unlock the driver's door with the key. Within 10 seconds of returning the key to the central position, turn the key in the unlock direction and hold it there.

To close: Lock the driver's door with the key. Within 10 seconds of returning the key to the central position, turn the key in the lock direction and hold it there.

Release the key to stop the windows/moonroof at the desired position. If you want further adjustment, repeat the same operation.

Opening/Closing the Moonroof

You can only operate the moonroof when the power mode is in ON. Use the switch in the front of the ceiling to open and close the moonroof.

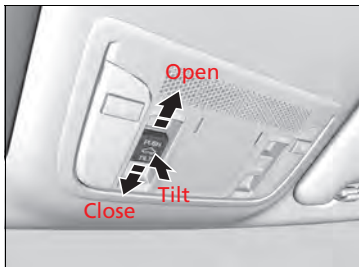

Automatic operation

To open: Pull the switch back firmly, then release.

To close: Push the switch forward firmly, then release.

The moonroof will automatically open or close all the way. To stop the moonroof midway, touch the switch briefly.

Manual operation

To open: Pull the switch back, and hold it until the desired position is reached.

To close: Push the switch forward, and hold it until the desired position is reached.

Tilting the moonroof up

To tilt: Push on the center of the moonroof switch.

To close: Push the switch forward firmly, then release.

Opening/Closing the Moonroof

WARNING

Opening or closing the moonroof on someone's hands or fingers can cause serious injury.

Make sure all hands and fingers are clear of the moonroof before opening or closing it.

NOTICE

Opening the moonroof in below freezing temperature or when it is covered with snow or ice can damage the moonroof panel or motor.

The power moonroof can be operated for up to 10 minutes after you set the power mode to VEHICLE OFF (LOCK).

Opening either front door cancels this function.

When resistance is detected, the auto reverse function causes the moonroof to change directions, then stop. Auto reverse stops sensing when the moonroof is almost closed to ensure that it fully closes. Make sure that all objects, including fingers, are clear of the moonroof.

ENGINE START/STOP Button

Changing the Power Mode

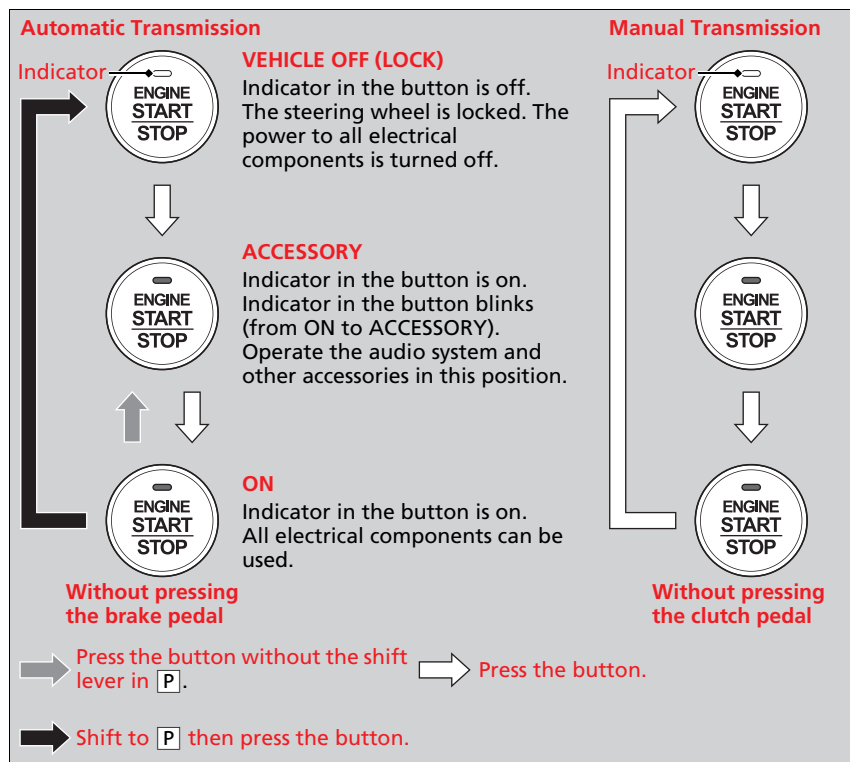

ENGINE START/STOP Button

ENGINE START/STOP Button Operating Range

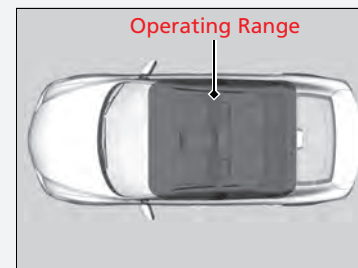

You can start the engine when the keyless access remote is inside the vehicle.

The engine may also run if the keyless access remote is close to the door or window, even if it is outside the vehicle.

ON mode:

Indicator in the button is off, if the engine is running.

If the keyless access remote battery is weak, beeper sounds and the **TO START, HOLD REMOTE NEAR START BUTTON** message appears on the multi-information display.

▶ If the Keyless Access Remote Battery is Weak P. 312

■ Power Mode Reminder

If you open the driver's door when the power mode is set to ACCESSORY, a warning buzzer sounds.

■ Keyless Access Remote Reminder

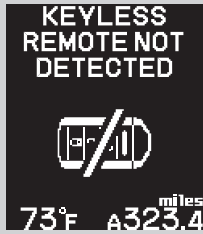

Warning buzzers may sound from inside or/ and outside the vehicle to remind you that the keyless access remote is out of the vehicle. If the buzzer continues even after the remote is put back inside, place it to be within its operational range.

■ When the power mode is in ON

If the keyless access remote is taken out of the vehicle, and the driver's door is closed, warning buzzers sound from both inside and outside the vehicle. A warning message on the multi-information display notifies the driver inside that the remote is out.

■ When the power mode is in ACCESSORY or in VEHICLE OFF (LOCK)

If the keyless access remote is taken out of the vehicle, and the driver's door is closed, a warning buzzer sounds from outside the vehicle.

▶ Keyless Access Remote Reminder

When the keyless access remote is within the system's operational range, and the driver's door is closed, the warning function cancels.

If the keyless access remote is taken out of the vehicle after the engine has been started, you can no longer change the **ENGINE START/STOP** button mode or restart the engine. Always make sure if the remote is in your vehicle when you operate the **ENGINE START/STOP** button.

Removing the keyless access remote from the vehicle through a window does not activate the warning buzzer.

Do not put the keyless access remote on the dashboard or in the glove box. It may cause the warning buzzer to go off. Under some other conditions that can prevent the vehicle from locating the remote, the warning buzzer may also go off even if the remote is within the system's operational range.

Turn Signals

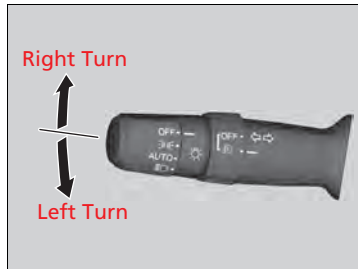

The turn signals can be used when the power mode is in ON.

■ One-touch turn signal

When you lightly push up or down and release the turn signal lever, the exterior turn signals and turn signal indicator blink three times.

This feature can be used when signaling for a lane change.

Light Switches

■ Manual Operation

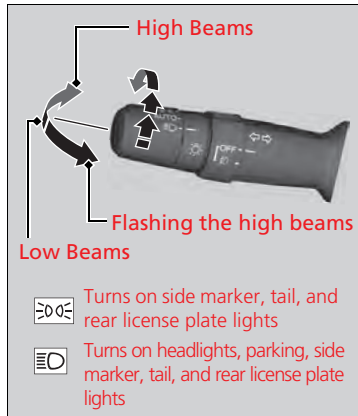

Rotating the light switch turns the lights on and off, regardless of the power model setting.

■ High beams

Push the lever forward until you hear a click.

■ Low beams

When in high beams, pull the lever back to return to low beams.

■ Flashing the high beams

Pull the lever back, and release it.

⊗ Light Switches

If you leave the power mode in VEHICLE OFF (LOCK) with the lights on, a light on reminder chime will sound when you open the driver's door.

When the lights are on, the lights on indicator in the instrument panel will be on.

[▶ Lights On Indicator P. 70](#)

Models with high voltage discharge tube bulb

Repeatedly turning the headlights on and off reduces the life of the HID headlight bulbs.

If you sense that the level of the headlights is abnormal, have the vehicle inspected by a dealer.

Do not leave the lights on when the engine is off because it will cause the battery to discharge.

Your vehicle is equipped with the automatic headlight adjusting system that automatically adjusts the vertical angle of the low beam headlights. If you find a significant change in the vertical angle of the headlights, there may be a problem with the system. Have your vehicle checked by a dealer.

Automatic Lighting Control

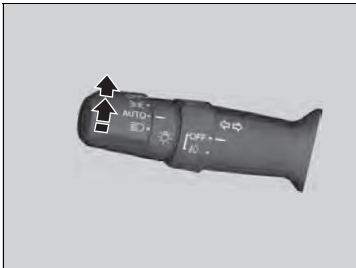

Automatic lighting control can be used when the power mode is in ON.

When you turn the light switch to **AUTO**, the headlights and other exterior lights will switch on and off automatically depending on the ambient brightness.

You can change the auto light sensitivity setting.

[▶ Customized Features P. 83](#)

Automatic Lighting Control

We recommend that you turn on the lights manually when driving at night, in a dense fog, or in dark areas such as long tunnels or parking facilities.

The light sensor is in the location shown below. Do not cover this light sensor with anything; otherwise, the automatic lighting system may not work properly.

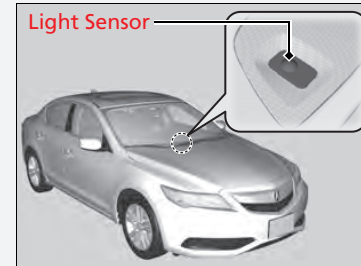

Adjust the auto light sensitivity as follows:

Setting	The exterior lights come on when the ambient light is at	
MAX		Bright
HIGH		
MID		
LOW		Dark
MIN		

[▶ Customized Features P. 83](#)

■ Headlight Integration with Wiper*

The headlights automatically come on when the wipers are used several times within a certain intervals with the headlight switch in **AUTO**.
The headlights automatically go off a few minutes later if the wipers are stopped.

■ Automatic Lighting Off Feature

The headlights, all other exterior lights, and the instrument panel lights turn off within 15 seconds after the door is opened and closed with the power mode in VEHICLE OFF (LOCK).

If you set the power mode to VEHICLE OFF (LOCK) with the headlight switch on, but do not open the door, the lights turn off after 10 minutes (three minutes, if the switch is in the **AUTO** position).

The lights turn on again when you unlock or open the driver's door. If you unlock the door, but do not open it within 15 seconds, the lights go off. If you open the driver's door, you will hear a lights on reminder chime.



▣ Headlight Integration with Wiper*

This feature activates during the headlights are off in **AUTO**.

The instrument panel brightness does not change when the headlights come on.

When the ambient light is at dark, the automatic lighting control feature overrides, and the headlights come on with or without the wipers sweeping more than several times.

▣ Automatic Lighting Off Feature

You can change the headlight auto off timer setting.
[▶ Customized Features P. 83](#)

Fog Lights*

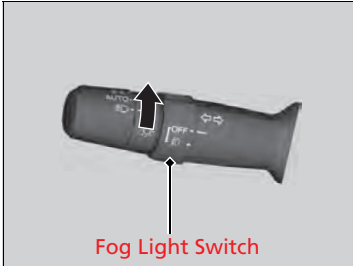

When the low beam headlights are on, turn the fog light switch on to use the fog lights.

☒ Fog Lights*

The fog lights go off when the headlights turn off, or when the daytime running lights are on.

▶ [Fog Light Indicator*](#) P. 70

Daytime Running Lights

The high beam headlights come on slightly dimmer than normal when the following conditions have been met:

- The power mode is in ON.
- The headlight switch is off, or in .
- The parking brake is released.

The lights remain on even if you set the parking brake. Setting the power mode to VEHICLE OFF turns off the daytime running lights.

The high beam headlights return to the original brightness once the headlight switch is turned on.

Wipers and Washers

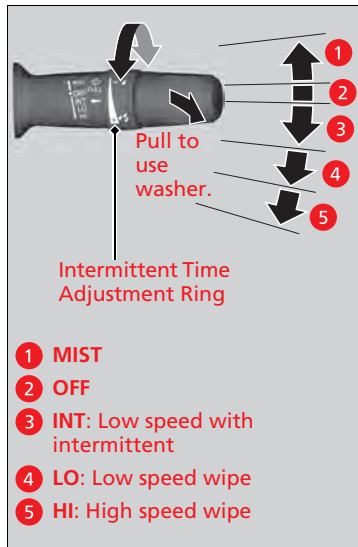

The windshield wipers and washers can be used when the power mode is in ON.

■ MIST

The wipers run at high speed until you release the lever.

■ Wiper switch (OFF, INT, LO, HI)

Change the wiper switch setting according to the amount of rain.

■ Adjusting the delay

Turn the adjustment ring to adjust the wiper delay.

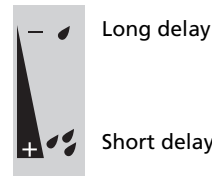

■ Washer

Sprays while you pull the lever toward you. When you release the lever, the wipers make two or three more sweeps before stopping.

Wipers and Washers

NOTICE

Do not use the wipers when the windshield is dry. The windshield will get scratched, or the rubber blades will get damaged.

NOTICE

In cold weather, the blades may freeze to the windshield, becoming stuck.

Operating the wipers in this condition may damage the wipers. Use the defroster to warm the windshield, then turn the wipers on.

If the vehicle speeds up while the wipers are operating intermittently, the length of the wipe interval shortens.

When the vehicle starts moving, the wipers make a single sweep.

When the vehicle speeds up, the wiper operation's shortest delay setting (🌀) and the **LO** setting become the same.

Turn the washers off if no washer fluid comes out. The pump may get damaged.

The wiper motor is equipped with a breaker that may stop motor operation temporarily to prevent an overload. Wiper operation will return to normal within a few minutes, once the circuit has returned to normal.

Brightness Control

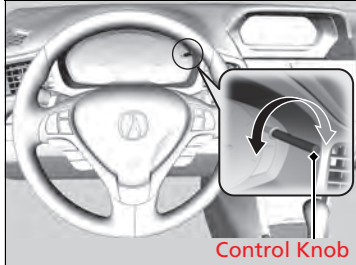

When the power mode is in ON, you can use the brightness control knob to adjust instrument panel brightness.

Brighten: Turn the knob to the right.

Dim: Turn the knob to the left.

You will hear a beep when the brightness reaches minimum or maximum. The multi-information display will return to its original state several seconds after you adjust the brightness.

■ Brightness level indicator

The brightness level is shown on the multi-information display while you are adjusting it.

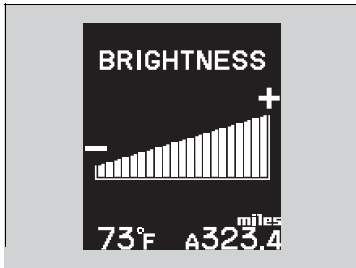

☒ Wipers and Washers



If the wiper stops operating due to any obstacle such as the build-up of snow, park the vehicle in a safe place.

Rotate the wiper switch to **OFF**, and set the power mode to ACCESSORY or VEHICLE OFF (LOCK), then remove the obstacle.

☒ Brightness Control

Instrument panel brightness varies, depending on whether the exterior lights are on or off. The instrument panel dims to reduce glare when they are on.

When it is bright outside and the headlight integration with the wiper is activated, the instrument panel brightness does not change.

Pressing the **SEL/RESET** button or either / (information) button switches the display.

If you turn the knob to the right until the brightness display is up to max, the beeper sounds. This cancels the reduced instrument panel brightness when the parking lights are on.

The brightness can be set differently for when the exterior lights are on, and when they are off.

Rear Defogger/Heated Door Mirror Button

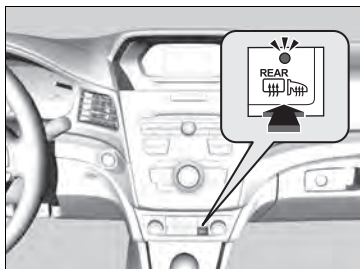

Press the rear defogger and heated door mirror button to defog the rear window and mirrors when the power mode is in ON.

The rear defogger and heated door mirrors automatically switch off after 10-30 minutes depending on the outside temperature.

Adjusting the Steering Wheel

The steering wheel height and distance from your body can be adjusted so that you can comfortably grip the steering wheel in an appropriate driving posture.

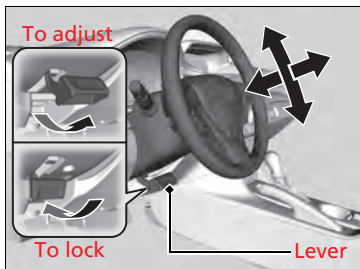

1. Pull the steering wheel adjustment lever up.
 - ▶ The steering wheel adjustment lever is under the steering column.
2. Move the steering wheel up or down, and in or out.
 - ▶ Make sure you can see the instrument panel gauges and indicators.
3. Push the steering wheel adjustment lever down to lock the steering wheel in position.
 - ▶ After adjusting the position, make sure you have securely locked the steering wheel in place by trying to move it up, down, in, and out.

▶▶ Rear Defogger/Heated Door Mirror Button

NOTICE

When cleaning the inside of the rear window, be careful not to damage the heating wires. It is critical to wipe the window from side to side along the defogger heating wires.

This system consumes a lot of power, so turn it off when the window has been defogged. Also, do not use the system for a long period when the engine is idling. This may weaken the battery, making it difficult to start the engine.

▶▶ Adjusting the Steering Wheel

⚠ WARNING

Adjusting the steering wheel position while driving may cause you to lose control of the vehicle and be seriously injured in a crash.

Adjust the steering wheel only when the vehicle is stopped.

Make any steering wheel adjustments before you start driving.

Interior Rearview Mirror

Adjust the angle of the rearview mirror when you are sitting in the correct driving position.

Rearview Mirror with Day and Night Positions*

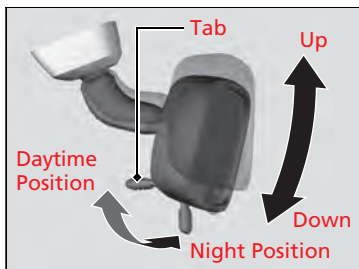

Flip the tab to switch the position. The night position will help to reduce the glare from headlights behind you when driving after dark.

Automatic Dimming Rearview Mirror*

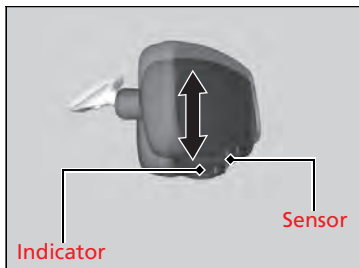

When driving after dark, the automatic dimming rearview mirror always reduces the glare from headlights behind you.

Adjusting the Mirrors

Keep the inside and outside mirrors clean and adjusted for best visibility.

Adjust the mirrors before you start driving.

[Adjusting the Seat Positions P. 123](#)

Automatic Dimming Rearview Mirror*

The auto dimming function cancels when the shift position is in **R**.

* Not available on all models

Power Door Mirrors

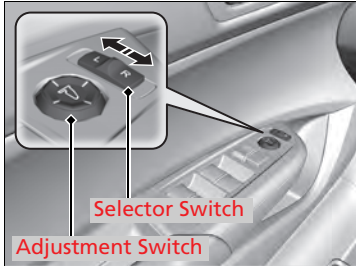

You can adjust the door mirrors when the power mode is in ON.

■ Mirror position adjustment

L/R selector switch: Select the left or right mirror. After adjusting the mirror, return the switch to the center position.

Mirror position adjustment switch: Press the switch left, right, up, or down to move the mirror.

■ Expanded View Driver's Mirror

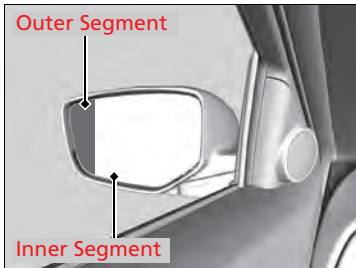

The driver side door mirror has outer and inner segments.

The outer segment is slightly curved to provide a wider angle view than a standard flat mirror. This wider view may help you check areas that are not visible using a standard door mirror.

☒ Expanded View Driver's Mirror

Objects visible in the outer segment of the driver side door mirror appear smaller than objects in the rest of the mirror. But in fact, they are closer than they appear.

Do not rely on your mirrors. Always look to the side and behind your vehicle before changing lanes.

Adjusting the Seat Positions

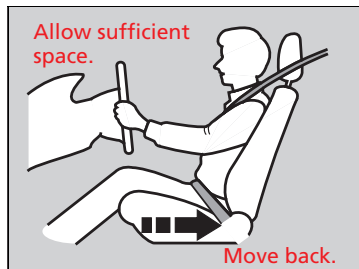

Adjust the driver's seat as far back as possible while allowing you to maintain full control of the vehicle. You should be able to sit upright, well back in the seat and be able to adequately press the pedals without leaning forward, and grip the steering wheel comfortably. The passenger's seat should be adjusted in a similar manner, so that it is as far back from the front airbag in the dashboard as possible.

■ Adjusting the front power seat*



Adjusting the Seats

⚠ WARNING

Sitting too close to a front airbag can result in serious injury or death if the front airbags inflate.

Always sit as far back from the front airbags as possible while maintaining control of the vehicle.

The National Highway Traffic Safety Administration and Transport Canada recommend that drivers allow at least 10 inches (25 cm) between the center of the steering wheel and the chest.

Always make seat adjustments before driving.

* Not available on all models

■ Adjusting the front manual seat(s)

Height Adjustment

(Driver side only)

Pull up or push down the lever to raise or lower the seat.

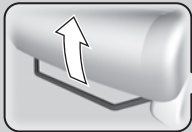

Horizontal Position Adjustment

Pull up on the bar to move the seat, then release the bar.



Seat-back Angle Adjustment

Pull up the lever to change the angle.

Driver's seat is shown.

▶▶ Adjusting the front manual seat(s)

Once a seat is adjusted correctly, rock it back and forth to make sure it is locked in position.

Adjusting the Seat-Backs

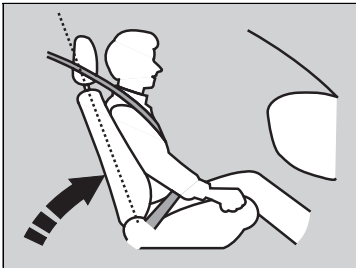

Adjust the driver's seat-back to a comfortable, upright position, leaving ample space between your chest and the airbag cover in the center of the steering wheel.

The front seat passenger should also adjust their seat-back to a comfortable, upright position.

Reclining a seat-back so that the shoulder part of the belt no longer rests against the occupant's chest reduces the protective capability of the belt. It also increases the chance of sliding under the belt in a crash and being seriously injured. The farther a seat-back is reclined, the greater the risk of injury.

Adjusting the Seat-Backs

⚠ WARNING

Reclining the seat-back too far can result in serious injury or death in a crash.

Adjust the seat-back to an upright position, and sit well back in the seat.

Do not put a cushion, or other object, between the seat-back and your back. Doing so may interfere with proper seat belt or airbag operation.

If you cannot get far enough away from the steering wheel and still reach the controls, we recommend that you investigate whether some type of adaptive equipment may help.

■ Adjusting the Head Restraints

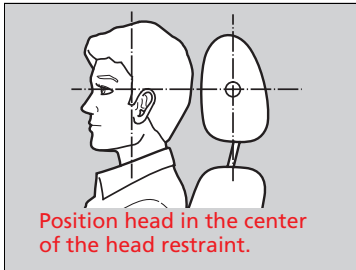

Your vehicle is equipped with head restraints in all seating positions.

Head restraints are most effective for protection against whiplash and other rear-impact crash injuries when the center of the back of the occupant's head rests against the center of the restraint. The tops of the occupant's ears should be level with the center height of the restraint.

■ Adjusting the front and rear outer head restraint positions

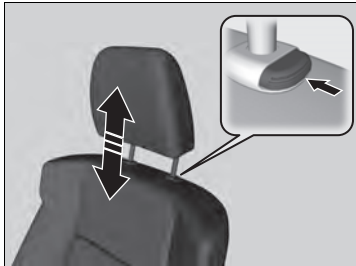

To raise the head restraint: Pull it upward.

To lower the head restraint: Push it down while pressing the release button.

►► Adjusting the Head Restraints

⚠ WARNING

Improperly positioning head restraints reduces their effectiveness and increases the likelihood of serious injury in a crash.

Make sure head restraints are in place and positioned properly before driving.

For the head restraint system to work properly:

- Do not hang any items on the head restraints, or from the restraint legs.
- Do not place any object between an occupant and the seat-back.
- Install each restraint in its proper location.

■ Changing the Rear Center Seat Head Restraint Positions

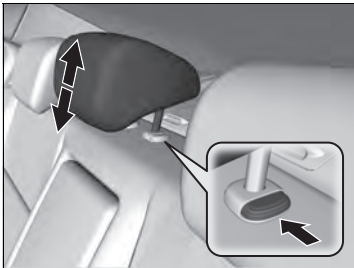

A passenger sitting in the center back seating position should adjust the height of their head restraint to an appropriate position before the vehicle begins moving.

To raise the head restraint:

Pull it upward.

To lower the head restraint:

Push it down while pressing the release button.

■ Removing and Reinstalling the Head Restraints

Head restraints can be removed for cleaning or repair.

To remove a head restraint:

Pull the restraint up as far as it will go. Then push the release button, and pull the restraint up and out.

To reinstall a head restraint:

Insert the legs back in place, then adjust the head restraint to an appropriate height while pressing the release button. Pull up on the restraint to make sure it is locked in position.

✘ Removing and Reinstalling the Head Restraints

⚠ WARNING

Failure to reinstall, or correctly reinstall, the head restraints can result in severe injury during a crash.

Always replace the head restraints before driving.

■ Maintain a Proper Sitting Position

After all occupants have adjusted their seats and head restraints, and put on their seat belts, it is very important that they continue to sit upright, well back in their seats, with their feet on the floor, until the vehicle is safely parked and the engine is off.

Sitting improperly can increase the chance of injury during a crash. For example, if an occupant slouches, lies down, turns sideways, sits forward, leans forward or sideways, or puts one or both feet up, the chance of injury during a crash is greatly increased.

In addition, an occupant who is out of position in the front seat can be seriously or fatally injured in a crash by striking interior parts of the vehicle or being struck by an inflating front airbag.

► Maintain a Proper Sitting Position

WARNING

Sitting improperly or out of position can result in serious injury or death in a crash.

Always sit upright, well back in the seat, with your feet on the floor.

Rear Seat

Folding Down the Rear Seat

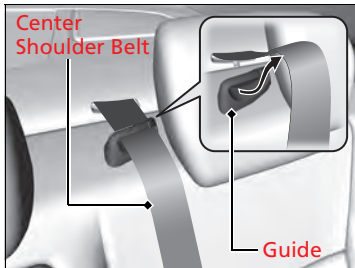

1. Remove the center shoulder belt from the guide.

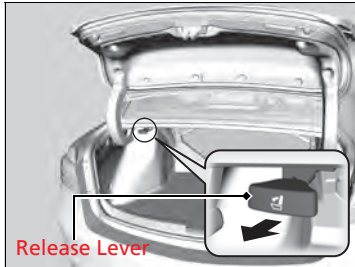

2. Pull the release lever in the trunk to release the lock.



3. Fold the seat-back down.

If the rear head restraints get caught on the front seat-backs, remove the head restraints.

➤ [Removing and Reinstalling the Head Restraints](#) P. 127

Folding Down the Rear Seat

The rear seat-backs can be folded down to accommodate bulkier items in the trunk.

Never drive with the seat-back folded down and the trunk lid open.

➤ [Exhaust Gas Hazard](#) P. 60

To lock the seat-back upright, push it backwards until it locks.

When returning a seat-back to its original position, push it firmly back. Also, make sure all rear shoulder belts are positioned in front of the seat-back, and the center shoulder belt is re-positioned in the guide.

Make sure that the folded seat-back does not press against the front passenger seat, as this can cause the weight sensors in the front passenger seat to work improperly.

➤ [Passenger Airbag Off Indicator](#) P. 45

Also make sure all items in the trunk or items extending through the opening into the rear seat is properly secured. Loose items can fly forward if you have to brake hard.

The front seat(s) must be far enough forward so they do not interfere with the rear seats as they fold down.

Armrest

■ Using the Rear Seat Armrest

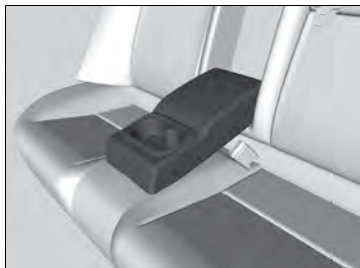

Pull down the armrest in the center seat-back.

Interior Lights

Interior Light Switches

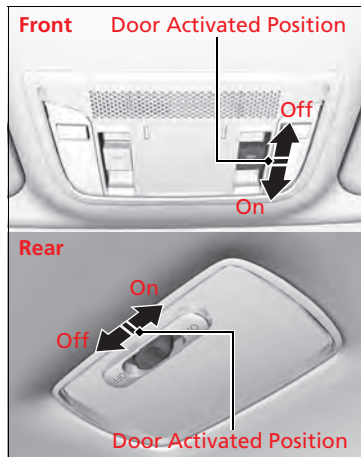

ON

The interior lights come on regardless of whether the doors are open or closed.

Door activated

The interior lights come on in the following situations:

- When any of the doors are opened.
- You unlock the driver's door.
- The lights also come on when the power mode is set to VEHICLE OFF (LOCK).

OFF

The interior lights remain off regardless of whether the doors are open or closed.

Map Lights

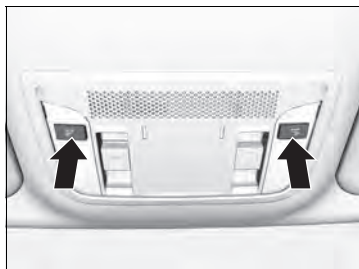

The map lights can be turned on and off by pressing the  (map light) button.

Interior Light Switches

In the door activated position, the interior lights fade out and go off about 30 seconds after the doors are closed.

The lights go off after 30 seconds in the following situations:

- When you unlock the driver's door but do not open it.
- When you set the power mode to VEHICLE OFF (LOCK) but do not open a door.

You can change the interior lights dimming time.

[▶ Customized Features P. 83](#)

The interior lights go off immediately in the following situations:

- When you lock the driver's door.
- When you set the power mode to ON.

If you leave any of the doors open, the interior lights go off after about 15 minutes.

Map Lights

When the interior light switch is in the door activated position and any door is open, pressing the  button does not turn off the map light.

Interior Convenience Items

■ Glove Box



Pull the handle to open the glove box. You can lock the glove box with the built-in key.

» Glove Box

⚠ WARNING

An open glove box can cause serious injury to your passenger in a crash, even if the passenger is wearing the seat belt.

Always keep the glove box closed while driving.

■ Console Compartment

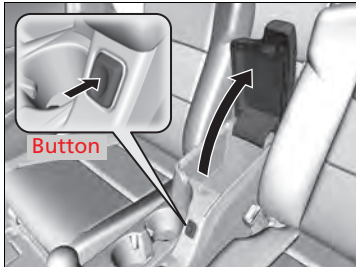

Press the button to open the console compartment.

■ Beverage Holders

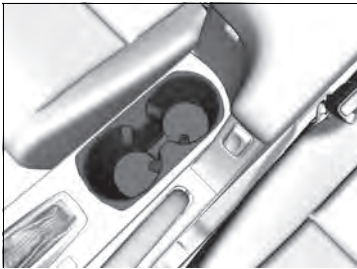

■ Front seat beverage holders

Are located in the console between the front seats.

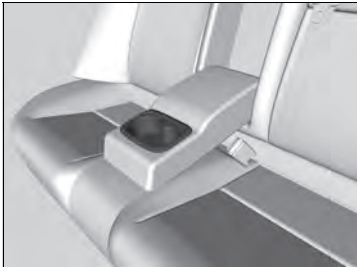

■ Rear seat beverage holders

Fold the armrest down to use the rear seat beverage holders.

» Beverage Holders

NOTICE

Spilled liquids damage the upholstery, carpeting, and electrical components in the interior.

Be careful when you are using the beverage holders. Hot liquid can scald you.

■ Accessory Power Socket

The accessory power sockets can be used when the power mode is in ACCESSORY or ON.



Open the console lid and the cover to use it.

■ Coat Hook



There is a coat hook on the rear left grab handle. Pull it down to use it.

▣ Accessory Power Socket

NOTICE

Do not insert an automotive type cigarette lighter element. This can overheat the power socket.

The accessory power socket is designed to supply power for 12 volt DC accessories that are rated 180 watts or less (15 amps).

To prevent battery drain, only use the power socket with the engine running.

▣ Coat Hook

The coat hook is not designed for large or heavy items.

Seat Heaters*



The power mode must be in ON to use the seat heaters. The **HI** setting heats the seats faster than the **LO** setting.

There is no heater in the passenger's seat-back due to the side airbag cutoff system.

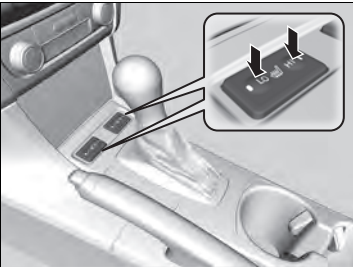

While in **HI**, the heater cycles on and off.

- The appropriate indicator will be on while the seat heater is on. Briefly press the switch on the opposite side to turn the heater off. The indicator will be off. When a comfortable temperature is reached, select **LO** to keep the seat warm.

Seat Heaters*

⚠ WARNING

Heat induced burns are possible when using seat heaters.

Persons with a diminished ability to sense temperature (e.g., persons with diabetes, lower-limb nerve damage, or paralysis) or with sensitive skin should not use seat heaters.

Do not use the seat heaters even in **LO** when the engine is off. Under such conditions, the battery may be weakened, making the engine difficult to start.

In the **LO** setting, the heater runs continuously and does not automatically turn off.

* Not available on all models

Using Automatic Climate Control

The automatic climate control system maintains the interior temperature you select. The system also selects the proper mix of heated or cooled air that will as quickly as possible, raise or lower the interior temperature to your preference.

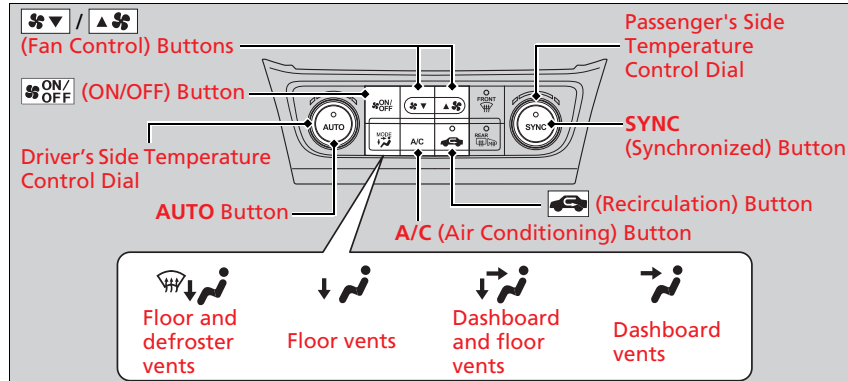

Use the system when the engine is running.

1. Press the **AUTO** button.
2. Adjust the interior temperature using the driver's side or passenger's side control dial.
3. Press the **ON/OFF** (ON/OFF) button to cancel.

Switching between the recirculation and fresh air modes

Press the  (recirculation) button and switch the mode depending on environmental conditions.

Recirculation Mode (indicator on): Recirculates air from the vehicle's interior through the system.

Fresh Air Mode (indicator off): Maintains outside ventilation. Keep the system in fresh air mode in normal situations.

Using Automatic Climate Control

If any buttons are pressed while using the climate control system in auto, the function of the button that was pressed will take priority.

The **AUTO** indicator will go off, but functions unrelated to the button that was pressed will be controlled automatically.

To prevent cold air from blowing in from outside, the fan may not start immediately when the **AUTO** button is pressed.

If the interior is very warm, you can cool it down more rapidly by partially opening the windows, turning the system on auto, and setting the temperature to low. Change the fresh mode to recirculation mode until the temperature cools down.

When you set the temperature to the lower or upper limit, **Lo** or **Hi** is displayed.

Pressing the **ON/OFF** button switches the climate control system between on and off. When turned on, the system returns to your last selection.

■ Defrosting the Windshield and Windows

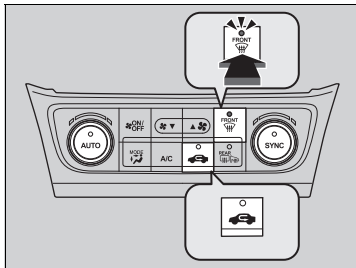

Pressing the  button turns the air conditioning system on and automatically switches the system to fresh air mode.

Press the  button again to turn off, the system returns to the previous settings.

■ To rapidly defrost the windows

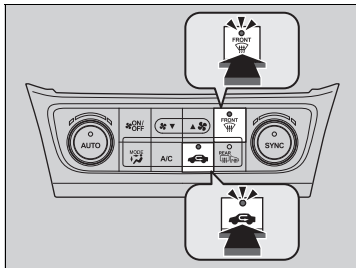

1. Press the  button.
2. Press the  button.

▣ Defrosting the Windshield and Windows

For your safety, make sure you have a clear view through all the windows before driving.

Do not set the temperature near the upper or lower limit.

When cold air hits the windshield, the outside of the windshield may fog up.

If the side windows fog up, adjust the vents so that the air hits the side windows.

▣ To rapidly defrost the windows

After defrosting the windows, switch over to fresh air mode.

If you keep the system in recirculation mode, the windows may fog up from humidity. This impedes visibility.

QRG

Synchronized Mode

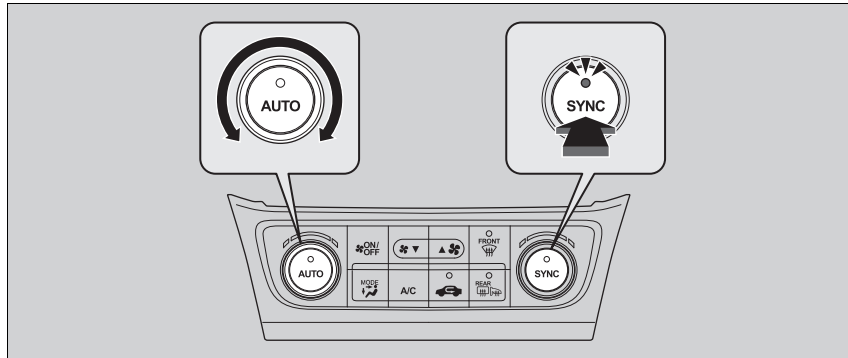

You can set the temperature synchronously for the driver side and the passenger side in synchronized mode.

1. Press the **SYNC** button.
 - The system will switch to synchronized mode.
2. Adjust the temperature using driver's side temperature control dial.

Press the **SYNC** button to return to dual mode.

☒ Synchronized Mode

When you press the  button, the system changes to synchronized mode.

When the system is in dual mode, the driver side temperature and the passenger side temperature can be set separately.

TOC

Controls

Index

Home

QRG

Automatic Climate Control Sensors

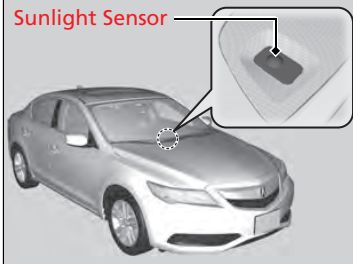

The automatic climate control system is equipped with a sunlight sensor, an interior temperature and humidity sensor. Do not cover or spill any liquid on them.

TOC

Controls

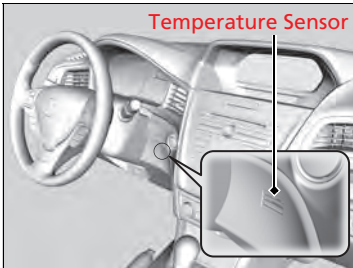

Index



Features

This chapter describes how to operate technology features on models without the navigation system.



Audio System

- About Your Audio System 142
- USB Adapter Cable 143
- Auxiliary Input Jack 143
- Audio System Theft Protection 144

Audio System Basic Operation 145

- Audio/Information Screen 146
- Audio Remote Controls..... 149
- Adjusting the Sound 150
- Playing the AM/FM Radio 151
- Playing the XM® Radio* 153
- Playing a CD 155
- Playing an iPod®..... 158

- Playing Internet Radio 161
- Playing a USB Flash Drive 163
- Playing Bluetooth® Audio..... 166
- Wallpaper Setup 168

Audio Error Messages*

- CD Player..... 170
- iPod®/USB Flash Drive..... 171
- Pandora® 172

General Information on the Audio System

- XM® Radio Service* 173
- Recommended CDs 174

- Compatible iPod®, iPhone®, and USB Flash Drives 176
- HomeLink® Universal Transceiver* 177
- Training HomeLink..... 177
- Bluetooth® HandsFreeLink®
- Using HFL 179
- HFL Menu 181

* Not available on all models

About Your Audio System

On models with navigation system, see Navigation System Manual for operation of the audio system, AcuraLink[™], Bluetooth[®] HandsFreeLink[®], and voice commands for these features.

The audio system features AM/FM radio and the XM[®] Radio service. It can also play audio CDs, WMA/MP3/AAC files, iPod[®], iPhone[®], USB flash drives, and Bluetooth[®] devices.

You can operate the audio system from the buttons and switches on the panel, or the remote controls on the steering wheel.



About Your Audio System

XM[®] Radio is available on a subscription basis only. For more information on XM[®] Radio, contact a dealer.

[General Information on the Audio System](#)
P. 173

XM[®] Radio is available in the United States and Canada, except Hawaii, Alaska, and Puerto Rico.

XM[®] is a registered trademark of Sirius XM Radio, Inc.

Video CDs, DVDs, and 3-inch (8-cm) mini CDs are not supported.

iPod[®] and iPhone[®] are registered trademark owned by Apple Inc.

State or local laws may limit the circumstances in which you can launch or control your attached audio device.

USB Adapter Cable

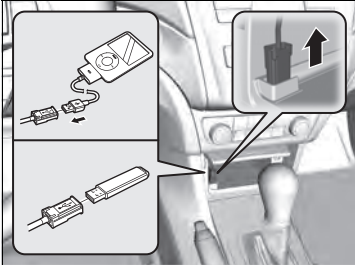

1. Unclip the USB connector and loosen the adapter cable.
2. Install the iPod® dock connector or the USB flash drive to the USB connector.

⊠ USB Adapter Cable

- Do not leave the iPod® or USB flash drive in the vehicle. Direct sunlight and high temperatures may damage it.
- Do not use an extension cable with the USB adapter cable.
- Do not connect the iPod® or USB flash drive using a hub.
- Do not use a device such as a card reader or hard disk drive, as the device or your files may be damaged.
- We recommend backing up your data before using the device in your vehicle.
- Displayed messages may vary depending on the device model and software version.

If the audio system does not recognize the iPod®, try reconnecting it a few times or reboot the device. To reboot, follow the manufacturer's instructions provided with the iPod® or visit www.apple.com/ipod.

⊠ Auxiliary Input Jack

To switch the mode, press any of the audio mode buttons. You can return to the AUX mode by pressing the **AUX** button.

You cannot use the auxiliary input jack if you replace the audio system.

Auxiliary Input Jack

Use the jack to connect standard audio devices.

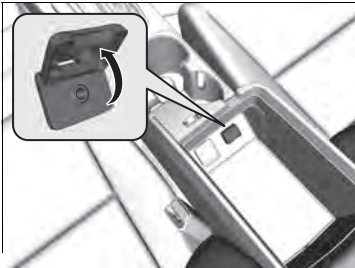

1. Open the AUX cover.
2. Connect a standard audio device to the input jack using a 1/8 inch (3.5 mm) stereo miniplug.
 - ▶ The audio system automatically switches to the AUX mode.

Audio System Theft Protection

The audio system is disabled when it is disconnected from the power source, such as when the battery is disconnected or goes dead.

■ Reactivating the audio system

1. Set the power mode to ON, and turn on the audio system.
 - ▶ If you set the power mode to ACCESSORY, you will be requested to enter the audio security code. See step 3.
2. Press and hold the power button again for more than two seconds.
 - ▶ The audio system is reactivated when the system's control unit recognizes that the system is in your vehicle.
If the control unit fails to recognize, **ENTER CODE** appears on the audio/information screen.
3. Enter the audio security code using the preset buttons. If you enter an incorrect digit, continue to the last digit, then try again. If you do not enter the code correctly after 10 tries, leave the system for one hour before trying again, or visit a dealer to have the system reset.

▶▶ Audio System Theft Protection

Find the audio system's security code and serial number label in your owner's manual kit.

We recommend that you write down the serial number in this owner's manual.

Do not store the label in your vehicle. If you lose the label, you must first retrieve the serial number, and then obtain the code.

You can find out about your serial number and security code from a dealer.

U.S. models

You can register the security code at Acura Owners (owners.acura.com), and find information on how to retrieve the serial number and obtain the code at radio-navicode.acura.com.

To use the audio system function, the power mode must be in ACCESSORY or ON.

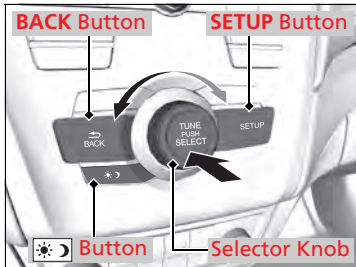

Use the selector knob or **SETUP** button to access some audio functions.

Press to switch between the normal and extended display for some functions.

Selector knob: Rotate left or right to scroll through the available choices. Press to set your selection.

SETUP button: Press to select any mode such as the **RDS Information**, **Sound Settings**, **Play Mode**, **Resume/Pause**, or **Adjust Clock**.

BACK button: Press to go back to the previous display.

button: Press to change the audio/information screen brightness. The brightness can be set differently for the day time and night time.

Pressing the button switches the modes between daytime and night time.

Adjust the brightness using .

Audio System Basic Operation

These indications are used to show how to operate the selector knob.

Rotate to select.

Press to enter.

Press the **MODE**, , , , or button on the steering wheel to change any audio setting.

[▶ Audio Remote Controls P. 149](#)

Setup Menu Items

[▶ RDS Information P. 152](#)

[▶ Sound Settings P. 150](#)

[▶ Play Mode P. 157, 160, 165](#)

[▶ Resume/Pause P. 167](#)

[▶ Adjust Clock P. 92](#)

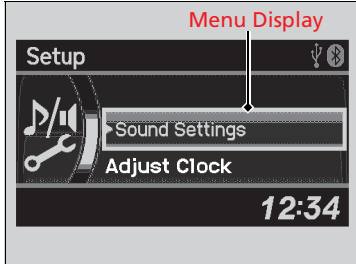

Audio/Information Screen

Displays audio status and wallpaper, and allows you to go to various setup options.

■ Switching the Display

Press **DISPLAY** button. Rotate  and select the mode from the three display modes.

Press .

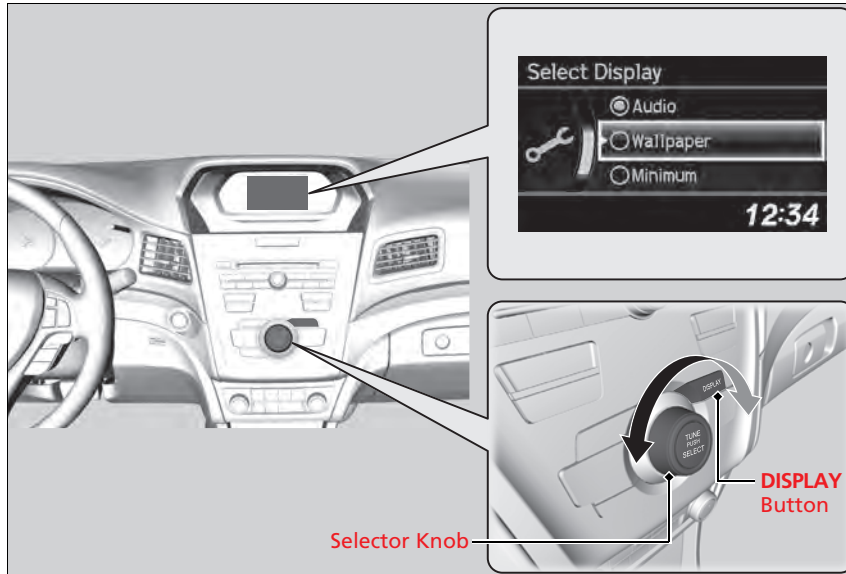

■ Audio Display

Shows the current audio information.

▶ [Audio System Basic Operation P. 145](#)

■ Wallpaper

Shows a clock screen or an image you import.



▶ [Wallpaper Setup P. 168](#)

■ Minimum Display

Minimizes the display by only showing the clock and audio status on the display.

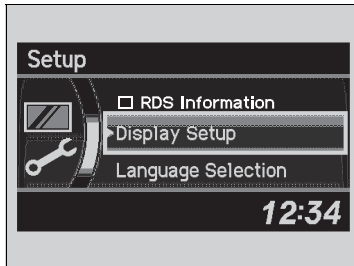
■ Setting Options





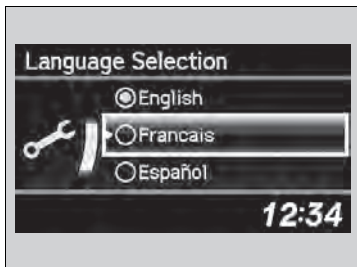

1. Press the **SETUP** button.
2. Rotate  and select the setup option you want to change. Press .

QRG

■ Language Selection



1. Rotate  to select **Language Selection**, then press .
2. Rotate  to select the language, then press .

TOC

Features

Index

Home

Audio Remote Controls

Allow you to operate the audio system while driving.

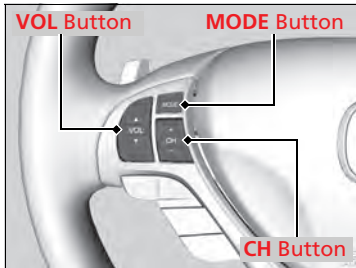

MODE Button

Cycles through the audio modes as follows:
FM1→FM2→AM→XM1*→XM2*→CD→AUX

VOL (Volume) Button

Press ▲: Increases the volume.

Press ▼: Decreases the volume.

CH (Channel) Button

- When listening to the radio
 - Press** [+]: Selects the next preset radio station.
 - Press** [-]: Selects the previous preset radio station.
 - Press and hold** [+]: Selects the next strong station.
 - Press and hold** [-]: Selects the previous strong station.
- When listening to a CD, iPod®, USB flash drive, or *Bluetooth*® Audio
 - Press** [+]: Skips to the next song.
 - Press** [-]: Goes back to the beginning of the current or previous song.
- When listening to a CD, USB flash drive
 - Press and hold** [+]: Skips to the next folder.
 - Press and hold** [-]: Goes back to the previous folder.
- When listening to Pandora®*
 - Press** [+]: Skips to the next song.

Audio Remote Controls

The CD mode appears only when a CD is loaded.

When in the AUX mode, the following are operable from the remote controls:

- iPod®/USB flash drive connected to the USB adapter cable
- *Bluetooth*® Audio (with some phones only)

* Not available on all models

Adjusting the Sound

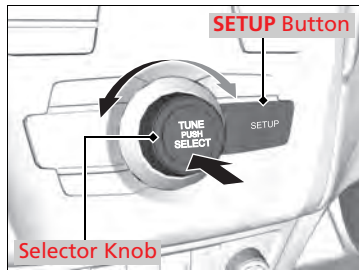

Press the **SETUP** button, and rotate to select **Sound Settings**, then press . Rotate to scroll through the following choices:

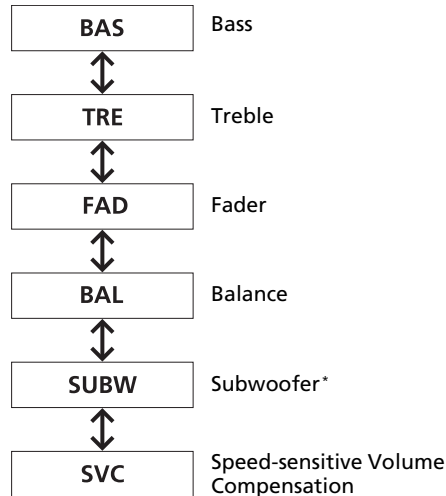
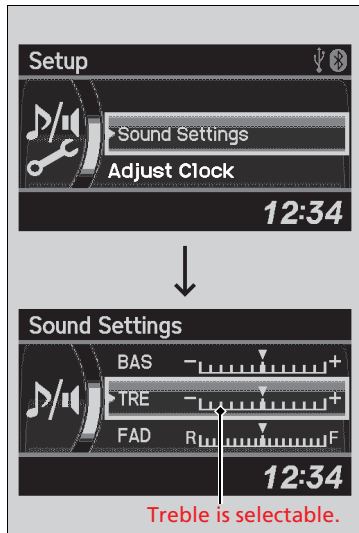

▶▶ Adjusting the Sound

The **SVC** has four modes: **Off**, **Low**, **Mid**, and **High**. **SVC** adjusts the volume level based on the vehicle speed. As you go faster, audio volume increases. As you slow down, audio volume decreases.

QRG

TOC

Features

Index



Playing the AM/FM Radio

QRG

TOC

Features

Index

Home

The diagram shows the car's audio system interface. At the top is a digital display showing 'FM 1 103.5MHz ST' and '12:34'. Below the display is a control panel with various buttons and a knob. Callouts point to specific features:

- VOL/⏻ (Volume/Power) Knob:** Press to turn the audio system on and off. Turn to adjust the volume.
- AM Button* / FM Button*:** Press to select a band.
- FOLDER Bar*:** Press either side to display and select an RDS category.
- FM/AM Button*:** Press to select a band.
- CATEGORY Bar*:** Press either side to display and select an RDS category.
- SCAN Button:** Press to sample each of the strongest stations on the selected band for 10 seconds. To turn off scan, press the button again.
- Preset Buttons (1-6):** To store a station: 1. Tune to the selected station. 2. Pick a preset button and hold it until you hear a beep. To listen to a stored station, select a band, then press the preset button.
- SKIP Bar:** Press to search up and down the selected band for a station with a strong signal.
- A.SEL (Auto Select) Button:** Press to scan both bands and store the strongest station in each preset. To turn off auto select, press the button again. This restores the presets you originally set.
- SETUP Button:** Press to display menu items.
- Selector Knob:** Turn to tune the radio frequency.
- BACK Button:** Press to go back to the previous display.



* Not available on all models

■ Radio Data System (RDS)

Provides text data information related to your selected RDS capable FM station.

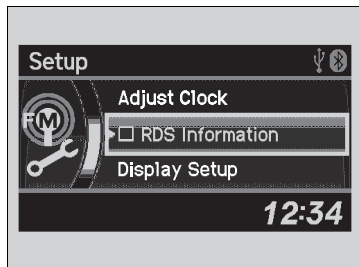
■ RDS Information



1. Press the **SETUP** button and rotate  to select **RDS Information**.
2. Each time you press , the RDS Information switches between on and off.

■ To find an RDS station from your selected program category

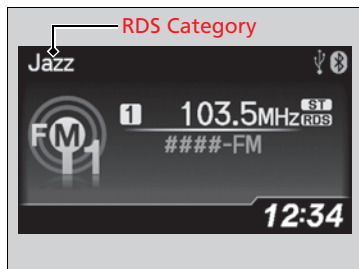

1. Press the **FOLDER** bar or the **CATEGORY** bar to display and select an RDS category.
2. Use **SKIP** or **SCAN** to select an RDS station.

▶▶ Playing the AM/FM Radio

The **ST** indicator appears on the display indicating stereo FM broadcasts.

Stereo reproduction in AM is not available.

Switching the Audio Mode

Press the **MODE** button on the steering wheel.

[▶▶ Audio Remote Controls P. 149](#)

You can store six AM stations and twelve FM stations into the preset button memory. FM1 and FM2 let you store six stations each.

Auto Select function scans and stores up to six AM stations and twelve FM stations with a strong signal into the preset button memory.

If you do not like the stations auto select has stored, you can manually store your preferred frequencies.

Playing the XM® Radio*

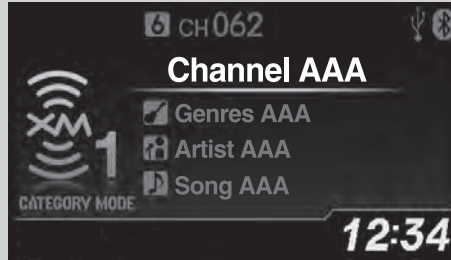

VOL/⏻ (Volume/Power) Knob

Press to turn the audio system on and off. Turn to adjust the volume.

(((XM))) (XM®) Button

Press to select XM® Radio.

CATEGORY Bar

Press either side to display and select an XM® Radio category.

SCAN Button

Press to sample all channels (in the channel mode), or channels within a category (in the category mode). Each sampling continues for a few seconds. Press **SCAN** again to cancel scanning and continue listening to the channel.

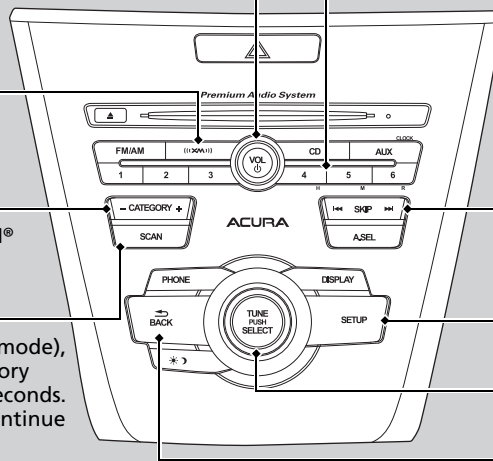

Preset Buttons (1-6)

To store the channel:
 1. Tune to the channel.
 2. Pick a preset button and hold it until you hear a beep.
 To listen to a stored channel, select XM, then press the preset button.

SKIP Bar

Press to skip to the previous or next channel.

SETUP Button

Press to display menu items.

Selector Knob





Press and turn to select channels.

BACK Button

Press to go back to the previous display.



* Not available on all models

■ To Play the XM® Radio

1. Press the (Ⓜ) button to select the XM® radio band (XM1 or XM2).
2. Press the **SETUP** button, rotate  to select **XM Mode**, and press . Rotate  to select **Channel Mode** or **Category Mode**, then press .
3. Select a channel using the **TUNE** () , **SKIP**, **CATEGORY**, **SCAN**, or Preset buttons.

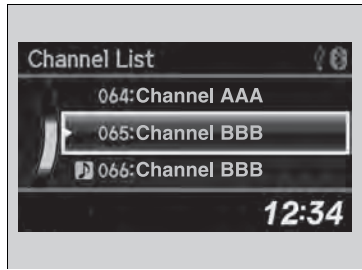
■ To Select a Channel from a List



1. Press  to display a channel list.
2. Rotate  to select a channel, then press .

▶▶ Playing the XM® Radio*

In the channel mode, all available channels are selectable. In the category mode, you can select a channel within a category (Jazz, Rock, Classical, etc.).

You can store twelve XM® stations in the preset buttons. XM1 and XM2 let you store six stations each.

There may be instances when XM® Radio does not broadcast all the data fields (artist name, title). This does not indicate a problem with your audio system.

Playing a CD

Your audio system supports audio CDs, CD-Rs and CD-RWs in either MP3, WMA or AAC format. With the CD loaded, press the **CD** button.

The diagram shows the audio system's display and control panel. The display screen at the top shows 'Track AAA', a progress bar at 1'23", 'Genres AAA', 'Artists AAA', and the time '12:34'. Below the screen is a control panel with buttons for 'FM', 'AM', 'VOL', 'CD', and 'ALUX'. There are also buttons for 'SCAN', 'FOLDER', 'SKIP', 'ASEL', 'PHONE', 'BACK', 'TUNE/FILE SELECT', 'DISPLAY', and 'SETUP'. A 'CD Eject' button is located above the 'CD' button. A 'CATEGORY' button is shown to the left of the 'SCAN' button. A 'VOL/Power' knob is located to the right of the 'CD' button.

FOLDER Bar*
Press **+** to skip to the next folder, and **-** to skip to the beginning of the previous folder in MP3, WMA or AAC.

▲ (CD Eject) Button
Press to eject a CD.

CATEGORY Bar*
Press **+** to skip to the next folder, and **-** to skip to the beginning of the previous folder in MP3, WMA or AAC.

SCAN Button
You will get a 10-second sampling of each song.

- Press to sample all tracks on the CD (all files in the current folder in MP3, WMA or AAC).
- Press and hold to sample the first file in each of the main folders (MP3, WMA or AAC).
- To turn off scan, press the button.

BACK Button
Press to go back to the previous display.

VOL/⏻ (Volume/Power) Knob
Press to turn the audio system on and off. Turn to adjust the volume.

CD Button
Press to play a CD.

CD Slot
Insert a CD about halfway into the CD slot.

SKIP Bar
Press **⏪** or **⏩** to change tracks (files in MP3, WMA or AAC). Press and hold to move rapidly within a track/file.

SETUP Button
Press to display menu items.

Selector Knob
Turn to change tracks/files. Turn to select an item, then press to set your selection.

* Not available on all models

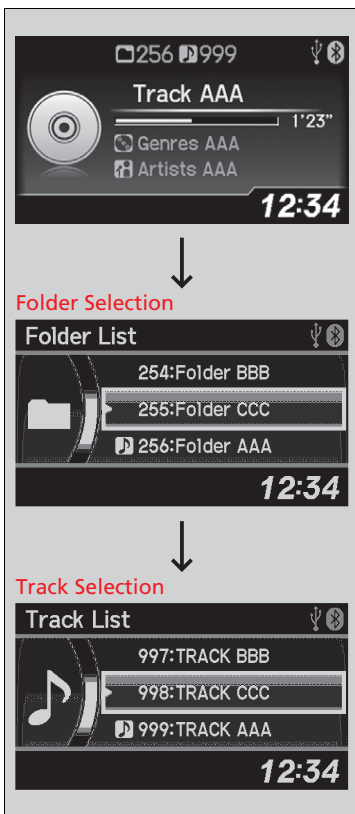

How to Select a File from a Folder with the Selector Knob (MP3/WMA/AAC)



1. Press  to switch the display to a folder list.

2. Rotate  to select a folder.

3. Press  to change the display to a list of files in that folder.

4. Rotate  to select a file, then press .

▶▶ Playing a CD

NOTICE

Do not use CDs with adhesive labels. The label can cause the CD to jam in the unit.

WMA files protected by digital rights management (DRM) cannot be played.

The audio system displays **Unplayable File**, then skips to the next file.

Text data appears on the display under the following circumstances:

- When you select a new folder, file, or track.
- When you change the audio mode to CD.
- When you insert a CD.

If you eject the CD but do not remove it from the slot, the system reloads the CD automatically after several seconds.



How to Select a Play Mode

You can select repeat and random modes when playing a track or file.

1. Press the **SETUP** button.



2. Rotate  to select **Play Mode**, then press .

3. Rotate  to select a mode, then press .

To turn off a play mode

1. Press the **SETUP** button.

2. Rotate  to select **Play Mode**, then press .

3. Rotate  to select **Normal Play**, then press .

How to Select a Play Mode

Press the **BACK** button to go back to the previous display, and press the **SETUP** button to cancel this setting mode.

Play Mode Menu Items

Normal Play

Repeat One Track: Repeats the current track/file(s).

Repeat One Folder (MP3/WMA/AAC): Repeats all files in the current folder.

Random in Folder (MP3/WMA/AAC): Plays all files in the current folder in random order.

Random All: Plays all tracks/files in random order.

Playing an iPod®

Connect the iPod® using your dock connector to the USB adapter cable, then press the **AUX** button.

➤ [USB Adapter Cable P. 143](#)

Album Art — Points to the album art image on the display screen.

USB Indicator — Points to the USB and Bluetooth icons in the top right corner of the display. Appears when an iPod® is connected.

VOL/⏻ (Volume/Power) Knob — Points to the central volume knob. Press to turn the audio system on and off. Turn to adjust the volume.

AUX Button — Points to the AUX button on the top right of the control panel. Press to select iPod® (if connected).

SKIP Bar — Points to the skip buttons on the right side of the control panel. Press ◀◀ or ▶▶ to change songs. Press and hold to move rapidly within a song.

BACK Button — Points to the BACK button on the left side of the control panel. Press to go back to the previous display.

SETUP Button — Points to the SETUP button on the right side of the control panel. Press to display menu items.

Selector Knob — Points to the central selector knob. Turn to change songs. Turn to select an item, then press to set your selection.

How to Select a File from the iPod® Menu

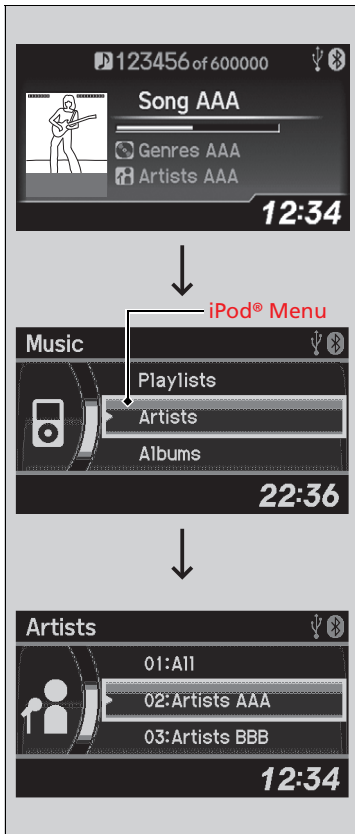

1. Press to display the iPod® menu.

2. Rotate to select a menu.

3. Press to display the items on that menu.

4. Rotate to select an item, then press .

▶▶ Playing an iPod®

Available operating functions vary on models or versions. Some functions may not be available on the vehicle's audio system.

If there is a problem, you may see an error message on the audio/information screen.



[▶ iPod®/USB Flash Drive P. 171](#)

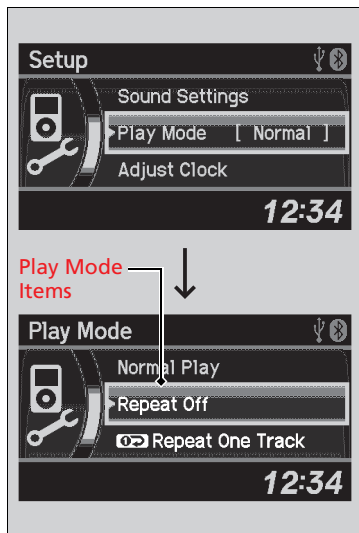

■ How to Select a Play Mode

You can select repeat and shuffle modes when playing a file.



1. Press the **SETUP** button.

2. Rotate  to select **Play Mode**, then press .

3. Rotate  to select a mode, then press .

■ To turn off a play mode

1. Press the **SETUP** button.

2. Rotate  to select **Play Mode**, then press .

3. Rotate  to select **Normal Play**, then press .

▶▶ How to Select a Play Mode

Play Mode Menu Items

Normal Play

Repeat Off: Turns off the repeat mode.

Repeat One Track: Repeats the current track.

Shuffle Off: Turns off the shuffle mode.

Shuffle: Plays all available files in a selected list (playlists, artists, albums, songs, genres, or composers) in random order.

Shuffle Albums: Plays all available albums in a selected list (playlists, artists, albums, songs, genres, or composers) in random order.

U.S. models

iPhone® use only

Playing Internet Radio

Activate Pandora®, and connect the iPhone® using your dock connector to the USB adapter cable, then press the **AUX** button.

➤ [USB Adapter Cable](#) P. 143

The diagram illustrates the car's audio system interface. At the top, a screen displays the Pandora menu with the text "Push Select for PANDORA MENU". The menu items are: "Song AAA", "Albums AAA", "Artists AAA", and "AAA station". The time "12:34" is shown in the bottom right corner of the screen. Below the screen is the physical control panel. A "FOLDER Bar" is located on the left side of the screen, and a "CATEGORY Bar" is located below it. The physical buttons include a "VOL/ (Volume/Power) Knob" at the top center, an "AUX Button" on the right side, a "SKIP Bar" below it, a "BACK Button" on the left side, and a "SELECTOR Knob" at the bottom center. The "TUNE PUSH SELECT" button is also labeled.

Rating Icon — Points to the star icon next to "Song AAA".

Album Art — Points to the album art icon next to "Albums AAA".

FOLDER Bar* — Press **+** to the next station. Press **-** to the previous station.

CATEGORY Bar* — Press **+** to the next station. Press **-** to the previous station.

BACK Button — Press to go back to the previous display.

Selector Knob — Press to enter **PANDORA MENU**. Press and turn to select an item, then press to set your selection.

VOL/ (Volume/Power) Knob — Press to turn the audio system on and off. Turn to adjust the volume.

AUX Button — Press to select iPhone® (if connected when the Pandora® application is activated).

SKIP Bar — Press **▶▶** to skip a song.

SETUP Button — Press to display menu items.

* Not available on all models



■ Pandora® Menu

You can operate some of the Pandora menu items from your vehicle's audio system. The available items are:

- **Station List** (**QuickMix** is also available)
- **Like**
- **Dislike**
- **Resume/Pause**
- **SKIP**
- **Bookmark this song**
- **Bookmark this artist**

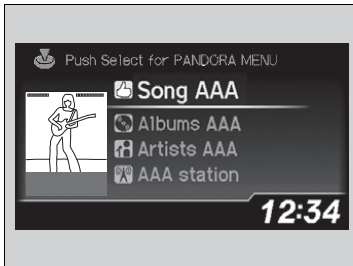
■ Operating a menu item



1. Press  to display the **PANDORA MENU**.
2. Rotate  to select a menu.
3. Press  to display the items on that menu.

▶▶ Playing Internet Radio

Pandora® is a personalized Internet radio service that selects music based on an artist, song, or genre a user enters, and streams what is likely to be of interest.

To use this service in your vehicle, the Pandora® app must first be installed on your iPhone®. Visit www.pandora.com for more information.

If you cannot operate Pandora® through the audio system, it may be streaming through *Bluetooth®* Audio. Make sure Pandora® mode on your audio system is selected.

▶▶ Pandora® Menu

Available operating functions vary on software versions. Some functions may not be available on the vehicle's audio system.

If there is a problem, you may see an error message on the audio/information screen.

 [Pandora® P. 172](#)

There are restrictions on the number of songs you can skip or dislike in a given hour.

Playing a USB Flash Drive

Your audio system reads and plays sound files on a USB flash drive in either MP3, WMA or AAC*¹ format.

Connect your USB flash drive to the USB adapter cable, then press the **AUX** button.

▶ [USB Adapter Cable](#) P. 143

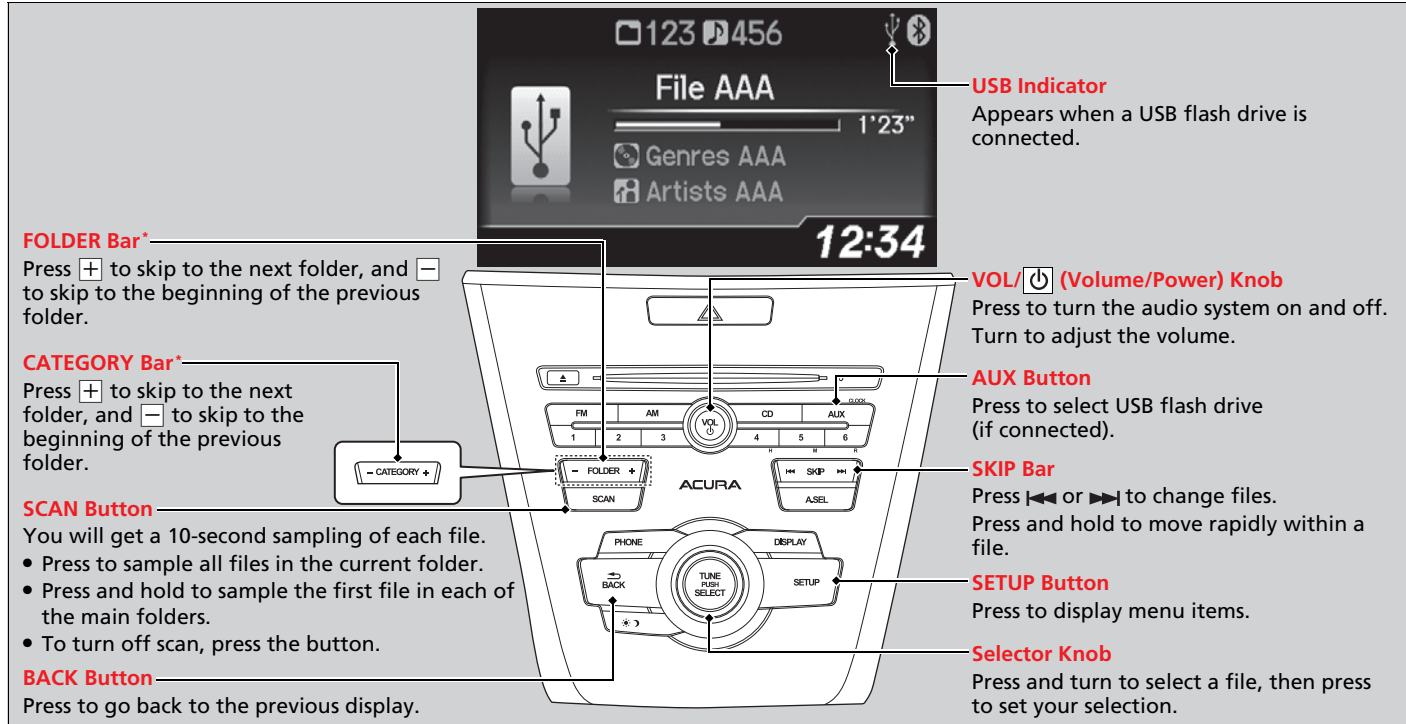



*1: Only AAC format files recorded with iTunes® are playable on this unit.

* Not available on all models

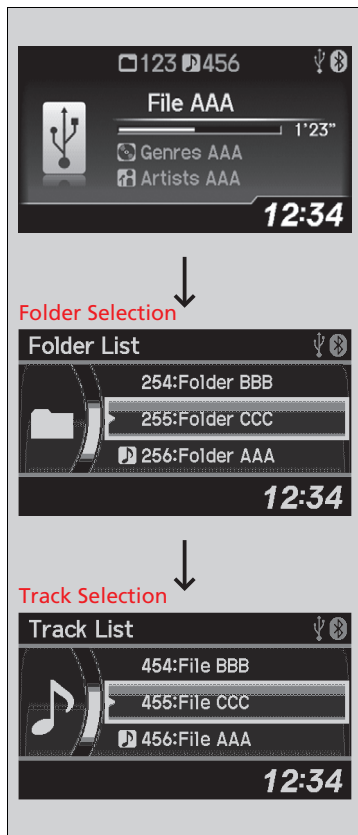
How to Select a File from a Folder with the Selector Knob



1. Press  to switch the display to a folder list.

2. Rotate  to select a folder.

3. Press  to change the display to a list of files in that folder.

4. Rotate  to select a file, then press .

▶▶ Playing a USB Flash Drive

Use the recommended USB flash drives.

 [General Information on the Audio System P. 173](#)

Files in WMA format protected by digital rights management (DRM) are not played.

The audio system displays **Unplayable File**, and then skips to the next file.

If there is a problem, you may see an error message on the audio/information screen.



 [iPod®/USB Flash Drive P. 171](#)

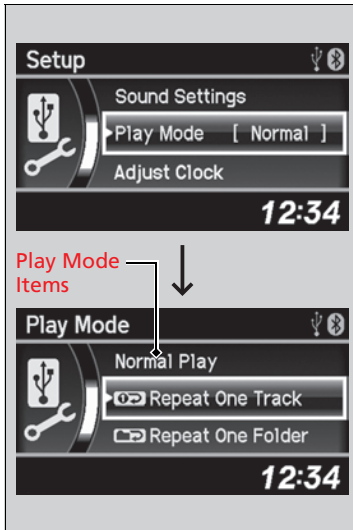

How to Select a Play Mode

You can select repeat and random modes when playing a file.

1. Press the **SETUP** button.



2. Rotate  to select **Play Mode**, then press .

3. Rotate  to select a mode, then press .

To turn off a play mode

1. Press the **SETUP** button.

2. Rotate  to select **Play Mode**, then press .

3. Rotate  to select **Normal Play**, then press .

How to Select a Play Mode

Play Mode Menu Items

Normal Play

Repeat One Track: Repeats the current file.

Repeat One Folder: Repeats all files in the current folder.

Random in Folder: Plays all files in the current folder in random order.

Random All: Plays all files in random order.

Playing *Bluetooth*® Audio

Your audio system allows you to listen to music from your *Bluetooth*®-compatible phone.

This function is available when the phone is paired and linked to the vehicle's *Bluetooth*® HandsFreeLink® (HFL) system.

▶ **Phone Setup** P. 186

▶▶ Playing *Bluetooth*® Audio

Not all *Bluetooth*-enabled phones with streaming audio capabilities are compatible with the system. For a list of compatible phones:

- **U.S.:** Visit www.acura.com/handsfreelink, or call 1-888-528-7876.
- **Canada:** Visit www.handsfreelink.ca, or call 1-888-528-7876.

In some states, it may be illegal to perform some data device functions while driving.

If more than one phone is paired to the HFL system, there will be a delay before the system begins to play.

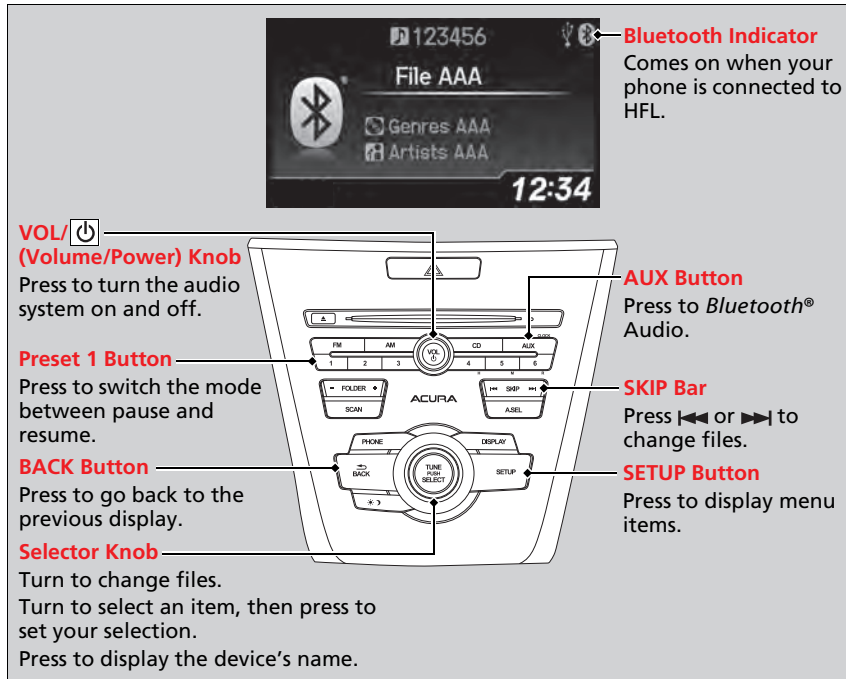

To Play *Bluetooth*® Audio Files

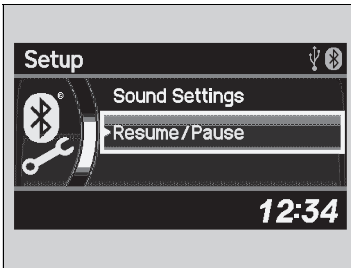

1. Make sure that your phone is paired and linked to HFL.
2. Press the **AUX** button.

If the phone is not recognized, another HFL-compatible phone, which is not compatible for *Bluetooth*® Audio, **may be** already linked.

▶▶ To Play *Bluetooth*® Audio Files

To play the audio files, you may need to operate your phone. If so, follow the phone maker's operating instructions.

The pause function may not be available on some phones.

If any audio device is connected to the auxiliary input jack, you may need to press the **AUX** button repeatedly to select the *Bluetooth*® Audio system.

Switching to another mode pauses the music playing from your phone.

To pause or resume a file

1. Press the **SETUP** button.
2. Rotate to select **Resume/Pause**, then press .

Each time you press , the setting switches between Pause and Resume.

Switching to HFL

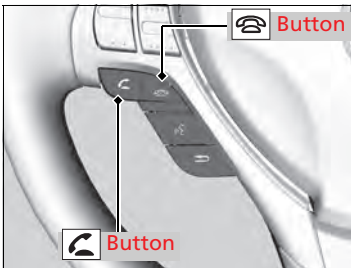

Press the (pick-up) button on the steering wheel to receive a call when *Bluetooth*® Audio is playing.

[▶▶ *Bluetooth*® HandsFreeLink® P. 179](#)

Press the (hang-up) button to end the call and return to *Bluetooth*® Audio.

▶▶ Switching to HFL

If you receive a call while *Bluetooth*® Audio is in the pause mode, it will resume play after ending the call.









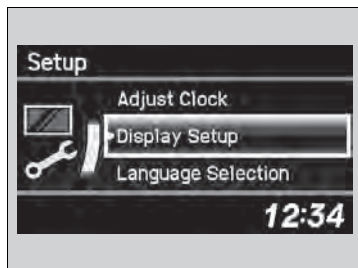

Wallpaper Setup

You can change, store and delete the wallpaper on the audio/information screen.

■ Import Wallpaper

You can import up to three images, one at a time, for wallpaper from a USB flash drive.



1. Connect the USB flash drive to the adapter cable.
▶ **USB Adapter Cable** P. 143
2. Press the **SETUP** button.
3. Rotate  to select **Display Setup**, then press .
4. Rotate  to select **Wallpaper**, then press .
5. Rotate  to select **Import**, then press .
6. Rotate  to select a desired picture, then press .
▶ The preview of the imported data is displayed.
7. Press  to save the data.
▶ The confirmation message will appear. Then the display will return to the import wallpaper list.
8. Rotate  to select the place to save the data, then press .
▶ The confirmation message will appear.

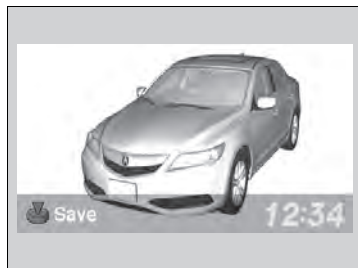





▶▶ Wallpaper Setup







- When importing wallpaper files, the image must be in the USB flash drive's root directory. Images in a folder cannot be imported.
- The file format of the image that can be imported is BMP (bmp) or JPEG (jpg).
- Each image file can be up to 2 MB.
- The maximum image size is 1,680 x 936 pixels. If the image size was less than 420 x 234 pixels, the image is displayed in the middle of the screen with the extra area appearing in black.
- Up to 255 files can be selected.

If the USB flash drive does not have any pictures, **No compatible images were found. See Owner's Manual.** will appear.

Select Wallpaper



1. Rotate  to select **Select** on the wallpaper setup menu, then press .
▶ The screen will change to the wallpaper list.
2. Rotate  to select desired wallpaper and press .
▶ When the scroll is stopped, the thumbnail is displayed.

Delete wallpaper

1. Rotate  to select **Delete** on the wallpaper setup menu, then press .
▶ The screen will change to the delete wallpaper list.
2. Rotate  to select wallpaper that you want to delete and press .
▶ The confirmation message will appear.
3. Rotate  to select **Yes**, then press  to delete completely.

CD Player

If a disc error occurs, you may see the following error messages.

Error Message	Cause	Solution
Unplayable File	Track/file format not supported	<ul style="list-style-type: none"> Current track/file will be skipped. The next supported track/file plays automatically.
Bad Disc Please check owners manual Push Eject	Mechanical error	<ul style="list-style-type: none"> Press the  (eject) button and remove the disc, and check that the error message is cleared. Check that the disc is not damaged or deformed, and insert the disc again. <ul style="list-style-type: none"> ▶ Protecting CDs P. 175
Mecha Error		
Bad Disc Please check owners manual	Servo error	<ul style="list-style-type: none"> If the error message reappears, press the  button, and pull out the disc. Insert a different disc. If the new disc plays, there is a problem with the first disc. If the error message repeats, or the disc cannot be removed, contact a dealer. Do not try to force the disc out of the player.
Check Disc	Disc error	<ul style="list-style-type: none"> Check that the disc is not damaged or deformed. <ul style="list-style-type: none"> ▶ Protecting CDs P. 175

iPod®/USB Flash Drive

If an error occurs while playing an iPod® or USB flash drive, you may see the following error messages. If you cannot clear the error message, contact a dealer.

Error Message	Solution
USB Error	Appears when there is a problem with the USB adapter unit. Check if the device is compatible with the USB adapter unit.
Bad USB Device Please Check Owners Manual.	Appears when an incompatible device is connected. Disconnect the device. Then turn the audio system off, and turn it on again. Do not reconnect the device that caused the error.
No Song	Appears when the iPod® is empty. Check that compatible files are stored on the device.
Unsupported Ver	Appears when an unsupported iPod® is connected. If it appears when a supported iPod® is connected, update the iPod® software to the newer version.
Retry Connection	Appears when the system does not acknowledge the iPod®. Reconnect the iPod®.
Unplayable File	Appears when the files in the USB flash drive are DRM or an unsupported format. This error message appears for about 3 seconds, then plays the next song.
No Data	Appears when the USB flash drive is empty or there are no MP3, WMA, or AAC files in the USB flash drive. Check that compatible files are stored on the device.
Unsupported	Appears when an unsupported device is connected. If it appears when a supported device is connected, reconnect the device.

U.S. models

Pandora®

If an error occurs while playing Pandora®, you may see the following error messages. If you cannot clear the error message, contact a dealer.

Error Message	Solution
PANDORA No Station	Appears when there is no station list on the device. Use the device to create a station.
PANDORA Requires Update	Appears when Pandora version is not supported. Please update the device application.
PANDORA Unavailable	Appears when Pandora is performing system maintenance. Try again later.
PANDORA Cannot Connect	Appears when Pandora is unable to play music. Check your device.
PANDORA Loading...	Appears when Pandora is loading.

XM® Radio Service*

■ Subscribing to XM® Radio

1. You need your radio ID ready before registering for subscription. To see the ID in the display: Turn the selector knob until **0** appears.
2. Have your radio ID and credit card number ready, and either call or visit the XM® website to subscribe.

■ Receiving XM® Radio

Press the ((**XM**)) (XM®) button and stay in this mode for about 30 minutes until the service is activated. Make sure your vehicle is in an open area with good reception.

■ XM® Radio Display Messages

Loading...:

XM® is loading the audio or program information.

Channel Off Air:

The channel is not currently broadcasting.

Channel Not Authorized:

XM® radio is receiving information update from the network.

No Signal:

The signal is too weak in the current location.

-----:

No such channel exists, the channel is not part of your subscription, or the artist or title information is unavailable.

Check Antenna:

There is a problem with the XM® antenna. Contact a dealer.

* Not available on all models

☒ Subscribing to XM® Radio

Contact Information for XM® Radio:

US: XM® Radio at www.siriusxm.com or

1-800-852-9696

Canada: XM® Canada at www.xmradio.ca, or

1-877-209-0079

☒ Receiving XM® Radio

The XM® satellites are in orbit over the equator; therefore, objects south of the vehicle may cause satellite reception interruptions. Satellite signals are more likely to be blocked by tall buildings and mountains the farther north you travel from the equator.

You may experience reception problems under the following circumstances:

- In a location with an obstruction to the south of your vehicle.
- In tunnels
- On the lower level of a multi-tiered road
- Large items carried on the roof rack

Recommended CDs

- Use only high-quality CD-R or CD-RW discs labeled for audio use.
- Use only CD-R or CD-RW discs on which the recordings are closed.
- Play only standard round-shaped CDs.

The CD packages or jackets should have one of these marks.



CDs with MP3, WMA or AAC files

- Some software files may not allow for audio play or text data display.
- Some versions of MP3, WMA or AAC formats may be unsupported.

▶▶ Recommended CDs

A Dual-disc cannot play on this audio unit. If recorded under certain conditions, a CD-R or CD-RW may not play either.

■ Protecting CDs

Follow these precautions when handling or storing CDs:

- Store a CD in its case when it is not being played.
- When wiping a CD, use a soft clean cloth from the center to the outside edge.
- Handle a CD by its edge. Never touch either surface.
- Never insert foreign objects into the CD player.
- Keep CDs out of direct sunlight and extreme heat.
- Do not place stabilizer rings or labels on the CD.
- Avoid fingerprints, liquids, and felt-tip pens on the CD.

▶▶ Protecting CDs

NOTICE

Do not insert a damaged CD. It may be stuck inside and damage the audio unit.

Examples:

- **Bubbled, wrinkled, labeled, and excessively thick CDs**

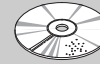

Bubbled/
Wrinkled

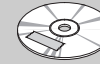

With Label/
Sticker



Using
Printer Label
Kit

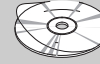

Sealed

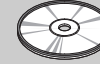

With Plastic Ring

- **Damaged CDs**

- **Poor quality CDs**

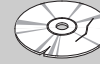

Chipped/
Cracked

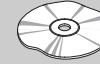

Warped

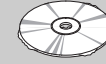

Burrs

- **Small CDs**



3-inch
(8-cm)
CD

Compatible iPod®, iPhone®, and USB Flash Drives

■ iPod® and iPhone® Model Compatibility

Model
iPod® (5th generation)
iPod classic® 80/160GB (launched in 2007)
iPod classic® 120GB (launched in 2008)
iPod classic® 160GB (launched in 2009)
iPod nano® (launched in 2010)
iPod touch® (launched in 2010)
iPhone® 3G/iPhone® 3GS/iPhone® 4

■ USB Flash Drives

- Use a recommended USB flash drive of 256 MB or higher.
- Some digital audio players may not be compatible.
- Some USB flash drives (e.g., a device with security lockout) may not work.
- Some software files may not allow for audio play or text data display.
- Some versions of MP3, WMA, or AAC formats may be unsupported.

⌘ iPod® and iPhone® Model Compatibility

This system may not work with all software versions of these devices.

⌘ USB Flash Drives

Files on the USB flash drive are played in their stored order. This order may be different from the order displayed on your PC or device.

QRG

The HomeLink® Universal Transceiver can be programmed to operate up to three remote controlled devices around your home, such as garage doors, lighting, or home security systems.

■ Important Safety Precautions

Refer to the safety information that comes with your garage door opener to test that the safety features are functioning properly. If you do not have the safety information, contact the manufacturer.

Before programming HomeLink, make sure that people and objects are out of the way of the garage or gate to prevent potential injury or damage.

When programming a garage door opener, park just outside the garage door's path.

Training HomeLink

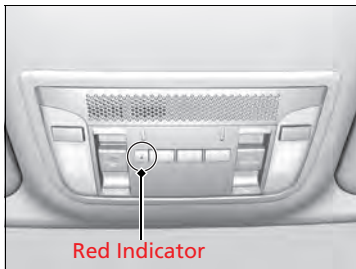

If you have not trained any of the buttons in HomeLink before, you should erase any previously learned codes. To do this:

- Press and hold the two outside buttons for about 20 seconds, until the red indicator blinks. Release the buttons, and proceed to step 1.
- If you are training the second or third button, go directly to step 1.

▣ HomeLink® Universal Transceiver*

HomeLink® is a registered trademark of Johnson Controls., Inc.

Before programming HomeLink to operate a garage door opener, confirm that the opener has an external entrapment protection system, such as an "electronic eye," or other safety and reverse stop features. If it does not, HomeLink may not be able to operate it.

TOC

Features

Index

Home

* Not available on all models

Continued

■ Training a Button

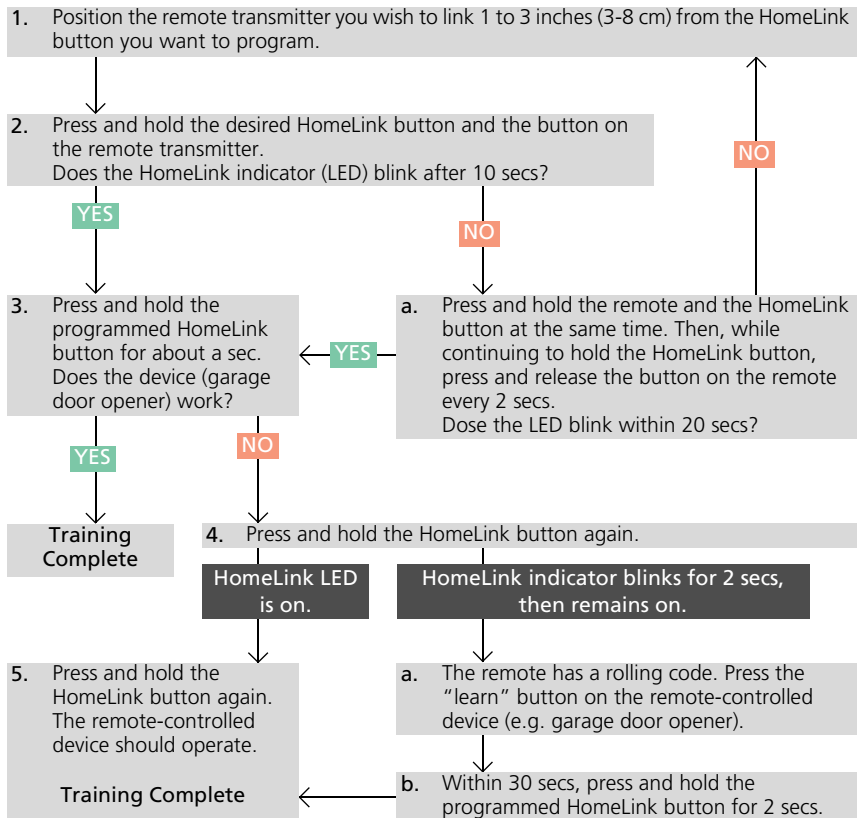

▶▶ Training HomeLink

Retraining a Button

If you want to retrain a programmed button for a new device, you do not have to erase all button memory. You can replace the existing memory code using this procedure:

1. Press and hold the desired HomeLink button until the HomeLink indicator begins to blink.

Standard transmitter

Indicator remains on for about 25 secs.

Rolling code transmitter

Indicator blinks rapidly for two secs, then remains on for about 23 secs.

2. Continue to hold the HomeLink button and follow steps 1 - 3 under "Training a Button."

Erasing Codes

To erase all the codes, press and hold the two outside buttons until the HomeLink indicator begins to blink (about 10 to 20 secs). You should erase all codes before selling the vehicle.

If you have any problems, see the device's instructions, visit www.homelink.com, or call HomeLink at 1-800-355-3515.

Models with navigation system

For models with the navigation system, see Navigation System Manual for how to operate the *Bluetooth*® HandsFreeLink®.

Models without navigation system

Bluetooth® HandsFreeLink® (HFL) allows you to place and receive phone calls using your vehicle's audio system, without handling your cell phone.

Using HFL

HFL Buttons

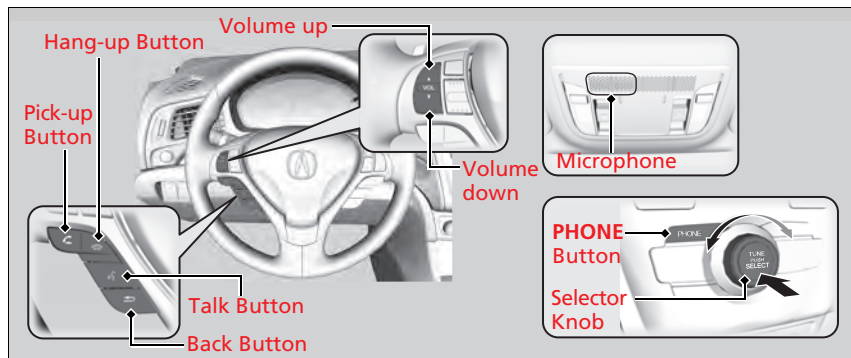

(Pick-up) button: Press to go directly to the **Phone** screen or to answer an incoming call.

(Hang-up) button: Press to end a call.

(Talk) button: Press to call a number with a stored voice tag.

(Back) button: Press to cancel a command.

PHONE button: Press to go directly to the **Phone** screen.

Selector knob: Rotate to select an item on the screen, then press .

Continued

Bluetooth® HandsFreeLink®

To use HFL, you need a *Bluetooth*-compatible cell phone. For a list of compatible phones, pairing procedures, and special feature capabilities:

- **U.S.:** Visit www.acura.com/handsfreelink, or call 1-888-528-7876.
- **Canada:** Visit www.handsfreelink.ca, or call 1-888-528-7876.

Voice control tips

- Aim the vents away from the ceiling and close the windows, as noise coming from them may interfere with the microphone.
- Press and release the button when you want to call a number using a stored voice tag. Speak clearly and naturally after a beep.
- If the microphone picks up voices other than yours, the command may be misinterpreted.
- To change the volume level, use the audio system's volume knob or the remote audio controls on the steering wheel.

HFL Status Display

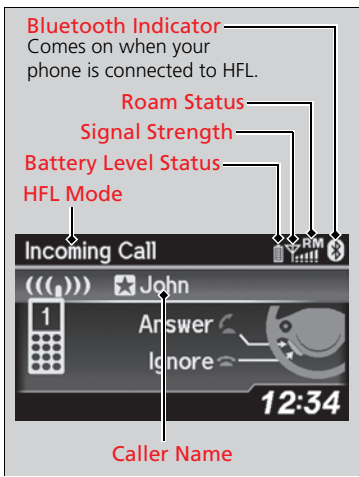

The audio/information screen notifies you when there is an incoming call.

Limitations for Manual Operation

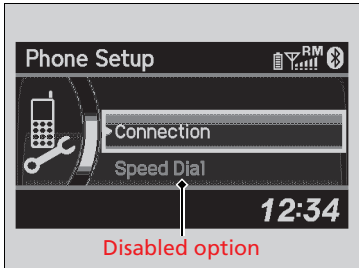

Certain manual functions are disabled or inoperable while the vehicle is in motion. You cannot select a grayed-out option until the vehicle is stopped.

Only previously stored speed dial entries with voice tags can be called using voice commands while the vehicle is in motion.

[▶ Speed Dial P. 196](#)

Bluetooth® HandsFreeLink®

Bluetooth® Wireless Technology
The *Bluetooth®* word mark and logos are registered trademarks owned by *Bluetooth SIG, Inc.*, and any use of such marks by Honda Motors Co., Ltd., is under license. Other trademarks and trade names are those of their respective owners.

HFL Limitations
An incoming call on HFL will interrupt the audio system when it is playing. It will resume when the call is ended.

HFL Status Display

The information that appears on the audio/information screen varies between phone models.

You can change the system language to English, French, or Spanish.
[▶ Language Selection P. 148](#)

HFL Menus

The power mode must be in ACCESSORY or ON to use HFL.

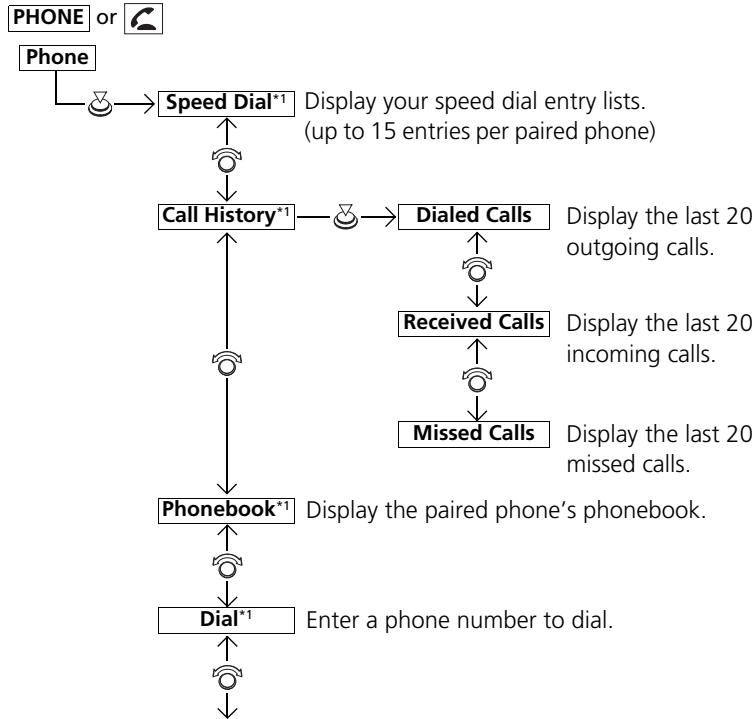

HFL Menus

To use HFL, you must first pair your *Bluetooth*-compatible cell phone to the system while the vehicle is parked.

Some functions are limited while driving. A message appears on the screen when the vehicle is moving and the operation is canceled.

*1: Appears only when a phone is connected to HFL.

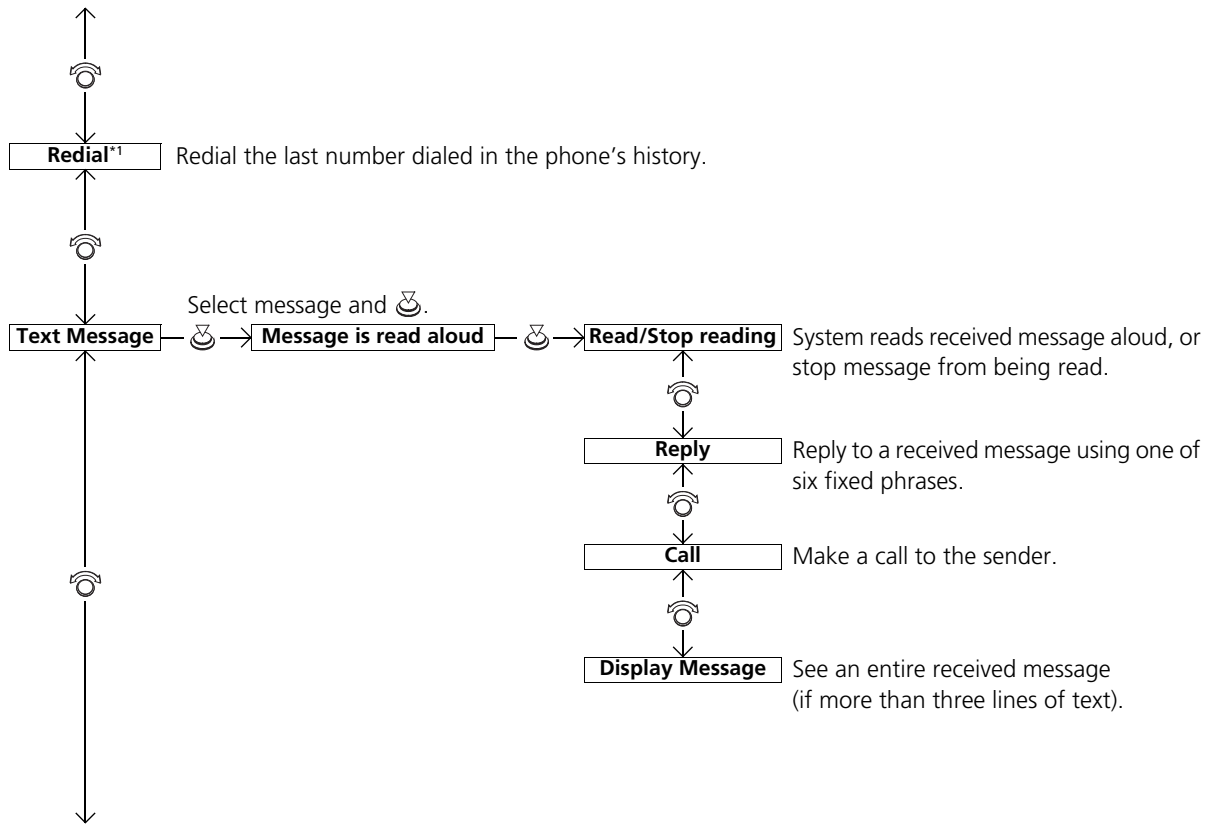

*1: Appears only when a phone is connected to HFL.

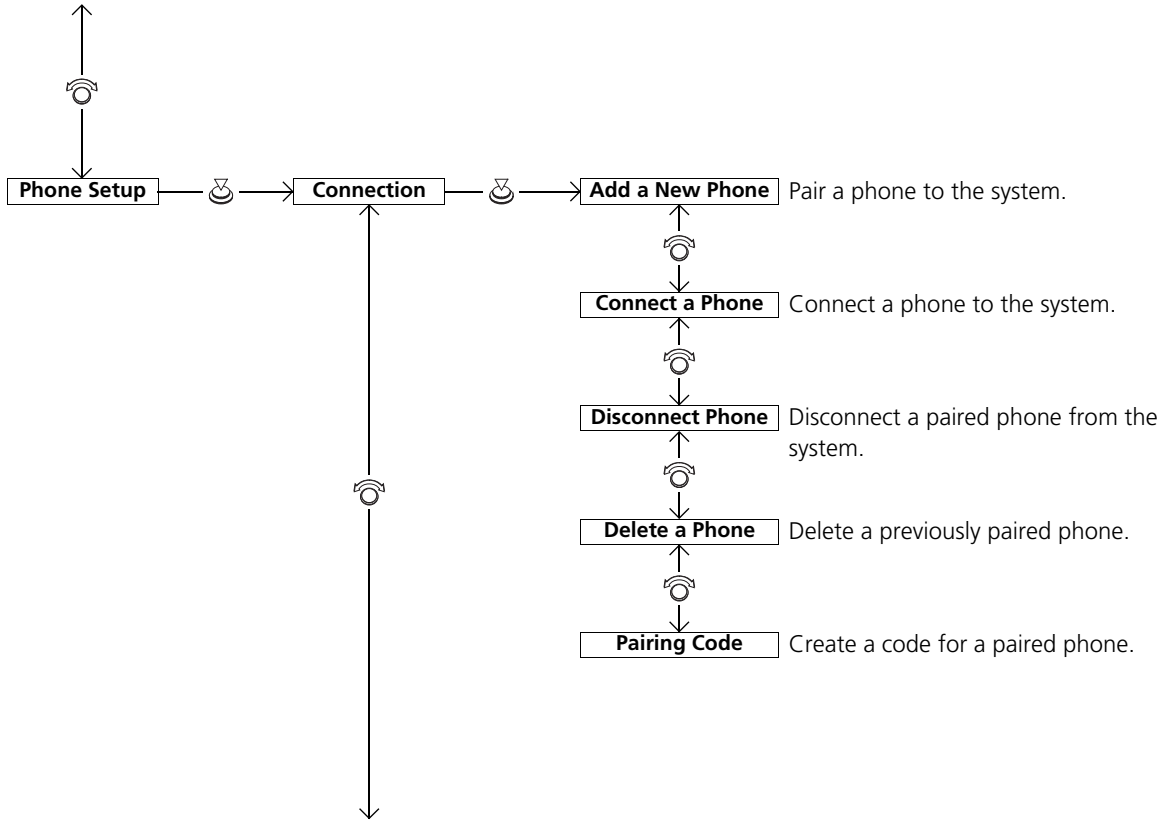

*1: Appears only when a phone is connected to HFL.

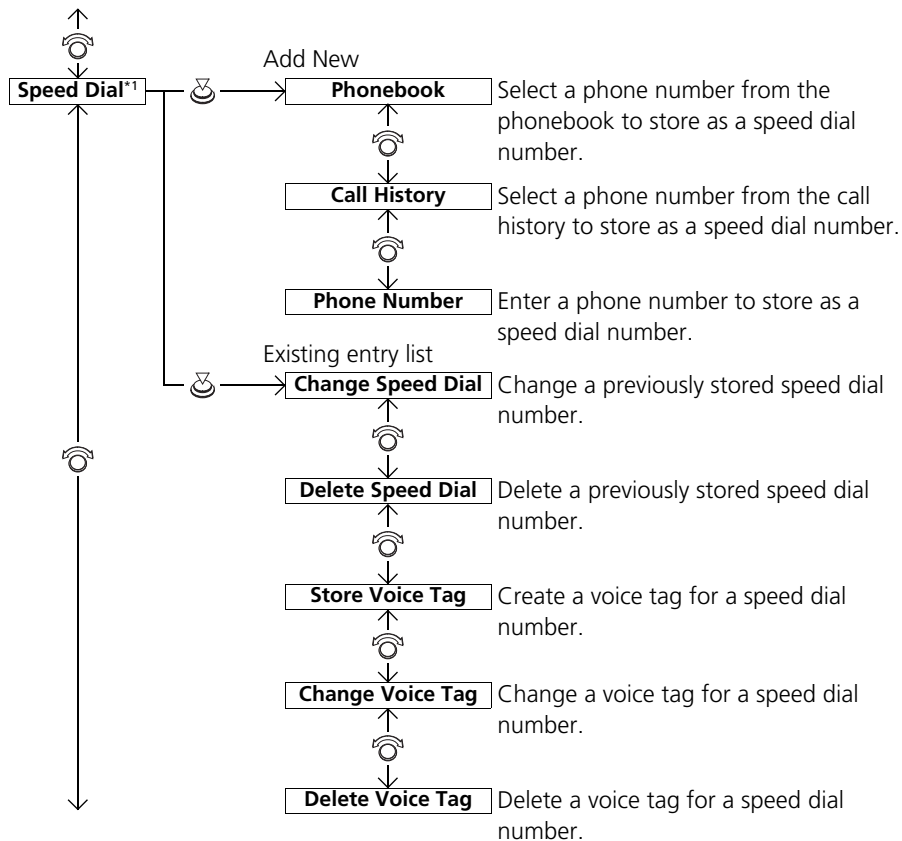

*1: Appears only when a phone is connected to HFL.

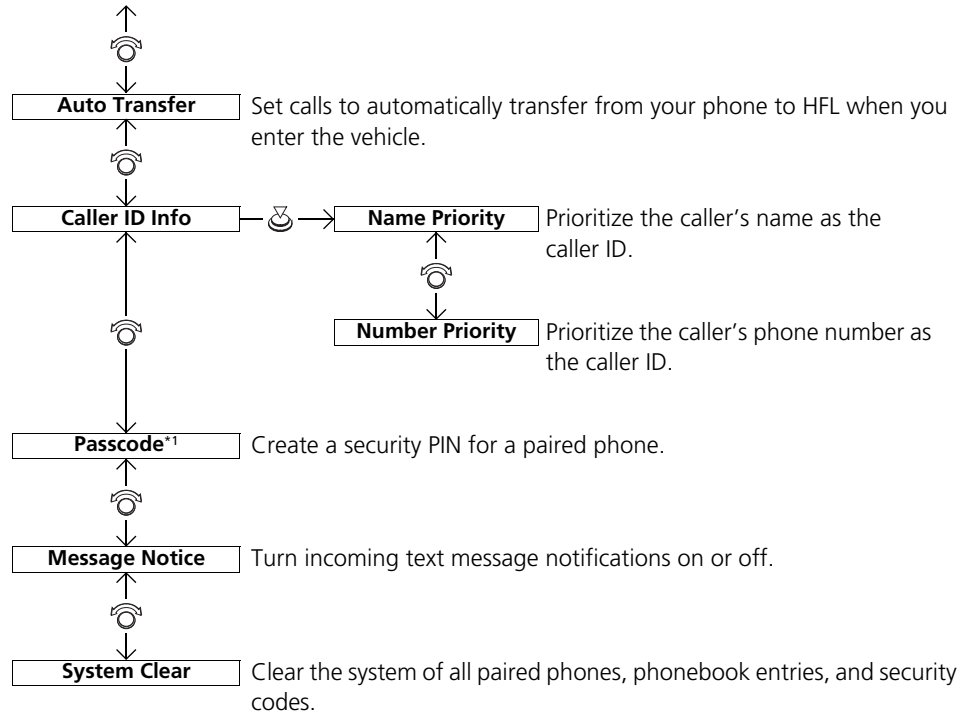

*1: Appears only when a phone is connected to HFL.

Phone Setup

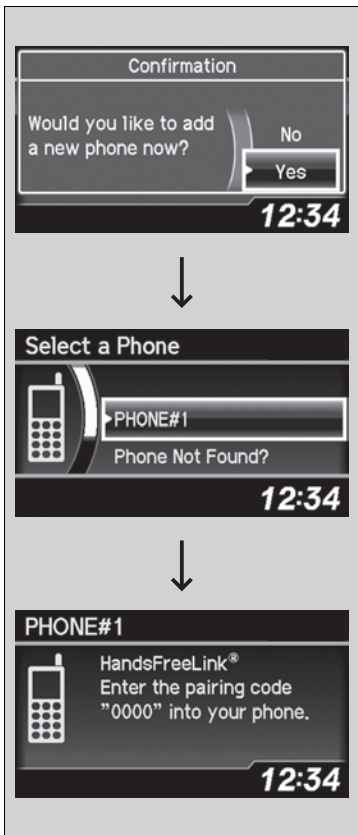

■ To pair a cell phone (when there is no phone paired to the system)

1. Press the **PHONE** button or the button.
2. Rotate to select **Yes**, then press .
3. Make sure your phone is in search or discoverable mode, then press .
 - ▶ HFL automatically searches for a Bluetooth device.
4. When your phone appears on the list, select it by pressing .
 - ▶ If your phone doesn't appear, select **Phone Not Found?** and search for Bluetooth devices using your phone. From your phone, select **HandsFreeLink**.
5. HFL gives you a four-digit pairing code to input on your phone. When your phone prompts you, input the four-digit pairing code.
6. You will receive a notification on the screen if pairing is successful.

☒ Phone Setup

Your *Bluetooth*-compatible phone must be paired to HFL before you can make and receive hands-free calls.

Phone Pairing Tips:

- You cannot pair your phone while the vehicle is moving.
- Up to six phones can be paired.
- Your phone's battery may drain faster when it is paired to HFL.
- If your phone is not ready for pairing or not found by the system within three minutes, the system will time out and returns to idle.







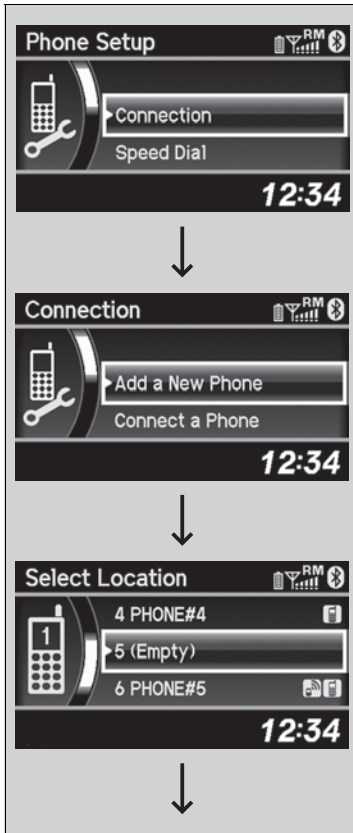

Once you have paired a phone, you can see it displayed on the screen with one or two icons on the right side.

These icons indicate the following:

- : The phone can be used with HFL.
- : The phone is compatible with *Bluetooth*® Audio.



■ **To pair a cell phone (when a phone has already been paired to the system)**

1. Press the **PHONE** button or the  button.
 - ▶ If a prompt appears asking to connect to a phone, select **No** and proceed with step 2.
2. Rotate  to select **Phone Setup**, then press .
3. Rotate  to select **Connection**, then press .
4. Rotate  to select **Add a New Phone**, then press .
 - ▶ The screen changes to **Select Location**.
5. Rotate  to select **Empty**, then press .

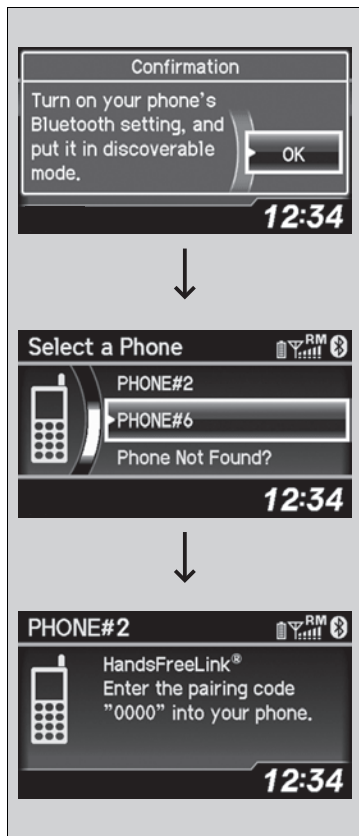

6. Make sure your phone is in search or discoverable mode, then press .
 - ▶ HFL automatically searches for a Bluetooth device.

7. When your phone appears on the list, select it by pressing .
 - ▶ If your phone doesn't appear, select **Phone Not Found?** and search for Bluetooth devices using your phone. From your phone, select **HandsFreeLink**.

8. HFL gives you a four-digit pairing code to input on your phone. When your phone prompts you, input the four-digit pairing code.

9. You will receive a notification on the screen if pairing is successful.

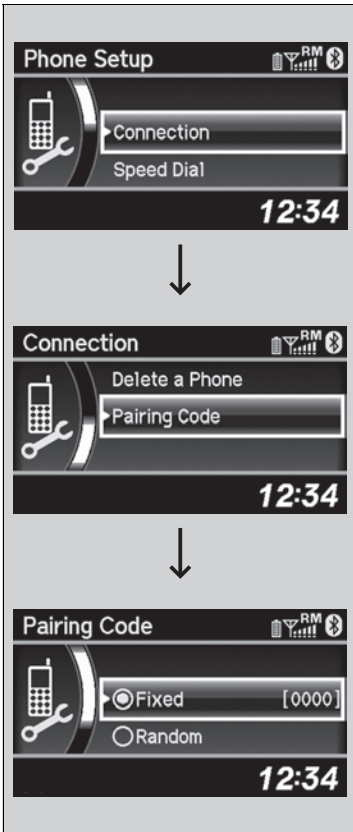

■ **To change the pairing code setting**

1. Press the **PHONE** button or the button.
2. Rotate to select **Phone Setup**, then press .
3. Rotate to select **Connection**, then press .
4. Rotate to select **Pairing Code**, then press .
5. Rotate to select **Fixed** or **Random**, then press .

▶▶ To change the pairing code setting





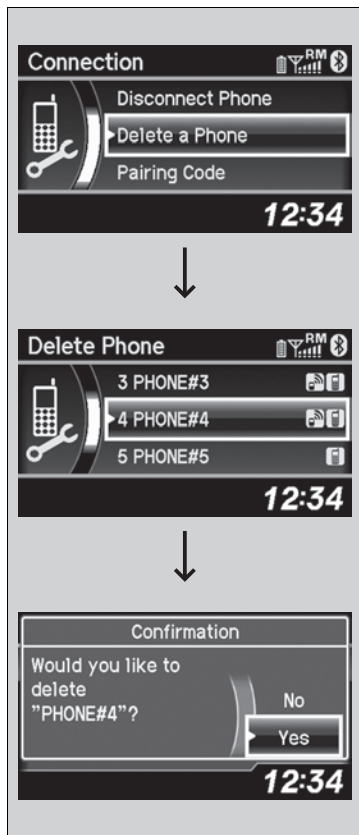

The default pairing code is **0000** until you change the setting.

To create your own, select **Fixed**, and delete the current code, then enter a new one.

For a randomly generated pairing code each time you pair a phone, select **Random**.



■ **To delete a paired phone**

1. Press the **PHONE** button or the  button.
2. Rotate  to select **Phone Setup**, then press .
 - ▶ Repeat the procedure to select **Connection**, then **Delete a Phone**.
3. Rotate  to select a phone you want to delete, then press .
4. You will receive a confirmation message on the screen. Rotate  to select **Yes**, then press .
 - ▶ You will receive a notification on the screen if it is successful.

To Set Up a Text Message Notice Option



1. Press the **PHONE** button or the button.
2. Rotate to select **Phone Setup**, then press .
3. Rotate to select **Message Notice**, then press .
4. Rotate to select a mode you want, then press .

To Set Up a Text Message Notice Option

On: A pop-up notification comes on every time you receive a new text message.









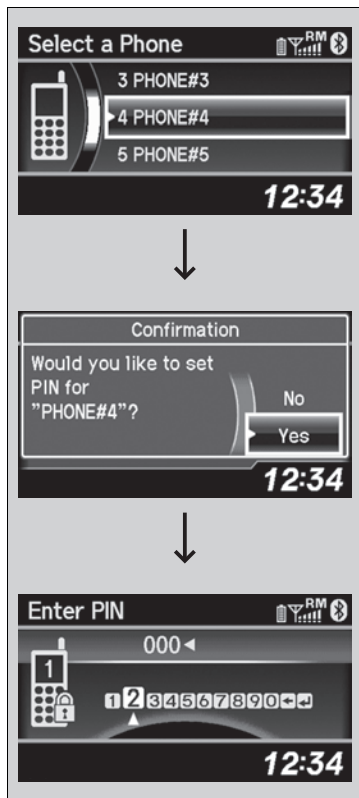

Off: The message you receive is stored in the system without notification.

Continued

■ To Create a Security PIN

You can protect each of the six cell phones with a security PIN.



1. Press the **PHONE** button or the  button.
2. Rotate  to select **Phone Setup**, then press .
 - ▶ Repeat the procedure to select **Passcode**.
3. Select a phone you want to add a security PIN to.
 - ▶ Rotate  to select a phone you want to add a security PIN to, then press .
4. You will receive a confirmation message on the screen.
 - ▶ Rotate  to select **Yes**, then press .
5. Enter a new four-digit number.
 - ▶ Rotate  to select, then press . Press  to delete. Press  to enter the security PIN.
6. Re-enter the four-digit number.
 - ▶ The screen returns to the screen in step 2.





▶▶ To Create a Security PIN

In the phone is already security PIN protected, you need to enter the current security PIN before clearing the PIN or creating a new one.

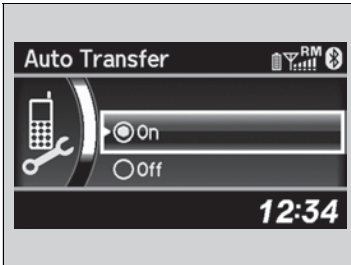
Automatic Transferring

If you get into the vehicle while you are on the phone, the call can be automatically transferred to HFL.





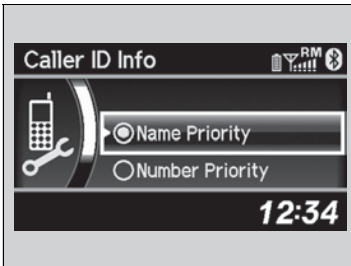

1. Press the **PHONE** button or the  button.
2. Rotate  to select **Phone Setup**, then press .
 - ▶ Repeat the procedure to select **Auto Transfer**.
3. Rotate  to select **On**, then press .
4. You will receive a notification on the screen if the change is successful.

Caller's ID Information

You can select a caller's information to be displayed when you have an incoming call.



1. Press the **PHONE** button or the  button.
2. Rotate  to select **Phone Setup**, then press .
 - ▶ Repeat the procedure to select **Caller ID Info**.
3. Rotate  to select a mode you want, then press .
4. You will receive a notification on the screen if the change is successful.

☒ Caller's ID Information

Name Priority mode: A caller's name is displayed if it is stored in the phonebook.







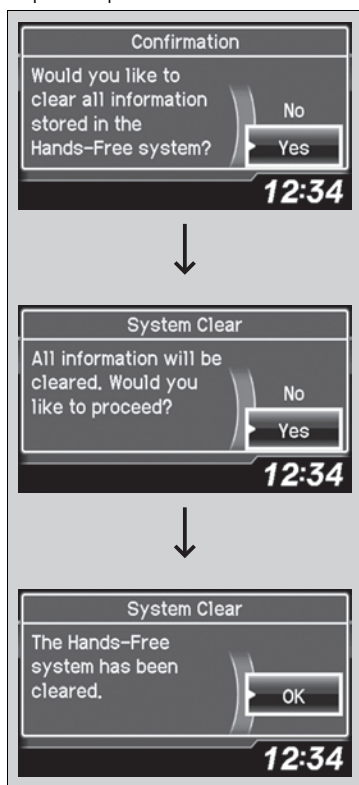

Number Priority mode: A caller's phone number is displayed.

Continued

■ To Clear the System

Security codes, paired phones, all stored voice tags, all speed dial entries, and all imported phonebook data are erased.



1. Press the **PHONE** button or the  button.
2. Rotate  to select **Phone Setup**, then press .
 - ▶ Repeat the procedure to select **System Clear**.
3. Rotate  to select **Yes**, then press .
4. You will receive a notification message on the screen. Rotate  to select **Yes**, then press .
5. You will receive a confirmation message on the screen. Press  to finish.

Automatic Import of Cellular Phonebook and Call History

When your phone is paired, the contents of its phonebook and call history are automatically imported to HFL.



Automatic Import of Cellular Phonebook and Call History

When you select a person from the list in the cellular phonebook, you can see up to three category icons.

The icons indicate what types of numbers are stored for that name.



On some phones, it may not be possible to import the category icons to HFL.

The phonebook is updated after every connection. Call history is updated after every connection or call.

Speed Dial

Up to 15 speed dial numbers can be stored per phone.

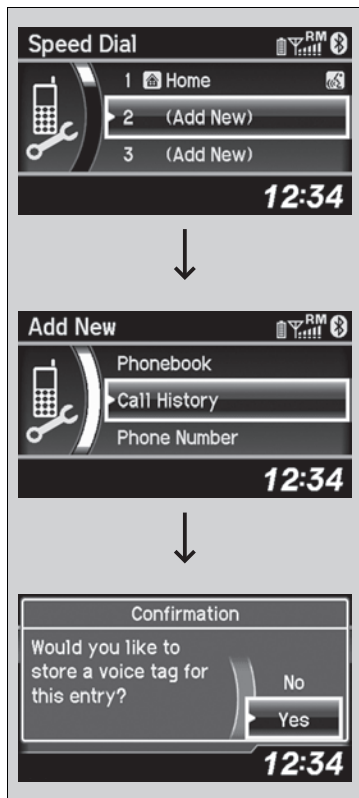

To store a speed dial number:

1. Press the **PHONE** button or the button.
2. Rotate to select **Phone Setup**, then press .
 - ▶ Repeat the procedure to select **Speed Dial**, then **Add New**.
3. Rotate to select a place to choose a number from, then press .
 - By **Phonebook**:
 - ▶ Select a number from the linked cell phone's imported phonebook.
 - By **Call History**:
 - ▶ Select a number from the call history.
 - By **Phone Number**:
 - ▶ Input the number manually.
4. When the speed dial is successfully stored, you are asked to create a voice tag for the number. Rotate to select **Yes** or **No**, then press .
5. Using the button, follow the prompts to say the name for the speed dial entry.

Speed Dial

You can use the audio preset buttons during a call to store a speed dial number:

1. Press and hold the desired audio preset button during a call.
2. The contact information for the active call will be stored for the corresponding speed dial.

When a voice tag is stored, press the button to call the number using the voice tag.



■ To add a voice tag to a stored speed dial number

1. Press the **PHONE** button or the button.
2. Rotate to select **Phone Setup**, then press .
 - ▶ Repeat the procedure to select **Speed Dial**.
3. Select an existing speed dial entry.
4. Rotate to select **Store Voice Tag**, then press .
5. Using the button, follow the prompts to complete the voice tag.

■ To delete a voice tag

1. Press the **PHONE** button or the button.
2. Rotate to select **Phone Setup**, then press .
 - ▶ Repeat the procedure to select **Speed Dial**.
3. Select an existing speed dial entry.
4. Rotate to select **Delete Voice Tag**, then press .
 - ▶ You will receive a confirmation message on the screen. Rotate to select **Yes**, then press .

▶ Speed Dial

Avoid using duplicate voice tag.

Avoid using "home" as a voice tag.

It is easier for HFL to recognize a longer name. For example, use "John Smith" instead of "John."

Continued

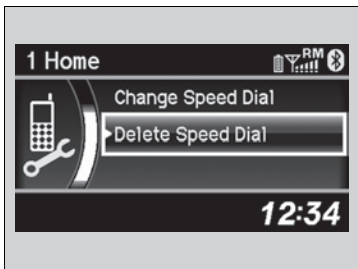

■ **To delete a speed dial number**

1. Press the **PHONE** button or the button.
2. Rotate to select **Phone Setup**, then press .
 - ▶ Repeat the procedure to select **Speed Dial**.
3. Select an existing speed dial entry.
4. Rotate to select **Delete Speed Dial**, then press .
 - ▶ You will receive a confirmation message on the screen. Rotate to select **Yes** then press .

■ **Making a Call**

You can make calls by inputting any phone number, or by using the imported phonebook, call history, speed dial entries, or redial.

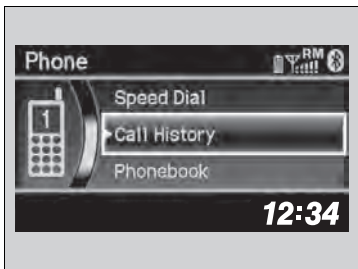

▣ Making a Call

Any voice-tagged speed dial entry can be dialed by voice from any screen.

Press the button and follow the prompts.

The maximum range between your phone and vehicles is 30 feet (10 meters).

Once a call is connected, you can hear the voice of the person you are calling through the audio speakers.

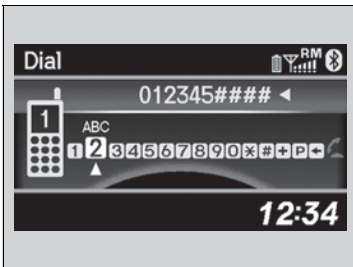
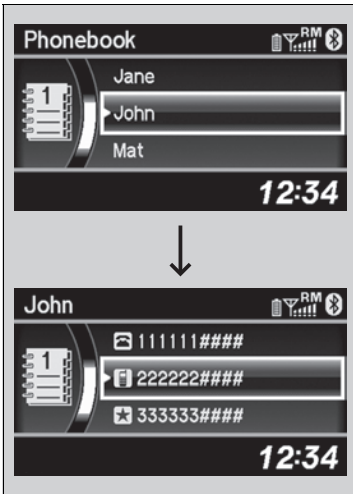

■ To make a call using the imported phonebook

When your phone is paired, the contents of its phonebook are automatically imported to HFL.

1. Press the **PHONE** button or the button.
2. Rotate to select **Phonebook**, then press .
3. The phonebook is stored alphabetically. Rotate to select the initial, then press .
4. Rotate to select a name, then press .
5. Rotate to select a number, then press .
 - ▶ Dialing starts automatically.

■ To make a call using a phone number

1. Press the **PHONE** button or the button.
2. Rotate to select **Dial**, then press .
3. Rotate to select a number, then press .
4. Rotate to select , then press .
 - ▶ Dialing starts automatically.

☒ To make a call using the imported phonebook

This function is disabled while the vehicle is moving. However, you can call a stored speed dial number with a voice tag using voice commands.

- ▶ [Limitations for Manual Operation P. 180](#)
- ▶ [Speed Dial P. 196](#)

☒ To make a call using a phone number

This function is disabled while the vehicle is moving. However, you can call a stored speed dial number with a voice tag using voice commands.

- ▶ [Limitations for Manual Operation P. 180](#)
- ▶ [Speed Dial P. 196](#)

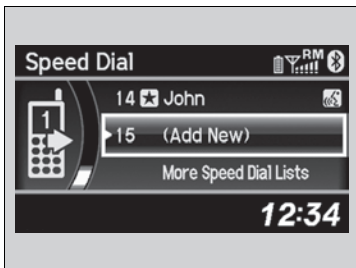
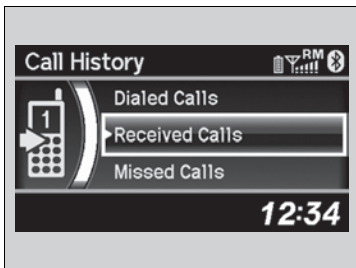
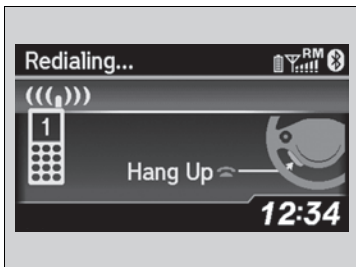

■ **To make a call using redial**

1. Press the **PHONE** button or the button.
2. Rotate to select **Redial**, then press .
 - ▶ Dialing starts automatically.

■ **To make a call using the call history**
Call history is stored by **Dialed Calls**, **Received Calls**, and **Missed Calls**.

1. Press the **PHONE** button or the button.
2. Rotate to select **Call History**, then press .
3. Rotate to select **Dialed Calls**, **Received Calls**, or **Missed Calls**, then press .
4. Rotate to select a number, then press .
 - ▶ Dialing starts automatically.

■ **To make a call using a speed dial entry**

1. Press the **PHONE** button or the button.
2. Rotate to select **Speed Dial**, then press .
3. Rotate to select a number, then press .
 - ▶ Dialing starts automatically.

» To make a call using the call history

The call history displays the last 20 dialed, received, or missed calls.
(Appears only when a phone is connected to HFL.)

» To make a call using a speed dial entry

On the **Phone** screen, the first six speed dials on the list can be directly selected by pressing the corresponding audio preset buttons (1-6).

Select **More Speed Dial Lists** to view another paired phone's speed dial list.

When a voice tag is stored, press the button to call the number using the voice tag.

[Speed Dial P. 196](#)

Any voice-tagged speed dial entry can be dialed by voice from any screen.

Press the button and follow the prompts.

Receiving a Call

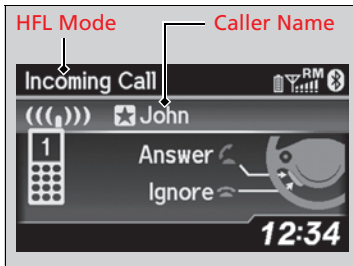

When there is an incoming call, an audible notification sounds (if activated) and the **Incoming Call** screen appears.

Press the  button to answer the call.

Press the  button to decline or end the call.

Receiving a Call

Call Waiting

Press the  button to put the current call on hold to answer the incoming call.

Press the  button again to return to the current call.

Ignore the incoming call if you do not want to answer it.

Press the  button if you want to hang up the current call.

Options During a Call

The following options are available during a call.



Mute: Mute your voice.

Transfer Call: Transfer a call from HFL to your phone.

Touch Tones: Send numbers during a call. This is useful when you call a menu-driven phone system.



1. To view the available options, press the **PHONE** button.

2. Rotate  to select the option, then press .
 - ▶ The check box is checked when **Mute** is selected. Select **Mute** again to turn it off.

Options During a Call

Touch Tones: Available on some phones.

Receiving a Text Message

HFL can display newly received text messages as well as 20 of the most recently received messages on a linked cell phone. Each received message can be read aloud and replied to using a fixed common phrase.



1. A pop-up appears and notifies you of a new text message.
2. Rotate to select **Yes** to listen to the message, then press .
 - ▶ The text message is displayed. The system automatically starts reading out the message.
3. To discontinue the message read-out, press the **BACK** button.

Receiving a Text Message

The system does not display any received messages while you are driving. You can only hear them read aloud.

With some phones, you may be able to display up to 20 most recent text messages.





Only the first three lines of the received message are displayed with this option.

[▶ Displaying an entire message P. 207](#)

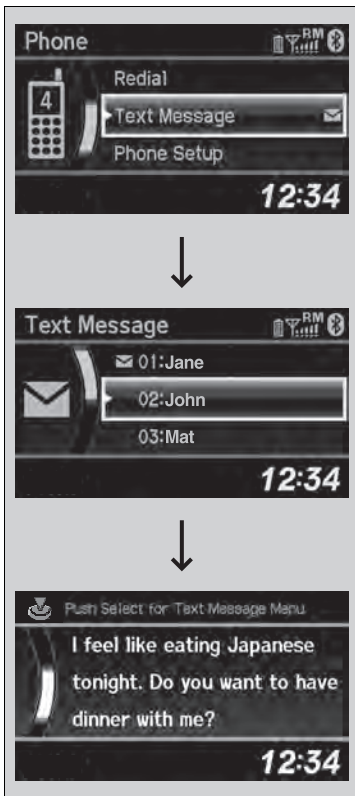
State or local laws may limit your use of the HFL text message feature. Only use the text message feature when conditions allow you to do so safely.

■ Displaying Messages



1. Press the **PHONE** button or the  button.
2. Rotate  to select **Text Message**, then press .
3. Rotate  to select a message, then press .
 - ▶ The text message is displayed. The system automatically starts reading the message aloud.

» Displaying Messages

The  icon appears next to an unread message.







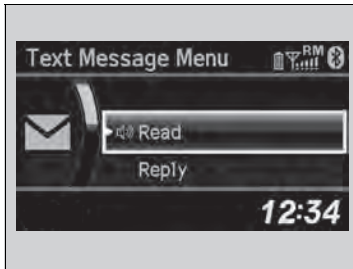

Only the first three lines of the received message are displayed with this option.

[▶ Displaying an entire message P. 207](#)

If you delete a message on the phone, the message is also deleted in the system. If you send a message from the system, the message goes to your phone's outbox.



■ Using the stop reading or read option

1. Press the **PHONE** button or the  button.
2. Rotate  to select **Text Message**, then press .
3. Rotate  to select a message, then press .
 - ▶ The text message is displayed. The system automatically starts reading the message aloud.
4. Press  to enter the **Text Message Menu**.
5. Rotate  to select **Stop Reading** or **Read**, then press .

☒ Using the stop reading or read option

This option changes to:

- **Stop Reading** while the text message is read out. Select this option to discontinue the message read-out.
- **Read** when you go to the **Text Message** menu, or after you selected **Stop Reading**. Select this option to hear the system reading out the selected message.



■ Reply to a message

You can reply to a message using one of the six common phrases available in the system.

1. Press the **PHONE** button or the button.
2. Rotate to select **Text Message**, then press .
3. Rotate to select a message, then press .
 - ▶ The text message is displayed. The system automatically starts reading out the message.
4. Press to enter the **Text Message Menu**.
5. Rotate to select **Reply**, then press .
6. Rotate to select the reply message, then press .
7. The reply message you selected is displayed. Select **Yes** to send the message.

▶▶ Reply to a message

The available fixed reply messages are as follows:

- **Talk to you later, I'm driving.**
- **I am on my way.**
- **I'm running late.**
- **OK**
- **Yes**
- **No**

You cannot add, edit, or delete reply messages.



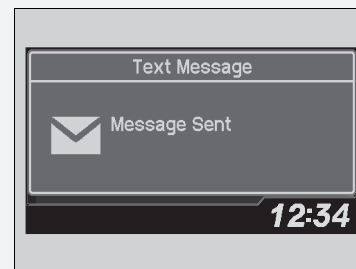

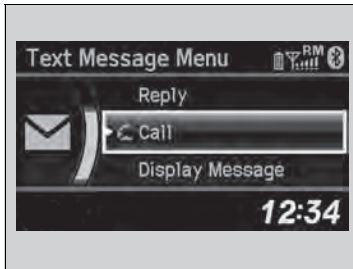



After you reply, the following is displayed:













■ Making a call to a sender

You can call the text message sender.

1. Press the **PHONE** button or the  button.
2. Rotate  to select to **Text Message**, then press .
3. Rotate  to select a message, then press .
 - ▶ The text message is displayed. The system automatically starts reading out the message.
4. Press  to enter the **Text Message Menu**.
5. Rotate  to select **Call**, then press .
 - ▶ HFL begins dialing.

■ Displaying an entire message

1. Press the **PHONE** button or the  button.
2. Rotate  to select to **Text Message**, then press .
3. Rotate  to select a message, then press .
 - ▶ The text message is displayed. The system automatically starts reading out the message.
4. Press  to enter the **Text Message Menu**.
5. Rotate  to select **Display Message**, then press .
6. Rotate  to scroll down and display the entire message.



Driving

This chapter discusses driving, refueling, and information on items such as accessories.



Before Driving

- Driving Preparation 210
- Maximum Load Limit..... 213

Towing a Trailer

- Towing Your Vehicle 215

When Driving

- Starting the Engine 216
- Precautions While Driving..... 220
- Automatic Transmission 221

Automatic transmission models

- Shifting 222

Manual transmission models

- Shifting 226

- Cruise Control 229
- VSA® (Vehicle Stability Assist), aka ESC (Electronic Stability Control), System 232
- TPMS (Tire Pressure Monitoring System)... 234
- Tire Pressure Monitoring System (TPMS) - Required Federal Explanation 235

Braking

- Brake System 237
- ABS (Anti-lock Brake System) 239
- Brake Assist System..... 240

Parking Your Vehicle

- When Stopped..... 241

- Parking Your Vehicle**..... 241

- Multi-View Rear Camera**..... 242

Refueling

- Fuel Information 243
- How to Refuel 244

- Fuel Economy**..... 245

- Improving Fuel Economy..... 245

Accessories and Modifications

- Accessories 246
- Modifications..... 246



Driving Preparation

Check the following items before you start driving.

Exterior Checks

- Make sure there are no obstructions on the windows, door mirrors, exterior lights, or other parts of the vehicle.
 - ▶ Remove any frost, snow, or ice.
 - ▶ Remove any snow on the roof, as this can slip down and obstruct your field of vision while driving. If frozen solid, remove ice once it has softened.
 - ▶ When removing ice from around the wheels, be sure not to damage the wheel or wheel components.
- Make sure the hood is securely closed.
 - ▶ If the hood opens while driving, your front view will be blocked.
- Make sure the tires are in good condition.
 - ▶ Check air pressures, and check for damage and excessive wear.
 - ▶ [Checking and Maintaining Tires P. 286](#)
- Make sure there are no people or objects behind or around the vehicle.
 - ▶ There are blind spots from the inside.

Exterior Checks

NOTICE

When doors are frozen shut, use warm water around the door edges to melt any ice. Do not try to force them open, as this can damage the rubber trim around the doors. When done, wipe dry to avoid further freezing.

Do not pour warm water into the key cylinder. You will be unable to insert key if the water freezes in the hole.

Heat from the engine and exhaust can ignite flammable materials left under the hood, causing a fire. If you've parked your vehicle for an extended period, inspect and remove any debris that may have collected, such as dried grass and leaves that have fallen or have been carried in for use as a nest by a small animal.

Also check under the hood for leftover flammable materials after you or someone else has performed maintenance on your vehicle.

Interior Checks

- Store or secure all items on board properly.
 - ▶ Carrying too much cargo, or improperly storing it, can affect your vehicle's handling, stability, stopping distance, and tires, and make it unsafe.
 - [Maximum Load Limit P. 213](#)
- Do not pile items higher than the seat height.
 - ▶ They can block your view and may be thrown forward in the event of sudden braking.
- Do not place anything in the front seat footwells. Make sure to secure the floor mat.
 - ▶ An object or unsecured floor mat can interfere with your brake and accelerator pedal operation while driving.
- If you have any animals on board, do not let them move around in the vehicle.
 - ▶ They may interfere with driving and a crash could occur.
- Securely close and lock all doors and the trunk.
 - [Locking/Unlocking the Doors from the Inside P. 99](#)
- Adjust your seating position properly.
 - ▶ Adjust the head restraint, too.
 - [Adjusting the Seats P. 123](#)
 - [Adjusting the Head Restraints P. 126](#)
- Adjust the mirrors and steering wheel properly for your driving.
 - ▶ Adjust them while sitting in the proper driving position.
 - [Adjusting the Mirrors P. 121](#)
 - [Adjusting the Steering Wheel P. 120](#)

Interior Checks

The headlight aim is set by the factory, and does not need to be adjusted. However, if you regularly carry heavy items in the trunk have the aiming readjusted at a dealer or by a qualified technician.

QRG

- Be sure items placed on the floor behind the front seats cannot roll under the seats.
 - ▶ They can interfere with the driver's ability to operate the pedals, the operation of the seats, or the operation of the sensors under the seats.
- Everyone in the vehicle must fasten their seat belt.
 - ▶ [Fastening a Seat Belt P. 29](#)
- Make sure that the indicators in the instrument panel come on when you start the vehicle, and go off soon after.
 - ▶ Always have a dealer check the vehicle if a problem is indicated.
 - ▶ [Indicators P. 64](#)

TOC

Driving

Index

Home

Maximum Load Limit

The maximum load for your vehicle is 850 lbs (385 kg).
See Tire and Loading Information label attached to the driver's doorjamb.

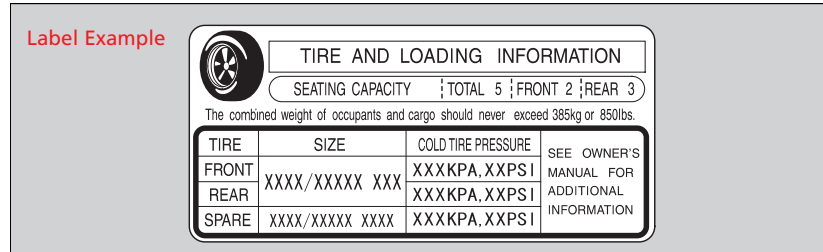

This figure includes the total weight of all occupants, cargo, and accessories, and the tongue load if you are towing a trailer.

Steps for Determining Correct Load Limit -

- (1) Locate the statement "The combined weight of occupants and cargo should never exceed XXX kg or XXX lbs." on your vehicle's placard.
- (2) Determine the combined weight of the driver and passengers that will be riding in your vehicle.
- (3) Subtract the combined weight of the driver and passengers from XXX kg or XXX lbs.
- (4) The resulting figure equals the available amount of cargo and luggage load capacity. For example, if the "XXX" amount equals 1,400 lbs. and there will be five 150 lb. passengers in your vehicle, the amount of available cargo and luggage load capacity is 650 lbs.
(1,400 - 750 (5 x 150) = 650 lbs.)

Maximum Load Limit

⚠ WARNING

Overloading or improper loading can affect handling and stability and cause a crash in which you can be hurt or killed.

Follow all load limits and other loading guidelines in this manual.

Gross Vehicle Weight Rating (GVWR):

The maximum allowable weight of the vehicle, all occupants, all accessories, and all cargo.

➤ [Specifications P. 330, 332](#)

Gross Axle Weight Rating (GAWR):

The maximum allowable weight of the vehicle axle.







➤ [Specifications P. 330, 332](#)

QRG

- (5) Determine the combined weight of luggage and cargo being loaded on the vehicle. That weight may not safely exceed the available cargo and luggage load capacity calculated in step 4.
- (6) If your vehicle will be towing a trailer, load from your trailer will be transferred to your vehicle. Consult this manual to determine how this reduces the available cargo and luggage load capacity of your vehicle.

In addition, the total weight of the vehicle, all occupants, accessories, cargo, and trailer tongue load must not exceed the Gross Vehicle Weight Rating (GVWR) or the Gross Axle Weight Rating (GAWR). Both are on a label on the driver's doorjamb.

Load Limits Example

<p>Example 1</p>  <p>Max Load 850 lbs (385 kg)</p>	\leq		<p>+</p>	
		<p>Passenger Weight 150 lbs x 2 = 300 lbs (68 kg x 2 = 136 kg)</p>		<p>Cargo Weight 550 lbs (249 kg)</p>
<p>Example 2</p>  <p>Max Load 850 lbs (385 kg)</p>	\leq		<p>+</p>	
		<p>Passenger Weight 150 lbs x 5 = 750 lbs (68 kg x 5 = 340 kg)</p>		<p>Cargo Weight 100 lbs (45 kg)</p>

TOC

Driving

Index

Home

Your vehicle is not designed to tow a trailer. Attempting to do so can void your warranties.

Towing Your Vehicle

Your vehicle is not designed to be towed behind a motor home. If your vehicle needs to be towed in an emergency, refer to the emergency towing information.

[📄 Emergency Towing P. 327](#)

Starting the Engine

QRG

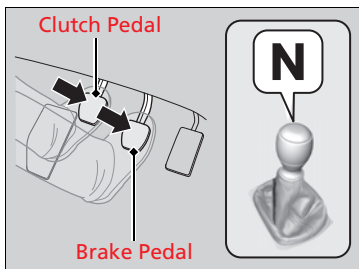
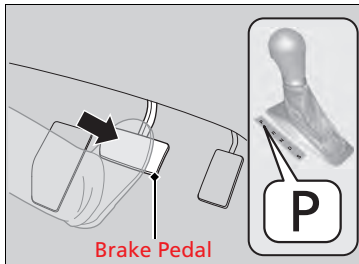
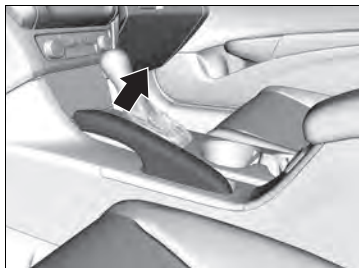

1. Make sure the parking brake is applied.

Automatic transmission models

2. Check that the shift lever is in **P**, then depress the brake pedal.

▶ Although it is possible to start the vehicle in **N**, it is safer to start it in **P**.

Manual transmission models

2. Check that the shift lever is in **N**. Then depress the brake pedal with your right foot, and the clutch pedal with your left foot.

▶ The clutch pedal must be fully depressed to start the engine.

Starting the Engine

Keep your foot firmly on the brake pedal when starting the engine.

The engine is harder to start in cold weather and in thinner air found at altitudes above 8,000 feet (2,400 meters).

When starting the engine in cold weather, turn off all electrical accessories such as the lights, climate control system, and rear defogger in order to reduce battery drain.

If you live in a region where winter is extremely cold, an engine block heater will improve starting and warming of the engine. If temperatures consistently below -22°F (-30°C) are expected, the coolant mixture should be changed to a higher concentration to prevent freezing. Consult a dealer for details.

If exhaust system sounds abnormal or you can smell exhaust gas inside the vehicle, have your vehicle checked by a dealer. There may be a problem with the engine or exhaust system.

The immobilizer system protects your vehicle from theft.

If an improperly coded device is used, the engine's fuel system is disabled.

[Immobilizer System P. 106](#)

TOC

Driving

Index

Home

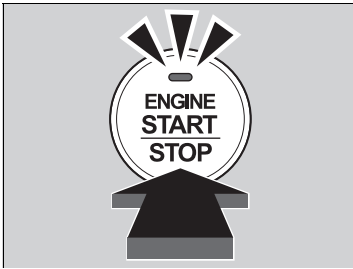
**All models**

3. Press the **ENGINE START/STOP** button without depressing the accelerator pedal.

Starting the Engine

Bring the keyless access remote close to the **ENGINE START/STOP** button if the battery in the keyless access remote is weak.

[▶ If the Keyless Access Remote Battery is Weak P. 312](#)

The engine may not start if the keyless access remote is subjected to strong radio waves.

Do not hold the **ENGINE START/STOP** button to start the engine.

If the engine does not start, wait at least 10 seconds before trying again.

■ Stopping the Engine

You can turn the engine off when the vehicle is completely stopped.

Automatic transmission models

1. Shift to **P**.
2. Press the **ENGINE START/STOP** button.

Manual transmission models

- If the shift lever is in **N**, press the **ENGINE START/STOP** button.
- If the shift lever is in any gear other than **N**, depress the clutch pedal, then press the **ENGINE START/STOP** button.

■ Starting to Drive

Automatic transmission models

1. Keeping your right foot on the brake pedal, release the parking brake. Check that the parking brake indicator has gone off.
[▶ Parking Brake P. 237](#)
2. Put the shift lever in **D**. Select **R** when reversing.
3. Gradually release the brake pedal and gently depress the accelerator pedal to pull away.

■ Hill Start Assist System

Hill start assist keeps the brake engaged briefly to help prevent the vehicle from rolling on inclines as you move your foot from the brake pedal to the accelerator.

Manual transmission models

Depress the clutch pedal, and shift to **1** when facing uphill, or **R** when facing downhill, then release the brake pedal.

Automatic transmission models

Move the shift lever to **D** or **S** when facing uphill, or **R** when facing downhill, then release the brake pedal.

Starting the Engine

Hill start assist may not prevent the vehicle from rolling downhill on a very steep or slippery slope, and does not operate on small inclines.

Hill start assist is not a replacement for the parking brake.

Precautions While Driving

In Rain

Avoid driving in deep water and on flooded roads. This can damage the engine, driveline, or cause electrical component failure.

Other Precautions

If there is a strong impact with something under the vehicle, stop in a safe location. Check the underside of the vehicle for damage or any fluid leaks.

Precautions While Driving

NOTICE

Do not operate the shift lever while pressing the accelerator pedal. You could damage the transmission.

NOTICE

If you repeatedly turn the steering wheel at an extremely low speed, or hold the steering wheel on the full left or right position for a while, the electric power steering (EPS) system heats up. The system goes into a protective mode, and limits its performance. The steering wheel becomes harder and harder to operate. Once the system cools down, the EPS system is restored.

Repeated operation under these conditions can eventually damage the system.

If the power mode is set to ACCESSORY while driving, the engine will shut down and all steering and brake power assist functions will stop, making it difficult to control the vehicle.

Do not put the shift lever in **[N]**, as you will lose engine braking (and acceleration) performance.

During the first 600 miles (1,000 km) of operation, avoid sudden acceleration or full throttle operation so as to not damage the engine or powertrain.

Avoid hard braking for the first 200 miles (300 km). You should also follow this when the brake pads are replaced.

Automatic Transmission

Creeping

The following conditions cause the engine to run at high revolutions, and increase creeping:

- Immediately after the engine starts.
- When the climate control system is in use.

Keep the brake pedal firmly depressed when stopped.

Kickdown

Quickly depressing the accelerator pedal while driving uphill may cause the transmission to drop to a lower gear, unexpectedly increasing vehicle speed. Depress the accelerator pedal carefully, especially on slippery roads and curves.

Precautions While Driving

NOTICE

The following can damage the under spoiler:

- Parking the vehicle by a parking block
- Parallel parking along the road shoulder
- Driving towards the bottom of a hill
- Driving up or down to a different surface level (such as a road shoulder)
- Driving on a rutted or bumpy road
- Driving on a road with potholes.

Automatic transmission models

Shifting

Change the shift position in accordance with your driving needs.

■ Shift lever positions

The diagram shows a 3D rendering of the shift lever. A red arrow points to the top of the lever, labeled "Release Button". Below the lever, the letters P, R, N, D, and S are arranged in a semi-circle, corresponding to the gear positions. To the right of the lever, five entries describe each gear position:

- P Park**
Used when parking or starting the engine
- R Reverse**
Used when reversing
- N Neutral**
Used when idling
- D Drive**
Used for:
 - Normal driving (gears change between 1st and 5th automatically)
 - Temporarily driving in the sequential mode
- S Drive (S)**
Used for:
 - Automatically changing gears between 1st and 4th (4th gear is used only at high speed)
 - Driving in the sequential mode

☞ Shifting

You cannot change the power mode from ON to VEHICLE OFF (LOCK) unless the shift lever is in **P**.

The vehicle may move forward very slightly even in **N** while the engine is cold. Depress the brake pedal firmly and, when necessary, apply the parking brake.

When shifting gears in extremely low temperatures (-22°F/-30°C), there may be a short delay before the shift is indicated in the display. Always confirm you are in the correct gear before driving.

Shift Lever Operation

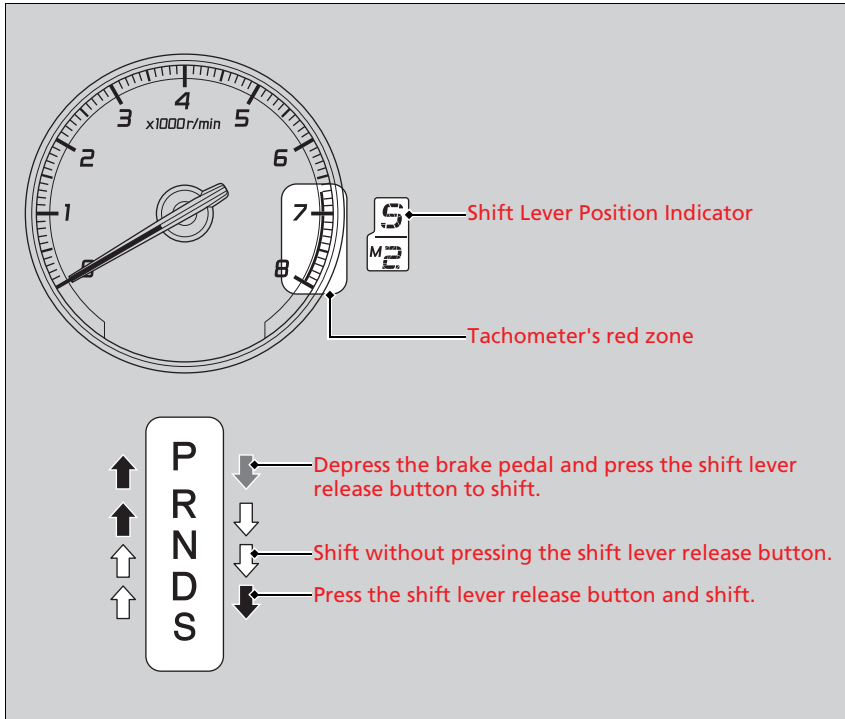

Shift Lever Operation

NOTICE

When you change the shift lever from **[D]** to **[R]** and vice versa, come to a complete stop and keep the brake pedal depressed.

Operating the shift lever before the vehicle has come to a complete standstill can damage the transmission.

Use the shift lever position indicator to check the lever position before pulling away.

Whichever position the shift lever is in when driving, a blinking **[D]** indicator indicates a transmission problem.

Avoid sudden acceleration and have the transmission checked by a dealer as soon as possible.

The fuel supply may be cut off if you drive at engine speeds in or over the tachometer's red zone (engine speed limit). If this happens, you may experience a slight jolt.

It may not be possible to operate the shift lever if the brake pedal is applied while the shift lever release button is held down.

Depress the brake pedal first.

■ Sequential Shift Mode

Use the paddle shifters to change between 1st and 5th gears without removing your hands from the steering wheel. The transmission will switch to the sequential shift mode.

■ When the shift lever is in **[D]**:

The vehicle will go into the sequential shift mode momentarily, and the gear position indicator will come on.

Once you start traveling at a constant speed, the sequential shift mode will automatically switch off, and the gear position indicator will go off.

Hold the **[+]** paddle shifter for two seconds to return to normal drive.

■ When the shift lever is in **[S]**:

The vehicle will go into the sequential shift mode, and the **M** (sequential shift) indicator and gear position indicator will come on. At speeds of 6 mph (10 km/h) or less, the vehicle automatically shifts down into 1st gear. It will not automatically shift up, even if vehicle speed increases.

You can only pull away in 1st or 2nd gear.

When switching out of the sequential shift mode, move the shift lever from **[S]** to **[D]**. When the sequential shift mode is canceled, the sequential shift mode indicator and shift indicator go off.

■ Second gear lock mode

If you pull the **+** paddle shifter while stopped or driving at 6 mph (10 km/h) or less, the gear position will be locked in 2nd gear. This makes it easier to pull away on slippery surfaces such as snow covered roads.

To cancel the 2nd gear lock mode, pull the **-** paddle shifter, or move the shift lever from **[S]** to **[D]**.

■ Sequential Shift Mode Operation

▣ Sequential Shift Mode Operation

Each paddle shift operation makes a single gear change.

To change gears continuously, release the paddle shifter before pulling it again for the next gear.

Recommended Shift Points

Use this table as a guideline for efficient fuel economy and effective emission control.

Shift Up	Normal Acceleration
1st to 2nd	15 mph (24 km/h)
2nd to 3rd	25 mph (40 km/h)
3rd to 4th	40 mph (64 km/h)
4th to 5th	47 mph (75 km/h)

If the gear position indicator blinks when you try to shift up or down, this means your vehicle speed is not in its allowable gear range.

Slightly accelerate to shift up and decelerate to shift down while the indicator is blinking.

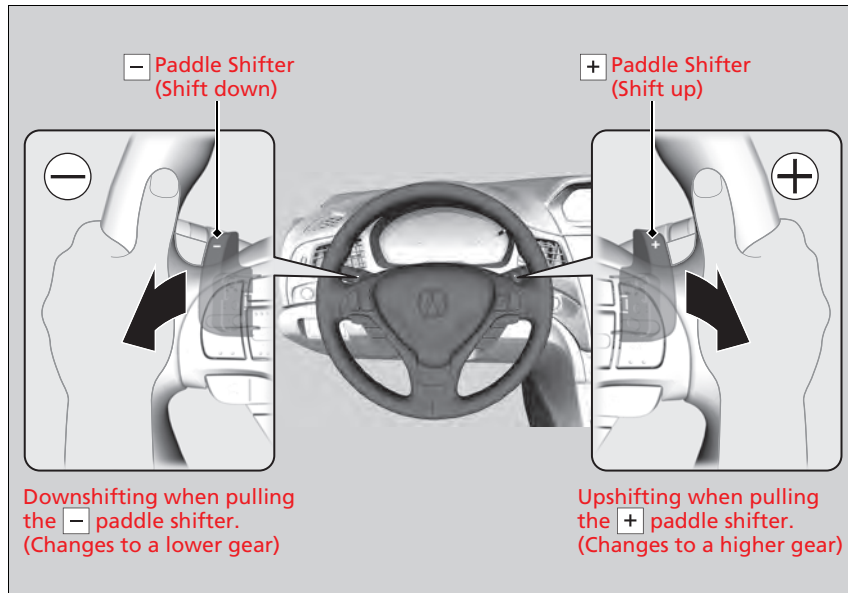

Manual transmission models

Shifting

■ Shift Lever Operation

Fully depress the clutch pedal to operate the shift lever and change gears, then slowly release the pedal.

Depress the clutch pedal, and pause for a few seconds before shifting into **R**, or shift into one of the forward gears for a moment. This stops the gears so they do not “grind.”

» Shifting

NOTICE

Do not shift to **R** before the vehicle comes to a complete stop.

Shifting to **R** before stopping can damage the transmission.

NOTICE

Before downshifting, make sure the engine will not go into the tachometer's red zone. Should this occur, it can severely damage your engine.

There is a metallic part on the shift lever. If you leave the vehicle parked outside for a long time on a hot day, be careful before moving the shift lever. Because of heat, the shift lever may be extremely hot. If the outside temperature is low, the shift lever may feel cold.

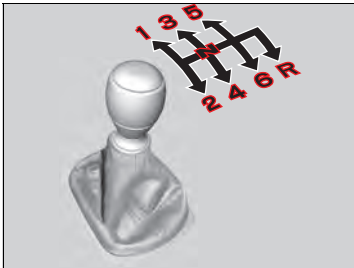

When you are not shifting, do not rest your foot on the clutch pedal. This can cause your clutch to wear out faster.

Shifting

Recommended Shift Points

Driving in the highest gear that allows the engine to run and accelerate smoothly helps to optimize fuel economy and effective emissions control. The following shift points are recommended:

Shift Up	Normal Acceleration
1st to 2nd	17 mph (27 km/h)
2nd to 3rd	29 mph (46 km/h)
3rd to 4th	37 mph (59 km/h)
4th to 5th	43 mph (69 km/h)
5th to 6th	49 mph (79 km/h)

If you exceed the maximum speed for the gear you are in, the engine speed will enter into the tachometer's red zone. When this happens, you may experience a slight jolt.

Reverse Lockout

The manual transmission has a lockout mechanism that stops you from accidentally shifting into **R** from a forward gear while the vehicle is moving above a certain speed.

If you cannot shift to **R** when the vehicle is stopped, do the following:

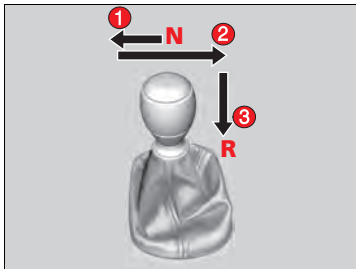

1. Depress the clutch pedal, move the shift lever all the way to the left, and shift to **R**.
2. If you still cannot shift into **R**, apply the parking brake, and set the power mode to ACCESSORY or VEHICLE OFF (LOCK).
3. Depress the clutch pedal and shift into **R**.
4. Keep depressing the clutch pedal and start the engine.

Have the vehicle checked by a dealer if you have to go through this procedure repeatedly.

Cruise Control

Maintains a constant vehicle speed without having to keep your foot on the accelerator. Use cruise control on freeways or open roads where you can travel at a constant speed with little acceleration or deceleration.

When to use

- Vehicle speed for cruise control:
Desired speed in a range above roughly 25 mph (40 km/h) ~

Automatic transmission models

- Shift positions for cruise control:
In **D** or **S**

Always keep sufficient distance between you and the vehicle in front of you.



How to use

- Press the **CRUISE** button on the steering wheel.

CRUISE MAIN

CRUISE MAIN is on in the instrument panel.
Cruise control is ready to use.

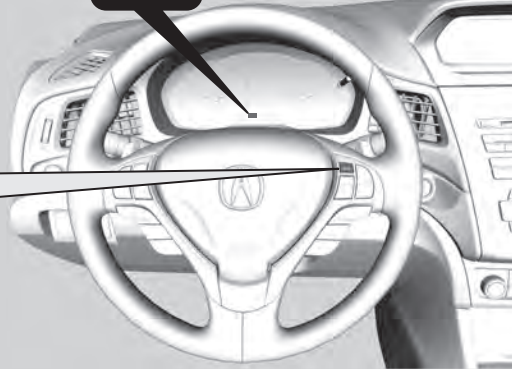
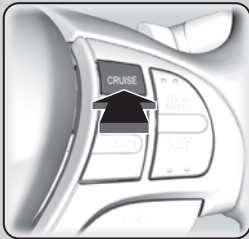

⊗ Cruise Control

⚠ WARNING

Improper use of the cruise control can lead to a crash.

Use the cruise control only when traveling on open highways in good weather.

It may not be possible to maintain a constant speed when driving uphill or downhill.

When not using cruise control:

Turn off cruise control by pressing the **CRUISE** button.

Manual transmission models

When the engine speed slows down, try to downshift.

You can maintain the set speed if you change gear within five seconds.

■ To Set the Vehicle Speed

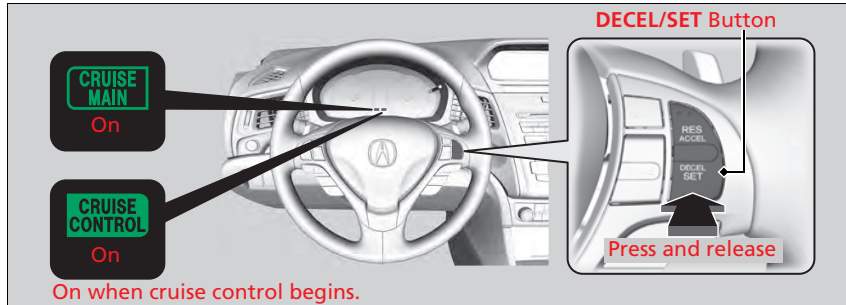

Take your foot off the pedal and press the **DECEL/SET** button when you reach the desired speed.

The moment you release the **DECEL/SET** button, the set speed is fixed, and cruise control begins. The **CRUISE CONTROL** indicator comes on.

To Adjust the Vehicle Speed

Increase or decrease the vehicle speed using the **RES/ACCEL** or **DECEL/SET** buttons on the steering wheel.

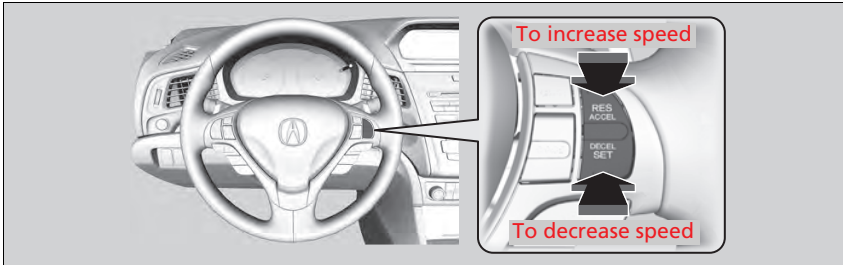

- Each time you press the button, the vehicle speed is increased or decreased by about 1 mph (1.6 km/h).
- If you keep the button pressed, the vehicle speed increased or decreased by about 10 mph (16 km/h).

To Cancel

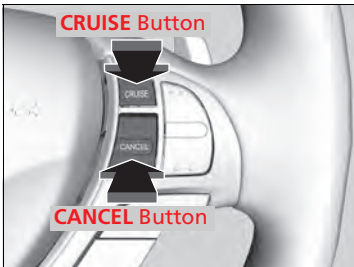

To cancel cruise control, do any of the following:

- Press the **CANCEL** button.
- Press the **CRUISE** button.
- Depress the brake pedal.
- Depress the clutch pedal for five seconds or more.

The **CRUISE CONTROL** indicator goes off.

▶▶ To Adjust the Vehicle Speed

You can set the vehicle speed using the **DECEL/SET** button on the steering wheel when adjusting the speed with the accelerator and brake pedals.

▶▶ To Cancel

Resuming the prior set speed:

After cruise control has been canceled, you can still resume the prior set speed by pressing the **RES/ACCEL** button while driving at a speed of at least 25 mph (40 km/h) or more.

You cannot set or resume in the following situations:

- When vehicle speed is less than 25 mph (40 km/h)
- When the **CRUISE** button is turned off

At vehicle speeds of 22 mph (35 km/h) or less, cruise control is canceled automatically.

VSA® (Vehicle Stability Assist), aka ESC (Electronic Stability Control), System

VSA® helps to stabilize the vehicle during cornering if the vehicle turns more or less than what was intended. It also assists in maintaining traction on slippery surfaces. It does so by regulating engine output and selectively applying the brakes.

⌘ VSA® (Vehicle Stability Assist), aka ESC (Electronic Stability Control), System

The VSA® may not function properly if tire type and size are mixed. Make sure to use the same size and type of tire, and the air pressures as specified.

When the VSA® indicator comes on and stays on while driving, there may be a problem with the system. While this may not interfere with normal driving, have your vehicle checked by a dealer immediately.

VSA® cannot enhance stability in all driving situations and does not control the entire braking system. You still need to drive and corner at speeds appropriate for the conditions and always leave a sufficient margin of safety.

The main function of the VSA® system is generally known as Electronic Stability Control (ESC). The system also includes a traction control function.

■ VSA® Operation



When VSA® activates, you may notice that the engine does not respond to the accelerator. You may also notice some noise from the hydraulic system. You will also see the indicator blink.

VSA® On and Off

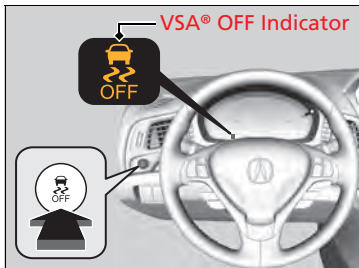

This button is on the driver side control panel. To turn the VSA® system on and off, press and hold it until you hear a beep.

VSA® will stop and the indicator will come on.

To turn it on again, press the  (VSA® OFF) button until you hear a beep.

VSA® is turned on every time you start the engine, even if you turned it off the last time you drove the vehicle.

VSA® (Vehicle Stability Assist), aka ESC (Electronic Stability Control), System

Without VSA®, your vehicle will have normal braking and cornering ability, but it will not have VSA® traction and stability enhancement.

In certain unusual conditions when your vehicle gets stuck in shallow mud or fresh snow, it may be easier to free it with the VSA® temporarily switched off.

When the VSA® system is off, the traction control system is also off. You should only attempt to free your vehicle with the VSA® off if you are not able to free it when the VSA® is on.

Immediately after freeing your vehicle, be sure to switch VSA® on again. We do not recommend driving your vehicle with the VSA® and traction control systems switched off.

If the low tire pressure/TPMS indicator comes on or blinks, the VSA® system comes on automatically. In this case, you cannot turn the system off by pressing the  button.

You may hear a motor sound coming from the engine compartment while system checks are being performed immediately after starting the engine or while driving. This is normal.

QRG

U.S. models only

TPMS (Tire Pressure Monitoring System)

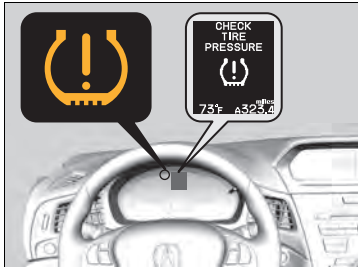

Monitors the tire pressure while you are driving. If your vehicle's tire pressure becomes significantly low, the low tire pressure/TPMS indicator comes on and a message appears on the multi-information display.

CHECK TIRE PRESSURE is displayed when a tire has significantly low pressure.

▶▶ TPMS (Tire Pressure Monitoring System)

Conditions such as low ambient temperature and altitude change directly affect tire pressure and can trigger the low tire pressure/TPMS indicator to come on.

[▶ If the Low Tire Pressure/TPMS Indicator Comes On or Blinks P. 323](#)

Tire pressure checked and inflated in:

- Warm weather can become under-inflated in colder weather.
- Cold weather can become over-inflated in warmer weather.

The low tire pressure/TPMS indicator will not come on as a result of over inflation.

TOC

Driving

Index

Home

U.S. models

Tire Pressure Monitoring System (TPMS) - Required Federal Explanation

Each tire, including the spare (if provided), should be checked monthly when cold and inflated to the inflation pressure recommended by the vehicle manufacturer on the vehicle placard or tire inflation pressure label.

(If your vehicle has tires of a different size than the size indicated on the vehicle placard or tire inflation pressure label, you should determine the proper tire inflation pressure for those tires.)

As an added safety feature, your vehicle has been equipped with a tire pressure monitoring system (TPMS) that illuminates a low tire pressure telltale when one or more of your tires is significantly under-inflated.



Accordingly, when the low tire pressure telltale illuminates, you should stop and check your tires as soon as possible, and inflate them to the proper pressure.

Driving on a significantly under-inflated tire causes the tire to overheat and can lead to tire failure. Under-inflation also reduces fuel efficiency and tire tread life, and may affect the vehicle's handling and stopping ability.

QRG

Please note that the TPMS is not a substitute for proper tire maintenance, and it is the driver's responsibility to maintain correct tire pressure, even if under-inflation has not reached the level to trigger illumination of the TPMS low tire pressure telltale.

Your vehicle has also been equipped with a TPMS malfunction indicator to indicate when the system is not operating properly. The TPMS malfunction indicator is combined with the low tire pressure telltale. When the system detects a malfunction, the telltale will flash for approximately one minute and then remain continuously illuminated. This sequence will continue upon subsequent vehicle start-ups as long as the malfunction exists.

When the malfunction indicator is illuminated, the system may not be able to detect or signal low tire pressure as intended.

TOC

Driving

TPMS malfunctions may occur for a variety of reasons, including the installation of replacement or alternate tires or wheels on the vehicle that prevent the TPMS from functioning properly.

Always check the TPMS malfunction telltale after replacing one or more tires or wheels on your vehicle to ensure that the replacement or alternate tires and wheels allow the TPMS to continue to function properly.

Index



Brake System

■ Parking Brake

Use the parking brake to keep the vehicle stationary when parking.

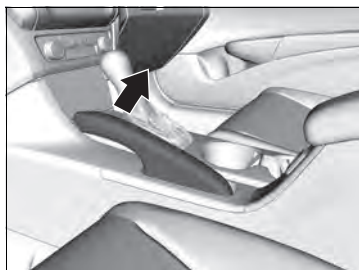

To apply:

Pull the lever fully up without pressing the release button.

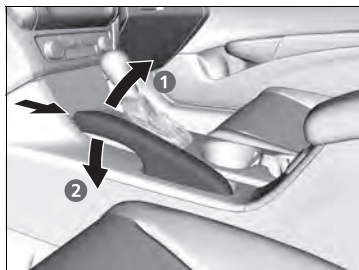

To release:

1. Pull the lever slightly, and press and hold the release button.
2. Lower the lever down all the way, then release the button.

▣ Parking Brake

NOTICE

Release the parking brake fully before driving. The rear brakes and axle can be damaged if you drive with the parking brake applied.

If you start driving without fully releasing the parking brake, a buzzer sounds as a warning, and **RELEASE PARKING BRAKE** appears on the multi-information display.

Always apply the parking brake when parking.

■ Foot Brake

Your vehicle is equipped with disc brakes at all four wheels. A vacuum power assist helps reduce the effort needed on the brake pedal. The brake assist system increases the stopping force when you depress the brake pedal hard in an emergency situation. The anti-lock brake system (ABS) helps you retain steering control when braking very hard.

➤ [Brake Assist System](#) P. 240

➤ [ABS \(Anti-lock Brake System\)](#) P. 239

☞ Foot Brake

Check the brakes after driving through deep water, or if there is a buildup of road surface water. If necessary, dry the brakes by lightly depressing the pedal several times.

If you hear a continuous metallic friction sound when applying the brakes, the brake pads need to be replaced. Have the vehicle checked by a dealer.

Constantly using the brake pedal while going down a long hill builds up heat, which reduces the brake effectiveness. Apply engine braking by taking your foot off the accelerator pedal and downshifting to a lower gear. With manual transmission use a lower gear for greater engine braking.

Do not rest your foot on the brake pedal while driving, as it will lightly apply the brakes and cause them to lose effectiveness over time and reduce pad life. It will also confuse drivers behind you.

ABS (Anti-lock Brake System)

■ ABS

Helps prevent the wheels from locking up, and helps you retain steering control by pumping the brakes rapidly, much faster than you.

The electronic brake distribution (EBD) system, which is part of the ABS, also balances the front-to-rear braking distribution according to vehicle loading.

You should never pump the brake pedal. Let the ABS work for you by always keeping firm, steady pressure on the brake pedal. This is sometimes referred to as “stomp and steer.”

■ ABS operation

The brake pedal may pulsate slightly when the ABS is working. Keep holding the pedal firmly down. On dry pavement, you will need to press on the brake pedal very hard before the ABS activates. However, you may feel the ABS activate immediately if you are trying to stop on snow or ice.

When the vehicle speed goes under 6 mph (10 km/h), the ABS stops.

ⓘ ABS (Anti-lock Brake System)

NOTICE

The ABS may not function correctly if you use an incorrect tire type and size.

When the **ABS** indicator comes on while driving, there may be a problem with the system. While normal braking is not affected, there is a possibility of the ABS not operating. Have the vehicle checked by a dealer immediately.

The ABS does not reduce the time or distance it takes to stop the vehicle. It only helps with steering control during hard braking.

In the following cases, your vehicle may need more stopping distance than a vehicle without the ABS:

- When driving on rough road surfaces, including when driving on uneven surfaces, such as gravel or snow.
- When tire chains are installed.

You may hear a motor sound coming from the engine compartment while system checks are being performed immediately after starting the engine or while driving. This is normal.

Brake Assist System

■ Brake Assist System

Designed to assist the driver by generating greater braking force when you depress the brake pedal hard during emergency braking.

■ Brake assist system operation

Press the brake pedal firmly for more powerful braking.

When brake assist operates, the pedal may wiggle slightly and an operating noise may be heard. This is normal. Keep holding the brake pedal firmly down.

When Stopped

1. Depress the brake pedal firmly.
2. Firmly apply the parking brake.

Automatic transmission models

3. Move the shift lever from **D** to **P**.

Manual transmission models

3. Move the shift lever to **R**.
4. Turn off the engine.

Always set the parking brake firmly, in particular if you are parked on an incline.

▣ Parking Your Vehicle

Do not park your vehicle near flammable objects, such as dry grass, oil, or timber. Heat from the exhaust can cause a fire.

▣ When Stopped

Automatic transmission models

NOTICE

The following can damage the transmission:

- Depressing the accelerator and brake pedals simultaneously.
- Holding the vehicle in place when facing uphill by depressing the accelerator pedal.
- Moving the shift lever into **P** before the vehicle stops completely.

Raise the wiper arms when snow is expected.

About Your Multi-View Rear Camera

Models with navigation system

For models with the navigation system, see Navigation System Manual.

Models without navigation system

The audio/information screen can display your vehicle's rear view. The display automatically changes to the rear view when the shift lever is moved to **R**.

Multi-View Rear Camera Display Area

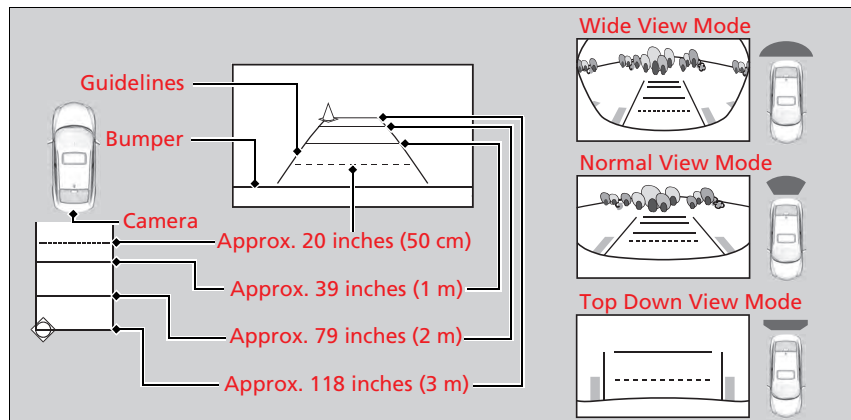

You can view three different camera angles on the rearview display. Press the selector knob to switch the angle.

If the last used viewing mode is Wide or Normal, the same mode is selected the next time you shift into **R**. If Top View was last used, Wide mode is selected.

About Your Multi-View Rear Camera

The rear camera view is restricted. You cannot see the corner ends of the bumper or what is underneath the bumper. Its unique lens also makes objects appear closer or farther than they actually are.

Visually confirm that it is safe to drive before backing up. Certain conditions (such as weather, lighting, and high temperatures) may also restrict the rear view. Do not rely on the rearview display which does not give you all information about conditions at the back of your vehicle.

If the camera lens is covered with dirt or moisture, use a soft, moist cloth to keep the lens clean and free of debris.

Fuel Information

Fuel recommendation

Unleaded premium gasoline, pump octane number 91 or higher

Use of lower octane gasoline can cause occasional metallic knocking noise in the engine and will result in decreased engine performance.

Use of gasoline with a pump octane less than 87 can lead to engine damage.

Top tier detergent gasoline

Because the level of detergency and additives in gasoline vary in the market, Acura endorses the use of "TOP TIER Detergent Gasoline" where available to help maintain the performance and reliability of your vehicle. TOP TIER Detergent Gasoline meets a new gasoline standard jointly established by leading automotive manufacturers to meet the needs of today's advanced engines.

Qualifying gasoline retailers will, in most cases, identify their gasoline as having met "TOP TIER Detergent Gasoline" standards at the retail location. This fuel is guaranteed to contain the proper level of detergent additives and be free of metallic additives. The proper level of detergent additives, and absence of harmful metallic additives in gasoline, help avoid build-up of deposits in your engine and emission control system.

For further important fuel-related information for your vehicle, or on information on gasoline that does not contain MMT, visit Acura Owners at owners.acura.com. In Canada, visit www.acura.ca for additional information on gasoline. For more information on top tier gasoline, visit www.toptiergas.com.

Fuel tank capacity: 13.2 US gal (50 liters)

Fuel Information

NOTICE

We recommend quality gasoline containing detergent additives that help prevent fuel system and engine deposits. In addition, in order to maintain good performance, fuel economy, and emissions control, we strongly recommend the use of gasoline that does NOT contain harmful manganese-based fuel additives such as MMT, if such gasoline is available.

Use of gasoline with these additives may adversely affect performance, and cause the malfunction indicator lamp on your instrument panel to come on. If this happens, contact a dealer for service. Some gasoline today is blended with oxygenates such as ethanol. Your vehicle is designed to operate on oxygenated gasoline containing up to 15% ethanol by volume. Do not use gasoline containing methanol. If you notice any undesirable operating symptoms, try another service station or switch to another brand of gasoline.

How to Refuel

QRG

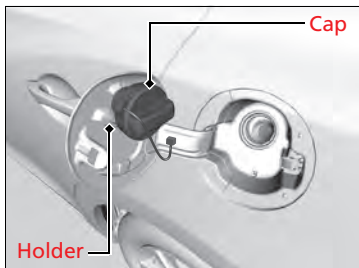
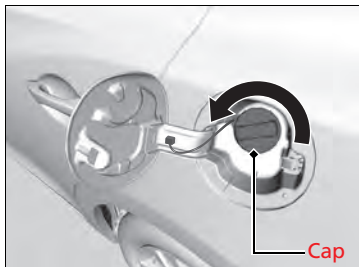
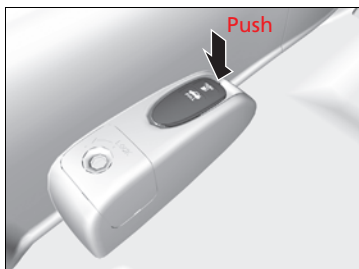

1. Stop your vehicle with the service station pump on the left side of the vehicle in the rear.
2. Turn off the engine.
3. Push on the fuel fill door release handle at the foot of the driver's seat.
 - ▶ The fuel fill door opens.
4. Remove the fuel fill cap slowly. If you hear a release of air, wait until this stops, then turn the knob slowly to open the fuel fill cap.
5. Place the fuel fill cap in the holder.
6. Insert the filler nozzle fully.
 - ▶ When the tank is full, the fuel nozzle will click off automatically. This leaves space in the fuel tank in case the fuel expands with a change in the temperature.
7. After filling, replace the fuel fill cap, tightening it until you hear it click at least once.
 - ▶ Shut the fuel fill door by hand.

How to Refuel

⚠ WARNING

Gasoline is highly flammable and explosive. You can be burned or seriously injured when handling fuel.

- Stop the engine, and keep heat, sparks, and flame away.
- Handle fuel only outdoors.
- Wipe up spills immediately.

The filler nozzle automatically stops to leave space in the fuel tank so that fuel does not overflow as a result of changes in air temperature.

If the fuel nozzle keeps turning off when the tank is not full, there may be a problem with the pump's fuel vapor recovery system. Try filling at another pump. If this does not fix the problem, consult a dealer.

Do not continue to add fuel after the nozzle has automatically stopped. Additional fuel can exceed the full tank capacity.

TOC

Driving

Index

Home

Improving Fuel Economy

Fuel economy depends on several conditions, including driving conditions, your driving habits, the condition of your vehicle, and loading. Depending on these and other conditions, you may or may not achieve the rated fuel economy of this vehicle.

Maintenance and Fuel Economy

You can optimize your fuel economy with proper maintenance of your vehicle. Always maintain your vehicle in accordance with the messages displayed on the multi-information display.

- Use the recommended viscosity engine oil, displaying the API Certification Seal.
- Maintain the specified tire pressure.
- Do not load the vehicle with excess cargo.
- Keep your vehicle clean. A buildup of snow or mud on your vehicle's underside adds weight and increases wind resistance.

Improving Fuel Economy

Direct calculation is the recommended method to determine actual fuel consumed while driving.

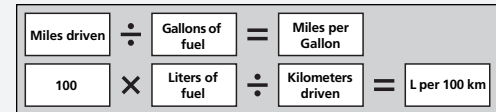

In Canada, posted fuel economy numbers are established following a simulated test. For more information on how this test is performed, please visit <http://oee.nrcan.gc.ca/>

Accessories

When installing accessories, check the following:

- Do not install accessories on the windshield. They can obstruct your view and delay your reaction to driving conditions.
- Do not install accessories on the side pillars or across the side windows. Accessories installed in these areas may interfere with proper operation of the side curtain airbags.
- Be sure electronic accessories do not overload electrical circuits or interfere with proper operation of your vehicle.
[Fuses P. 324](#)
- Before installing any electronic accessory, have the installer contact a dealer for assistance. If possible, have a dealer inspect the final installation.

Modifications

Do not modify your vehicle or use non-Acura components that can affect its handling, stability, and reliability.

Overall vehicle performance can be affected. Always make sure all equipment is properly installed and maintained, and that it meets federal, state, province, territory, and local regulations.

Accessories and Modifications

WARNING

Improper accessories or modifications can affect your vehicle's handling, stability, and performance, and cause a crash in which you can be seriously hurt or killed.

Follow all instructions in this owner's manual regarding accessories and modifications.

Acura Genuine accessories are recommended to ensure proper operation on your vehicle.

Maintenance

This chapter discusses basic maintenance.



- Before Performing Maintenance**
- Inspection and Maintenance 248
- Safety When Performing Maintenance..... 249
- Parts and Fluids Used in Maintenance Service 250
- Maintenance Minder™** 251
- Maintenance Under the Hood**
- Maintenance Items Under the Hood..... 256
- Opening the Hood 258
- Engine Compartment Cover..... 259
- Recommended Engine Oil 261
- Oil Check..... 262
- Adding Engine Oil 264

- Changing the Engine Oil and Oil Filter 265
- Engine Coolant..... 268
- Transmission Fluid..... 270
- Brake/Clutch Fluid..... 272
- Refilling Window Washer Fluid..... 273
- Replacing Light Bulbs** 274
- Checking and Maintaining Wiper Blades** 284
- Checking and Maintaining Tires**
- Checking Tires 286
- Tire and Loading Information Label..... 287
- Tire Labeling 287
- DOT Tire Quality Grading (U.S. Vehicles)..... 289

- Wear Indicators 291
- Tire Service Life 291
- Tire and Wheel Replacement 292
- Tire Rotation 293
- Winter Tires 294
- Battery** 295
- Remote Transmitter Care**
- Replacing the Button Battery 296
- Climate Control System Maintenance** 297
- Cleaning**
- Interior Care 298
- Exterior Care..... 300

Inspection and Maintenance

For your safety, perform all listed inspections and maintenance to keep your vehicle in good condition. If you become aware of any abnormality (noise, smell, insufficient brake fluid, oil residue on the ground, etc.), have your vehicle inspected by a dealer. (Note, however, that service at a dealer is not mandatory to keep your warranties in effect.) Refer to the separate maintenance booklet for detailed maintenance and inspection information.

Types of Inspection and Maintenance

Daily inspections

Perform inspections before long distance trips, when washing the vehicle, or when refueling.

Periodic inspections

- Check the automatic transmission fluid level monthly.
[Automatic Transmission Fluid P. 270](#)
- Check the brake fluid level monthly.
[Brake/Clutch Fluid P. 272](#)
- Check the tire pressure monthly. Examine the tread for wear and foreign objects.
[Checking and Maintaining Tires P. 286](#)
- Check the operation of the exterior lights monthly.
[Replacing Light Bulbs P. 274](#)
- Check the condition of the wiper blades at least every six months.
[Checking and Maintaining Wiper Blades P. 284](#)

Inspection and Maintenance

U.S. models

Maintenance, replacement, or repair of emissions control devices and systems may be done by any automotive repair establishment or individuals using parts that are "certified" to EPA standards.

According to state and federal regulations, failure to perform maintenance on the maintenance main items marked with # will not void your emissions warranties. However, all maintenance services should be performed in accordance with the intervals indicated by the multi-information display.

[Maintenance Service Items P. 254](#)

If you want to perform complex maintenance tasks that require more skills and tools, you can purchase a subscription to the Service Express website at www.techinfo.honda.com.

[Authorized Manuals P. 341](#)

If you want to perform maintenance yourself, make sure that you have the necessary tools and skills first. After performing maintenance, update the records in the separate maintenance booklet.

Safety When Performing Maintenance

Some of the most important safety precautions are given here. However, we cannot warn you of every conceivable hazard that can arise in performing maintenance. Only you can decide whether or not you should perform a given task.

Maintenance Safety

- To reduce the possibility of fire or explosion, keep cigarettes, sparks, and flames away from the battery and all fuel related parts.
- Never leave rags, towels, or other flammable objects under the hood.
 - ▶ Heat from the engine and exhaust can ignite them causing a fire.
- To clean parts, use a commercially available degreaser or parts cleaner, not gasoline.
- Wear eye protection and protective clothing when working with the battery or compressed air.
- Engine exhaust contains carbon monoxide, which is poisonous and can kill you.
 - ▶ Only operate the engine if there is sufficient ventilation.

Vehicle Safety

- The vehicle must be in a stationary condition.
 - ▶ Make sure your vehicle is parked on level ground, the parking brake is set, and the engine is off.
- Be aware that hot parts can burn you.
 - ▶ Make sure to let the engine and exhaust system cool thoroughly before touching vehicle parts.
- Be aware that moving parts can injure you.
 - ▶ Do not start the engine unless instructed, and keep your hands and limbs away from moving parts.

⚠ Safety When Performing Maintenance

⚠ WARNING

Improperly maintaining this vehicle or failing to correct a problem before driving can cause a crash in which you can be seriously hurt or killed.

Always follow the inspection and maintenance recommendations according to the schedules in this owner's manual.

⚠ WARNING

Failure to properly follow maintenance instructions and precautions can cause you to be seriously hurt or killed.

Always follow the procedures and precautions in this owner's manual.

QRG

Parts and Fluids Used in Maintenance Service

The use of Acura genuine parts and fluids is recommended when maintaining and servicing your vehicle. Acura genuine parts are manufactured according to the same high quality standards used in Acura vehicles.

TOC

Maintenance

Index

Home

QRG

If the engine oil life is less than 15%, you will see the Maintenance Minder messages appear the multi-information display every time you set the power mode to ON. The messages notify you when to change the engine oil, or when to bring your vehicle to a dealer for indicated maintenance services.

TOC

Maintenance

Index





To Use Maintenance Minder™

■ Displaying the Engine Oil Life and Maintenance Items

Maintenance items, which should be serviced at the same time that you replace the engine oil, appear on the multi-information display.

You can view them on the **engine oil life** screen at any time.

1. Set the power mode to ON.
2. Press the  /  button repeatedly until the engine oil life appears on the multi-information display.

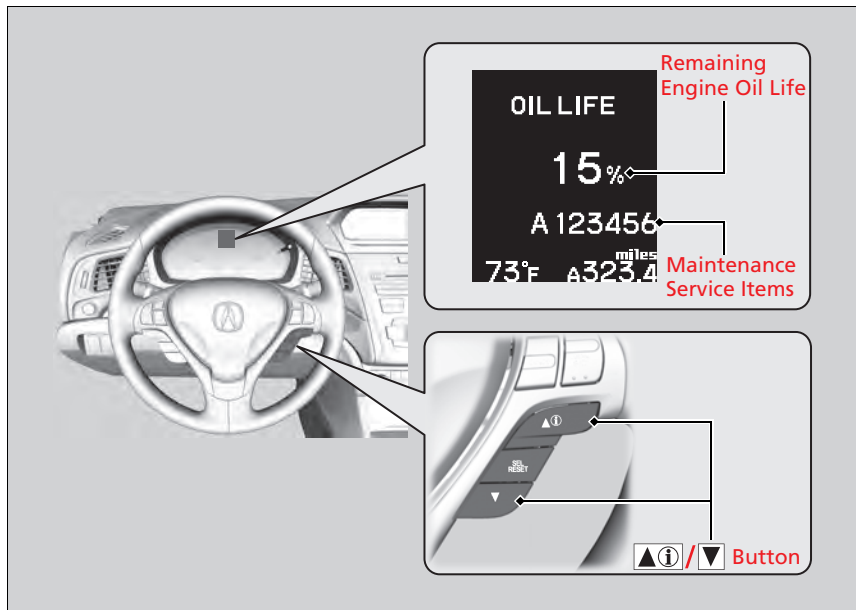

► Displaying the Engine Oil Life and Maintenance Items











Based on the engine operating conditions, the remaining engine oil life is calculated and displayed as a percentage.

Displayed Engine Oil Life (%)	Calculated Engine Oil Life (%)
100	100 to 91
90	90 to 81
80	80 to 71
70	70 to 61
60	60 to 51
50	50 to 41
40	40 to 31
30	30 to 21
20	20 to 16
15	15 to 11
10	10 to 6
5	5 to 1
0	0

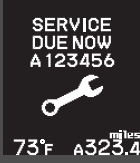
There is a list of maintenance main and sub items you can view on the multi-information display.

[▶ Maintenance Service Items P. 254](#)

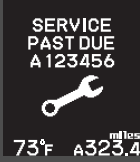
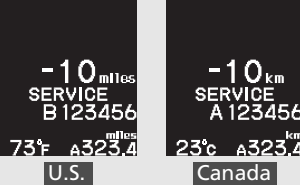
Maintenance Minder Messages on the Multi-Information Display

Maintenance Message	Oil Life Display	Explanation	Information
<p>SERVICE DUE SOON</p> 	<p>Oil Life Display: 15 %</p> 	<p>The remaining engine oil life is 15 to 6 percent. Once you switch the display by pressing the /  (information) button, this message will go off.</p>	<p>The engine oil is approaching the end of its service life, and the maintenance items should be inspected and serviced soon.</p>
<p>SERVICE DUE NOW</p> 	<p>Oil Life Display: 5 %</p> 	<p>The remaining engine oil life is 5 to 1 percent. Press the /  button to switch to another display.</p>	<p>The engine oil has almost reached the end of its service life, and the maintenance items should be inspected and serviced as soon as possible.</p>
<p>SERVICE PAST DUE</p> 	<p>Negative Distance</p> 	<p>The remaining engine oil life has passed its service life, and a negative distance appears after driving over 10 miles (U.S. models) or 10 km (Canadian models). Press the /  button to switch to another display.</p>	<p>The engine oil life has passed. The maintenance items must be inspected and serviced immediately.</p>

The system message indicator () comes on along with the Maintenance Minder message.

Maintenance Service Items

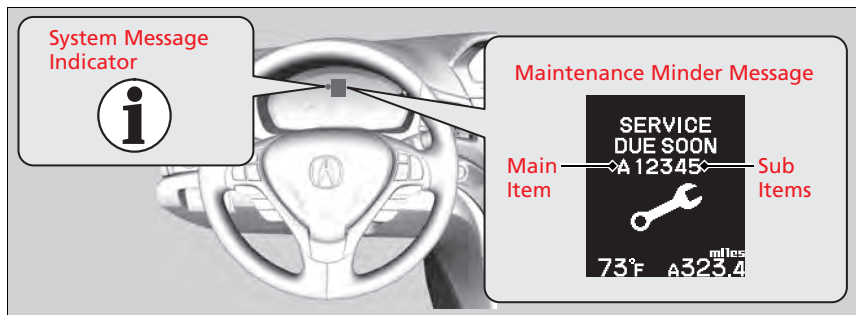

Maintenance Service Items

- Independent of the Maintenance Minder information, replace the brake fluid every 3 years.
- Inspect idle speed every 160,000 miles (256,000 km).
- Adjust the valves during services A, B, 1, 2, or 3 if they are noisy.

CODE	Maintenance Main Items
A	<ul style="list-style-type: none"> • Replace engine oil*1
B	<ul style="list-style-type: none"> • Replace engine oil*1 and oil filter • Inspect front and rear brakes/service as necessary • Check parking brake adjustment • Inspect tie rod ends, steering gearbox, and boots • Inspect suspension components • Inspect driveshaft boots • Inspect brake hoses and lines (Including ABS/VSA) • Inspect all fluid levels and condition of fluids • Inspect exhaust system# • Inspect fuel lines and connections#

CODE	Maintenance Sub Items
1	<ul style="list-style-type: none"> • Rotate tires
2	<ul style="list-style-type: none"> • Replace air cleaner element*2 • Replace dust and pollen filter*3 • Inspect drive belt
3	<ul style="list-style-type: none"> • Replace transmission fluid
4	<ul style="list-style-type: none"> • Replace spark plugs • Inspect valve clearance
5	<ul style="list-style-type: none"> • Replace engine coolant

*2: If you drive in dusty conditions, replace the air cleaner element every 15,000 miles (24,000 km).
 *3: If you drive primarily in urban areas that have high concentrations of soot in the air from industry and from diesel-powered vehicles, replace the dust and pollen filter every 15,000 miles (24,000 km).

*1: If a message **SERVICE** does not appear more than 12 months after the display is reset, change the engine oil every year.

#: See information on maintenance and emissions warranty.

Resetting the Display

Reset the engine oil life display if you have performed the maintenance service.

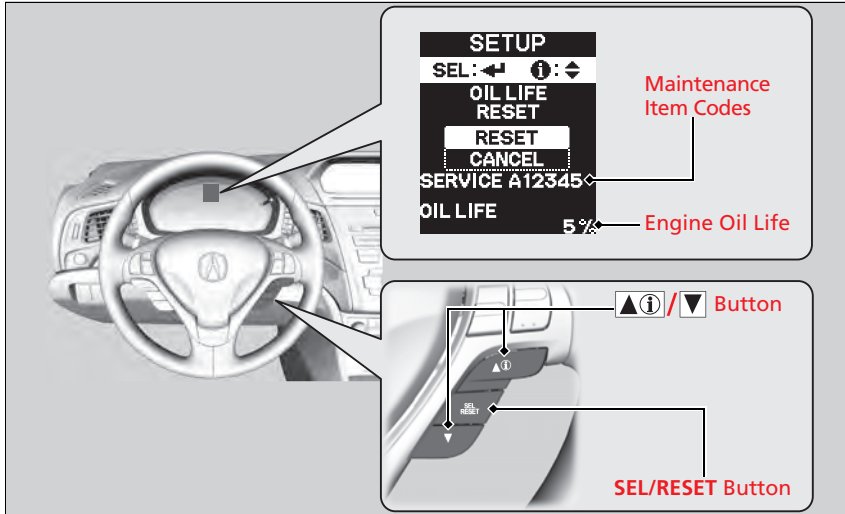

1. Set the power mode to ON.
2. Go to the **MAINTENANCE INFO.** group.
▶ [Customized Features P. 83](#)
3. Press the **SEL/RESET** button.
▶ The oil life reset mode is displayed on the multi-information display.
4. Select **RESET** with the ▲▲/▼▼ button, then press the **SEL/RESET** button.
▶ The displayed maintenance items disappear, and the engine oil life display returns to **100%**.

To cancel the oil life reset mode, select **CANCEL**, then press the **SEL/RESET** button.

Resetting the Display

NOTICE

Failure to reset the engine oil life after a maintenance service results in the system showing incorrect maintenance intervals, which can lead to serious mechanical problems.

The dealer will reset the engine oil life display after completing the required maintenance service. If someone other than a dealer performs maintenance service, reset the engine oil life display yourself.

Maintenance Items Under the Hood

2.0 l engine models

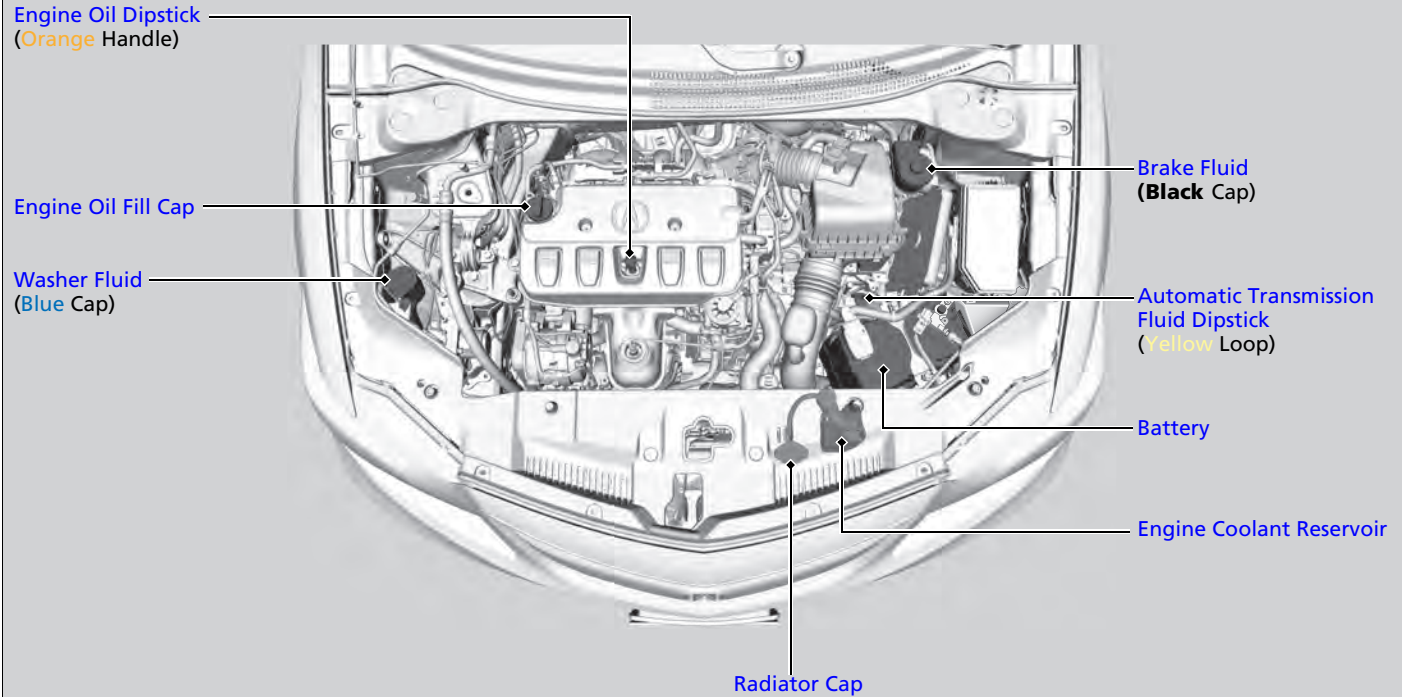

2.4 l engine models

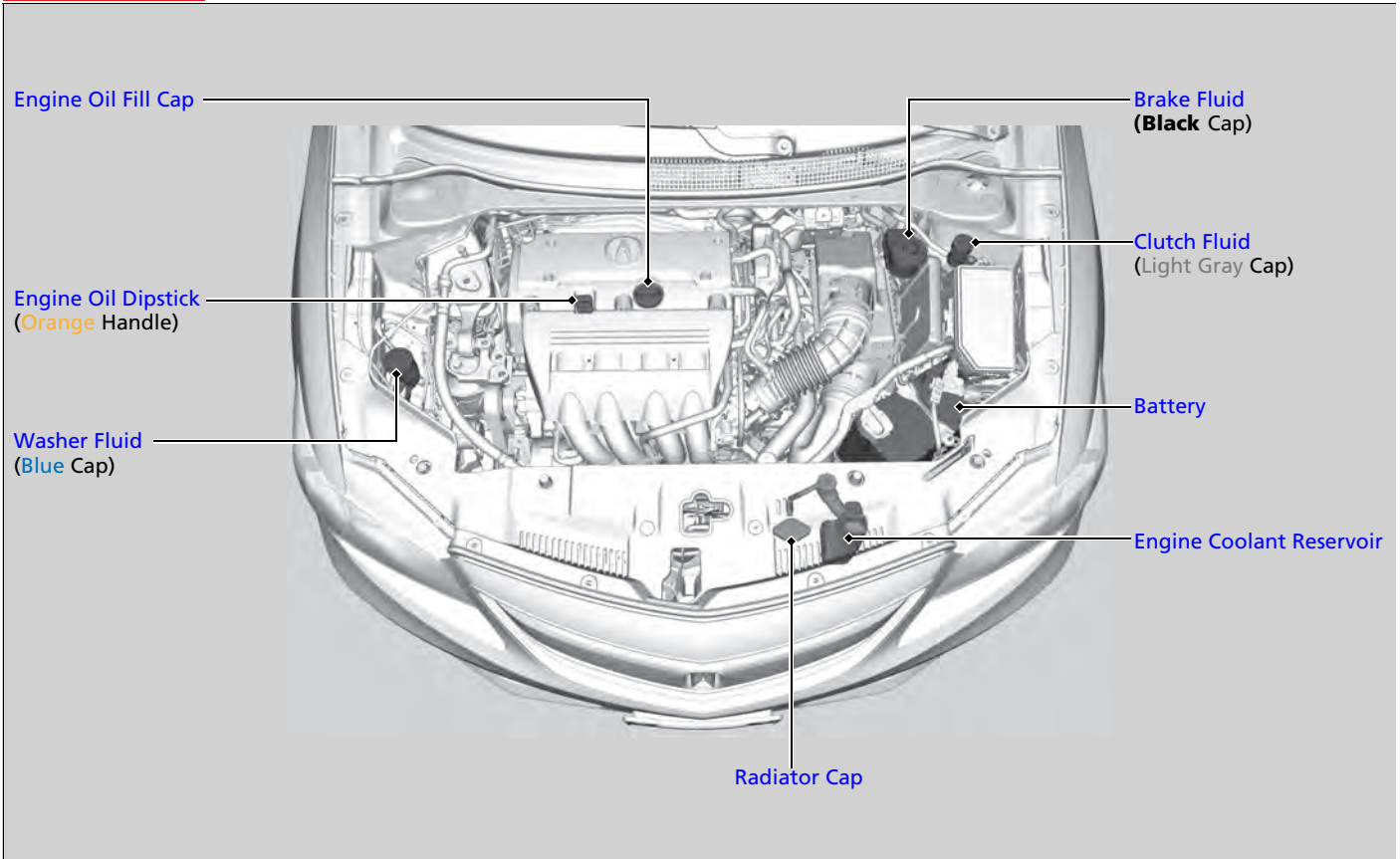

Opening the Hood

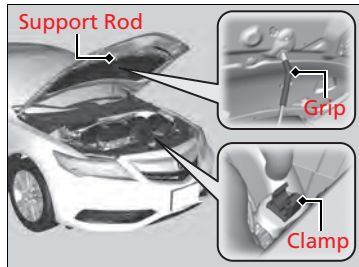
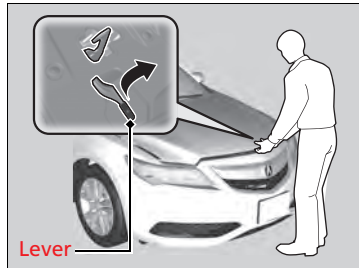

1. Park the vehicle on a level surface, and set the parking brake.
2. Pull the hood release handle under the lower left corner of the dashboard.
 - The hood will pop up slightly.
3. Slide the hood latch lever in the center of the hood to release the lock mechanism, and open the hood.

4. Remove the support rod from the clamp using the grip. Mount the support rod in the hood.

When closing, remove the support rod, and stow it in the clamp, then gently lower the hood. Remove your hand at a height of approximately 12 inches (30 cm) and let the hood close.

Opening the Hood

NOTICE

Do not open the hood when the wiper arms are raised.

The hood will strike the wipers, and may damage either the hood or the wipers.

When closing the hood, check that the hood is securely latched.

If the hood latch lever moves stiffly, or if you can open the hood without lifting the lever, the latch mechanism should be cleaned and lubricated.

Engine Compartment Cover

The component parts in the engine compartment are protected by a cover. You may need to remove the cover when you perform certain maintenance work.

To remove the cover:

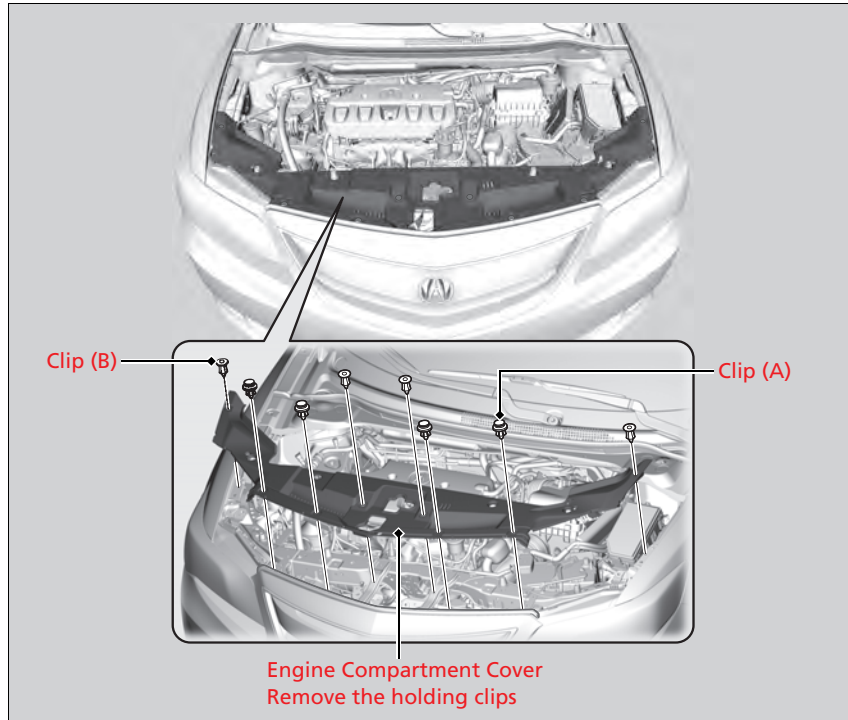

Engine Compartment Cover

Removing holding clip (A-type)

Insert a flat-tip screwdriver, lift and remove the center pin to remove the clip.

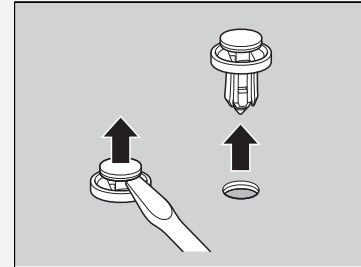

Insert the clip with the center pin raised, and push until it is flat.

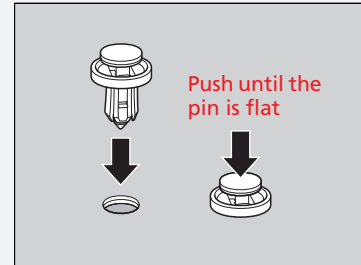

✎ Engine Compartment Cover

Holding clip (B-type)

Press down the center pin until it clicks to unlock it.

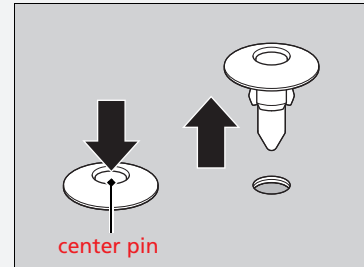

Push the center pin back to lock the clip. Then, insert the clip into the hole and press on the center pin until it is flat.

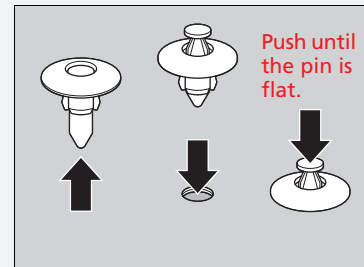

Recommended Engine Oil

- **Genuine Acura Motor Oil**
- **Premium-grade 0W-20 detergent oil with an API Certification Seal on the container.**



Oil is a major contributor to your engine's performance and longevity. If you drive the vehicle with insufficient or deteriorated oil, the engine may fail or be damaged.

This seal indicates the oil is energy conserving and that it meets the American Petroleum Institute's latest requirements.

Use a Genuine Acura Motor Oil or another commercial engine oil of suitable viscosity for the ambient temperature as shown.

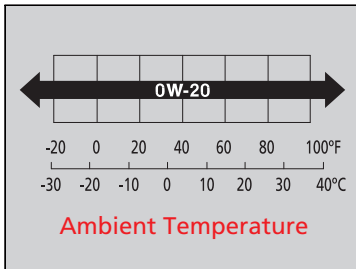

■ Synthetic oil

You may also use synthetic motor oil if it is labeled with the API Certification Seal and is the specified viscosity grade.

Recommended Engine Oil

Engine Oil Additives

Your vehicle does not require oil additives. In fact, they may adversely affect the engine performance and durability.

Oil Check

We recommend that you check the engine oil level every time you refuel. Park the vehicle on level ground.

Wait approximately three minutes after turning the engine off before you check the oil.

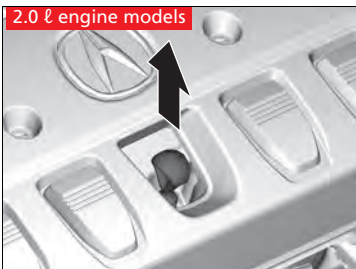

1. Remove the dipstick (orange handle).
2. Wipe the dipstick with a clean cloth or paper towel.
3. Insert the dipstick back all the way into its hole.

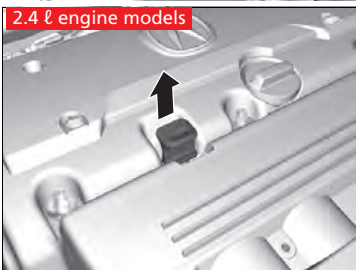

Oil Check

If the oil level is near or below the lower mark, slowly add oil being careful not to overfill.

QRG

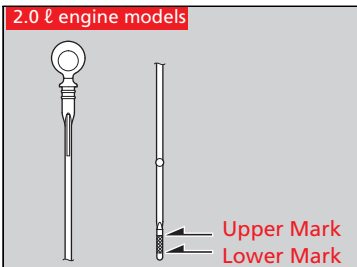

4. Remove the dipstick again, and check the level. It should be between the upper and lower marks. Add oil if necessary.

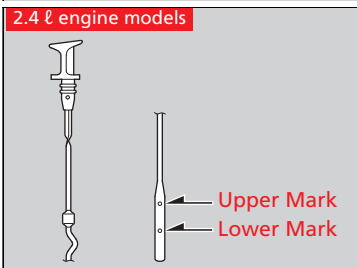

TOC

Maintenance

Index

Home

Adding Engine Oil

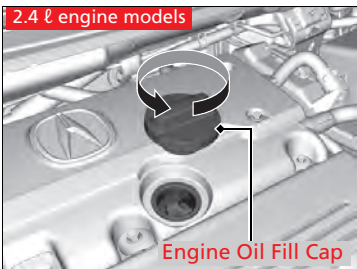
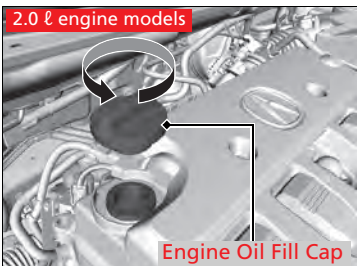

1. Unscrew and remove the engine oil fill cap.
2. Add oil slowly.
3. Reinstall the engine oil fill cap, and tighten it securely.
4. Wait for three minutes and recheck the engine oil dipstick.

Adding Engine Oil

If any oil spills, wipe it up immediately. Spilled oil may damage the engine compartment components.

NOTICE

Do not fill the engine oil above the upper mark. Overfilling the engine oil can result in leaks and engine damage.

QRG

Changing the Engine Oil and Oil Filter

You must change the engine oil and oil filter regularly in order to maintain the engine's lubrication. The engine may be damaged if they are not changed regularly.

Change the oil and filter in accordance with the maintenance message on the multi-information display.

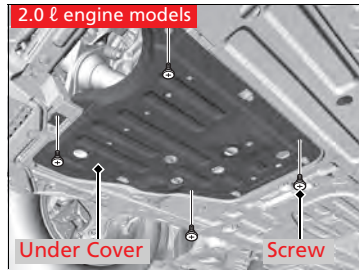

1. Run the engine until it reaches normal operating temperature, and then turn the engine off.
2. Open the hood and remove the engine oil fill cap.

2.0 l engine models

3. Remove the screws on the undercarriage and remove the under cover.

Changing the Engine Oil and Oil Filter

NOTICE

You may damage the environment if you do not dispose of the oil in a suitable way. If you are changing the oil by yourself, appropriately dispose of the used oil. Put the oil in a sealed container and take it to a recycling center. Do not throw the oil away into a garbage can or onto the ground.

TOC

Maintenance

Index

Home

Continued

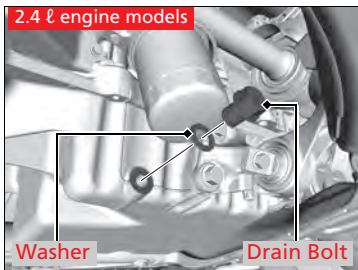
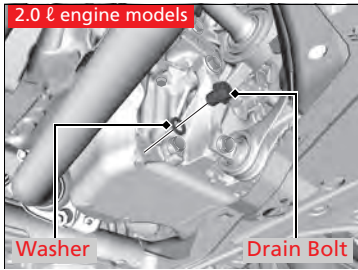

All models

4. Remove the drain bolt and washer from the bottom of the engine, and drain the oil into a suitable container.

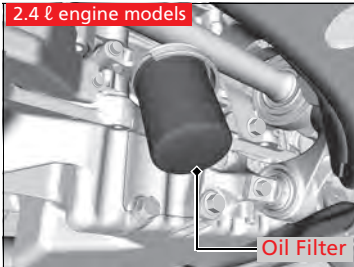
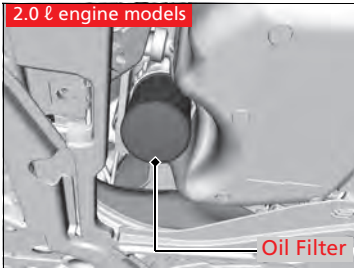

5. Remove the oil filter and dispose of the remaining oil.
6. Check that the filter gasket is not stuck to the engine contact surface.
 - If it is stuck, you must detach it.
7. Wipe away dirt and dust adhering to the contact surface of the engine block, and install a new oil filter.
 - Apply a light coat of new engine oil to the oil filter rubber seal.
8. Put a new washer on the drain bolt, then reinstall the drain bolt.
 - Tightening torque:
30 lbf·ft (40 N·m, 4.0 kgf·m)
9. Pour the recommended engine oil into the engine.
 - Engine oil change capacity (including filter):
 - 2.0 L engine models**
3.9 US qt (3.7 L)
 - 2.4 L engine models**
4.4 US qt (4.2 L)
10. Reinstall the engine oil fill cap securely and start the engine.
11. Run the engine for a few minutes, and then check that there is no leak from the drain bolt or oil filter.
12. Stop the engine, wait for three minutes, and then check the oil level on the dipstick.
 - If necessary, add more engine oil.

✕ Changing the Engine Oil and Oil Filter

You will need a special wrench to replace the oil filter. You can buy this wrench from a dealer.

When installing the new oil filter, follow the instructions supplied with the oil filter.

Reinstall the engine oil fill cap. Start the engine. The low oil pressure indicator should go off within five seconds. If it does not, turn off the engine, and check your work.

Engine Coolant

Specified coolant: Honda Long Life Antifreeze/Coolant Type 2

This coolant is premixed with 50% antifreeze and 50% water. Do not add any straight antifreeze or water.

We recommend you check the engine coolant level every time you refuel. Check the reserve tank first. If it is completely empty, also check the coolant level in the radiator. Add the engine coolant accordingly.

Reserve Tank

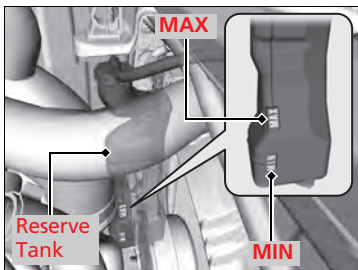

1. Check the amount of coolant in the reserve tank.

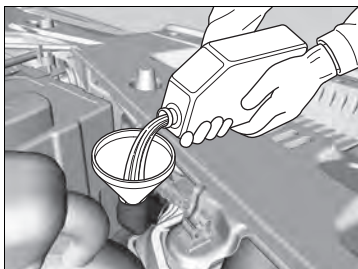

2. If the coolant level is below the **MIN** mark, add the specified coolant until it reaches the **MAX** mark.
3. Inspect the cooling system for leaks.

Engine Coolant

NOTICE

If temperatures consistently below -22°F (-30°C) are expected, the coolant mixture should be changed to a higher concentration. Consult a dealer for more information.

If Honda antifreeze/coolant is not available, you may use another major brand non-silicate coolant as a temporary replacement. Check that it is a high quality coolant recommended for aluminum engines. Continued use of any non-Honda coolant can result in corrosion, causing the cooling system to malfunction or fail. Have the cooling system flushed and refilled with Honda antifreeze/coolant as soon as possible.

Do not add rust inhibitors or other additives to your vehicle's coolant system. They may not be compatible with the coolant or with the engine components.

Radiator

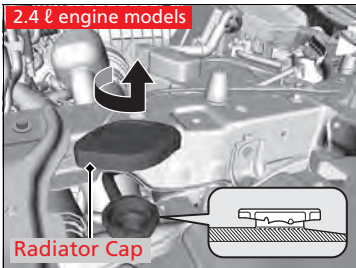
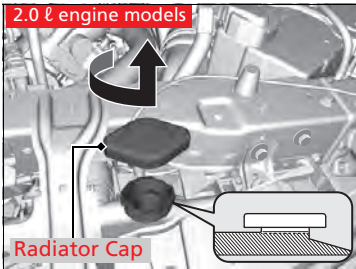

1. Make sure the engine and radiator are cool.
2. Remove the engine compartment cover.
 - [Engine Compartment Cover P. 259](#)
3. Turn the radiator cap counterclockwise and relieve any pressure in the coolant system. Do not push the cap down when turning.
4. Push down and turn the radiator cap counterclockwise to remove it.
5. The coolant level should be up to the base of the filler neck. Add coolant if it is low.
6. Put the radiator cap back on, and tighten it fully.
7. Pour coolant into the reserve tank until it reaches the **MAX** mark. Put the cap back on the reserve tank.

⌘ Radiator

⚠ WARNING

Removing the radiator cap while the engine is hot can cause the coolant to spray out, seriously scalding you.

Always let the engine and radiator cool down before removing the radiator cap.

NOTICE

Pour the fluid slowly and carefully so you do not spill any. Clean up any spills immediately; they can damage components in the engine compartment.

Transmission Fluid

Automatic Transmission Fluid

Specified fluid: Acura ATF DW-1 (automatic transmission fluid)

Check the fluid level when the engine is at normal operating temperature.

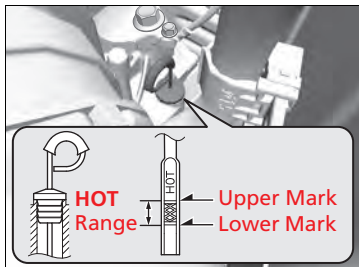

1. Park on level ground, and start the engine.
2. Wait until the radiator fan starts and then turn off the engine.
 - Perform step 3 after waiting for about 60 seconds (less than 90 seconds).
3. Remove the dipstick (yellow loop) from the transmission and wipe it with a clean cloth.
4. Insert the dipstick all the way back into the transmission securely, as shown in the image.
5. Remove the dipstick and check the fluid level.
 - It should be between the upper and lower marks in the **HOT** range.
6. If the level is below the lower mark, add fluid into the dipstick hole to bring it to the level between the upper and lower marks, and have your vehicle checked by a dealer immediately.

Automatic Transmission Fluid

NOTICE

Do not mix Acura ATF DW-1 with other transmission fluids.

Using a transmission fluid other than Acura ATF DW-1 may adversely affect the operation and durability of your vehicle's transmission, and damage the transmission.

Any damage caused by using a transmission fluid that is not equivalent to Acura ATF DW-1 is not covered by Acura's new vehicle warranty.

NOTICE

Pour the fluid slowly and carefully so you do not spill any. Clean up any spills immediately; they can damage components in the engine compartment.

Manual Transmission Fluid

Specified fluid: Acura Manual Transmission Fluid (MTF)

Check the fluid level when the engine is at normal operating temperature.

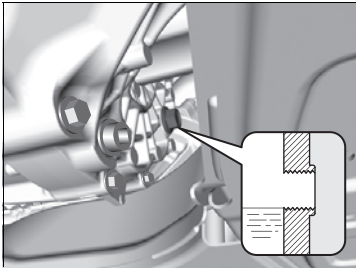

1. Park the vehicle on level ground.
2. Remove the transmission filler bolt and washer. Carefully feel inside the bolt hole with your fingers.
 - Check if the fluid level is up to the edge of the bolt hole.
3. If the fluid level is not up to the edge of the bolt hole, add Acura Manual Transmission Fluid (MTF) until it runs out of the hole.
4. Put a new washer on the filler bolt, then reinstall the filler bolt.
 - Tightening torque:
33 lbf·ft (44 N·m, 4.5 kgf·m)

Manual Transmission Fluid

If Acura MTF is not available, you may use the API certified SAE 0 W-20 or 5 W-20 viscosity motor oil as a temporary measure.

Replace with MTF as soon as possible. Motor oil does not contain the proper additives for the transmission and continued use can cause decreased shifting performance and lead to transmission damage.

Brake/Clutch Fluid

Specified fluid: Honda Heavy Duty Brake Fluid DOT 3

Use the same fluid for both the brakes and clutch.

Checking the Brake Fluid

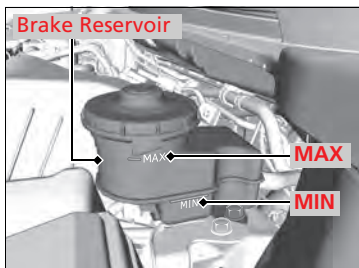

The fluid level should be between the **MIN** and **MAX** marks on the side of the reservoir.

Brake/Clutch Fluid

NOTICE

Brake fluid marked DOT 5 is not compatible with your vehicle's braking system and can cause extensive damage.

If the specified brake fluid is not available, you should use only DOT 3 or DOT 4 fluid from a sealed container as a temporary replacement.

Using any non-Honda brake fluid can cause corrosion and decrease the longevity of the system. Have the brake system flushed and refilled with Honda Heavy Duty Brake Fluid DOT 3 as soon as possible.

If the brake fluid level is at or below the **MIN** mark, have a dealer inspect for leaks or worn brake pads as soon as possible.

Checking the Clutch Fluid

If the clutch fluid level is at or below the **MIN** mark, have a dealer inspect for leaks or an excessively worn clutch plate as soon as possible.

Checking the Clutch Fluid

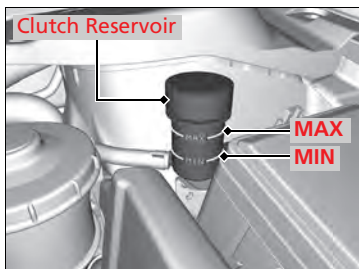

The fluid level should be between the **MIN** and **MAX** marks on the side of the reservoir.

Refilling Window Washer Fluid

Check the amount of window washer fluid using the washer fluid level gauge on the cap.

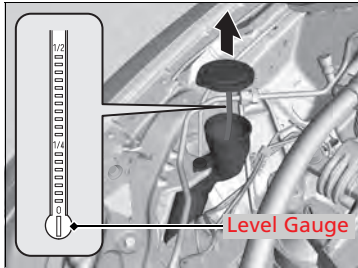

If the level is low, fill the washer reservoir.

✕ Refilling Window Washer Fluid

NOTICE

Do not use engine antifreeze or a vinegar/water solution in the windshield washer reservoir. Antifreeze can damage your vehicle's paint. A vinegar/water solution can damage the windshield washer pump.

Headlight Bulbs

When replacing, use the following bulbs.

High beam headlight: 60 W (HB3)
Low beam headlight: 55 W (H11 for halogen bulb Type)
35 W (D2S for high voltage discharge type)

High Beam Headlight

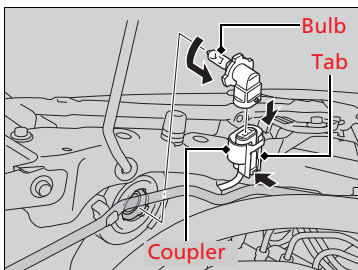

Driver side

1. Remove the engine compartment cover.
➔ [Engine Compartment Cover P. 259](#)

All models

2. Push the tab to remove the coupler.
3. Rotate the old bulb to the left to remove.
4. Insert a new bulb into the headlight assembly and turn it to the right.
5. Insert the coupler into the connector of the bulb.

High Voltage Discharge Types

Low Beam Headlights

High voltage can remain in the circuit for a long period of time after the light is switched off. Do not attempt to inspect or replace the high voltage discharge type bulbs yourself. Ask a dealer to inspect and replace low beam headlights.

Headlight Bulbs

NOTICE

Halogen bulbs get very hot when lit.

Oil, perspiration, or a scratch on the glass can cause the bulb to overheat and shatter.

The headlight aim is set by the factory, and does not need to be adjusted. However, if you regularly carry heavy items in the trunk or tow a trailer, have the aiming readjusted at a dealer or by a qualified technician.

The HB3 type is a halogen bulb.

When replacing a bulb, handle it by its base, and protect the glass from contact with your skin or hard objects. If you touch the glass, clean it with denatured alcohol and a clean cloth.

The exterior lights' inside lenses (headlights, brake lamps, etc.) may fog temporarily after a vehicle wash or while driving in the rain. This does not impact the exterior light function.

However, if you see a large amount of water or ice accumulated inside the lenses, have your vehicle inspected by a dealer.

Halogen Types

Low Beam Headlights

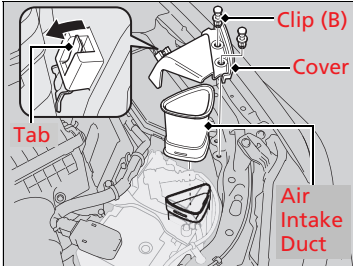

Driver side

1. Remove the engine compartment cover.
▶ [Engine Compartment Cover P. 259](#)
2. Unlock the holding clips (B). Push up the tab, and remove the cover of the air intake duct and its upper part.

Passenger side

All models

3. Remove the holding clip (C) using a flat-tip screwdriver, then remove the upper part of the windshield washer reservoir.
4. Rotate the cover to the left, and remove.

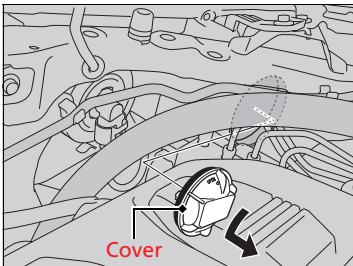
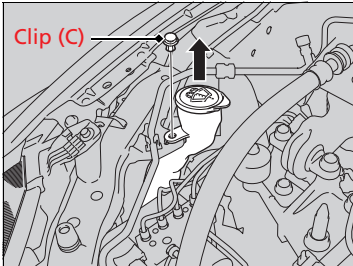

▶ Low Beam Headlights

Holding clip (C-type)

Insert a flat-tip screwdriver, lift and remove the center pin to remove the clip.

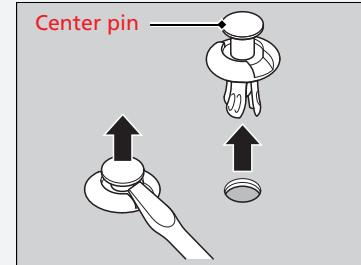

Insert the clip with the center pin raised, and push until it is flat.

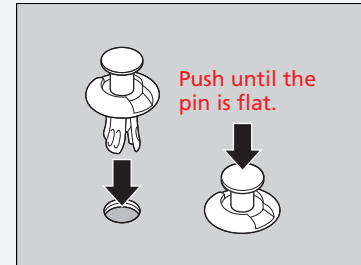

Continued

QRG

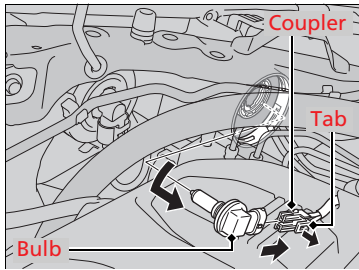

All models

5. Pull the tab to remove the coupler.
6. Rotate the old bulb to the left to remove.
7. Insert a new bulb into the headlight assembly and turn it to the right.
8. Insert the coupler into the connector of the bulb.

Fog Light Bulbs*

When replacing, use the following bulbs.

Fog Light: 55 W (H11)

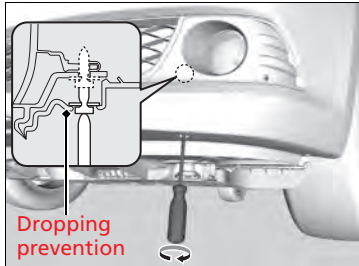

1. Remove the screw using a Phillips-head screwdriver.
 - The screw does not drop.

► Fog Light Bulbs*

NOTICE

Halogen bulbs get very hot when lit. Oil, perspiration, or a scratch on the glass can cause the bulb to overheat and shatter.

The fog lights are halogen bulbs.

When replacing a bulb, handle it by its plastic case, and protect the glass from contact with your skin or hard objects. If you touch the glass, clean it with denatured alcohol and a clean cloth.

TOC

Maintenance

Index

Home

QRG

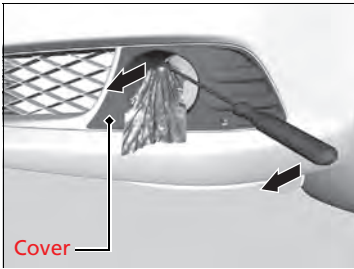

2. Insert a flat-tip screwdriver into the tab at the inside edge of the cover, then pull straight out as indicated to remove the cover.

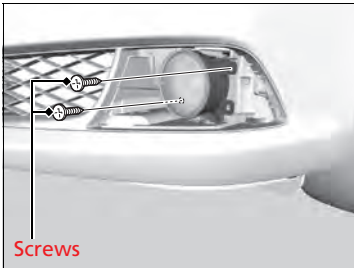

3. Remove the screws using a Phillips-head screwdriver and carefully pull the fog light assembly out of the bumper.

TOC

Maintenance

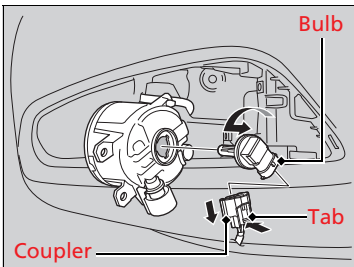

4. Push the tab to remove the coupler.

5. Rotate the old bulb to the left to remove.

6. Insert a new bulb into the fog light assembly and turn it to the right.

7. Insert the coupler into the connector of the bulb.

Index

Home

Front Turn Signal Light Bulbs

When replacing, use the following bulbs.

Front Turn Signal Light: 21 W

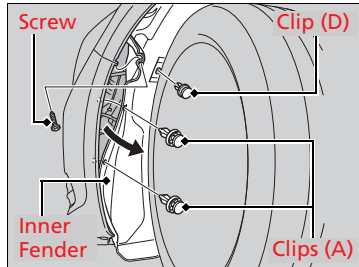

1. Turn the steering wheel all the way to the opposite side from the light being replaced.

Passenger side: Turn the steering wheel to the left.

Driver side: Turn the steering wheel to the right.

2. Remove the holding clips (A), (D) and screw, pull the inner fender back.

► [Engine Compartment Cover P. 259](#)

3. Turn the socket to the left and remove it, then remove the old bulb.

4. Insert a new bulb.

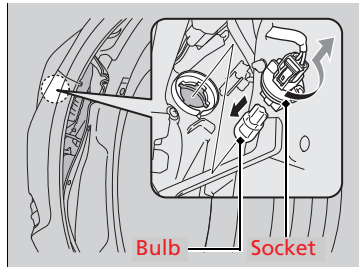

Front Turn Signal Light Bulbs

Holding clip (D-type)

When removing the clip, insert a flat-tip screwdriver, then lift and remove the clip.

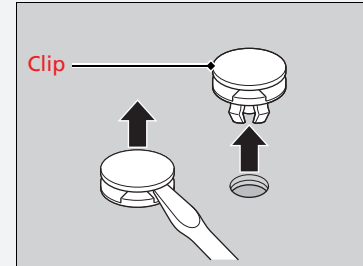

Insert the clip with the pin raised, and push until it is flat.

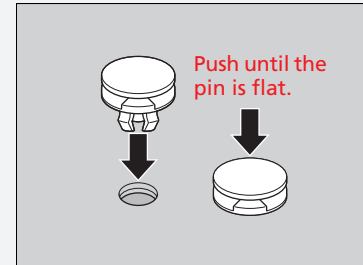

Parking/Side Marker Light Bulbs

When replacing, use the following bulbs.

Parking/Side Marker Light: 5 W

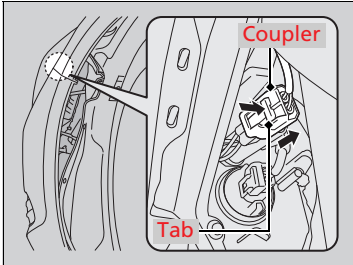

Turn the steering wheel and pull the inner fender back in the same way as when replacing the front turn signal light bulbs.

▶ [Front Turn Signal Light Bulbs P. 278](#)

1. Push the tab to remove the coupler.
2. Turn the socket to the left and remove it.
3. Remove the old bulb and insert a new bulb.
4. Insert the coupler into the connector of the bulb.

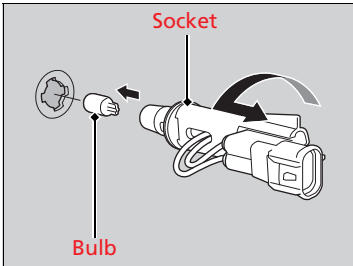

Brake Light, Taillight, Rear Turn Signal Light and Rear Side Marker Light Bulbs

When replacing, use the following bulbs.

Brake/Rear Side Marker/Taillight: 21/5 W
Rear Turn Signal Light: 21 W

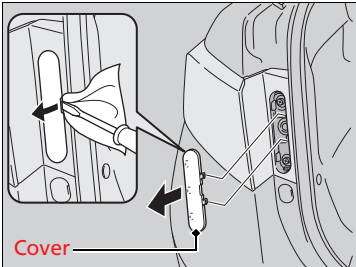

1. Pry on the edge of the cover using a flat-tip screwdriver to remove the cover.
 - Wrap the flat-tip screwdriver with a cloth to prevent scratches.

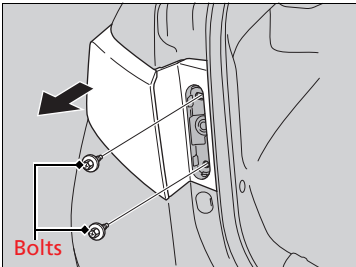

2. Remove the mounting bolts.
3. Pull the light assembly out of the rear pillar.

QRG

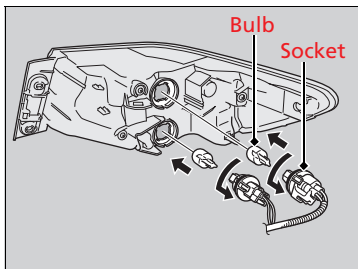

4. Turn the socket to the left and remove it.
Remove the old bulb.

5. Insert a new bulb.

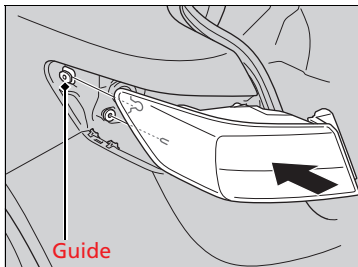

6. Reinstall the light assembly by sliding it on to the guide on the body.

TOC

Maintenance

Index

Home

Back-Up Light Bulbs

When replacing, use the following bulbs.

Back-Up Light: 16 W

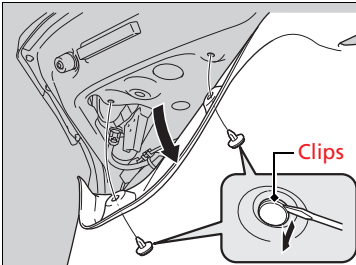

1. Remove the holding clips using a flat-tip screwdriver, then pull the lining back.

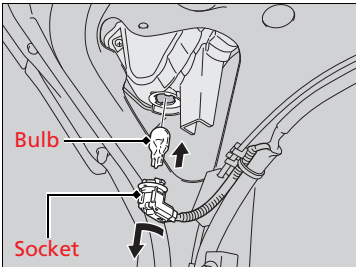

2. Turn the socket to the left and remove it.

3. Remove the old bulb and insert a new bulb.

QRG

Rear License Plate Light Bulb

When replacing, use the following bulb.

Rear License Plate Light: 5 W

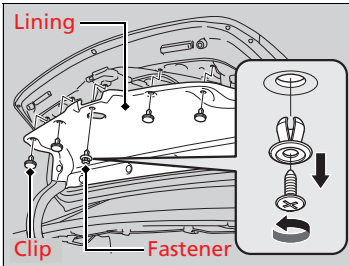

1. Remove the screw from the center of the fastener using a Phillips-head screwdriver.
2. Remove the holding clips using a flat-tip screwdriver, then pull the lining back.

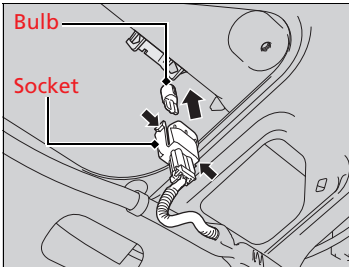

3. Remove the license plate light assembly by squeezing the tabs on both sides of the socket.
4. Remove the old bulb and insert a new bulb.

TOC

Maintenance

High-Mount Brake Light Bulb

High-mount brake light bulbs are LED type. Have an authorized Acura dealer inspect and replace the light bulbs.

Index

Home

Checking Wiper Blades

If the wiper blade rubber has deteriorated, it will leave streaks and the metal wiper arm may scratch the window glass.

Changing the Wiper Blade Rubber

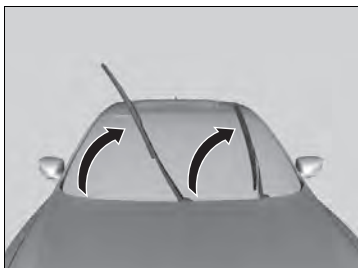

1. Lift the driver side wiper arm first, then the passenger side.

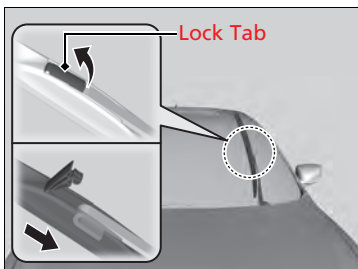

2. Place a cloth on the edge of the lock tab. Push the lock tab up with a flat-tip screw driver.
3. Slide the blade from the wiper arm.

Changing the Wiper Blade Rubber

NOTICE

Avoid dropping the wiper arm; it may damage the windshield.

QRG

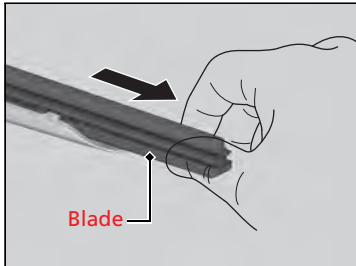

4. Slide the wiper blade out from its holder by pulling the tabbed end out.

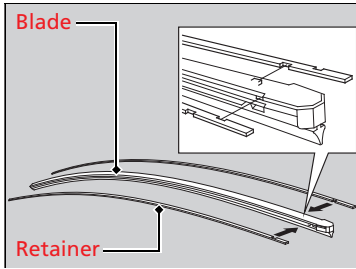

5. Remove the retainers from the rubber blade that has been removed, and mount to a new rubber blade.

▶ Correctly align the rubber protrusion and the retainer grooves.

6. Slide the new wiper blade onto the holder from the bottom end.

7. Slide the wiper blade onto the wiper arm, then push down the lock tab.

8. Lower the passenger side wiper arm first, then the driver side.

TOC

Maintenance

Index



Checking Tires

To safely operate your vehicle, your tires must be of the proper type and size, in good condition with adequate tread, and properly inflated.

■ Inflation guidelines

Properly inflated tires provide the best combination of handling, tread life, and comfort. Refer to the driver's doorjamb label or specification's page for the specified pressure.

Underinflated tires wear unevenly, adversely affect handling and fuel economy, and are more likely to fail from overheating.

Overinflated tires make your vehicle ride harshly, are more prone to road hazards, and wear unevenly.

Every day before you drive, look at each of the tires. If one looks lower than the others, check the pressure with a tire gauge.

At least once a month or before long trips, use a gauge to measure the pressure in all tires, including the spare. Even tires in good condition can lose 1 to 2 psi (10 to 20 kPa, 0.1 to 0.2 kgf/cm²) per month.

■ Inspection guidelines

Every time you check inflation, also examine the tires and valve stems.

Look for:

- Bumps or bulges on the side or in the tread. Replace the tire if you find any cuts, splits, or cracks in the side of the tire. Replace it if you see fabric or cord.
- Remove any foreign objects and inspect for air leaks.
- Uneven tread wear. Have a dealer check the wheel alignment.
- Excessive tread wear.

 [Wear Indicators P. 291](#)

- Cracks or other damage around valve stem.

☒ Checking Tires

WARNING

Using tires that are excessively worn or improperly inflated can cause a crash in which you can be seriously hurt or killed.

Follow all instructions in this owner's manual regarding tire inflation and maintenance.

Measure the air pressure when tires are cold. This means the vehicle has been parked for at least three hours, or driven less than 1 mile (1.6 km). If necessary, add or release air until the specified pressure is reached.

If checked when hot, tire pressure can be as much as 4 – 6 psi (30 – 40 kPa, 0.3 – 0.4 kgf/cm²) higher than if checked when cold.

Have a dealer check the tires if you feel a consistent vibration while driving. New tires and any that have been removed and reinstalled should be properly balanced.

QRG

Tire and Loading Information Label

The label attached to the driver's doorjamb provides necessary tire and loading information.

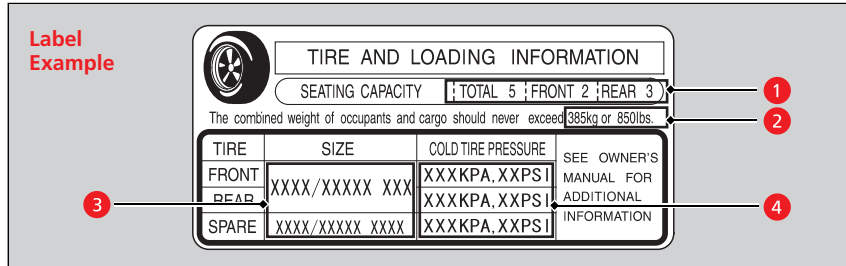

Tire and Loading Information Label

The tire and loading information label attached to the driver's doorjamb contains:

- 1 The number of people your vehicle can carry.
- 2 The total weight your vehicle can carry. Do not exceed this weight.
- 3 The original tire sizes for front, rear, and spare.
- 4 The proper cold tire pressure for front, rear, and spare.

Tire Labeling

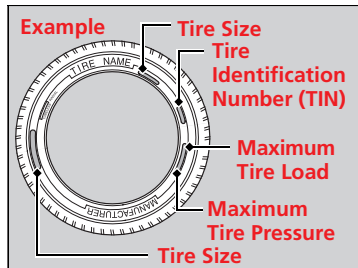

The tires that came on your vehicle have a number of markings. Those you should be aware of are described below.

Tire Sizes

Following is an example of tire size with an explanation of what each component means.

P215/45R17 87V

- P:** Vehicle type (P indicates passenger vehicle).
- 215:** Tire width in millimeters.
- 45:** Aspect ratio (the tire's section height as a percentage of its width).
- R:** Tire construction code (R indicates radial).
- 17:** Rim diameter in inches.
- 87:** Load index (a numerical code associated with the maximum load the tire can carry).
- V:** Speed symbol (an alphabetical code indicating the maximum speed rating).

TOC

Maintenance

Index

Tire Sizes

Whenever tires are replaced, they should be replaced with tires of the same size.

Continued

■ Tire Identification Number (TIN)

The tire identification number (TIN) is a group of numbers and letters that look like the example in the side column. TIN is located on the sidewall of the tire.

■ Glossary of Tire Terminology

Cold Tire Pressure – The tire air pressure when the vehicle has been parked for at least three hours or driven less than 1 mile (1.6 km).

Load Rating – Means the maximum load that a tire is rated to carry for a given inflation pressure.

Maximum Inflation Pressure – The maximum tire air pressure that the tire can hold.

Maximum Load Rating – Means the load rating for a tire at the maximum permissible inflation pressure for that tire.

Recommended Inflation Pressure – The cold tire inflation pressure recommended by the manufacturer.

Treadwear Indicators (TWI) – Means the projections within the principal grooves designed to give a visual indication of the degrees of wear of the tread.

▶▶ Tire Identification Number (TIN)

DOT B97R FW6X 2209

DOT: This indicates that the tire meets all requirements of the U.S. Department of Transportation.

B97R: Manufacturer's identification mark.

FW6X: Tire type code.

22 09: Date of manufacture.

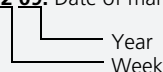

DOT Tire Quality Grading (U.S. Vehicles)

The tires on your vehicle meet all U.S. Federal Safety Requirements. All tires are also graded for treadwear, traction, and temperature performance according to Department of Transportation (DOT) standards. The following explains these gradings.

■ Uniform Tire Quality Grading

Quality grades can be found where applicable on the tire sidewall between tread holder and maximum section width.

■ Treadwear

The treadwear grade is a comparative rating based on the wear rate of the tire when tested under controlled conditions on a specified government test course. For example, a tire graded 150 would wear one and one-half (1 1/2) times as well on the government course as a tire graded 100. The relative performance of tires depends upon the actual conditions of their use, however, and may depart significantly from the norm due to variations in driving habits, service practices and differences in road characteristics and climate.

☒ Uniform Tire Quality Grading

For example:

Treadwear 200
Traction AA
Temperature A

All passenger car tires must conform to Federal Safety Requirements in addition to these grades.

■ Traction

The traction grades, from highest to lowest, are AA, A, B, and C. Those grades represent the tire's ability to stop on wet pavement as measured under controlled conditions on specified government test surfaces of asphalt and concrete. A tire marked C may have poor traction performance.

■ Temperature

The temperature grades are A (the highest), B, and C, representing the tire's resistance to the generation of heat and its ability to dissipate heat when tested under controlled conditions on a specified indoor laboratory test wheel. Sustained high temperature can cause the material of the tire to degenerate and reduce tire life, and excessive temperature can lead to sudden tire failure. The grade C corresponds to a level of performance which all passenger car tires must meet under the Federal Motor Vehicle Safety Standard No. 109. Grades B and A represent higher levels of performance on the laboratory test wheel than the minimum required by law.

☒ Traction

Warning: The traction grade assigned to this tire is based on straight-ahead braking traction tests, and does not include acceleration, cornering, hydroplaning, or peak traction characteristics.

☒ Temperature

Warning: The temperature grade for this tire is established for a tire that is properly inflated and not overloaded. Excessive speed, underinflation or excessive loading, either separately or in combination, can cause heat buildup and possible tire failure.

Wear Indicators

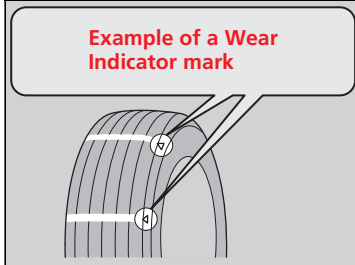

The groove where the wear indicator is located is 1/16 inch (1.6 mm) shallower than elsewhere on the tire. If the tread has worn so that the indicator is exposed, replace the tire.

Worn out tires have poor traction on wet roads.

Tire Service Life

The life of your tires is dependent on many factors, including driving habits, road conditions, vehicle loading, inflation pressure, maintenance history, speed, and environmental conditions (even when the tires are not in use).

In addition to regular inspections and inflation pressure maintenance, it is recommended that you have annual inspections performed once the tires reach five years old. All tires, including the spare, should be removed from service after 10 years from the date of manufacture, regardless of their condition or state of wear.

☒ Checking Tires

High speed driving

We recommend that you do not drive faster than the posted speed limits and conditions allow. If you drive at sustained high speeds (over 118 mph or 190 km/h), adjust the cold tire pressures as shown below to avoid excessive heat build up and sudden tire failure.

Tire Size	P215/45R17 87V
Pressure	36 psi (250 kPa, 2.5 kgf/cm ²)

Tire and Wheel Replacement

Replace your tires with radials of the same size, load range, speed rating, and maximum cold tire pressure rating (as shown on the tire's sidewall). Using tires of a different size or construction can cause the ABS and VSA® (vehicle stability assist) system to work incorrectly.

It is best to replace all four tires at the same time. If that isn't possible, replace the front or rear tires in pairs.

Make sure that the wheel's specifications match those of the original wheels.

U.S. models only

If you replace a wheel, only use TPMS specified wheels approved for your vehicle.

▶▶ Tire and Wheel Replacement

WARNING

Installing improper tires on your vehicle can affect handling and stability. This can cause a crash in which you can be seriously hurt or killed.

Always use the size and type of tires recommended in this owner's manual.

Tire Rotation

Rotating tires according to the maintenance messages on the multi-information display helps to distribute wear more evenly and increase tire life.

■ Tires without rotation marks

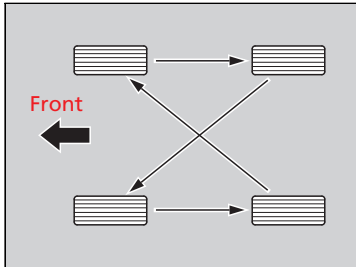

Rotate the tires as shown here.

■ Tires with rotation marks

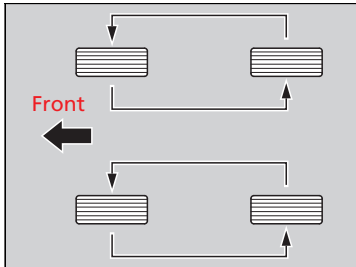

Rotate the tires as shown here.

☒ Tire Rotation

Tires with directional tread patterns should only be rotated front to back (not from one side to the other). Directional tires should be mounted with the rotation indication mark facing forward, as shown below.

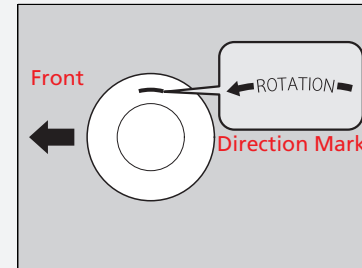

Winter Tires

If driving on snowy or frozen roads, mount all season marked **M+S** tires, snow tires, or tire chains; reduce speed; and maintain sufficient distance between vehicles when driving.

Be particularly careful when operating the steering wheel or brakes to prevent skidding.

Use tire chains, snow tires, or all season tires when necessary or according to the law.

When mounting, refer to the following points.

For winter tires:

- Select the size and load ranges that are the same as the original tires.
- Mount the tires to all four wheels.

For tire chains:

- Install them on the front tires only.
- Because your vehicle has limited tire clearance, we strongly recommend using the chains listed below:

Cable-type: SCC Radial Chain SC1032

- Follow the chain manufacturer's instruction when installing. Mount them as tightly as you can.
- Check that the chains do not touch the brake lines or suspension.
- Drive slowly.

Winter Tires

⚠ WARNING

Using the wrong chains, or not properly installing chains, can damage the brake lines and cause a crash in which you can be seriously injured or killed.

Follow all instructions in this owner's manual regarding the selection and use of tire chains.

NOTICE

Traction devices that are the wrong size or improperly installed can damage your vehicle's brake lines, suspension, body, and wheels. Stop driving if they are hitting any part of the vehicle.

When tire chains are mounted, follow the chain manufacturer's instructions regarding vehicle operational limits.

If your vehicle is equipped with summer tires, be aware that these tires are not designed for winter driving conditions. For more information, contact a dealer.

Checking the Battery

The battery condition is being monitored by the sensor on the negative terminal. If there is a problem with the sensor, the warning message on multi-information display will let you know. Have your vehicle checked by a dealer.

If your vehicle's battery is disconnected or goes dead:

- The audio system is disabled.
➤ [Reactivating the audio system P. 144](#)
- The clock resets.
➤ [Setting the Clock P. 92](#)
- The navigation system* is disabled.
➤ [Refer to the navigation system manual](#)

Charging the Battery

Disconnect both battery cables to prevent damaging your vehicle's electrical system. Always disconnect the negative (–) cable first, and reconnect it last.

⚠ Battery

⚠ WARNING

The battery gives off explosive hydrogen gas during normal operation.

A spark or flame can cause the battery to explode with enough force to kill or seriously hurt you.

When conducting any battery maintenance, wear protective clothing and a face shield, or have a skilled technician do it.

WARNING: Battery post, terminals, and related accessories contain lead and lead compounds.

Wash your hands after handling.

The test indicator's color information is on the battery.

When you find corrosion, clean the battery terminals by applying a baking powder and water solution. Rinse the terminals with water. Cloth/towel dry the battery. Coat the terminals with grease to help prevent future corrosion.

Replacing the Button Battery

If the indicator does not come on when the button is pressed, replace the battery.



Battery type: CR2032

1. Remove the built-in key.
2. Remove the upper half by carefully prying on the edge with a coin.
 - ▶ Wrap a coin with a cloth to prevent scratching the transmitter.
3. Make sure to replace the battery with the correct polarity.

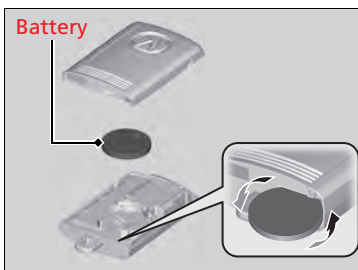

Replacing the Button Battery

NOTICE

An improperly disposed of battery can damage the environment. Always confirm local regulations for battery disposal.

Replacement batteries are commercially available or at a dealer.

Dust and Pollen Filter

The climate control system is equipped with a dust and pollen filter that collects pollen, dust, and other debris in the air. The Maintenance Minder™ messages will let you know when to replace the filter.

We recommend that you replace the dust and pollen filter sooner when using your vehicle in areas with high concentrations of dust.

☒ Dust and Pollen Filter

If the airflow from the climate control system deteriorates noticeably, and the windows fog up easily, the filter may need to be replaced. Please contact a dealer for replacement.

Interior Care

Use a damp cloth with a mixture of mild detergent and warm water to remove dirt. Use a clean cloth to remove detergent residue.

Cleaning Seat Belts

Use a soft brush with a mixture of mild soap and warm water to clean the seat belts. Let the belts air dry. Wipe the openings of the seat belt anchors using a clean cloth.

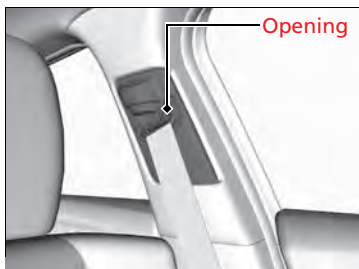

Interior Care

Do not spill liquids inside the vehicle.

Electrical devices and systems may malfunction if liquids are splashed on them.

Do not use silicone based sprays on electrical devices such as audio devices and switches.

Doing so may cause the items to malfunction or a fire inside the vehicle.

If a silicone based spray is inadvertently used on electrical devices, consult a dealer.

Depending on their composition, chemicals and liquid aromatics may cause discoloration, wrinkles, and cracking to resin-based parts and textiles.

Do not use alkali solvents or organic solvents such as benzene or gasoline.

After using chemicals, make sure to gently wipe them off using a dry cloth.

Do not place used cloths on top of resin based parts or textiles for long periods of time without washing.

■ Floor Mats

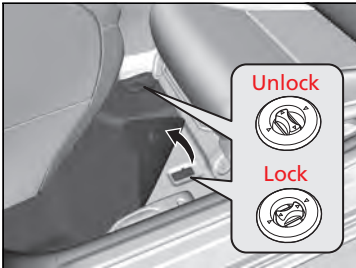

The front floor mats hook over the floor anchors, which keep the mats from sliding forward. To remove the mats for cleaning, turn the anchor knobs to the unlock position. When reinstalling the mats after cleaning, turn the knobs to the lock position.

Do not put additional floor mats on top of the anchored mat.

■ Maintaining Genuine Leather*

Vacuum dirt and dust from the leather frequently. Pay close attention to the pleats and seams. Clean the leather with a soft cloth dampened with a 90% water and 10% neutral soap solution. Then buff it with a clean, dry cloth. Remove any dust or dirt on leather surfaces immediately.

▣ Floor Mats

If you use any floor mats that were not originally provided with your vehicle, make sure they are designed for your specific vehicle, fit correctly, and are securely anchored by the floor anchors. Position the rear seat floor mats properly. If they are not properly positioned, the floor mats can interfere with the front seat functions.

* Not available on all models

Exterior Care

Dust off the vehicle body after you drive.

Regularly inspect your vehicle for scratches on painted surfaces. A scratch on a painted surface can result in body rust. If you find a scratch, promptly repair it.

■ Washing the Vehicle

Wash the vehicle regularly. Wash more frequently when driving in the following conditions:

- If driving on roads with road salt.
- If driving in coastal areas.
- If tar, soot, bird droppings, insects, or tree sap are stuck to painted surfaces.

■ Using an Automated Vehicle Wash

Fold in the door mirrors. Make sure to follow the instructions indicated on the automated vehicle wash.

■ Using High Pressure Cleaners

- Keep sufficient distance between the cleaning nozzle and the vehicle body.
- Take particular care around the windows. Standing too close may cause water to enter the vehicle interior. Do not spray water into the engine compartment.

⌘ Washing the Vehicle

Do not spray water into the air intake vents or engine compartment. It can cause a malfunction.



■ Applying Wax

A good coat of automotive body wax helps protect your vehicle's paint from the elements. Wax will wear off over time and expose your vehicle's paint to the elements, so reapply as necessary.

■ Maintaining the Bumpers and Other Resin Coated Parts

If you get gasoline, oil, engine coolant, or battery fluid on resin coated parts, they may be stained or the coating may peel. Promptly wipe it away using a soft cloth and clean water.

■ Cleaning the Window

Wipe using a glass cleaner.

■ Maintaining Aluminum Wheels

Aluminum is susceptible to deterioration caused by salt and other road contaminants. Use a sponge and mild detergent to wipe away promptly. Be careful not to use harsh chemicals (including some commercial wheel cleaners) or a stiff brush. They can damage the clear coat of the aluminum alloy wheels that helps keep the aluminum from corroding and tarnishing.

▣ Applying Wax

NOTICE

Chemical solvents and strong cleaners can damage the paint, metal, and plastic on your vehicle. Wipe up spills immediately.

▣ Maintaining the Bumpers and Other Resin Coated Parts

Ask a dealer about the correct coating material when you want to repair the painted surface of the parts made of resin.

▣ Cleaning the Window

Wires are mounted to the inside of the rear window. Wipe along the same direction as the wires with a soft cloth so as not to damage them.

Handling the Unexpected

This chapter explains how to handle unexpected troubles.



- Tools**
- Types of Tools..... 304
- If a Tire Goes Flat**
- Changing a Flat Tire..... 305
- Engine Does Not Start**
- Checking the Engine..... 311
- If the Keyless Access Remote Battery is Weak..... 312
- Emergency Engine Stop..... 313
- Jump Starting**..... 314
- Shift Lever Does Not Move**..... 317

- Overheating**
- How to Handle Overheating..... 318
- Indicator, Coming On/Blinking**
- If the Low Oil Pressure Indicator Comes On..... 320
- If the Charging System Indicator Comes On..... 320
- If the Malfunction Indicator Lamp Comes On or Blinks..... 321
- If the Brake System Indicator Comes On..... 322
- If the Electric Power Steering (EPS) System Indicator Comes On..... 322

- If the Low Tire Pressure/TPMS Indicator Comes On or Blinks..... 323
- Fuses**
- Fuse Locations..... 324
- Inspecting and Changing Fuses..... 326
- Emergency Towing**..... 327

Types of Tools

Types of Tools

[How to Set Up the Jack P. 308](#)

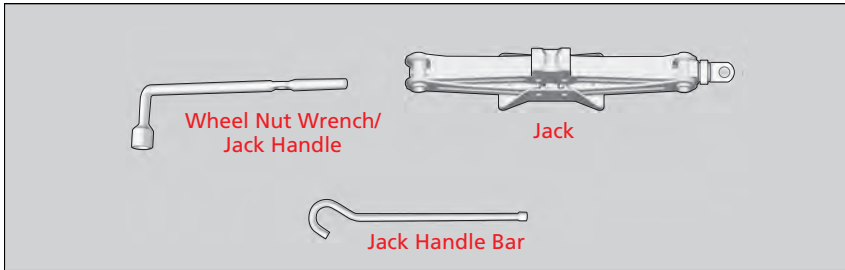

Changing a Flat Tire

If a tire goes flat while driving, grasp the steering wheel firmly, and brake gradually to reduce speed. Then, stop in a safe place. Replace the flat tire with a compact spare tire. Go to a dealer as soon as possible to have the full size tire repaired or replaced.

1. Park the vehicle on firm, level, and non-slippery and apply the parking brake.

Automatic transmission models

2. Move the shift lever in **P**.

Manual transmission models

2. Move the shift lever in **R**.

All models

3. Set the parking brake.
4. Turn on the hazard warning lights and set the power mode to VEHICLE OFF (LOCK).

Changing a Flat Tire

Periodically check the tire pressure of the compact spare. It should be set to the specified pressure.
Specified Pressure: 60 psi (420 kPa, 4.2 kgf/cm²)

When driving with the compact spare tire, keep the vehicle speed under 50 mph (80 km/h). Replace with a full size tire as soon as possible.

The compact spare tire and wheel in your vehicle are specifically for this model.

Do not use them with another vehicle.

Do not use another type of compact spare tire or wheel with your vehicle.

Do not mount tire chains on a compact spare tire. If a chain-mounted front tire goes flat, remove one of the full-size rear tires and replace it with the compact spare tire. Remove the flat front tire and replace it with the full size tire that was removed from the rear. Mount the tire chains on the front tire.

U.S. models only

Do not use a puncture-repairing agent on a flat tire, as it can damage the tire pressure sensor.

■ Getting Ready to Replace the Flat Tire

⊠ Getting Ready to Replace the Flat Tire

The shape of the tool case varies by model.



1. Open the trunk floor lid.

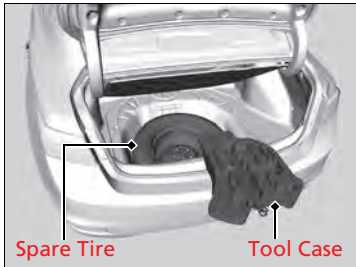

2. Take the tool case out of the trunk. Take the jack and wheel nut wrench out of the tool case.
3. Unscrew the wing bolt, and remove the spacer cone. Then, remove the spare tire.

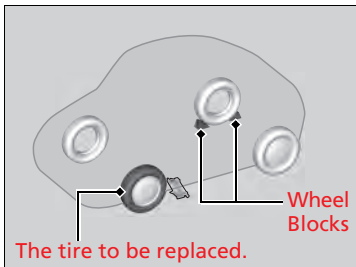

4. Place a wheel block or rock in front and rear of the wheel diagonal to the flat tire.

QRG

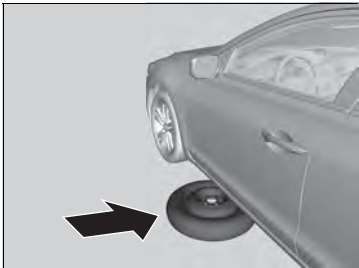

5. Place the compact spare tire (wheel side up) under the vehicle body, near the tire that needs to be replaced.

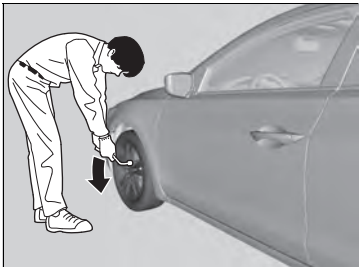

6. Loosen each wheel nut about one turn using the wheel nut wrench.

Handling the Unexpected

TOC

Index

Home

■ How to Set Up the Jack

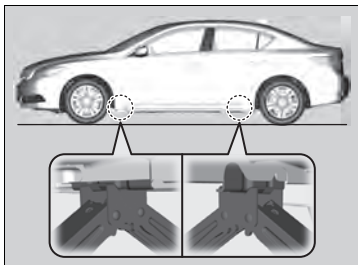

1. Place the jack under the jacking point closest to the tire to be changed.

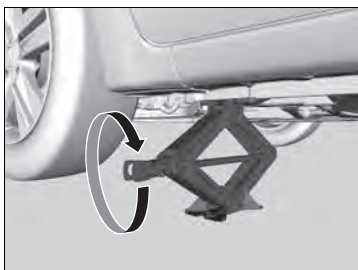

2. Turn the end bracket (as shown in the image) clockwise until the top of the jack contacts the jacking point.

▶ Make sure that the jacking point tab is resting in the jack notch.

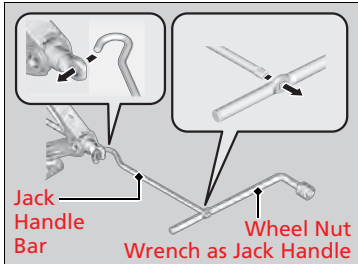

3. Raise the vehicle, using the jack handle bar and the jack handle, until the tire is off the ground.

🔧 How to Set Up the Jack

⚠️ WARNING

The vehicle can easily roll off the jack, seriously injuring anyone underneath.

Follow the directions for changing a tire exactly, and never get under the vehicle when it is supported only by the jack.

Do not use the jack with people or luggage in the vehicle.

Use the jack provided in your vehicle.

Other jacks may not support the weight ("load") or their shape may not match.

The following instructions must be followed to use the jack safely.

- Do not use while the engine is running.
- Use only where the ground is firm and level.
- Use only at the jacking points.
- Do not get in the vehicle while using the jack.
- Do not put anything on top of or underneath the jack.

Replacing the Flat Tire



1. Remove the wheel nuts and flat tire.

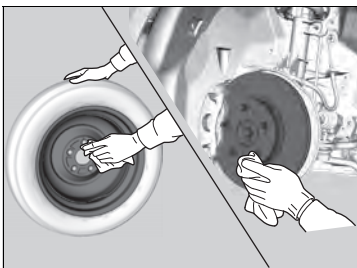

2. Wipe the mounting surfaces of the wheel with a clean cloth.

3. Mount the compact spare tire.

4. Screw the wheel nuts until they touch the lips around the mounting holes, and stop rotating.

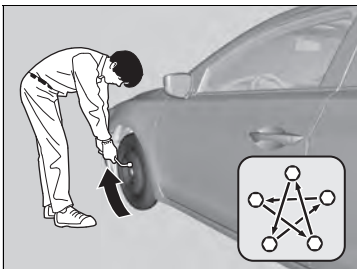

5. Lower the vehicle and remove the jack. Tighten the wheel nuts in the order indicated in the image. Go around, tightening the nuts, two to three times in this order.

Wheel nut torque:

80 lbf·ft (108 N·m, 11 kgf·m)

Replacing the Flat Tire

Do not over tighten the wheel nuts by applying extra torque using your foot or a pipe.

■ Storing the Flat Tire

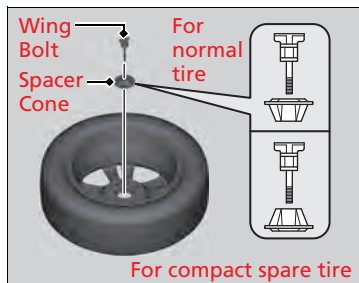

1. Remove the center cap.
2. Place the flat tire face down in the spare tire well.
3. Remove the spacer cone from the wing bolt, flip it over, and insert it back on the bolt. Secure the flat tire with the wing bolt.
4. Securely put the jack and wheel nut wrench back in the tool case. Store the case in the trunk.

■ TPMS and the Spare Tire

U.S. models

If you replace a flat tire with the spare tire, the low tire pressure/TPMS indicator comes on while you are driving. After driving for a few miles (kilometers), the indicator will start blinking for a short time and then stay on. **CHECK TPMS SYSTEM** appears on the multi-information display, but this is normal.

If you replace the tire with a specified regular tire, the warning message on the multi-information display and the low tire pressure/TPMS indicator will go off after a few miles (kilometers).

▶▶ Storing the Flat Tire

⚠ WARNING

Loose items can fly around the interior in a crash and can seriously injure the occupants.

Store the wheel, jack, and tools securely before driving.

▶▶ TPMS and the Spare Tire

The system cannot monitor the pressure of the spare tire. Manually check the spare tire pressure to be sure that it is correct.

Use TPMS specific wheels. Each is equipped with a tire pressure sensor mounted inside the tire behind the valve stem.

Checking the Engine

If the engine does not start, check the starter.

Checking the Engine

If you must start the vehicle immediately, use an assisting vehicle to jump start it.

[Jump Starting P. 314](#)

Starter condition

Checklist

Starter doesn't turn or turns over slowly.

The battery may be dead. Check each of the items on the right and respond accordingly.

Check brightness of the interior light.

Turn on interior lights and check brightness.

- If the interior lights are dim or do not come on at all [Battery P. 295](#)
- If the interior lights come on normally [Fuses P. 324](#)

The starter turns over normally but the engine doesn't start.

There may be a problem with the fuse. Check each of the items on the right and respond accordingly.

Review the engine start procedure.

Follow its instructions, and try to start the engine again. [Starting the Engine P. 216](#)

Check the immobilizer system indicator.

When the immobilizer system indicator is blinking, the engine cannot be started.

[Immobilizer System P. 106](#)

Check the fuel level.

There should be enough fuel in the tank. [Fuel Gauge P. 78](#)

Check the fuse.

Check all fuses, or have the vehicle checked by a dealer.

[Inspecting and Changing Fuses P. 326](#)

If the problem continues:

[Emergency Towing P. 327](#)

If the Keyless Access Remote Battery is Weak

If the beeper sounds, the **TO START, HOLD REMOTE NEAR START BUTTON** message appears on the multi-information display, the indicator on the **ENGINE START/STOP** button flashes, and the engine won't start. Start the engine as follows.

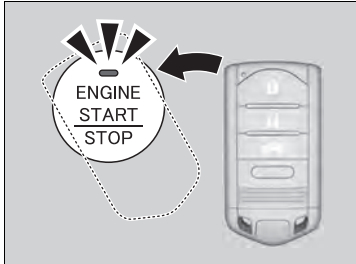

1. Touch the center of the **ENGINE START/STOP** button with the **A** logo on the keyless access remote while the indicator on the **ENGINE START/STOP** button is flashing. The buttons on the keyless access remote should be facing you.
 - ▶ The indicator flashes for about 30 seconds.

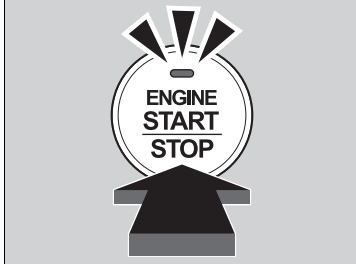

2. Depress the brake pedal (automatic transmission) or clutch pedal (manual transmission) and press the **ENGINE START/STOP** button within 10 seconds after the beeper sounds and the indicator stays on.
 - ▶ If you don't depress the pedal, the mode will change to ACCESSORY.

Emergency Engine Stop

If you cannot stop the engine by pressing the **ENGINE START/STOP** button, do either of the following operations:

- Press and hold the **ENGINE START/STOP** button for three seconds.
- Firmly press the **ENGINE START/STOP** button three times.

The steering wheel will not lock.

Automatic transmission models

The power mode changes to VEHICLE OFF with the shift lever in **P**, and to ACCESSORY with the shift lever in any position other than **P**.

Manual transmission models

The power mode changes to VEHICLE OFF.

Emergency Engine Stop

Do not press the button while driving unless it is absolutely necessary for the engine to be switched off.

Jump Starting Procedure

Turn off the power to electric devices, such as audio and lights. Turn off the engine, then open the hood.

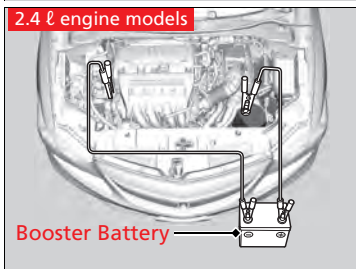
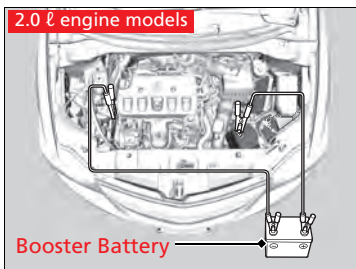

1. Connect the first jumper cable to your vehicle's battery \oplus terminal.
2. Connect the other end of the first jumper cable to the assisting vehicle's \oplus terminal.
▶ Use a 12-volt booster battery only.
3. Connect the second jumper cable to the assisting vehicle's \ominus terminal.

Jump Starting

⚠ WARNING

A battery can explode if you do not follow the correct procedure, seriously injuring anyone nearby.

Keep all sparks, open flames, and smoking materials away from the battery.

Securely attach the jumper cable clips so that they do not come off when the engine vibrates. Also be careful not to tangle the jumper cables or allow the cable ends to touch each other while attaching or detaching the jumper cables.

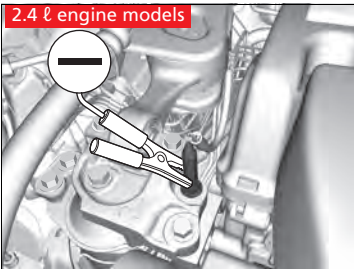
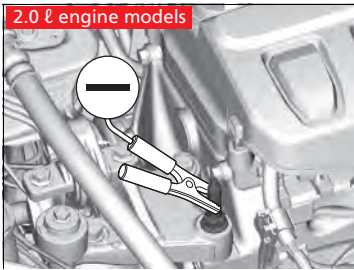

4. Connect the other end of the second jumper cable to the engine mounting bolt as shown.

Do not connect this jumper cable to any other part.

5. If your vehicle is connected to another vehicle, start the assisting vehicle's engine and increase its rpm slightly.
6. Attempt to start your vehicle's engine. If it turns over slowly, check that the jumper cables have good metal-to-metal contact.

Jump Starting

Battery performance degrades in cold conditions and may prevent the engine from starting.

■ What to Do After the Engine Starts

Once your vehicle's engine has started, remove the jumper cables in the following order.

1. Disconnect the jumper cable from your vehicle's ground.
2. Disconnect the other end of the jumper cable from the assisting vehicle's battery \ominus terminal.
3. Disconnect the jumper cable from your vehicle's battery \oplus terminal.
4. Disconnect the other end of the jumper cable from the assisting vehicle's battery \oplus terminal.

Have your vehicle inspected by a nearby service station or a dealer.

Automatic transmission models

Follow the procedure below if you cannot move the shift lever out of the **P** position.

Releasing the Lock

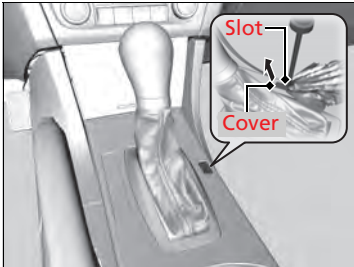

1. Set the parking brake.
2. Remove the built-in key from the keyless access remote.
3. Wrap a cloth around the tip of a small flat-tip screwdriver and remove the cover of the shift lock release slot.
 - ▶ Put the tip of the flat-tip screwdriver into the slot and remove it as shown in the image.

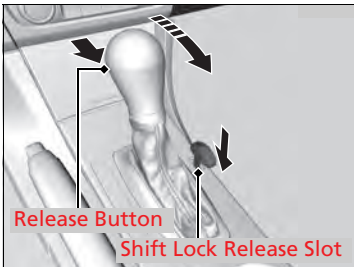

4. Insert the key into the shift lock release slot.
5. While pushing on the key, press the shift lever release button and place the shift lever into **N**.
 - ▶ The lock is now released. Have the shift lever checked by a dealer as soon as possible.

How to Handle Overheating

Overheating symptoms are as follows:

- The temperature gauge needle is at the **H** mark or the engine suddenly loses power.
- Steam or spray comes out of the engine compartment.

■ First thing to do

1. Immediately park the vehicle in a safe place.
2. Turn off all accessories and turn on the hazard warning lights.
 - ▶ **No steam or spray present:** Keep the engine running and open the hood.
 - ▶ **Steam or spray is present:** Turn off the engine and wait until it subsides. Then open the hood.

▣ How to Handle Overheating

WARNING

Steam and spray from an overheated engine can seriously scald you.

Do not open the hood if steam is coming out.

▣ NOTICE

Continuing to drive with the temperature gauge needle at the **H** mark may damage the engine.

■ Next thing to do

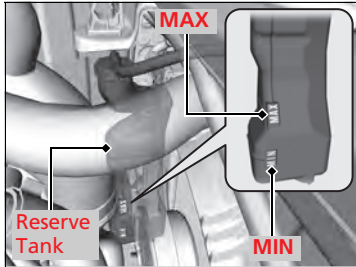

1. Check that the cooling fan is operating and stop the engine once the temperature gauge needle comes down.
 - ▶ If the cooling fan is not operating, immediately stop the engine.
2. Once the engine has cooled down, inspect the coolant level and check the cooling system components for leaks.
 - ▶ If the coolant level in the reserve tank is low, add coolant until it reaches the **MAX** mark.
 - ▶ If there is no coolant in the reserve tank, check that the radiator is cool. Cover the radiator cap with a heavy cloth and open the cap. If necessary, add coolant up to the base of the filler neck, and put the cap back on.

■ Last thing to do

Once the engine has cooled sufficiently, restart it and check the temperature gauge. If the temperature gauge needle has gone down, resume driving. If it has not gone down, contact a dealer for repairs.

▶▶ How to Handle Overheating

⚠ WARNING

Removing the radiator cap while the engine is hot can cause the coolant to spray out, seriously scalding you.

Always let the engine and radiator cool down before removing the radiator cap.

If the coolant is leaking, contact a dealer for repairs.

Use water as an emergency/temporary measure only. Have a dealer flush the system with proper antifreeze as soon as possible.

If the Low Oil Pressure Indicator Comes On



■ Reasons for the indicator to come on

Comes on when the engine oil pressure is low.

■ What to do as soon as the indicator comes on

1. Immediately park the vehicle in a safe place.
2. If necessary, turn the hazard warning lights on.

■ What to do after parking the vehicle

1. Stop the engine and let it sit for about one minute.
2. Open the hood and check the oil level.
 - ▶ Add oil as necessary.
3. Start the engine and check the low oil pressure indicator.
 - ▶ The light goes out: Start driving again.
 - ▶ The light does not go out within 10 seconds: Stop the engine and contact a dealer for repairs immediately.

If the Charging System Indicator Comes On



■ Reasons for the indicator to come on

Comes on when the battery is not being charged.

■ What to do when the indicator comes on

Turn off the climate control system, rear defogger, and other electrical systems, and immediately contact a dealer for repairs.

☒ If the Low Oil Pressure Indicator Comes On

NOTICE

Running the engine with low oil pressure can cause serious mechanical damage almost immediately.

☒ If the Charging System Indicator Comes On

If you need to stop temporarily, do not turn off the engine. Restarting the engine may rapidly discharge the battery.

If the Malfunction Indicator Lamp Comes On or Blinks



■ Reasons for indicator lamp to come on or blink

- Comes on when there is a problem with the engine emissions control system, or the fuel fill cap is missing, or loose.
- Blinks when engine misfiring is detected.

■ What to do when the indicator lamp comes on

Avoid high speeds and immediately get your vehicle inspected at a dealer.

■ What to do when the indicator lamp blinks

Park the vehicle in a safe place with no flammable items and wait at least ten minutes or more with the engine stopped until it cools.

■ Check/Tighten Fuel Cap Message

■ The message appears on when:

An evaporative system leak is detected. This may be caused by the fuel fill cap being loose or not being installed.

■ What to do when the message appears:

1. Stop the engine.
2. Check that the fuel fill cap is fully installed.
 - ▶ If not, loosen the cap, and then retighten it until it clicks at least once.
3. Drive for several days of normal driving.
 - ▶ The message should go off.

■ When the malfunction indicator lamp comes on

Malfunction indicator lamp comes on if the system continues to detect a leak of gasoline vapor. If this happens, check the fuel fill cap using the procedures described above.

▶▶ If the Malfunction Indicator Lamp Comes On or Blinks

NOTICE

If you drive with the malfunction indicator lamp on, the emissions control system and the engine could be damaged.

If the malfunction indicator lamp blinks again when restarting the engine, drive to the nearest dealer at 31 mph (50 km/h) or less. Have your vehicle inspected.

If the Brake System Indicator Comes On

U.S.



Canada



■ Reasons for the indicator to come on

- The brake fluid is low.
- There is a malfunction in the brake system.

■ What to do when the indicator comes on while driving

Press the brake pedal lightly to check pedal pressure.

- If normal, check the brake fluid level the next time you stop.
- If abnormal, take immediate action. If necessary, downshift the transmission to slow the vehicle using engine braking.

▶▶ If the Brake System Indicator Comes On

Have your vehicle repaired immediately.

It is dangerous to drive with low brake fluid. If there is no resistance from the brake pedal, stop immediately in a safe place. If necessary downshift the gears.

If the brake system indicator and **ABS** indicator come on simultaneously, the electronic brake distribution system is not working. This can result in vehicle instability under sudden braking.

Have your vehicle inspected by a dealer immediately.

If the Electric Power Steering (EPS) System Indicator Comes On



■ Reasons for the indicator to come on

- Comes on when there is a problem with EPS.
- If you depress the accelerator pedal repeatedly to increase the engine speed while the engine is idling, the indicator comes on, and sometimes the steering wheel becomes harder to operate.

■ What to do when the indicator comes on

Stop the vehicle in a safe place and restart the engine.

If the indicator comes on and stays on, immediately have your vehicle inspected by a dealer.

U.S. models

If the Low Tire Pressure/TPMS Indicator Comes On or Blinks



■ Reasons for the indicator to come on or blink

A tire pressure is significantly low. If there is a problem with the TPMS or the compact spare tire is installed, the indicator blinks for about one minute, and then stays on.

■ What to do when the indicator comes on

Stop your vehicle in a safe place. Check the tire pressure and adjust the pressure to the specified level. The specified tire pressure is on a label on the driver side doorjamb.

■ What to do when the indicator blinks

Have the tire inspected by a dealer as soon as possible. If the compact spare tire has triggered the indicator to blink, change the tire to a full size tire. The indicator goes off after a while.

▶▶ If the Low Tire Pressure/TPMS Indicator Comes On or Blinks

NOTICE

Driving on an extremely underinflated tire can cause it to overheat. An overheated tire can fail. Always inflate your tires to the prescribed level.

Fuse Locations

If any electrical devices are not working, set the power mode to VEHICLE OFF (LOCK) and check to see if any applicable fuse is blown.

Fuse locations are shown on the fuse box cover. Locate the fuse in question by the fuse number and box cover number.

Engine Compartment Fuse Box

Located near the brake fluid reservoir. Push the tabs to open the box.

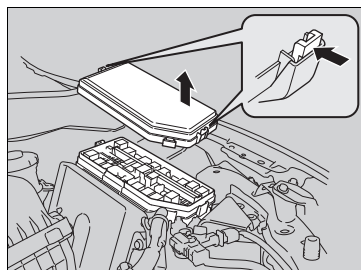

■ Circuit protected and fuse rating

	Circuit Protected	Amps
1	EPS	70 A
	–	–
	ABS/VSA Motor	30 A
	ABS/VSA FSR	30 A
	WIPER	30 A
	Main Fuse	100 A
	IG Main	50 A
2	Fuse Box Main	60 A
	Fuse Box Main 2	60 A
	Headlight Main	30 A
	ST/MG SW	30 A
	Rear Defogger	30 A
	–	–
	Blower	40 A
3	–	–
	Sub Fan Motor	20 A
	Main Fan Motor	20 A
4	–	–
5	Starter DIAG, ST MG	7.5 A
6	–	–
7	–	–
8	–	–
9	–	–
10	–	–

	Circuit Protected	Amps
11	Oil Level	7.5 A
12	Fog Lights*	(20 A)
13	–	–
14	Hazard	10 A
15	FI Sub	15 A
16	IG Coil	15 A
17	Stop	15 A
18	Horn	10 A
19	–	–
20	Right Headlight Low Beam* ¹	10 A
	Right Headlight Low Beam (HID)* ²	15 A
21	IGP	15 A
22	DBW	15 A
23	Left Headlight Low Beam* ¹	10 A
	Left Headlight Low Beam (HID)* ²	15 A
24	–	–
25	MG Clutch	7.5 A
26	WASHER	15 A
27	SMALL	20 A
28	Interior Lights	7.5 A
29	Backup	10 A

*1: Models with halogen bulb low beam headlights

*2: Models with discharge headlights

Interior Fuse Box

Located under the dashboard.

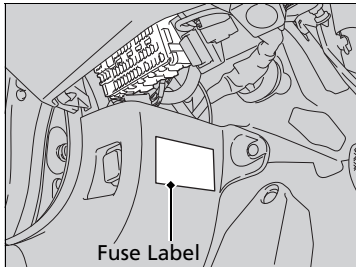

Fuse locations are shown on the label on the side panel.

Locate the fuse in question by the fuse number and label number.

Circuit protected and fuse rating

	Circuit Protected	Amps
1	–	–
2	ACG	15 A
3	SRS	10 A
4	Fuel Pump	15 A
5	Meter	7.5 A
6	Power Window	7.5 A
7	VB SOL*	7.5 A
8	Door Lock Motor 2 (Unlock)	15 A
9	Door Lock Motor 1 (Unlock)	15 A

	Circuit Protected	Amps
10	–	–
11	Moonroof*	20 A
12	Driver's Power Seat Sliding*	(20 A)
13	Driver's Power Seat Reclining*	(20 A)
14	Seat Heaters*	(15 A)
15	Driver's Door Lock Motor (Unlock)	10 A
16	–	–
17	–	–
18	–	–
19	ACC	7.5 A
20	ACC Key Lock	7.5 A
21	Daytime Running Lights	7.5 A
22	HAC	7.5 A
23	–	–
24	ABS/VSA	7.5 A
25	ACC	7.5 A
26	–	–
27	Accessory Power Socket	20 A
28	–	–
29	ODS	7.5 A
30	Driver's Door Lock Motor (Lock)	10 A
31	SMART	10 A
32	Door Lock Motor 2 (Lock)	15 A
33	Door Lock Motor 1 (Lock)	15 A

	Circuit Protected	Amps
34	Small Lights	7.5 A
35	Illumination	7.5 A
36	–	–
37	Premium Audio*	(20 A)
38	Left Headlight High Beam	10 A
39	Right Headlight High Beam	10 A
40	TPMS*	(7.5 A)
41	Door Lock	20 A
42	Driver's Power Window	20 A
43	Rear Passenger's Side Power Window	20 A
44	Front Passenger's Side Power Window	20 A
45	Rear Driver's Side Power Window	20 A
46	–	–

* Not available on all models

Inspecting and Changing Fuses

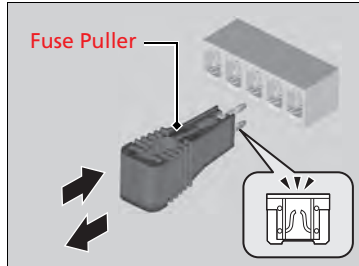
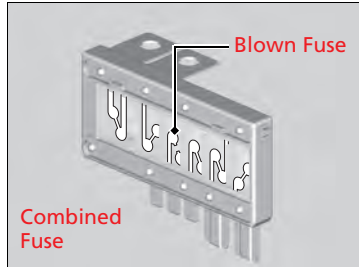

1. Set the power mode to VEHICLE OFF (LOCK). Turn headlights and all accessories off.
2. Remove the fuse box cover.
3. Check the large fuse in the engine compartment.
 - If the fuse is blown, use a Phillips-head screwdriver to remove the screw and replace it with a new one.
4. Inspect the small fuses in the engine compartment and the vehicle interior.
 - If there is a burned out fuse, remove it with the fuse puller and replace it with a new one.

Inspecting and Changing Fuses

NOTICE

Replacing a fuse with one that has a higher rating greatly increases the chances of damaging the electrical system.

Replace fuse with a spare fuse of the same specified amperage.

Confirm the specified amperage using the charts on P. [324](#) to [325](#).

There is a fuse puller on the back of the engine compartment fuse box cover.

Call a professional towing service if you need to tow your vehicle.

■ Flat bed equipment

The operator loads your vehicle on the back of a truck.

This is the best way to transport your vehicle.

■ Wheel lift equipment

The tow truck uses two pivoting arms that go under the front tires and lift them off the ground. The rear tires remain on the ground. **This is an acceptable way to tow your vehicle.**

» Emergency Towing

NOTICE

Trying to lift or tow your vehicle by the bumpers will cause serious damage. The bumpers are not designed to support the vehicle's weight.

NOTICE

Improper towing such as towing behind a motorhome or other motor vehicle can damage the transmission.

Never tow your vehicle with just a rope or chain. It is very dangerous, since ropes or chains may shift from side to side or break.

Information

This chapter includes your vehicle's specifications, locations of identification numbers, and other information required by regulation.



- Specifications** 330
- Identification Numbers**
 - Vehicle Identification Number (VIN)..... 334
 - Engine Number and Transmission Number..... 334
- Devices that Emit Radio Waves** 335
- Reporting Safety Defects** 336
- Emissions Testing**
 - Testing of Readiness Codes..... 337
- Warranty Coverages** 339
- Authorized Manuals** 341
- Client Service Information** 342

2.0 ℓ engine models

Vehicle Specifications

Model	Acura ILX
No. of Passengers:	
Front	2
Rear	3
Total	5
Weights:	
Gross Vehicle Weight Rating	3,968 lbs (1,800 kg)
Gross Axle Weight Rating (Front)	2,138 lbs (970 kg)
Gross Axle Weight Rating (Rear)	1,874 lbs (850 kg)
Air Conditioning:	
Refrigerant Type	HFC-134a (R-134a)
Charge Quantity	13.2 – 15.0 oz (375 – 425 g)
Lubricant Type	SP-10

Engine Specifications

Displacement	122 cu-in (1,997 cm ³)	
Spark Plugs	NGK	DILZKR7B11GS
	DENSO	DXU22HCR-D11S

Fuel

Fuel Type	Unleaded gasoline, Pump octane number of 91 or higher
Fuel Tank Capacity	13.2 US gal (50 ℓ)

Battery

Capacity/Type	38AH(5)/47AH(20)
---------------	------------------

Washer Fluid

Tank Capacity	U.S.: 2.6 US qt (2.5 ℓ)
	Canada: 5.12 US qt (4.85 ℓ)

Light Bulbs

Headlights (Low Beam)	35W (D2S) ^{*1}
	55W (H11) ^{*2}
Headlights (High Beam)	60W (HB3)
Fog Lights ^{*3}	55W (H11)
Front Turn Signal Lights	21W
Parking/Side Marker Lights	5W
Brake/Rear Side Marker/Taillight	21/5W
Back-Up Lights	16W
Rear Turn Signal Lights	21W
High-Mount Brake Light	LED
Rear License Plate Light	5W
Trunk Light	5W
Interior Lights	
Map Lights	LED
Ceiling Light	8W
Foot light	1.4W
Glove Box light	LED
Vanity Mirror light	2W

*1: Vehicle with discharge headlights

*2: Vehicle with halogen bulb low beam headlights

*3: Not available on all models

■ Brake Fluid

Specified	Honda Heavy Duty Brake Fluid DOT 3
-----------	------------------------------------

■ Automatic Transmission Fluid

Specified	Acura ATF DW-1 (automatic transmission fluid)
Capacity	Change 2.6 US qt (2.5 ℓ)

■ Engine Oil

Recommended	-Genuine Acura Motor Oil 0W-20
	-API Premium-grade 0W-20 detergent oil
Change	3.7 US qt (3.5 ℓ)
Capacity	Change
	including filter 3.9 US qt (3.7 ℓ)

■ Engine Coolant

Specified	Honda Long-Life Antifreeze/Coolant Type2
Ratio	50/50 with distilled water
Capacity	1.41 US gal (5.33 ℓ)
	(change including the remaining 0.125 US gal (0.475 ℓ) in the reserve tank)

■ Tire

Regular	Size	P215/45R17 87V
	Pressure psi (kPa [kgf/cm ²])	33 (230 [2.3])
Compact Spare	Size	T135/80D15 99M
	Pressure psi (kPa [kgf/cm ²])	60 (420 [4.2])
Wheel Size	Regular	17 x 7J
	Compact Spare	15 x 4T

2.4 ℓ engine models

■ Vehicle Specifications

Model	Acura ILX
No. of Passengers:	
Front	2
Rear	3
Total	5
Weights:	
Gross Vehicle Weight Rating	3,968 lbs (1,800 kg)
Gross Axle Weight Rating (Front)	2,138 lbs (970 kg)
Gross Axle Weight Rating (Rear)	1,918 lbs (870 kg)
Air Conditioning:	
Refrigerant Type	HFC-134a (R-134a)
Charge Quantity	13.2 – 15.0 oz (375 – 425 g)
Lubricant Type	SP-10

■ Engine Specifications

Displacement	144 cu-in (2,354 cm ³)
Spark Plugs	NGK ILZKR7B-11S
	DENSO SXU22HCR11S

■ Fuel

Fuel Type	Unleaded gasoline, Pump octane number of 91 or higher
Fuel Tank Capacity	13.2 US gal (50 ℓ)

■ Battery

Capacity/Type	38AH(5)/47AH(20)
---------------	------------------

■ Washer Fluid

Tank Capacity	U.S.: 2.6 US qt (2.5 ℓ) Canada: 5.12 US qt (4.85 ℓ)
---------------	--

■ Light Bulbs

Headlights (Low Beam)	35W (D2S)
Headlights (High Beam)	60W (HB3)
Fog Lights	55W (H11)
Front Turn Signal Lights	21W
Parking/Side Marker Lights	5W
Brake/Rear Side Marker/Taillight	21/5W
Back-Up Lights	16W
Rear Turn Signal Lights	21W
High-Mount Brake Light	LED
Rear License Plate Light	5W
Trunk Light	5W
Interior Lights	
Map Lights	LED
Ceiling Light	8W
Foot light	1.4W
Glove Box light	LED
Vanity Mirror light	2W

■ Brake/Clutch Fluid

Specified	Honda Heavy Duty Brake Fluid DOT 3
-----------	------------------------------------

■ Manual Transmission Fluid

Specified	Acura Manual Transmission Fluid
Capacity	Change 2.0 US qt (1.9 ℓ)

■ Engine Oil

Recommended	-Genuine Acura Motor Oil 0W-20
	-API Premium-grade 0W-20 detergent oil
Capacity	Change 4.2 US qt (4.0 ℓ)
	Change including filter 4.4 US qt (4.2 ℓ)

■ Engine Coolant

Specified	Honda Long-Life Antifreeze/Coolant Type2
Ratio	50/50 with distilled water
Capacity	1.45 US gal (5.5 ℓ)
	(change including the remaining 0.125 US gal (0.475 ℓ) in the reserve tank)

■ Tire

Regular	Size	P215/45R17 87V
	Pressure psi (kPa [kgf/cm ²])	33 (230 [2.3])
Compact Spare	Size	T135/80D16 101M
	Pressure psi (kPa [kgf/cm ²])	60 (420 [4.2])
Wheel Size	Regular	17 x 7J
	Compact Spare	16 x 4T

Vehicle Identification Number (VIN)

Your vehicle has a 17-digit vehicle identification number (VIN) used to register your vehicle for warranty purposes, and for licensing and insuring your vehicle. See the image below for the VIN locations.

Engine Number and Transmission Number

See the image below for the locations of your vehicle's engine number and transmission number.

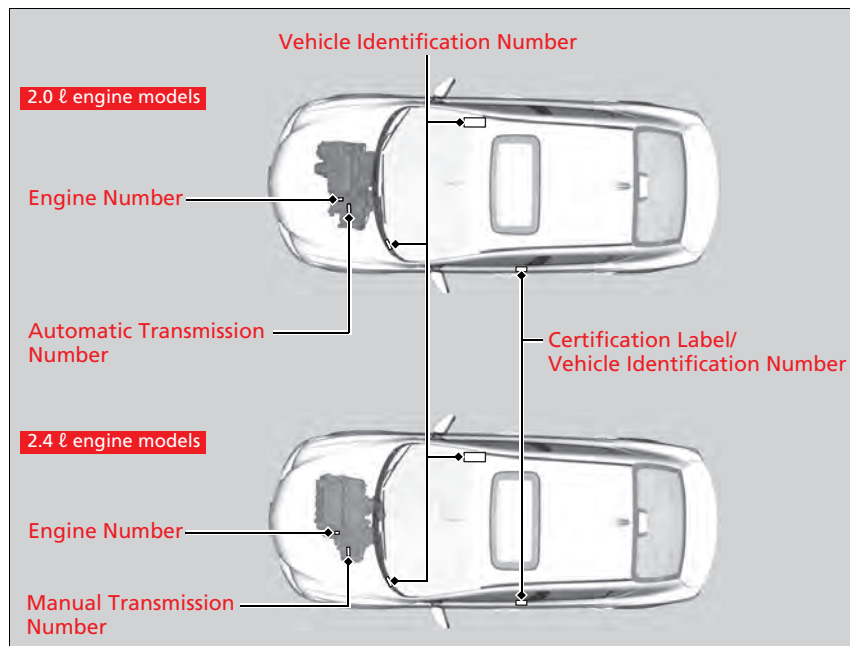

Vehicle Identification Number (VIN)

The interior vehicle identification number (VIN) is located under the cover.

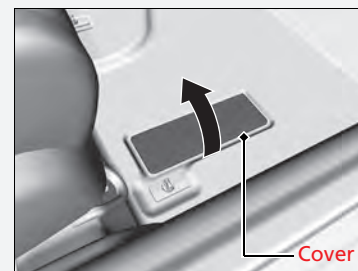

QRG

The following products and systems on your vehicle emit radio waves when in operation.

U.S. AcuraLink

Audio System

Bluetooth® Audio

Bluetooth® HandsFreeLink®

HomeLink® Universal Transceiver

Immobilizer System

Keyless Access System

U.S. models only

Tire Pressure Monitoring System (TPMS)

Each of the above complies with the appropriate requirements or the required standards of FCC (Federal Communications Commission) and Industry Canada Standard, described below:

As required by the FCC:

This device complies with Part 15 of the FCC rules. Operation is subject to the following two conditions: (1) This device may not cause harmful interference, and (2) this device must accept any interference received, including interference that may cause undesired operation.

Changes or modifications not expressly approved by the party responsible for compliance could void the user's authority to operate the equipment.

This device complies with Industry Canada Standard RSS-Gen/210/310. Operation is subject to the following two conditions: (1) this device may not cause interference, and (2) this device must accept any interference, including interference that may cause undesired operation of the device.

TOC

Information

TOC

Index

Home

In the U.S.

If you believe that your vehicle has a defect which could cause a crash or could cause injury or death, you should immediately inform the National Highway Traffic Safety Administration (NHTSA) in addition to notifying American Honda Motor Co., Inc.

If NHTSA receives similar complaints, it may open an investigation, and if it finds that a safety defect exists in a group of vehicles, it may order a recall and remedy campaign. However, NHTSA cannot become involved in individual problems between you, your dealer, or American Honda Motor Co., Inc.

To contact NHTSA, you may call the Vehicle Safety Hotline toll-free at 1-888-327-4236 (TTY: 1-800-424-9153);

go to <http://www.safercar.gov>

or write to: Administrator, NHTSA,
1200 New Jersey Avenue, SE.,
Washington, DC 20590.

You can also obtain other information about motor vehicle safety from <http://www.safercar.gov>.

In Canada

If you believe that your vehicle has a defect which could cause a crash or could cause injury or death, you should immediately inform Honda Canada Inc. and you may also inform Transport Canada.

If Transport Canada receives similar complaints, it may open an investigation, and if it finds that a safety defect exists in a group of vehicles, it may lead to a recall and remedy campaign. However, Transport Canada cannot become involved in individual problems between you, your dealer, or Honda Canada Inc.

To contact Transport Canada's Defect Investigations and Recalls Division, you may call 1-800-333-0510. For more information on reporting safety defects or about motor vehicle safety, go to <http://www.tc.gc.ca/roadsafety>.

Testing of Readiness Codes

Your vehicle uses “readiness codes,” as part of its onboard self diagnostic system. Some states refer to these codes during testing to see if your vehicle’s emissions components are working properly.

The codes may not be read if you go through the testing just after the battery has gone dead or been disconnected.

To check if they are set, set the power mode to ON, without starting the engine. The malfunction indicator lamp will come on for several seconds. If it then goes off, the readiness codes are set. If it blinks five times, the readiness codes are not set.

If you are required to have your vehicle tested before the readiness codes are ready, prepare the vehicle for retesting by doing the following:

1. Fill the gas tank to approximately 3/4 full.
2. Park the vehicle and leave the engine off for 6 hours or more.
3. Make sure the ambient temperature is between 40°F and 95°F (4°C and 35°C).
4. Start the engine without touching the accelerator pedal, and let it idle for 20 seconds.
5. Keep the vehicle in **P** (automatic transmission) or **N** (manual transmission). Increase the engine speed to 2,000 rpm, and hold it there until the temperature gauge rises to at least 1/4 of the scale (about 3 minutes).
6. Let the engine idle with your foot off the accelerator for 20 seconds.

Testing of Readiness Codes

The readiness codes are erased when the battery is disconnected, and set again only after several days of driving under a variety of conditions.

If a testing facility determines that the readiness codes are not set, you may be requested to return at a later date to complete the test.

If the testing facility determines the readiness codes are still not set, see a dealer.

7. Select a nearby, lightly traveled major highway where you can maintain a speed of 50 to 60 mph (80 to 97 km/h) for at least 20 minutes. Drive on the highway in **D** (automatic) or 5th (manual). Do not use cruise control. When traffic allows, drive for 90 seconds without moving the accelerator pedal. (Vehicle speed may vary slightly; this is okay.) If you cannot do this for a continuous 90 seconds because of traffic conditions, drive for at least 30 seconds, then repeat it two more times (for a total of 90 seconds).
8. Drive in city/suburban traffic for at least 10 minutes. When traffic conditions allow, let the vehicle coast for several seconds without using the accelerator pedal or the brake pedal.
9. Park the vehicle and leave the engine off for 30 minutes.

■ U.S. Owners

Your new vehicle is covered by these warranties:

New Vehicle Limited Warranty – covers your new vehicle, except for the emissions control systems and accessories, against defects in materials and workmanship.

Emissions Control Systems Defects Warranty and Emissions Performance Warranty – these two warranties cover your vehicle's emissions control systems. Time, mileage, and coverage are conditional. Please read your warranty booklet for exact information.

Seat Belt Limited Warranty – a seat belt that fails to function properly is covered by a limited warranty. Please read your warranty booklet for details.

Rust Perforation Limited Warranty – all exterior body panels are covered for rust-through from the inside for the specified time period with no mileage limit.

Accessory Limited Warranty – Acura accessories are covered under this warranty. Time and mileage limits depend on the type of accessory and other factors. Please read your warranty booklet for details.

Replacement Parts Limited Warranty – covers all Acura replacement parts against defects in materials and workmanship.

Replacement Battery Limited Warranty – provides prorated coverage for a replacement battery purchased from a dealer.

Replacement Muffler Lifetime Limited Warranty – provides coverage for as long as the purchaser of the muffler owns the vehicle.

Restrictions and exclusions apply to all these warranties. Please read the Acura warranty information booklet that came with your vehicle for precise information on warranty coverages. Your vehicle's original tires are covered by their manufacturer. Tire warranty information is in a separate booklet.

■ **Canadian Owners**

Please refer to the warranty manual that came with your vehicle.

■ Service Express

For electronic copies of service publications, you can purchase a subscription to Service Express. Visit www.techinfo.honda.com for pricing and options.

■ For U.S. Owners:

Manuals can be purchased from Helm Incorporated. You can order a manual by phone at (800) 782-4356 (credit card orders only), or online at www.helminc.com.

» Authorized Manuals

For Canadian Owners:

Please contact a dealer to order any manuals that you may require.

Acura dealership personnel are trained professionals.

They should be able to answer all your questions. If you encounter a problem that your dealership does not solve to your satisfaction, please discuss it with the dealership's service manager or general manager. If you are dissatisfied with the decision made by the dealership's management, contact Acura Client Relations/Services.

U.S. Owners:

American Honda Motor Co., Inc.
Acura Client Relations
Mail Stop 500-2N-7E 1919 Torrance Blvd.
Torrance, CA 90501-2746
Tel: (800) 382-2238

Canadian Owners:

Honda Canada Inc.
Acura Client Services
180 Honda Boulevard
Markham, ON
L6C 0H9
Tel: 1-888-9-ACURA-9
Fax: 1-877-939-0909
E-mail: acura_cr@ch.honda.com

In Puerto Rico and the U.S. Virgin Islands:

Bella International
P.O. Box 190816
San Juan, PR 00919-0816
Tel: (787) 620-7546

Client Service Information

When you call or write, please give us the following information:

- Vehicle Identification Number
 - **Vehicle Identification Number (VIN)**
P. 334
- Date of purchase
- Odometer reading of your vehicle
- Your name, address, and telephone number
- A detailed description of the problem
- Name of the dealer who sold the vehicle to you

QRG

A

ABS (Anti-lock Brake System)..... 239

Accessories and Modifications 246

Accessory Power Sockets 134

Additives

 Coolant 268

 Engine Oil 261

 Washer 273

Additives, Engine Oil 261

Adjusting

 Armrest 130

 Front Seats..... 123

 Head Restraints..... 126

 Mirrors..... 121

 Rear Seat 129

 Steering Wheel 120

 Temperature 81

Air Conditioning System (Climate Control System)..... 136

 Changing the Mode..... 136

 Defrosting the Windshield and Windows 137

 Dust and Pollen Filter 297

 Recirculation/Fresh Air Mode..... 136

 Sensors..... 139

 Synchronized Mode 138

 Using Automatic Climate Control..... 136

Air Pressure 287, 331, 333

Airbags 33

 Advanced Airbags..... 39

 After a Collision 37

 Airbag Care..... 47

 Event Data Recorder 19

 Front Airbags (SRS) 36

 Indicator 44, 67, 71

 Passenger Airbag Off Indicator 45

 Sensors..... 33

 Side Airbag Cutoff System 42

 Side Airbag Off Indicator 46

 Side Airbags 40

 Side Curtain Airbags..... 43

AM/FM Radio 151

Anti-lock Brake System (ABS) 239

 Indicator 67

Armrest 130

Audio Remote Controls..... 149

Audio System 142

 Adjusting the Sound 150

 Auxiliary Input Jack..... 143

 Error Messages 170

 General Information 173

 iPhone® 176

 iPod® 158

 MP3/WMA/AAC 163

 Pandora® 161

 Reactivating..... 144

 Recommended CDs 174

 Recommended Devices 176

 Security Code 144

 Theft Protection..... 144

 USB Adapter Cable..... 143

 USB Flash Drives 176

Audio/Information Screen 146

Authorized Manuals 341

Auto Door Locking/Unlocking..... 101

 Customize..... 86

Automatic Lighting 115

Automatic Transmission..... 221

 Creeping 221

 Fluid..... 270

 Kickdown..... 221

 Operating the Shift Lever..... 13, 223

 Shift Lever Does Not Move 317

 Shifting 222

Auxiliary Input Jack..... 143

Average Fuel Economy 81

Average Speed 82

B

Battery 295

 Charging System Indicator..... 65, 320

 Jump Starting..... 314

 Maintenance (Checking the Battery)..... 295

 Maintenance (Replacing) 296

Belts (Seat) 26

Beverage Holders 133

Bluetooth® Audio 166

Bluetooth® HandsFreeLink® 179

Booster Seats (For Children) 59



Brake System	237
Anti-lock Brake System (ABS).....	239
Brake Assist System	240
Fluid	272
Foot Brake	238
Indicator.....	64, 322
Parking Brake	237
Brightness Control (Instrument Panel)	119
Bulb Replacement	274
Back-Up Light Bulbs.....	282
Brake Light, Taillight, Rear Turn Signal Light and Rear Side Marker Light Bulbs ..	280
Fog Lights.....	276
Front Turn Signal Light Bulbs	278
Headlights	274
High-Mount Brake Light	283
Parking/Side Marker Light Bulbs.....	279
Rear License Plate Light.....	283
Bulb Specifications	330, 332

C

Carbon Monoxide Gas	60
Carrying Cargo	211, 213
CD Player	153, 155
Certification Label	334
Changing Bulbs	274
Charging System Indicator	65, 320
Child Safety	48
Childproof Door Locks.....	100

Child Seat	48
Booster Seats	59
Child Seat for Infants.....	50
Child Seat for Small Children.....	51
Installing a Child Seat with a Lap/Shoulder Seat Belt.....	55
Larger Children	58
Rear-facing Child Seat	50
Selecting a Child Seat.....	52
Using a Tether.....	57
Childproof Door Locks	100
Cleaning the Exterior	300
Cleaning the Interior	298
Client Service Information	342
Climate Control System	136
Changing the Mode	136
Defrosting the Windshield and Windows.....	137
Dust and Pollen Filter.....	297
Recirculation/Fresh Air Mode.....	136
Sensors	139
Synchronized Mode.....	138
Using Automatic Climate Control	136
Clock	92
Clutch Fluid	272
Coat Hook	134
Compact Spare Tire	305, 331, 333
Console Compartment	132
Controls	91
Coolant (Engine)	268
Adding to the Radiator.....	269

Adding to the Reserve Tank	268
Overheating.....	318
Creeping (Automatic Transmission)	221
Cruise Control	229
Indicator	72
Cup Holders	133
Customized Features	83

D

Daytime Running Lights	117
Dead Battery	314
Defrosting the Windshield and Windows	137
Devices that Emit Radio Waves	335
Dimming	
Headlights	114
Rearview Mirror	121
Dipstick (Engine Oil)	262
Directional Signals (Turn Signal)	114
Door Mirrors	122
Doors	93
Auto Door Locking.....	101
Auto Door Unlocking	101
Door Open Indicator	25, 69
Keys.....	93
Locking/Unlocking the Doors from the Inside.....	99
Locking/Unlocking the Doors from the Outside.....	95
Lockout Prevention System	98

DOT Tire Quality Grading.....	289
Driving	209
Automatic Transmission	221
Braking	237
Cruise Control	229
Shifting Gear	222, 226
Starting the Engine	216
Dust and Pollen Filter	297

E

Elapsed Time	81
Electric Power Steering System (EPS) Indicator	68, 322
Electronic Stability Control (ESC)	232
Emergency	327
Emissions Testing (Readiness Codes)	337
Engine	334
Coolant	268
Jump Starting	314
Oil	261
Starting.....	216
Switch Buzzer	112
Engine Compartment Cover.....	259
Engine Coolant	268
Adding to the Radiator	269
Adding to the Reserve Tank	268
Overheating.....	318
Temperature Gauge.....	78
Engine Oil.....	261
Adding	264

Checking.....	262
Displaying Oil Life	252
Low Oil Pressure Indicator.....	64, 320
Recommended Engine Oil.....	261
ENGINE START/STOP Button	112
EPS (Electric Power Steering) System	68, 322
Exhaust Gas Hazard (Carbon Monoxide) ..	60
Expanded View Driver's Mirror	122
Exterior Care (Cleaning).....	300
Exterior Mirrors	122

F

Features.....	141
Filters	
Dust and Pollen	297
Oil	265
Flat Tire	305
Floor Mats	299
Fluids	
Automatic Transmission.....	270
Brake/Clutch.....	272
Engine Coolant.....	268
Manual Transmission	271
Windshield Washer.....	273
Fog Light Indicator	70
Folding Down the Rear Seat	129
Foot Brake.....	238
Front Airbags (SRS).....	36

Front Seats	123
Adjusting	123
Fuel.....	14, 243
Economy	245
Gauge.....	78
Instant Fuel Economy	81
Low Fuel Indicator	67
Range	81
Recommendation	243
Refueling.....	243
Fuel Economy	245
Fuel Fill Cap	14, 244
Message.....	321
Fuel Fill Door	14, 244
Fuses.....	324
Inspecting and Changing.....	326
Locations.....	324, 325

G

Gasoline (Fuel)	
Economy	245
Gauge.....	78
Information	243
Instant Fuel Economy	81
Low Fuel Indicator	67
Refueling.....	243
Gauges	78
Gear Shift Lever Positions	
Automatic Transmission	222
Manual Transmission.....	227

Glass (care)	301
Glove Box	132

H

Halogen Bulbs	274, 276
Handling the Unexpected	303
HandsFreeLink® (HFL)	179
Automatic Import of Cellular Phonebook and Call History	195
Automatic Transferring	193
Caller's ID Information	193
HFL Buttons	179
HFL Menus	181
HFL Status Display	180
Making a Call	198
Options During a Call	202
Phone Setup	186
Receiving a Call	201
Speed Dial	196
Text Message	191, 203
To Clear the System	194
To Create a Security PIN	192
Hazard Warning Button	2
Head Restraints	126
Headlights	114
Aiming	274
Automatic Operation	115
Dimming	114, 117
Operating	114
Heaters (Seat)	135

HFL (HandsFreeLink®)	179
High-Beam Indicator	70
Hill Start Assist System	219
HomeLink® Universal Transceiver	177

I

Identification Numbers	334
Engine and Transmission	334
Vehicle Identification	334
Illumination Control	119
Knob	119
Immobilizer System	106
Indicator	71
Indicators	64
ABS (Anti-lock Brake System)	67
Charging System	65, 320
CRUISE CONTROL	72, 230
CRUISE MAIN	72, 229
Door and Trunk Open	25, 69
Electric Power Steering (EPS) System ..	68, 322
Fog Light	70
High-Beam	70
Immobilizer System	71
Keyless Access System	72
Lights On	70
Low Fuel	67
Low Oil Pressure	64, 320
Low Tire Pressure/TPMS	69, 234, 235
Maintenance Minder	251
Malfunction Indicator Lamp	65, 321

Parking Brake and Brake System	64, 322
Seat Belt Reminder	27, 66
Security System Alarm	72
Shift Lever Position	65
Side Airbag Off	46, 71
Supplemental Restraint System	44, 67
System Message	70
Transmission	66
Turn Signal	70
VSA® (Vehicle Stability Assist) System	68, 232
VSA® OFF	68, 233
Information	329
Information Buttons	79, 83
Instant Fuel Economy	81
Instrument Panel	63
Brightness Control	119
Interior Lights	131
Interior Rearview Mirror	121
Internet Radio	161
iPhone®	176
iPod®	158

J

Jack (Wheel Nut Wrench)	308
Jump Starting	314

K

Key Number Tag	94
----------------------	----

QRG

Keyless Access System	96
Keyless Lockout Prevention.....	98
Keys.....	93
Lockout Prevention	98
Number Tag.....	94
Rear Door Won't Open	100
Remote Transmitter	95
Types and Functions.....	93
Won't Turn	17
Kickdown (Automatic Transmission)	221

L

Language (HFL)	180
LATCH (Child Seats)	53
Lights	114, 274
Automatic.....	115
Bulb Replacement.....	274
Daytime Running Lights	117
Fog Lights	117
High-Beam Indicator	70
Interior.....	131
Light Switches.....	114
Lights On Indicator.....	70
Turn Signals.....	114
Limitations for Manual Operation.....	180
Load Limits	213
Locking/Unlocking	93
Auto Door Locking/Unlocking	101
Childproof Door Locks	100
From Inside	99

From Outside.....	95
Keys	93
Using a Key	98
Lockout Prevention System.....	98
Low Battery Charge.....	320
Low Fuel Indicator	67
Low Keyless Access Remote Signal Strength	94
Low Oil Pressure Indicator	64, 320
Lower Anchors.....	53
Lubricant Specifications Chart	330, 332
Luggage (Maximum Load Limit)	213

M

Maintenance	247
Battery	295
Brake/Clutch Fluid	272
Cleaning.....	298
Climate Control System	297
Coolant	268
Maintenance Minder™	251
Oil	262
Precautions.....	248
Radiator	269
Remote Transmitter	296
Replacing Light Bulbs.....	274
Safety.....	249
Service Items	254
Tires	286
Transmission Fluid	270

Under the Hood	256
Malfunction Indicator Lamp.....	65, 321
Manual Transmission	226
Map Lights	131
Maximum Load Limit	213
Meters, Gauges.....	78
Mirrors	121
Adjusting	121
Door	122
Exterior	122
Interior Rearview	121
Modifications (and Accessories)	246
Moonroof	111
MP3	155, 163
Multi-Information Display	79
Multi-View Rear Camera.....	242

N

Numbers (Identification).....	334
-------------------------------	-----

O

Odometer	80
Oil (Engine).....	261
Adding.....	264
Checking.....	262
Displaying Oil Life.....	252
Low Oil Pressure Indicator	64, 320
Recommended Engine Oil	261
Viscosity.....	261

Opening/Closing	
Hood.....	258
Moonroof.....	111
Power Windows.....	108
Trunk.....	102
Operating the Switches Around the Steering Wheel.....	112
Outside Temperature	
Adjusting.....	81
Overheating.....	318

P Q

Paddle Shifters (Sequential Shift Mode)...	13
Pandora®.....	161
Panic Mode.....	107
Parking.....	241
Parking Brake.....	237
Parking Brake and Brake System	
Indicator.....	64, 322
Passenger Airbag Off Indicator.....	45
Passing Indicators.....	114
Power Windows.....	108
Precautions While Driving.....	220
Rain.....	220
Pregnant Women.....	31
Puncture (Tire).....	305

R

Radiator.....	269
---------------	-----

Radio (AM/FM).....	151
Radio (XM®).....	153
Radio Data System (RDS).....	152
Range.....	81
RDS (Radio Data System).....	152
Readiness Codes (Emissions Testing).....	337
Rear Defogger/Heated Door Mirror	
Button.....	120
Rear Seat (Folding Down).....	129
Rearview Mirror.....	121
Refueling.....	243
Fuel Gauge.....	78
Gasoline.....	243, 330, 332
Low Fuel Indicator.....	67
Regulations.....	235, 289, 335
Remote Transmitter.....	95
Replacement	
Battery.....	296
Bulbs.....	274
Fuses.....	324, 325
Tires.....	292
Wiper Blade Rubber.....	284
Reporting Safety Defects.....	336
Resetting a Trip Meter.....	80

S

Safe Driving.....	21
Safety Check.....	25
Safety Labels.....	61
Safety Message.....	20

Seat Belts.....	26
Adjusting the Shoulder Anchor.....	30
Automatic Seat Belt Tensioners.....	28
Checking.....	32
Fastening.....	29
Installing a Child Seat with a Lap/Shoulder Seat Belt.....	55
Pregnant Women.....	31
Reminder.....	27
Warning Indicator.....	27, 66
Seat Heaters.....	135
Seats.....	123
Adjusting.....	123
Front Seats.....	123
Rear Seat.....	129
Seat Heaters.....	135
Security System.....	106
Immobilizer System Indicator.....	71
Security System Alarm Indicator.....	72
SEL/RESET Button.....	79
Select Lever.....	13, 222, 226
Operation.....	13, 223, 226
Releasing.....	317
Won't Move.....	317
Selecting a Child Seat.....	52
Selector Knob (Audio).....	145
Sequential Shift Mode.....	224
Sequential Shift Mode Operation.....	225
Setting the Clock.....	92
Shift Lever.....	13, 222, 226
Shift Lever Position Indicator.....	65, 223

QRG

Shifting (Transmission)	222, 226
Shoulder Anchor	30
Side Airbags	40
Cutoff System	42
Off Indicator	42
Side Curtain Airbags	43
SMS Text Message	191, 203
Snow Tires	294
Spare Tire	305, 331, 333
Spark Plugs	330, 332
Specifications	330
Specified Fuel	243, 330, 332
SRS Airbags (Airbags)	36
Starting the Engine	216
Does Not Start	311
Engine Switch Buzzer	112
Jump Starting	314
Steering Wheel	120
Adjusting	120
Stopping	241
Summer Tires	294
Supplemental Restraint System (SRS)	36
Switches (Around the Steering Wheel) ..	2, 3
System Message Indicator	70

T

Temperature	
Outside Temperature	81
Temperature Sensor	139
Text Message	191, 203

Time (Setting)	92
Tire Pressure Monitoring System (TPMS)	234
Indicator	69, 323
Tires	286
Air Pressure	287, 331, 333
Checking and Maintaining	286
Inspection	286
Labeling	287
Puncture (Flat Tire)	305
Regulations	289
Rotation	293
Spare Tire	305, 331, 333
Summer	294
Tire Chains	294
Wear Indicators	291
Winter	294
Tools	304
Towing a Trailer	215
Towing Your Vehicle	215
Emergency	327
TPMS (Tire Pressure Monitoring System)	234
Indicator	69, 323
Transmission	222, 226
Automatic	222
Fluid	270, 271
Manual	226
Number	334
Sequential Shift Mode	224
Shift Lever Position Indicator	65, 223

Trip Meter	80
Troubleshooting	303
Blown Fuse	324, 325
Brake Pedal Vibrates	17
Buzzer Sounds When Opening Door	18
Emergency Towing	327
Engine Won't Start	311
Noise When Braking	18
Overheating	318
Premium Gasoline	243, 330, 332
Puncture/Flat Tire	305
Rear Door Won't Open	17, 100
Select Lever Won't Move	317
Warning Indicators	64
Trunk	102
Lid	102
Light Bulb	330, 332
Turn Signals	114
Indicators (Instrument Panel)	70

U

Unlocking the Doors	95
Unlocking the Front Doors from the Inside	10, 99
USB Adapter Cable	142, 143
USB Flash Drives	176
Using the Keyless Access System	96

V

Vanity Mirrors	5
Vehicle Identification Number	334
Vehicle Stability Assist (VSA®)	232
Off Button	233
Off Indicator	68
System Indicator	68
Viscosity (Oil)	261, 331, 333
VSA® (Vehicle Stability Assist)	232

W

Wallpaper	147
Wallpaper Setup	168
Warning and Information Messages	73
Warning Indicator On/Blinking	320
Warning Labels	61
Warranties (Warranty Manual provided separately)	339
Watts	330, 332
Wear Indicators (Tire)	291
Wheel Nut Wrench (Jack Handle)	308
Window Washers	118
Adding/Refilling Fluid	273
Switch	118
Windows (Opening and Closing)	108
Windshield	118
Cleaning	301
Defrosting/Defogging	137
Washer Fluid	273
Wiper Blades	284

Wipers and Washers	118
Winter Tires	294
Snow Tires	294
Tire Chains	294
Wipers and Washers	118
Checking and Replacing Wiper Blades	284
WMA	155, 163
Worn Tires	286

X Y Z

XM® Radio	153
-----------------	-----