

2014 MDX

Online Reference Owner's Manual

This owner's manual should be considered a permanent part of the vehicle and should remain with the vehicle when it is sold.





This owner's manual covers all models of your vehicle. You may find descriptions of equipment and features that are not on your particular model.

Images throughout this owner's manual (including the front cover) represent features and equipment that are available on some, but not all, models. Your particular model may not have some of these features.

This owner's manual is for vehicles sold in the United States and Canada.

The information and specifications included in this publication were in effect at the time of approval for printing. Honda Motor Co., Ltd. reserves the right, however, to discontinue or change specifications or design at any time without notice and without incurring any obligation.

Navigation Key

-  Quick Reference Guide
-  Chapter Table of Contents
-  Index
-  Book Table of Contents

➤ Safe Driving P. 25

For Safe Driving P. 26 Seat Belts P. 31 Airbags P. 39

➤ Instrument Panel P. 69

Indicators P. 70 Gauges and Multi-Information Display (MID) P. 97

➤ Controls P. 113

Clock P. 114 Locking and Unlocking the Doors P. 115
 Opening and Closing the Moonroof P. 140
 Adjusting the Seats P. 161

➤ Features P. 197

Audio System P. 198 Audio System Basic Operation P. 203
 Customized Features P. 248 HomeLink® Universal Transceiver P. 266

➤ Driving P. 303

Before Driving P. 304 Towing a Trailer P. 309
 Parking Your Vehicle P. 377 Multi-View Rear Camera* P. 382

➤ Maintenance P. 387

Before Performing Maintenance P. 388 Maintenance Minder™ P. 391
 Checking and Maintaining Wiper Blades P. 413
 Climate Control System Maintenance P. 431 Cleaning P. 432

➤ Handling the Unexpected P. 437

Tools P. 438 If a Tire Goes Flat P. 439
 Overheating P. 463 Indicator, Coming On/Blinking P. 465
 When You Cannot Open the Tailgate P. 477

➤ Information P. 479

Specifications P. 480 Identification Numbers P. 482
 Emissions Testing P. 485 Warranty Coverages P. 487

Contents

2014 MDX

Child Safety [P. 54](#)

Exhaust Gas Hazard [P. 66](#)

Safety Labels [P. 67](#)

Opening and Closing the Tailgate [P. 128](#) Security System [P. 135](#)
Operating the Switches Around the Steering Wheel [P. 141](#)
Interior Lights/Interior Convenience Items [P. 172](#)

Opening and Closing the Windows [P. 138](#)
Adjusting the Mirrors [P. 158](#)
Climate Control System [P. 185](#)

Audio Error Messages [P. 239](#)
Bluetooth® HandsFreeLink® [P. 268](#)

General Information on the Audio System [P. 244](#)
Compass* [P. 301](#)

Off-Highway Driving Guidelines [P. 320](#)
Refueling [P. 383](#)

When Driving [P. 322](#)
Fuel Economy [P. 385](#)

Braking [P. 367](#)
Accessories and Modifications [P. 386](#)

Maintenance Under the Hood [P. 395](#)
Checking and Maintaining Tires [P. 417](#)

Replacing Light Bulbs [P. 407](#)
Battery [P. 426](#)

Remote Transmitter Care [P. 427](#)

Engine Does Not Start [P. 457](#)
Fuses [P. 469](#)

Jump Starting [P. 460](#) Shift Lever Does Not Move [P. 462](#)
Emergency Towing [P. 475](#) When You Cannot Unlock the Fuel Fill Door [P. 476](#)

Devices that Emit Radio Waves [P. 483](#)
Authorized Manuals [P. 489](#)

Reporting Safety Defects [P. 484](#)
Client Service Information [P. 490](#)

* Not available on all models

Quick Reference Guide [P. 2](#)

Safe Driving [P. 25](#)

Instrument Panel [P. 69](#)

Controls [P. 113](#)

Features [P. 197](#)

Driving [P. 303](#)

Maintenance [P. 387](#)

Handling the Unexpected [P. 437](#)

Information [P. 479](#)

Index [P. 491](#)

Navigation Key

QRG Quick Reference Guide

Index Index

TOC Chapter Table of Contents

Home Book Table of Contents

Visual Index

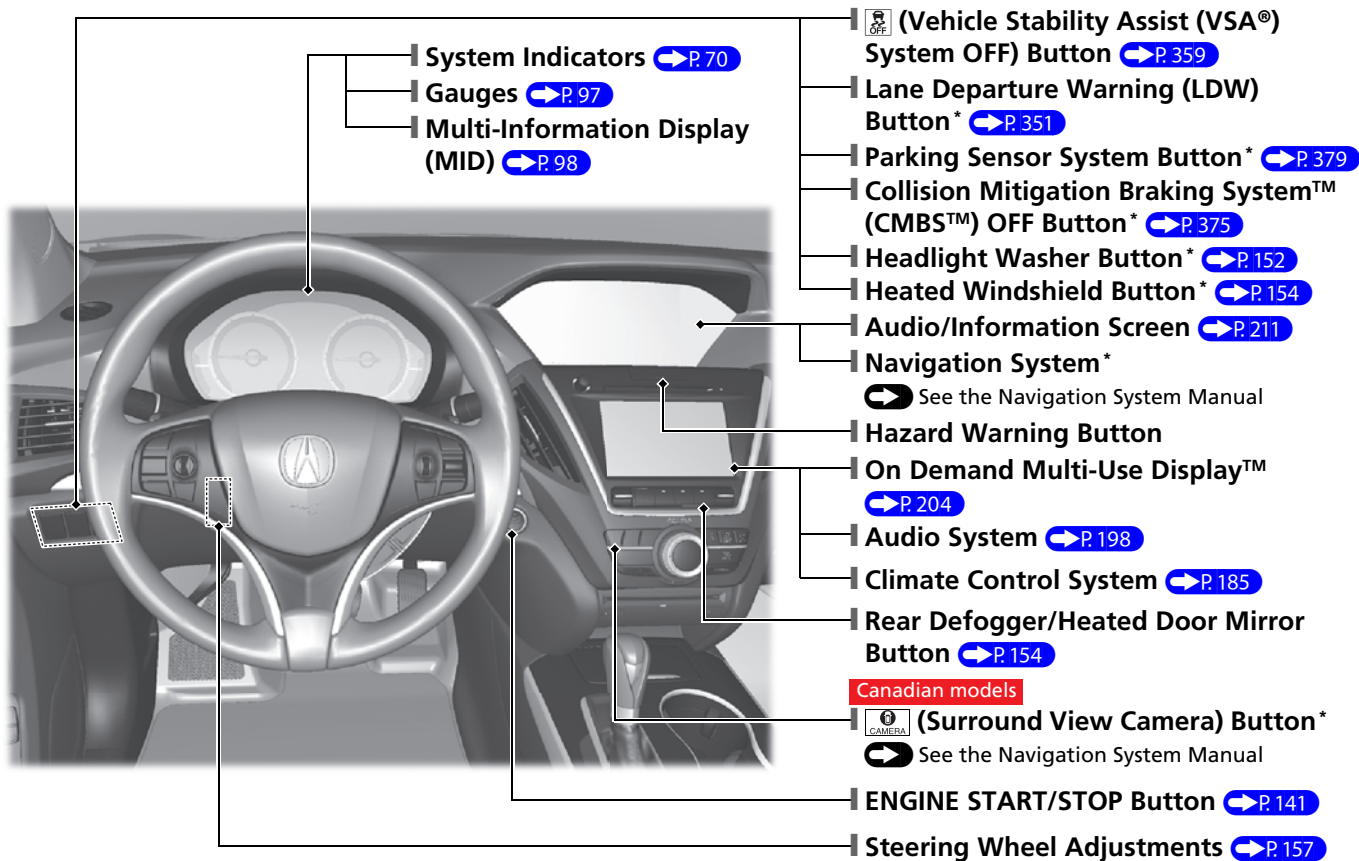

System Indicators → P. 70
Gauges → P. 97
Multi-Information Display (MID) → P. 98

- (Vehicle Stability Assist (VSA®) System OFF) Button → P. 359
- Lane Departure Warning (LDW) Button* → P. 351
- Parking Sensor System Button* → P. 379
- Collision Mitigation Braking System™ (CMBS™) OFF Button* → P. 375
- Headlight Washer Button* → P. 152
- Heated Windshield Button* → P. 154
- Audio/Information Screen → P. 211
- Navigation System*
↪ See the Navigation System Manual
- Hazard Warning Button
- On Demand Multi-Use Display™ → P. 204
- Audio System → P. 198
- Climate Control System → P. 185
- Rear Defogger/Heated Door Mirror Button → P. 154
- Canadian models**
- (Surround View Camera) Button*
↪ See the Navigation System Manual
- ENGINE START/STOP Button → P. 141
- Steering Wheel Adjustments → P. 157

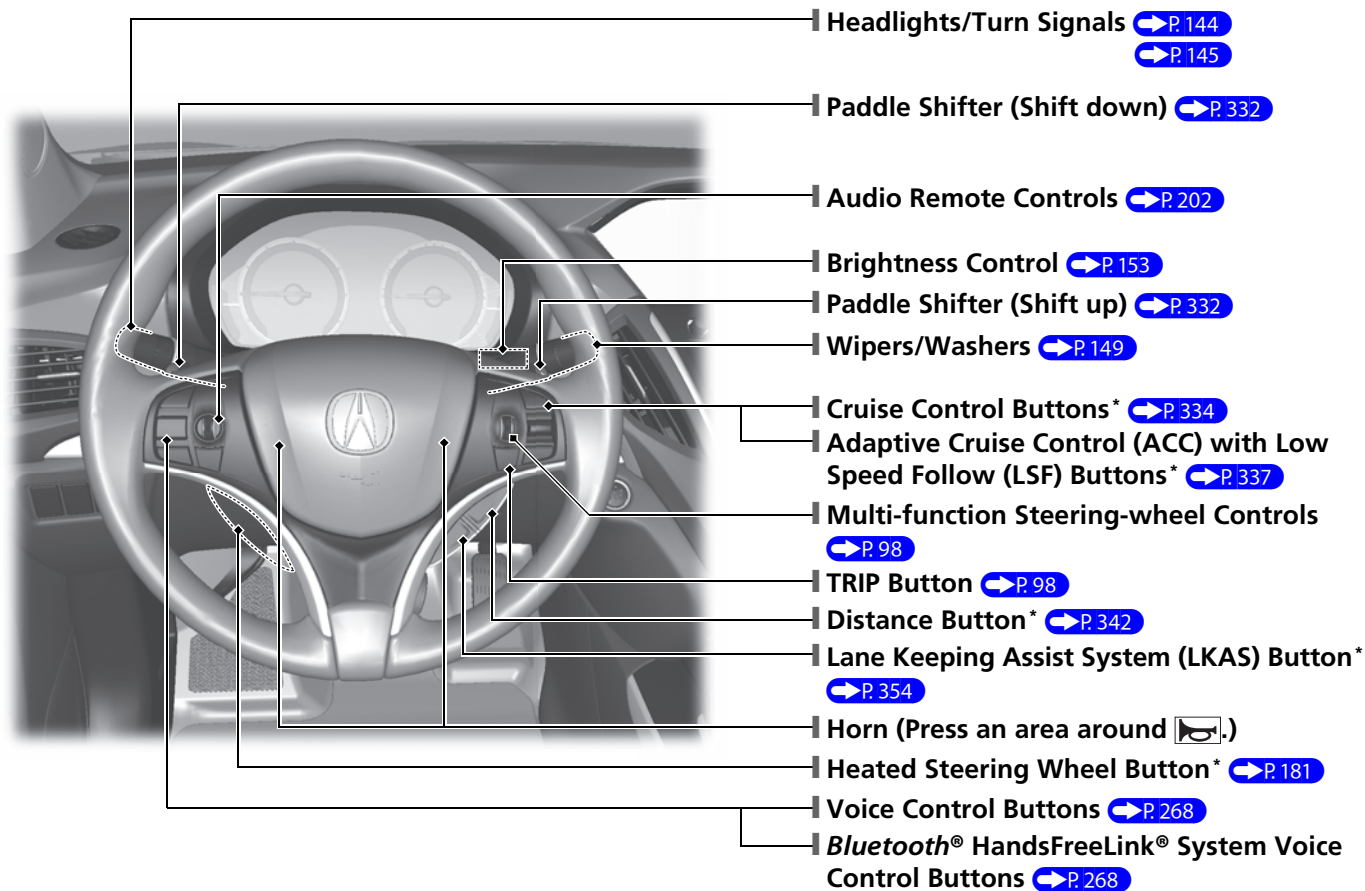

- Headlights/Turn Signals [P. 144](#)
[P. 145](#)
- Paddle Shifter (Shift down) [P. 332](#)
- Audio Remote Controls [P. 202](#)
- Brightness Control [P. 153](#)
- Paddle Shifter (Shift up) [P. 332](#)
- Wipers/Washers [P. 149](#)
- Cruise Control Buttons* [P. 334](#)
- Adaptive Cruise Control (ACC) with Low Speed Follow (LSF) Buttons* [P. 337](#)
- Multi-function Steering-wheel Controls [P. 98](#)
- TRIP Button [P. 98](#)
- Distance Button* [P. 342](#)
- Lane Keeping Assist System (LKAS) Button* [P. 354](#)
- Horn (Press an area around )
- Heated Steering Wheel Button* [P. 181](#)
- Voice Control Buttons [P. 268](#)
- Bluetooth® HandsFreeLink® System Voice Control Buttons [P. 268](#)

Visual Index

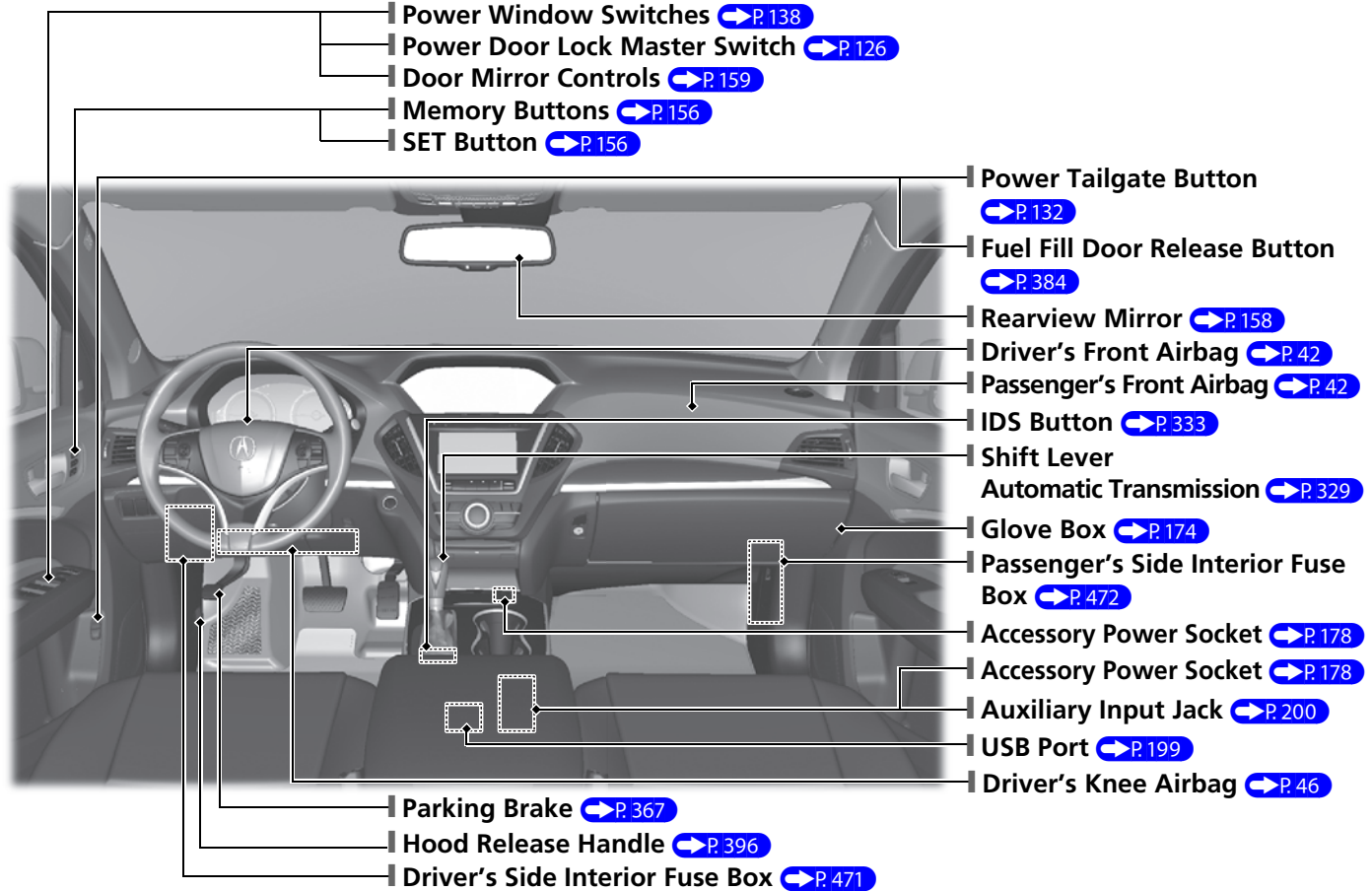

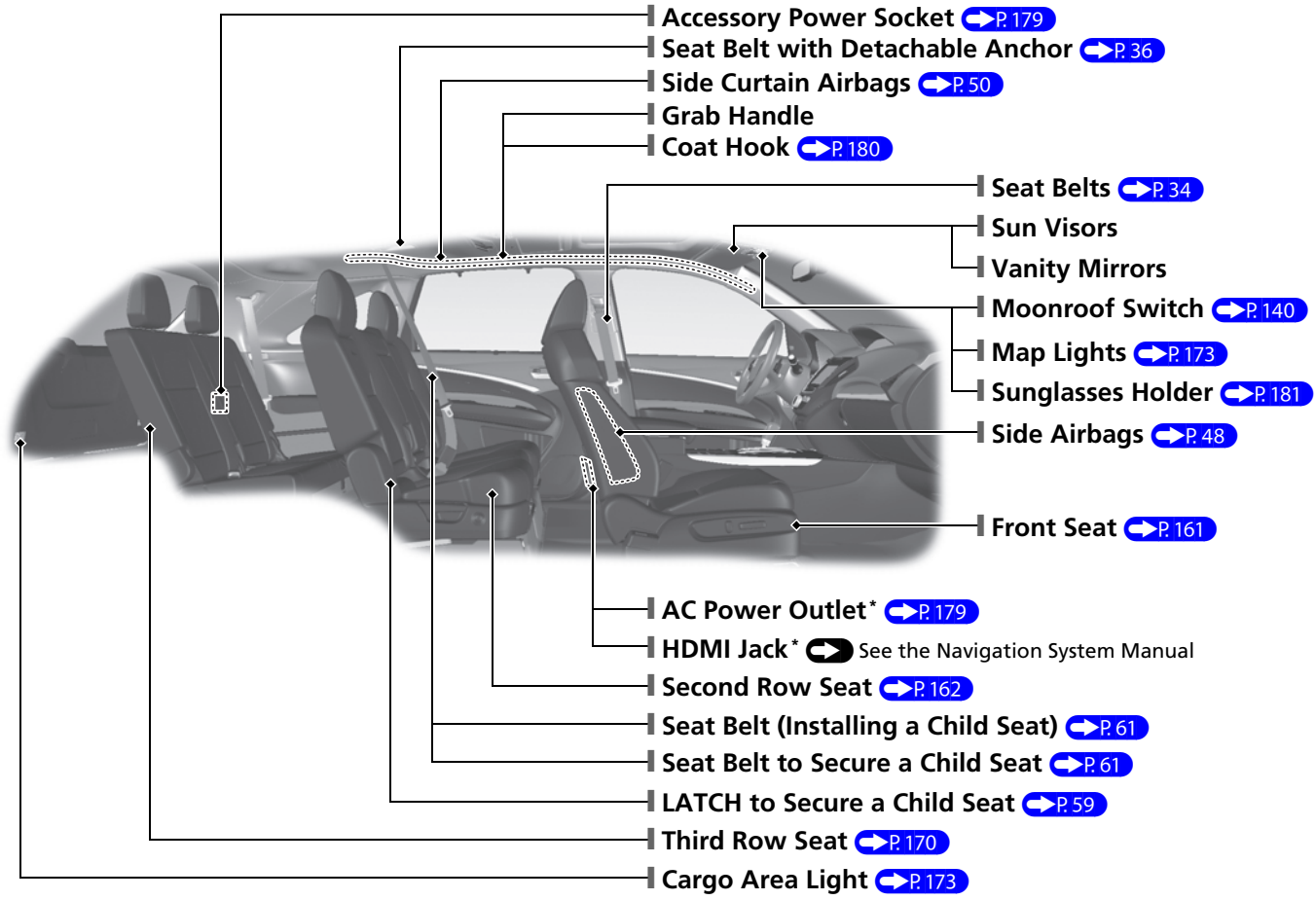

- Accessory Power Socket ➔ P.179
- Seat Belt with Detachable Anchor ➔ P.36
- Side Curtain Airbags ➔ P.50
- Grab Handle
- Coat Hook ➔ P.180
- Seat Belts ➔ P.34
- Sun Visors
- Vanity Mirrors
- Moonroof Switch ➔ P.140
- Map Lights ➔ P.173
- Sunglasses Holder ➔ P.181
- Side Airbags ➔ P.48
- Front Seat ➔ P.161
- AC Power Outlet* ➔ P.179
- HDMI Jack* ➔ See the Navigation System Manual
- Second Row Seat ➔ P.162
- Seat Belt (Installing a Child Seat) ➔ P.61
- Seat Belt to Secure a Child Seat ➔ P.61
- LATCH to Secure a Child Seat ➔ P.59
- Third Row Seat ➔ P.170
- Cargo Area Light ➔ P.173

Visual Index

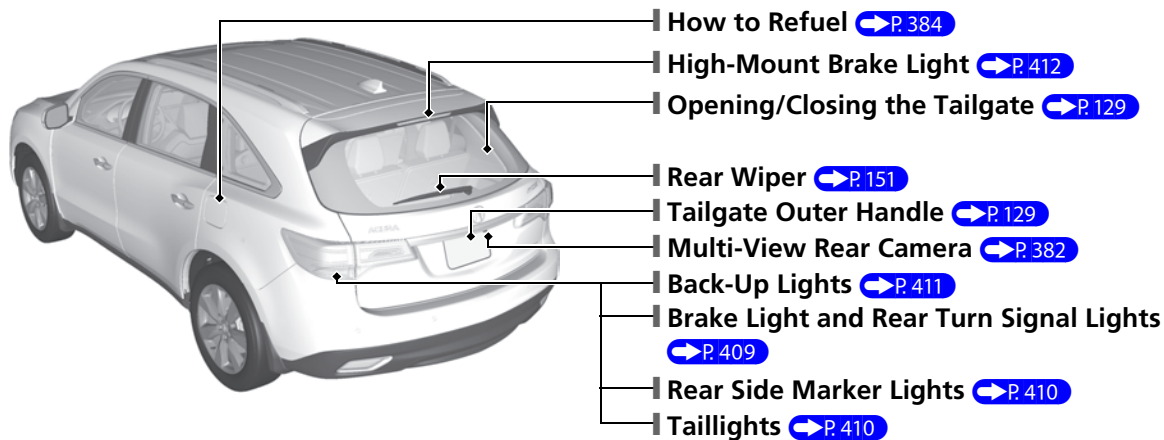
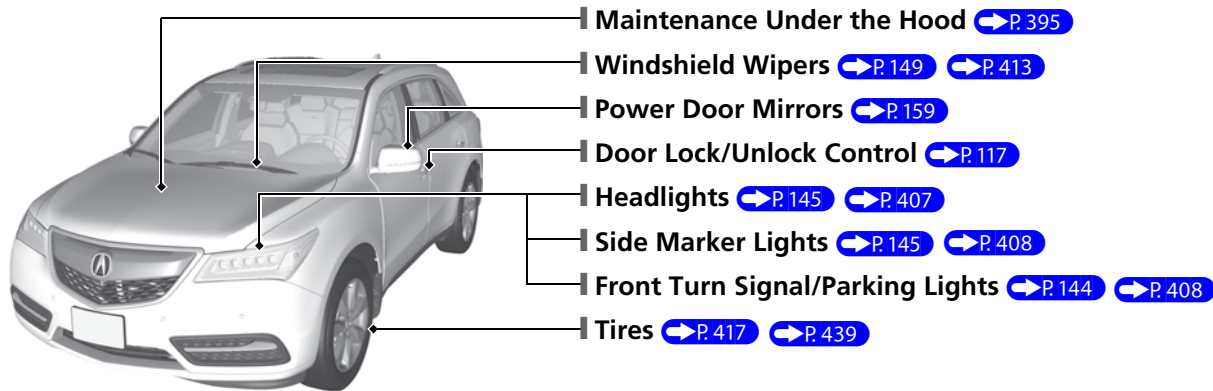

Safe Driving [P.25](#)

Airbags [P.39](#)

- Your vehicle is fitted with airbags to help protect you and your passengers during a moderate-to-severe collision.

Child Safety [P.54](#)

- All children 12 and younger should be seated in the rear seat.
- Smaller children should be properly restrained in a forward-facing child seat.
- Infants must be properly restrained in a rear-facing child seat.

Exhaust Gas Hazard [P.66](#)

- Your vehicle emits dangerous exhaust gases that contain carbon monoxide. Do not run the engine in confined spaces where carbon monoxide gas can accumulate.

Seat Belts [P.31](#)

- Fasten your seat belt and sit upright well back in the seat.
- Check that your passengers are wearing their seat belts correctly.

Before Driving Checklist [P.30](#)

- Before driving, check that the front seats, head restraints, steering wheel, and mirrors have been properly adjusted.

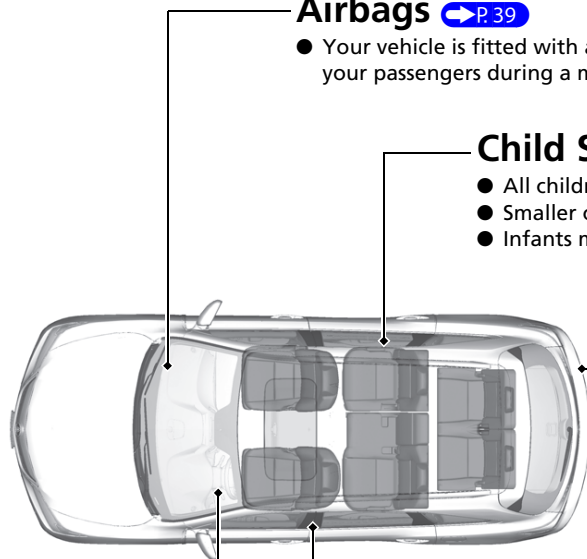











Fasten your lap belt as low as possible.

Instrument Panel ➔ P.69

Gauges ➔ P.97 / Multi-Information Display (MID) ➔ P.98 / System Indicators ➔ P.70

System Indicators

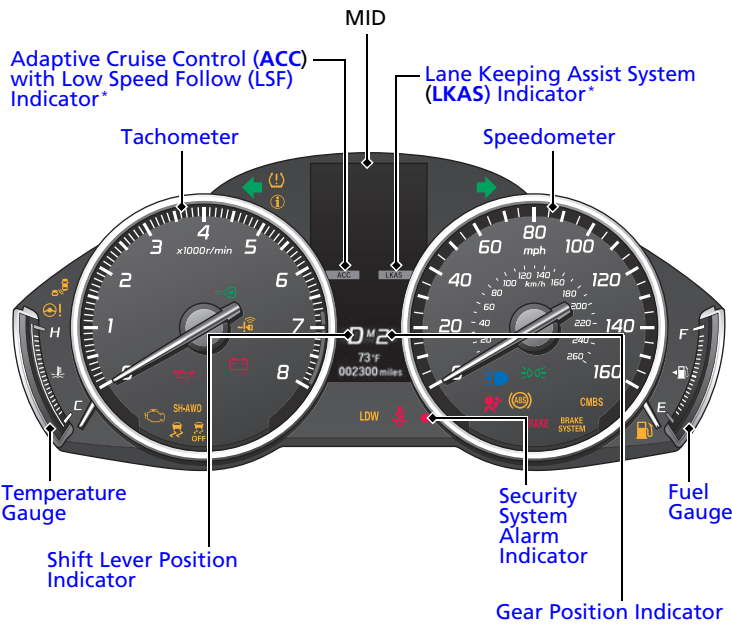

-  Blind Spot Information (BSI) Indicator*
-  Speed-sensitive Electric Power Steering (EPS) System Indicator
-  Malfunction Indicator Lamp
-  Low Oil Pressure Indicator
- SH-AWD SH-AWD Indicator***
-  Vehicle Stability Assist (VSA®) System Indicator
-  VSA® OFF Indicator
-  Immobilizer System Indicator
-  Keyless Access System Indicator
-  Charging System Indicator
-  Low Tire Pressure/TPMS Indicator
-  System Message Indicator









System Indicators

- FCW** Forward Collision Warning (FCW) Indicator*
- LDW** Lane Departure Warning (LDW) Indicator*

Lights Reminders

-  Lights On Indicator
-  High Beam Indicator

System Indicators

-  Turn Signal and Hazard Warning Indicators
-  Supplemental Restraint System Indicator
-  Anti-lock Brake System (ABS) Indicator
- U.S. BRAKE** Parking Brake and Brake System Indicator (Red)
- Canada** 
- U.S. BRAKE SYSTEM** Brake System Indicator (Amber)
- Canada** 
- CMBS** Collision Mitigation Brake System™ (CMBS™) Indicator*
-  Low Fuel Indicator
-  Seat Belt Reminder Indicator

* Not available on all models

Controls [P.113](#)

Clock [P.114](#)

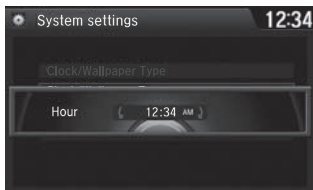

- 1 Enter the **Clock Adjustment** screen. [Adjusting the Clock](#) [P.114](#)
- 2 Rotate to change hour, then press .
- 3 Rotate to change minute, then press .

Models with navigation system

The navigation system receives signals from GPS satellites, updating the clock automatically.

ENGINE START/STOP Button [P.141](#)

Press the button to change the vehicle's power mode.



Turn Signals [P.144](#)

Turn Signal Control Lever

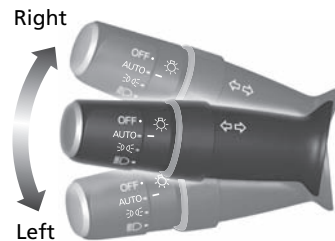

Lights [P.145](#)

Light Control Switches

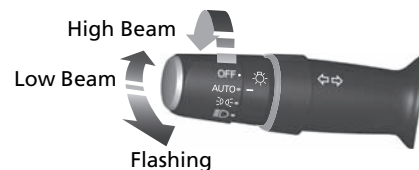

Wipers and Washers

➔ P. 149

Wiper/Washer Control Lever

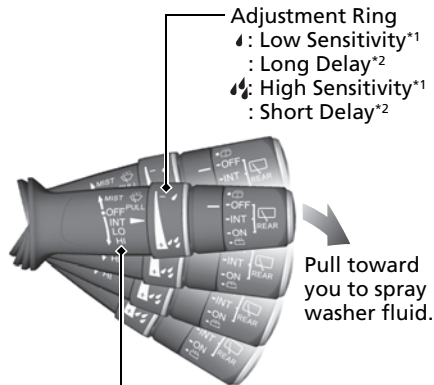

- Adjustment Ring
 - ↓: Low Sensitivity*¹
 - : Long Delay*²
 - ↑: High Sensitivity*¹
 - : Short Delay*²

Pull toward you to spray washer fluid.

MIST
OFF

AUTO*¹: Wiper speed varies automatically

INT*²: Low speed with intermittent

LO: Low speed wipe

HI: High speed wipe

*1: Models with automatic intermittent wipers

*2: Models without automatic intermittent wipers

Steering Wheel ➔ P. 157

- To adjust, push and hold the adjustment switch to move the steering wheel to the desired position.

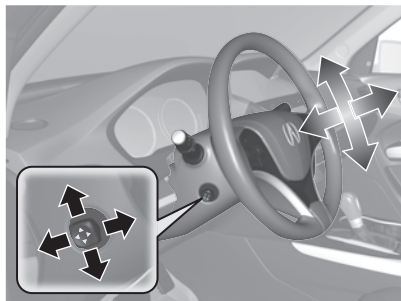

Unlocking the Front Doors from the Inside

➔ P. 125

- Pull either front door inner handle to unlock and open it at the same time.



Tailgate ➔ P. 129 ➔ P. 130

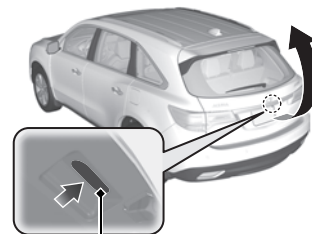

Tailgate Outer Handle

- Touch the tailgate outer handle to unlock and open the tailgate.
- Press the power tailgate button on the driver's door or the remote transmitter to open and close the power tailgate.

Power Door Mirrors

➔ P. 159

- With the power mode in ON, move the selector switch to L or R.
- Push the appropriate edge of the adjustment switch to adjust the mirror.
- Press the folding button* to fold in and out the door mirrors.

Folding Button* Selector Switch

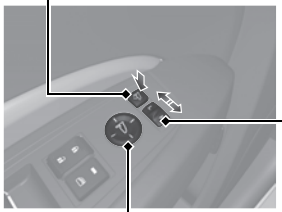

Adjustment Switch

Power Windows ➔ P. 138

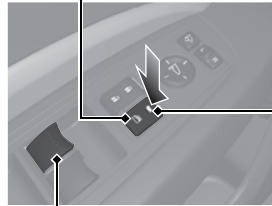

- With the power mode in ON, open and close the power windows.
- If the power window lock button is in the off position, each passenger's window can be opened and closed with its own switch.
- If the power window lock button is in the on position (indicator is on), each passenger's window switch is disabled.

Power Window Lock Button Indicator



Window Switch





Climate Control System ▶ P.185

- Press the **AUTO** button to activate the climate control system.
- Press the  button to turn the system on or off.
- Press the  button to defrost the windshield.

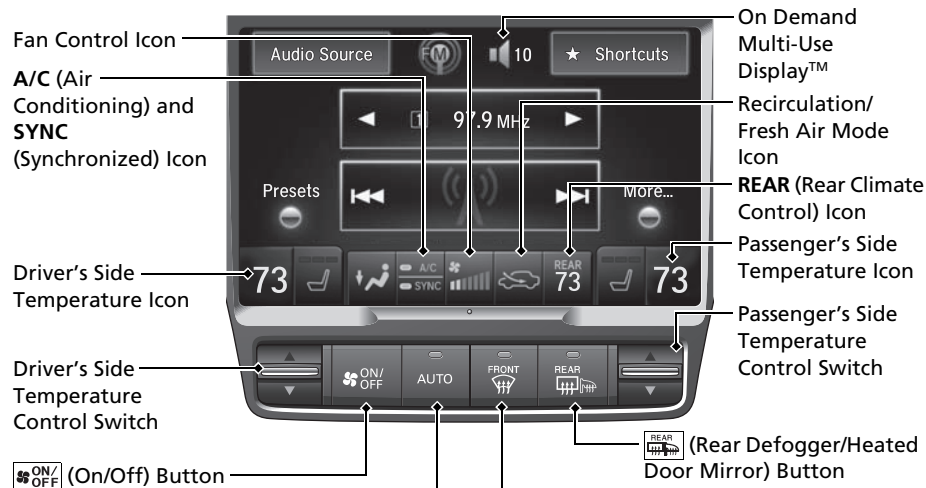
Models with navigation system

The climate control system is voice operable. See the navigation system manual for complete details.





-  Air flows from dashboard vents.
-  Air flows from floor and dashboard vents.
-  Air flows from floor vents.
-  Air flows from floor and windshield defroster vents.

Rear Climate Control ▶ P.195

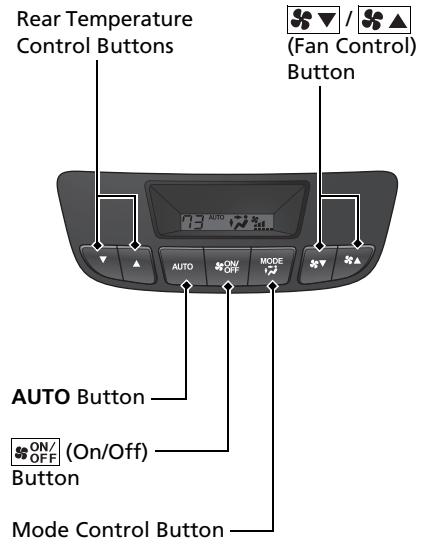
- Press the **AUTO** button to activate the rear climate control system.
- Press the  button to turn the system on or off.



-  Air flows from the rear console vents.
-  Air flow from the rear console vents and floor vents.
-  Air flows from the rear floor vents.

Features ➔ P.197

Audio system ➔ P.198 For navigation system operation ➔ See the Navigation System Manual

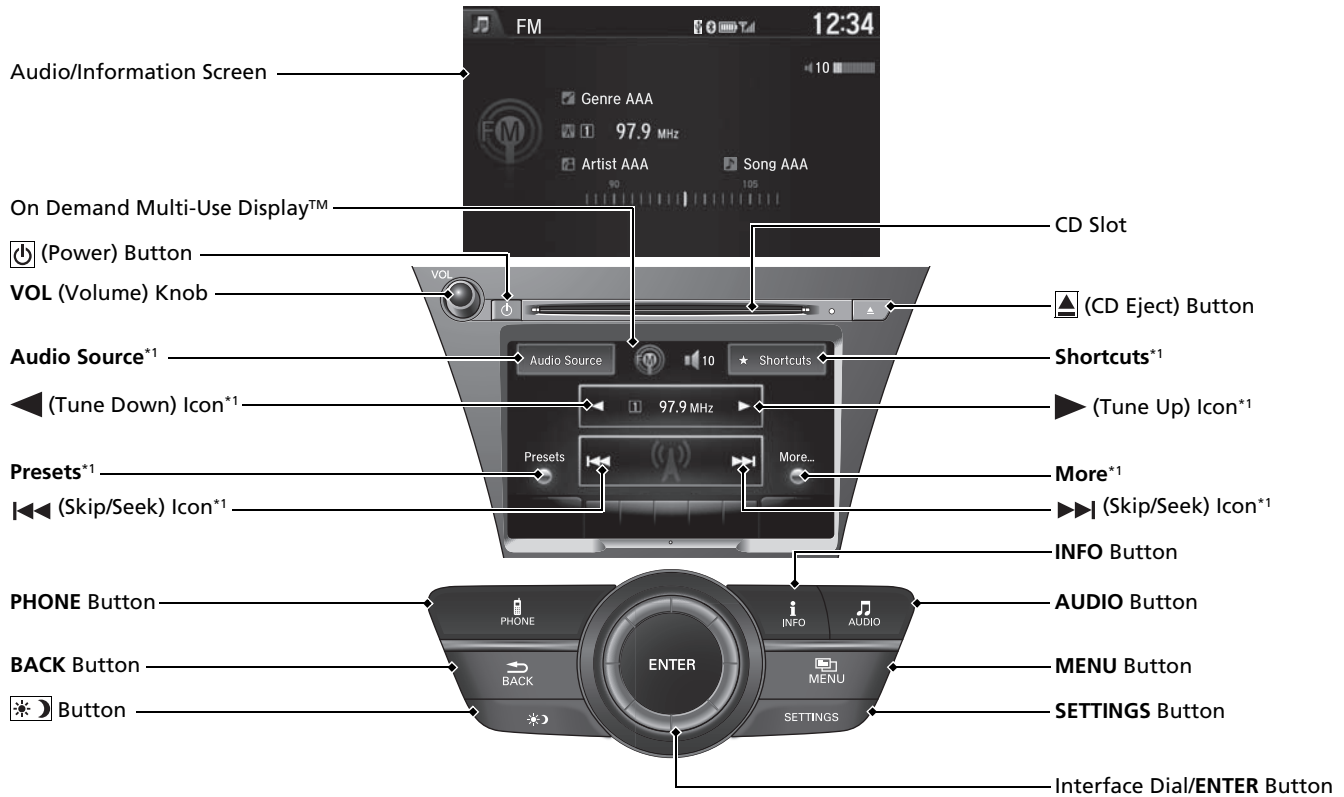

*1:Icons that appear on the screen vary by the source selected.

Audio Remote Controls

QRG

➔ P. 202

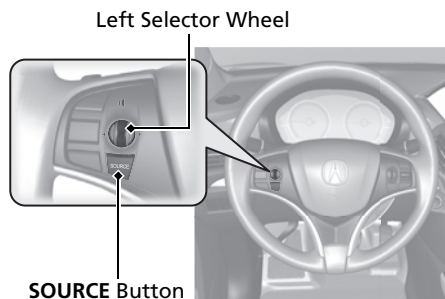

- **SOURCE Button**

Press and release to change the audio mode: FM/AM/CD/XM®/USB/iPod®/Bluetooth® Audio/Pandora®/Aha™/AUX.

- **Left Selector Wheel**

Roll to adjust the volume up/down.

Radio: Shift to a side to change the preset station.

Shift to a side and hold to select the next or previous strong station.

CD/USB device:

Shift to a side to skip to the beginning of the next song or return to the beginning of the current song.

Shift to a side and hold to change a folder.

Index

Home

Driving ➔ P.303

Automatic Transmission ➔ P.328

- Shift to **P** and depress the brake pedal when starting the engine.

● Shifting

P **Park**
Turn off or start the engine.
Transmission is locked.

R **Reverse**

N **Neutral**
Transmission is not locked.

D **Drive**
Normal driving. D-paddle shift mode can be used.

S **S Position**
Sequential shift mode can be used.

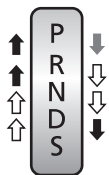
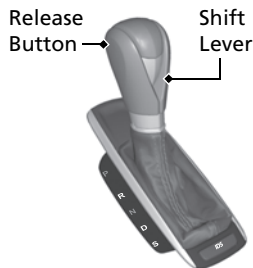

Depress the brake pedal and press the release button to move out of **P**.

Press the release button to move the shift lever.

Move the shift lever without pressing the release button.

Paddle Shifters ➔ P.331

- Paddle shifters allow you to shift gears much like a manual transmission (1st through 6th). This is useful for engine braking.
- D-paddle shift mode: The transmission will shift back to automatic mode once the system detects that the vehicle is cruising.
- Sequential shift mode: Holds the selected gear, and the **M** indicator comes on.
- The selected gear position is shown in the instrument panel.

Shift Lever Position Indicator  **M** Indicator Selected Gear Number

Shift Down **-**
Paddle Shifter

Shift Up **+**
Paddle Shifter



VSA® OFF Button [P. 359](#)

- The vehicle stability assist (VSA®) system helps stabilize the vehicle during cornering, and helps maintain traction while accelerating on loose or slippery road surfaces.
- VSA® comes on automatically every time you start the engine.
- To turn VSA® on or off, press and hold the button until you hear a beep.

Cruise Control [P. 334](#)

- Cruise control allows you to maintain a set speed without keeping your foot on the accelerator pedal.
- To use cruise control, press the **CRUISE** button, then press the **RES/+ / SET / -** button once you have achieved the desired speed (above 25 mph or 40 km/h).

Tire Pressure Monitoring System (TPMS) [P. 363](#)

- The TPMS monitors tire pressure.
- The TPMS is turned on automatically every time you start the engine.

Refueling [P. 383](#)

Fuel recommendation: Unleaded premium gasoline with a pump octane number 91 or higher recommended

Fuel tank capacity: 19.5 US gal (74.0 ℓ)

- 1 Press the fuel fill door release button.
- 2 Turn the fuel fill cap slowly to remove the cap.
- 3 Place the cap in the holder on the fuel fill door.
- 4 After refueling, screw the cap back on until it clicks at least once.

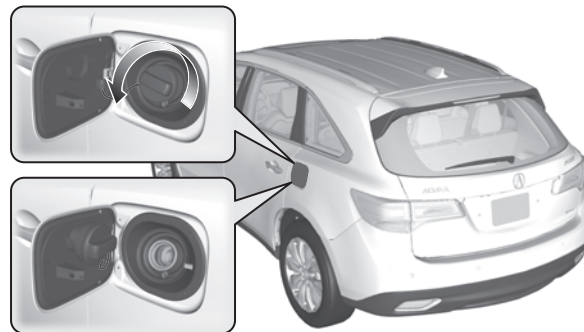

Maintenance [➔ P. 387](#)

Under the Hood [➔ P. 395](#)

- Check engine oil, engine coolant, and windshield washer fluid. Add when necessary.
- Check brake fluid.
- Check the battery condition monthly.

- 1** Pull the hood release handle under the corner of the dashboard.

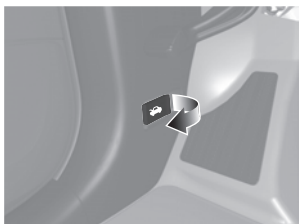

- 2** Locate the hood latch lever, pull the lever up, and lift up the hood.



- 3** When finished, close the hood and make sure it is firmly locked in place.

Wiper Blades [➔ P. 413](#)

- Replace blades if they leave streaks across the windshield.



Tires [➔ P. 417](#)

- Inspect tires and wheels regularly.
- Check tire pressures regularly.
- Install snow tires for winter driving.

Lights [➔ P. 407](#)

- Inspect all lights regularly.

Handling the Unexpected

➔ P. 437

Flat Tire ➔ P. 439

Vehicles with tire repair kit

- Park in a safe location and repair the flat tire using the tire repair kit.

Vehicles with compact spare tire kit

- Park in a safe location and replace the flat tire with the compact spare tire located under the cargo area.



Engine Won't Start ➔ P. 457

- If the battery is dead, jump start using a booster battery.



Overheating ➔ P. 463

- Park in a safe location. If you do not see steam under the hood, open the hood, and let the engine cool down.



Indicators Come On ➔ P. 465

- Identify the indicator and consult the owner's manual.



Blown Fuse ➔ P. 474

- Check for a blown fuse if an electrical device does not operate.

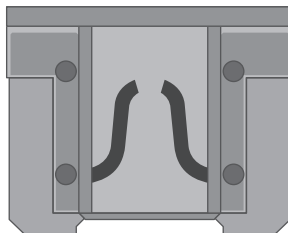

Emergency Towing ➔ P. 475

- Call a professional towing service if you need to tow your vehicle.



What to Do If

Q The power mode does not change from **VEHICLE OFF (LOCK)** to **ACCESSORY**. Why?

A

- The steering wheel may be locked.
- Move the steering wheel left and right after pressing the **ENGINE START/STOP** button.



Q The power mode does not change from **ON** to **VEHICLE OFF (LOCK)**. Why?

A The shift lever should be moved to **P**.



Q Why does the brake pedal pulsate slightly when applying the brakes?

A This can occur when the ABS activates, and does not indicate a problem. Apply firm, steady pressure on the brake pedal. Never pump the brake pedal.

Q The rear door cannot be opened from inside the vehicle. Why?

A Check if the childproof lock is in the lock position. If so, open the rear door with the outside door handle. To cancel this function, push the lever to the unlock position.

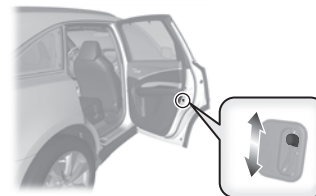

Q Why do the doors lock after I unlocked the doors using a remote transmitter?

A If you do not open the doors within 30 seconds, the doors are relocked automatically for security.

Q Why does the beeper sound when I open the driver's door?

A The beeper sounds when:

- The exterior lights are left on.
- The power mode is in ACCESSORY.

Q Why does the beeper sound when I start driving?

A The beeper sounds when:

- Driver and/or front passenger are not wearing their seat belts.
- The parking brake lever is not fully released.

Q Why does the beeper sound when I turn the engine off?

A The beeper sounds when you turn off the engine with the driver's door open.

Q Why do I hear a screeching sound when I apply the brake pedal?

A The brake pads may need to be replaced. Have your vehicle inspected by a dealer.

Q Unleaded gasoline with a Pump Octane Number (PON) of 91 or higher is recommended.
Is it possible to use unleaded gasoline with a Pump Octane Number (PON) of 87 or higher on this vehicle?

A Unleaded gasoline with a Pump Octane Number (PON) of 91 or higher is recommended.
Use of lower octane gasoline can cause occasional metallic knocking noise in the engine and will result in decreased engine performance.
Use of gasoline with a pump octane less than 87 can lead to engine damage.

California Proposition 65 Warning

WARNING: This product contains or emits chemicals known to the state of California to cause cancer and birth defects or other reproductive harm.

Event Data Recorders

This vehicle is equipped with an event data recorder (EDR).

The main purpose of an EDR is to record, in certain crash or near crash-like situations, such as an air bag deployment or hitting a road obstacle, data that will assist in understanding how a vehicle's systems performed. **The EDR is designed to record data related to vehicle dynamics and safety systems for a short period of time, typically 30 seconds or less. The EDR in this vehicle is designed to record such data as:**

- **How various systems in your vehicle were operating;**
- **Whether or not the driver and passenger safety belts were buckled/fastened;**
- **How far (if at all) the driver was depressing the accelerator and/or brake pedal; and,**
- **How fast the vehicle was traveling.**

These data can help provide a better understanding of the circumstances in which crashes and injuries occur. NOTE: EDR data are recorded by your vehicle only if a non-trivial crash situation occurs; no data are recorded by the EDR under normal driving conditions and no personal data (e.g., name, gender, age, and crash location) are recorded. However, other parties, such as law enforcement, could combine the EDR data with the type of personally identifying data routinely acquired during a crash investigation.

To read data recorded by an EDR, special equipment is required, and access to the vehicle or the EDR is needed. In addition to the vehicle manufacturer, other parties, such as law enforcement, that have the special equipment, can read the information if they have access to the vehicle or the EDR.

The data belongs to the vehicle owner and may not be accessed by anyone else except as legally required or with the permission of the vehicle owner.

Service Diagnostic Recorders

This vehicle is equipped with service-related devices that record information about powertrain performance. The data can be used to verify emissions law requirements and/or help technicians diagnose and solve service problems. It may also be combined with data from other sources for research purposes, but it remains confidential.

California Perchlorate Contamination Prevention Act

The airbags, seat belt tensioners, and CR type batteries in this vehicle may contain perchlorate materials - special handling may apply. See www.dtsc.ca.gov/hazardouswaste/perchlorate/

As you read this manual, you will find information that is preceded by a **NOTICE** symbol. This information is intended to help you avoid damage to your vehicle, other property, or the environment.

A Few Words About Safety

Your safety, and the safety of others, is very important. And operating this vehicle safely is an important responsibility.

To help you make informed decisions about safety, we have provided operating procedures and other information on labels and in this manual. This information alerts you to potential hazards that could hurt you or others.

Of course, it is not practical or possible to warn you about all the hazards associated with operating or maintaining your vehicle. You must use your own good judgement.

You will find this important safety information in a variety of forms, including:

- **Safety Labels** - on the vehicle.
- **Safety Messages** - preceded by a safety alert symbol  and one of three signal words: **DANGER**, **WARNING**, or **CAUTION**. These signal words mean:

 **DANGER**

You WILL be KILLED or SERIOUSLY HURT if you don't follow instructions.

 **WARNING**

You CAN be KILLED or SERIOUSLY HURT if you don't follow instructions.

 **CAUTION**

You CAN be HURT if you don't follow instructions.

- **Safety Headings** - such as Important Safety Precautions.
- **Safety Section** - such as Safe Driving.
- **Instructions** - how to use this vehicle correctly and safely.

This entire book is filled with important safety information - please read it carefully.

Safe Driving

You can find many safety recommendations throughout this chapter, and throughout this manual.

For Safe Driving

- Important Safety Precautions..... 26
- Important Handling Information..... 28
- Your Vehicle’s Safety Features..... 29

Seat Belts

- About Your Seat Belts..... 31
- Fastening a Seat Belt..... 34
- Seat Belt Inspection..... 38

Airbags

- Airbag System Components..... 39
- Types of Airbags 42
- Front Airbags (SRS) 42
- Driver’s Knee Airbag 46
- Side Airbags..... 48
- Side Curtain Airbags 50
- Airbag System Indicators..... 51
- Airbag Care 53

Child Safety

- Protecting Child Passengers 54
- Safety of Infants and Small Children .. 56
- Safety of Larger Children 64

Exhaust Gas Hazard

- Carbon Monoxide Gas..... 66

Safety Labels

- Label Locations..... 67



The following pages explain your vehicle's safety features and how to use them properly. The safety precautions below are ones that we consider to be among the most important.

Important Safety Precautions

■ Always wear your seat belt

A seat belt is your best protection in all types of collisions. Airbags are designed to supplement seat belts, not replace them. So even though your vehicle is equipped with airbags, make sure you and your passengers always wear your seat belts, and wear them properly.

■ Restrain all children

Children ages 12 and under should ride properly restrained in a back seat, not the front seat. Infants and small children should be restrained in a child seat. Larger children should use a booster seat and a lap/shoulder seat belt until they can use the belt properly without a booster seat.

■ Be aware of airbag hazards

While airbags can save lives, they can cause serious or fatal injuries to occupants who sit too close to them, or are not properly restrained. Infants, young children, and short adults are at the greatest risk. Be sure to follow all instructions and warnings in this manual.

■ Don't drink and drive

Alcohol and driving don't mix. Even one drink can reduce your ability to respond to changing conditions, and your reaction time gets worse with every additional drink. So don't drink and drive, and don't let your friends drink and drive, either.

⌘ Important Safety Precautions

Some states, provinces and territories prohibit the use of cell phones other than hands-free devices by the driver while driving.

■ Pay appropriate attention to the task of driving safely

Engaging in cell phone conversation or other activities that keep you from paying close attention to the road, other vehicles, and pedestrians could lead to a crash. Remember, situations can change quickly, and only you can decide when it is safe to divert some attention away from driving.

■ Control your speed

Excessive speed is a major factor in crash injuries and deaths. Generally, the higher the speed, the greater the risk, but serious injuries can also occur at lower speeds. Never drive faster than is safe for current conditions, regardless of the maximum speed posted.

■ Keep your vehicle in safe condition

Having a tire blowout or a mechanical failure can be extremely hazardous. To reduce the possibility of such problems, check your tire pressures and condition frequently, and perform all regularly scheduled maintenance.

Important Handling Information

Your vehicle has higher ground clearance than a passenger vehicle designed for use only on pavement. Higher ground clearance has many advantages for off-highway driving. It allows you to travel over bumps, obstacles, and rough terrain. It also provides good visibility so you can anticipate problems earlier.

These advantages come at some cost. Because your vehicle is taller and rides higher off the ground, it has a higher center gravity making it more susceptible to tripping or roll over if you make abrupt turns. Utility vehicles have a significantly higher rollover rate than other types of vehicles. In a rollover crash, an unbelted person is significantly more likely to die than a person wearing a seat belt. As a reminder, make sure you and your passengers always wear seat belts.

Important Handling Information

For information on how to reduce the risk of rollover, read:

[▶ Driving Guidelines for Your Utility Vehicle](#)
P. 327

[▶ Off-Highway Driving Guidelines P. 320](#)

Failure to operate your vehicle correctly might result in a crash or a rollover.

Your Vehicle's Safety Features

QRG

TOC

Safe Driving

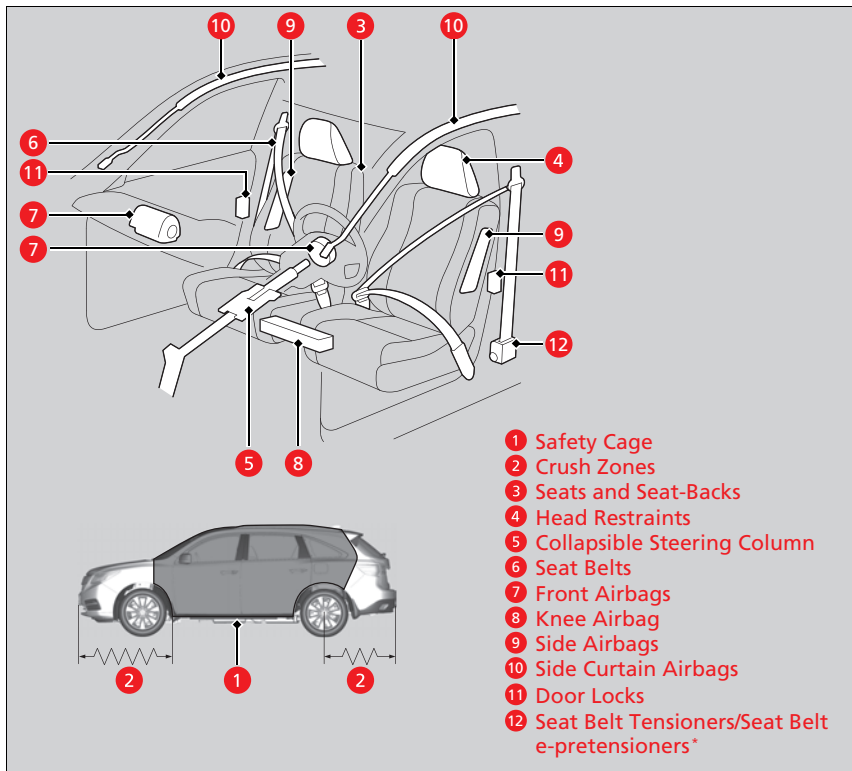

Your Vehicle's Safety Features

Your vehicle is equipped with many features that work together to help protect you and your passengers during a crash.

Some features do not require any action on your part. These include a strong steel framework that forms a safety cage around the passenger compartment, front and rear crush zones, a collapsible steering column, and tensioners that tighten the front seat belts in a sufficient crash.

However, you and your passengers cannot take full advantage of these features unless you remain seated in the correct position and always wear your seat belts. In fact, some safety features can contribute to injuries if they are not used properly.

The following checklist will help you take an active role in protecting yourself and your passengers.

Index



* Not available on all models

Continued

■ Safety Checklist

For the safety of you and your passengers, make a habit of checking these items each time before you drive.

- After everyone has entered the vehicle, be sure all doors and the tailgate are closed and locked. Locking the doors and the tailgate helps prevent an occupant from being ejected and an outsider from unexpectedly opening a door or the tailgate.
 - ▶ [Locking/Unlocking the Doors from the Inside P. 124](#)
- Adjust your seat to a position suitable for driving. Be sure the front seats are adjusted as far to the rear as possible while allowing the driver to control the vehicle. Sitting too close to a front airbag can result in serious or fatal injury in a crash.
 - ▶ [Adjusting the Seats P. 161](#)
- Adjust head restraints to the proper position. Head restraints are most effective when the center of the head restraint aligns with the center of your head. Taller persons should adjust their head restraint to the highest position.
 - ▶ [Adjusting the Head Restraints P. 164](#)
- Always wear your seat belt, and make sure you wear it properly. Confirm that any passengers are properly belted as well.
 - ▶ [Fastening a Seat Belt P. 34](#)
- Protect children by using seat belts or child seats according to a child's age, height and weight.
 - ▶ [Child Safety P. 54](#)

▶ Safety Checklist

If the door and/or tailgate open message appears on the multi-information display (MID), a door and/or the tailgate is not completely closed. Close all doors and the tailgate tightly until the message disappears.



About Your Seat Belts

Seat belts are the single most effective safety device because they keep you connected to the vehicle so that you can take advantage of many built-in safety features. They also help keep you from being thrown against the inside of the vehicle, against other passengers, or out of the vehicle. When worn properly, seat belts also keep your body properly positioned in a crash so that you can take full advantage of the additional protection provided by the airbags.

In addition, seat belts help protect you in almost every type of crash, including:

- frontal impacts
- side impacts
- rear impacts
- rollovers

■ Lap/shoulder seat belts

All seven seating positions are equipped with lap/shoulder seat belts with emergency locking retractors. In normal driving the retractor lets you move freely while keeping some tension on the belt. During a collision or sudden stop the retractor locks to restrain your body. The front passenger's, second row and third row seat belts also have a lockable retractor for use with child seats.

[▶ Installing a Child Seat with a Lap/Shoulder Seat Belt P. 61](#)

▶ About Your Seat Belts

⚠ WARNING

Not wearing a seat belt properly increases the chance of serious injury or death in a crash, even though your vehicle has airbags.

Be sure you and your passengers always wear seat belts and wear them properly.

Seat belts cannot completely protect you in every crash. But in most cases, seat belts can reduce your risk of serious injury.

Most states and all Canadian provinces and territories require you to wear seat belts.

■ Proper use of seat belts

Follow these guidelines for proper use:

- All occupants should sit upright, well back in the seat, and remain in that position for the duration of the trip. Slouching and leaning reduce the effectiveness of the belt and can increase the chance of serious injury in a crash.
- Never place the shoulder part of a lap/shoulder seat belt under your arm or behind your back. This could cause very serious injuries in a crash.
- Two people should never use the same seat belt. If they do, they could be very seriously injured in a crash.
- Do not put any accessories on the seat belts. Devices intended to improve comfort or reposition the shoulder part of a seat belt can reduce the protective capability and increase the chance of serious injury in a crash.

■ Seat Belt Reminder



Your vehicle monitors front seat belt use. If the power mode is set to ON before the driver's seat belt is fastened, the beeper will sound and the indicator will blink. If the driver does not fasten the belt before the beeper stops, the indicator will remain on.

The beeper will also periodically sound and the indicator will blink while driving until the driver's and front passenger's seat belts are fastened.

▶ About Your Seat Belts

If a rear seat passenger moves around and extends the seat belt, the lockable retractor may activate. If this happens, release the retractor by unfastening the seat belt and allow the belt to retract completely. Then refasten the belt.

▶ Seat Belt Reminder

The indicator will also come on if a front passenger does not fasten their seat belt within six seconds after the power mode is set to ON.

When no one is sitting in the front passenger's seat, the indicator will not come on and the beeper will not sound.

The indicator also may not come on and the beeper may not sound when the occupant is not heavy enough to trigger the weight sensor. Such occupants (e.g., infants and smaller children) should be moved to the rear seat as a deploying front airbag likely will injure or kill them.

[▶ Protecting Child Passengers P. 54](#)

Automatic Seat Belt Tensioners

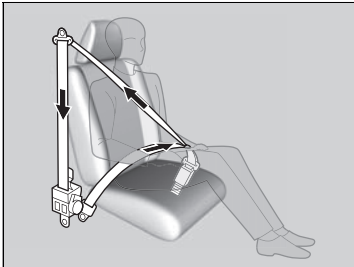

The front seats are equipped with automatic seat belt tensioners to enhance safety.

The tensioners automatically tighten the front seat belts during a moderate-to-severe frontal collision, sometimes even if the collision is not severe enough to inflate the front airbags or the driver's knee airbag.

Seat Belt e-pretensioners*

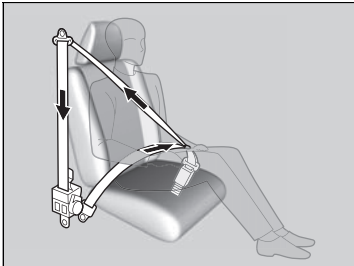

Are the motor-powered pretensioners that start to retract the front seat belts when the CMBS™, brake assist system, or VSA® system is in operation. They may also activate when you steer the vehicle hard, or the vehicle is impacted. After retracted, the seat belts are slackened to their original positions.

As convenient features, the e-pretensioners slightly retract the seat belts when you latch the seat belt buckle, depress the brake pedal more aggressively than you normally do, or make a sharp turn, and fully retract when you release the seat belt buckle.

Automatic Seat Belt Tensioners

The seat belt tensioners can only operate once. If a tensioner is activated, the SRS indicator will come on. Have a dealer replace the tensioner and thoroughly inspect the seat belt system as it may not offer protection in a subsequent crash.

During a moderate-to-severe side impact, the tensioner on that side of the vehicle also activates.

Seat Belt e-pretensioners*

If only the e-pretensioners were activated, no components need to be replaced.

The e-pretensioners may not work if:

- Supplemental Restraint System Indicator is on.
- Vehicle Stability Assist (VSA®) System Indicator is on.

Fastening a Seat Belt

After adjusting a front seat to the proper position, and while sitting upright and well back in the seat:

▶ [Adjusting the Seats](#) P. 161

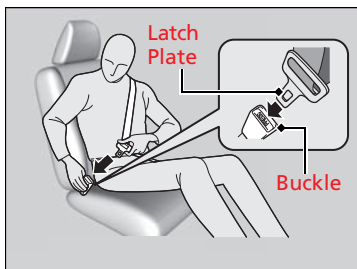
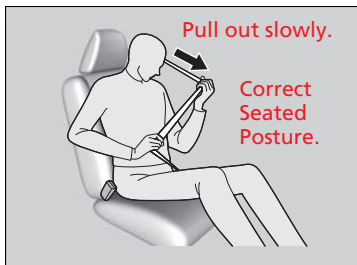

1. Pull the seat belt out slowly.

2. Insert the latch plate into the buckle, then tug on the belt to make sure the buckle is secure.

▶ Make sure that the belt is not twisted or caught on anything.

Models with CMBS™

When you or the front passenger insert the latch plate into the buckle, the front seat belt retracts automatically.

▶ [Seat Belt e-pretensioners*](#) P. 33

Fastening a Seat Belt

No one should sit in a seat with an inoperative seat belt or one that does not appear to be working correctly. Using a seat belt that is not working properly may not protect the occupant in a crash. Have a dealer check the belt as soon as possible.

Never insert any foreign objects into the buckle or retractor mechanism.

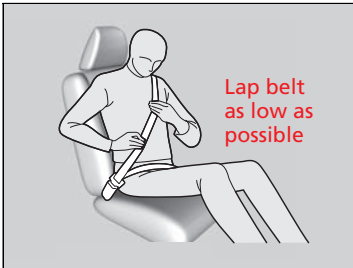

3. Position the lap part of the belt as low as possible across your hips, then pull up on the shoulder part of the belt so the lap part fits snugly. This lets your strong pelvic bones take the force of a crash and reduce the chance of internal injuries.
4. If necessary, pull up on the belt again to remove any slack, then check that the belt rests across the center of your chest and over your shoulder. This spreads the forces of a crash over the strongest bones in your upper body.

■ Adjusting the Shoulder Anchor

The front seats have adjustable shoulder anchors to accommodate taller and shorter occupants.

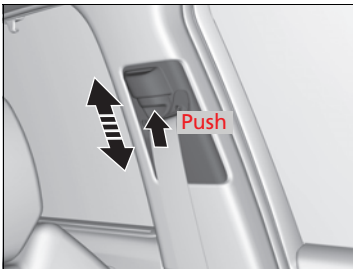

1. Move the anchor up and down while holding the release button.
2. Position the anchor so that the belt rests across the center of your chest and over your shoulder.

▶▶ Fastening a Seat Belt

⚠ WARNING

Improperly positioning the seat belts can cause serious injury or death in a crash.

Make sure all seat belts are properly positioned before driving.

To release the belt, push the red **PRESS** button then guide the belt by hand until it has retracted completely.

When exiting the vehicle, be sure the belt is out of the way and will not get caught by closing the door.

▶▶ Adjusting the Shoulder Anchor

The shoulder anchor height can be adjusted to four levels. If the belt contacts your neck, lower the height one level at a time.

After an adjustment, make sure that the shoulder anchor position is secure.

Seat Belt with Detachable Anchor

Seat Belt with Detachable Anchor

WARNING

Using the seat belt with the detachable anchor unlatched increases the chance of serious injury or death in a crash.

Before using the seat belt, make sure the detachable anchor is correctly latched.

To unlatch the detachable anchor, insert the latch plate into the slot on the side of the anchor buckle.

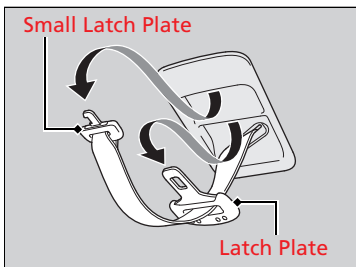
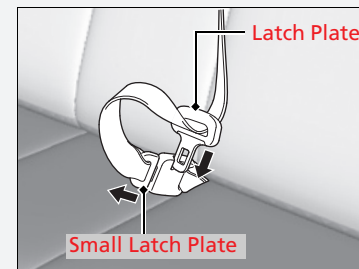

1. Pull out the seat belt's small latch plate and the latch plate from each holding slot in the ceiling.

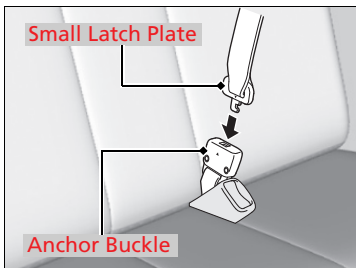

2. Line up the triangle marks on the small latch plate and anchor buckle. Make sure the seat belt is not twisted. Attach the belt to the anchor buckle.

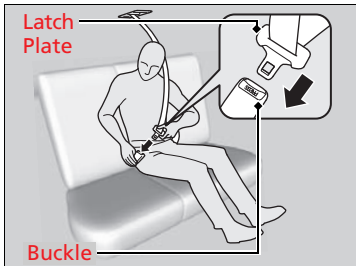

3. Insert the latch plate into the buckle. Properly fasten the seat belt the same way you fasten the lap/shoulder seat belt.

Advice for Pregnant Women

If you are pregnant, the best way to protect yourself and your unborn child when driving or riding in a vehicle is to always wear a seat belt and keep the lap part of the belt as low as possible across the hips.

Wear the shoulder belt across the chest avoiding the abdomen.



Wear the lap part of the belt as low as possible across the hips.

Advice for Pregnant Women

Each time you have a checkup, ask your doctor if it is okay for you to drive.

To reduce the risk of injuries to both you and your unborn child that can be caused by an inflating front airbag:

- When driving, sit upright and adjust the seat as far back as possible while allowing full control of the vehicle.
- When sitting in the front passenger's seat, adjust the seat as far back as possible.

Seat Belt Inspection

Regularly check the condition of your seat belts as follows:

- Pull each belt out fully, and look for frays, cuts, burns, and wear.
- Check that the latches work smoothly and the belts retract easily.
 - ▶ If a belt does not retract easily, cleaning the belt may correct the problem. Only use a mild soap and warm water. Do not use bleach or cleaning solvents. Make sure the belt is completely dry before allowing it to retract.

Any belt that is not in good condition or working properly will not provide proper protection and should be replaced as soon as possible.

A belt that has been worn during a crash may not provide the same level of protection in a subsequent crash. Have your seat belts inspected by a dealer after any collision.

Seat Belt Inspection

WARNING

Not checking or maintaining seat belts can result in serious injury or death if the seat belts do not work properly when needed.

Check your seat belts regularly and have any problem corrected as soon as possible.

Airbag System Components

QRG

TOC

Safe Driving

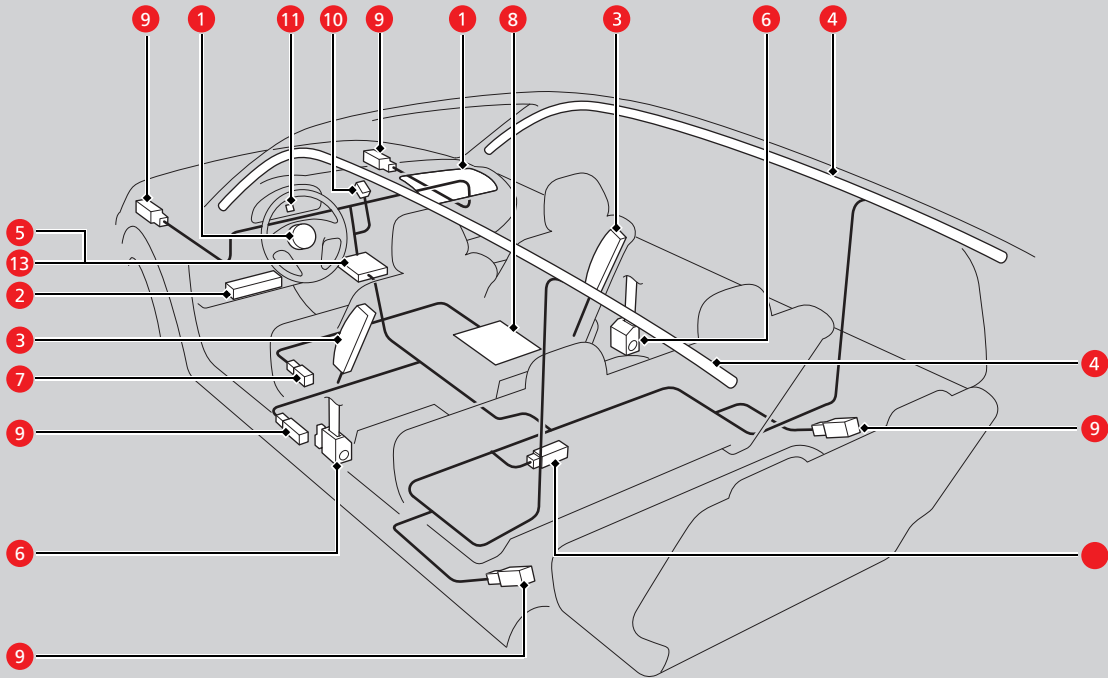

Index



Continued

The front, driver's knee, front side, and side curtain airbags are deployed according to the direction and severity of impact. Both side curtain airbags are deployed in a rollover. The airbag system includes:

- 1 Two SRS (Supplemental Restraint System) front airbags. The driver's airbag is stored in the center of the steering wheel; the front passenger's airbag is stored in the dashboard. Both are marked **SRS AIRBAG**.

- 2 Driver's knee airbag. The knee airbag is stored under the steering column. It is marked **SRS AIRBAG**.

- 3 Two side airbags, one for the driver and one for a front passenger. The airbags are stored in the outer edges of the seat-backs. Both are marked **SIDE AIRBAG**.

- 4 Two side curtain airbags, one for each side of the vehicle. The airbags are stored in the ceiling, above the side windows. The front and rear pillars are marked **SIDE CURTAIN AIRBAG**.

- 5 An electronic control unit that continually monitors and records information about the sensors, the airbag activators, the seat belt tensioners, and driver and front passenger seat belt use when the power mode is in ON.

- 6 Automatic front seat belt tensioners. The driver's and front passenger's seat belts incorporate sensors that detect whether or not they are fastened.

Models with CMBS™

The front seat belt tensioners also include the e-pretensioners.

- 7 A driver's seat position sensor. If the seat is too far forward, the airbag will inflate with less force.

- 8 Weight sensors in the front passenger's seat. The front passenger's airbag will be turned off if the weight on the seat is 65 lbs (29 kg) or less (the weight of an infant or small child).

- 9 Impact sensors that can detect a moderate to severe front or side impact.

- 10 An indicator on the dashboard that alerts you that the front passenger's front airbag has been turned off.

- 11 An indicator on the instrument panel that alerts you to a possible problem with your airbag system or seat belt tensioners.

- 12 Safing Sensor

- 13 A rollover sensor that detects whether the vehicle is about to roll over.

■ Important Facts About Your Airbags

Airbags can pose serious hazards. To do their job, airbags must inflate with tremendous force. So, while airbags help save lives, they can cause burns, bruises, and other minor injuries, and sometimes even fatal ones if occupants are not wearing their seat belts properly and sitting correctly.

What you should do: Always wear your seat belt properly, and sit upright and as far back from the steering wheel as possible while allowing full control of the vehicle. A front passenger should move their seat as far back from the dashboard as possible.

Remember, however, that no safety system can prevent all injuries or deaths that can occur in a severe crash, even when seat belts are properly worn and the airbags deploy.

Do not place hard or sharp objects between yourself and a front airbag.

Carrying hard or sharp objects on your lap, or driving with a pipe or other sharp object in your mouth, can result in injuries if your front airbag inflates.

Do not attach or place objects on the front and driver's knee airbag covers.

Objects on the covers marked **SRS AIRBAG** could interfere with the proper operation of the airbags or be propelled inside the vehicle and hurt someone if the airbags inflate.

▣ Important Facts About Your Airbags

Do not attempt to deactivate your airbags. Together, airbags and seat belts provide the best protection.

When driving, keep hands and arms out of the deployment path of the front airbag by holding each side of the steering wheel. Do not cross an arm over the airbag cover.

Types of Airbags

Your vehicle is equipped with four types of airbags:

- **Front airbags:** Airbags in front of the driver's and front passenger's seats.
- **Driver's knee airbag:** Airbag under the steering column.
- **Side airbags:** Airbags in the driver's and front passenger's seat-backs.
- **Side curtain airbags:** Airbags above the side windows.

Each is discussed in the following pages.

Front Airbags (SRS)

The front SRS airbags inflate in a moderate-to-severe frontal collision to help protect the head and chest of the driver and/or front passenger.

SRS (Supplemental Restraint System) indicates that the airbags are designed to supplement seat belts, not replace them. Seat belts are the occupant's primary restraint system.

Housing Locations

The front airbags are housed in the center of the steering wheel for the driver, and in the dashboard for the front passenger. Both airbags are marked **SRS AIRBAG**.

Types of Airbags

The airbags can inflate whenever the power mode is in ON.

After an airbag inflates in a crash, you may see a small amount of smoke. This is from the combustion process of the inflator material and is not harmful. People with respiratory problems may experience some temporary discomfort. If this occurs, get out of the vehicle as soon as it is safe to do so.

Front Airbags (SRS)

Dual-Stage, Multiple-Threshold Front Airbags (SRS)

Your vehicle is equipped with dual-stage, multiple-threshold front airbags (SRS).

During a frontal crash severe enough to cause one or both front airbags to deploy, the airbags can inflate at different rates, depending on the severity of the crash, whether or not the seat belts are latched, and/or other factors. Frontal airbags are designed to supplement the seat belts to help reduce the likelihood of head and chest injuries in frontal crashes.

■ Operation

Front airbags are designed to inflate during moderate-to-severe frontal collisions. When the vehicle decelerates suddenly, the sensors send information to the control unit which signals one or both front airbags to inflate.

A frontal collision can be either head-on or angled between two vehicles, or when a vehicle crashes into a stationary object, such as a concrete wall.

■ How the Front Airbags Work

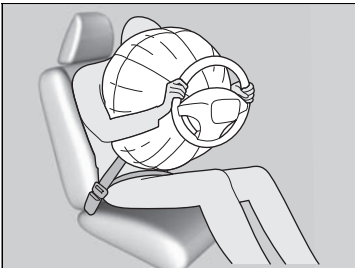

While your seat belt restrains your torso, the front airbag provides supplemental protection for your head and chest.

The front airbags deflate immediately so that they won't interfere with the driver's visibility or the ability to steer or operate other controls.

The total time for inflation and deflation is so fast that most occupants are not aware that the airbags deployed until they see them lying in front of them.

☒ How the Front Airbags Work

Although the driver's and front passenger's airbags normally inflate within a split second of each other, it is possible for only one airbag to deploy. This can happen if the severity of a collision is at the margin, or threshold that determines whether or not the airbags will deploy. In such cases, the seat belt will provide sufficient protection, and the supplemental protection offered by the airbag would be minimal.

■ When front airbags should not deploy

Minor frontal crashes: Front airbags were designed to supplement seat belts and help save lives, not to prevent minor scrapes, or even broken bones that might occur during a less than moderate-to-severe frontal crash.

Side impacts: Front airbags can provide protection when a sudden deceleration causes a driver or front passenger to move toward the front of the vehicle. Side airbags and side curtain airbags have been specifically designed to help reduce the severity of injuries that can occur during a moderate-to-severe side impact which can cause the driver or passenger to move toward the side of the vehicle.

Rear impacts: Head restraints and seat belts are your best protection during a rear impact. Front airbags cannot provide any significant protection and are not designed to deploy in such collisions.

Rollovers: Seat belts, and in vehicles equipped with a rollover sensor, side airbags, and side curtain airbags offer the best protection in a rollover. Because front airbags could provide little if any protection, they are not designed to deploy during a rollover.

■ When front airbags deploy with little or no visible damage

Because the airbag system senses sudden deceleration, a strong impact to the vehicle framework or suspension might cause one or more of the airbags to deploy. Examples include running into a curb, the edge of a hole, or other low fixed object that causes a sudden deceleration in the vehicle chassis. Since the impact is underneath the vehicle, damage may not be readily apparent.

■ When front airbags may not deploy, even though exterior damage appears severe

Since crushable body parts absorb crash energy during an impact, the amount of visible damage does not always indicate proper airbag operation. In fact, some collisions can result in severe damage but no airbag deployment because the airbags would not have been needed or would not have provided protection even if they had deployed.

Advanced Airbags

Your front airbags have advanced features to help reduce the likelihood of airbag related injuries to smaller occupants.

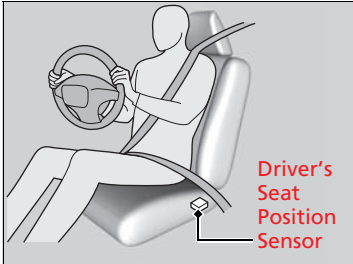

The driver's advanced front airbag system includes a seat position sensor.

If the seat is too far forward, the airbag inflates with less force, regardless of the severity of the impact.

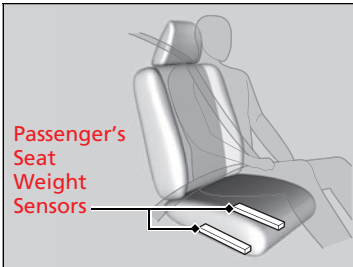

The passenger's advanced front airbag system has weight sensors.

Although Acura recommends against carrying an infant or small child in front, if the sensors detect the weight of a child (up to about 65 lbs or 29 kg), the system will automatically turn off the passenger's front airbag.

Advanced Airbags

If there is a problem with the driver's seat position sensor, the SRS indicator will come on and the airbag will inflate with full (normal) force, regardless of the driver's seating position.

For both advanced front airbags to work properly:

- Do not spill any liquid on or under the seats.
- Do not put any object under the passenger's seat.
- Make sure any objects are positioned properly on the floor. Improperly positioned objects can interfere with the advanced airbag sensors.
- All occupants should sit upright and wear their seat belts properly.
- Do not place any cover over the passenger side dashboard.

Make sure the floor mat behind the front passenger's seat is hooked to the floor mat anchor. An improperly placed mat can interfere with the advanced airbag sensors.

[▶ Floor Mats P. 433](#)

Driver's Knee Airbag

The driver's knee SRS airbag inflates in a moderate to severe frontal collision to help keep the driver in the proper position and to help maximize the benefit provided by the vehicle's other safety features.

SRS (Supplemental Restraint System) indicates that the airbag is designed to supplement seat belts, not replace them. Seat belts are the occupant's primary restraint system.

Driver's Knee Airbag

Do not attach accessories on or near the driver's knee airbag. They can interfere with the proper operation of the airbag, or hurt someone if an airbag inflates.

Housing Locations

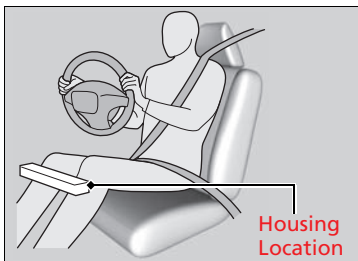

The driver's knee airbag is housed under the steering column for the driver.

The airbag is marked **SRS AIRBAG**.

Operation

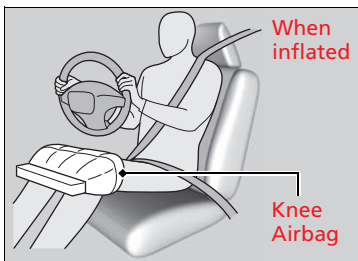

When the driver's front airbag inflates, the driver's knee airbag also inflates.

■ When driver's knee airbag deploys with little or no visible damage

Because the airbag system senses sudden deceleration, a strong impact to the vehicle framework or suspension might cause one or more of the airbags to deploy. Examples include running into a curb, the edge of a hole, or other low fixed object that causes a sudden deceleration in the vehicle chassis. Since the impact is underneath the vehicle, damage may not be readily apparent.

■ When driver's knee airbag may not deploy, even though exterior damage appears severe

Since crushable body parts absorb crash energy during an impact, the amount of visible damage does not always indicate proper airbag operation. In fact, some collisions can result in severe damage but no airbag deployment because the airbags would not have been needed or would not have provided protection even if they had deployed.

Side Airbags

The side airbags help protect the torso and pelvis of the driver or a front passenger during a moderate-to-severe side impact.

Housing Locations

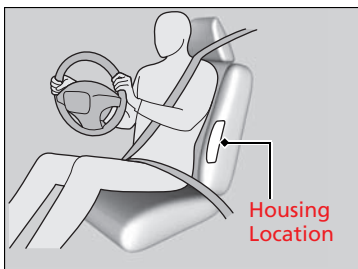

The side airbags are housed in the outside edge of the driver's and passenger's seat-backs.

Both are marked **SIDE AIRBAG**.

Operation

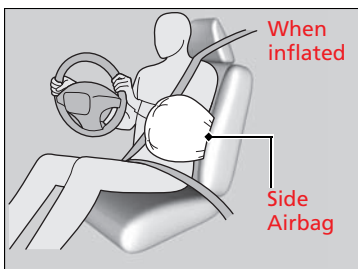

When the sensors detect a moderate-to-severe side impact, the control unit signals the side airbag on the impact side to immediately inflate.

Side Airbags

Do not attach accessories on or near the side airbags. They can interfere with the proper operation of the airbags, or hurt someone if an airbag inflates.

Do not cover or replace the front seat-back covers without consulting a dealer.

Improperly replacing or covering front seat-back covers can prevent your side airbags from properly deploying during a side impact.

■ When a side airbag deploys with little or no visible damage

Because the airbag system senses sudden acceleration, a strong impact to the side of the vehicle's framework can cause a side airbag to deploy. In such cases, there may be little or no damage, but the side impact sensors detected a severe enough impact to deploy the airbag.

■ When a side airbag may not deploy, even though visible damage appears severe

It is possible for a side airbag to not deploy during an impact that results in apparently severe damage. This can occur when the point of impact was toward the far front or rear of the vehicle, or when the vehicle's crushable body parts absorbed most of the crash energy. In either case, the side airbag would not have been needed nor provided protection even if it had deployed.

Side Curtain Airbags

Side curtain airbags help protect the heads of the driver and passengers in outer seating positions during a moderate-to-severe side impact. The side curtain airbags equipped in this vehicle are also designed to help reduce the likelihood of partial and complete ejection of vehicle occupants through side windows in crashes, particularly rollover crashes.

Housing Locations

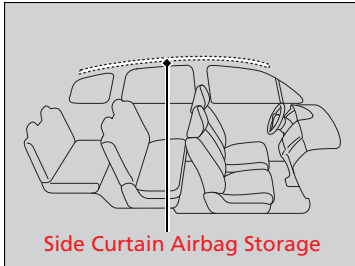

The side curtain airbags are located in the ceiling above the side windows on both sides of the vehicle.

Operation

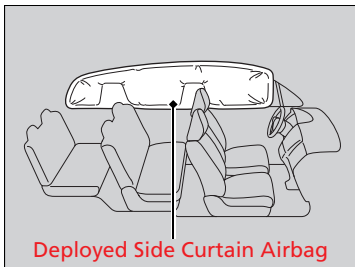

The side curtain airbag is designed to deploy in a rollover or a moderate-to-severe side impact.

Side Curtain Airbags

If the SRS control unit senses that your vehicle is about to rollover, it immediately deploys both side curtain airbags and activates both front seat belt tensioners.

The airbag on the passenger's side will deploy, even if there are no passengers on that side of the vehicle.

To get the best protection from the side curtain airbags, occupants should wear their seat belts properly and sit upright and well back in their seats.

Do not attach any objects to the side windows or roof pillars as they can interfere with the proper operation of the side curtain airbags.

■ When side curtain airbags deploy in a frontal collision

One or both side curtain airbags may inflate in a moderate to severe angled frontal collision.

In this case, the side curtain airbags will deploy slightly after the front airbags.

Airbag System Indicators

If a problem occurs in the airbag system, the SRS indicator will come on and a message appears on the MID.

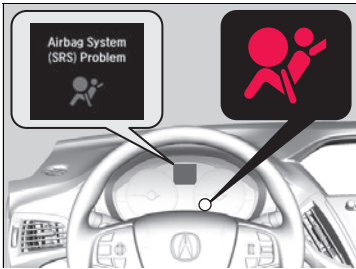
SRS (Supplemental Restraint System) Indicator**■ When the power mode is set to ON**

The indicator comes on for a few seconds, then goes off. This tells you the system is working properly.

If the indicator comes on at any other time, or does not come on at all, have the system checked by a dealer as soon as possible. If you don't, your airbags and seat belt tensioners may not work properly when they are needed.

ⓘ SRS (Supplemental Restraint System) Indicator

⚠ WARNING

Ignoring the SRS indicator can result in serious injury or death if the airbag systems or tensioners do not work properly.

Have your vehicle checked by a dealer as soon as possible if the SRS indicator alerts you to a possible problem.

■ Passenger Airbag Off Indicator

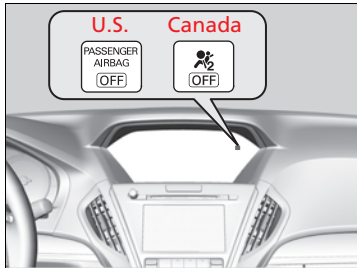

■ When the passenger airbag off indicator comes on

The indicator comes on to alert you that the passenger's front airbag has been turned off. This occurs when the front passenger's weight sensors detect 65 lbs (29 kg) or less, the weight of an infant or small child, on the seat.

Infants and small children should always ride properly restrained in a back seat.

➤ [Child Safety P. 54](#)

Objects placed on the seat can also cause the indicator to come on.

If the front passenger seat is empty, the passenger's front airbag will not deploy and the indicator will not come on.

☒ Passenger Airbag Off Indicator

If the indicator comes on with no front passenger and no objects on the passenger's seat, or with an adult riding there, something may be interfering with the weight sensors. Such as:

- An object hanging on the seat or in the seat-back pocket.
- A child seat or other object pressing against the rear of the seat-back.
- A rear passenger pushing or pulling on the back of the front passenger's seat.
- The front seat or seat-back is forced back against an object on the seat or floor behind it.
- An object placed under the front passenger's seat.

If none of these conditions exist, have your vehicle checked by a dealer as soon as possible.

The passenger airbag off indicator may come on and goes off repeatedly if the total weight on the seat is near the airbag cutoff threshold.

Airbag Care

You do not need to, and should not, perform any maintenance on or replace any airbag system components yourself. However, you should have your vehicle inspected by a dealer in the following situations:

■ When the airbags have deployed

If an airbag has inflated, the control unit and other related parts must be replaced. Similarly, once an automatic seat belt tensioner has been activated, it must be replaced.

■ When the vehicle has been in a moderate-to-severe collision

Even if the airbags did not inflate, have your dealer inspect the following: the driver's seat position sensor, weight sensors in the passenger's seat, front seat belt tensioners, and each seat belt that was worn during the crash.

■ Do not remove or modify a front seat without consulting a dealer

This would likely disable the driver's seat position sensor or the weight sensors in the passenger's seat. If it is necessary to remove or modify a front seat to accommodate a person with disabilities, contact an Acura dealer. For U.S. vehicles, Acura Client Service at 800-382-2238 and for Canadian vehicles, Acura Client Service at 888-9-ACURA-9.

✘ Airbag Care

We recommend against the use of salvaged airbag system components, including the airbag, tensioners, sensors, and control unit.

Protecting Child Passengers

Each year, many children are injured or killed in vehicle crashes because they are either unrestrained or not properly restrained. In fact, vehicle accidents are the number one cause of death of children ages 12 and under.

To reduce the number of child deaths and injuries, every state, Canadian province and territory requires that infants and children be properly restrained when they ride in a vehicle.

Children should sit properly restrained in a rear seat. This is because:

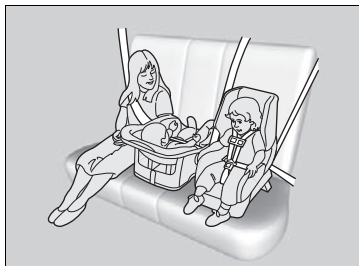

- An inflating front or side airbag can injure or kill a child sitting in the front seat.
- A child in the front seat is more likely to interfere with the driver's ability to safely control the vehicle.
- Statistics show that children of all sizes and ages are safer when they are properly restrained in a rear seat.

Protecting Child Passengers

WARNING

Children who are unrestrained or improperly restrained can be seriously injured or killed in a crash.

Any child too small for a seat belt should be properly restrained in a child seat. A larger child should be properly restrained with a seat belt, using a booster seat if necessary.

The National Highway Traffic Safety Administration and Transport Canada recommend that all children ages 12 and under be properly restrained in a rear seat. Some states or provinces/territories have laws restricting where children may ride.

- Any child who is too small to wear a seat belt correctly must be restrained in an approved child seat that is properly secured to the vehicle using either the lap belt portion of the lap/shoulder belt or the lower anchors of the LATCH system.
- Never hold a child on your lap because it is impossible to protect them in the event of a collision.
- Never put a seat belt over yourself and a child. During a crash, the belt would likely press deep into the child and cause serious or fatal injuries.
- Never let two children use the same seat belt. Both children could be very seriously injured in a crash.
- Do not allow children to operate the doors, windows or seat adjustments.
- Do not leave children in the vehicle unattended, especially in hot weather when the inside of the vehicle can get hot enough to kill them. They could also activate vehicle controls causing it to move unexpectedly.

 Protecting Child Passengers

 **WARNING**

Allowing a child to play with a seat belt or wrap one around their neck can result in serious injury or death.

Instruct children not to play with any seat belt and make sure any unused seat belt a child can reach is buckled, fully retracted, and locked.

To deactivate a lockable retractor, release the buckle and allow the seat belt to wind up all the way.

To remind you of the passenger's front airbag hazards and child safety, your vehicle warning came with a label on the dashboard (U.S. models) and has labels on the front visors. Please read and follow the instructions on these labels.

 [Safety Labels P. 67](#)

Safety of Infants and Small Children

■ Protecting Infants

An infant must be properly restrained in a rear-facing, reclining child seat until the infant reaches the seat maker's weight or height limit for the seat, and the infant is at least one year old.

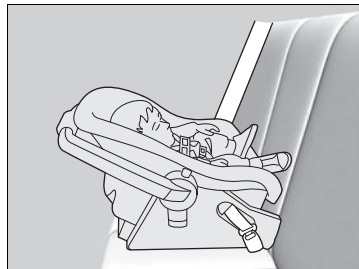

■ Positioning a rear-facing child seat

Child seats must be placed and secured in a rear seating position.

When properly installed, a rear-facing child seat may prevent the driver or a front passenger from moving their seat all the way back, or from locking their seat-back in the desired position.

It can also interfere with proper operation of the passenger's advanced front airbag system.

➤ [Airbags P. 39](#)

If this occurs, we recommend that you install the child seat directly behind the front passenger's seat, move the seat as far forward as needed, and leave it unoccupied. Or, you may wish to get a smaller rear-facing child seat.

▶▶ Protecting Infants

⚠ WARNING

Placing a rear-facing child seat in the front seat can result in serious injury or death during a crash.

Always place a rear-facing child seat in the rear seat, not the front.

Rear-facing child seats should never be installed in a forward facing position.

Always refer to the child seat manufacturer's instructions before installation.

Protecting Smaller Children

If a child is at least one year old and within the weight range indicated by the child seat manufacturer, the child should be properly restrained in a firmly secured forward-facing child seat.

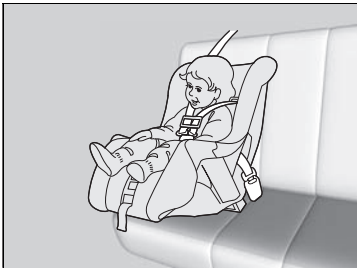

Forward-facing child seat placement

We strongly recommend placing a forward-facing child seat in a rear seating position.

Placing a forward-facing child seat in the front seat can be hazardous, even with advanced front airbags that automatically turn the passenger's front airbag off. A rear seat is the safest place for a child.

Protecting Smaller Children

WARNING

Placing a forward-facing child seat in the front seat can result in serious injury or death if the front airbag inflates.

If you must place a forward-facing child seat in front, move the vehicle seat as far back as possible, and properly restrain the child.

Educate yourself about the laws and regulations regarding child seat use where you are driving, and follow the child seat manufacturer's instructions.

Many experts recommend use of a rear-facing seat for a child up to two years old if the child's height and weight are appropriate for a rear-facing seat.

■ Selecting a Child Seat

Most child seats are LATCH-compatible (Lower Anchors and Tethers for Children). Some have a rigid-type connector while others have a flexible-type connector. Both are equally easy to use. Some existing and previously owned child seats can only be installed using the seat belt. Whichever type you choose, follow the child seat manufacturer's use and care instructions as well as the instructions in this manual. Proper installation is key to maximizing your child's safety.

In seating positions and vehicles not equipped with LATCH, a LATCH-compatible child seat can be installed using the seat belt and a top tether for added security. This is because all child seats are required to be designed so that they can be secured with a lap belt or the lap part of a lap/shoulder belt. In addition, the child seat manufacturer may advise that a seat belt be used to attach a LATCH-compatible seat once a child reaches a specified weight. Please read the child seat owner's manual for proper installation instructions.

■ Important consideration when selecting a child seat

Make sure the child seat meets the following three requirements:

- The child seat is the correct type and size for the child.
- The child seat is the correct type for the seating position.
- The child seat is compliant with Federal Motor Vehicle Safety Standard 213 or Canadian Motor Vehicle Safety Standard 213.

▶▶ Selecting a Child Seat

Installation of a LATCH-compatible child seat is simple.

LATCH-compatible child seats have been developed to simplify the installation process and reduce the likelihood of injuries caused by incorrect installation.

■ Installing a LATCH-Compatible Child Seat

A LATCH-compatible child seat can be installed in the second row seats. A child seat is attached to the lower anchors with either the rigid or flexible type of connectors.

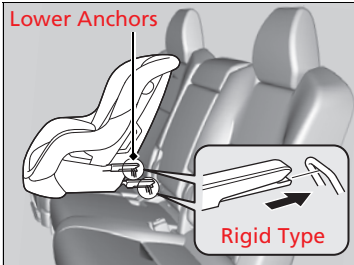
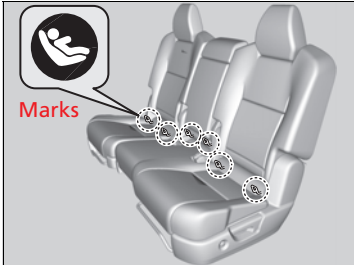

1. Locate the lower anchors under the marks.

2. Place the child seat on the vehicle seat then attach the child seat to the lower anchors according to the instructions that came with the child seat.

- ▶ When installing the child seat, make sure that the lower anchors are not obstructed by the seat belt or any other object.

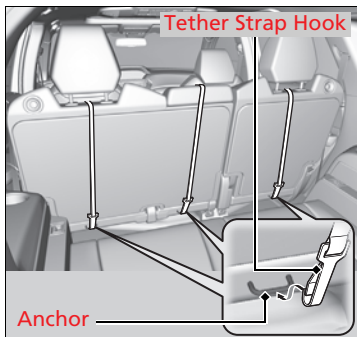
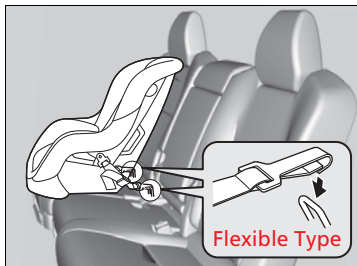

Outer positions

- Put the outer head restraint to its uppermost position, then route the tether strap between the head restraint legs, and secure the tether strap hook onto the anchor. Make sure the strap is not twisted.

Center position

- Put the center head restraint to its lowest position, then route the tether strap over the top of the head restraint and secure the tether strap hook onto the anchor. Make sure the strap is not twisted.

All positions

- Tighten the tether strap as instructed by the child seat manufacturer.
- Make sure the child seat is firmly secured by rocking it forward and back and side to side; little movement should be felt.
- Make sure any unused seat belt that a child can reach is buckled, the lockable retractor is activated, and the belt is fully retracted and locked.

[▶ Protecting Child Passengers P. 54](#)

▶▶ Installing a LATCH-Compatible Child Seat

For your child's safety, when using a child seat installed using the LATCH system, make sure that the child seat is properly secured to the vehicle. A child seat that is not properly secured will not adequately protect a child in a crash and may cause injury to the child or other vehicle occupants.

Installing a Child Seat with a Lap/Shoulder Seat Belt

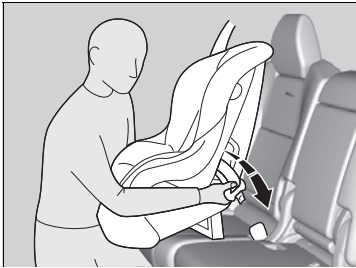

1. Place the child seat on the vehicle seat.

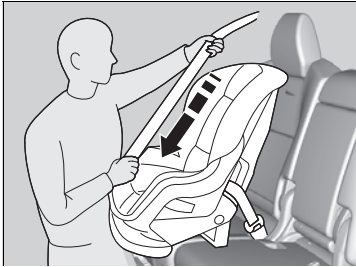

2. Route the seat belt through the child seat according to the seat maker's instructions, and insert the latch plate into the buckle.
▶ Insert the latch plate fully until it clicks.



3. Slowly pull the shoulder part of the belt all the way out until it stops. This activates the lockable retractor.

4. Let the seat belt completely wind up into the retractor, then try to pull it out to make sure the retractor is locked.
▶ If you are able to pull the shoulder belt out, the lockable retractor is not activated. Pull the seat belt all the way out, and repeat steps 3 – 4.

5. Grab the shoulder part of the seat belt near the buckle, and pull up to remove any slack from the lap part of the belt.
▶ When doing this, place your weight on the child seat and push it into the vehicle seat.

Installing a Child Seat with a Lap/Shoulder Seat Belt

A child seat that is not properly secured will not adequately protect a child in a crash and may cause injury to the child or other vehicle occupants.

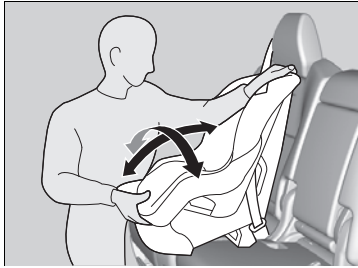

6. Make sure the child seat is firmly secured by rocking it forward and back and side to side; little movement should be felt.
7. Make sure any unused seat belt that a child can reach is buckled, the lockable retractor is activated, and the belt is fully retracted and locked.

► [Protecting Child Passengers P. 54](#)

■ Adding Security with a Tether

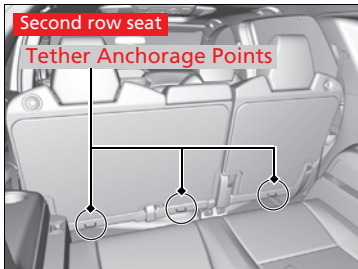

A tether anchorage point is provided behind each second and third row seating position. A child seat that is installed with a seat belt and comes with a tether can use the tether for additional security.

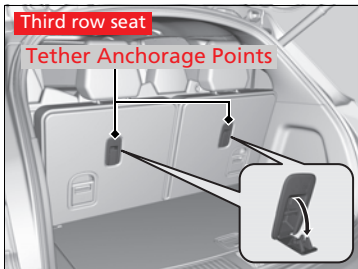

►► Installing a Child Seat with a Lap/Shoulder Seat Belt

To deactivate a lockable retractor, release the buckle and allow the seat belt to wind up all the way.

►► Adding Security with a Tether

Since a tether can provide additional security to the lap/shoulder seat belt installation, we recommend using a tether whenever one is available.

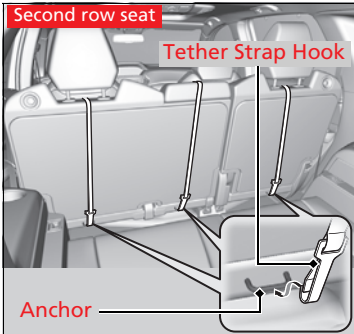

■ Using a second row anchor

Outer positions

1. Put the outer head restraint to its uppermost position, then route the tether strap between the head restraint legs, and secure the tether strap hook onto the anchor. Make sure the strap is not twisted.

Center position

1. Put the center head restraint to its lowest position, then route the tether strap over the top of the head restraint and secure the tether strap hook onto the anchor. Make sure the strap is not twisted.

All positions

2. Tighten the tether strap as instructed by the child seat manufacturer.

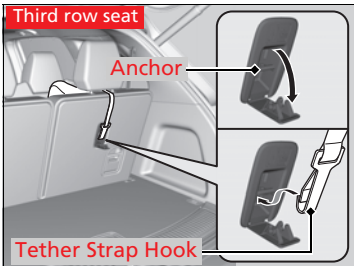

■ Using a third row anchor

1. Pull up the head restraint and push rearwards until it latches, then route the tether strap through the head restraint legs. Make sure the strap is not twisted.
2. Open the anchor cover.
3. Secure the tether strap hook onto the anchor.
4. Tighten the tether strap as instructed by the child seat manufacturer.

Safety of Larger Children

■ Protecting Larger Children

The following pages give instructions on how to check proper seat belt fit, what kind of booster seat to use if one is needed, and important precautions for a child who must sit in front.

■ Checking Seat Belt Fit

When a child is too big for a child seat, secure the child in a rear seat using the lap/shoulder seat belt. Have the child sit upright and all the way back, then answer the following questions.

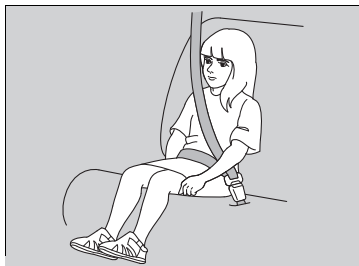

■ Checklist

- Do the child's knees bend comfortably over the edge of the seat?
- Does the shoulder belt cross between the child's neck and arm?
- Is the lap part of the seat belt as low as possible, touching the child's thighs?
- Will the child be able to stay seated like this for the whole trip?

If you answer yes to all these questions, the child is ready to wear the lap/shoulder seat belt correctly. If you answer no to any question, the child needs to ride on a booster seat until the seat belt fits properly without a booster seat.

▶ Safety of Larger Children

⚠ WARNING

Allowing a child age 12 or under to sit in front can result in injury or death if the passenger's front airbag inflates.

If a larger child must ride in front, move the vehicle seat as far to the rear as possible, have the child sit up properly and wear the seat belt properly, using a booster seat if needed.

Booster Seats



If a lap/shoulder seat belt cannot be used properly, position the child in a booster seat in a rear seating position. For the child's safety, check that the child meets the booster seat manufacturer's recommendations.

Protecting Larger Children-Final Checks

Your vehicle has a rear seat where children can be properly restrained. If you ever have to carry a group of children, and a child must ride in front:

- Make sure you read and fully understand the instructions and safety information in this manual.
- Move the front passenger seat as far back as possible.
- Have the child sit upright and well back in the seat.
- Check that the seat belt is properly positioned so that the child is secure in the seat.

Monitoring child passengers

We strongly recommend that you keep an eye on child passengers. Even older, more mature children sometimes need to be reminded to fasten their seat belts and sit up properly.

Booster Seats

When installing a booster seat, make sure to read the instructions that came with it, and install the seat accordingly.

There are high- and low-type booster seats. Choose a booster seat that allows the child to wear the seat belt correctly.

Some U.S. states, and Canadian provinces and territories require children to use a booster seat until they reach a given age or weight (e.g. six years or 60 lbs). Be sure to check current laws in the state or province, or territory where you intend to drive.

Carbon Monoxide Gas

The engine exhaust from this vehicle contains carbon monoxide, a colorless, odorless, and highly toxic gas. As long as you properly maintain your vehicle, carbon monoxide gas will not get into the interior.

■ Have the exhaust system inspected for leaks whenever

- The exhaust system is making an unusual noise.
- The exhaust system may have been damaged.
- The vehicle is raised for an oil change.

When you operate a vehicle with the tailgate open, airflow can pull exhaust gas into the interior and create a hazardous condition. If you must drive with the tailgate open, open all the windows and set the climate control system as shown below.

1. Select the fresh air mode.
2. Select the  mode.
3. Set the fan speed to high.
4. Set the temperature control to a comfortable setting.

Adjust the climate control system in the same manner if you sit in your parked vehicle with the engine running.

Carbon Monoxide Gas

WARNING

Carbon monoxide gas is toxic. Breathing it can cause unconsciousness and even kill you.

Avoid any enclosed areas or activities that expose you to carbon monoxide.

An enclosed area such as a garage can quickly fill up with carbon monoxide gas.

Do not run the engine with the garage door closed. Even when the garage door is open, drive out of the garage immediately after starting the engine.

Label Locations

These labels are in the locations shown. They warn you of potential hazards that can cause serious injury or death. Read these labels carefully.

If a label comes off or becomes hard to read (except for the U.S. dashboard label which may be removed by the owner), contact a dealer for a replacement.

Sun Visor

U.S. models

WARNING
EVEN WITH ADVANCED AIR BAGS

- Children can be killed or seriously injured by the air bag.
- The back seat is the safest place for children.
- Never put a child or baby child seat in the front.
- Always use seat belts and child restraints.
- See owner's manual for more information about air bags.

Canadian models

CAUTION
TO AVOID SERIOUS INJURY:

- FOR MAXIMUM SAFETY PROTECTION IN ALL TYPES OF CRASHES YOU MUST ALWAYS WEAR YOUR SAFETY BELT.
- DO NOT INSTALL REARWARD-FACING CHILD SEATS IN ANY FRONT PASSENGER SEAT POSITION.
- DO NOT SIT OR LEAN UNNECESSARILY CLOSE TO THE AIR BAG.
- DO NOT PLACE ANY OBJECTS OVER THE AIR BAG OR BETWEEN THE AIR BAG AND YOURSELF.
- SEE THE OWNER'S MANUAL FOR FURTHER INFORMATION AND EXPLANATIONS.

PRECAUTIONS:
POUR PROFITER D'UNE PROTECTION MAXIMALE LORS D'UNE COLLISION BOUCLEZ TOUJOURS VOTRE CEINTURE DE SECURITE.

- N'INSTALLEZ JAMAIS UN SIEGE POUR ENFANTS FAISANT FACE A L'ARRIERE SUR LE SIEGE DU PASSAGER AVANT.
- NE VOUS APPUYEZ PAS ET NE VOUS ASSOYEZ PAS PRES DU COUSSIN GONFLABLE.
- NE DEPOSEZ AUCUN OBJET SUR LE COUSSIN GONFLABLE OU ENTRE LE COUSSIN GONFLABLE ET VOUS.
- LISEZ LE GUIDE UTILISATEUR POUR DE PLUS AMPLES RENSEIGNEMENTS.

Sun Visor

U.S. models only

WARNING: HIGHER ROLLOVER RISK

Avoid Abrupt Maneuvers and Excessive Speed. Always Buckle Up. See Owner's Manual For Further Information.

Dashboard

U.S. models only

This Vehicle is Equipped with Advanced Air Bags

Even with Advanced Air Bags, children can be killed or seriously injured by the air bag. The back seat is the safest place for children. Never put a child or baby child seat in the front. Always use seat belts and child restraints. See owner's manual for more information about air bags.

Radiator Cap

DANGER WARNING
 危険 危険

▶ NEVER OPEN WHEN HOT.
 Hot coolant will scald you.
 ▶ N'OUVREZ PAS QUAND CHAUD.
 Le fluide de refroidissement est chaud.
 ▶ 熱い液体が飛び出すので、決して蓋を開けないでください。
 高温時に、液体が飛び出す。

1.1

Doorjamb

SIDE AIRBAG

- This car is equipped with side airbags in the front seats and side curtain airbags.
- Do not lean against the door.
- See owner's manual for more information.

U.S. models

Canadian models

SIDE AIRBAG

- This car is equipped with side airbags in the front seats and side curtain airbags.
- Do not lean against the door.
- See owner's manual for more information.

COUSSIN GONFLABLE LATÉRAL

- Cette automobile est équipée de coussins gonflables latéraux dans les sièges avant ainsi que de coussins gonflables latéraux de type rideau.
- Né vous appuyez pas sur la porte.
- Consultez le Manuel du propriétaire pour en savoir plus.

Instrument Panel







This chapter describes the buttons, indicators, and gauges that are used while driving.







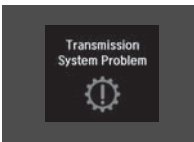

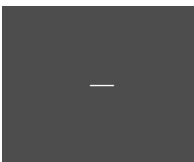

- Indicators** 70
 - Multi-Information Display (MID)
 - Warning and Information Messages. 84
- Gauges and Multi-Information Display (MID)**
 - Gauges..... 97
 - MID 98



Indicator	Name	On/Blinking	Explanation	Message
	Parking Brake and Brake System Indicator (Red)	<ul style="list-style-type: none"> Comes on for a few seconds when you set the power mode to ON, then goes off. Comes on when the parking brake is applied, and goes off when it is released. Comes on when the brake fluid level is low. Comes on if there is a problem with the brake system. The beeper sounds and the indicator comes on if you drive with the parking brake not fully released. 	<ul style="list-style-type: none"> Comes on while driving - Make sure the parking brake is released. Check the brake fluid level. <ul style="list-style-type: none"> ➤ What to do when the indicator comes on while driving P. 467 Comes on along with the ABS indicator - Have your vehicle checked by a dealer. <ul style="list-style-type: none"> ➤ If the Brake System Indicator (Red) Comes On P. 467 	
	Brake System Indicator (Amber)	<ul style="list-style-type: none"> Comes on for a few seconds when you set the power mode to ON, then goes off. Comes on if there is a problem with a system related to braking other than the conventional brake system. 	<ul style="list-style-type: none"> Comes on while driving - Have your vehicle checked by a dealer. With this indicator on, your vehicle still has normal braking ability. 	

Indicator	Name	On/Blinking	Explanation	Message
	Low Oil Pressure Indicator	<ul style="list-style-type: none"> Comes on when you set the power mode to ON, and goes off when the engine starts. Comes on when the engine oil pressure is low. 	<ul style="list-style-type: none"> Comes on while driving - Immediately stop in a safe place. <ul style="list-style-type: none"> ► If the Low Oil Pressure Indicator Comes On P. 465 	
	Malfunction Indicator Lamp	<ul style="list-style-type: none"> Comes on when you set the power mode to ON, and goes off either when the engine starts or after several seconds if the engine did not start. If “readiness codes” have not been set, it blinks five times before it goes off. Comes on if there is a problem with the emissions control systems. Blinks when a misfire in the engine’s cylinders is detected. 	<ul style="list-style-type: none"> Readiness codes are part of the on board diagnostics for the emissions control systems. <ul style="list-style-type: none"> ► Testing of Readiness Codes P. 485 Comes on while driving - Have your vehicle checked by a dealer. Blinks while driving - Stop in a safe place where there are no flammable objects. Stop the engine for 10 minutes or more, and wait for it to cool down. Then, take your vehicle to a dealer. <ul style="list-style-type: none"> ► If the Malfunction Indicator Lamp Comes On or Blinks P. 466 	
	Charging System Indicator	<ul style="list-style-type: none"> Comes on when you set the power mode to ON, and goes off when the engine starts. Comes on when the battery is not charging. 	<ul style="list-style-type: none"> Comes on while driving - Turn off the climate control system and rear defogger in order to reduce electricity consumption. <ul style="list-style-type: none"> ► If the Charging System Indicator Comes On P. 465 	

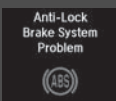
Indicator	Name	On/Blinking	Explanation	Message
	Shift Lever Position Indicator	<ul style="list-style-type: none"> Indicates current shift lever position. 	<p> Shifting P. 329</p>	
	Transmission Indicator	<ul style="list-style-type: none"> Blinks if the transmission system has a problem. 	<ul style="list-style-type: none"> Blinks while driving - Avoid sudden starts and acceleration and have your vehicle checked by a dealer immediately. 	
	M (sequential shift mode) Indicator/Gear Position Indicator	<ul style="list-style-type: none"> Comes on when the manual sequential shift mode is applied. 	<p> Sequential Shift Mode P. 331</p>	

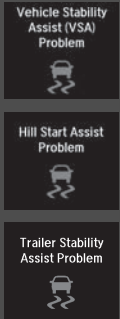

Indicator	Name	On/Blinking	Explanation	Message
	Seat Belt Reminder Indicator	<ul style="list-style-type: none"> • Comes on and the beeper sounds if you are not wearing a seat belt when you set the power mode to ON. • If the front passenger is not wearing a seat belt, the indicator comes on about a few seconds later. • Blinks while driving if either you or the front passenger has not fastened a seat belt. The beeper sounds and the indicator blinks at regular intervals. 	<ul style="list-style-type: none"> • The beeper stops and the indicator goes off when you and the front passenger fasten their seat belts. • Stays on after you or the front passenger has fastened the seat belt - A detection error may have occurred in the sensor. Have your vehicle checked by a dealer. ▶ Seat Belt Reminder P. 32 	 
	Low Fuel Indicator	<ul style="list-style-type: none"> • Comes on when the fuel reserve is running low (approximately 2.5 U.S. gal./9.5 Liter left). • Blinks if there is a problem with the fuel gauge. 	<ul style="list-style-type: none"> • Comes on - Refuel your vehicle as soon as possible. • Blinks - Have your vehicle checked by a dealer. 	 





Indicator	Name	On/Blinking	Explanation	Message
	Anti-lock Brake System (ABS) Indicator	<ul style="list-style-type: none"> • Comes on for a few seconds when you set the power mode to ON, then goes off. • If it comes on at any other time, there is a problem with the ABS. 	<ul style="list-style-type: none"> • Stays on constantly - Have your vehicle checked by a dealer. With this indicator on, your vehicle still has normal braking ability but no anti-lock function. ▶ Anti-lock Brake System (ABS) P. 369 	
	Supplemental Restraint System Indicator	<ul style="list-style-type: none"> • Comes on for a few seconds when you set the power mode to ON, then goes off. • Comes on if a problem with any of the following is detected: <ul style="list-style-type: none"> - Supplemental restraint system - Side airbag system - Side curtain airbag system - Seat belt tensioner 	<ul style="list-style-type: none"> • Stays on constantly or does not come on at all - Have your vehicle checked by a dealer. 	







Indicator	Name	On/Blinking	Explanation	Message
	Vehicle Stability Assist (VSA®) System Indicator	<ul style="list-style-type: none"> • Comes on for a few seconds when you set the power mode to ON, then goes off. • Blinks when VSA®, or trailer stability assist is active. • Comes on if there is a problem with the VSA®, hill start assist, trailer stability assist or brake lighting system. 	<ul style="list-style-type: none"> • Stays on constantly - Have your vehicle checked by a dealer. <ul style="list-style-type: none"> ➤ VSA® (Vehicle Stability Assist), aka ESC (Electronic Stability Control), System P. 358 ➤ Trailer Stability Assist* P. 317 ➤ Hill start assist system P. 326 • When Trailer Stability Assist Problem is displayed on the MID, the VSA® does not activate. 	
	VSA® OFF Indicator	<ul style="list-style-type: none"> • Comes on for a few seconds when you set the power mode to ON, then goes off. • Comes on when you deactivate VSA®. 	<ul style="list-style-type: none"> ➤ VSA® On and Off P. 359 	—

* Not available on all models





Indicator	Name	On/Blinking	Explanation	Message
	Speed-sensitive Electric Power Steering (EPS) System Indicator	<ul style="list-style-type: none"> Comes on when you set the power mode to ON, and goes off when the engine starts. Comes on if there is a problem with the EPS system. 	<ul style="list-style-type: none"> Stays on constantly or does not come on at all - Have your vehicle checked by a dealer. ► If the Speed-Sensitive Electric Power Steering (EPS) System Indicator Comes On P. 467 	
	Low Tire Pressure/TPMS Indicator	<ul style="list-style-type: none"> Comes on for a few seconds when you set the power mode to ON. Comes on if the tire pressure of any of the tires becomes significantly low. Blinks for about one minute, and then stays on if there is a problem with the TPMS, or when a compact spare tire* is temporarily installed. 	<ul style="list-style-type: none"> Comes on while driving - Stop in a safe place, check tire pressures, and inflate the tire(s) if necessary. Blinks and remains on - Have your vehicle checked by a dealer. If the vehicle is fitted with a compact spare, get your regular tire repaired or replaced and put back on your vehicle as soon as you can. 	
	Turn Signal Indicators	<ul style="list-style-type: none"> Blinks when you operate the turn signal lever. Blinks along with all turn signals if you press the hazard warning button. 	<ul style="list-style-type: none"> Does not blink or blinks rapidly - A turn signal light bulb has blown. Change the bulb immediately. ► Front Turn Signal/Front Side Marker/Parking Light Bulbs P. 408 	—
	High Beam Indicator	<ul style="list-style-type: none"> Comes on when the high beam headlights are on. 	—	—





Indicator	Name	On/Blinking	Explanation	Message
	Lights On Indicator	<ul style="list-style-type: none"> Comes on whenever the light switch is on, or in AUTO when the exterior lights are on. 	<ul style="list-style-type: none"> If you set the power mode to ACCESSORY or VEHICLE OFF (LOCK) while the lights are on, a chime sounds when the driver's door is opened. 	—
	Immobilizer System Indicator	<ul style="list-style-type: none"> Comes on briefly when you set the power mode to ON, then goes off. Comes on if the immobilizer system cannot recognize the key information. 	<ul style="list-style-type: none"> Blinks - You cannot start the engine. Set the power mode to VEHICLE OFF (LOCK), then select the ON mode again. Repeatedly blinks - The system may be malfunctioning. Have your vehicle checked by a dealer. Do not attempt to alter this system or add other devices to it. Electrical problems can occur. 	—

Indicator	Name	On/Blinking	Explanation	Message
	Security System Alarm Indicator	<ul style="list-style-type: none"> Blinks when the security system alarm has been set. 	<p>▶ Security System Alarm P. 135</p>	—
	System Message Indicator	<ul style="list-style-type: none"> Comes on for a few seconds when you set the power mode to ON, then goes off. Comes on along with a beep when a problem is detected. A system message on the MID appears at the same time. 	<ul style="list-style-type: none"> While the indicator is on, roll the multi-function steering wheel control to see the message again. Refer to the Indicators information in this chapter when a system message appears on the MID. Take the appropriate action for the message. The MID does not return to the normal screen unless the warning is canceled, or the multi-function steering-wheel controls is rolled. 	—
	CRUISE MAIN Indicator*	<ul style="list-style-type: none"> Comes on when you press the CRUISE button. 	<p>▶ Cruise Control P. 334</p>	—
	CRUISE CONTROL Indicator*	<ul style="list-style-type: none"> Comes on when you have set a speed for cruise control. 	<p>▶ Cruise Control P. 334</p>	—

Indicator	Name	On/Blinking	Explanation	Message
	Keyless Access System Indicator	<ul style="list-style-type: none"> Comes on for a few seconds when you set the power mode to ON. Comes on as soon as a problem is detected in the keyless access system or keyless starting system. 	<ul style="list-style-type: none"> Have your vehicle checked by a dealer. 	 
	Super Handling-All Wheel Drive™ (SH-AWD®) Indicator*	<ul style="list-style-type: none"> Comes on for a few seconds when you set the power mode to ON, then goes off. Comes on if there is a problem with the SH-AWD® system. Blinks when the differential temperature is too high. 	<ul style="list-style-type: none"> Stays on constantly - The engine drives the front wheels only in this state. Have your vehicle checked by a dealer. 	
			<ul style="list-style-type: none"> Blinks while driving - Stop in a safe place, shift to P, and idle the engine until the indicator goes off. If the indicator does not stop blinking, take your vehicle to a dealer. <p>➤ Super Handling-All Wheel Drive™ (SH-AWD®)* P. 363</p>	

* Not available on all models

Indicator	Name	On/Blinking	Explanation	Message
<p>FCW</p>	<p>Forward Collision Warning (FCW) Indicator*</p>	<ul style="list-style-type: none"> • Comes on for a few seconds when you set the power mode to ON, then goes off. • Comes on when you have customized FCW to turn off. • Comes on if there is a problem with the FCW system. 	<ul style="list-style-type: none"> • Stays on constantly without FCW off - Have your vehicle checked by a dealer. 	 
		<ul style="list-style-type: none"> • Comes on when the FCW system shuts itself off. 	<ul style="list-style-type: none"> • Stays on - The temperature inside the FCW system is too high. The system activates when the temperature inside the system cools down. Automatic shutoff P. 348 	
			<ul style="list-style-type: none"> • Stays on - The area around the camera is blocked by dirt, mud, etc. Stop your vehicle in a safe place, and wipe it off with a soft cloth. • Have your vehicle checked by a dealer if the indicator and message come back on after you cleaned the area around the camera. Automatic shutoff P. 348 	

Indicator	Name	On/Blinking	Explanation	Message
<p>LDW</p>	<p>Lane Departure Warning (LDW) Indicator*</p>	<ul style="list-style-type: none"> • Comes on for a few seconds when you set the power mode to ON, then goes off. • Comes on if there is a problem with the LDW system. 	<ul style="list-style-type: none"> • Stays on constantly - Have your vehicle checked by a dealer. 	
		<ul style="list-style-type: none"> • Comes on when the LDW system shuts itself off. 	<ul style="list-style-type: none"> • Stays on - The temperature inside the LDW camera is too high. Use the climate control system to cool down the camera. The system activates when the temperature inside the camera cools down. ► LDW Camera P. 351 	<p>*1</p>  <p>*2</p> 
			<p>Models without LKAS</p> <ul style="list-style-type: none"> • Stays on - The area around the camera is blocked by dirt, mud, etc. Stop your vehicle in a safe place, and wipe it off with a soft cloth. • Have your vehicle checked by a dealer if the indicator and message come back on after you cleaned the area around the camera. ► LDW Camera P. 351 	

*1: Models without LKAS

*2: Models with LKAS

Indicator	Name	On/Blinking	Explanation	Message
	Adaptive Cruise Control (ACC) with Low Speed Follow (LSF) Indicator (Amber)*	<ul style="list-style-type: none"> Comes on for a few seconds when you set the power mode to ON, then goes off. Comes on if there is a problem with ACC with LSF. 	<ul style="list-style-type: none"> Comes on while driving - Have your vehicle checked by a dealer. 	
	Adaptive Cruise Control (ACC) with Low Speed Follow (LSF) Indicator (Green)*	<ul style="list-style-type: none"> Comes on when you press the MAIN button. 	<p>▶ Adaptive Cruise Control (ACC) with Low Speed Follow (LSF)* P. 337</p>	
	Lane Keeping Assist System (LKAS) Indicator (Amber)*	<ul style="list-style-type: none"> Comes on for a few seconds when you set the power mode to ON, then goes off. Comes on if there is a problem with the LKAS. 	<ul style="list-style-type: none"> Stays on constantly - Have your vehicle checked by a dealer. 	
	Lane Keeping Assist System (LKAS) Indicator (Green)*	<ul style="list-style-type: none"> Comes on when you press the MAIN button. 	<p>▶ Lane Keeping Assist System (LKAS)* P. 353</p>	

Indicator	Name	On/Blinking	Explanation	Message
	Blind Spot Information (BSI) Indicator*	<ul style="list-style-type: none"> Comes on for a few seconds when you set the power mode to ON, then goes off. Stays on while BSI is turned off. 	—	
		<ul style="list-style-type: none"> Comes on when mud, snow, or ice accumulates in the vicinity of sensor. 	<ul style="list-style-type: none"> Comes on while driving - Remove the obstacle in the vicinity of sensor. ► Blind Spot Information (BSI) System* P. 361 	
		<ul style="list-style-type: none"> Comes on if there is a problem with the system. 	<ul style="list-style-type: none"> Comes on while driving - Have your vehicle checked by a dealer. 	
	Collision Mitigation Brake System™ (CMBS™) Indicator*	<ul style="list-style-type: none"> Comes on for a few seconds when you set the power mode to ON, then goes off. Comes on when you deactivate the CMBS™. A MID message appears for a few seconds. Comes on if there is a problem with the CMBS™. 	<ul style="list-style-type: none"> Stays on constantly without the CMBS™ off - Have your vehicle checked by a dealer. ► Collision Mitigation Braking System™ (CMBS™)* P. 371 	

* Not available on all models

Multi-Information Display (MID) Warning and Information Messages

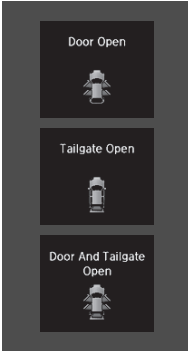
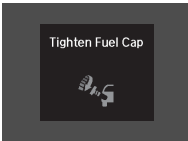

The following messages appear only on the MID. Roll the multi-function steering-wheel controls to see the message again with the system message indicator on.

Message	Condition	Explanation
 <p>Door Open</p> <p>Tailgate Open</p> <p>Door And Tailgate Open</p>	<ul style="list-style-type: none"> Appears if any door or the tailgate is not completely closed. 	<ul style="list-style-type: none"> Goes off when all doors and the tailgate are closed.
 <p>Tighten Fuel Cap</p>	<ul style="list-style-type: none"> Appears when the fuel fill cap is loose or is not installed. 	<p>▶ Tighten Fuel Cap Message P. 466</p>

QRG

TOC

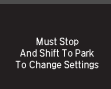
Instrument Panel

Message	Condition	Explanation
<p>Canadian models</p> 	<ul style="list-style-type: none"> Appears when the washer fluid is low. 	<ul style="list-style-type: none"> Refill washer fluid. <ul style="list-style-type: none"> ► Refilling Window Washer Fluid P. 406
	<ul style="list-style-type: none"> Appears while you are customizing the settings and the shift lever is moved out of P. 	<ul style="list-style-type: none"> ► Customized Features P. 104
	<ul style="list-style-type: none"> Appears when the transmission fluid temperature is too high. 	<ul style="list-style-type: none"> Stop in a safe place in P. Let the engine idle until the message disappears.
	<ul style="list-style-type: none"> Appears when there is a problem with the sensor on the battery. Appears along with the battery charging system indicator when the battery is not charging. 	<ul style="list-style-type: none"> Have your vehicle checked by a dealer. <ul style="list-style-type: none"> ► Checking the Battery P. 426 Turn off the climate control system and rear defogger to reduce electricity consumption. <ul style="list-style-type: none"> ► If the Charging System Indicator Comes On P. 465





Index

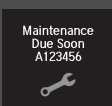

QRG

TOC

Instrument Panel

Message	Condition	Explanation
	<ul style="list-style-type: none"> • Appears when the scheduled maintenance is due soon. • Consequently, Maintenance Due Now and Maintenance Past Due follow. 	<p>➤ Maintenance Minder Messages on the Multi-Information Display (MID) P. 392</p>
	<ul style="list-style-type: none"> • Appears when the engine coolant temperature gets abnormally high. 	<p>➤ Overheating P. 463</p>
<div style="text-align: center;"> <p>U.S.</p>  <p>Canada</p>  </div>	<ul style="list-style-type: none"> • Appears when there is a problem with the power tailgate system. 	<ul style="list-style-type: none"> • Manually open or close the power tailgate. • Have your vehicle checked by a dealer.



Index



QRG



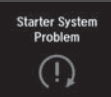

TOC

Instrument Panel

Message	Condition	Explanation
<p>U.S.</p>  <p>Canada</p> 	<ul style="list-style-type: none"> Appears if there is a problem with the starting system. 	<ul style="list-style-type: none"> Hold the ENGINE START/STOP button up to 15 seconds to start the engine. <ul style="list-style-type: none"> ► Starting the Engine P. 322 Have your vehicle checked by a dealer.
	<ul style="list-style-type: none"> Appears when you set the power mode to ACCESSORY or ON. 	<ul style="list-style-type: none"> ► Starting the Engine P. 322
	<ul style="list-style-type: none"> Appears when the steering wheel is locked. 	<ul style="list-style-type: none"> Move the steering wheel left and right after pressing the ENGINE START/STOP button.

Index

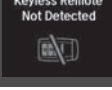





Message	Condition	Explanation
	<ul style="list-style-type: none"> Appears if you press the ENGINE START/STOP button to turn the engine off without the shift lever in P. 	<ul style="list-style-type: none"> Press the ENGINE START/STOP button twice after moving the shift lever to P.
	<ul style="list-style-type: none"> Appears when the power mode is in ACCESSORY. 	—
	<ul style="list-style-type: none"> Appears after the driver's door is opened when the power mode is in ACCESSORY. 	<ul style="list-style-type: none"> Press the ENGINE START/STOP button twice with your foot off the brake pedal to change the power mode to VEHICLE OFF (LOCK).
	<ul style="list-style-type: none"> Appears when you close the door with the power mode is in ON without the keyless access remote inside the vehicle. 	<ul style="list-style-type: none"> Disappears when you bring the keyless access remote back inside the vehicle and close the door. <ul style="list-style-type: none"> ➤ Keyless Access Remote Reminder P. 143
	<ul style="list-style-type: none"> Appears when the keyless access remote battery becomes weak. 	<ul style="list-style-type: none"> Replace the battery as soon as possible. <ul style="list-style-type: none"> ➤ Replacing the Button Battery P. 427
	<ul style="list-style-type: none"> Appears if the keyless access remote battery is too weak to start the engine or the key is not with you to start the engine. The beeper sounds six times. 	<ul style="list-style-type: none"> Bring the keyless access remote in front of the ENGINE START/STOP button to be touched with. <ul style="list-style-type: none"> ➤ If the Keyless Access Remote Battery is Weak P. 458

QRG

TOC

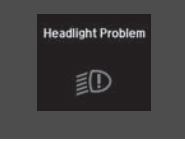
Instrument Panel

Message	Condition	Explanation
	<ul style="list-style-type: none"> Appears when pressing the IDS button. <ul style="list-style-type: none"> ► Press again to change the next mode. 	<p>► Integrated Dynamics System (IDS) P. 333</p>
	<ul style="list-style-type: none"> Appears if there is a problem with the radiator system. 	<ul style="list-style-type: none"> Drive slowly to prevent overheating and have your vehicle checked by a dealer as soon as possible.
	<ul style="list-style-type: none"> Appears when there is a problem with the headlights. 	<ul style="list-style-type: none"> Appears while driving - The low beam headlights may not be on. When conditions allow you to drive safely, have your vehicle checked by a dealer as soon as possible.
	<ul style="list-style-type: none"> Appears if there is a problem with the parking sensor system*. 	<ul style="list-style-type: none"> Check if the area around the sensor(s) is covered with mud, ice, snow, etc. If the indicator(s) stays on or the beeper does not stop even after you clean the area, have the system checked by a dealer.

Index





* Not available on all models

QRG

TOC

Instrument Panel

Message	Condition	Explanation
	<ul style="list-style-type: none"> Flashes when the system senses a likely collision with a vehicle in front of you. 	<ul style="list-style-type: none"> Take the appropriate means to prevent a collision (apply the brakes, change lanes, etc.) <ul style="list-style-type: none"> ➤ Collision Mitigation Braking System™ (CMBS™)* P. 371 ➤ Forward Collision Warning (FCW)* P. 346 ➤ Adaptive Cruise Control (ACC) with Low Speed Follow (LSF)* P. 337
	<ul style="list-style-type: none"> Appears when your vehicle is too close to the traffic lane lines. The beeper sounds. 	<ul style="list-style-type: none"> Take appropriate action to keep your vehicle within the lane lines. <ul style="list-style-type: none"> ➤ Lane Departure Warning (LDW)* P. 350
	<ul style="list-style-type: none"> Appears if there is a problem with the e-pretensioner system*. 	<ul style="list-style-type: none"> Have your vehicle checked by a dealer.

Index



Models with ACC with LSF



Message	Condition	Explanation
	<ul style="list-style-type: none"> Appears when ACC with LSF has been automatically canceled. 	<ul style="list-style-type: none"> You can resume the set speed after the condition that caused ACC with LSF to cancel improves. Press the RES/+SET/- switch up. <ul style="list-style-type: none"> ► Adaptive Cruise Control (ACC) with Low Speed Follow (LSF)* P. 337
	<ul style="list-style-type: none"> Appears if anything covers the radar sensor cover and prevents the sensor from detecting a vehicle in front. May appear when driving in bad weather (rain, snow, fog, etc.) 	<ul style="list-style-type: none"> When the radar sensor gets dirty, stop your vehicle in a safe place, and wipe off dirt using a soft cloth. Have your vehicle checked by a dealer if the message does not disappear even after you clean the sensor cover.
	<ul style="list-style-type: none"> Appears when the vehicle speed slows down to 25 mph (40 km/h) and the vehicle ahead of you goes out of the ACC with LSF range while ACC with LSF is in operation. 	<ul style="list-style-type: none"> ACC with LSF has been automatically canceled. <ul style="list-style-type: none"> ► Adaptive Cruise Control (ACC) with Low Speed Follow (LSF)* P. 337
	<ul style="list-style-type: none"> Appears when pressing the RES/+SET/- switch down while the vehicle speed is less than 25 mph (40 km/h) and the vehicle ahead of you goes out of the ACC with LSF range. 	<ul style="list-style-type: none"> ACC with LSF cannot be set. <ul style="list-style-type: none"> ► Adaptive Cruise Control (ACC) with Low Speed Follow (LSF)* P. 337
	<ul style="list-style-type: none"> Appears when the distance between your vehicle and the vehicle ahead of you is too close while ACC with LSF is in operation. 	<ul style="list-style-type: none"> ACC with LSF has been automatically canceled. <ul style="list-style-type: none"> ► Adaptive Cruise Control (ACC) with Low Speed Follow (LSF)* P. 337

* Not available on all models

QRG

TOC

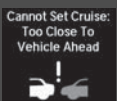
Instrument Panel

Message	Condition	Explanation
	<ul style="list-style-type: none"> Appears when pressing the RES/+SET/- switch down while the distance between your vehicle and the vehicle ahead of you is too close. 	<ul style="list-style-type: none"> ACC with LSF cannot be set. <ul style="list-style-type: none"> ➤ Adaptive Cruise Control (ACC) with Low Speed Follow (LSF) * P. 337
	<ul style="list-style-type: none"> Appears when pressing the RES/+SET/- switch down while the driver's seat belt is unfastened. 	<ul style="list-style-type: none"> ACC with LSF cannot be set. <ul style="list-style-type: none"> ➤ Adaptive Cruise Control (ACC) with Low Speed Follow (LSF) * P. 337
	<ul style="list-style-type: none"> Appears when pressing the RES/+SET/- switch down while the shift lever is in any position other than D. 	<ul style="list-style-type: none"> ACC with LSF cannot be set. <ul style="list-style-type: none"> ➤ Adaptive Cruise Control (ACC) with Low Speed Follow (LSF) * P. 337





Index

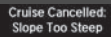

QRG

TOC

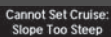
Instrument Panel

Message	Condition	Explanation
 	<ul style="list-style-type: none"> Appears when the vehicle is stopped on a very steep slope while ACC with LSF is in operation. 	<ul style="list-style-type: none"> ACC with LSF has been automatically canceled. <ul style="list-style-type: none"> ► Adaptive Cruise Control (ACC) with Low Speed Follow (LSF)* P. 337
 	<ul style="list-style-type: none"> Appears when pressing the RES/+/SET/- switch down while the vehicle is stopped on a very steep slope. 	<ul style="list-style-type: none"> ACC with LSF cannot be set. <ul style="list-style-type: none"> ► Adaptive Cruise Control (ACC) with Low Speed Follow (LSF)* P. 337
	<ul style="list-style-type: none"> Appears when pressing the RES/+/SET/- switch down while the parking brake is applied. 	<ul style="list-style-type: none"> ACC with LSF cannot be set. <ul style="list-style-type: none"> ► Adaptive Cruise Control (ACC) with Low Speed Follow (LSF)* P. 337 ► Parking Brake P. 367

Index



* Not available on all models

QRG

TOC

Instrument Panel

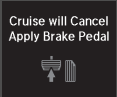
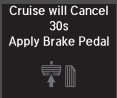
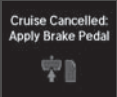
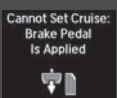
Message	Condition	Explanation
	<ul style="list-style-type: none"> Appears when your vehicle is stopped by ACC with LSF for more than five minutes. The beeper sounds. 	—
	<ul style="list-style-type: none"> Appears when your vehicle is stopped by ACC with LSF for more than nine and a half minutes. <ul style="list-style-type: none"> ► The display starts the countdown when ACC with LSF is cancelled within 30 seconds. The beeper sounds. 	—
	<ul style="list-style-type: none"> Appears if ACC with LSF is canceled while your vehicle is automatically stopped by ACC with LSF. The beeper sounds. 	<ul style="list-style-type: none"> Immediately depress the brake pedal.
	<ul style="list-style-type: none"> Appears when pressing the RES/+ / SET/- switch down while the vehicle is moving and the brake pedal is depressed. 	<ul style="list-style-type: none"> ACC with LSF cannot be set. <ul style="list-style-type: none"> ➤ Adaptive Cruise Control (ACC) with Low Speed Follow (LSF) * P. 337

Index



QRG

TOC

Instrument Panel

Models with two-way keyless access remote

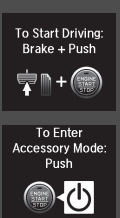



Message	Condition	Explanation
	<ul style="list-style-type: none"> Appears when you unlock and open the driver's door while the engine is running by two-way keyless access remote. 	<p>▶ Remote Engine Start with Vehicle Feedback* P. 324</p>

Index

Home

* Not available on all models

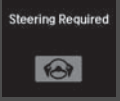
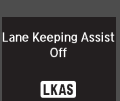
Models with LKAS

Message	Condition	Explanation
 	<ul style="list-style-type: none"> • Appears when the vehicle is driving out of a detected line. The beeper sounds simultaneously if selected by customization. 	<ul style="list-style-type: none"> • Keep the vehicle within the lane you are driving. • The color of either line changes from white to amber as the vehicle gets closer to that side of the lane line.
	<ul style="list-style-type: none"> • Blinks when you fail to steer the vehicle. The beeper sounds simultaneously if selected by customization. 	<ul style="list-style-type: none"> • Operate the steering wheel to resume the LKAS.
	<ul style="list-style-type: none"> • Appears when the LKAS is in operation, or the LKAS button is pressed, but there is a problem with a system related to the LKAS. The LKAS cancels automatically. The beeper sounds simultaneously if selected by customization. 	<ul style="list-style-type: none"> • If any other system indicators come on, such as the VSA®, ABS and brake system, take appropriate action. ➤ Indicators P. 70
	<ul style="list-style-type: none"> • Appears when the LKAS is in operation, or the LKAS button is pressed, but there the temperature inside the LKAS camera is too high. The LKAS cancels automatically. The beeper sounds simultaneously if selected by customization. 	<ul style="list-style-type: none"> • Use the climate control system to cool down the camera. • Goes off - The camera has been cooled down. Pressing the LKAS button can resume the system. ➤ LKAS camera P. 354

QRG

Gauges

Gauges include the speedometer, tachometer, fuel gauge, and related indicators. They are displayed when the power mode is in ON.

■ Speedometer

Displays your driving speed in mph (U.S.) or km/h (Canada).

■ Tachometer

Shows the number of engine revolutions per minute.

■ Fuel Gauge

Displays the amount of fuel left in the fuel tank.

■ Temperature Gauge

Displays the temperature of the engine coolant.

▣ Fuel Gauge

NOTICE

You should refuel when the reading approaches **E**. Running out of fuel can cause the engine to misfire, damaging the catalytic converter.

The actual amount of remaining fuel may differ from the fuel gauge reading.

▣ Temperature Gauge

NOTICE

Driving with the temperature gauge pointer in the upper zone can cause serious engine damage. Pull safely to the side of the road and allow engine temperature to return to normal.

➤ [Overheating P. 463](#)

TOC

Instrument Panel

Index

Home

MID

The MID shows the odometer, trip meter, outside temperature indicator, and other gauges. It also displays important messages such as warnings and other helpful information.

Switching the Display

Roll the multi-function steering-wheel controls or press the **TRIP** button to change the display.

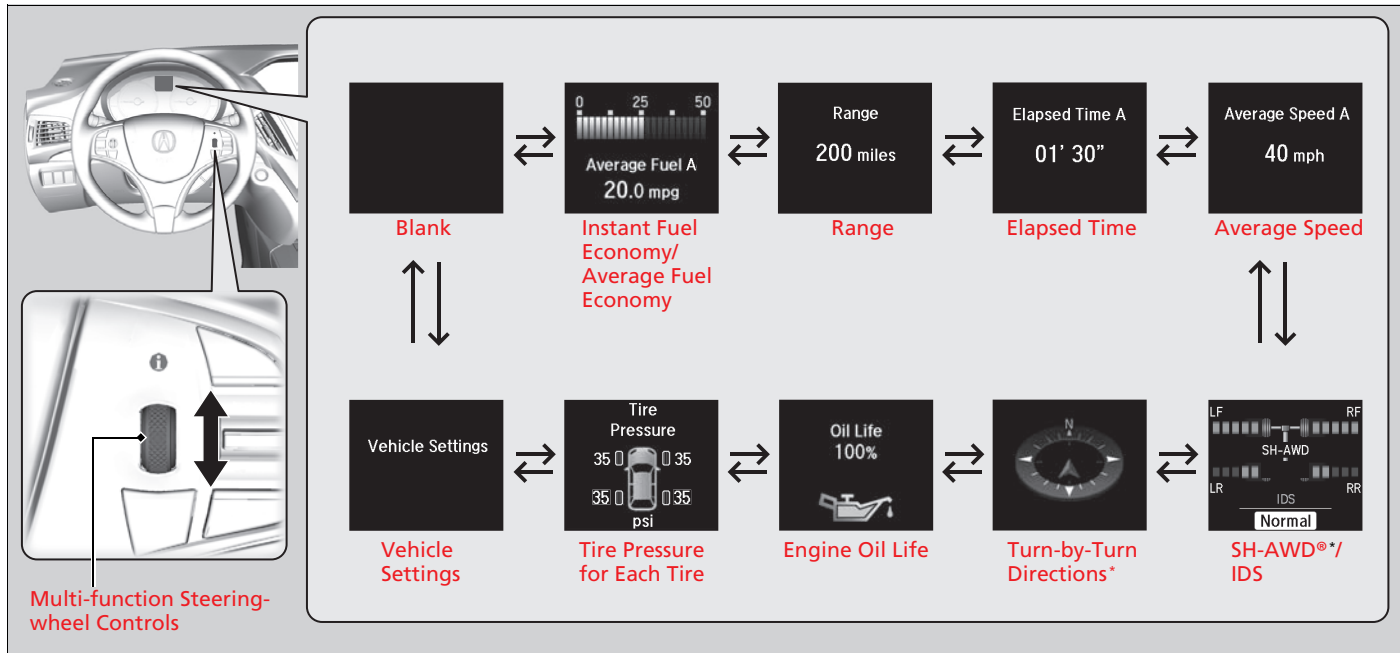

QRG

TOC

Instrument Panel

Index

Home

QRG

TOC

Instrument Panel

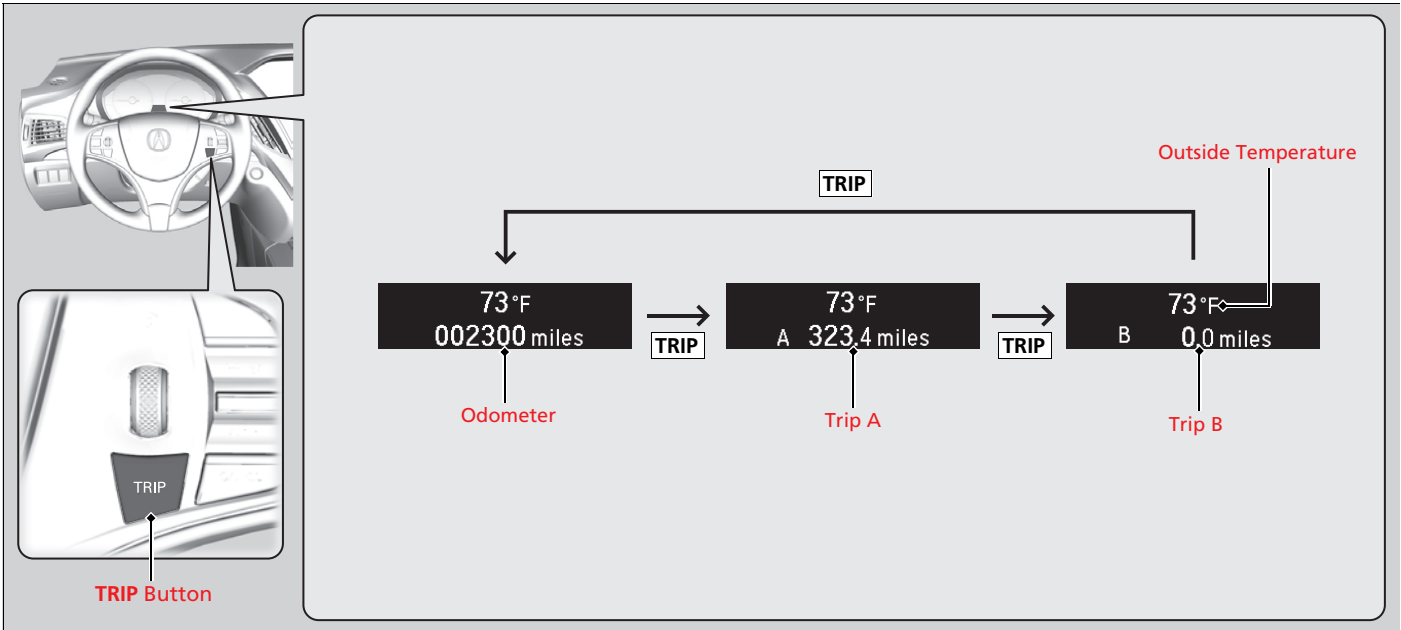

■ Odometer

Shows the total number of miles (U.S.) or kilometers (Canada) that your vehicle has accumulated.

Index

Home

QRG

■ Trip Meter

Shows the total number of miles (U.S.) or kilometers (Canada) driven since the last reset. Meters A and B can be used to measure two separate trips.

TOC

■ Resetting a trip meter

To reset a trip meter, display it, then press and hold the **TRIP** button until the trip meter is reset to **0.0**.

Instrument Panel

■ Outside Temperature

Shows the outside temperature in Fahrenheit (U.S.) or Celsius (Canada).

■ Adjusting the outside temperature display

Adjust the temperature reading up to $\pm 5^{\circ}\text{F}$ or $\pm 3^{\circ}\text{C}$ if the temperature reading seems incorrect.

■ Average Fuel Economy

Shows the estimated average fuel economy of each trip meter in mpg (U.S.) or l/100 km (Canada). The display is updated at set intervals. When a trip meter is reset, the average fuel economy is also reset.

Index

Home

☞ Trip Meter

Switch between trip meter A and trip meter B by pressing the **TRIP** button.

☞ Outside Temperature

The temperature sensor is located in the front bumper.
Road heat and exhaust from another vehicle can affect the temperature reading when your vehicle speed is less than 19 mph (30 km/h).

It may take several minutes for the display to be updated after the temperature reading has stabilized.

Use the MID's customized features to correct the temperature.

[☞ Customized Features P. 104](#)

☞ Average Fuel Economy

You can change when to reset the average fuel economy.

[☞ Customized Features P. 104](#)

Instant Fuel Economy

Shows the instant fuel economy as a bar graph in mpg (U.S.) or l/100 km (Canada).

Range

Shows the estimated distance you can travel on the remaining fuel. This distance is estimated from the fuel economy of your trips in the past.

Elapsed Time

Shows the time elapsed since the last time Trip A or Trip B was reset.

Average Speed

Shows the average speed in mph (U.S.) or km/h (Canada) since the last time Trip A or Trip B was reset.

⌘ Elapsed Time

You can change when to reset the elapsed time.

➤ [Customized Features P. 104](#)

⌘ Average Speed

You can change when to reset the average speed.

➤ [Customized Features P. 104](#)

QRG

TOC

Instrument Panel

■ SH-AWD® Torque Distribution Monitor*

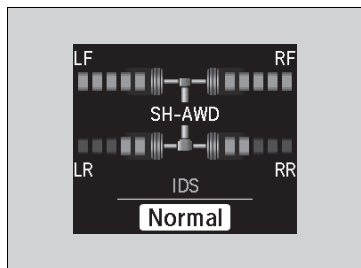

The indicators on the display show the amount of torque being transferred to the right front, left front, right rear, and left rear wheels.

▶ [Super Handling-All Wheel Drive™ \(SH-AWD®\)* P. 363](#)

■ Current Mode for IDS

Shows the current mode for IDS.

▶ [Integrated Dynamics System \(IDS\) P. 333](#)

■ Turn-by-Turn Directions

Models with navigation system

Shows you turn-by-turn driving directions to your destination linked with the navigation system.

▶ [Refer to the navigation system](#)

☒ Turn-by-Turn Directions

You can select whether the turn-by-turn display comes on or not during the route guidance.

▶ [Customized Features P. 104](#)

▶ [Refer to the navigation system](#)

Index

Home

QRG

■ Engine Oil Life and Maintenance Items

Shows the remaining oil life and Maintenance Minder™.

➤ [Maintenance Minder™](#) P. 391

TOC

Instrument Panel

■ Tire Pressure Monitor

Shows each tire's pressure.

➤ [Tire Pressure Monitoring System \(TPMS\)](#) P. 363

Index

Home

■ Customized Features

Use the MID to customize certain features.

■ How to customize

Select the **Vehicle Settings** screen by rolling the multi-function steering-wheel controls while the power mode is in ON, and the vehicle is at a complete stop. Push the multi-function steering-wheel controls.

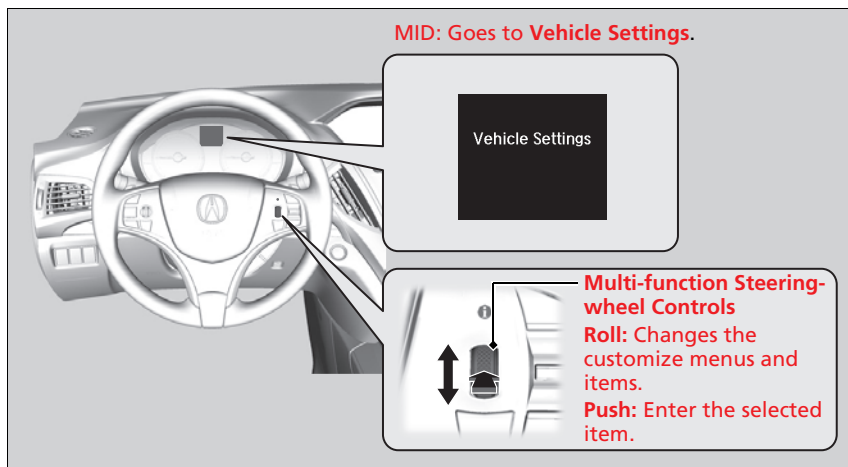

▶ Customized Features

To customize other features, roll the multi-function steering-wheel controls.

- ▶ [List of customizable options P. 107](#)
- ▶ [Example of customization settings P. 111](#)

Customization is possible when you see the driver's ID (**Driver 1** or **Driver 2**) on the screen.

The driver's ID indicates which remote transmitter you have used to unlock the driver's door. The customized settings are recalled every time you unlock the driver's door with that remote.

Shift to **[P]** before you attempt to change any customized setting.



Customization flow

Roll the multi-function steering-wheel controls to select **Vehicle Settings** and push the multi-function steering-wheel controls.

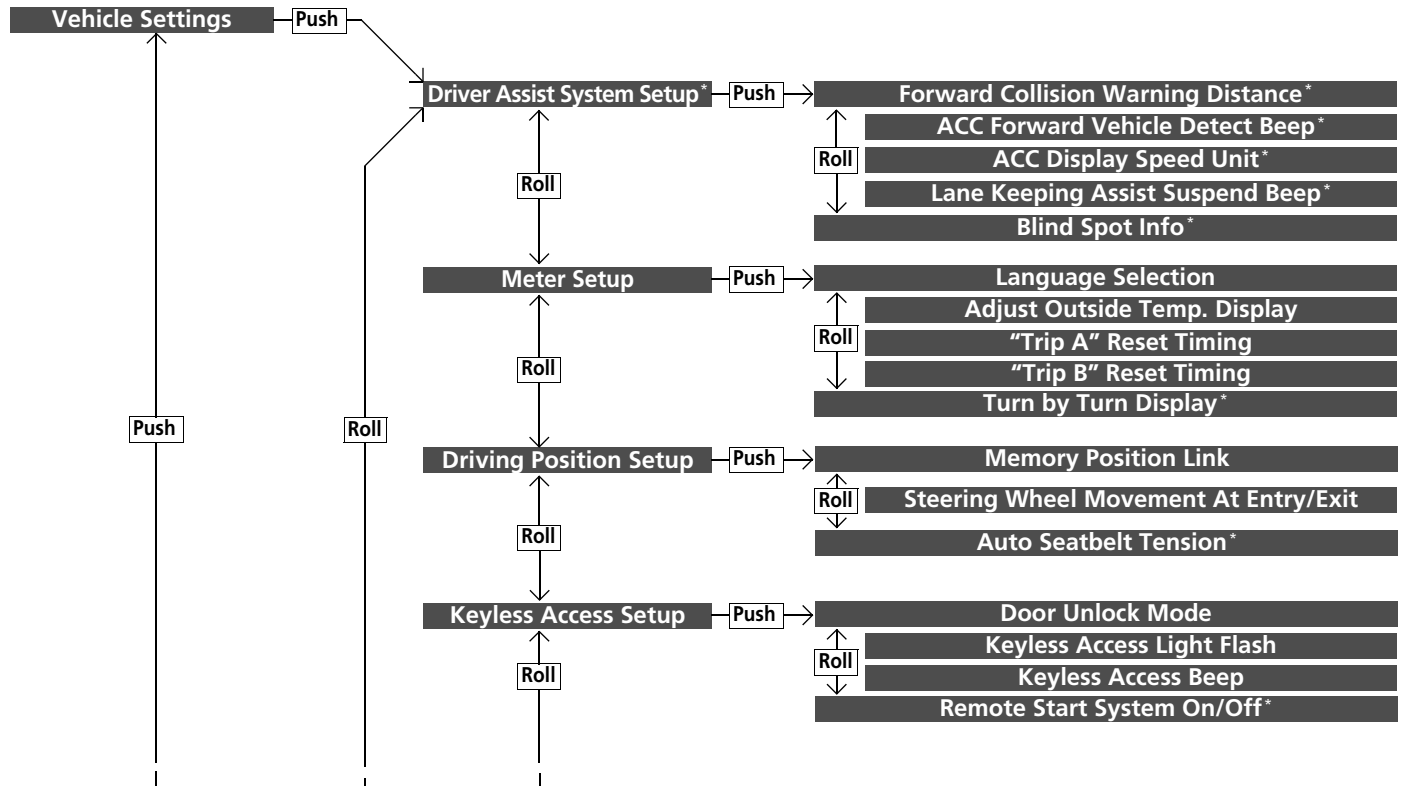

* Not available on all models

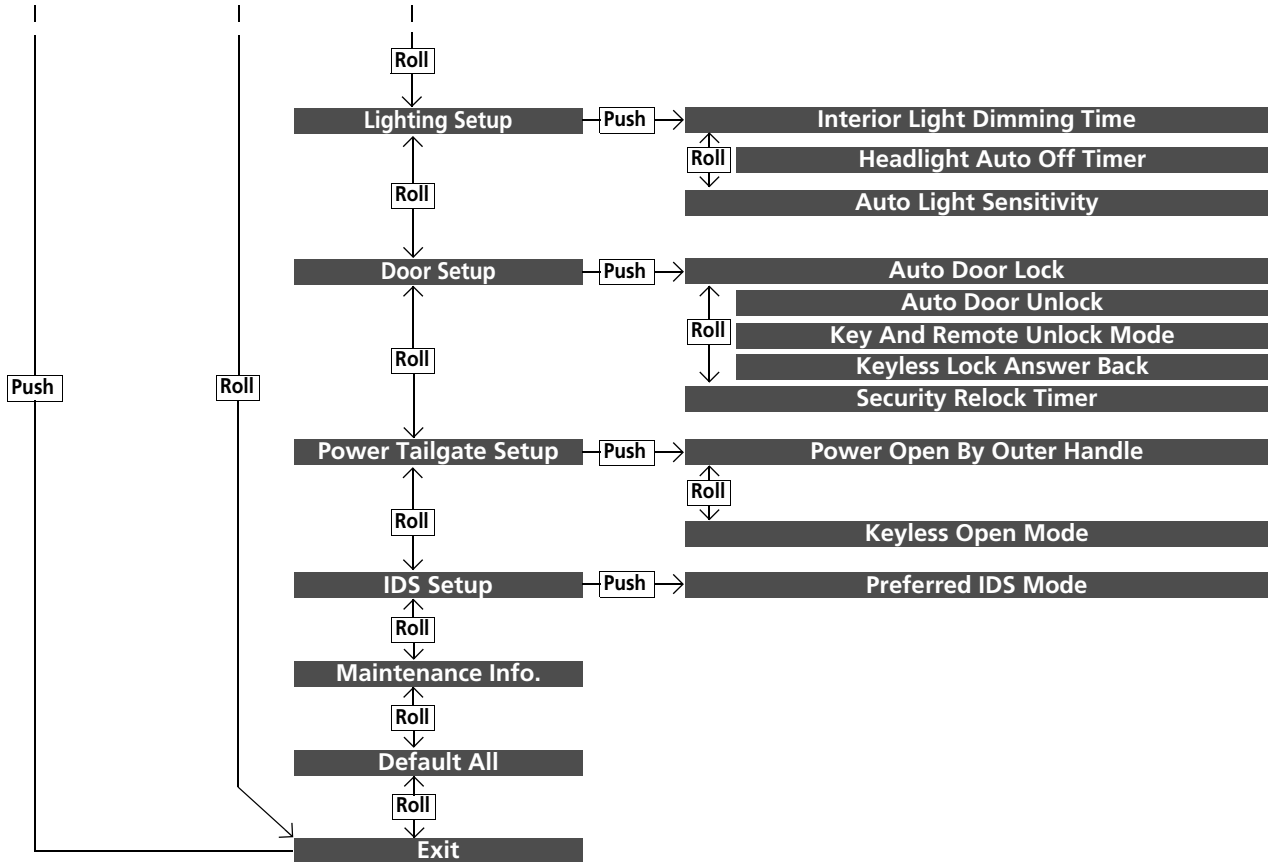

■ List of customizable options

Setup Group	Customizable Features	Description	Selectable Settings
Driver Assist System Setup*	Forward Collision Warning Distance*	Changes at which distance FCW* or CMBS™* alerts, or turns FCW* on and off.	Long/Normal*¹/Short/Off
	ACC Forward Vehicle Detect Beep*	Causes the system to beep when the system detects a vehicle, or when the vehicle goes out of the ACC with LSF range.	On/Off*¹
	ACC Display Speed Unit*	Changes the speed unit for ACC with LSF on the MID.	mph*¹/km/h (U.S.) mph/km/h*¹ (Canada)
	Lane Keeping Assist Suspend Beep*	Causes the system to beep when the LKAS is suspended.	On/Off*¹
	Blind Spot Info*	Changes the setting for the blind spot information.	Audible And Visual Alert*¹/Visual Alert/Off
Meter Setup	Language Selection	Changes the displayed language.	English*¹/Francais/Español
	Adjust Outside Temp. Display	Adjusts the temperature reading by a few degrees.	-5°F ~ ±0°F*¹ ~ +5°F (U.S.) -3°C ~ ±0°C*¹ ~ +3°C (Canada)
	“Trip A” Reset Timing	Changes the setting of how to reset trip meter A, average fuel economy A, average speed A, and elapsed time A.	When Refueled/IGN Off/Manually Reset*¹
	“Trip B” Reset Timing	Changes the setting of how to reset trip meter B, average fuel economy B, average speed B, and elapsed time B.	When Refueled/IGN Off/Manually Reset*¹
	Turn by Turn Display*	Select whether the turn-by-turn display comes on during the route guidance.	On*¹/Off

*1:Default Setting

* Not available on all models

Setup Group	Customizable Features	Description	Selectable Settings
Driving Position Setup	Memory Position Link	Turns the driving position memory system on and off.	On*¹/Off
	Steering Wheel Movement At Entry/Exit	Moves the steering wheel fully up when you get in/get out of the vehicle. Turns this feature on and off.	On*¹/Off
	Auto Seatbelt Tension*	Turns the setting for the automatic seat belt e-pretensioner activation on and off.	On*¹/Off
Keyless Access Setup	Door Unlock Mode	Changes which doors unlock when you grab the driver's door handle.	Driver Door Only*¹/All Doors
	Keyless Access Light Flash	Causes some exterior lights to flash when you unlock/lock the doors.	On*¹/Off
	Keyless Access Beep	Causes the beeper to sound when you unlock/lock the doors.	On*¹/Off
	Remote Start System On/Off*	Turns the remote engine start feature on and off.	On*¹/Off

*1: Default Setting

Setup Group	Customizable Features	Description	Selectable Settings
Lighting Setup	Interior Light Dimming Time	Changes the length of time the interior lights stay on after you close the doors.	60sec/30sec^{*1}/15sec
	Headlight Auto Off Timer	Changes the length of time the exterior lights stay on after you close the driver's door.	60sec/30sec/15sec^{*1}/0sec
	Auto Light Sensitivity	Changes the timing for the headlights to come on.	Max/High/Mid^{*1}/Low/Min
Door Setup	Auto Door Lock	Changes the setting for the automatic locking feature.	With Vehicle Speed^{*1}/Shift From P/Off
	Auto Door Unlock	Changes the setting for when the doors unlock automatically.	All Doors When Driver's Door Opens^{*1}/All Doors When Shifted To Park/All Doors When Ignition Switched Off/Off
	Key And Remote Unlock Mode	Sets up either the driver's door or all doors to unlock on the first operation of the remote or built-in key.	Driver Door^{*1}/All Doors
	Keyless Lock Answer Back	LOCK/UNLOCK- The exterior lights flash. LOCK (2nd push)- The beeper sounds.	On^{*1}/Off
	Security Relock Timer	Changes the time it takes for the doors to relock and the security system to set after you unlock the vehicle without opening any door.	90sec/60sec/30sec^{*1}

*1: Default Setting

Setup Group	Customizable Features	Description	Selectable Settings
Power Tailgate Setup	Power Open By Outer Handle	Changes the setting to open power tailgate by tailgate outer handle.	On (Power/Manual)*¹/Off (Manual Only)
	Keyless Open Mode	Changes the keyless setting for when the power tailgate opens.	Anytime*¹/When Unlocked
IDS Setup	Preferred IDS Mode	Changes the IDS mode setting for when you set the power mode to ON.	Last Used*¹/Comfort/Normal/Sport
Maintenance Info.	Maintenance Reset	Resets/Cancel the engine oil life display when you have performed the maintenance service.	Cancel/Reset
Default All	—	Cancels/Resets all the customized settings as default.	Cancel/Set

*1: Default Setting

■ Example of customization settings

The steps for changing the **“Trip A” Reset Timing** setting to **When Refueled** are shown below. The default setting for **“Trip A” Reset Timing** is **Manually Reset**.

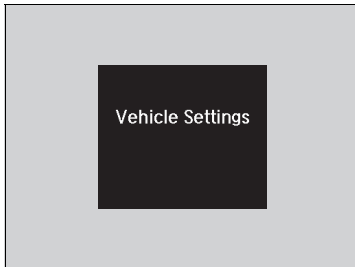

1. Roll the multi-function steering-wheel controls to select **Vehicle Settings**, then push the multi-function steering-wheel controls.



2. Roll the multi-function steering-wheel controls until **Meter Setup** appears on the display.
3. Push the multi-function steering-wheel controls.
 - ▶ **Language Selection** appears first on the display.

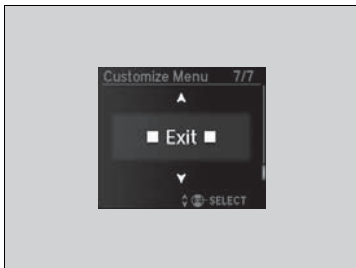
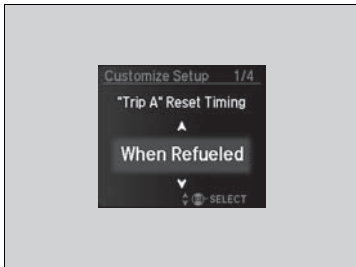
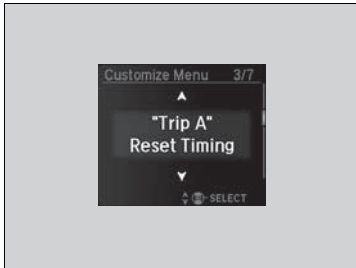

4. Roll the multi-function steering-wheel controls until **"Trip A" Reset Timing** appears on the display, then push the multi-function steering-wheel controls.
 - The display switches to the customization setup screen, where you can select **When Refueled**, **IGN Off**, **Manually Reset**, or **Exit**.

5. Roll the multi-function steering-wheel controls and select **When Refueled**, then push the multi-function steering-wheel controls.
 - The **When Refueled Setup** screen appears, then the display returns to the customization menu screen.

6. Roll the multi-function steering-wheel controls until **Exit** appears on the display, then push the multi-function steering-wheel controls.

7. Repeat Step 6 until you return to the normal screen.

Controls

This chapter explains how to operate the various controls necessary for driving.



- Clock** 114
- Locking and Unlocking the Doors**
- Key Types and Functions 115
- Locking/Unlocking the Doors from the Outside 117
- Low Keyless Access Remote Signal Strength 123
- Locking/Unlocking the Doors from the Inside 124
- Childproof Door Locks 126
- Auto Door Locking/Unlocking 127
- Opening and Closing the Tailgate**... 128
- Security System**
- Immobilizer System 135

- Security System Alarm..... 135
- Opening and Closing the Windows** ... 138
- Opening and Closing the Moonroof** .. 140
- Operating the Switches Around the Steering Wheel**
- ENGINE START/STOP Button..... 141
- Turn Signals 144
- Light Switches..... 145
- Daytime Running Lights 148
- Wipers and Washers 149
- Brightness Control 153
- Defogger/Heated Door Mirror 154
- Driving Position Memory System 155
- Adjusting the Steering Wheel..... 157

- Adjusting the Mirrors**
- Interior Rearview Mirror 158
- Power Door Mirrors 159
- Adjusting the Seats**
- Adjusting the Seat Positions..... 161
- Rear Seats..... 168
- Armrest 171
- Interior Lights/Interior Convenience Items**
- Interior Lights 172
- Interior Convenience Items 174
- Climate Control System**
- Using Automatic Climate Control 185
- Rear Climate Control System 192
- Automatic Climate Control Sensors... 196





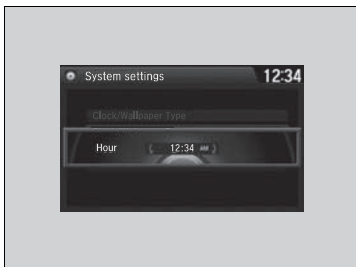

Adjusting the Clock

You can adjust the time manually in the audio/information screen, with the power mode in ON.

Adjusting the Time

Using the Settings menu on the audio/information screen



1. Press the **SETTINGS** button.
2. Rotate  to select **System Settings**, press .
 - ▶ Repeat the procedure to select **Clock Adjustment**.
3. Rotate  to change hour, then press .
4. Rotate  to change minute, then press .

⌘ Clock

These indications are used to show how to operate the interface dial.

Rotate  to select.

Press  to enter.

You can customize the clock display to show the 12 hour clock or 24 hour clock.

[Customized Features P. 248](#)

You can turn the clock display in the audio/information screen on and off.

[Customized Features P. 248](#)

Models with navigation system

The clock is automatically updated through the navigation system, so the time does not need to be adjusted.

Key Types and Functions

This vehicle comes with the following keys:

Keys

Models without two-way keyless access remote



Models with two-way keyless access remote

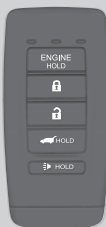

Use the keyless access remote to start and stop the engine, and to lock and unlock all the doors and tailgate. You can also use the keyless access system to lock and unlock the doors and tailgate.

Key Types and Functions

All the keys have an immobilizer system. The immobilizer system helps to protect against vehicle theft.

[Immobilizer System P. 135](#)

The keys contain precision electronics. Adhere to the following advice to prevent damage to the electronics:

- Do not leave the keys in direct sunlight, or in locations with high temperature or high humidity.
- Do not drop the keys or set heavy objects on them.
- Keep the keys away from liquids.
- Do not take the keys apart except for replacing the battery.

If the circuits in the keys are damaged, the engine may not start, and the keyless access system may not work.

If the keys do not work properly, have them inspected by a dealer.

Models with two-way keyless access remote

You can remotely start the engine using the two-way keyless access remote.

[Remote Engine Start with Vehicle Feedback* P. 324](#)

* Not available on all models

■ Keyless access remote

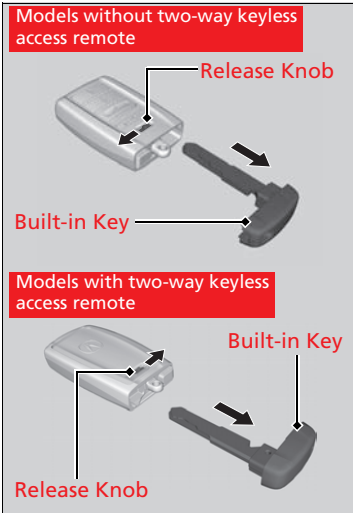

The built-in key can be used to lock/unlock the doors when the keyless access remote battery becomes weak or the power door lock/unlock operation is disabled.

To remove the built-in key, pull it out while sliding the release knob. To reinstall the built-in key, push the built-in key into the keyless access remote until it clicks.

■ Key Number Tag

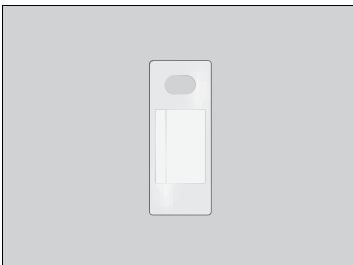

Contains a number that you will need if you purchase a replacement key.

☒ Key Number Tag

Keep the key number tag separate from the key in a safe place outside of your vehicle. If you wish to purchase an additional key, contact a dealer.

If you lose your key and you cannot start the engine, contact a dealer.

Locking/Unlocking the Doors from the Outside

Using the Remote Transmitter

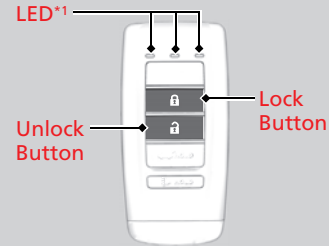
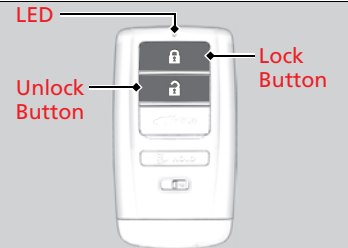

Locking the doors

Press the lock button.

Once:

- ▶ Some exterior lights flash, all the doors and tailgate lock, and the security system sets.

Twice (within five seconds after the first push):

- ▶ The beeper sounds and verifies the security system is set.

Unlocking the doors

Press the unlock button.

Once:

- ▶ Some exterior lights flash twice, and the driver's door unlocks.

Twice:

- ▶ The remaining doors and tailgate unlock.

Locking/Unlocking the Doors from the Outside

You can lock or unlock doors using the remote transmitter or keyless access system only when the power mode is in VEHICLE OFF.

Using the Remote Transmitter

If you do not open a door within 30 seconds of unlocking the vehicle with the remote transmitter, the doors will automatically relock. You can change the relock timer setting.

▶ [Customized Features P. 104 P. 248](#)

If the interior light switch is in the door activated position, the interior lights come on when you press the unlock button.

No doors opened: The lights fade out after 30 seconds.

Doors relocked with the remote: The lights go off immediately.

▶ [Interior Lights P. 172](#)

The remote transmitter uses low-power signals, so the operating range may vary depending on the surroundings.

The remote will not lock the vehicle when a door or the tailgate is open.

1: [Checking Door Lock Status P. 122](#)

* Not available on all models

■ Using the Keyless Access System

Models without rear door touch sensor

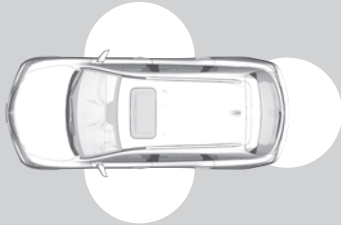

Models with rear door touch sensor

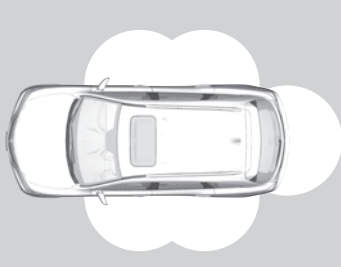

When you carry the keyless access remote, you can lock/unlock the doors and the tailgate.

You can lock/unlock the doors within a radius of about 32 inches (80 cm) of the outside door handle. You can open the tailgate within about 32 inches (80 cm) radius from the tailgate outer handle.

▣ Using the Remote Transmitter

If the distance at which the remote transmitter works varies, the battery is probably low. If the LED does not come on when you press a button, the battery is dead.

➤ [Replacing the Button Battery P. 427](#)

You can customize the door lock mode and keyless lock acknowledgement setting.

➤ [Customized Features P. 104](#)
[P. 248](#)

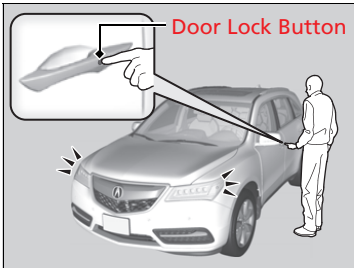

■ Locking the doors and tailgate

Press the door lock button on a front door, rear doors* or the tailgate.

- ▶ Some exterior lights flash; the beeper sounds; all the doors and tailgate lock; and the security system sets.

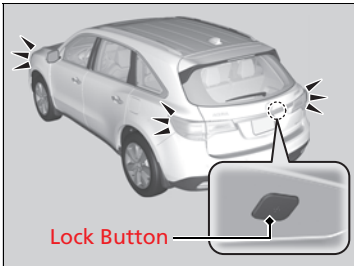

⊗ Using the Keyless Access System

- Do not leave the keyless access remote in the vehicle when you get out. Carry it with you.
- Even if you are not carrying the keyless access remote, you can lock/unlock the doors and unlock the tailgate while someone else with the remote is within range.
- The door may be unlocked if the door handle is covered with water in heavy rain or in a car wash if the keyless access remote is within range.
- If you grip a door handle wearing gloves, the door sensor may be slow to respond or may not respond by unlocking the doors.
- The door may not open if you pull it immediately after gripping the door handle. Grip the handle again and confirm that the door is unlocked before pulling the handle.
- Even within the 32 inches (80 cm) radius, you may not be able to lock/unlock the doors with the keyless access remote if it is above or below the outside handle.
- The keyless access remote may not operate if it is too close to the door and door glass.

* Not available on all models

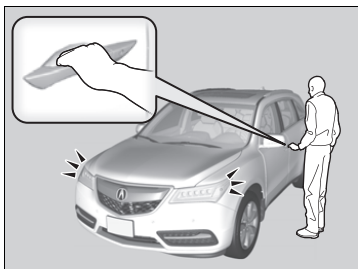

■ Unlocking the doors and tailgate

Grab the driver's door handle:

- ▶ The driver's door unlocks.
- ▶ Some exterior lights flash twice and the beeper sounds twice.

Grab the front passenger's or rear* door handle:

- ▶ All the doors unlock.
- ▶ Some exterior lights flash twice and the beeper sounds twice.

Press and hold the tailgate outer handle:

- ▶ All doors and the tailgate unlock and open.
- ▶ Some exterior lights flash twice and the beeper sounds twice.

➤ **Opening/Closing the Tailgate Using the Tailgate Outer Handle** P. 129

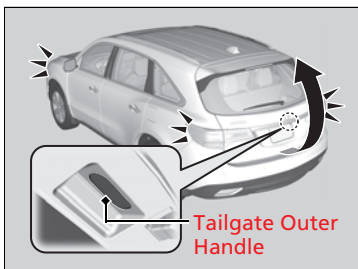

➤ Using the Keyless Access System

Models with navigation system

When you go into the keyless access system working range with all the doors locked, the LED puddle lights come on for 30 seconds.

The lights do not come on if you have previously stayed within the range for more than two minutes, or the doors have been locked for a few days.

The feature activates again after you drive the vehicle, then lock the doors.

If you do not open a door within 30 seconds of unlocking the vehicle, the doors will automatically relock.

The light flash, beeper, and unlock settings can be customized using the audio/information screen or multi-information display (MID).

➤ **Customized Features** P. 104
P. 248

You can also unlock and open with the power tailgate.

➤ **Opening/Closing the Tailgate Using the Tailgate Outer Handle** P. 129

■ Locking/Unlocking the Doors Using a Key

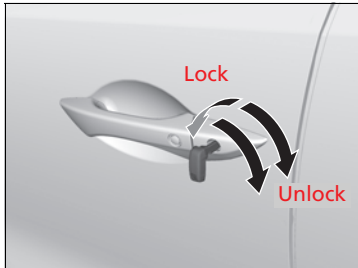

Fully insert the key and turn it.

■ Locking a Door Without Using a Key

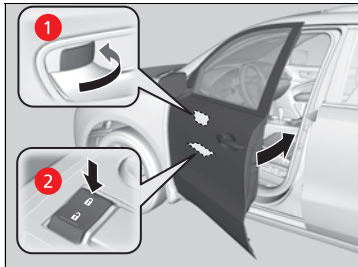

■ Locking the front doors

Push the lock tab forward **1** or push the master door lock switch in the lock direction **2**, and close the door.

■ Locking the rear doors

Push the lock tab forward and close the door.

■ Lockout prevention system

The doors and tailgate cannot be locked when the keyless access remote is inside the vehicle.

☒ Locking/Unlocking the Doors Using a Key

When you lock the driver's door with a key, all the other doors and tailgate lock at the same time. When unlocking, the driver's door unlocks first. Turn the key a second time within a few seconds to unlock the remaining doors and the tailgate.

You can customize the door unlock mode setting.

➤ [Customized Features](#) P. 104
P. 248

☒ Locking a Door Without Using a Key

When you lock the driver's door, all the other doors and tailgate lock at the same time.

Make sure you have the key in your hand before locking the door to prevent it from being locked in the vehicle.

■ Checking Door Lock Status*

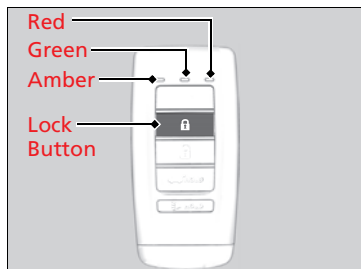

You can remotely check if your vehicle's doors are all locked or any are unlocked from distance up to 328 feet (100 meters), using the keyless access remote.

Press the lock button, the Amber (LEFT) LED blinks once. Then after three seconds one of the following feedback will come:

- Green (center) comes on: Acknowledges that the doors are locked.
- Red (right) comes on: Acknowledges that doors are not locked, or any door is not completely closed.
- Red (right) blinks three times: The remote does not receive the door lock status from the vehicle.

▣ Checking Door Lock Status*

Operate the remote in an open space. If there are buildings or other obstacles between your vehicle and the remote, the remote may not work even within the operable range. However, the range of unlock, all doors, and panic functions are the same as the standard keyless access remote.

[▶ Using the Remote Transmitter P. 117](#)

When checking the door lock status, you can also start or stop the engine.

[▶ Remote Engine Start with Vehicle Feedback* P. 324](#)

Low Keyless Access Remote Signal Strength

The vehicle transmits radio waves to locate the keyless access remote when locking/unlocking the doors and tailgate, or to start the engine.

In the following cases, locking/unlocking the doors and tailgate, or starting the engine may be inhibited or operation may be unstable:

- Strong radio waves are being transmitted by nearby equipment.
- You are carrying the keyless access remote together with telecommunications equipment, laptop computers, cell phones, or wireless devices.
- A metallic object is touching or covering the keyless access remote.

Low Keyless Access Remote Signal Strength

Communication between the keyless access remote and the vehicle consumes the keyless access remote's battery.

The keyless access remote battery lasts about two years. This changes by how often you use the remote. The battery is consumed whenever the keyless access remote is receiving strong radio waves. Avoid placing it near electrical appliances such as televisions and personal computers.

Locking/Unlocking the Doors from the Inside

■ Using the Lock Tab

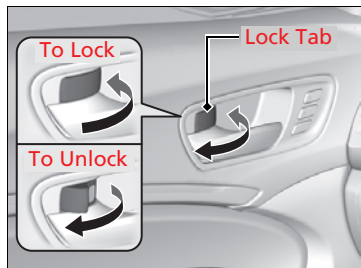

■ Locking a door

Push the lock tab forward.

■ Unlocking a door

Pull the lock tab rearward.

☒ Using the Lock Tab

When you lock the door using the lock tab on the driver's door, all the other doors and tailgate lock at the same time.

When you unlock the door using the lock tab on the driver's door, only the driver's door will unlock.

■ Unlocking Using the Front Door Inner Handle

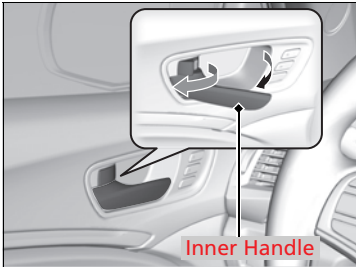

Pull the front door inner handle.

- ▶ The door unlocks and opens in one motion.

Unlocking and opening the driver's door from the inner handle unlocks all the other doors.

To avoid all the doors to be unlocked, use the lock tab on the driver's door to unlock, then lock again before opening the door.

- ▶ This setting works for one time only. If you do not want all the doors to be unlocked all the time, customize the **Auto Door Unlock** setting to **Off** using the MID or audio/information screen.

☒ Unlocking Using the Front Door Inner Handle

The front door inner handles are designed to allow front seat occupants to open the door in one motion. However this feature requires that front seat occupants never pull a front door inner handle while the vehicle is in motion.

Children should always ride in a rear seat where childproof door locks are provided.

▶ [Childproof Door Locks P. 126](#)

■ Using the Master Door Lock Switch

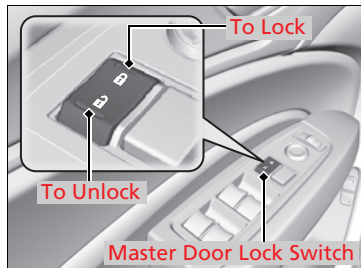

Press the master door lock switch in as shown to lock or unlock all doors and the tailgate.

Childproof Door Locks

The childproof door locks prevent the rear doors from being opened from the inside regardless of the position of the lock tab.

■ Setting the Childproof Door Locks

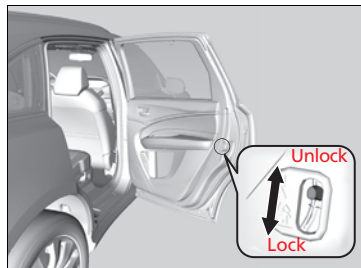

Slide the lever in the rear door to the lock position, and close the door.

■ When opening the door

Open the door using the outside door handle.

☒ Using the Master Door Lock Switch

When you lock/unlock either front door using the master door lock switch, all the other doors and tailgate lock/unlock at the same time.

☒ Childproof Door Locks

To open the door from the inside when the childproof door lock is on, put the lock tab in the unlock position, lower the rear window, put your hand out of the window, and pull the outside door handle.

Auto Door Locking/Unlocking

Your vehicle locks all doors and unlocks all doors or the driver's door automatically when a certain condition is met.

■ Auto Door Locking

■ Drive lock mode

All doors and tailgate lock when the vehicle's speed reaches about 10 mph (15 km/h).

■ Auto Door Unlocking

■ Driver's door open mode

All doors unlock when the driver's door is opened.

☒ Auto Door Locking/Unlocking

You can turn off or change to another auto door locking/unlocking setting using the audio/information screen or MID.

➤ [Customized Features](#) P. 104
P. 248

Precautions for Opening/Closing the Tailgate

Always make sure individuals and objects are clear of the tailgate before opening or closing it.

■ Opening the tailgate

- Open the tailgate all the way.
 - ▶ If it is not fully opened, the tailgate may come down accidentally by its own weight.
- Be careful when it is windy. The wind may cause the tailgate to close.

■ Closing the tailgate

Keep the tailgate closed while driving to:

- ▶ Avoid possible damage.
- ▶ Prevent exhaust gas from leaking into the vehicle.

➤ [Carbon Monoxide Gas P. 66](#)

ⓘ Precautions for Opening/Closing the Tailgate

WARNING

Closing a power tailgate while anyone is in the path of the tailgate can cause serious injury.

Make sure everyone is clear before closing the power tailgate.

Be careful not to hit your head on the tailgate or to put your hands between the tailgate and the cargo area when closing the tailgate.

When operating the power tailgate, make sure there is enough space around your vehicle. People near the tailgate may be seriously hurt if the tailgate hits or closes on their heads. Be especially cautious if children are around.

When you are storing or picking up luggage from the cargo area while the engine is idling, do not stand in front of the exhaust pipe. You may get burned.

Do not allow any passenger in the cargo space. They may get hurt during hard braking, a sudden acceleration, or a crash.

Opening/Closing the Tailgate Using the Tailgate Outer Handle

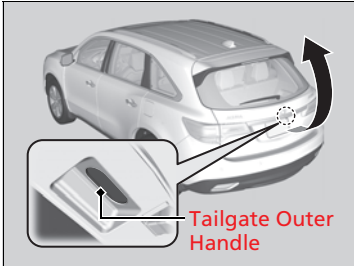

When all the doors are unlocked, the tailgate is unlocked. Press the tailgate outer handle for more than one second, and wait until you hear three beeps before you lift open the tailgate.

▶ Releasing the outer handle within one second with one beep enables the power tailgate operations.

▶ [Power Tailgate Outer Handle P. 132](#)

Even if the tailgate is locked, you can open the tailgate if you carry the keyless access remote.

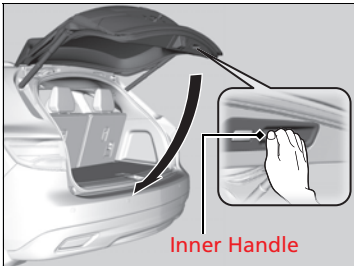

To manually close the tailgate, grab the inner handle, pull the tailgate down, and push it closed from outside.

Opening/Closing the Tailgate Using the Tailgate Outer Handle

Do not leave the keyless access remote inside the cargo area and close the tailgate. The beeper sounds and the tailgate cannot be closed.

Even if you are not carrying the keyless access remote, you can lock/unlock the doors while someone else with the remote is within range.

Opening/Closing the Power Tailgate

The power tailgate can be operated by pressing the power tailgate button on the remote transmitter or driver's door, or pressing the outer handle or button on the tailgate.

■ The power tailgate can be opened when:

- The tailgate is fully closed.
- The shift lever is in **P**.
- Press and hold the tailgate button on the remote transmitter for about one second when the power mode is in VEHICLE OFF (LOCK).
 - ▶ If you have changed the **Keyless Open Mode** setting to **When Unlocked**, you need to unlock the tailgate before you press the tailgate button to open it.
[Customized Features P. 104](#)

■ The power tailgate can be closed when:

- The tailgate is fully open.
- The shift lever is in **P**.
- Press and hold the tailgate button on the remote transmitter for about one second when the power mode is in VEHICLE OFF (LOCK).

▶ Opening/Closing the Power Tailgate

The power tailgate may not open or close under the following conditions:

- The vehicle is parked on a steep hill.
- The vehicle is swayed in a strong wind.
- The tailgate or the roof is covered with snow or ice.

If you close the power tailgate when all the doors are locked, the power tailgate locks automatically.

If you replace the battery or the power tailgate fuse while the tailgate is open, the power tailgate may be disabled. The power tailgate resumes once you manually close the tailgate.

Installing aftermarket components other than Acura genuine accessories on the power tailgate may prevent it from fully opening or closing.

Make sure the power tailgate is fully open before you get your luggage in and out.

Make sure the power tailgate is fully closed before you start the vehicle.

Remote Transmitter

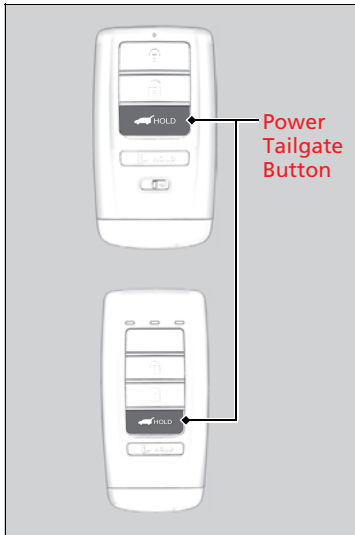

Press the power tailgate button for more than one second to operate when the power mode is in VEHICLE OFF (LOCK).

To reverse direction while the power tailgate is in operation, press the button again. The beeper sounds three times and the tailgate reverses direction.

Customizing when to open the tailgate

Anytime: The power tailgate unlocks and opens at the same time. This is the default setting.

When Unlocked: The tailgate opens when all doors are unlocked.

[Customized Features](#) P. 104
P. 248

Opening/Closing the Power Tailgate

If the power tailgate meets resistance while opening or closing, the auto reverse feature reverses the direction. The beeper sounds three times.

The auto reverse function stops sensing when the tailgate is almost closed to make sure that it fully closes.

Do not touch the sensors located on both sides of the tailgate. The power tailgate does not close if you touch either sensor when you are trying to close the tailgate.

Be careful not to scratch the sensors with a sharp object. If scratched, they can be damaged, and the power tailgate closing feature malfunctions.

■ Power Tailgate Button

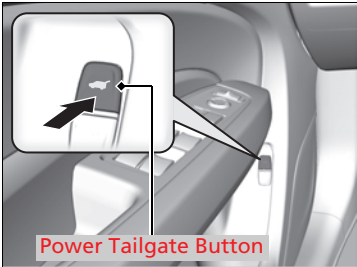

To open or close the power tailgate, press the power tailgate button for about one second. The beeper sounds and some exterior lights flash.

To reverse direction while the power tailgate is in operation, press the button again. The beeper sounds three times and the tailgate reverses direction.

■ Power Tailgate Outer Handle

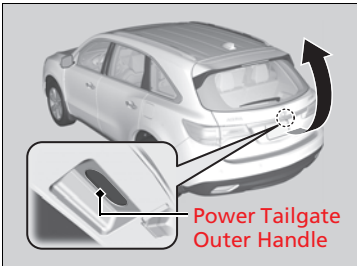

To open the power tailgate, press the outer handle for one second. The beeper sounds and some exterior lights flash.

■ Power Tailgate Close Button

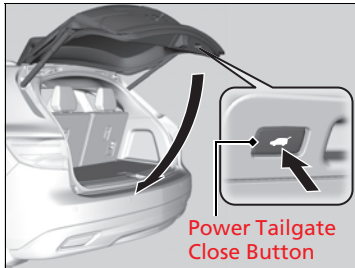

Press the button on the tailgate to close the power tailgate.
If you press the button again while the power tailgate is closing, it reverses direction.

■ Auto-Closer

If you manually close the power tailgate, it latches automatically.

☒ Power Tailgate Close Button

If you press the power tailgate close button while the tailgate is automatically opening, the power tailgate operation reverses direction.

☒ Auto-Closer

The auto-closer feature does not activate if you press the tailgate outer handle while the power tailgate is closing.

Do not put any force on the tailgate while the power tailgate is latching.

Keep your hands away from the tailgate when you manually close the tailgate and let it latch automatically. It is dangerous to put your hands around the tailgate as it starts to latch itself.

■ Power Tailgate Fall Detection

Automatically lowers the power tailgate when there is a possibility that the fully opened power tailgate can fall down by its own weight (for example, by snow on the tailgate). The beeper sounds while the power tailgate lowers.

☒ Power Tailgate Fall Detection

If you try to manually close the power tailgate immediately after it fully opens, the power tailgate fall detection may activate.

Once the power tailgate fall detection activates, wait until the power tailgate fully closes. Keep away from the power tailgate when it is in motion.

If the power tailgate fall detection constantly activates, consult at a dealer.

Immobilizer System

The immobilizer system prevents a key that has not been pre-registered from starting the engine. Each key contains electronic transmitters that use electronic signals to verify the key.

Pay attention to the following when pressing the **ENGINE START/STOP** button:

- Do not allow objects that emit strong radio waves near the **ENGINE START/STOP** button.
- Make sure the key is not covered by or touching a metal object.
- Do not bring a key from another vehicle's immobilizer system with the keyless access remote.

Security System Alarm

The security system alarm activates when the tailgate, hood, or doors are opened without the key, remote transmitter or keyless access system.

■ When the security system alarm activates

The horn sounds intermittently, and all of the exterior lights flash.

■ To deactivate the security system alarm

Unlock the vehicle using the key, remote transmitter, or keyless access system. The system, along with the horn and flashing lights, is deactivated.

☒ Immobilizer System

NOTICE

Leaving the keyless access remote in the vehicle can result in theft or accidental movement of the vehicle. Always take the key with you whenever you leave the vehicle unattended.

Do not alter the system or add other devices to it. Doing so may damage the system and make your vehicle inoperable.

☒ Security System Alarm

The security alarm continues for a maximum of two minutes until the security system alarm deactivates.

■ Setting the security system alarm

The security system alarm automatically sets when the following conditions have been met:

- The power mode is set to VEHICLE OFF (LOCK).
- The hood is closed.
- All doors and the tailgate are locked from outside with the key, remote transmitter, or keyless access system.

■ When the security system alarm sets

The security system alarm indicator in the instrument panel blinks. When the blinking interval changes after about 15 seconds, the security system alarm is set.

■ To cancel the security system alarm

The security system alarm is canceled when the vehicle is unlocked using the key, remote transmitter, keyless access system, or the power mode is set to ON. The security system alarm indicator goes off at the same time.

» Security System Alarm

Do not set the security system alarm when someone is in the vehicle or a window is open. The system can accidentally activate when unlocking the door with the lock tab.

If the battery goes dead after you have set the security system alarm, the security alarm may go off once the battery is recharged or replaced.

If this occurs, deactivate the security system alarm by unlocking a door using the key, remote transmitter, or keyless access system.

Do not attempt to alter this system or add another device to it.

Panic Mode

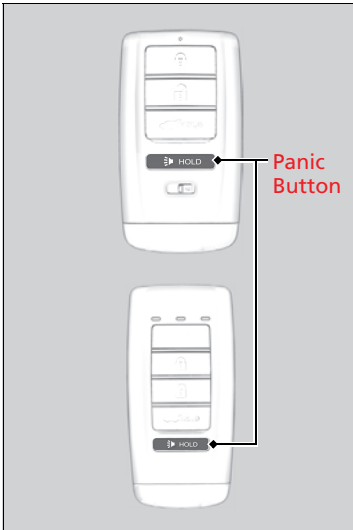

■ The panic button on the remote transmitter

If you press the panic button for approximately one second, the following will occur for about 30 seconds:

- The horn sounds.
- Some exterior lights flash.

■ Canceling panic mode

Press any button on the remote transmitter, or set the power mode to ON.

Opening/Closing the Power Windows

The power windows can be opened and closed when the power mode is in ON, using the switches on the doors. The driver's side switches can be used to open and close all of the windows.

The power window lock button on the driver's side must be switched off (not pushed in, indicator off) to open and close the windows from anywhere other than the driver's seat.

When the power window lock button is pushed in, the indicator comes on and you can only operate the driver's window. Turn the power window lock button on when children are in the vehicle.

Opening/Closing Windows with Auto-Open/Close Function

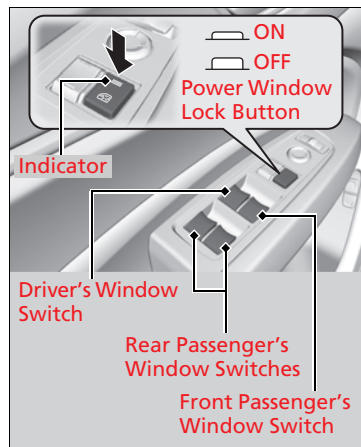

Automatic operation

To open: Push the switch down firmly.

To close: Pull the switch up firmly.

The window opens or closes completely. To stop the window at any time, push or pull the switch briefly.

Manual operation

To open: Push the switch down lightly, and hold it until the desired position is reached.

To close: Pull the switch up lightly, and hold it until the desired position is reached.

Opening/Closing the Power Windows

WARNING

Closing a power window on someone's hands or fingers can cause serious injury.

Make sure your passengers are away from the windows before closing them.

The power windows can be operated for up to 10 minutes after you set the power mode to VEHICLE OFF (LOCK).

Opening either front door cancels this function.

Auto Reverse

If a power window senses resistance when closing automatically, it stops closing and reverse direction.

The driver's window auto reverse function is disabled when you continuously pull up the switch.

The auto reverse function stops sensing when the window is almost closed to ensure that it fully closes.

■ Opening Windows and the Moonroof with the Remote

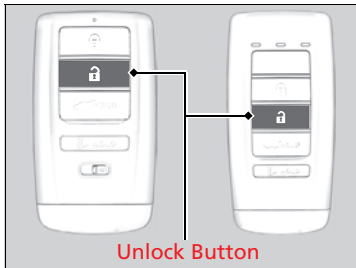

To open: Press the unlock button twice within 10 seconds and hold it down the second time. If the windows stop midway, repeat the procedure.

■ Opening/Closing Windows and the Moonroof with the Key

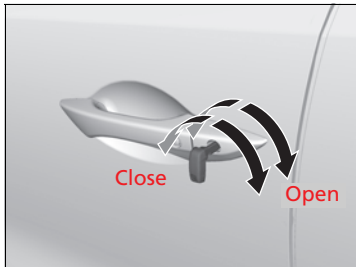

To open: Unlock the driver's door with the key. Within 10 seconds of returning the key to the central position, turn the key in the unlock direction and hold it there.

To close: Lock the driver's door with the key. Within 10 seconds of returning the key to the central position, turn the key in the lock direction and hold it there.

Release the key to stop the windows/moonroof at the desired position. If you want further adjustment, repeat the same operation.

■ Opening/Closing the Moonroof

You can only operate the moonroof when the power mode is in ON. Use the switch in the front of the ceiling to open and close the moonroof.

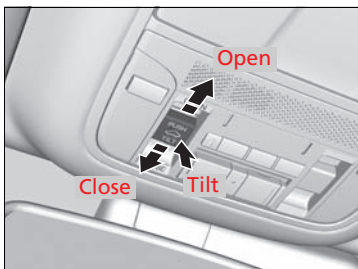

■ Automatic operation

To open: Pull the switch back firmly.

To close: Push the switch forward firmly.

The moonroof will automatically open or close all the way. To stop the moonroof midway, touch the switch briefly.

■ Manual operation

To open: Pull the switch back lightly, and hold it until the desired position is reached.

To close: Push the switch forward lightly, and hold it until the desired position is reached.

■ Tilting the moonroof up

To tilt: Push on the center of the moonroof switch.

To close: Push the switch forward firmly, then release.

☞ Opening/Closing the Moonroof

⚠ WARNING

Opening or closing the moonroof on someone's hands or fingers can cause serious injury.

Make sure all hands and fingers are clear of the moonroof before opening or closing it.

NOTICE

Opening the moonroof in below freezing temperature or when it is covered with snow or ice can damage the moonroof panel or motor.

The power moonroof can be operated for up to 10 minutes after you set the power mode to VEHICLE OFF (LOCK).

Opening either front door cancels this function.

When resistance is detected, the auto reverse function causes the moonroof to change directions, then stop. Auto reverse stops sensing when the moonroof is almost closed to ensure that it fully closes.

ENGINE START/STOP Button

Changing the Power Mode

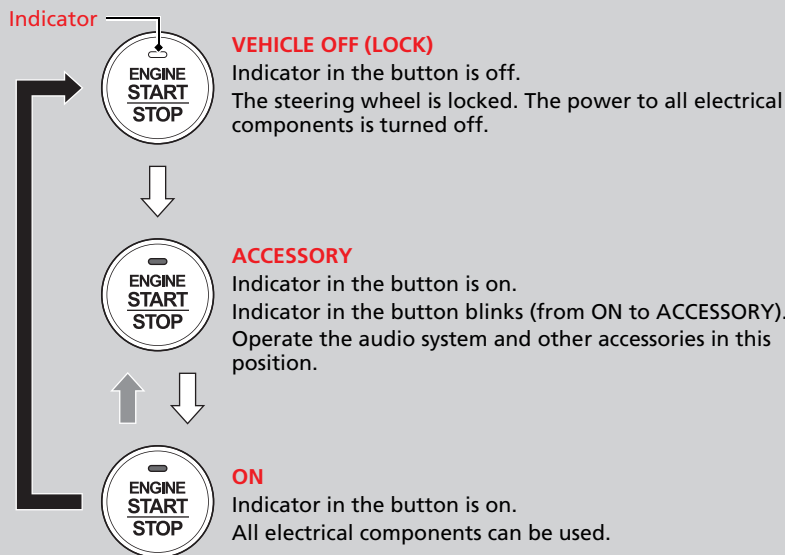

Without pressing the brake pedal

- ➔ Press the button without the shift lever in **P**.
- ➔ Press the button.
- ➔ Shift to **P**, then press the button.

ENGINE START/STOP Button

ENGINE START/STOP Button Operating Range

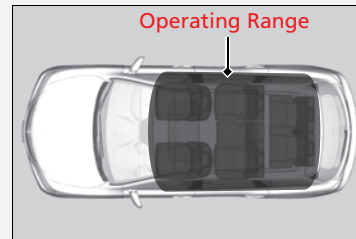

You can start the engine when the keyless access remote is inside the vehicle.

The engine may also run if the keyless access remote is close to the door or window, even if it is outside the vehicle.

ON mode:

Indicator in the button is off, if the engine is running.

If the keyless access remote battery is weak, beeper sounds and the **To Start, Hold Remote Near Start Button** message appears on the MID.

➔ **If the Keyless Access Remote Battery is Weak** P. 458

If the power mode does not change from VEHICLE OFF to ACCESSORY, press the **ENGINE START/STOP** button while moving the steering wheel left and right. The steering wheel will unlock, allowing the mode to change.

■ Automatic Power Off

If you leave the vehicle for 30 to 60 minutes with the shift lever in **P** and the power mode in ACCESSORY, the vehicle automatically goes into the mode similar to VEHICLE OFF (LOCK) to avoid the battery drain.

When in this mode:

The steering wheel does not lock.

You cannot lock or unlock doors with the remote transmitter or the keyless access system.

Press the **ENGINE START/STOP** button to switch the mode to VEHICLE OFF (LOCK).

■ Power Mode Reminder

If you open the driver's door when the power mode is set to ACCESSORY, a warning buzzer sounds.

■ Keyless Access Remote Reminder

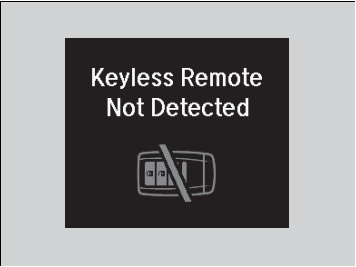

Warning buzzers may sound from inside or/ and outside the vehicle to remind you that the keyless access remote is out of the vehicle. If the buzzer continues even after the remote is put back inside, place it within its operational range.

■ When the power mode is in ON

If the keyless access remote is taken out of the vehicle, and the driver's door is closed, warning buzzers sound from both inside and outside the vehicle. A warning message on the MID notifies the driver inside that the remote is out.

■ When the power mode is in ACCESSORY

If the keyless access remote is taken out of the vehicle, and the driver's door is closed, a warning buzzer sounds from outside the vehicle.

▣ Keyless Access Remote Reminder

When the keyless access remote is within the system's operational range, and the driver's door is closed, the warning function cancels.

If the keyless access remote is taken out of the vehicle after the engine has been started, you can no longer change the **ENGINE START/STOP** button mode or restart the engine. Always make sure if the remote is in your vehicle when you operate the **ENGINE START/STOP** button.

Removing the keyless access remote from the vehicle through a window does not activate the warning buzzer.

Do not put the keyless access remote on the dashboard or in the glove box. It may cause the warning buzzer to go off. Under some other conditions that can prevent the vehicle from locating the remote, the warning buzzer may also go off even if the remote is within the system's operational range.

QRG

Turn Signals

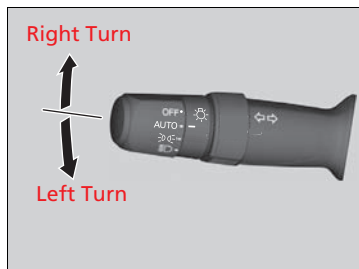

The turn signals can be used when the power mode is in ON.

■ One-touch turn signal

When you lightly push up or down and release the turn signal lever, the exterior turn signals and turn signal indicator blink three times. This feature can be used when signaling for a lane change.

TOC

Controls

Index

Home

Light Switches

Manual Operation

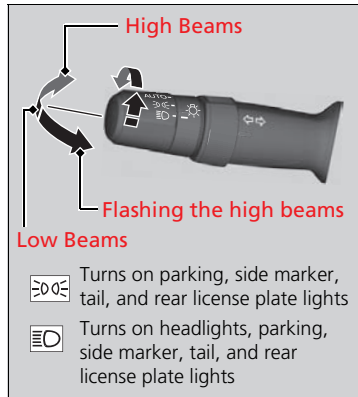

Rotating the light switch turns the lights on and off, regardless of the power mode setting.

High beams

Push the lever forward until you hear a click.

Low beams

When in high beams, pull the lever back to return to low beams.

Flashing the high beams

Pull the lever back, and release it.

Lights off

Turn the lever to **OFF** either when:

- The shift lever is in **P**.
- The parking brake is applied.

To turn the lights on again, turn the lever to **OFF** to cancel the lights off mode. Even if you do not cancel the lights off mode, the lights come on automatically when:

- The shift lever is moved out of **P** and the parking brake is released.
- The vehicle starts to move.

Light Switches

If you leave the power mode in VEHICLE OFF (LOCK) with the lights on, a light on reminder chime sounds when you open the driver's door.

Do not leave the lights on when the engine is off because it will cause the battery to discharge.

Canadian models with rear entertainment system

Your vehicle is equipped with the automatic headlight adjusting system that automatically adjusts the vertical angle of the high/low beam headlights. If you find a significant change in the vertical angle of the headlights, there may be a problem with the system. Have your vehicle checked by a dealer.

Automatic Lighting Control



Automatic lighting control can be used when the power mode is in ON.

When the light switch is in **AUTO**, the headlights and other exterior lights will switch on and off automatically depending on the ambient brightness.

▶ You can change the auto light sensitivity setting.

▶ [Customized Features P. 104](#)
[P. 248](#)

Automatic Lighting Control

We recommend that you turn on the lights manually when driving at night, in a dense fog, or in dark areas such as long tunnels or parking facilities.

The light sensor is in the location shown below. Do not cover this light sensor with anything; otherwise, the automatic lighting system may not work properly.

Models with Automatic Intermittent Wipers

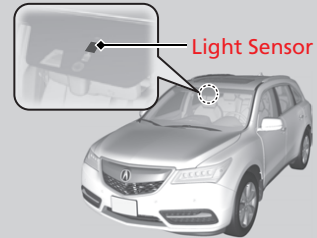

Models without Automatic Intermittent Wipers

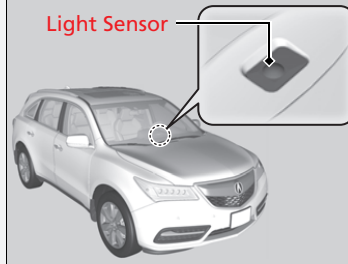

■ Headlight Integration with Wiper

The headlights automatically come on when the wipers are used several times within a certain intervals with the headlight switch in **AUTO**.

The headlights automatically go off a few minutes later if the wipers are stopped.

■ Automatic Lighting Off Feature

The headlights, all other exterior lights, and the instrument panel lights turn off 15 seconds after you set the power mode to VEHICLE OFF (LOCK), take the remote with you, and close the driver's door.

If you set the power mode to VEHICLE OFF (LOCK) with the headlight switch on, but do not open the door, the lights turn off after 10 minutes (three minutes, if the switch is in the **AUTO** position).

The lights turn on again when you unlock or open the driver's door. If you unlock the door, but do not open it within 15 seconds, the lights go off. If you open the driver's door, you will hear a lights on reminder chime.

⌘ Automatic Lighting Control

Adjust the auto light sensitivity as follows:

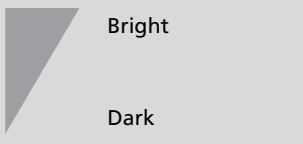
Setting	The exterior lights come on when the ambient light is at
Max	
High	
Mid	
Low	
Min	

⌘ Headlight Integration with Wiper

This feature activates during the headlights are off in **AUTO**.

The instrument panel brightness does not change when the headlights come on.

When the ambient light is at dark, the automatic lighting control feature overrides, and the headlights come on with or without the wipers sweeping more than several times.

⌘ Automatic Lighting Off Feature

You can change the headlight auto off timer setting.

➤ [Customized Features P. 104](#)
[P. 248](#)

Daytime Running Lights

The daytime running lights come on when the following conditions have been met:

- The power mode is in ON.
- The headlight switch is **AUTO**, or in .
- The parking brake is released.

The daytime running lights are off once the headlight switch is turned on, or when the head light switch is in **AUTO** and it is getting darker outside.

Wipers and Washers

Windshield Wipers/Washers

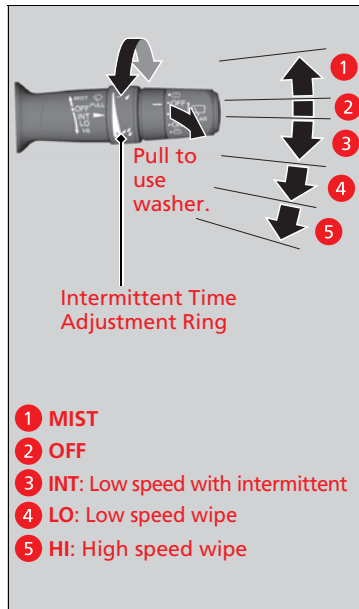

The windshield wipers and washers can be used when the power mode is in ON.

■ MIST

The wipers run at high speed until you release the lever.

■ Wiper switch (OFF, INT*, LO, HI)

Change the wiper switch setting according to the amount of rain.

■ Adjusting the delay

Turn the adjustment ring to adjust the wiper delay.



■ Washer

Sprays while you pull the lever toward you. When you release the lever, the wipers make two or three more sweeps before stopping.

Wipers and Washers

NOTICE

Do not use the wipers when the windshield is dry. The windshield will get scratched, or the rubber blades will get damaged.

NOTICE

In cold weather, the blades may freeze to the windshield, becoming stuck.

Operating the wipers in this condition may damage the wipers. Use the defroster to warm the windshield, then turn the wipers on.

If the vehicle speeds up while the wipers are operating intermittently, the length of the wipe interval shortens.

When the vehicle starts moving, the wipers make a single sweep.

When the vehicle speeds up, the wiper operation's shortest delay setting (👆) and the **LO** setting become the same.

Turn the washers off if no washer fluid comes out. The pump may get damaged.

The wiper motor may stop motor operation temporarily to prevent an overload. Wiper operation will return to normal within a few minutes, once the circuit has returned to normal.

* Not available on all models

■ Automatic Intermittent Wipers *

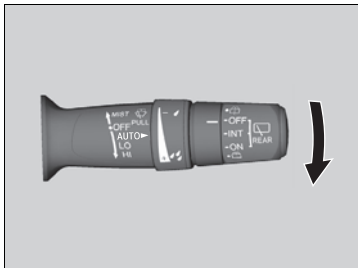

When you push the lever down to **AUTO**, the windshield wipers sweep once, and go into the automatic mode.

The wipers operate intermittently, at low speed, or at high speed and stops in accordance with the amount of rainfall the rainfall sensor detects.

■ Auto sensitivity adjustment

When in **AUTO**, you can also adjust the rainfall sensor sensitivity using the intermittent time adjustment ring.

Sensor sensitivity



Low: The wipers start to react to a larger amount of rainfall.

High: The wipers start to react to a smaller amount of rainfall.

▶▶ Automatic Intermittent Wipers *

The rainfall sensor is in the location shown below.

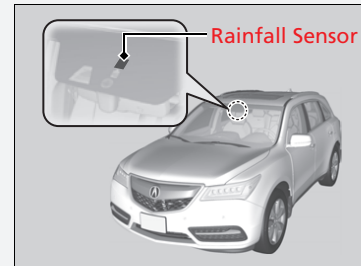

Do not put the wiper lever in **AUTO** when cleaning the windshield or driving through a car wash. If the wiper lever is in **AUTO**, and the power mode is in ON, the rainfall sensor may respond to your hand or car wash liquids, and the wipers may operate automatically.

Rear Wiper/Washer



- 1 INT: Intermittent
- 2 ON: Continuous wipe
- 3 OFF
- 4 Washer

The rear wiper and washer can be used when the power mode is in ON.

Wiper switch (OFF, INT, ON)

Change the wiper switch setting according to the amount of rain.

Washer (Washer icon)

Sprays while you rotate the switch to this position.

Hold it to activate the wiper and to spray the washer. Once released, it stops operating after a few more sweeps.

Operating in reverse

When you shift the transmission to **R** with the front wiper activated, the rear wiper operates automatically as follows even if its switch is off.

Front Wiper Position	Rear Wiper Operation
INT (Intermittent)	Intermittent
LO (Low speed wipe) HI (High speed wipe)	Continuous

Wipers and Washers

If the wiper stops operating due to any obstacle such as the build-up of snow, park the vehicle in a safe place.

Rotate the wiper switch to **OFF**, and set the power mode to ACCESSORY or VEHICLE OFF (LOCK), then remove the obstacle.

QRG

Canadian models

■ Headlight Washers

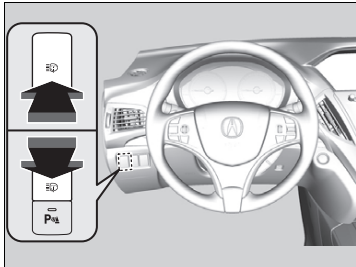

Turn the headlights on and press the headlight washer button to operate.

The headlight washers also operate when you turn the windshield washers for the first time after the power mode is set to ON.

▶ Headlight Washers

The headlight washers use the same fluid reservoir as the windshield washers.

TOC

Controls

Index

Home

Brightness Control

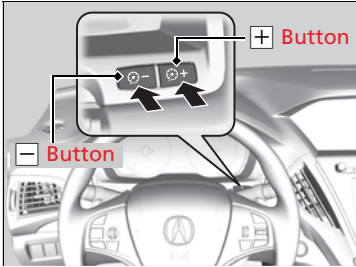

When the power mode is in ON, you can use the **+** or **-** button to adjust instrument panel brightness.

To brighten: Press the **+** button.

To dim: Press the **-** button.

You will hear a beep when the brightness reaches minimum or maximum. The MID will return to its original state several seconds after you adjust the brightness.

■ Brightness level indicator

The brightness level is shown on the MID while you are adjusting it.



☒ Brightness Control

Instrument panel brightness varies, depending on whether the exterior lights are on or off. The instrument panel dims to reduce glare when they are on.

When it is bright outside and the headlight integration with the wiper is activated, the instrument panel brightness does not change.

Rolling the multi-function steering-wheel controls switches the display.

If you press the **+** button until the brightness display is up to max, the beeper sounds. This cancels the reduced instrument panel brightness when the parking lights are on.

The brightness can be set differently for when the exterior lights are on, and when they are off.

Defogger/Heated Door Mirror

Canadian models

Heated Windshield Button

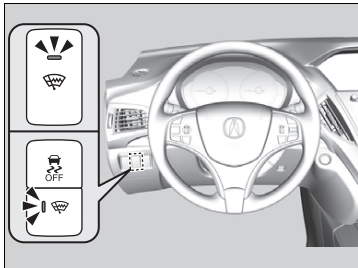

Press the heated windshield button to deice the windshield when the power mode is in ON.

Defogger/Heated Door Mirror

This system consumes a lot of power, so turn it off when the window has been defogged or deiced.

Heated Windshield Button

When the outside temperature is below 4°C, the heated windshield may automatically activate. The system deactivates itself once the outside temperature reaches 6°C.

Rear Defogger/Heated Door Mirror Button

Rear Defogger/Heated Door Mirror Button

Press the rear defogger and heated door mirror button to defog the rear window and mirrors when the power mode is in ON.

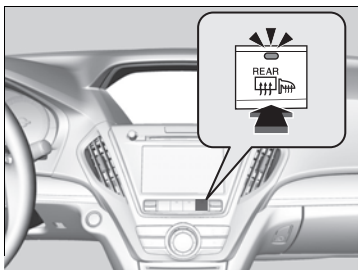

The rear defogger and heated door mirrors automatically switch off after 10-30 minutes depending on the outside temperature.

NOTICE

When cleaning the inside of the rear window, be careful not to damage the heating wires. It is critical to wipe the window from side to side along the defogger heating wires.

Driving Position Memory System

You can store two driver's seat (except for power lumbar), steering wheel and door mirror positions with the driving position memory system.

When you unlock and open the driver's door with a remote transmitter, or keyless access system, the seat and door mirrors adjust automatically to one of the two preset positions.

The steering wheel will move to the stored position when you set the power mode to ACCESSORY.

The MID shows you which remote transmitter you used to unlock the vehicle when you enter.

- **DRIVER 1** transmitter is linked to memory button 1.
- **DRIVER 2** transmitter is linked to memory button 2.



Driving Position Memory System

Using the audio/information screen or MID, you can disable the automatic seat, steering wheel and door mirrors adjustment function.

▶ [Customized Features](#) P. 104
P. 248

■ Storing a Position in Memory

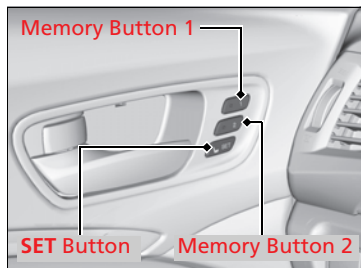

1. Set the power mode to ON. Adjust the driver's seat, the steering wheel and the door mirrors to the desired position.
2. Press the **SET** button.
 - ▶ You will hear a beep, and the memory button indicator light will blink.
3. Press memory button **1** or **2** within five seconds of pressing the **SET** button.
 - ▶ Once the seat, the steering wheel and the outside mirror positions have been memorized, the indicator light on the button you pressed stays on.

■ Recalling the Stored Position

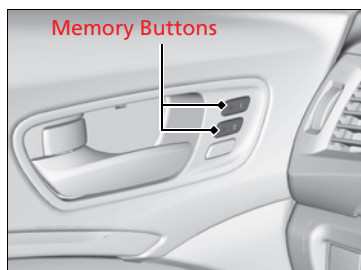

1. Move the shift lever to **P**.
2. Apply the parking brake.
3. Press a memory button (**1** or **2**).
 - ▶ You will hear a beep, and the indicator light will blink.

The seat, the steering wheel and the door mirrors will automatically move to the memorized positions. When it has finished moving, you will hear the beep, and the indicator light stays on.

⌘ Storing a Position in Memory

After you press the **SET** button, the storing operation will be canceled when:

- You do not press the memory button within five seconds.
- You readjust the seat, the steering wheel or the outside mirror position before the double-beep.
- You set the power mode to any position except ON.

⌘ Recalling the Stored Position

The seat will stop moving if you:

- Press the **SET** button, or a memory button (**1** or **2**).
- Adjust the seat, the steering wheel or the door mirror position.
- Shift into any position except **P**.

Adjusting the Steering Wheel

The steering wheel height and distance from your body can be adjusted so that you can comfortably grip the steering wheel in an appropriate driving posture.

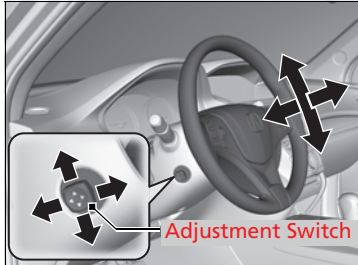

Push and hold the adjustment switch to move the steering wheel in, out, up or down.

- ▶ Make sure you can see the instrument panel gauges and indicators.

Adjusting the Steering Wheel

⚠ WARNING

Adjusting the steering wheel position while driving may cause you to lose control of the vehicle and be seriously injured in a crash.

Adjust the steering wheel only when the vehicle is stopped.

Make any steering wheel adjustments before you start driving.

Interior Rearview Mirror

Adjust the angle of the rearview mirror when you are sitting in the correct driving position.

Automatic Dimming Rearview Mirror and Power Door Mirrors*

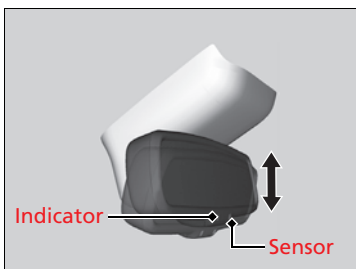

When driving after dark, the automatic dimming rearview mirror and power door mirrors* reduce the glare from headlights behind you.

Adjusting the Mirrors

Keep the inside and outside mirrors clean and adjusted for best visibility.

Adjust the mirrors before you start driving.

[Adjusting the Seat Positions P. 161](#)

Automatic Dimming Rearview Mirror and Power Door Mirrors*

The auto dimming function cancels when the shift position is in **R**.

Power Door Mirrors

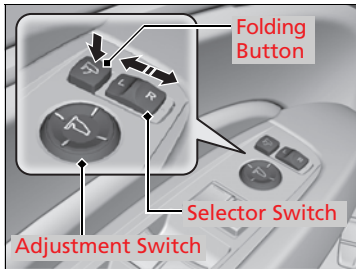

You can adjust the door mirrors when the power mode is in ON.

■ Mirror position adjustment

L/R selector switch: Select the left or right mirror. After adjusting the mirror, return the switch to the center position.

Mirror position adjustment switch: Press the switch left, right, up, or down to move the mirror.

■ Folding door mirrors*

Press the folding button to fold in and out the door mirrors.

■ Reverse Tilt Door Mirror

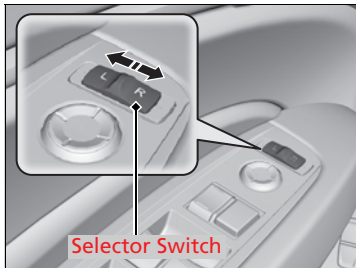

If activated, either side door mirror automatically tilts downward when you put the shift lever in **R**; this improves close-in visibility on the selected side of the vehicle when backing up. The mirror automatically returns to its original position when you shift out of **R**.

To activate this feature, set the power mode to ON, and slide the selector switch to the left or right side.

■ Expanded View Driver's Mirror

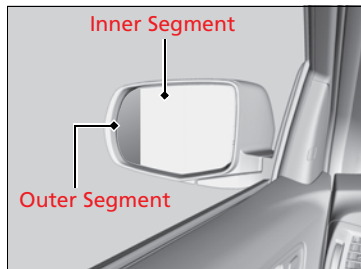

The driver's side door mirror has outer and inner segments.

The outer segment is slightly curved to provide a wider angle view than a standard flat mirror. This wider view may help you check areas that are not visible using a standard door mirror.

▣ Expanded View Driver's Mirror

Objects visible in the outer segment of the driver's side door mirror appear smaller than objects in the rest of the mirror. But in fact, they are closer than they appear.

Do not rely on your mirrors. Always look to the side and behind your vehicle before changing lanes.

Adjusting the Seat Positions

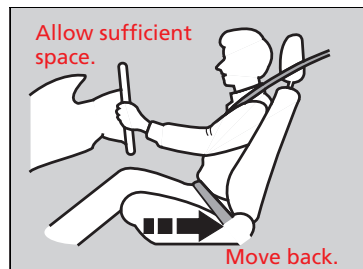

Adjust the driver's seat as far back as possible while allowing you to maintain full control of the vehicle. You should be able to sit upright, well back in the seat and be able to adequately press the pedals without leaning forward, and grip the steering wheel comfortably. The passenger's seat should be adjusted in a similar manner, so that it is as far back from the front airbag in the dashboard as possible.

■ Adjusting the front power seats

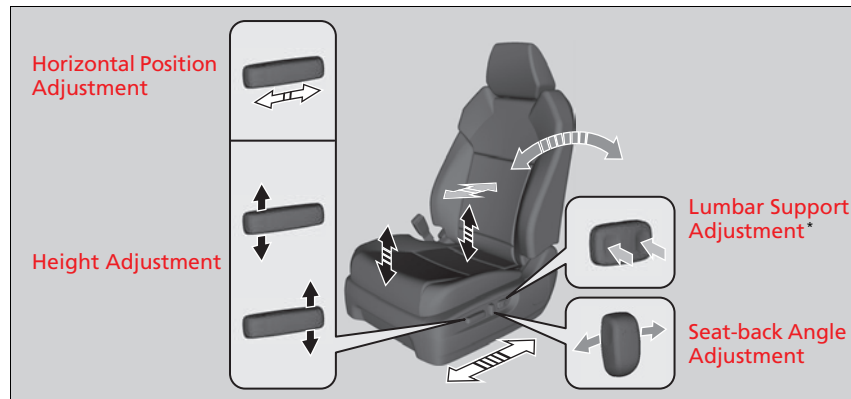

Adjusting the Seats

⚠ WARNING

Sitting too close to a front airbag can result in serious injury or death if the front airbags inflate.

Always sit as far back from the front airbags as possible while maintaining control of the vehicle.

The National Highway Traffic Safety Administration and Transport Canada recommend that drivers allow at least 10 inches (25 cm) between the center of the steering wheel and the chest.

Always make seat adjustments before driving.

Once a seat is adjusted correctly, rock it back and forth to make sure it is locked in position.

* Not available on all models

■ Adjusting the second row manual seats

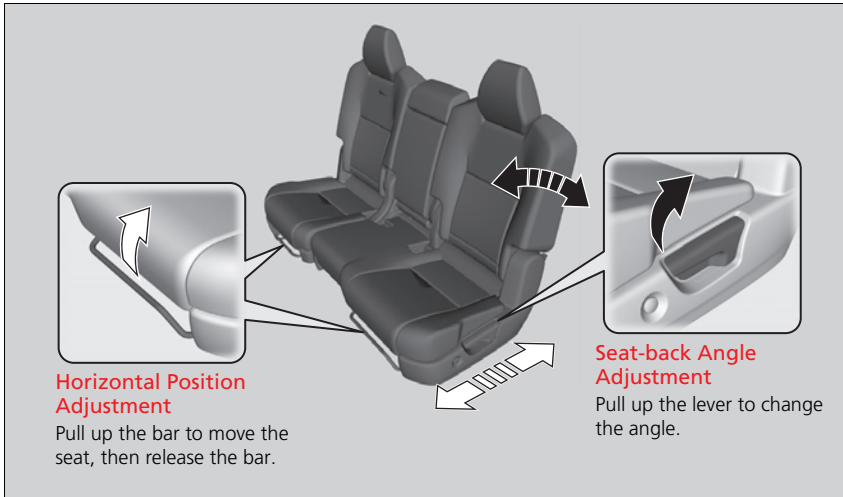

Adjusting the Seat-Backs

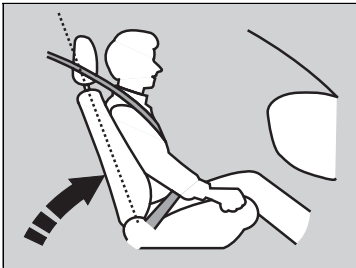

Adjust the driver's seat-back to a comfortable, upright position, leaving ample space between your chest and the airbag cover in the center of the steering wheel.

The front seat passenger should also adjust their seat-back to a comfortable, upright position.

Reclining a seat-back so that the shoulder part of the belt no longer rests against the occupant's chest reduces the protective capability of the belt. It also increases the chance of sliding under the belt in a crash and being seriously injured. The farther a seat-back is reclined, the greater the risk of injury.

Adjusting the Seat-Backs

⚠ WARNING

Reclining the seat-back too far can result in serious injury or death in a crash.

Adjust the seat-back to an upright position, and sit well back in the seat.

Do not put a cushion, or other object, between the seat-back and your back. Doing so may interfere with proper seat belt or airbag operation.

If you cannot get far enough away from the steering wheel and still reach the controls, we recommend that you investigate whether some type of adaptive equipment may help.

■ Adjusting the Head Restraints

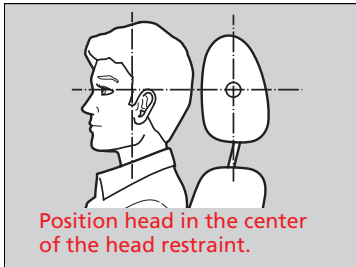

Your vehicle is equipped with head restraints in all seating positions.

Head restraints are most effective for protection against whiplash and other rear-impact crash injuries when the center of the back of the occupant's head rests against the center of the restraint. The tops of the occupant's ears should be level with the center height of the restraint.

■ Adjusting the front and second row outer head restraint positions

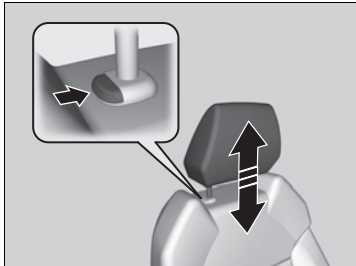

To raise the head restraint: Pull it upward.

To lower the head restraint: Push it down while pressing the release button.

▶▶ Adjusting the Head Restraints

⚠ WARNING

Improperly positioning head restraints reduces their effectiveness and increases the likelihood of serious injury in a crash.

Make sure head restraints are in place and positioned properly before driving.

In order for the head restraint system to work properly:

- Do not hang any items on the head restraints, or from the restraint legs.
- Do not place any objects between an occupant and the seat-back.
- Install each restraint in its proper location.

Changing the Second Row Center Seat Head Restraint Position

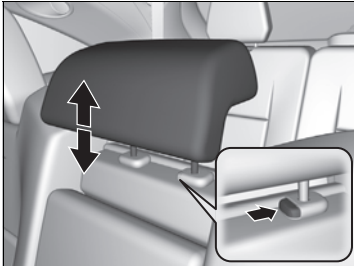

A passenger sitting in the second row center seating position should adjust the height of their head restraint to an appropriate position before the vehicle begins moving.

To raise the head restraint:

Pull it upward.

To lower the head restraint:

Push it down while pressing the release button.

Removing and Reinstalling the Head Restraints

Front and second row head restraints

Head restraints can be removed for cleaning or repair.

To remove a head restraint:

Pull the restraint up as far as it will go. Then push the release button, and pull the restraint up and out.

To reinstall a head restraint:

Insert the legs back in place, then adjust the head restraint to an appropriate height while pressing the release button. Pull up on the restraint to make sure it is locked in position.

Removing and Reinstalling the Head Restraints

⚠ WARNING

Failure to reinstall, or correctly reinstall, the head restraints can result in severe injury during a crash.

Always replace the head restraints before driving.

■ Folding Down the Third Row Head Restraint

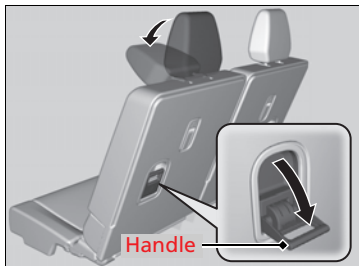

A passenger in the third row seating position should put the head restraint in the upright position before the vehicle begins moving.

To fold down the head restraint:

Pull the handle.

To put the head restraint back in the upright position:

Pull up the head restraint and push rearward until it latches.

Maintain a Proper Sitting Position

After all occupants have adjusted their seats and head restraints, and put on their seat belts, it is very important that they continue to sit upright, well back in their seats, with their feet on the floor until the vehicle is safely parked and the engine is off.

Sitting improperly can increase the chance of injury during a crash. For example, if an occupant slouches, lies down, turns sideways, sits forward, leans forward or sideways, or puts one or both feet up, the chance of injury during a crash is greatly increased.

In addition, an occupant who is out of position in the front seat can be seriously or fatally injured in a crash by striking interior parts of the vehicle or being struck by an inflating front airbag.

ⓘ Maintain a Proper Sitting Position

WARNING

Sitting improperly or out of position can result in serious injury or death in a crash.

Always sit upright, well back in the seat, with your feet on the floor.

Rear Seats

■ Third Row Seat Access

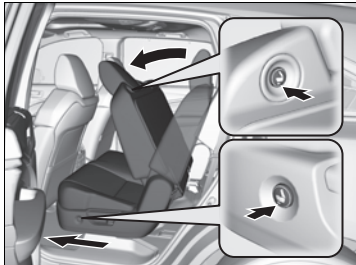

Pressing the button on the seat-back, or seat cushion tilts the second row outer seat's seat-back forward.

► The whole seat slides forward.

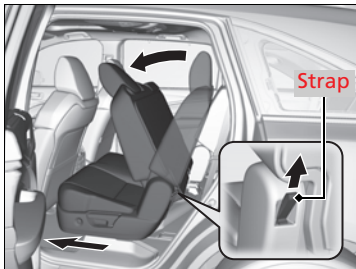

Pulling up on the strap also tilts the seat-back forward.

▣ Third Row Seat Access

The button is disabled when the vehicle is moving.

When you enter the third row seat, be careful not to trip over the second row seat belt.

Folding Down the Second Row Seat

Separately fold down the left and right halves of the second row seat to make room for cargo.

1. Store the center seat belt first. Insert the latch plate into the slot on the side of the anchor buckle.
2. Retract the seat belt into the holder on the ceiling.
[▶ Seat Belt with Detachable Anchor P. 36](#)
3. Lower the center head restraint to its lowest position. Put the armrest back into the seat-back.

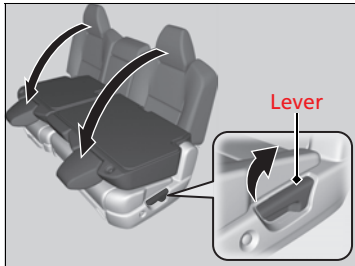

4. Pull up on the seat-back angle adjustment lever.

To return the seat to the original position, pull up the seat-back in the upright position.

Folding Down the Second Row Seat

Make sure that the folded seat-back does not press against the front passenger seat, as this can cause the weight sensors in the front passenger seat to work improperly.

[▶ Passenger Airbag Off Indicator P. 52](#)

The front seats must be far enough forward so they do not interfere with the second row seats as they fold down.

To lock the seat-back upright, push it backwards until it locks.

Make sure the seat-back, head restraints and seat cushion are securely latched back into place before driving. Also, make sure all rear shoulder belts are positioned in front of the seat-back, and the center shoulder belt is re-positioned in the holding slot.

■ Folding Down the Third Row Seat

Separately fold down the left and right halves of the third row seat to make room for cargo.

■ To fold down the seat

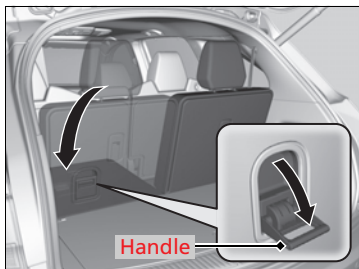

1. Pull the handle on the seat-back fully.
 - The head restraint tilt downward.
2. Push the seat-back forward while pulling the handle.

■ To return the seat to the original position

1. Pull the seat-back up with the handle pulled.
2. Push the head restraint up to its original position.

☒ Folding Down the Third Row Seat

Make sure all items in the cargo area or items extending to the third row seats are properly secured. Loose items can fly forward if you have to brake hard.

☒ To return the seat to the original position

Make sure the seat-back and head restraints are securely latched back into place before driving.

Armrest

QRG

■ Using the Front Seat Armrest

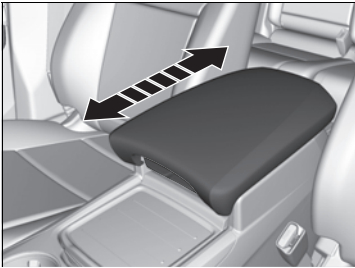

The console lid can be used as an armrest.

To adjust:

Slide the armrest to a desired position.

TOC

Controls

■ Using the Rear Seat Armrest

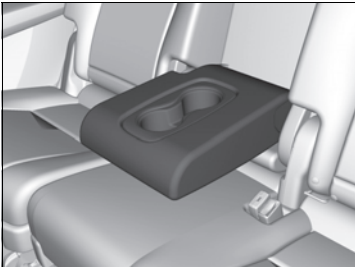

Pull down the armrest in the center seat-back.

Index

Home

Interior Lights

Interior Light Switches

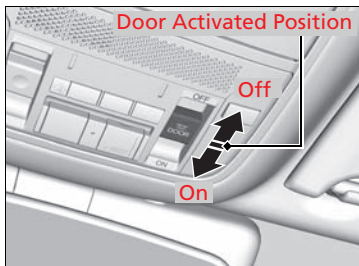

■ ON

The interior lights come on regardless of whether the doors are open or closed.

■ Door activated

The interior lights come on in the following situations:

- When any doors are opened.
- You unlock the driver's door.
- When the power mode is set to VEHICLE OFF (LOCK).

■ OFF

The interior lights remain off regardless of whether the tailgate or the doors are open or closed.

Interior Light Switches

In the door activated position, the interior lights fade out and go off about 30 seconds after the doors are closed.

The lights go off after 30 seconds in the following situations:

- When you unlock the driver's door but do not open it.
- When you set the power mode to VEHICLE OFF (LOCK) but do not open a door.

You can change the interior lights dimming time.

[Customized Features P. 104](#)
[P. 248](#)

The interior lights go off immediately in the following situations:

- When you lock the driver's door.
- When you close the driver's door in ACCESSORY mode.
- When you set the power mode to ON.

If you leave any doors open in VEHICLE OFF (LOCK) mode, the interior lights go off after about 15 minutes.

When the interior light switch is in **ON**, if you close the tailgate and all doors in VEHICLE OFF (LOCK) mode, the interior lights go off after about 30 minutes.

However, when the battery is weakened, the interior lights go off after about 30 minutes if any door is open.

Map Lights

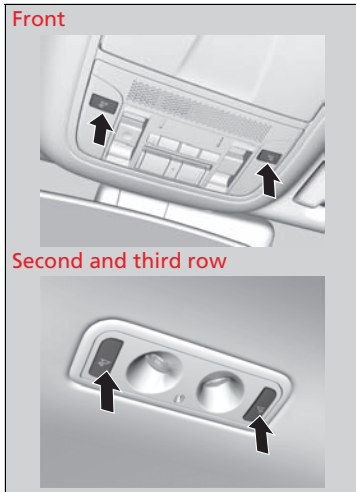

■ Front

The map lights can be turned on and off by pressing the  (map light) button.

■ Second and third row

The map lights can be turned on and off by pressing the  (map light) button when the front interior light switch is in the door activated position.

☒ Map Lights

When the interior light switch is in the door activated position and any door is open, pressing the  button does not turn off the map light.

Cargo Area Lights

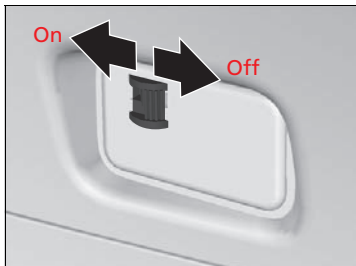

■ ON

The light comes on when you open the tailgate, and goes off when closed.

■ OFF

The light stays off with or without opening the tailgate.

Interior Convenience Items

■ Glove Box

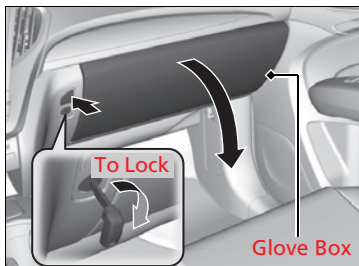

Press the button to open the glove box. You can lock the glove box with the built-in key.

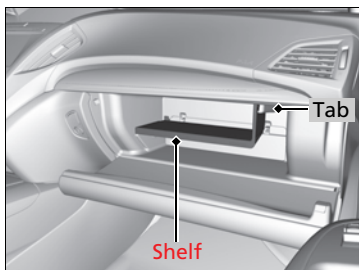

■ Removable shelf

The shelf in the glove box is detachable. To remove it, disengage the tabs.



The removed shelf can be stored upside down in the glove box.

» Glove Box

⚠ WARNING

An open glove box can cause serious injury to your passenger in a crash, even if the passenger is wearing the seat belt.

Always keep the glove box closed while driving.

■ Console Compartment

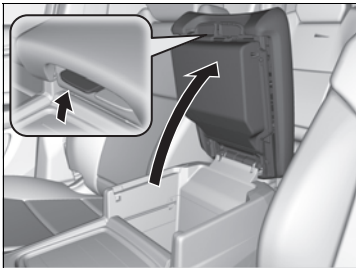

Pull the passenger's side handle to open the console compartment.

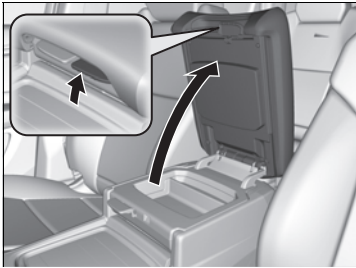

Pull the driver's side handle to open the utility tray in the console lid.

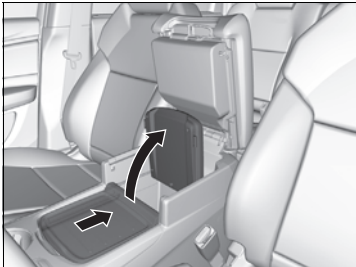

■ Console Tray
Slide or lift the tray when you use the console compartment.

- To lift this tray, slide it rearward, then pull it up.

■ Center Pocket

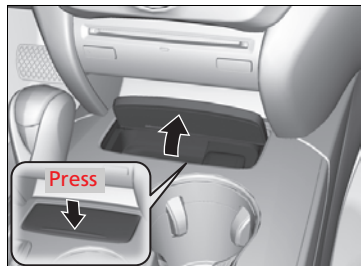

Press the raised detent to open the lid. To close the lid, push it down until it latches.

■ Under-floor Storage Area



Pull the handle to open the cargo floor lid.

■ Beverage Holders



■ Front seat beverage holders

Are located in the console between the front seats.

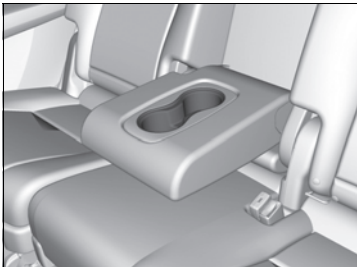

■ Second row seat beverage holders

Fold the armrest down to use the rear seat beverage holders.



■ Third row seat beverage holders

» Beverage Holders

NOTICE

Spilled liquids damage the upholstery, carpeting, and electrical components in the interior.

Be careful when you are using the beverage holders. Hot liquid can scald you.

QRG

■ Accessory Power Sockets

The accessory power sockets can be used when the power mode is in ACCESSORY or ON.

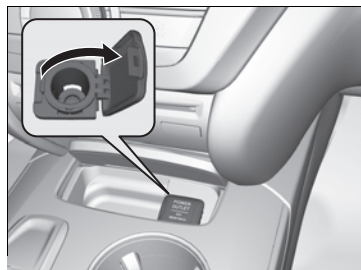

■ Accessory power socket (center pocket)

Open the lid and the cover to use it.

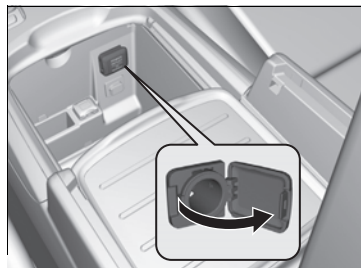

■ Accessory power socket (console compartment)

Pull the handle and open the cover to use it.

» Accessory Power Sockets

NOTICE

Do not insert an automotive type cigarette lighter element.

This can overheat the power socket.

The accessory power sockets are designed to supply power for 12 volt DC accessories that are rated 180 watts or less (15 amps).

To prevent battery drain, only use the power socket with the engine running.

TOC

Controls

Index

Home

QRG

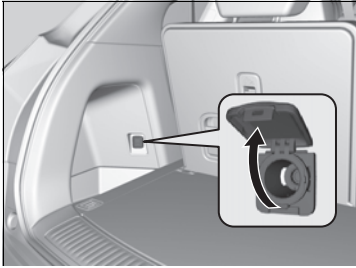

■ **Accessory power socket (cargo area)**

Open the cover to use it.

TOC

Controls

■ **AC Power Outlet***

The AC power outlet can be used when the engine is running.

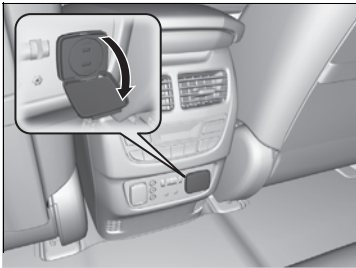

Open the cover to use it. Plug in the appliance slightly, turn it 90° clockwise, then push it all the way.

⌘ AC Power Outlet*

NOTICE

Do not use the AC power outlet for electric appliances that require high initial peak wattage, such as cathode-ray tube type televisions, refrigerators, electric pumps, etc. It is not suitable for devices that process precise data, such as medical equipment, and that require an extremely stable power supply, such as microcomputer-controlled electric blankets, touch sensor lamps, etc.

The AC power outlet is designed to supply power for up to 115 volt appliances that are rated 150 watts or less.

Continued use of any electric appliance/device exceeding these ratings may result in damage to the appliance/device.

Index



* Not available on all models

Continued

■ Coat Hooks



There is a coat hook on the rear grab handle of both sides. Pull it down to use it.

■ Tie-down Anchors

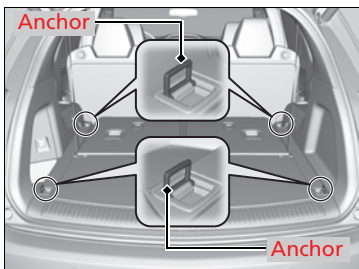

The tie-down anchors on the cargo area floor can be used to install a net for securing items.

☒ Coat Hooks

The coat hooks are not designed for large or heavy items.

■ Sunglasses Holder

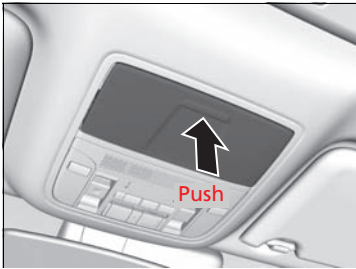

To open the sunglasses holder, push and release the indent. To close, push it again until it latches.

You can store eyeglasses and other small items in this holder.

Canadian models

■ Heated Steering Wheel

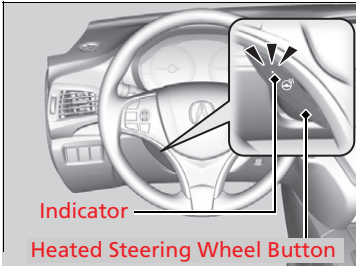

The power mode must be in ON to use the heated steering wheel.

Press the button on the left side of the steering wheel.

When a comfortable temperature is reached, press the button again to turn it off.

The heated steering wheel is turned off every time you start the engine, even if you turned it on the last time you drove the vehicle.

☒ Sunglasses Holder

Keep the holder closed while driving except when accessing stored items.

☒ Heated Steering Wheel

Do not use the heated steering wheel continuously when the engine is off. Under such conditions, the battery may be weakened, making the engine difficult to start.

■ Front Seat Heaters and Seat Ventilation*



If the power mode is in ON:

Seat heater - The HI setting heats the seats faster than the LO setting.

Seat ventilation* - The HI setting ventilates the seats faster than the LO setting.

Models with seat ventilation

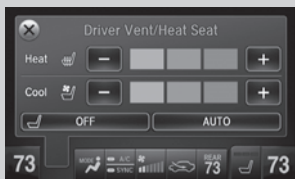

Models without seat ventilation

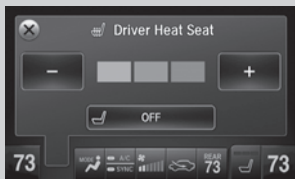

1. Select .
2. Change the setting with one of the following:

The **Heat/Cool*** level indicators: Select your desired level setting. The left is for a LO setting, the center is for a MID setting, and to the right for a HI setting.

: To go up or down one level at a time.

AUTO*: The system automatically selects the setting most suitable to the ambient environment.

OFF: Turn off the system.

When a comfortable temperature is reached while using the seat heaters in HI, select MID or LO to keep the seat warm.

⚠ Front Seat Heaters and Seat Ventilation*

⚠ WARNING

Heat induced burns are possible when using seat heaters.

Persons with a diminished ability to sense temperature (e.g., persons with diabetes, lower-limb nerve damage, or paralysis) or with sensitive skin should not use seat heaters.

Do not use the seat heaters and the seat ventilation even in LO when the engine is off. Under such conditions, the battery may be weakened, making the engine difficult to start.

■ Second Row Outer Seat Heaters *

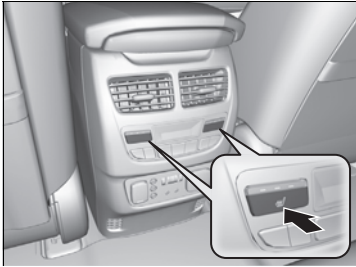

The power mode must be in ON to use the seat heaters. The HI setting heats the seats faster than the LO setting.

Press the seat heater button:

Once - The HI setting (three indicators on)

Twice - The MID setting (two indicators on)

Three times - The LO setting

Four times - The OFF setting (no indicators on)

▣ Second Row Outer Seat Heaters *

⚠ WARNING

Heat induced burns are possible when using seat heaters.

Persons with a diminished ability to sense temperature (e.g., persons with diabetes, lower-limb nerve damage, or paralysis) or with sensitive skin should not use seat heaters.

Do not use the seat heaters even in LO when the engine is off. Under such conditions, the battery may be weakened, making the engine difficult to start.

* Not available on all models

QRG

TOC

Controls

Index



■ Integrated Sunshades*

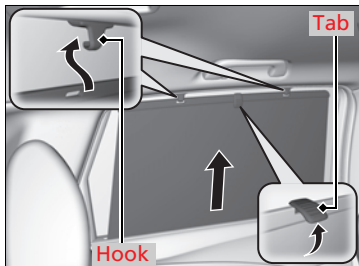

Pull the tab and roll up the sunshade all the way. Use the hooks to hang it.

▣ Integrated Sunshades*

Use the sunshades only when the windows are fully closed. Using the shade while a window is open can unhook and blow off the shade, hitting and hurting anyone sitting near the window.

QRG

Using Automatic Climate Control

The automatic climate control system maintains the interior temperature you select. The system also selects the proper mix of heated or cooled air that raises or lowers the interior temperature to your preference as quickly as possible.

TOC

Controls

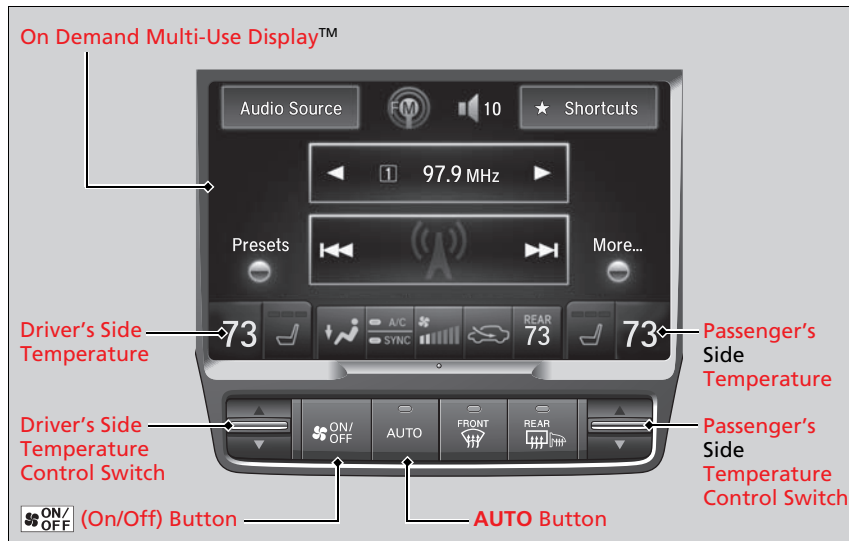

Use the system when the engine is running.

1. Press the **AUTO** button.
2. Adjust the interior temperature using the driver's side or passenger's side temperature control switch.
3. Press the  (On/Off) button to cancel.

Using Automatic Climate Control

If any buttons/icons on the touch screen are pressed while using the climate control system in AUTO, the function of the button/icon that was pressed will take priority.

The AUTO indicator will go off, but functions unrelated to the button/icon that was pressed will be controlled automatically.

To prevent cold air from blowing in from outside, the fan may operate at low speed for a while after the **AUTO** button has been pressed.

If the interior is very warm, you can cool it down more rapidly by partially opening the windows, turning the system on auto, and setting the temperature to low. Change the fresh mode to recirculation mode until the temperature cools down.

When you set the temperature to the lower or upper limit, **Lo** or **Hi** is displayed.

Pressing the  button switches the climate control system between on and off. When turned on, the system returns to your last selection.

When you unlock the doors with your remote, the driver's ID (**Driver 1** or **Driver 2**) is detected, and the climate control settings are turned to the respective mode automatically when you set the power mode to ON.

Index

Home

Continued

■ Operating from the On Demand Multi-Use Display™

In addition to the button/switch controls, you can operate the climate control system from the On Demand Multi-Use Display™ touch screen.

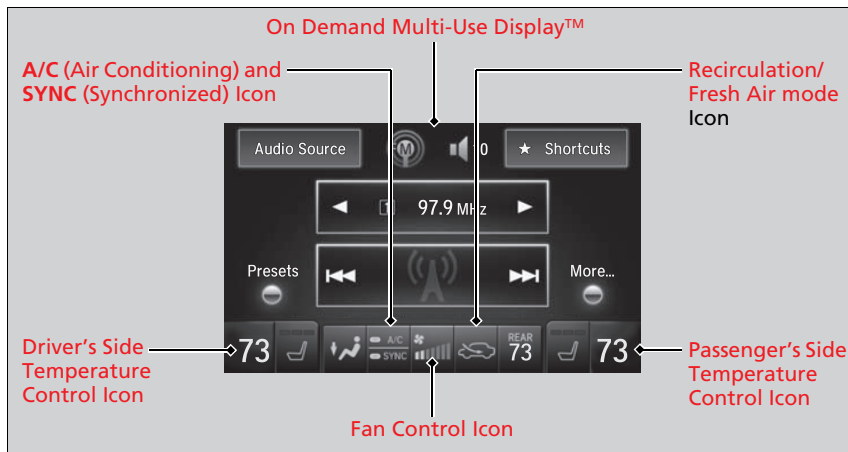

▣ Using Automatic Climate Control

You can store two customized climate control settings to the system and recall them from the On Demand Multi-Use Display™.

[▶ Shortcuts P. 205](#)

■ Changing the interior temperature setting

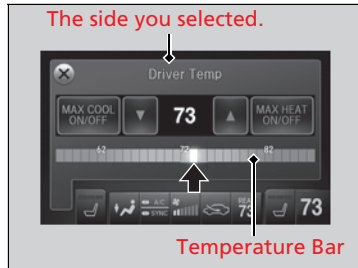

1. Select the driver's or passenger's side temperature control icon.
2. Change the temperature setting from the following:

Temperature bar: Select a point where your desired temperature setting is.

Farther to the left is for a lower, and to the right for a higher setting.

▲/▼: To raise or lower the temperature setting one degree at a time.

While you select and hold **▲/▼**, the temperature decreases or increases.

MAX COOL ON/OFF: To rapidly cool down the interior.

- The A/C indicator comes on. The setting returns to the previously selected value when you select it again.

MAX HEAT ON/OFF: To rapidly warm up the interior.

- The A/C indicator goes off. The setting returns to the previously selected value when you select it again.

Using Automatic Climate Control

When you set the temperature to the lower or upper limit, **Lo** or **Hi** is displayed.

When you set the **MAX COOL** or **MAX HEAT**, **MAX COOL** or **MAX HEAT** is displayed.

■ Switching the vent mode

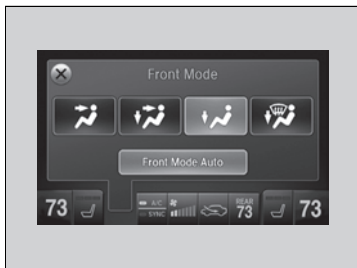

Select a desired vent mode icon, or **Front Mode Auto**: The system automatically selects the vent mode most suitable to the ambient environment.

Vent mode

- : Dashboard vents
- : Dashboard and floor vents
- : Floor vents
- : Floor and defroster vents

■ A/C on and off

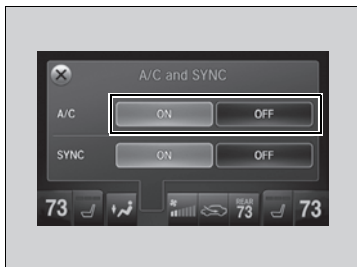

1. Select **A/C**.
2. Select **ON** or **OFF**.

► Switching the vent mode

While the climate control system is in AUTO, **Front Mode Auto** is highlighted.

■ SYNC on and off

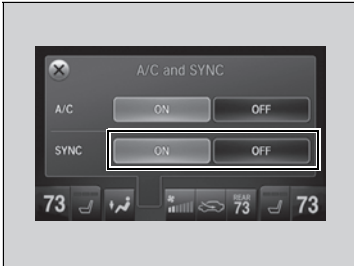

1. Select **SYNC**.
2. Select **ON** for synchronized mode.
 - When in synchronized mode, the front passenger's side temperature and the rear passenger compartment become the same as the driver's side settings.
3. Adjust the temperature or change the mode from the driver's side.

■ Changing the fan speed

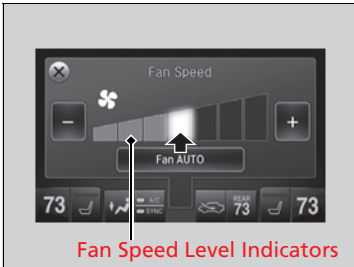

1. Select .
 2. Change the fan speed with one of the following:
- The fan speed level indicators: Select your desired speed level. The smaller indicator is for a slower speed, and the larger for a faster speed.

: To go up or down one level at a time.

Fan AUTO: The system automatically selects the fan speed most suitable to the ambient environment.

▣ SYNC on and off

When you press the  button, the system synchronizes the driver's and front passenger's temperature settings.

When the system is not in SYNC mode, the driver's side temperature, the front passenger's side temperature and the rear passenger compartment (if it is on) can be set separately.

You can also turn off SYNC mode by changing the front passenger's side temperature or rear passenger's temperature.

Models with navigation system





The system adjusts each temperature based on the information of the sunlight sensor and the sun position updated by the navigation system's GPS.

▣ Changing the fan speed

While the climate control system is in AUTO, **Fan AUTO** is highlighted.

■ Switching between the recirculation and fresh air modes



1. Select  or  currently shown.
2. Switch the mode depending on environmental conditions to the following:
 -  (Recirculation Mode): Recirculates air from the vehicle's interior through the system.
 -  (Fresh Air Mode): Maintains outside ventilation. Keep the system in fresh air mode in normal situations.

■ Defrosting the Windshield and Windows

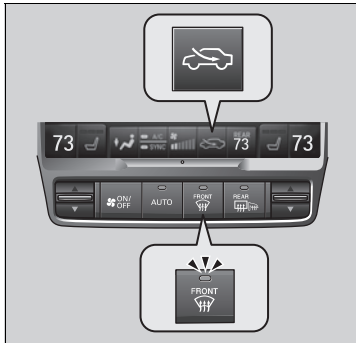

Press the  button to turn the air conditioning system on and automatically switch the system to fresh air mode.

Press the  button again to turn off, the system returns to the previous settings.

■ To rapidly defrost the windows

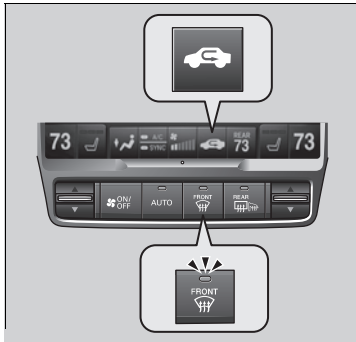

1. Press the  button.
2. Select the recirculation mode.
 - [Switching between the recirculation and fresh air modes](#) P. 190

☒ Defrosting the Windshield and Windows

For your safety, make sure you have a clear view through all the windows before driving.

Do not set the temperature near the upper or lower limit.

When cold air hits the windshield, the outside of the windshield may fog up.

If the side windows fog up, adjust the vents so that the air hits the side windows.

☒ To rapidly defrost the windows

After defrosting the windows, switch over to fresh air mode.

If you keep the system in recirculation mode, the windows may fog up from humidity. This impedes visibility.

Rear Climate Control System

■ Using the Rear Climate Control System From the Front Panel

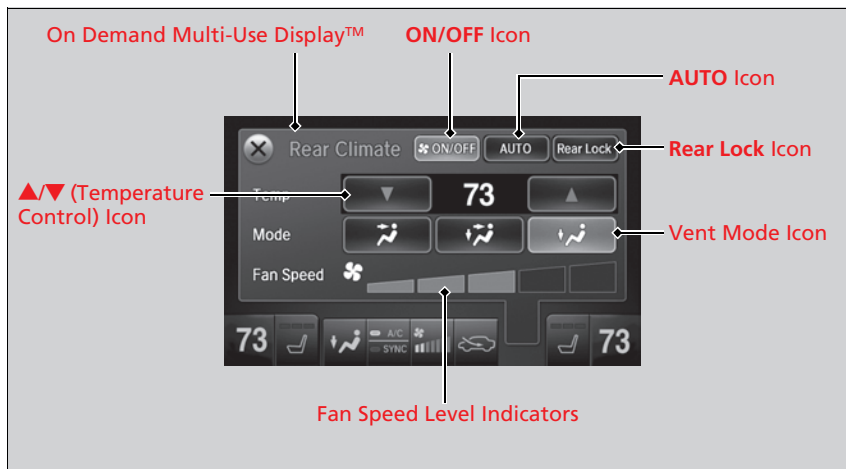

Use the system when the engine is running.

1. Select **REAR**.
2. Select **AUTO**.
 - The rear system changes to AUTO mode.
3. Adjust the rear passenger's compartment temperature using the temperature bar.
4. Select the **ON/OFF** to cancel.
 - When the turned back on, the system returns to your last selection.

▣ Rear Climate Control System

If any icons on the touch screen are pressed while using the rear climate control system in AUTO, the function of the icon that was pressed will take priority.

Rear Lock: Appears on the front panel. When selected, it disables the rear panel control.

LOCK: Appears on the rear control panel while the rear lock is on.

If the rear lock is on while in SYNC mode, the rear control panel is disabled. **LOCK SYNC** appears on the rear control panel.

■ Changing the rear temperature setting

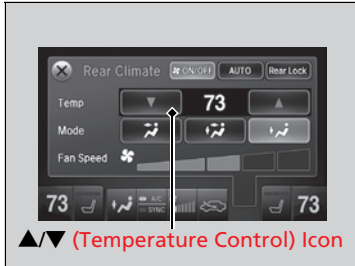

Change the temperature setting from the following:

▲/▼: To raise or lower the temperature setting one degree at a time.

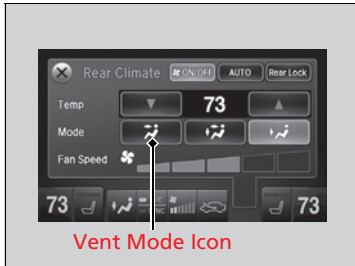

While you select and hold ▲/▼, the temperature decreases or increases.

■ Switching the vent mode



Select a desired vent mode icon.

Vent mode

- : Rear console vents
- : Rear console vents and floor vents
- : Rear floor vents

► Changing the rear temperature setting

When you set the temperature to the lower or upper limit, **Lo** or **Hi** is displayed.

■ Changing the fan speed

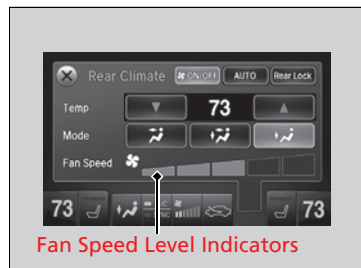

Select your desired speed level. The smaller indicator is for a slower speed, and the larger for a faster speed.

■ Using the Rear Climate Control System From the Rear Panel

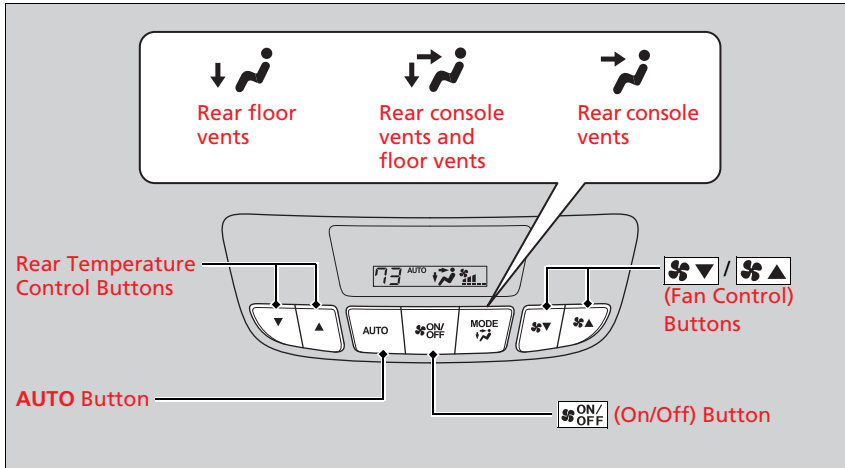

Use the system when the engine is running

1. Press the **AUTO** button.
2. Adjust the interior temperature using the rear temperature control button.
3. To turn off the rear climate control system, press  button.

▣ Using the Rear Climate Control System From the Rear Panel

When the **Rear Lock** icon on the front control panel is off, the temperature of the rear passenger compartment can be controlled independently.

QRG

Automatic Climate Control Sensors

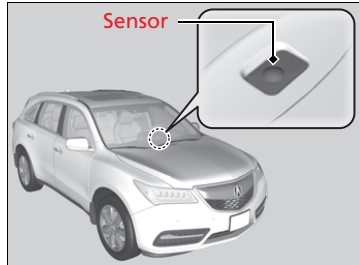

The automatic climate control system is equipped with sensors. Do not cover or spill any liquid on them.

TOC

Controls

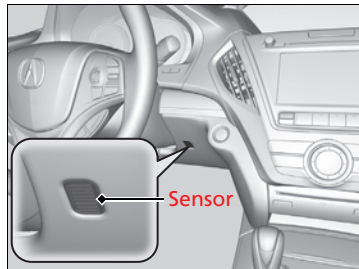

Index

Home

Features

This chapter describes how to operate technology features.



Audio System

- About Your Audio System 198
- USB Port 199
- Auxiliary Input Jack 200
- Audio System Theft Protection 201
- Audio Remote Controls..... 202

Audio System Basic Operation

- On Demand Multi-Use Display™..... 204
- Audio/Information Screen 211
- Adjusting the Sound 215
- Display Setup 216
- Playing AM/FM Radio 217
- Playing XM® Radio 221

- Playing a CD 224
- Playing an iPod®..... 227
- Playing Internet Radio 231
- Playing a USB Flash Drive 234
- Playing *Bluetooth*® Audio..... 237

Audio Error Messages

- CD Player..... 239
- iPod®/USB Flash Drive..... 240
- Pandora® 241
- Aha™ Radio..... 243

General Information on the Audio System

- XM® Radio Service 244

- Recommended CDs 245
- Compatible iPod®, iPhone®, and USB Flash Drives..... 247

Customized Features

- Defaulting All the Settings 265

HomeLink® Universal Transceiver ...

- Bluetooth*® HandsFreeLink® Using HFL 268
- HFL Menus 270

Compass* 301

* Not available on all models

About Your Audio System

Models with navigation system

See the Navigation System Manual for operation of the audio system, AcuraLink, rear entertainment system*, *Bluetooth*® HandsFreeLink®, and voice commands for these features.

Models without navigation system

The audio system features AM/FM radio and XM® Radio service. It can also play audio CDs, WMA/MP3/AAC files, USB flash drives, and iPod®, iPhone® and *Bluetooth*® devices.

You can operate the audio system from the buttons and switches on the panel or the icons on the touchscreen interface.

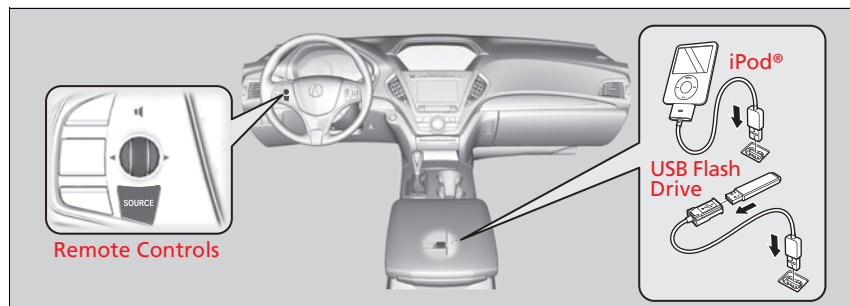

About Your Audio System

XM® Radio is available on a subscription basis only. For more information on XM® Radio, contact a dealer.

[General Information on the Audio System](#)
P. 244

XM® Radio is available in the United States and Canada, except Hawaii, Alaska, and Puerto Rico.

XM® is a registered trademark of Sirius XM Radio, Inc.

Video CDs, DVDs*, and 3-inch (8-cm) mini CDs are not supported.

iPod® and iPhone® are registered trademarks owned by Apple Inc.

State or local laws may prohibit the operation of handheld electronic devices while operating a vehicle.

When the screen is viewed through polarized sunglasses, a rainbow pattern may appear on the screen due to optical characteristics of the screen. If this is disturbing, please operate the screen without polarized sunglasses.

USB Port

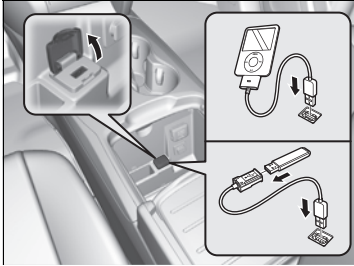

Install the iPod® dock connector or the USB flash drive to the USB port.

⊠ USB Port

- Do not leave the iPod® or USB flash drive in the vehicle. Direct sunlight and high temperatures may damage it.
- We recommend using an extension cable with the USB port.
- Do not connect the iPod® or USB flash drive using a hub.
- Do not use a device such as a card reader or hard disk drive, as the device or your files may be damaged.
- We recommend keeping your data backed up before using the device in your vehicle.
- Displayed messages may vary depending on the device model and software version.

If the audio system does not recognize the iPod®, try reconnecting it a few times or reboot the device. To reboot, follow the manufacturer's instructions provided with the iPod® or visit www.apple.com/ipod

Auxiliary Input Jack

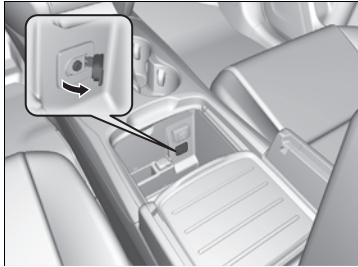

Use the jack to connect standard audio devices.

1. Open the **AUX** cover.
2. Connect a standard audio device to the input jack using a 1/8 inch (3.5 mm) stereo miniplug.
 - ▶ The audio system automatically switches to the AUX mode.

▶▶ Auxiliary Input Jack

You can return to the AUX mode by selecting **Change Source** on the **Audio menu** screen or **Audio Source** on the touchscreen.

Audio System Theft Protection

The audio system is disabled when it is disconnected from the power source, such as when the battery is disconnected or goes dead. In certain conditions, the system may display **Enter PIN Code**. If this occurs, reactivate the audio system.

■ Reactivating the audio system

1. Set the power mode to ON.
2. Turn on the audio system.
3. Press and hold the audio system power button for more than two seconds.
 - ▶ The audio system is reactivated when the audio control unit establishes a connection with the vehicle control unit. If the control unit fails to recognize the audio unit, you must go to a dealer and have the audio unit checked.

Audio Remote Controls

Allows you to operate the audio system while driving.

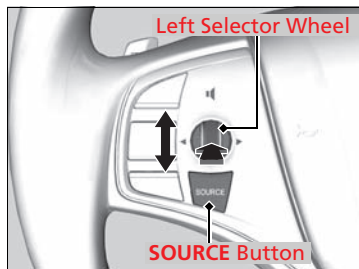

SOURCE Button

Cycles through the audio modes as follows:
 FM → AM → XM → CD → USB → iPod® →
Bluetooth® Audio → Pandora® → Aha™ →
 AUX

Left Selector Wheel

Roll Up: To increase the volume.

Roll Down: To decrease the volume.

Push: To mute. Push again to unmute.

Audio Remote Controls

The CD mode appears only when a CD is loaded. Pandora®, *Bluetooth*® Audio, or Aha™ mode appears when a connection (*Bluetooth*® or USB) is established with a device.

To select audio mode, press the **SOURCE** button, then shift the left selector wheel to the right or left.

- When listening to the radio
 - Shift to the right:** To select the next preset radio station.
 - Shift to the left:** To select the previous preset radio station.
 - Shift to the right and hold:** To select the next strong station.
 - Shift to the left and hold:** To select the previous strong station.
- When listening to a CD, iPod®, USB flash drive, or *Bluetooth*® Audio
 - Shift to the right:** To skip to the next song.
 - Shift to the left:** To go back to the beginning of the current or previous song.
 - Shift to the right and hold:** To go to the group up. (*Bluetooth*® Audio only)
 - Shift to the left and hold:** To go to the group down. (*Bluetooth*® Audio only)
- When listening to a CD or USB flash drive
 - Shift to the right and hold:** To skip to the next folder.
 - Shift to the left and hold:** To go back to the previous folder.
- When listening to Pandora® and Aha™
 - Shift to the right:** To skip to the next song.
 - Shift to the right and hold:** To select the next station.
 - Shift to the left and hold:** To select the previous station.

To use the audio system, the power mode must be in ACCESSORY or ON.

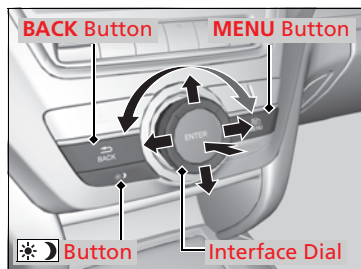

Use the interface dial or **MENU** button to access some audio functions.

Press to switch between the normal and extended display for some functions.

Interface dial: Rotate left or right to scroll through the available choices. Press to set your selection. Move right, left, up or down to select secondary menu.

MENU button: Press to select any mode. The available mode includes **Change Source, Station List, Save Preset, Radio Text, Music Search,** and play modes. Play modes can be also selected from **Scan, Random/Repeat,** and so on.

BACK button: Press to go back to the previous display.

button: Press to change the audio/information screen brightness.

Press once and make an adjustment.

- ▶ Each time you press , the mode switches between the daytime mode, nighttime mode and off mode.

Audio System Basic Operation

These indications are used to show how to operate the interface dial.

Rotate to select.

Press to enter.

Move , , or to select secondary menu.

Audio Menu Items

Station List P. 219

Save Preset P. 218
P. 223

Radio Text P. 220

Music Search P. 225
P. 229
P. 235

Scan P. 226
P. 236

Random/Repeat P. 226
P. 230
P. 236

When you unlock the doors with your remote, the driver's ID (**Driver 1** or **Driver 2**) is detected, and the audio system settings and preset memory are turned to the respective mode automatically when you set the power mode to ON.



On Demand Multi-Use Display™

Use the On Demand Multi-Use Display™ to operate the audio system.

Selecting an Audio Source

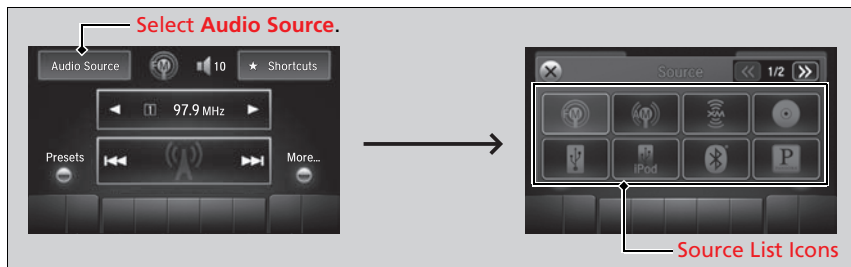

Select **Audio Source**, then select an icon on the source list to switch the audio source.

Displaying the Menu Items

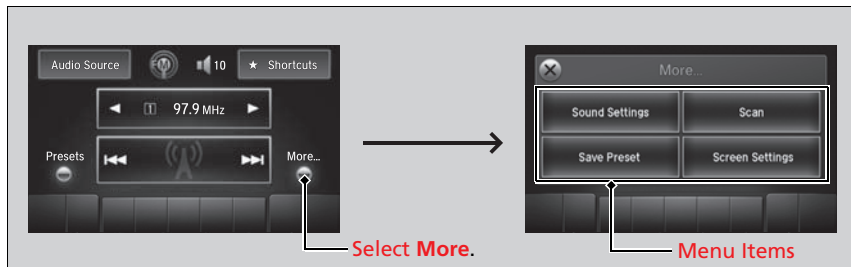

Select **More** to display the menu items.

On Demand Multi-Use Display™

Icons that appear on the screen vary by the source selected.

Select to go back to the previous screen.

Use the icons to turn the page.

QRG

Shortcuts

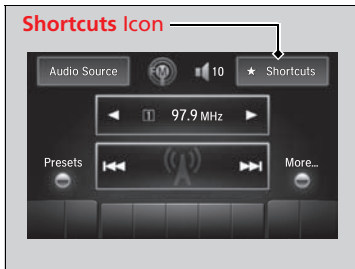

You can preset the settings of three categories (**Phone, Climate, Audio**) from **Shortcuts**.

TOC

Features

Index

Home

■ Phone

You can preset five previously stored speed dial entries, and make a call from one of the preset numbers, or call history when the phone is paired and connected to the vehicle's *Bluetooth*® HandsFreeLink® (HFL) system. [▶Phone Setup P. 274](#)

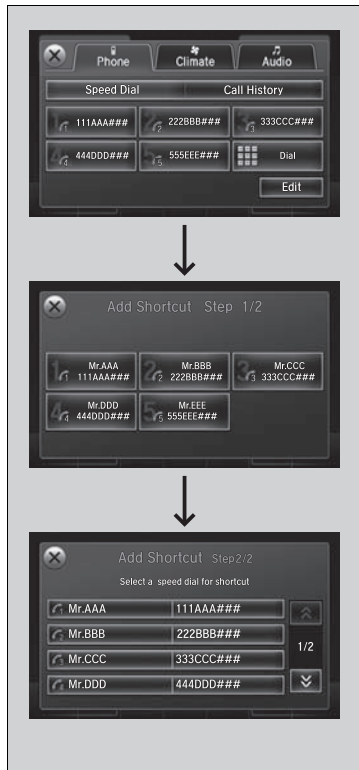

To preset a speed dial:

1. Select **Shortcuts**.
2. Select **Phone**.
3. Select **Speed Dial**.
4. Select **Edit** or **No Entry**.
 - ▶ If you select **No Entry**, go to step 6.
5. Select **Add**.
 - ▶ Five presets appear. Select a **No Entry** preset or an existing preset.
 - ▶ The screen changes to a list of previously stored speed dial entries.
6. Select a number you want to store as a shortcut.

To make a call from a speed dial entry:

1. Select **Shortcuts**.
2. Select **Phone**.
3. Select **Speed Dial**.
4. Select a preset number.
 - ▶ Dialing starts automatically.

☰ Phone

[▶ Speed Dial P. 285](#)

Dial icon

You can make a call using the keyboard on the On Demand Multi-Use Display™ to input numbers.

[▶ To make a call using a phone number P. 290](#)



To delete a speed dial:

1. Select **Shortcuts**.
2. Select **Phone**.
3. Select **Speed Dial**.
4. Select **Edit**.
5. Select **Delete**.
6. Select the preset number with the phone number you want to delete.



To make a call from call history:

1. Select **Shortcuts**.
2. Select **Phone**.
3. Select **Call History**.
4. Select a phone number.
 - ▶ Dialing starts automatically.

☒ Phone

The call history displays the last six dialed, received, or missed calls.

■ Climate

You can store two sets of your preferred temperature, fan speed, and vent mode settings to the climate control system.

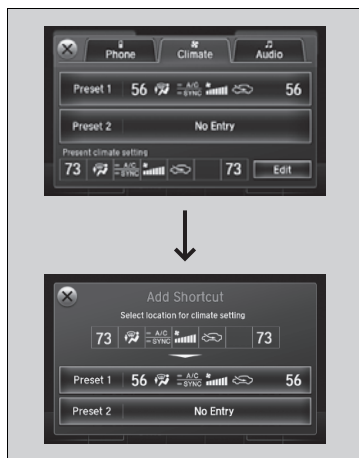

To store a set of the climate control settings:

1. Select **Shortcuts**.
2. Adjust the climate control system to your preference.
[▶ Climate Control System P. 185](#)
3. Select **Climate**.
4. Select **Edit**.
5. Select **Add**.
6. Select **Preset 1** or **Preset 2** you want to store your settings to.

To recall one of the settings:

1. Select **Shortcuts**.
2. Select **Climate**.
3. Select **Preset 1** or **Preset 2**.

To delete a preset:

1. Select **Shortcuts**.
2. Select **Climate**.
3. Select **Edit**.
4. Select **Delete**.
5. Select **Preset 1** or **Preset 2** you want to delete.

☒ Climate

You can also store a set by pressing and holding the preset number you want to store that setting after step 3.

■ Audio

You can store up to six radio stations when playing AM, FM, or XM® radio.

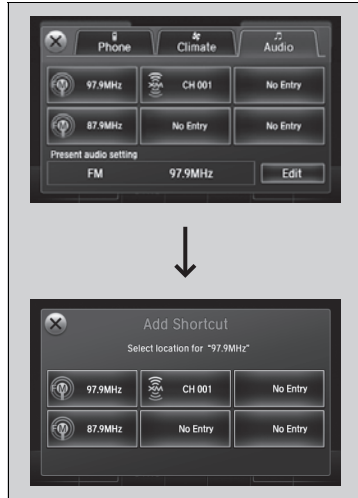

To preset a station or song:

1. Tune to a radio station.
▶ [Playing AM/FM Radio P. 217](#)
▶ [Playing XM® Radio P. 221](#)
2. Select **Shortcuts**.
3. Select **Audio**.
4. Select **Edit** or **No Entry**.
▶ If you select **No Entry**, go to step 6.
5. Select **Add**.
6. Select the preset icon you want to store the station or song to.

To play a preset station or song:

1. Select **Shortcuts**.
2. Select **Audio**.
3. Select a preset icon.

To delete a preset station or song:

1. Select **Shortcuts**.
2. Select **Audio**.
3. Select **Edit**.
4. Select **Delete**.
5. Select the preset icon with the radio station or a song you want to delete.

▶▶ Audio

You can also preset a station or song by pressing and holding the preset icon you want to store that station or song after step 3.

■ Adjusting the Sound



1. Select **More**, then **Sound Settings**.
2. Use **+**, **-** or other icons to adjust the setting.

■ Changing the Screen Settings



1. Select **More**, then **Screen Settings**.
2. Use **+**, **-** or other icons to adjust the setting.

▶▶ Adjusting the Sound

Select **Off**, **Low**, **Mid** or **High** for the SVC setting.

▶▶ [Adjusting the Sound P. 215](#)

Instead of using **+**, **-** or icons, you can also touch the point where your desired setting is.

▶▶ Changing the Screen Settings

The followings are adjustable screen settings:

- **Sync Display Brightness**
Selects whether the screen brightness synchronizes with the instruments panel brightness.
- **Brightness**
- **Contrast**
- **Black Level**
- **Display**
Changes between the daytime or nighttime modes.
- **Beep**
Mutes a beep that sounds every time you touch the screen.
- **Keyboard**
Changes the on-screen keyboard from the alphabetical order to the qwerty type.
- **Vibration**
Turns on and off the vibration when you touch the screen.
- **Fade Timer**
Sets the screen black out timing.

Instead of using **+**, **-** or icons, you can also touch the point where your desired setting is.

Audio/Information Screen

Displays the audio status and wallpaper. From this screen, you can go to various setup options.

Switching the Display

Press the **PHONE**, **INFO** and **AUDIO** buttons to go to the corresponding display.

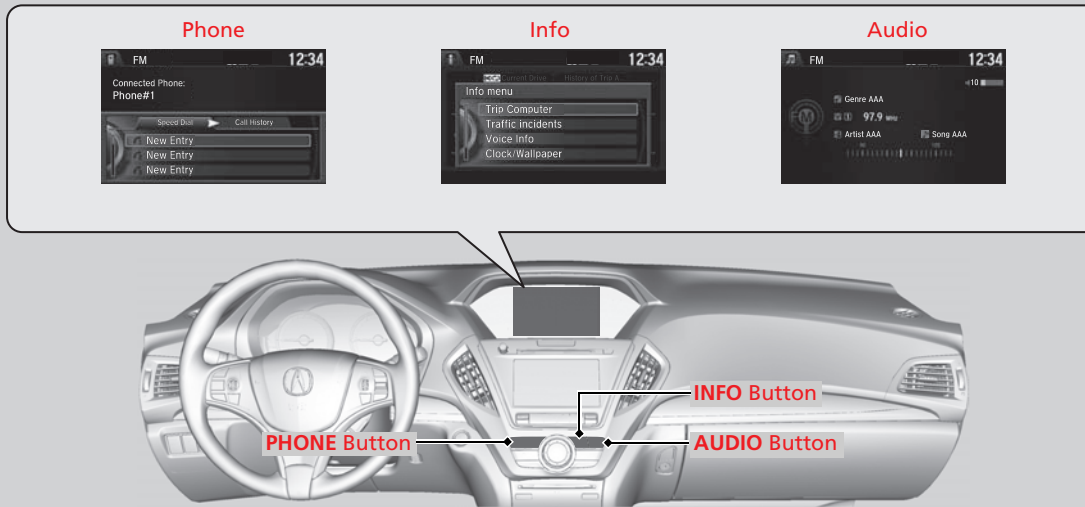

■ Audio

Shows the current audio information.

■ Phone

Shows the HFL information.  **Bluetooth® HandsFreeLink®** P. 268

■ Info

Shows the **Trip Computer** or **Clock/Wallpaper** and other information. Rotate  to select an item, then press .

■ Trip computer (Current Drive)





Shows the range, and instant and average fuel economy of the current trip, as well as the average fuel economy from your last trip.

■ Trip computer (History of Trip A)

Shows the range, average fuel economy and distances traveled for the current trip, as well as the average fuel economy and distances traveled during the last three driving cycles.

Each time you reset the trip meter A, the information on the display updates. The history of the previous three driving cycles is kept.

■ Deleting the history manually

1. Move  on the **History of Trip A** screen to select **Delete History**, then press .
2. You will receive a confirmation message on the screen. Rotate  to select **Yes**, then press .

■ Clock/Wallpaper

Shows a clock screen or an image you import.

Wallpaper Setup

You can change, store, and delete the wallpaper on the audio/information screen.

Import wallpaper

You can import up to three images, one at a time, for wallpaper from a USB flash drive.



1. Connect the USB flash drive to the USB port.

▶ [USB Port P. 199](#)

2. Press the **SETTINGS** button.
3. Rotate to select **System Settings**, then press .
 - ▶ Repeat the procedure to select **Clock, Clock/Wallpaper Type**.

4. Move to select **Wallpaper**.

▶ The screen will change to the wallpaper list.

5. Move to select **Add New**, then press .

6. Rotate to select a desired picture.

▶ The preview is displayed on the left side on the screen.

7. Press , then move to select

Start Import.







▶ The confirmation message will appear. Then the display will return to the wallpaper list.











Wallpaper Setup

- When importing wallpaper files, the image must be in the USB flash drive's root directory. Images in a folder cannot be imported.
- The file name must be fewer than 64 characters.
- The file format of the image that can be imported is BMP (bmp) or JPEG (jpg).
- The individual file size limit is 6 MB.
- The maximum image size is 1,680 x 936 pixels. If the image size is less than 420 x 234 pixels, the image is displayed in the middle of the screen with the extra area appearing in black.
- Up to 255 files can be selected.
- If the USB flash drive does not have any pictures, the **No files detected** message appears.



■ Select wallpaper

1. Press the **SETTINGS** button.
2. Rotate  to select **System Settings**, then press .
 - ▶ Repeat the procedure to select **Clock/Wallpaper Type**.
3. Move  to select **Wallpaper**.
 - ▶ The screen changes to the wallpaper list.
4. Rotate  to select a desired wallpaper.
 - ▶ The preview is displayed on the left side on the screen.
5. Press .
 - ▶ The pop-up menu appears on the screen.
6. Rotate  to select **Set**, then press .
 - ▶ The display will return to the wallpaper list.

■ Delete wallpaper

1. Press the **SETTINGS** button.
2. Rotate  to select **System Settings**, then press .
 - ▶ Repeat the procedure to select **Clock/Wallpaper Type**.
3. Move  to select **Wallpaper**.
 - ▶ The screen changes to the wallpaper list.
4. Rotate  to select a wallpaper that you want to delete, then press .
 - ▶ The preview is displayed on the left side on the screen.
5. Press .
 - ▶ The pop-up menu appears on the screen.
6. Rotate  to select **Delete**, then press .
 - ▶ The confirmation message will appear.
7. Rotate  to select **Yes**, then press to delete completely.
 - ▶ The display will return to the wallpaper list.

▶▶ Wallpaper Setup

From the pop-up menu, rotate  to select **Preview** and press  to see a preview at full-size screen.

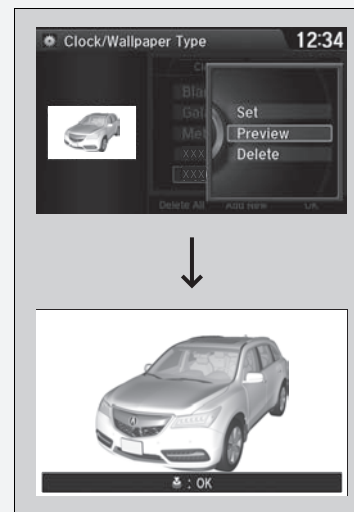



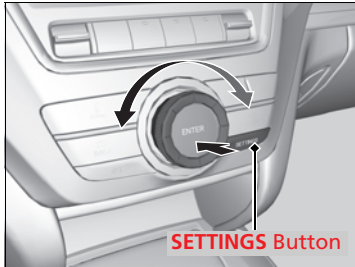

To go back to the previous screen, press  to select **OK**, or press the **BACK** button.

When the file size is large, it takes a while to be previewed.

Adjusting the Sound



1. Press the **SETTINGS** button.
2. Rotate  to select **Audio Settings**, then press .
3. Rotate  to select **Sound**, then press .

Rotate  to scroll through the following choices:

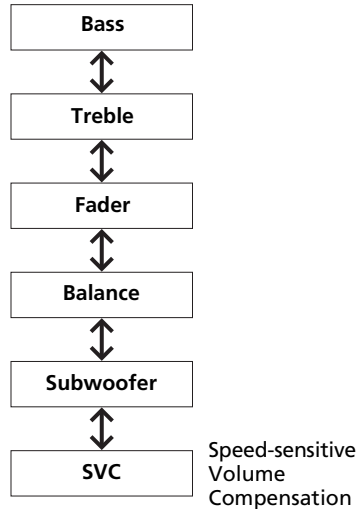

Adjusting the Sound

The SVC has four modes: **Off**, **Low**, **Mid**, and **High**. SVC adjusts the volume level based on the vehicle speed. As you go faster, audio volume increases. As you slow down, audio volume decreases.



Display Setup

You can change the brightness or color theme of the audio/information screen.

■ Changing the Screen Brightness



1. Press the **SETTINGS** button.
2. Rotate to select **System Settings**, then press .
3. Rotate to select **Brightness**, then press .
4. Rotate to adjust the setting, then press .

▣ Changing the Screen Brightness

You can change the **Contrast** and **Black Level** settings in the same manner.

■ Changing the Screen's Color Theme



1. Press the **SETTINGS** button.
2. Rotate to select **System Settings**, then press .
3. Rotate to select **Background Color**, then press .
4. Rotate to select the setting you want, then press .

Playing AM/FM Radio

Audio/Information Screen — Points to the top display area showing 'FM', 'Genre AAA', '97.9 MHz', 'Artist AAA', and 'Song AAA'.

On Demand Multi-Use Display™ — Points to the central display area.

Audio Source — Select to change a band or change an audio source.

(Power) Button — Press to turn the audio system on and off.

VOL (Volume) Knob (Pushed out) — Turn to adjust the volume.

Presets — Select to store a station.
To listen to a stored channel, select 1-6 (AM) or 1-12 (FM).

Tune Up/Down Icons — Select ◀ or ▶ to tune the radio frequency.

More — Select to display the menu items.

Skip/Seek Icons — Select ◀◀ or ▶▶ to search up and down the selected band for a station with a strong signal.

MENU Button — Press to display the menu items.





Interface Dial/ENTER Button — Press and turn to select preset radio stations. Move up, down, right and left to select secondary menu.

BACK Button — Press to go back to the previous display.



■ Preset Memory

To store a station:

Interface Dial

1. Tune to the selected station.
2. Press the **MENU** button.
3. Rotate  to select **Save Preset**, then press .
4. Rotate  to select the preset number you want to store that station, then press .

You can also store that station by the following procedure.

1. Tune to the selected station.
2. Rotate  to select the preset number you want to store the station.
3. Press and hold  for a few seconds.

On Demand Multi-Use Display™

1. Tune to the selected station.
2. Select **More**.
3. Select **Save Preset**.
4. Select the preset number you want to store that station.

You can also store that station by the following procedure.

1. Tune to the selected station.
2. Change the display to the preset screen.
3. Select and hold the preset number you want to store that station.

▶▶ Playing AM/FM Radio

The **ST** indicator appears on the display indicating stereo FM broadcasts.

Stereo reproduction in AM is not available.

Switching the Audio Mode

Press the **SOURCE** button on the steering wheel.

[▶ Audio Remote Controls P. 202](#)





You can also switch the mode by pressing the **MENU** button and selecting **Change Source** on the **Audio menu** screen.

You can store 6 AM stations and 12 FM stations into the preset memory.

Radio Data System (RDS)





Provides text data information related to your selected RDS-capable FM station.

■ To find an RDS station from Station List

1. Press the **MENU** button while listening to an FM station.
2. Rotate  to select **Station List**, then press .
3. Rotate  to select the station, then press .



■ Manual update

Updates your available station list at any time.

1. Press the **MENU** button while listening to an FM station.
2. Rotate  to select **Station List**, then press .
3. Rotate  to select **Refresh**, then press .

■ Radio text

Display the radio text information of the selected RDS station.

1. Press the **MENU** button.
2. Rotate  to select **Radio Text**, then press .

■ Scan

Samples each of the strongest stations on the selected band for 10 seconds.

Interface Dial

1. Press the **MENU** button.
 2. Rotate  to select **Scan**, then press .
- To turn off scan, press  to select **Cancel Scan**, or press the **BACK** button.

On Demand Multi-Use Display™

1. Select **More**.
2. Select **Scan**.

To turn off scan, select **Cancel Scan**

Playing XM® Radio

Audio/Information Screen

On Demand Multi-Use Display™

Audio Source

Select to change an audio source.

(Power) Button

Press to turn the audio system on and off.

VOL (Volume) Knob (Pushed out)

Turn to adjust the volume.

Presets

Select to store a station.



To listen to a stored channel, select 1-12.

BACK Button

Press to go back to the previous display.

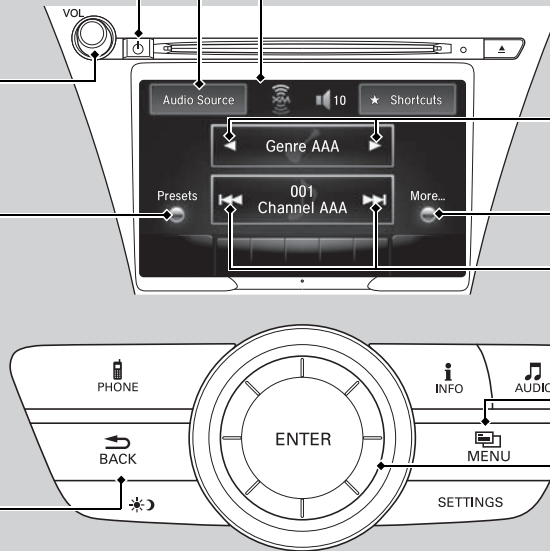
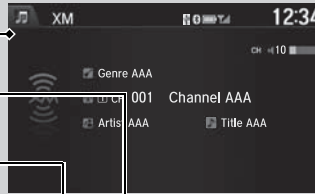

Category Up/Down Icons

Select ◀ or ▶ to display and select an XM® Radio category.

More

Select to display the menu items.

Skip/Seek Icons

Select ◀◀ or ▶▶ to the previous or next channel.

In channel mode, select and hold to change the channel rapidly.

MENU Button

Press to display the menu items.

Interface Dial/ENTER Button





Press and turn to select preset radio stations.

Move up, down, right and left to select secondary menu.

■ To Play the XM® Radio

1. Select the XM® mode.
 - ▶ [Audio Remote Controls](#) P. 202
 - ▶ [On Demand Multi-Use Display™](#) P. 204

Interface Dial

2. Press the **MENU** button.
3. Rotate  to select **Channel List**, then press .
4. Rotate  to select a channel from a list, then press .





On Demand Multi-Use Display™

2. Select a channel using the , , ,  icons on the tune mode screen or the preset numbers (**1-12**) on the preset mode screen.

To change the tune mode:

1. Select the XM® mode.

Interface Dial

2. Press the **MENU** button.
3. Rotate  to select **XM Tune Mode**, then press .
4. Rotate  to select **Channel Mode** or **Category Mode**, then press .

On Demand Multi-Use Display™

2. Select **More**.
3. Select **XM Tune Mode**.
4. Select **Channel Mode** or **Category Mode**.

▶▶ Playing XM® Radio

In the channel mode, all available channels are selectable. In the category mode, you can select a channel within a category (Jazz, Rock, Classical, etc.).





There may be instances when XM® Radio does not broadcast all the data fields (artist name, title). This does not indicate a problem with your audio system.

XM® Radio stations load in ascending order, which can take about a minute. Once they have loaded you will be able to scroll up or down to make your selections.



Preset Memory

To store a station:

Interface Dial

1. Tune to the selected station.
2. Press the **MENU** button.
3. Rotate  to select **Save Preset**, then press .
4. Rotate  to select the preset number you want to store that station, then press .

You can also store that station by the following procedure.

1. Tune to the selected station.
2. Rotate  to select the preset number you want to store the station.
3. Press and hold  for a few seconds.

On Demand Multi-Use Display™

1. Tune to the selected station.
2. Select **More**.
3. Select **Save Preset**.
4. Select the preset number you want to store that station.

You can also store that station by the following procedure.

1. Tune to the selected station.
2. Change the display to the preset screen.
3. Select and hold the preset number you want to store that station.

▶▶ Playing XM® Radio

You can store 12 XM® stations into the preset memory.

Playing a CD

Your audio system supports audio CDs, CD-Rs and CD-RWs in either MP3, WMA, or AAC*1 format. With the CD loaded, select the CD mode.

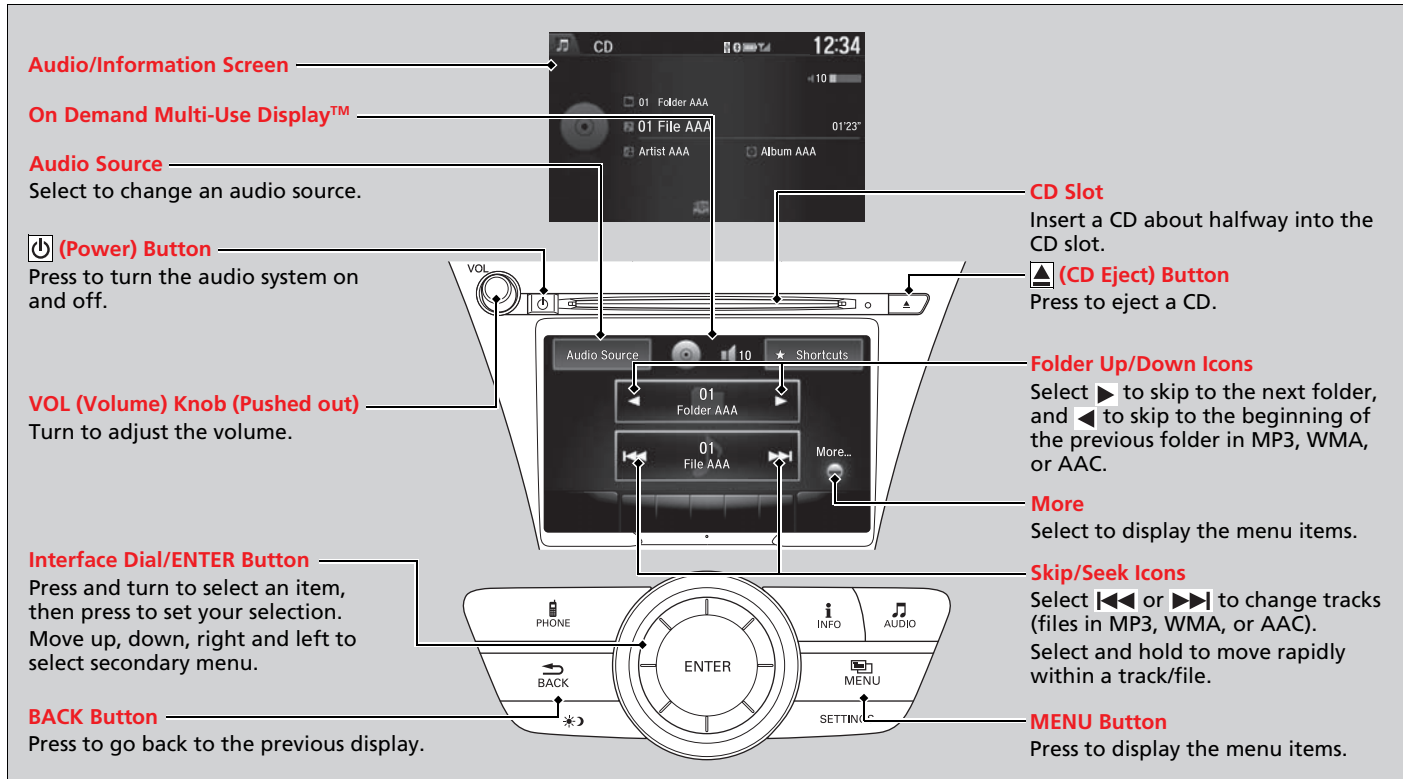

*1: Only AAC format files recorded with iTunes® are playable on this unit.

How to Select a File from the Music Search List (MP3/WMA/AAC)

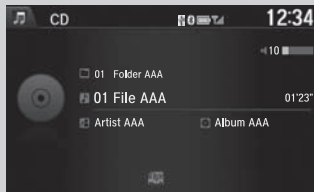

1. Press the **MENU** button.
2. Rotate to select **Music Search**, then press .

3. Rotate , move or , then press to select a file from the **Music Search** list.

You can also select a file by the following procedure.

1. Rotate or press to display the song list.
2. Rotate , move or , then press to select a file from the list.

▶▶ Playing a CD

NOTICE

Do not use CDs with adhesive labels. The label can cause the CD to jam in the unit.

WMA and ACC files protected by digital rights management (DRM) cannot be played.

The audio system displays **Unplayable File**, then skips to the next file.

Text data appears on the display under the following circumstances:

- When you select a new folder, file, or track.
- When you change the audio mode to CD.
- When you insert a CD.

If you eject the CD but do not remove it from the slot, the system reloads the CD automatically after several seconds.

Continued

■ How to Select a Play Mode

You can select scan, repeat, and random modes when playing a track or file.





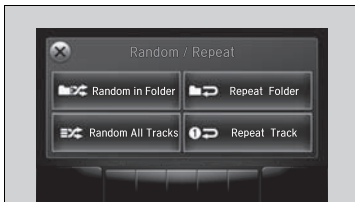

Random/Repeat is selected.



Random/Repeat is selected.

Interface Dial



1. Press the **MENU** button.
2. Rotate  to select **Scan** or **Random/Repeat**, then press .
3. Rotate  to select a mode, then press .

On Demand Multi-Use Display™

1. Select **More**.
2. Select **Scan** or **Random/Repeat**.
3. Select a mode.

■ To turn off a play mode

Interface Dial

1. Press the **MENU** button.
2. Rotate  to select the mode you want to turn off, then press .

▶▶ How to Select a Play Mode

Play Mode Menu Items

Scan

Scan Folders (MP3/WMA/AAC): Provides 10-second sampling of the first file in each of the main folders.

Scan Tracks: Provides 10-second sampling of all tracks on the CD (all files in the current folder in MP3, WMA, or AAC).

Random/Repeat

Repeat Folder (MP3/WMA/AAC): Repeats all files in the current folder.

Repeat Track: Repeats the current track/file.

Random in Folder (MP3/WMA/AAC): Plays all files in the current folder in random order.

Random All Tracks: Plays all tracks/files in random order.

On Demand Multi-Use Display™

1. Select **More**.
2. Select the mode you want to turn off.

Playing an iPod®

Connect the iPod® using your dock connector to the USB port, then select the iPod mode.

[USB Port P. 199](#)

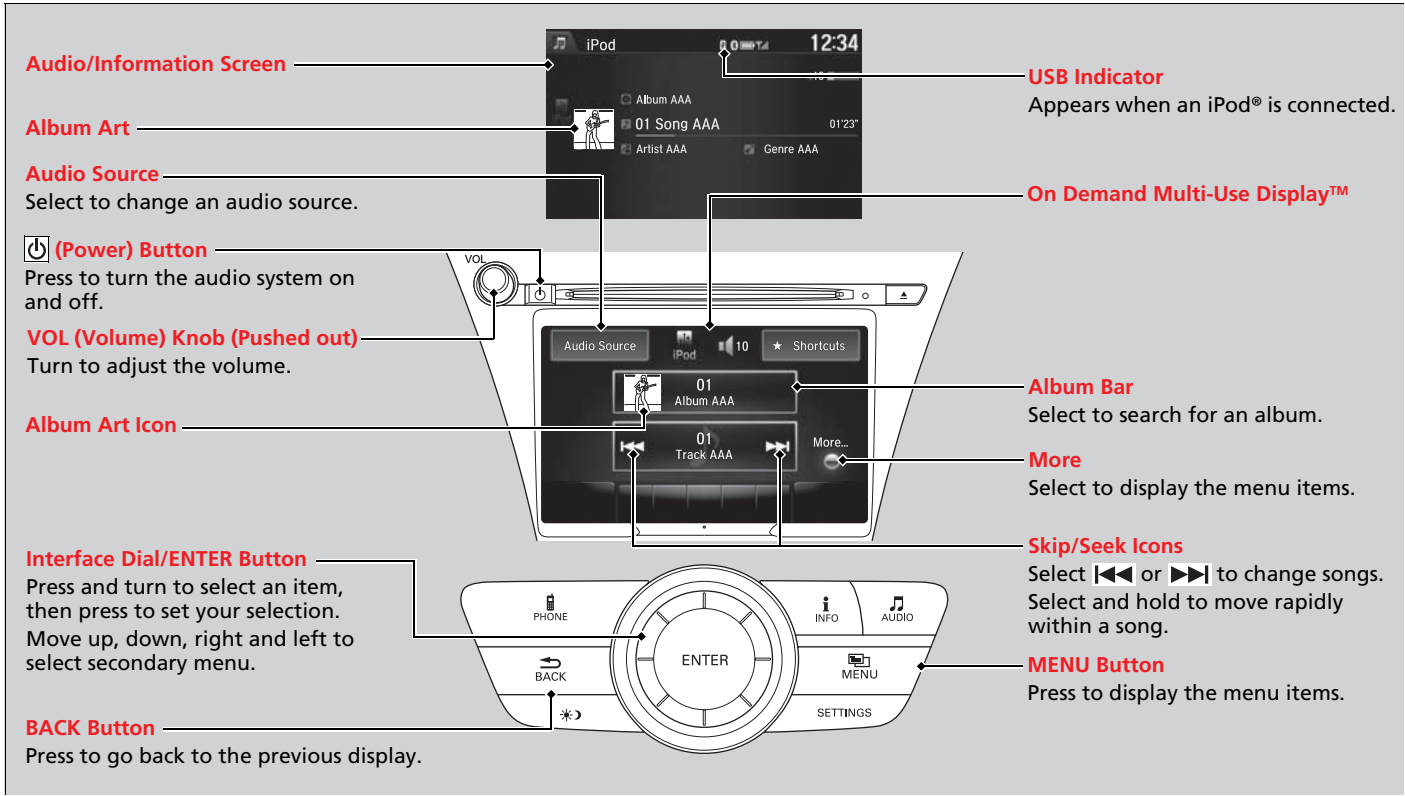

■ How to Select an Album

You can select albums in the category you selected by the **Music Search** list.

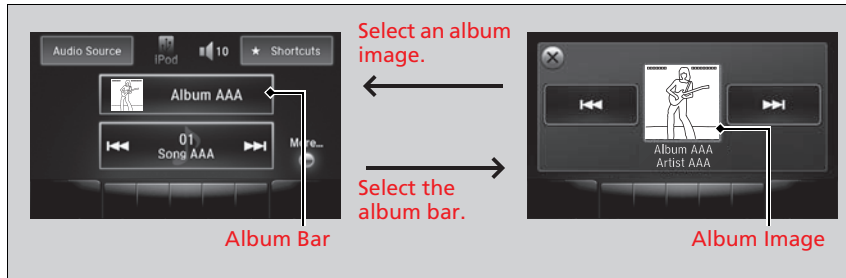

1. Select the album bar.
 - ▶ The image of the current album is displayed.
2. Select **⏮** or **⏭** icon to search for an album.
 - ▶ When the album image you are looking for appears, select it to play.

▶▶ How to Select an Album

This function may not be available depending on models or versions.

Select **[X]** to go back to the previous screen.

How to Select a Song from the Music Search List

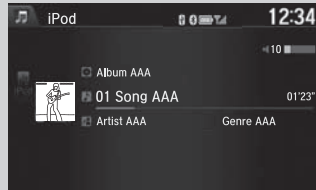

1. Press the **MENU** button.
2. Rotate to select **Music Search**, then press .

3. Rotate , move or , then press to select a song from the **Music Search** list.

You can also select a song by the following procedure.

1. Rotate or press to display the song list.
2. Rotate , move or , then press to select a song from the list.

How to Select a Song from the Music Search List

Available operating functions vary on models or versions. Some functions may not be available on the vehicle's audio system.

If there is a problem, you may see an error message on the audio/information screen.



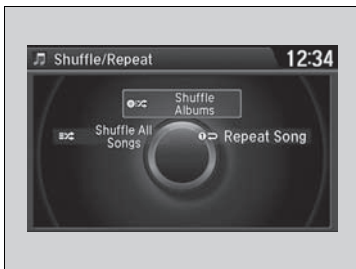

[▶ iPod®/USB Flash Drive P. 240](#)

■ How to Select a Play Mode

You can select repeat and shuffle modes when playing a file.



Interface Dial

1. Press the **MENU** button.
2. Rotate  to select **Shuffle/Repeat**, then press .
3. Rotate  to select a mode, then press .

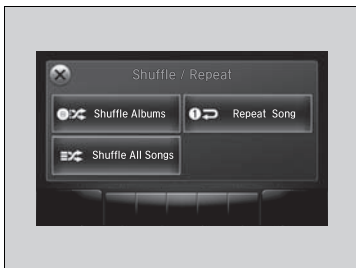



On Demand Multi-Use Display™

1. Select **More**.
2. Select **Shuffle/Repeat**.
3. Select a mode.

■ To turn off a play mode

Interface Dial

1. Press the **MENU** button.
2. Rotate  to select the mode you want to turn off, then press .

▶▶ How to Select a Play Mode

Play Mode Menu Items

Repeat Song: Repeats the current track.

Shuffle Albums: Plays all available albums in a selected list (playlists, artists, albums, songs, genres, or composers) in random order.

Shuffle All Songs: Plays all available files in a selected list (playlists, artists, albums, songs, genres, or composers) in random order.

Compatible phones only

Playing Internet Radio

Connect a compatible phone through *Bluetooth®*.

iPhone®

You can also connect the phone using your dock connector to the USB port. Select **Audio Source** to select Pandora or Aha mode.

▶▶ Playing Internet Radio

U.S. models

Pandora®, the Pandora logo, and the Pandora trade dress are trademarks or registered trademarks of Pandora Media, Inc., used with permission. Pandora is currently available exclusively in the United States.

Audio/Information Screen — Points to the top display area showing Pandora station information.

Album Art — Points to the album art icon on the screen.

Audio Source — Select Pandora®* or Aha™.

(Power) Button — Press to turn the audio system on and off.

VOL (Volume) Knob (Pushed out) — Turn to adjust the volume.

Play/Pause Icon — Select to resume or play a song.

BACK Button — Press to go back to the previous display.

Interface Dial/ENTER Button — Press and turn to select an item, then press to set your selection. Move up, down, right and left to select secondary menu.

Bluetooth® Indicator — Appears when your phone is connected to HFL.

USB Indicator — Appears when a phone is connected.

Rating Icon —

On Demand Multi-Use Display™ —

Station Up/Down Icons — Select to change a station.

Skip Icon — Select to skip a song.

More — Select to display the menu items.

Like/Dislike Icons — Select to evaluate a song.

MENU Button — Press to display the menu items.

* Not available on all models

U.S. models



Pandora® Menu

You can operate some of the Pandora® menu items from your vehicle's audio system. The available items are:

- Skip Forward
- Play/Pause
- Station List
- Like
- Dislike
- Bookmark Track
- Bookmark Artist
- Change Source

Operating a menu item

The menu items are shown in the lower half of the audio/information screen.

Rotate  to select an item and press .

To select **Change Source**, press the **MENU** button, then press .

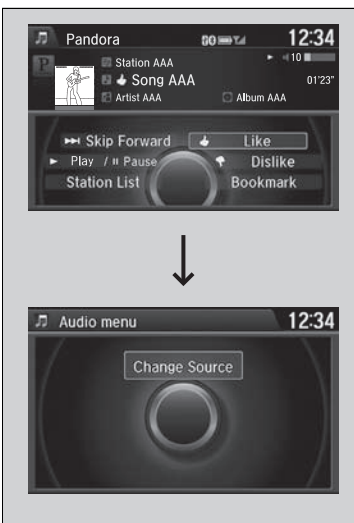

▶▶ Playing Internet Radio

To find out if your phone is compatible with this feature, visit www.acura.com/handsfreelink, or call 1-888-528-7876.

U.S. models

Pandora® is a personalized Internet radio service that selects music based on an artist, song, or genre a user enters, and streams what is likely to be of interest.

To use this service in your vehicle, the Pandora® app must first be installed on your phone. Visit www.pandora.com for more information.

If you cannot operate Pandora® through the audio system, it may be streaming through *Bluetooth®* Audio. Make sure Pandora® mode on your audio system is selected.

▶▶ Pandora® Menu

Available operating functions vary on software versions. Some functions may not be available on the vehicle's audio system.

If there is a problem, you may see an error message on the audio/information screen.

 **Pandora® P. 241**

There are restrictions on the number of songs you can skip or dislike in a given hour.



Aha™ Radio Menu

You can operate some of the Aha™ menu items from your vehicle's audio system. The available items are:

- Like
- Dislike
- Play/Pause
- 15sec rewind
- 30sec skip
- Tracks
- Reply
- Change Source
- Stations

Operating a menu item

The menu items are shown in the lower half of the audio/information screen.

Rotate  to select an item and press .

To select **Change Source** or **Stations**, press the **MENU** button, then press .

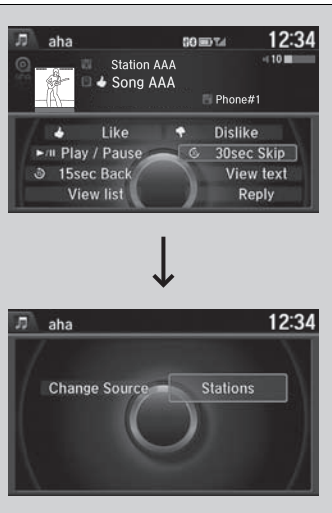

Aha™ Radio Menu

Aha™ by Harman is a cloud-based service that organizes your favorite web content into live radio stations. You can access podcasts, internet radio, location-based services, and audio updates from social media sites.

Available operating functions vary on software versions. Some functions may not be available on the vehicle's audio system.

If there is a problem, you may see an error message on the audio/information screen.

 [Aha™ Radio P. 243](#)

The menu items vary depending on the station you selected.

To use this service in your vehicle, the AcuraLink app must be installed on your phone. Visit owners.acura.com/apps for more information.

You must have a previously set up Aha account prior to using the service in your vehicle. Visit www.aharadio.com for more information.

Playing a USB Flash Drive

Your audio system reads and plays sound files on a USB flash drive in either MP3, WMA, or AAC**1 format.

Connect your USB flash drive to the USB port, then select the USB mode.

➤ **USB Port** P. 199

Audio/Information Screen — Points to the top display showing 'USB' and file details.

On Demand Multi-Use Display™ — Points to the central display area.

Audio Source — Select to change an audio source.

(Power) Button — Press to turn the audio system on and off.

VOL (Volume) Knob (Pushed out) — Turn to adjust the volume.

Folder Up/Down Icons — Select ▶ to skip to the next folder, and ◀ to skip to the beginning of the previous folder.

More — Select to display the menu items.

Skip/Seek Icons — Select ◀◀ or ▶▶ to change files. Select and hold to move rapidly within a file.

MENU Button — Press to display the menu items.

BACK Button — Press to go back to the previous display.

Interface Dial/ENTER Button — Press and turn to select an item, then press to set your selection. Move up, down, right and left to select secondary menu.

USB Indicator — Appears when a USB flash drive is connected.

*1: Only AAC format files recorded with iTunes® are playable on this unit.

How to Select a File from the Music Search List

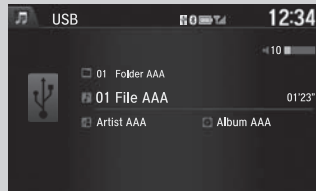

Folder Selection



File Selection



1. Press the **MENU** button.
2. Rotate to select **Music Search**, then press .

3. Rotate , move or , then press to select a file from the **Music Search** list.

You can also select a file by the following procedure.

1. Rotate or press to display the song list.
2. Rotate , move or , then press to select a file from the list.

▶▶▶ Playing a USB Flash Drive

Use the recommended USB flash drives.

▶ [General Information on the Audio System](#)
P. 244

Files in WMA/ACC format protected by digital rights management (DRM) cannot be played.

The audio system displays **Unplayable File**, and then skips to the next file.

If there is a problem, you may see an error message on the audio/information screen.

▶ [iPod®/USB Flash Drive](#) P. 240

■ How to Select a Play Mode

You can select scan, repeat, and random modes when playing a file.







Random/Repeat is selected.



Random/Repeat is selected.

Interface Dial



1. Press the **MENU** button.
2. Rotate  to select **Scan** or **Random/Repeat**, then press .
3. Rotate  to select a mode, then press .

On Demand Multi-Use Display™

1. Select **More**.
2. Select **Random/Repeat**.
3. Select a mode.

■ To turn off a play mode

Interface Dial

1. Press the **MENU** button.
2. Rotate  to select the mode you want to turn off, then press .

▶▶ How to Select a Play Mode

Play Mode Menu Items

Scan

Scan Folders: Provides 10-second sampling of the first file in each of the main folders.

Scan Tracks: Provides 10-second sampling of all files in the current folder.

Random/Repeat

Repeat Folder: Repeats all files in the current folder.

Repeat Track: Repeats the current file.

Random in Folder: Plays all files in the current folder in random order.

Random All Tracks: Plays all files in random order.

On Demand Multi-Use Display™

1. Select **More**.
2. Select the mode you want to turn off.

Playing *Bluetooth*® Audio

Your audio system allows you to listen to music from your *Bluetooth*®-compatible phone.

This function is available when the phone is paired and connected to the vehicle's *Bluetooth*® HandsFreeLink® (HFL) system.

▶ **Phone Setup** P. 274

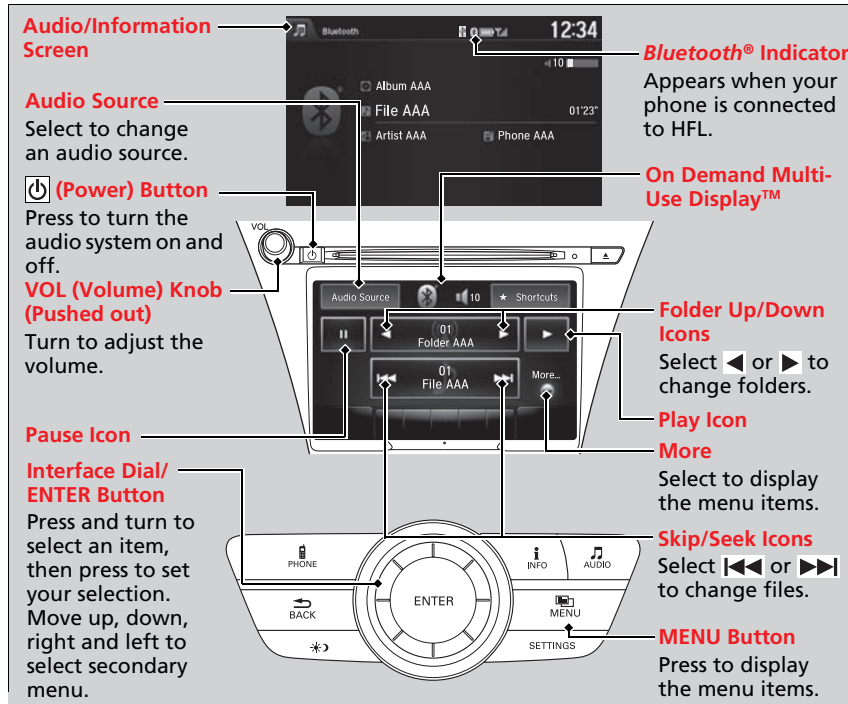

▶▶ Playing *Bluetooth*® Audio

Not all *Bluetooth*-enabled phones with streaming audio capabilities are compatible with the system.

For a list of compatible phones:

- **U.S.:** Visit www.acura.com/handsfreelink, or call 1-888-528-7876.
- **Canada:** Visit www.handsfreelink.ca, or call 1-888-528-7876.

In some states, it may be illegal to perform some data device functions while driving.

If more than one phone is paired to the HFL system, there will be a delay before the system begins to play.

■ To Play *Bluetooth*® Audio Files





1. Make sure that your phone is paired and connected to HFL.
2. Select the *Bluetooth*® Audio mode.

If the phone is not recognized, another HFL- compatible phone, which is not compatible for *Bluetooth*® Audio, may already be connected.

■ To pause or resume a file

Interface Dial

1. Press the **MENU** button.
2. Rotate  to select **Play** or **Pause**, then press .

On Demand Multi-Use Display™

Select the play icon or pause icon.

▶▶ To Play *Bluetooth*® Audio Files



To play the audio files, you may need to operate your phone. If so, follow the phone maker's operating instructions.

The pause function may not be available on some phones.

Switching to another mode pauses the music playing from your phone. This function may not be available on some phones.

CD Player

If a disc error occurs, you may see the following error messages.

Error Message	Cause	Solution
Unplayable File	Track/file format not supported	<ul style="list-style-type: none"> Current track/file will be skipped. The next supported track/file plays automatically.
Bad Disc Please Check Owner's Manual Push Eject	Mechanical error	<ul style="list-style-type: none"> Press the  (eject) button and remove the disc, and check that the error message is cleared. Check that the disc is not damaged or deformed, and insert the disc again. <ul style="list-style-type: none"> Protecting CDs P. 246
Mecha Error		<ul style="list-style-type: none"> If the error message reappears, press the  button, and pull out the disc. Insert a different disc. If the new disc plays, there is a problem with the first disc. If the error message repeats, or the disc cannot be removed, contact a dealer. Do not try to force the disc out of the player.
Bad Disc Please Check Owner's Manual	Servo error	<ul style="list-style-type: none"> Check that the disc is not damaged or deformed. <ul style="list-style-type: none"> Protecting CDs P. 246
Check Disc	Disc error	<ul style="list-style-type: none"> Check that the disc is not damaged or deformed. <ul style="list-style-type: none"> Protecting CDs P. 246
Heat Error	High temperature	<ul style="list-style-type: none"> Turn the audio system off and allow the player to cool down until the error message is cleared.

iPod®/USB Flash Drive

If an error occurs while playing an iPod® or USB flash drive, you may see the following error messages. If you cannot clear the error message, contact a dealer.

Error Message	Solution
USB Error	Appears when there is a problem with the audio system. Check if the device is compatible with the audio system.
Incompatible USB Device Please Check Owner's Manual.	Appears when an incompatible device is connected. Disconnect the device. Then turn the audio system off, and turn it on again. Do not reconnect the device that caused the error.
Unsupported Version	Appears when an unsupported iPod® is connected. If it appears when a supported iPod® is connected, update the iPod® software to the newer version.
Connect Retry	Appears when the system does not acknowledge the iPod®. Reconnect the iPod®.
Unplayable File	Appears when the files in the USB flash drive are DRM or an unsupported format. This error message appears for about three seconds, then plays the next song.
No Data	iPod® Appears when the iPod® is empty.
	USB flash drive Appears when the USB flash drive is empty or there are no MP3, WMA, or AAC files in the USB flash drive.
	iPod® and USB flash drive Check that compatible files are stored on the device.
Unsupported	Appears when an unsupported device is connected. If it appears when a supported device is connected, reconnect the device.

U.S. models

Pandora®

If an error occurs while playing Pandora®, you may see the following error messages. If you cannot clear the error message, contact a dealer.

Error Message	Solution
Incompatible USB Device Please Check Owner's Manual	Appears when an incompatible device is connected. Disconnect the device. Then turn the audio system off, and turn it again. Do not reconnect the device that caused the error.
<i>Audio/Information Screen</i> There is no station list in the device. Please add the station list to your device. <i>On Demand Multi-Use Display™</i> No stations have been created. Please create a station on the device.	Appears when there is no station list on the device. Use the device to create a station.
Music licenses force us to limit the number of tracks you may skip each hour.	Appears when you try to skip a song or select Dislike over the predetermined number of times in an hour.

Error Message	Solution
Unable to save rating. Unable to save bookmark. or Unable to skip.	Appears when the commanded operation is failed. Try again later.
No data	Appears when no data is available with Pandora® activated. Reboot the app and reconnect the device.
Unsupported	Appears when Pandora® version is not supported. Update Pandora® to the latest version.
PANDORA system maintenance.	Appears when the Pandora® server is in maintenance. Try again later.
Cannot connect to PANDORA. When stopped, make sure PANDORA is running on the phone. For iPhone, set connection priority to USB and reconnect.	Appears when Pandora® is unable to play music. Check your device.

Aha™ Radio

If an error occurs while playing Aha™ Radio, you may see the following error messages. If you cannot clear the error message, contact a dealer.

Error Message	Solution
Incompatible USB Device Please Check Owner's Manual	Appears when an incompatible device is connected. Disconnect the device. Then turn the audio system off, and turn it on again. Do not reconnect the device that caused the error.

XM® Radio Service

■ Subscribing to XM® Radio

1. You need your radio ID ready before registering for subscription. To see the ID in the display: Turn the interface dial until **0** appears.
2. Have your radio ID and credit card number ready, and either call or visit the XM® website to subscribe.

■ Receiving XM® Radio

Switch to the XM® mode by using the **SOURCE** button on the steering wheel, or through the On Demand Multi-Use Display™, and stay in this mode for about 30 minutes until the service is activated. Make sure your vehicle is in an open area with good reception.

■ XM® Radio Display Messages

Loading:

XM® is loading the audio or program information.

Ch off air:

The channel is not currently broadcasting.

Ch unauthorized:

XM® radio is receiving information update from the network.

No signal:

The signal is too weak in the current location.

Ch unavailable:

No such channel exists, the channel is not part of your subscription, or the artist or title information is unavailable.

Check antenna:

There is a problem with the XM® antenna. Contact a dealer.

☞ Subscribing to XM® Radio

Contact Information for XM® Radio:

- **US:** XM® Radio at www.siriusxm.com or 1-800-852-9696
- **Canada:** XM® Canada at www.xmradio.ca, or 1-877-209-0079

☞ Receiving XM® Radio

The XM® satellites are in orbit over the equator; therefore, objects south of the vehicle may cause satellite reception interruptions. Satellite signals are more likely to be blocked by tall buildings and mountains the farther north you travel from the equator.

You may experience reception problems under the following circumstances:

- In a location with an obstruction to the south of your vehicle.
- In tunnels
- On the lower level of a multi-tiered road
- Large items carried on the roof rack

Recommended CDs

- Use only high-quality CD-R or CD-RW discs labeled for audio use.
- Use only CD-R or CD-RW discs on which the recordings are closed.
- Play only standard round-shaped CDs.

The CD packages or jackets should have one of these marks.



CDs with MP3, WMA or AAC files

- Some software files may not allow for audio play or text data display.
- Some versions of MP3, WMA or AAC formats may be unsupported.

Recommended CDs

A Dual-disc cannot play on this audio unit. If recorded under certain conditions, a CD-R or CD-RW may not play either.

■ Protecting CDs

Follow these precautions when handling or storing CDs:

- Store a CD in its case when it is not being played.
- When wiping a CD, use a soft clean cloth from the center to the outside edge.
- Handle a CD by its edge. Never touch either surface.
- Never insert foreign objects into the CD player.
- Keep CDs out of direct sunlight and extreme heat.
- Do not place stabilizer rings or labels on the CD.
- Avoid fingerprints, liquids, and felt-tip pens on the CD.

▶▶ Protecting CDs

NOTICE

Do not insert a damaged CD. It may be stuck inside and damage the audio unit.

Examples:

- **Bubbled, wrinkled, labeled, and excessively thick CDs**



Bubbled/
Wrinkled

With Label/
Sticker

Using
Printer Label
Kit



Sealed

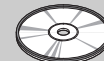

With Plastic Ring

- **Damaged CDs**

- **Poor quality CDs**



Chipped/
Cracked

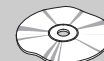

Warped



Burrs

- **Small CDs**



3-inch
(8-cm)
CD

Compatible iPod®, iPhone®, and USB Flash Drives

■ iPod® and iPhone® Model Compatibility

Model
iPod® (5th generation)
iPod classic® 80GB/160GB (launch in 2007)
iPod classic® 120GB (launch in 2008)
iPod classic® 160GB (launch in 2009)
iPod nano® (1st to 6th generation) launch in 2010
iPod touch® (1st to 4th generation) launch in 2010
iPhone® 3G/iPhone® 3GS/iPhone® 4/iPhone® 4S

■ USB Flash Drives

- Use a recommended USB flash drive of 256 MB or higher.
- Some digital audio players may not be compatible.
- Some USB flash drives (e.g., a device with security lockout) may not work.
- Some software files may not allow for audio play or text data display.
- Some versions of MP3, WMA, or AAC formats may be unsupported.

⌘ iPod® and iPhone® Model Compatibility

This system may not work with all software versions of these devices.

⌘ USB Flash Drives

Files on the USB flash drive are played in their stored order. This order may be different from the order displayed on your PC or device.



Models with navigation system

See the Navigation System Manual for the customized features except for the **Vehicle Settings**.

Models without navigation system







Use the audio/information screen to customize certain features.

■ How to customize

Select your desired setting item by pressing the **SETTINGS** button, then rotating  while the power mode is ON, and the vehicle is at a complete stop. Press .

Customized Features

When you customize setting, make sure that the vehicle is at a complete stop and shift to **P**.

To customize other features, rotate , move , , , or , and press .

[List of customizable options P. 253](#)

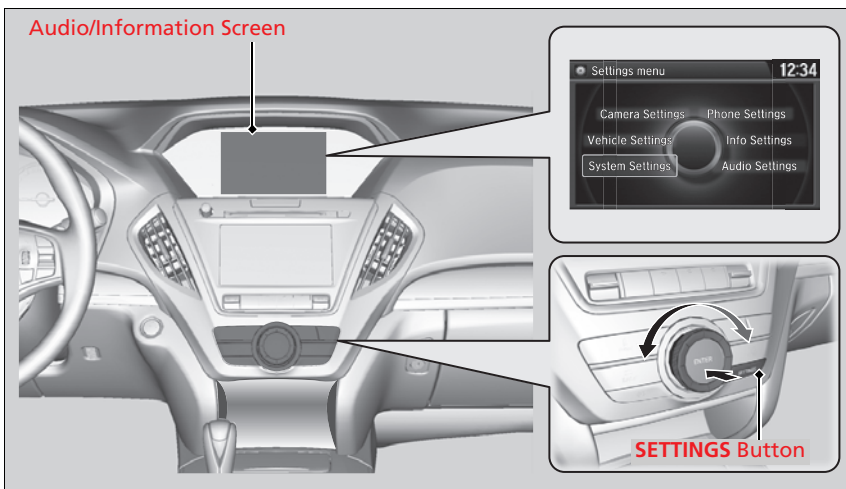

■ Customization flow

Press the **SETTINGS** button.

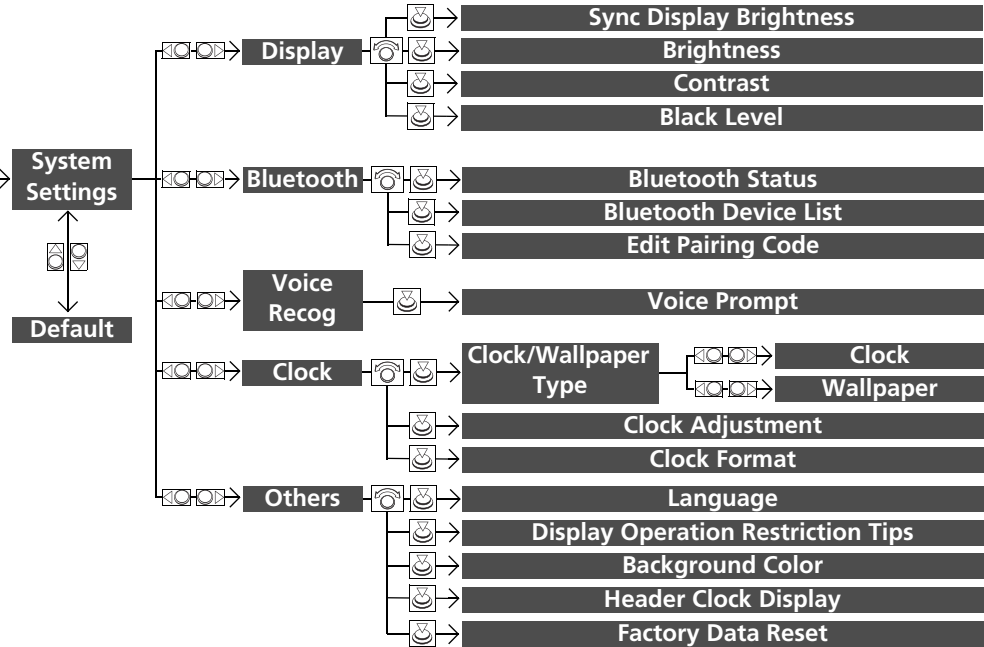
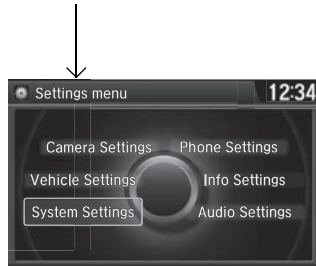

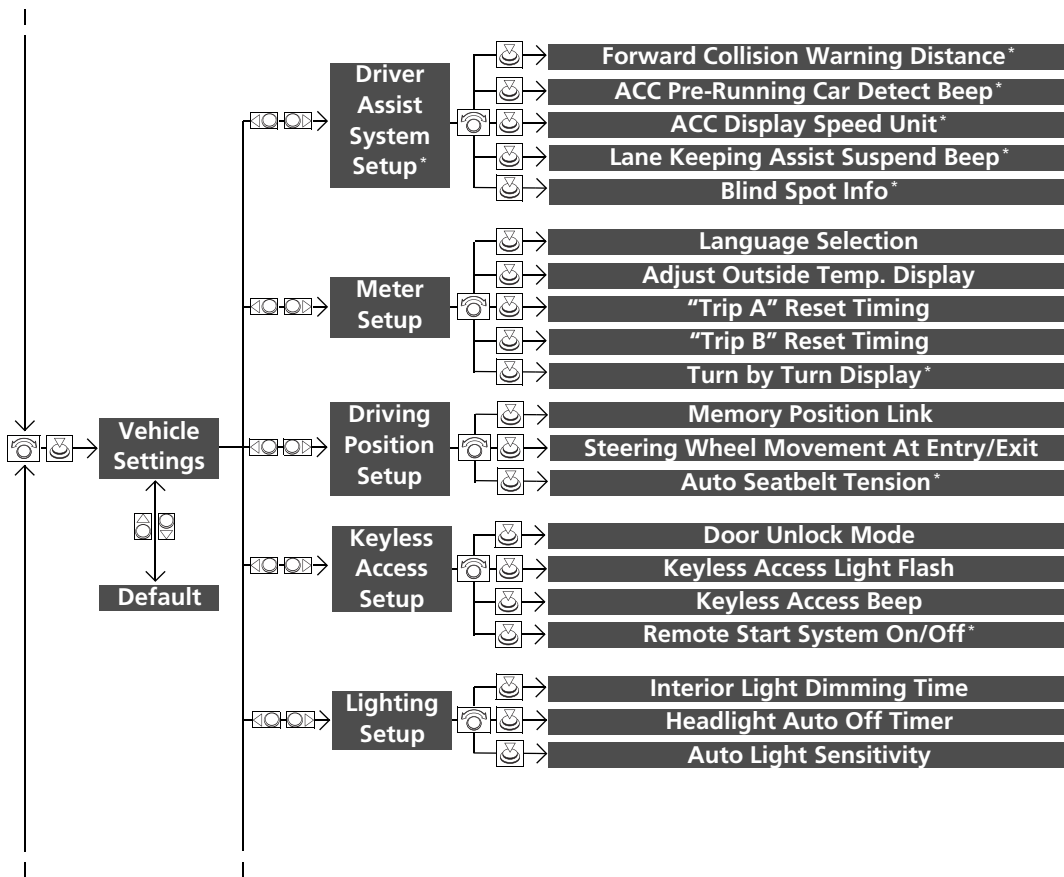

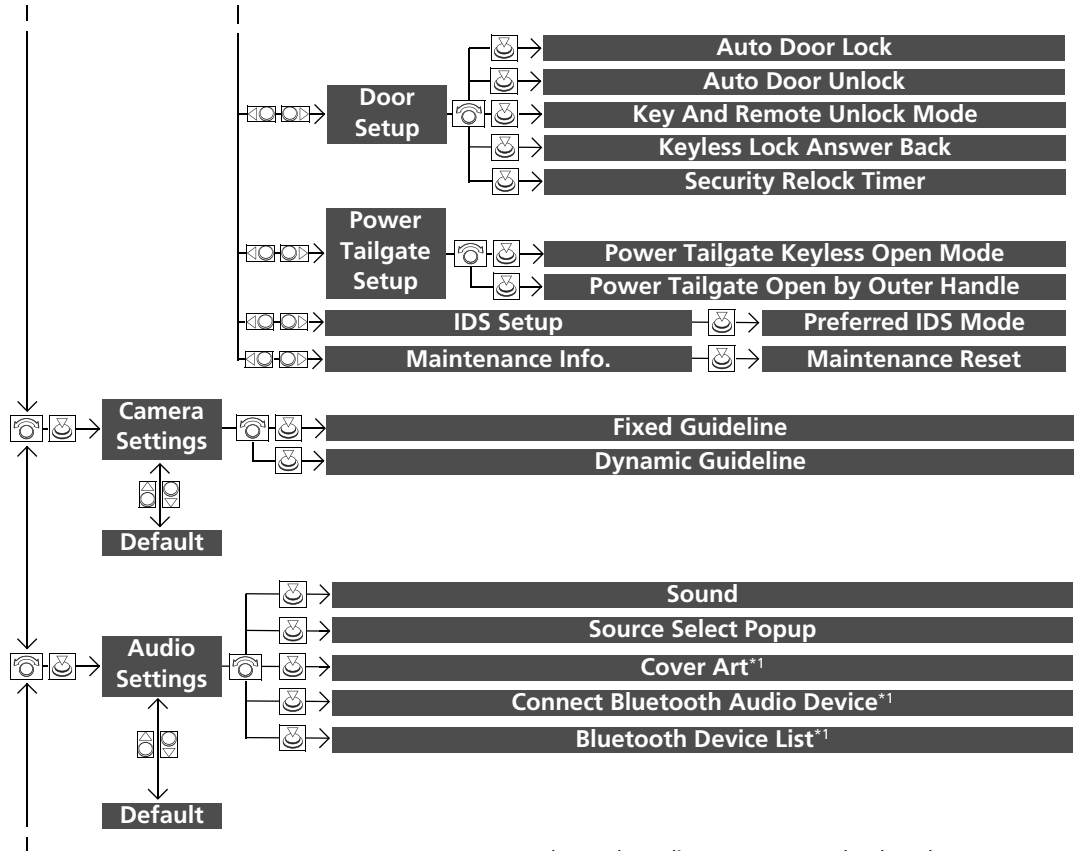

*1: May change depending on your currently selected source.

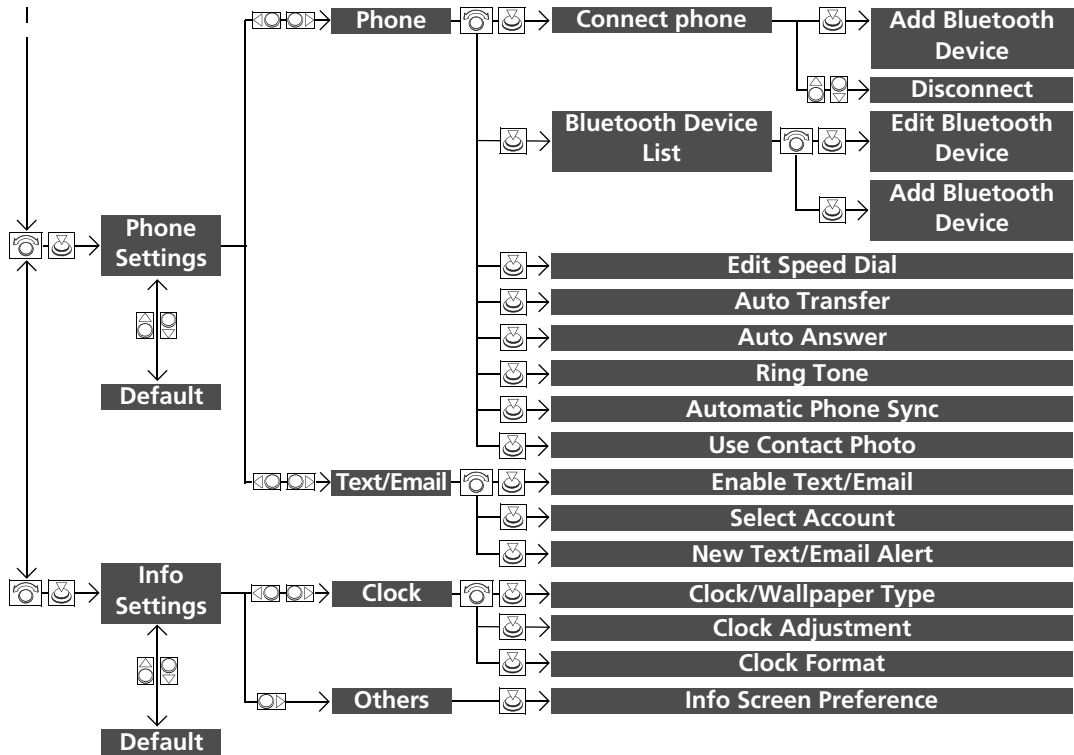

■ List of customizable options

Setup Group	Customizable Features	Description	Selectable Settings
System Settings	Display	Sync Display Brightness	On* ¹ /Off
		Brightness	—
		Contrast	—
		Black Level	—

*1:Default Setting

Setup Group	Customizable Features	Description	Selectable Settings		
System Settings	Bluetooth Status	Turns the <i>Bluetooth</i> ® on and off.	On*¹/Off		
	Bluetooth Device List	Pairs a new phone to HFL, edits and deletes a paired phone, and creates a security PIN. ➤ Phone Setup P. 274	—		
	Edit Pairing Code	Changes a pairing code. ➤ To change the pairing code setting P. 276	Random/Fixed*¹		
	Voice Recog	Voice Prompt	Turns the voice prompt on and off.	Beginner*¹/Expert	
	Clock	Clock	Changes the clock display type.	Analog/Digital*¹/ Small Digital/Off	
		Clock/ Wallpaper Type	Wallpaper	<ul style="list-style-type: none"> • Changes the wallpaper type. • Imports an image file for a new wallpaper. • Deletes an imported wallpaper (default wallpapers can be deleted). ➤ Wallpaper Setup P. 213	Blank/Galaxy*¹/ Metallic
		Clock Adjustment	Adjust Clock. ➤ Clock P. 114	—	
Clock Format		Selects the digital clock display from 12H to 24H.	12H*¹/24H		

*1: Default Setting

Setup Group	Customizable Features	Description	Selectable Settings
System Settings	Language	Changes the display language.	English^{*1}/Français/ Español
	Display Operation Restriction Tips	Alerts you when manual control of the system is disabled to prevent distraction while driving.	On^{*1}/Off
	Others		
	Background Color	Changes the background color of the audio/information screen and the On Demand Multi-Use Display™.	Blue^{*1}/Amber/Red/ Green
	Header Clock Display	Selects whether the clock display comes on.	On^{*1}/Off
	Factory Data Reset	Resets all the settings to their factory default. ▶ Defaulting All the Settings P. 265	—
Default		Cancels /Resets all customized items in the System Settings group as default.	Default/OK

*1:Default Setting

Setup Group	Customizable Features	Description	Selectable Settings	
Vehicle Settings	Driver Assist System Setup*	Forward Collision Warning Distance*	Changes at which distance FCW* or CMBS™* alerts, or turns FCW* on and off.	Long/Normal*¹/ Short/Off
		ACC Forward Vehicle Detect Beep*	Causes the system to beep when the system detects a vehicle, or when the vehicle goes out of the ACC with LSF range.	On/Off*¹
		ACC Display Speed Unit*	Changes the speed unit for ACC with LSF on the multi-information display (MID).	mph*¹/km/h (U.S.) mph/km/h*¹ (Canada)
		Lane Keeping Assist Suspend Beep*	Cause the system to beep when the LKAS is suspended.	On/Off*¹
		Blind Spot Info*	Changes the setting for the blind spot information.	Audible And Visual Alert*¹/Visual Alert/ Off

*1: Default Setting

Setup Group	Customizable Features	Description	Selectable Settings	
Vehicle Settings	Language Selection	Changes the displayed language on the multi-information display.	English^{*1}/Français/ Español	
	Adjust Outside Temp. Display	Adjust the temperature reading by a few degrees.	-5°F ~ ±0°F^{*1} ~ +5°F (U.S.) -3°C ~ ±0°C^{*1} ~ +3°C (Canada)	
	Meter Setup	"Trip A" Reset Timing	Changes the setting of how to reset trip meter A, average fuel economy A, average speed A, and elapsed time A.	With Refuel/IGN Off/ Manually Reset^{*1}
	"Trip B" Reset Timing	Changes the setting of how to reset trip meter B, average fuel economy B, average speed B, and elapsed time B.	With Refuel/IGN Off/ Manually Reset^{*1}	
	Turn by Turn Display[*]	Selects whether the turn-by-turn display comes on during the route guidance.	On^{*1}/Off	
	Door Unlock Mode	Changes which doors unlock when you grab the driver's door handle.	Driver Door Only^{*1}/ All Doors	
	Keyless Access Setup	Keyless Access Light Flash	Causes some exterior lights to flash when you unlock/lock the doors.	On^{*1}/Off
	Keyless Access Beep	Causes the beeper to sound when you unlock/lock the doors.	On^{*1}/Off	
	Remote Start System On/Off[*]	Turns the remote engine start feature on and off.	Enabled^{*1}/Disabled	

*1:Default Setting

* Not available on all models

Setup Group	Customizable Features	Description	Selectable Settings
Vehicle Settings	Lighting Setup	Interior Light Dimming Time	Changes the length of time the interior lights stay on after you close the doors. 60seconds/ 30seconds*¹/ 15seconds
		Headlight Auto Off Timer	Changes the length of time the exterior lights stay on after you close the driver's door. 60seconds/ 30seconds/ 15seconds*¹/ 0seconds
		Auto Light Sensitivity	Changes the timing for the headlights to come on. Max/High/Mid*¹/ Low/Min
	Driving Position Setup	Memory Position Link	Turns the driving position memory system using a remote transmitter on and off. On*¹/Off
		Steering Wheel Movement At Entry/Exit	Moves the steering wheel fully up when you get in/get out of the vehicle. On*¹/Off
		Auto Seatbelt Tension*	Turns the setting for the automatic seat belt e-pretensioner activation on and off. On*¹/Off

*1:Default Setting

Vehicle Settings **Door Setup**

Setup Group	Customizable Features	Description	Selectable Settings
	Auto Door Lock	Changes the setting for the automatic locking feature.	With Vehicle Speed*¹/Shift from P/Off
	Auto Door Unlock	Changes the setting for when the doors unlock automatically.	All Doors When Driver's Door Opens*¹/All Doors When Shifted to Park/All Doors When Ignition Switched Off/Off
	Key And Remote Unlock Mode	Sets up either the driver's door or all doors to unlock on the first push of the remote or built-in key.	Driver Door*¹/All Doors
	Keyless Lock Answer Back	LOCK/UNLOCK- The exterior lights flash. LOCK (2nd push)- The beeper sounds.	On*¹/Off
	Security Relock Timer	Changes the time it takes for the doors to relock and the security system to set after you unlock the vehicle without opening any door.	90seconds/ 60seconds/ 30seconds*¹

*1:Default Setting



Setup Group	Customizable Features	Description	Selectable Settings
Vehicle Settings	Power Tailgate Setup	Power Tailgate Keyless Open Mode	Changes the keyless setting for when the power tailgate opens. Anytime*¹/When Unlocked
		Power Tailgate Open by Outer Handle	Selects whether to enable the power tailgate open operation using the tailgate outer handle. Off (Manual Only)/On (Power/Manual)*¹
	IDS Setup	Preferred IDS Mode	Changes the IDS mode setting for when you set the power mode to ON. Last Used*¹/Comfort/Normal/Sport
	Maintenance Info.	Maintenance Reset	Resets the engine oil life display when you have performed the maintenance service. —
	Default	Cancels/Resets all customized items in the Vehicle Settings group as default. Default/OK	
Camera Settings	Guidelines	Fixed Guideline	Selects whether the fixed guidelines come on the rear camera monitor. On*¹/Off
		Dynamic Guideline	Selects whether the dynamic guidelines come on the rear camera monitor. On*¹/Off
	Default		Cancels/Resets all customized items in the Camera Settings group as default. Default/OK

*1: Default Setting

Setup Group	Customizable Features	Description	Selectable Settings
Audio Settings	Sound	Adjusts the settings of the audio speaker's sound. ▶ Adjusting the Sound P. 215	-6 ~ C ⁺¹ ~ +6 (Bass, Treble and Subwoofer), -9 ~ C ⁺¹ ~ +9 (Fader, Balance), Off/Low/Mid ⁺¹ /High (SVC)
	Source Select Popup	Selects whether the list of selectable audio sources comes on when the AUDIO button is pressed.	On/Off ^{*1}
	CD (MP3/WMA/AAC), iPod®, USB, Pandora®* or Aha™ mode	Turns on and off the cover art display.	On ^{*1} /Off
	Cover Art		
	Bluetooth® Audio, Pandora®* or Aha™ mode	Connects, disconnects or pairs a <i>Bluetooth</i> ® Audio device to HFL.	—
	Connect Bluetooth Audio Device		
	Bluetooth® Audio, Pandora®* or Aha™ mode	Edits or deletes a <i>Bluetooth</i> ® Audio device paired to HFL.	—
Bluetooth Device List			
Default	Cancels/Resets all customized items in the Audio Settings group as default.	Default/OK	

*1:Default Setting

Setup Group	Customizable Features	Description	Selectable Settings
Phone Settings	Phone	Connect phone Pairs a new phone to HFL, or connects or disconnects a paired phone. ➤ Phone Setup P. 274	—
		Bluetooth Device List Pairs a new phone to HFL, edits or deletes a paired phone, or creates a security PIN. ➤ Phone Setup P. 274	—
		Edit Speed Dial Edits, adds or deletes a speed dial entry. ➤ Phone Setup P. 274	—

*1:Default Setting



Setup Group	Customizable Features	Description	Selectable Settings	
Phone Settings	Auto Transfer	Sets calls to automatically transfer from your phone to HFL when you enter the vehicle.	On^{*1}/Off	
	Auto Answer	Sets whether to automatically answer an incoming call after about four seconds.	On/Off^{*1}	
	Phone Ring Tone	Selects the ring tone.	Fixed/Mobile Phone^{*1}/Off	
	Automatic Phone Sync	Sets a phonebook data to be automatically imported when a phone is paired to HFL.	On/Off	
	Use Contact Photo	Displays a caller's picture on an incoming call screen.	On^{*1}/Off	
	Text/Email	Enable Text/Email	Turns the text message/E-mail function on and off.	On^{*1}/Off
		Select Account	Selects a mail or text message account.	—
		New Text/Email Alert	Selects whether a pop-up alert comes on the screen when HFL receives a new text message/E-mail.	On/Off
	Default	Cancels/Resets all customized items in the Phone Settings group as default.	Default/OK	

*1:Default Setting

Setup Group	Customizable Features	Description	Selectable Settings
Clock	Clock/Wallpaper Type	See System Settings on P. 253 to P. 255 .	
	Clock		
	Wallpaper		
	Clock Adjustment		
	Clock Format		
Info Settings	Other	<p>Info Screen Preference</p> <p>Selects either of the following to be displayed when you press the INFO button.</p> <ul style="list-style-type: none"> • Info Top: Some of the available menu items pop up. • Info Menu: All available menu items pop up. • Off: The menu item you selected last time is displayed. 	Info Top/Info Menu*1/Off
	Default	<p>Cancels/Resets all customized items in the Info Settings group as default.</p>	Default/OK

*1:Default Setting

Defaulting All the Settings

You can reset all the menu and customized settings as the factory defaults.



1. Press the **SETTINGS** button.
2. Rotate to select **System Settings**, then press .
3. Rotate to select **Factory Data Reset**, then press .
 - The pop-up menu appears on the screen.
4. Rotate to select **Yes**, then press .
 - The confirmation message will appear.
5. Rotate to select **Yes**, then press again to reset the settings.
 - The confirmation message will appear. Press to select **OK**.

Defaulting All the Settings

When you transfer the vehicle to a third party, reset all settings to default and delete all personal data.

QRG

The HomeLink® Universal Transceiver can be programmed to operate up to three remote controlled devices around your home, such as garage doors, lighting, or home security systems.

Important Safety Precautions

Refer to the safety information that comes with your garage door opener to test that the safety features are functioning properly. If you do not have the safety information, contact the manufacturer.

Before programming HomeLink, make sure that people and objects are out of the way of the garage or gate to prevent potential injury or damage.

When programming a garage door opener, park just outside the garage door's path.

Training HomeLink

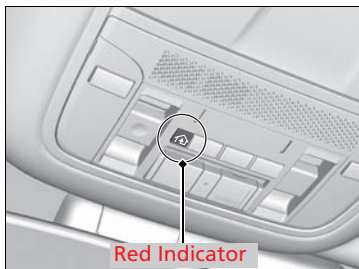

If you have not trained any of the buttons in HomeLink before, you should erase any previously learned codes. To do this:

- Press and hold the two outside buttons for about 20 seconds, until the red indicator blinks. Release the buttons, and proceed to step 1.
- If you are training the second or third button, go directly to step 1.

HomeLink® Universal Transceiver

HomeLink® is a registered trademark of Johnson Controls., Inc.

Before programming HomeLink to operate a garage door opener, confirm that the opener has an external entrapment protection system, such as an "electronic eye," or other safety and reverse stop features. If it does not, HomeLink may not be able to operate it.

TOC

Features

Index

Home

Training a Button

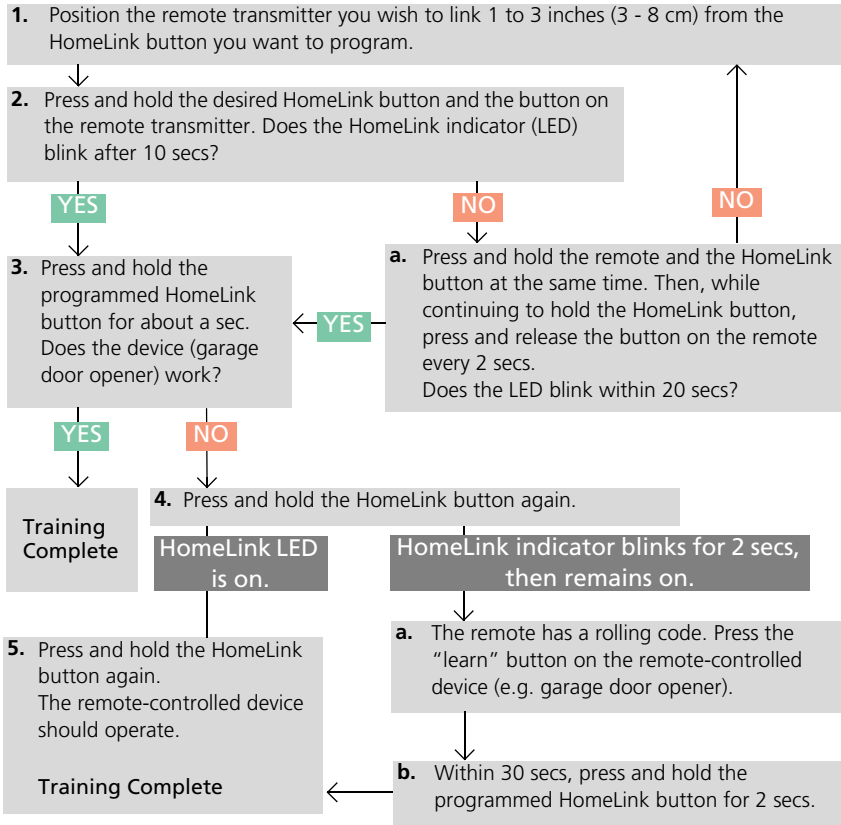

Training HomeLink

Retraining a Button

If you want to retrain a programmed button for a new device, you do not have to erase all button memory. You can replace the existing memory code using this procedure:

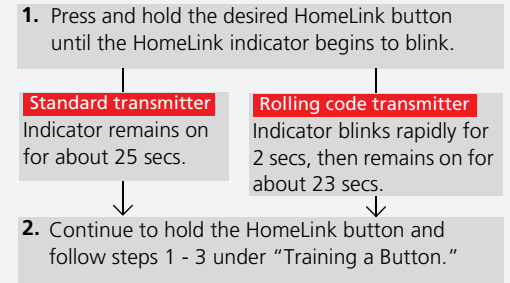

Erasing Codes

To erase all the codes, press and hold the two outside buttons until the HomeLink indicator begins to blink (about 10 to 20 secs). You should erase all codes before selling the vehicle.

If you have any problems, see the device's instructions, visit www.homelink.com, or call HomeLink at (800) 355-3515.

Models with navigation system

See Navigation System Manual for how to operate *Bluetooth*® HandsFreeLink®.

Models without navigation system

Bluetooth® HandsFreeLink® (HFL) allows you to place and receive phone calls using your vehicle's audio system, without handling your cell phone.

Using HFL

HFL Buttons

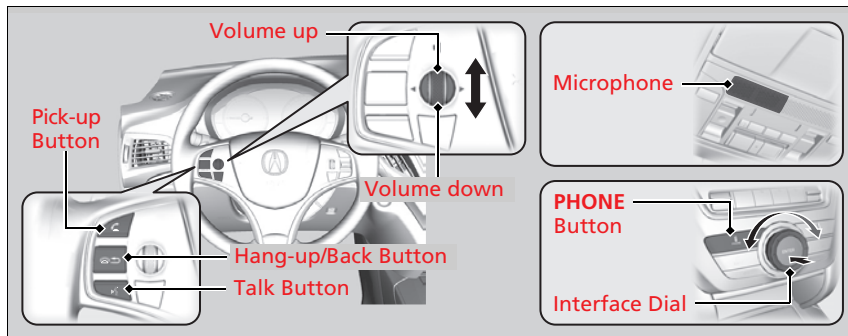

(Pick-up) button: Press to go to the **Speed Dial/Call History** on the multi-information display or to answer an incoming call.

(Hang-up/back) button: Press to end a call, to cancel a command or to clear the phone information on the MID.

(Talk) button: Press to give HFL voice commands.

PHONE button: Press to go directly to the Phone screen.

Interface dial: Rotate to select an item on the screen, then press . Move , , or to select secondary menu.

Bluetooth® HandsFreeLink®

To use HFL, you need a *Bluetooth*-compatible cell phone. For a list of compatible phones, pairing procedures, and special feature capabilities:

- **U.S.:** Visit www.acura.com/handsfreelink, or call 1-888-528-7876.
- **Canada:** Visit www.handsfreelink.ca, or call 1-888-528-7876.

To use HFL, the **Bluetooth** setting must be **On**.

[Customized Features P. 248](#)

Voice control tips:

- Aim the vents away from the ceiling and close the windows, as noise coming from them may interfere with the microphone.
- Press and release the button when you want to call a number using a stored voice tag, a phonebook name, or a number. Speak clearly and naturally after a beep.
- If the microphone picks up voices other than yours, the command may be misinterpreted.
- To change the volume level, use the audio system's volume knob or the remote audio controls on the steering wheel.

State or local laws may prohibit the operation of handheld electronic devices while operating a vehicle.

If you receive a call while using the audio system, the system resumes its operation an after ending the call.

HFL Status Display

The audio/information screen notifies you when there is an incoming call.

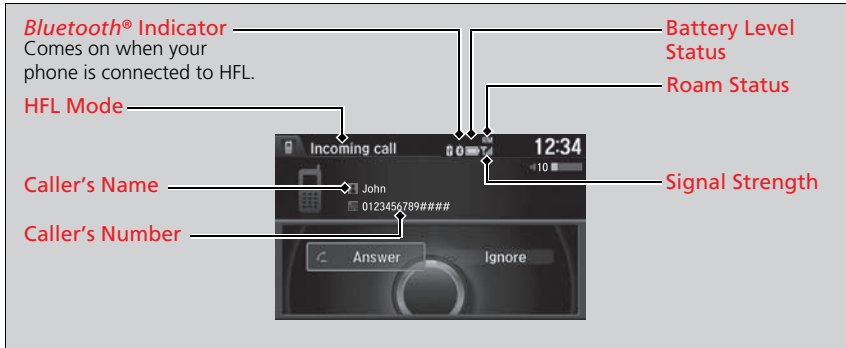

Limitations for Manual Operation

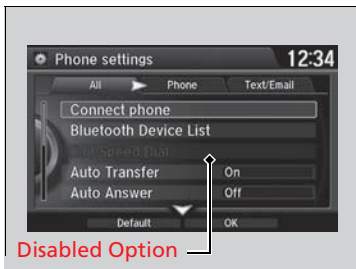

Certain manual functions are disabled or inoperable while the vehicle is in motion. You cannot select a grayed-out option until the vehicle is stopped.

Only previously stored speed dial entries with voice tags, phonebook names, or numbers can be called using voice commands while the vehicle is in motion.

▶ [Speed Dial P. 285](#)

Bluetooth® HandsFreeLink®

Bluetooth® Wireless Technology

The *Bluetooth*® word mark and logos are registered trademarks owned by Bluetooth SIG, Inc., and any use of such marks by Honda Motors Co., Ltd., is under license. Other trademarks and trade names are those of their respective owners.

HFL Limitations

An incoming call on HFL will interrupt the audio system when it is playing. It will resume when the call is ended.

HFL Status Display

The information that appears on the audio/information screen varies between phone models.

You can change the system language to English, French, or Spanish.

▶ [Customized Features P. 248](#)

HFL Menus

The power mode must be in ACCESSORY or ON to use HFL.

■ Phone Settings screen



1. Press the **SETTINGS** button.
2. Rotate to select **Phone Settings**, then press .

▶ HFL Menus

To use HFL, you must first pair your *Bluetooth*-compatible cell phone to the system while the vehicle is parked.

Some functions are limited while driving. A message appears on the screen when the vehicle is moving and the operation is canceled.

TOC

Features

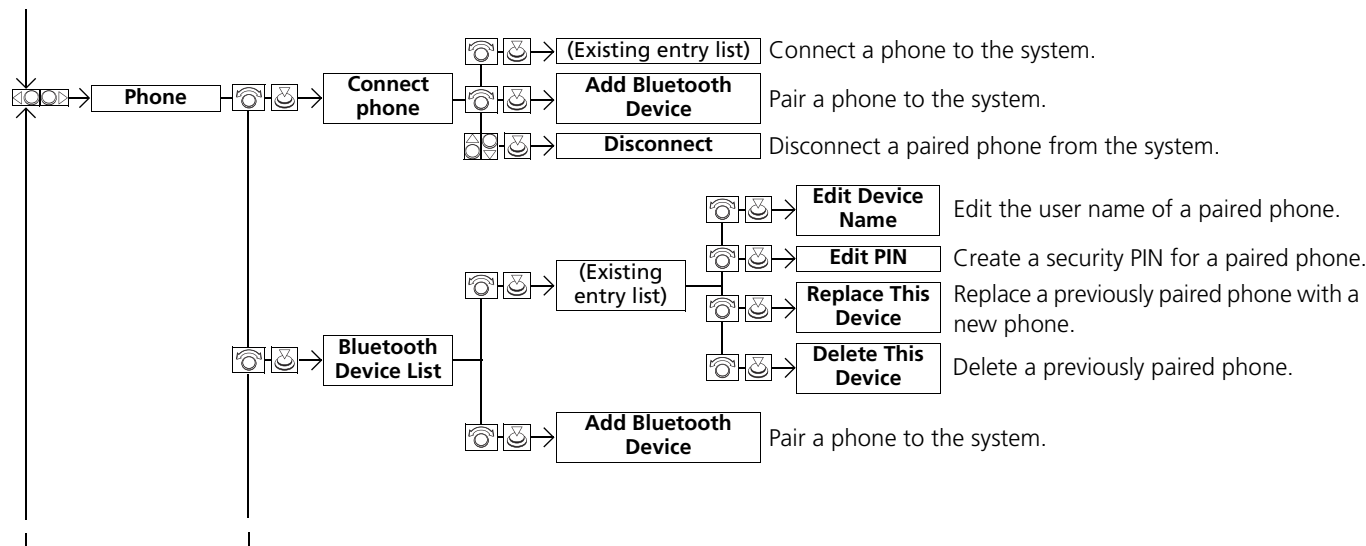

*1: Appears only when a phone is connected to HFL.

Index



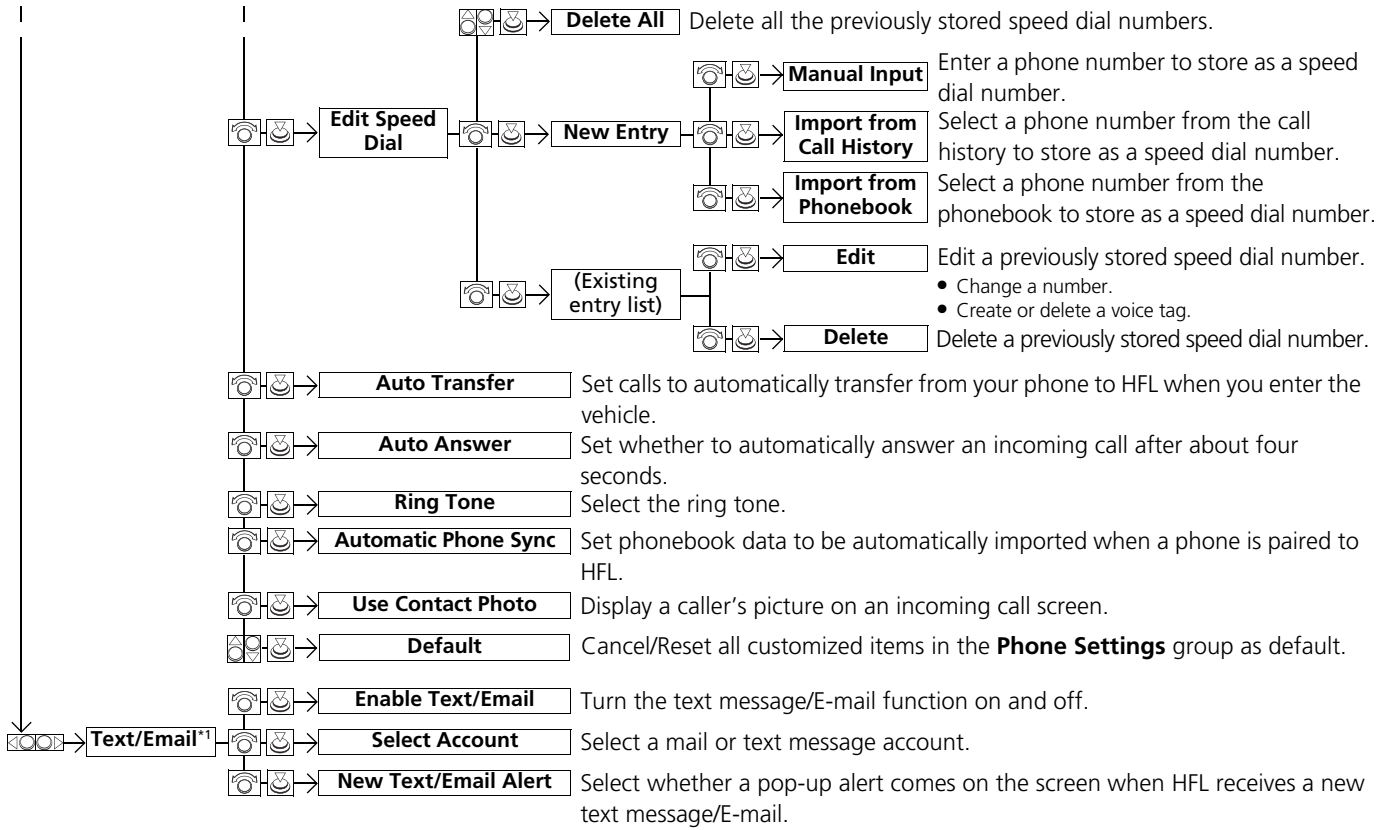

*1: Appears only when a phone is connected to HFL.

■ Phone screen



1. Press the **PHONE** button.
2. Press the **MENU** button to display the menu items.

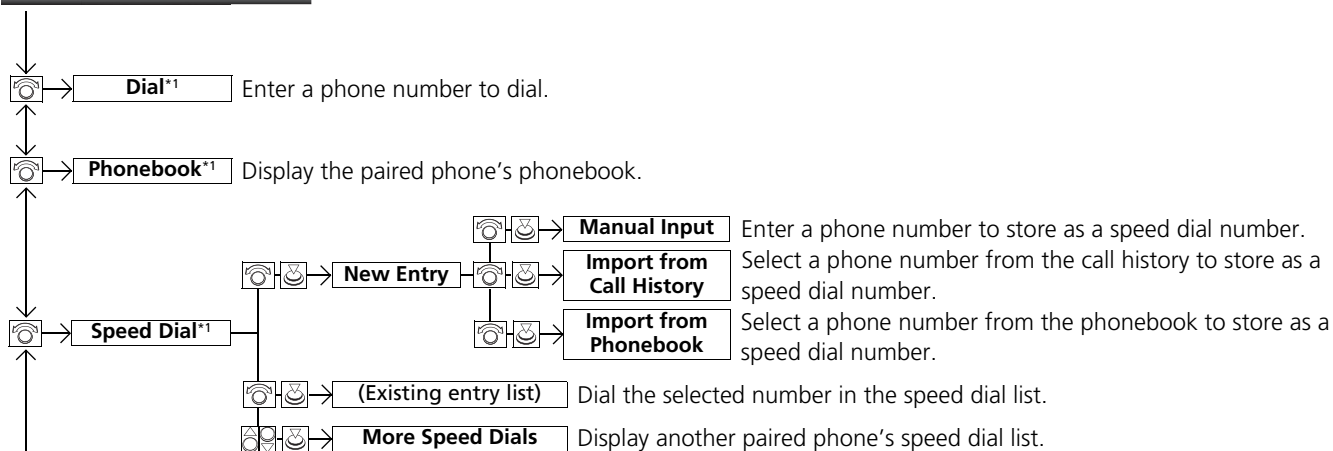

*1: Appears only when a phone is connected to HFL.

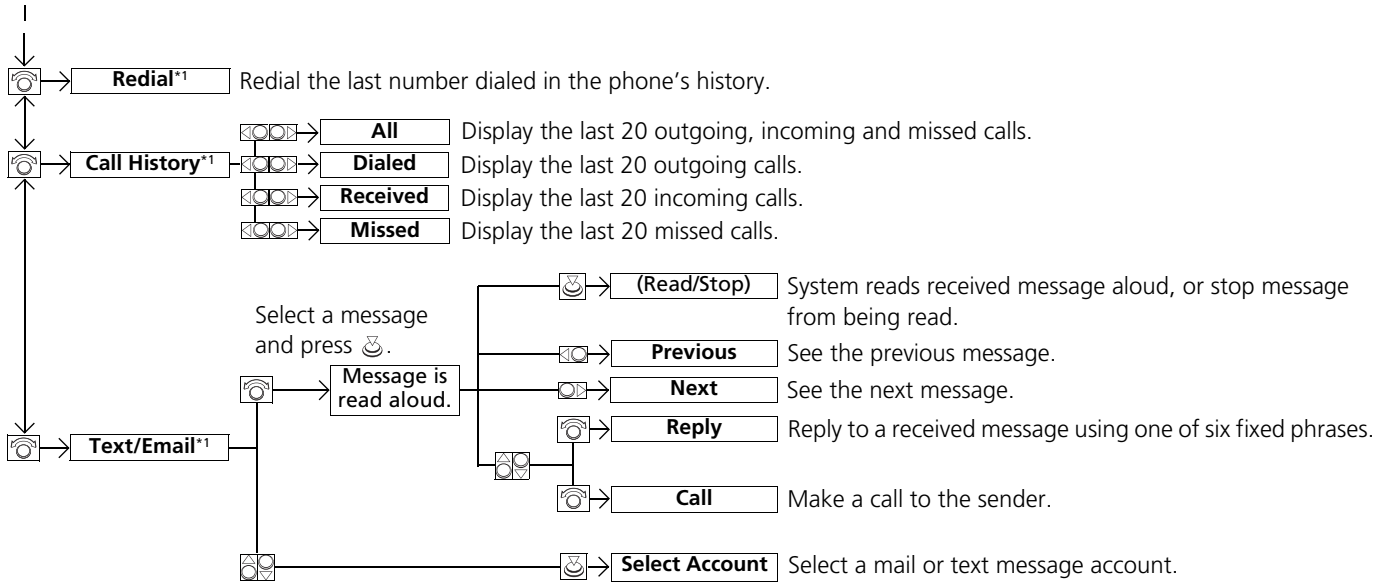

*1: Appears only when a phone is connected to HFL.

Phone Setup

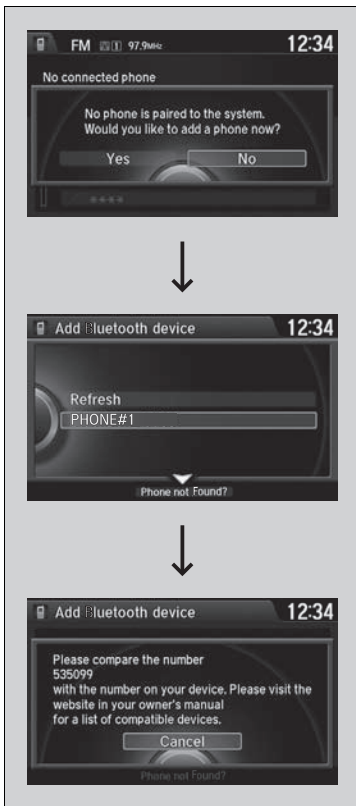

■ To pair a cell phone (when there is no phone paired to the system)

1. Press the **PHONE** button.
2. Rotate to select **Yes**, then press .
3. Make sure your phone is search or discoverable mode, then press .
 - ▶ HFL automatically searches for a *Bluetooth* device.
4. When your phone appears on the list, select it by pressing .
 - ▶ If your phone does not appear, you can select **Refresh** to search again.
 - ▶ If your phone still does not appear, move to select **Phone not Found?** and search for *Bluetooth* devices using your phone. From your phone, select **HandsFreeLink**.
5. HFL gives you a pairing code on the audio/ information screen.
 - ▶ Confirm if the pairing code on the screen and your phone match. This may vary by phone.
6. You will receive a notification on the screen if pairing is successful.

☞ Phone Setup

Your *Bluetooth*-compatible phone must be paired to HFL before you can make and receive hands-free calls.

Phone Pairing Tips:

- You cannot pair your phone while the vehicle is moving.
- Up to six phones can be paired.
- Your phone's battery may drain faster when it is connected to HFL.
- If your phone is not ready for pairing or not found by the system within three minutes, the system will time out and returns to idle.

Once you have paired a phone, you can see it displayed on the screen with one or two icons on the right side.

These icons indicate the following:

- : The phone can be used with HFL.
- : The phone is compatible with *Bluetooth*® Audio.

When pairing is completed, an **Automatic Phone Sync** prompt appears. Select **On** if you want your call history and phonebook automatically imported to HFL.

▶ [Changing the Automatic Phone Sync setting P. 284](#)



■ To pair a cell phone (when a phone has already been paired to the system)

1. Press the **SETTINGS** button.
2. Rotate to select **Phone Settings**, then press .
 - ▶ Repeat the procedure to select **Connect phone**, then **Add Bluetooth Device**.
3. Make sure your phone is in search or discoverable mode, then press .
 - ▶ HFL automatically searches for a *Bluetooth* device.
4. When your phone appears on the list, select it by pressing .
 - ▶ If your phone does not appear, you can select **Refresh** to search again.
 - ▶ If your phone still does not appear, move to select **Phone not Found?** and search for *Bluetooth* devices using your phone. From your phone, select **HandsFreeLink**.
5. HFL gives you a pairing code on the audio/information screen.
 - ▶ Confirm if the pairing code on the screen and your phone match. This may vary by phone.
6. You will receive a notification on the screen if pairing is successful.

Continued



■ **To change the pairing code setting**

1. Press the **SETTINGS** button.
2. Rotate to select **System Settings**, then press .
 - ▶ Repeat the procedure to select **Edit Pairing Code**.
3. Rotate to select **Fixed** or **Random** then press .

▶▶ To change the pairing code setting

The pairing code may be six or four digits depending on your phone.

The default pairing code is **0000** until you change the setting.

To create your own, select **Fixed**, and delete the current code, then enter a new one.

For a randomly generated pairing code each time you pair a phone, select **Random**.



■ To replace an already-paired phone with a new phone







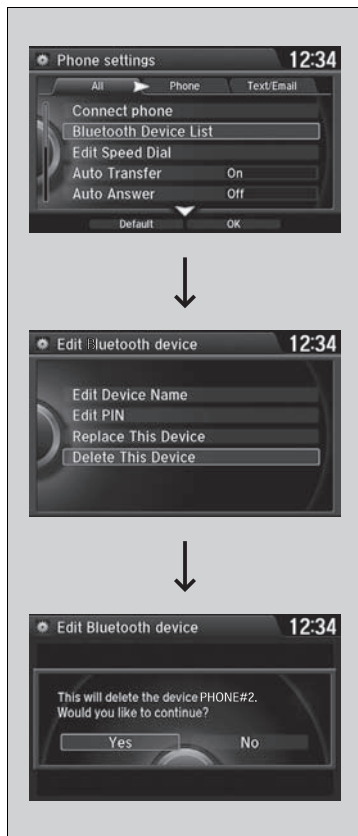

1. Press the **SETTINGS** button.
2. Rotate to select **Phone Settings**, then press .
- ▶ Repeat the procedure to select **Bluetooth Device List**.
3. Rotate to select a paired phone you want to replace, then press .
4. Rotate to select **Replace This Device**, then press .
5. HFL enters the pairing process and searches a new phone.
 - ▶ Follow the prompts to pair a new phone.
6. You will receive a notification on the screen if pairing is successful.

☒ To replace an already-paired phone with a new phone

The replaced phone will keep the same speed dial entries, and security PIN information from the previously paired phone.



■ To delete a paired phone

1. Press the **SETTINGS** button.
2. Rotate  to select **Phone Settings**, then press .
▶ Repeat the procedure to select **Bluetooth Device List**.
3. Rotate  to select a phone you want to delete, then press .
4. Rotate  to select **Delete This Device**, then press .
5. You will receive a confirmation message on the screen. Rotate  to select **Yes**, then press .
6. You will receive a notification on the screen if it is successful.

To Set Up a Text Message/E-mail Options

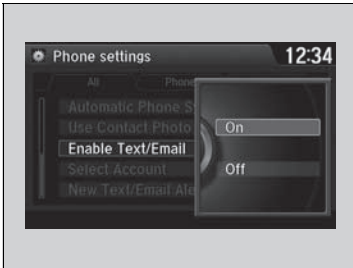

■ To turn on or off the text/E-mail function

1. Press the **SETTINGS** button.
2. Rotate to select **Phone Settings**, then press .
 - ▶ Repeat the procedure to select **Enable Text/Email**.
 - ▶ A pop-up menu appears on the screen.
3. Rotate to select **On** or **Off**, then press .

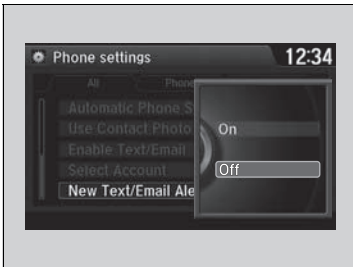

■ To turn on or off the text/E-mail notice

1. Press the **SETTINGS** button.
2. Rotate to select **Phone Settings**, then press .
 - ▶ Repeat the procedure to select **New Text/Email Alert**.
 - ▶ A pop-up menu appears on the screen.
3. Rotate to select **On** or **Off**, then press .

✉ To turn on or off the text/E-mail notice

On: A pop-up notification comes on every time you receive a new text message.

Off: The message you receive is stored in the system without notification.

■ To Create a Security PIN

You can protect each of the six cell phones with a security PIN.



1. Press the **SETTINGS** button.
2. Rotate to select **Phone Settings**, then press .
 - ▶ Repeat the procedure to select **Bluetooth Device List**.
3. Rotate to select a phone you want to add a security PIN to, then press .
4. Rotate to select **Edit PIN**, then press .
5. Enter a new four-digit number.
 - ▶ **Audio/information screen**
Rotate to select, then press . Move to delete. Rotate to select **OK** to enter the security PIN.
 - ▶ **On Demand Multi-Use Display™**
You can also enter a number using the icons.
6. Re-enter the four-digit number.
 - ▶ The screen returns to the screen in step 4.

▶▶ To Create a Security PIN

If the phone is already security PIN protected, you need to enter the current security PIN before clearing the PIN or creating a new one.

Editing User Name







Edit the user name of a paired phone as follows:

1. Press the **SETTINGS** button.
2. Rotate to select **Phone Settings**, then press .
 - ▶ Repeat the procedure to select **Bluetooth Device List**.
3. Rotate to select a phone you want to edit, then press .
4. Rotate to select **Edit Device Name**, then press .
5. Enter a new name of the phone.
 - ▶ **Audio/information screen**
Rotate to select, then press . Move to delete. Rotate or move to select **OK** then press to enter the name.
 - ▶ **On Demand Multi-Use Display™**
You can also enter a name using the icons.

■ Automatic Transferring

If you get into the vehicle while you are on the phone, the call can be automatically transferred to HFL.







1. Press the **SETTINGS** button.
2. Rotate  to select **Phone Settings**, then press .
 - ▶ Repeat the procedure to select **Auto Transfer**.
3. Rotate  to select **On**, then press .

■ Auto Answer

You can set HFL to automatically answer an incoming call in four seconds.



1. Press the **SETTINGS** button.
2. Rotate  to select **Phone Settings**, then press .
 - ▶ Repeat the procedure to select **Auto Answer**.
3. Rotate  to select **On**, then press .

Ring Tone

You can change the ring tone setting.



1. Press the **SETTINGS** button.
2. Rotate to select **Phone Settings**, then press .
 - ▶ Repeat the procedure to select **Ring Tone**.
3. Rotate to select **Fixed**, **Mobile Phone** or **Off**, then press .

Ring Tone

Fixed: The fixed ring tone sounds from the speaker.
Mobile Phone: The ring tone stored in the connected cell phone sounds from the speaker.
Off: No ring tones sound from the speaker.

Use Contact Photo

You can display a caller's picture on an incoming call screen.



1. Press the **SETTINGS** button.
2. Rotate to select **Phone Settings**, then press .
 - ▶ Repeat the procedure to select **Use Contact Photo**.
3. Rotate to select **On** or **Off**, then press .

Use Contact Photo

This function may not be available on some phones.

Automatic Import of Cellular Phonebook and Call History



■ When Automatic Phone Sync is set to On:

When your phone is paired, the contents of its phonebook and call history are automatically imported to HFL.

■ Changing the Automatic Phone Sync setting

1. Press the **SETTINGS** button.
2. Rotate to select **Phone Settings**, then press .
 - ▶ Repeat the procedure to select **Automatic Phone Sync**.
3. Rotate to select **On** or **Off**, then press .

▶▶ Automatic Import of Cellular Phonebook and Call History

When you select a person from the list in the cellular phonebook, you can see up to three category icons. The icons indicate what types of numbers are stored for that name.

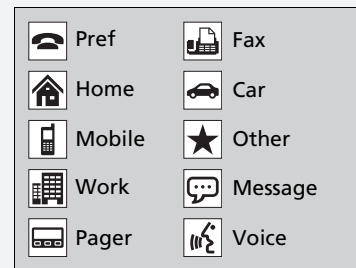







On some phones, it may not be possible to import the category icons to HFL.

The phonebook is updated after every connection. Call history is updated after every connection or call.

Speed Dial

Up to 20 speed dial numbers can be stored per phone.

To store a speed dial number:

1. Press the **PHONE** button.
2. Press the **MENU** button.
3. Rotate  to select **Speed Dial**, then press .
 - ▶ Repeat the procedure to select **New Entry**.
4. Rotate  to select a place to choose a number from, then press .
 - From **Import from Call History**:
 - ▶ Select a number from the call history.
 - From **Manual Input**:
 - ▶ Input the number manually.
 - From **Import from Phonebook**:
 - ▶ Select a number from the linked cell phone's imported phonebook.
5. When the speed dial is successfully stored from **Import from Call History** or **Import from Phonebook**, you are asked to create a voice tag for the number. Rotate  to select **Yes** or **No**, then press .
6. Using the  button, follow the prompts to store a voice tag for the speed dial entry.

Speed Dial

When a voice tag is stored, press the  button to call the number using the voice tag. Say "Call" and the voice tag name.

Continued

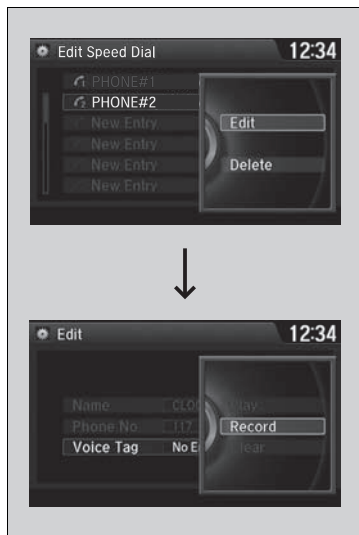

■ To add a voice tag to a stored speed dial number

1. Press the **SETTINGS** button.
2. Rotate to select **Phone Settings**, then press .
 - ▶ Repeat the procedure to select **Edit Speed Dial**.
3. Select an existing speed dial entry.
 - ▶ From the pop-up menu, rotate to select **Edit**, then press .
4. Rotate to select **Voice Tag** then press .
5. From the pop-up menu, rotate to select **Record**, then press .
 - ▶ After selecting **Record**, wait for the beep(s) to sound before you state the name.
6. Move and select **OK** to complete the voice tag.

☒ Speed Dial

Avoid using duplicate voice tags.

Avoid using "home" as a voice tag. It is easier for HFL to recognize a longer name. For example, use "John Smith" instead of "John."

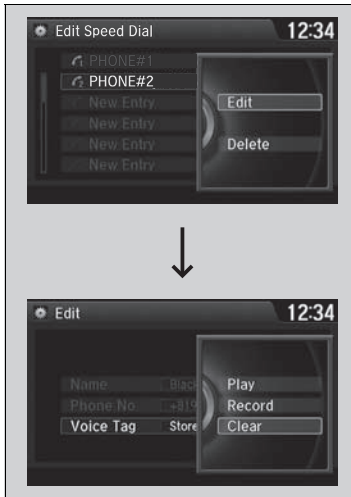

■ To delete a voice tag

1. Press the **SETTINGS** button.
2. Rotate to select **Phone Settings**, then press .
 - ▶ Repeat the procedure to select **Edit Speed Dial**.
3. Select an existing speed dial entry.
 - ▶ From the pop-up menu, rotate to select **Edit**, then press .
4. Rotate to select **Voice Tag**, then press .
 - ▶ From the pop-up menu, rotate to select **Clear**, then press .
5. You will receive a confirmation message on the screen. Rotate to select **Yes**, then press .

■ To delete a speed dial

1. Press the **SETTINGS** button.
2. Rotate to select **Phone Settings**, then press .
 - ▶ Repeat the procedure to select **Edit Speed Dial**.
3. Select an existing speed dial entry.
 - ▶ From the pop-up menu, rotate to select **Delete**, then press .
4. You will receive a confirmation message on the screen. Rotate to select **Yes**, then press .

Continued

■ Making a Call



You can make calls by inputting any phone number, or by using the imported phonebook, call history, speed dial entries, or redial.

▶▶ Making a Call

Any voice-tagged speed dial entry, phonebook name, or number can be dialed by voice from most screens.

Press the  button and say "Call" and the voice tag name, "Call by name" and the phonebook name, or "Call" and the phone number.

The maximum range between your phone and vehicles is 30 feet (10 meters).

Once a call is connected, you can hear the voice of the person you are calling through the audio speakers.

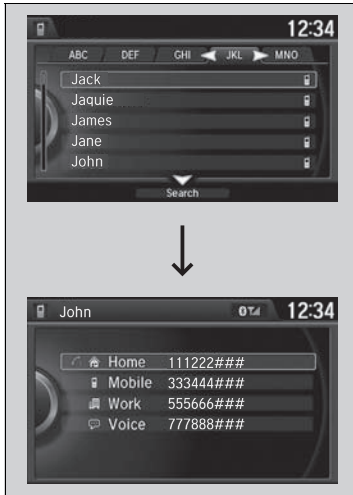

■ **To make a call using the imported phonebook**

1. Press the **PHONE** button.
2. Press the **MENU** button.
3. Rotate to select **Phonebook**, then press .
4. The phonebook is stored alphabetically. Move to **Search**.
 - ▶ You can use the keyboard on the touch screen for an alphabetical search.
5. Rotate to select a number, then press .
 - ▶ Dialing starts automatically.

☒ To make a call using the imported phonebook

This function is disabled while the vehicle is moving. However, you can call a stored voice-tagged speed dial number, phonebook name, or number using voice commands.

- ▶ [Limitations for Manual Operation P. 269](#)
- ▶ [Speed Dial P. 285](#)

You can use the keyboard on the On Demand Multi-Use Display™ for an alphabetical search.





■ **To make a call using a phone number**

1. Press the **PHONE** button.
2. Press the **MENU** button.
3. Rotate to select **Dial**, then press .
4. Rotate to select a number, then press .
5. Rotate to select , then press .
 - ▶ Dialing starts automatically.

▶▶ To make a call using a phone number

This function is disabled while the vehicle is moving. However, you can call a stored voice-tagged speed dial number, phonebook name, or number using voice commands.

- ▶ [Limitations for Manual Operation P. 269](#)
- ▶ [Speed Dial P. 285](#)

You can use the keyboard on the On Demand Multi-Use Display™ to input numbers. Select numbers, then to start dialing.



■ **To make a call using redial**

1. Press the **PHONE** button.
2. Press the **MENU** button.
3. Rotate to select **Redial**, then press .
 - ▶ Dialing starts automatically.

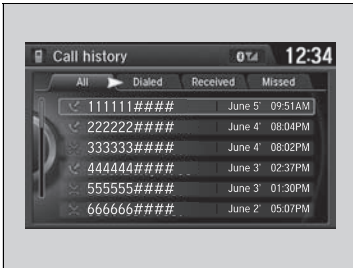

■ **To make a call using the call history**

Call history is stored by **All, Dialed, Received, and Missed.**

1. Press the **PHONE** button.
2. Press the **MENU** button.
3. Rotate to select **Call History**, then press .
4. Move or to select **All, Dialed, Received, and Missed.**
5. Rotate to select a number, then press .
 - ▶ Dialing starts automatically.

☒ **To make a call using the call history**

The call history displays the last 20 dialed, received, or missed calls.
(Appears only when a phone is connected to HFL.)

These icons next to the number indicate the following:

- : Dialed calls.
- : Received calls.
- : Missed calls.

Steering switches

The call history displays the last 12 dialed, received, or missed calls.

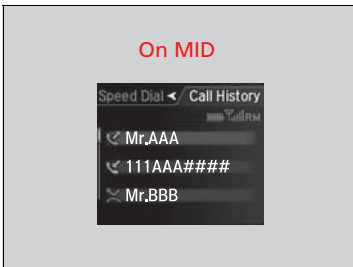



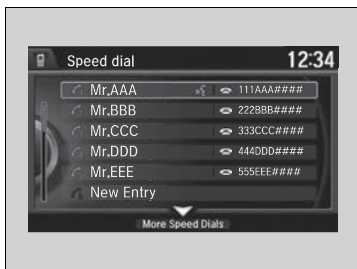

Steering switches

1. Press the button.
2. Shift the left selector wheel right to select **Call History.**
3. Roll the left selector wheel to select a number.
4. Push the left selector wheel or the button.
 - ▶ Dialing starts automatically.



■ **To make a call using a speed dial entry**

1. Press the **PHONE** button.
2. Press the **MENU** button.
3. Rotate  to select **Speed Dial**, then press .
4. Rotate  to select a number, then press .
 - ▶ Dialing starts automatically.

▶▶ To make a call using a speed dial entry

Move  to select **More Speed Dials** to view another paired phone's speed dial list. You can make a call from that list using the currently connected phone.

When a voice tag is stored, press the  button to call the number using the voice tag.

 [Speed Dial P. 285](#)



Any voice-tagged speed dial entry, phonebook name or number can be dialed by voice from any screen. Press the  button and follow the prompts.

Steering switches

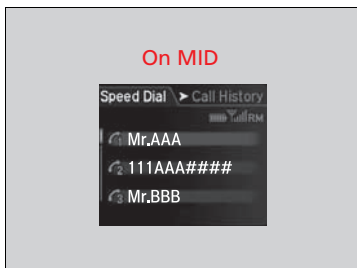
The speed dial displays the 20 speed dial entries.



Steering switches

1. Press the  button.
2. Shift the left selector wheel left to select **Speed Dial**.
3. Roll the left selector wheel to select a number.
4. Push the left selector wheel or the  button.
 - ▶ Dialing starts automatically.

Receiving a Call



When there is an incoming call, an audible notification sounds (if activated) and the **Incoming call** screen appears.

Press the  button to answer the call.

Press the  button to decline or end the call.

Receiving a Call



Call Waiting

Press the  button to put the current call on hold to answer the incoming call.

Press the  button again to return to the current call.

Ignore the incoming call if you do not want to answer it.

Press the  button if you want to hang up the current call.

You can select the icons on the On Demand Multi-Use Display™ instead of the  and  buttons.



Options During a Call

The following options are available during a call.



Mute: Mute your voice.

Transfer: Transfer a call from HFL to your phone.

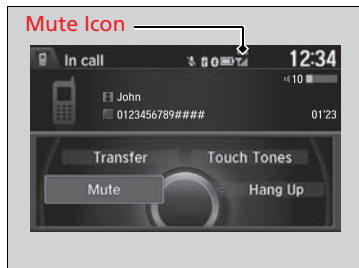
Touch Tones: Send numbers during a call. This is useful when you call a menu-driven phone system.



The available options are shown on the Phone screen.

Rotate  to select one of the available options, then press .

▶ The mute icon appears when **Mute** is selected. Select **Mute** again to turn it off.

Options During a Call

Touch Tones: Available on some phones.

You can select the icons on the On Demand Multi-Use Display™.



Receiving a Text Message/E-mail

HFL can display newly received text messages and E-mails as well as 20 of the most recently received messages on a linked cell phone. Each received message can be read aloud and replied to using a fixed common phrase.



1. A pop-up appears and notifies you of a new text message or E-mail.
2. Rotate to select **Read** to listen to the message, then press .
 - ▶ The text message or E-mail is displayed. The system automatically starts reading out the message.
3. To discontinue the message read-out, press .

Receiving a Text Message/E-mail

The system does not display any received messages while you are driving. You can only hear them read aloud.

With some phones, you may be able to display up to 20 most recent text messages and E-mails.

State or local laws may limit your use of the HFL text message/E-mail feature. Only use the text message/E-mail feature when conditions allow you to do so safely.

When you receive a text message or E-mail for the first time since the phone is paired to HFL, you are asked to turn the **New Text/Email Alert** setting to **On**.

To turn on or off the text/E-mail notice
P. 279

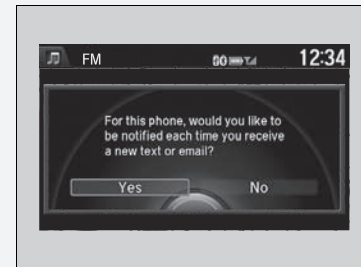

■ Selecting a Mail Account

If a paired phone has text message or mail accounts, you can select one of them to be active and receive notifications.

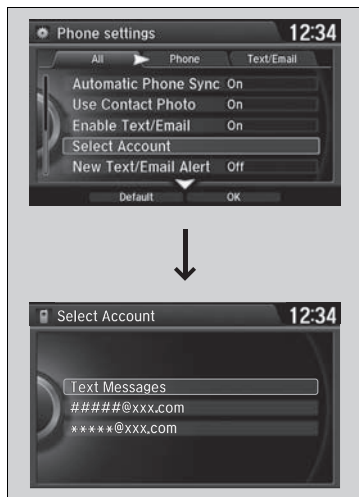

1. Press the **SETTINGS** button.
2. Rotate to select **Phone Settings**, then press .
 - ▶ Repeat the procedure to select **Select Account**.
3. Rotate to select **Text Messages** or an E-mail account you want, then press .

▶▶ Selecting a Mail Account

You can also select a mail account from the folder list screen or the message list screen.

Move to select **Select Account**, then press .

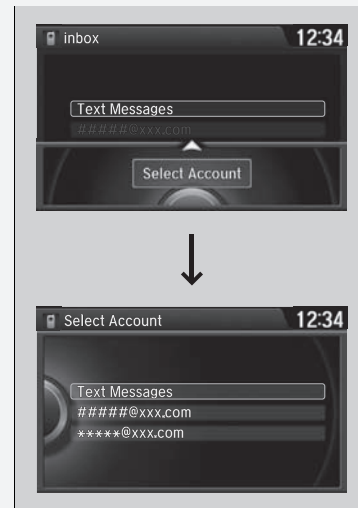

You can only receive notifications from one text message or mail account at a time.

Displaying Messages



■ Displaying text messages

1. Press the **PHONE** button.
2. Press the **MENU** button.
3. Rotate to select **Text/Email**, then press .

 - ▶ Select account if necessary.

4. Rotate to select a message, then press .

 - ▶ The text message is displayed. The system automatically starts reading the message aloud.

» Displaying Messages

The icon appears next to an unread message.

If you delete a message on the phone, the message is also deleted in the system. If you send a message from the system, the message goes to your phone's mailbox.

To see the previous or next message, move or on the text message screen.

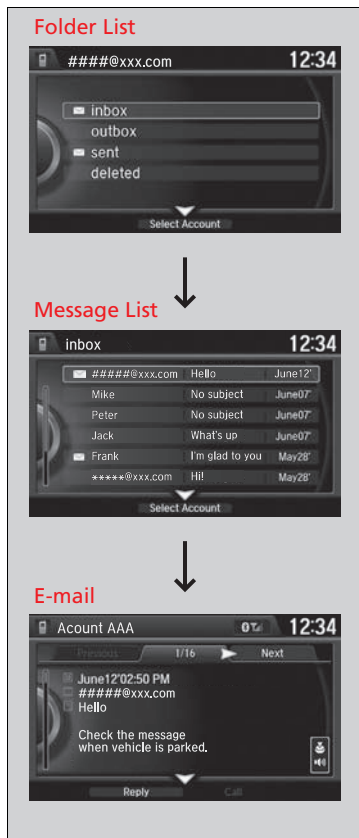

■ Displaying E-mails

1. Press the **PHONE** button.
2. Press the **MENU** button.
3. Rotate to select **Text/Email**, then press .
4. Rotate to select a folder, then press .
5. Rotate to select a message, then press .
 - ▶ The E-mail is displayed. The system automatically starts reading the message aloud.

»» Displaying E-mails

Received text messages and E-mails may appear in the message list screen at the same time. In this case, text messages are titled **No subject**.

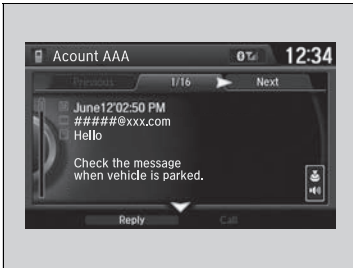

■ **Read or stop reading a message**

1. Go to the text message or E-mail screen.
 - ▶ The system automatically starts reading the message aloud.
 - [Displaying Messages P. 297](#)
2. Press to stop reading.
 - Press again to start reading the message from the beginning.



■ **Reply to a message**

1. Go to the text message or E-mail screen.
 - ▶ The system automatically starts reading the message aloud.
 - [Displaying Messages P. 297](#)
2. Move and rotate to select **Reply**, then press .
3. Rotate to select the reply message, then press .
 - ▶ The pop-up menu appears on the screen.
4. Select **Send** to send the message.
 - ▶ **Message Sent** appears on the screen when the reply message was successfully sent.

✉ Reply to a message



The available fixed reply messages are as follows:

- **Talk to you later, I'm driving.**
- **I'm on my way.**
- **I'm running late.**
- **OK**
- **Yes**
- **No**

You cannot add, edit, or delete reply messages.



■ Making a call to a sender





1. Go to the text message screen.
 - ▶ The system automatically starts reading the message aloud.
 - ▶ [Displaying text messages P. 297](#)
2. Move  and rotate  to select **Call**, then press .

When you set the power mode to ON, the compass self-calibrates, and the compass display appears.

Compass Calibration

If the compass indicates the wrong direction, or the **CAL** indicator blinks, you need to manually calibrate the system.



1. Set the power mode to ON.
2. On the top screen of any audio source, press and hold  for five seconds.
 - ▶ The display switches to the **Compass settings** screen.
3. Rotate  to select **Calibration**, then press .
4. When the display changes to **Calibration Start**, press .
5. Drive the vehicle slowly in two circles.
 - ▶ The compass starts to show a direction after the calibration. The **CAL** indicator goes off.

Compass*

Compass operation can be affected under the following conditions:

- Driving near power lines or stations
- Crossing a bridge
- Passing a large vehicle, or driving near a large object that can cause a magnetic disturbance
- When accessories such as antennas and roof racks are mounted by magnets





Compass Calibration

Calibrate the compass in an open area.

While setting the compass, press the **BACK** button to cancel the setting mode and return to the previous screen.

Compass Zone Selection



1. Set the power mode to ON.
2. On the top screen of any audio source, press and hold  for five seconds.
 - ▶ The display switches to the **Compass settings** screen.
3. Rotate  to select **Zone Adjust**, then press .
 - ▶ The display shows the current zone number the system is set to.
4. To change the zone, rotate  to select the zone number of your area (See Zone Map), then press .

Compass Zone Selection

The zone selection is done to compensate the variation between magnetic north and true north.

If the calibration starts while the audio system is in use, the display returns to normal after the calibration is completed.

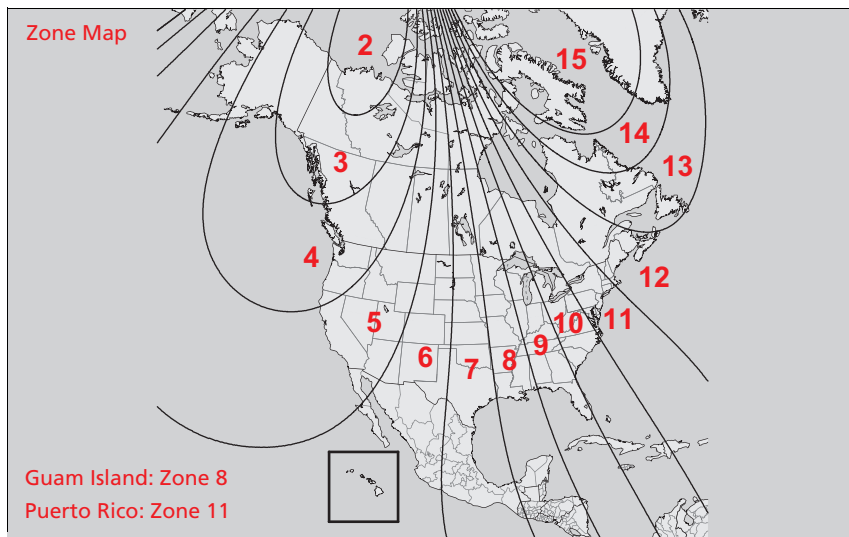

Driving

This chapter discusses driving, refueling, and information on items such as accessories.



Before Driving			
Driving Preparation	304	Forward Collision Warning (FCW)* ..	346
Maximum Load Limit.....	307	Lane Departure Warning (LDW)*	350
Towing a Trailer	309	Lane Keeping Assist System (LKAS)* ..	353
Off-Highway Driving Guidelines	320	VSA® (Vehicle Stability Assist), aka ESC	
When Driving		(Electronic Stability Control), System ..	358
Starting the Engine	322	Agile Handling Assist System.....	360
Precautions While Driving.....	327	Blind Spot Information (BSI) System* ..	361
Automatic Transmission	328	Super Handling-All Wheel Drive™	
Shifting	329	(SH-AWD*)®.....	363
Integrated Dynamics System (IDS).....	333	Tire Pressure Monitoring System	363
Cruise Control	334	Tire Pressure Monitoring System	
Adaptive Cruise Control (ACC) with		(TPMS) - Required Federal Explanation	365
Low Speed Follow (LSF)*.....	337	Braking	
		Brake System	367
		Anti-lock Brake System (ABS).....	369
		Brake Assist System	370
		Collision Mitigation Braking System™	
		(CMBS™)*	371
		Parking Your Vehicle	
		When Stopped	377
		Parking Sensor System*	378
		Multi-View Rear Camera*	382
		Refueling	
		Fuel Information	383
		How to Refuel	384
		Fuel Economy	385
		Accessories and Modifications	386

* Not available on all models

Driving Preparation

Check the following items before you start driving.

Exterior Checks

- Make sure there are no obstructions on the windows, door mirrors, exterior lights, or other parts of the vehicle.
 - ▶ Remove any frost, snow, or ice.
 - ▶ Remove any snow on the roof, as this can slip down and obstruct your field of vision while driving. If frozen solid, remove ice once it has softened.
 - ▶ When removing ice from around the wheels, be sure not to damage the wheel or wheel components.
- Make sure the hood is securely closed.
 - ▶ If the hood opens while driving, your front view will be blocked.
- Make sure the tires are in good condition.
 - ▶ Check air pressure, check for damage and excessive wear.
 - ▶ [Checking and Maintaining Tires P. 417](#)
- Make sure there are no people or objects behind or around the vehicle.
 - ▶ There are blind spots from the inside.

Exterior Checks

NOTICE

When doors are frozen shut, use warm water around the door edges to melt any ice. Do not try to force them open, as this can damage the rubber trim around the doors. When done, wipe dry to avoid further freezing.

Do not pour warm water into the key cylinder. You will be unable to insert key if the water freezes in the hole.

Heat from the engine and exhaust can ignite flammable materials left under the hood, causing a fire. If you've parked your vehicle for an extended period, inspect and remove any debris that may have collected, such as dried grass and leaves that have fallen or have been carried in for use as a nest by a small animal.

Also check under the hood for leftover flammable materials after you or someone else has performed maintenance on your vehicle.

Interior Checks

- Store or secure all items on board properly.
 - ▶ Carrying too much cargo, or improperly storing it, can affect your vehicle's handling, stability, stopping distance, and tires, and make it unsafe.
 - [Maximum Load Limit P. 307](#)
- Do not pile items higher than the seat height.
 - ▶ They can block your view and may be thrown forward in the event of sudden braking.
- Do not place anything in the front seat footwells. Make sure to secure the floor mat.
 - ▶ An object or unsecured floor mat can interfere with your brake and accelerator pedal operation while driving.
- If you have any animals on board, do not let them move around in the vehicle.
 - ▶ They may interfere with driving and a crash could occur.
- Securely close and lock all doors and the tailgate.
 - [Locking/Unlocking the Doors from the Inside P. 124](#)
- Adjust your seating position properly.
 - ▶ Adjust the head restraint, too.
 - [Adjusting the Seats P. 161](#)
 - [Adjusting the Head Restraints P. 164](#)
- Adjust the mirrors and steering wheel properly for your driving.
 - ▶ Adjust them while sitting in the proper driving position.
 - [Adjusting the Steering Wheel P. 157](#)
 - [Adjusting the Mirrors P. 158](#)

Interior Checks

The headlight aim is set by the factory, and does not need to be adjusted. However, if you regularly carry heavy items in the cargo area or tow a trailer, have the aiming readjusted at a dealer or by a qualified technician.

QRG

- Be sure items placed on the floor behind the front seats cannot roll under the seats.
 - ▶ They can interfere with the driver's ability to operate the pedals, the operation of the seats, or the operation of the sensors under the seats.
- Everyone in the vehicle must fasten their seat belt.
 - ▶ [Fastening a Seat Belt P. 34](#)
- Make sure that the indicators in the instrument panel come on when you start the vehicle, and go off soon after.
 - ▶ Always have a dealer check the vehicle if a problem is indicated.
 - ▶ [Indicators P. 70](#)

TOC

Driving

Index



Maximum Load Limit

The maximum load for your vehicle is 1,173 lbs (532 kg).
See Tire and Loading Information label attached to the driver's doorjamb.

Maximum Load Limit

⚠ WARNING

Overloading or improper loading can affect handling and stability and cause a crash in which you can be hurt or killed.

Follow all load limits and other loading guidelines in this manual.

Gross Vehicle Weight Rating (GVWR):

The maximum allowable weight of the vehicle, all occupants, all accessories, all cargo, and the tongue load.

➤ [Specifications P. 480](#)

Gross Axle Weight Rating (GAWR):

The maximum allowable weight of the vehicle axle.

➤ [Specifications P. 480](#)

Label Example

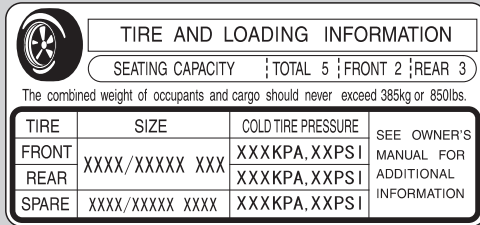

This figure includes the total weight of all occupants, cargo, and accessories, and the tongue load if you are towing a trailer.

Steps for Determining Correct Load Limit -







- (1) Locate the statement "The combined weight of occupants and cargo should never exceed XXX kg or XXX lbs." on your vehicle's placard.
- (2) Determine the combined weight of the driver and passengers that will be riding in your vehicle.
- (3) Subtract the combined weight of the driver and passengers from XXX kg or XXX lbs.
- (4) The resulting figure equals the available amount of cargo and luggage load capacity. For example, if the "XXX" amount equals 1,400 lbs. and there will be five 150 lb. passengers in your vehicle, the amount of available cargo and luggage load capacity is 650 lbs.
(1,400 - 750 (5 x 150) = 650 lbs.)

Continued

- (5) Determine the combined weight of luggage and cargo being loaded on the vehicle. That weight may not safely exceed the available cargo and luggage load capacity calculated in step 4.
- (6) If your vehicle will be towing a trailer, load from your trailer will be transferred to your vehicle. Consult this manual to determine how this reduces the available cargo and luggage load capacity of your vehicle.

In addition, the total weight of the vehicle, all occupants, accessories, cargo, and trailer tongue load must not exceed the Gross Vehicle Weight Rating (GVWR) or the Gross Axle Weight Rating (GAWR). Both are on a label on the driver's doorjamb.

Load Limits Example

<p>Example 1</p>  <p>Max Load 1,173 lbs (532 kg)</p>	\geq	 <p>Passenger Weight 150 lbs x 2 = 300 lbs (68 kg x 2 = 136 kg)</p>	<p>+</p>	 <p>Cargo Weight 873 lbs (396 kg)</p>
<p>Example 2</p>  <p>Max Load 1,173 lbs (532 kg)</p>	\geq	 <p>Passenger Weight 150 lbs x 5 = 750 lbs (68 kg x 5 = 340 kg)</p>	<p>+</p>	 <p>Cargo Weight 423 lbs (192 kg)</p>

Towing Preparation

Towing Load Limits

Your vehicle can tow a trailer if you carefully observe the load limits, use the proper equipment, and follow the towing guidelines. Check the load limits before driving.

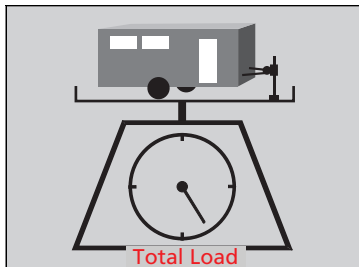

Total trailer weight

Do not exceed the maximum allowable weight of the trailer, cargo, and everything in or on it shown in the table.

Towing loads in excess of this can seriously affect vehicle handling and performance and can damage the engine and drivetrain.

Number of occupants	4WD models with ATF cooler	4WD models without ATF cooler	2WD models
2	5,000 lbs (2,268 kg)	3,500 lbs (1,588 kg)	3,500 lbs (1,588 kg)
3	4,750 lbs (2,155 kg)	3,250 lbs (1,474 kg)	3,250 lbs (1,474 kg)
4	4,500 lbs (2,041 kg)	3,000 lbs (1,361 kg)	3,000 lbs (1,361 kg)
5	4,250 lbs (1,928 kg)	2,750 lbs (1,247 kg)	2,750 lbs (1,247 kg)
6	4,000 lbs (1,814 kg)	2,500 lbs (1,134 kg)	2,500 lbs (1,134 kg)
7	Towing not recommended		

Each weight limit is calculated based on the following conditions:

- Occupants fill seats from the front of the vehicle to the back
- Each occupant weights 150 lbs (68 kg)
- Each occupant has 15 lbs (7 kg) of cargo in the cargo area

Any additional weight, cargo or accessories reduce the maximum trailer weight and maximum tongue load.

Towing Load Limits

⚠ WARNING

Exceeding any load limit or improperly loading your vehicle and trailer can cause a crash in which you can be seriously hurt or killed.

Check the loading of your vehicle and trailer carefully before starting to drive.

Check if all loads are within limits at a public scale. If a public scale is not available, add the estimated weight of your cargo load to the weight of your trailer (as quoted by the manufacturer), and then measure the tongue load with an appropriate scale or tongue gauge or estimate it based on cargo distribution.

Refer to the trailer owner's manual for additional information.

Break-in Period

Avoid towing a trailer during your vehicle's first 600 miles (1,000 km).

Never exceed the gross weight ratings. Gross weight information

[📄 Vehicle Specifications P. 480](#)

QRG

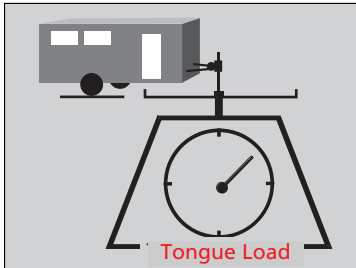

■ **Tongue load**

The weight of the tongue with a fully loaded trailer on the hitch should be approximately:

Boat trailers: 5 – 15% of the total trailer weight

Other trailers: 10 – 15% of total trailer weight

Number of occupants	4WD models	2WD models
2	500 lbs (227 kg)	350 lbs (159 kg)
3	475 lbs (215 kg)	325 lbs (147 kg)
4	380 lbs (172 kg)	300 lbs (136 kg)
5	290 lbs (132 kg)	275 lbs (125 kg)
6	165 lbs (75 kg)	150 lbs (68 kg)
7	Towing not recommended	

TOC

Driving

Index

Home

QRG

■ To estimate the tongue load

Excessive tongue load reduces front tire traction and steering control. Too little tongue load can make the trailer unstable and cause it to sway.

You can estimate the tongue load by measuring the trailer hitch height from the ground in the following steps:

1. Park the vehicle on level ground.
2. Measure the distance between the ground and the bottom of the trailer hitch.
3. Connect the fully loaded trailer to the hitch.
4. Measure the distance between the ground and the bottom of the trailer hitch again.
5. Subtract the second measurement from the first measurement, then refer to the following table.

TOC

Driving

If the difference is	4WD models	2WD models
1 inches (2.5 cm)	150 lbs (68 kg)	
1 1/2 inches (3.8 cm)	250 lbs (114 kg)	
2 inches (5.1 cm)	350 lbs (159 kg)	
2 3/8 inches (6.0 cm)	450 lbs (205 kg)	—
2 5/8 inches (6.7 cm)	500 lbs (227 kg)	—

If the difference becomes more than indicated in the table, distribute the load or remove cargo as needed.

Index



■ How to weigh the trailer loads using the public scale

Check each weight in the order indicated as shown.

Refer to the table on the right for each weight's limit except for the tongue load.

➤ **Tongue load P. 310**

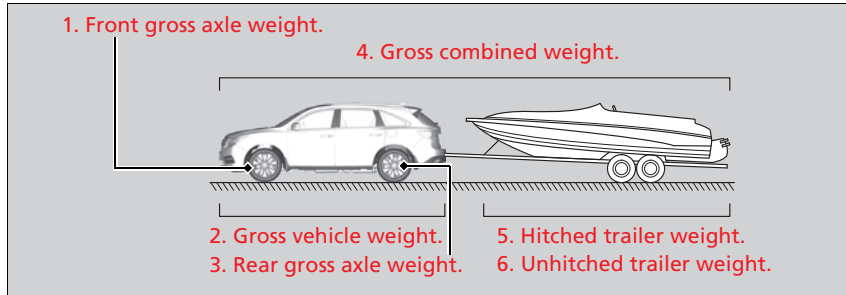

- If you cannot weigh the rear axle, subtract 1 from 2.
- The maximum gross combined weight (4) decreases by 2% for every 1,000 feet (305 meters) of elevation.
- To calculate the tongue load, subtract 5 from 6.
- Refer to the trailer owner's manual for additional information.

☒ How to weigh the trailer loads using the public scale

Fully load the vehicle and trailer. An attendant who watches the scale is needed as all occupants should stay in the vehicle.

Weight limit for	2WD models	4WD models
Front gross axle	2,811 lbs (1,275 kg)	2,910 lbs (1,320 kg)
Gross vehicle	5,368 lbs (2,435 kg)	5,677 lbs (2,575 kg)
Rear gross axle	2,734 lbs (1,240 kg)	2,965 lbs (1,345 kg)
Gross combined	8,036 lbs (3,645 kg)	9,833 lbs (4,460 kg)

If a public scale is not available, add the estimated weight of your cargo load to the weight of your trailer (as quoted by the manufacturer), and then measure the tongue load with an appropriate scale or tongue gauge or estimate it based on cargo distribution.

■ Towing Equipment and Accessories

Towing generally requires a variety of supplemental equipment. To ensure the best quality, we recommend that you purchase Acura equipment whenever possible.

☒ Towing Equipment and Accessories

Make sure that all equipment is properly installed and maintained, and that it meets federal, state, province/territory, and local regulations.

Consult your trailer maker for proper installation and setup of the equipment.

Improper installation and setup can affect the handling, stability, and braking performance of your vehicle.

Consult your trailer sales or rental agency if any other items are recommended or required for your towing situation.

The lighting and wiring of trailers can vary by type and brand. If a connector is required, it should only be installed by a qualified technician.

Trailer packages and products:

- Ball mount, hitch plug, hitch pin etc.
- Wiring harness kit
- Trailer hitch kit (jumper harness included)
 - ▶ [Trailer brakes P. 314](#)
- Automatic transmission cooler kit
 - ▶ [Automatic transmission cooler P. 316](#)

Are available at a dealer.

■ Trailer brakes

Recommended for any trailer with a total weight of 1,000 lbs (450 kg) or more: There are two common types of trailer brakes: surge and electric. Surge brakes are common for boat trailers, since the brakes will get wet.

If you choose electric brakes, be sure they are electronically actuated. Do not attempt to attach trailer brakes to your vehicle's hydraulic system, as it will lower braking effectiveness and create a potential hazard.

The 4-pin gray connector installed in your vehicle has all of the circuits required to install most electric trailer brake controllers.

►► Trailer brakes

The 4-pin gray connector is located under the instrument panel near the top of the parking brake pedal.

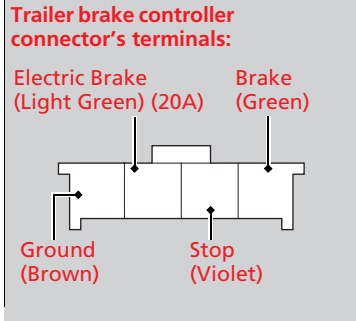

Have a qualified mechanic install your trailer brake controller following the trailer brake controller manufacturer's instructions. Failure to properly install the trailer brake controller may increase the distance it takes for you to stop your vehicle when towing a trailer.

Trailer light

Trailer lights and equipment must comply with federal, state, province/territory, and local regulations. Check with your local trailer sales or rental agency for the requirements in the area where you plan to tow.

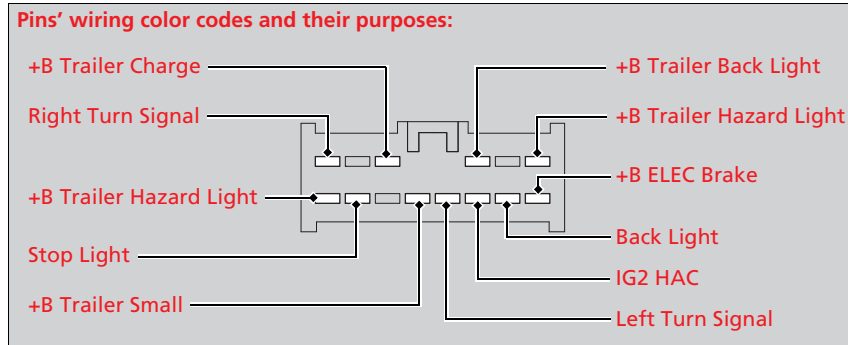

We recommend that you have a dealer install a Acura wiring harness and converter. They are designed for your vehicle.

Trailer light

The trailer lighting connector is located behind the left side panel in the cargo area. Even if you are planning to use the non-Acura trailer lighting harness and converter, ask a dealer for the correct connector and pins.

■ Hitches

Read the trailer manufacturer's instructions, and select the appropriate draw bar for the height of the trailer you will be towing.

■ Weight distribution hitches

Your vehicle is designed to tow without the need for a load distributing hitch. If you wish to use one, please consult your trailer maker for proper installation and set-up. Improper set-up could degrade the handling, stability, and braking performance of your vehicle.

■ Safety chains

Always use safety chains when you tow a trailer. Leave enough slack to allow the trailer to turn corners easily, but do not allow the chains to drag on the ground.

■ Sway control

This device can be used if your trailer tends to sway. Your trailer maker can tell you what kind of sway control you need and how to install it. Improper installation could degrade the handling and stability of your vehicle.

■ Automatic transmission cooler

Install an additional ATF (automatic transmission fluid) cooler to help prevent the transmission from overheating, and damaging. You can get the additional ATF cooler at a dealer.

4WD models

An additional ATF cooler is required to keep the transmission from overheating when towing more than 3,500 lbs (1,588 kg). You can get the additional ATF cooler at a dealer.

■ Trailer mirrors

Many states, provinces and territories require special exterior mirrors when towing a trailer. Install special mirrors whenever you cannot clearly see behind you, or if the trailer creates a blind spot.

Trailer Stability Assist*

Helps to stabilize the vehicle and trailer when the trailer severely sways.

■ How trailer stability assist works

When the vehicle and trailer become unstable while driving, trailer stability assist determines the cause. If the trailer oscillation is detected as the cause, and the swaying increases, the system applies the brakes or controls engine output to reduce vehicle speed.

Both the vehicle and trailer brake lights come on automatically if you brake to reduce vehicle speed.

☒ Trailer Stability Assist*

Trailer stability assist is not a function that prevents the vehicle and trailer from swaying. Avoid high speeds, abrupt steering, improper trailer load, and sudden braking to keep the trailer from swaying. When swayed too severely, the system becomes ineffective, and you may lose control of your vehicle, causing the trailer to roll over or get damaged.

➤ [Driving Safely with a Trailer P. 318](#)

Trailer towing sway is caused by:

- Crosswinds
- Improper towbar down load
- Excessive Speed

The VSA® system indicator blinks during the trailer stability assist operation.

➤ [VSA® Operation P. 358](#)

Driving Safely with a Trailer

■ Things You Need To Know Before Towing a Trailer

- Have the trailer properly serviced and keep it in good condition.
- Make sure that all the weights and load in the vehicle and trailer are within limits.
 - ▶ [Towing Load Limits P. 309](#)
- When towing more than 3,500 lbs (1,590 kg), use of gasoline with a pump octane number of 91 or higher is recommended.
 - ▶ Towing performance can be affected by high altitude, high temperature, or steep uphill.
- Securely attach the hitch, safety chains, and other necessary parts to the trailer.
- Securely store all the items in and on the trailer so that they do not shift while driving.
- Check if the lights and brakes on the trailer are working properly.
- Check the pressures of the trailer tires, including the spare.

■ Towing Speeds and Gears

- Drive slower than normal.
- Obey posted speed limits for vehicles with trailers.
- Use the  position when towing a trailer on level roads.

■ Turning and Braking

- Turn more slowly and with a wider turning arc than normal.
- Allow more time and distance for braking.
- Do not brake or turn suddenly.

▶▶ Driving Safely with a Trailer

Parking

In addition to the normal precautions, place wheel chocks at each of the trailer's tires.

▶▶ Towing Speeds and Gears

When towing a fixed-sided trailer (e.g., camper), do not exceed 55 mph (88 km/h).

At higher speeds, the trailer may sway or affect vehicle handling.

Driving in Hilly Terrain

- Monitor your temperature gauge. If it nears the red (Hot) mark, turn off the climate control system and reduce speed. Pull to the side of the road safely to cool down the engine if necessary.
- Shift to the **S** position if the transmission shifts frequently.

Retrieving a Boat

If the vehicle tires slip when retrieving a boat from the water, keep the transmission in **D** and do not use the sequential shift mode in **S**. This prevents damage to the transmission.

Towing Your Vehicle

Your vehicle is not designed to be towed behind a motor home. If your vehicle needs to be towed in an emergency, refer to the emergency towing information.

[Emergency Towing](#) P. 475

General Information

Your vehicle has been designed primarily for use on pavement, however, its higher ground clearance allows you to occasionally travel on unpaved roads. It is not designed for trail-blazing, or other challenging off-road activities.

If you decide to drive on unpaved roads, you will find that it requires somewhat different driving skills and that your vehicle will handle somewhat differently than it does on pavement. Pay attention to the precautions and tips in this section, and get acquainted with your vehicle before leaving the pavement.

Important Safety Precautions

To avoid loss of control or rollover, be sure to follow all precautions and recommendations:

- Be sure to store cargo properly and do not exceed your cargo load limits.
[▶ Maximum Load Limit P. 307](#)
- Whenever you drive, make sure you and your passengers always wear seat belts.
- Keep your speed low, and never go faster than the conditions allow.
- It's up to you to continually assess the situation and drive within the limits.

Off-Highway Driving Guidelines

⚠ WARNING

Improperly operating this vehicle on or off pavement can cause a crash or rollover in which you and your passengers can be seriously injured or killed.

- Follow all instructions and guidelines in this owner's manual.
- Keep your speed low, and don't drive faster than conditions permit.

Failure to operate your vehicle correctly might result in a crash or a rollover.

- ▶ [Important Handling Information P. 28](#)
- ▶ [Precautions While Driving P. 327](#)

Spinning the tires can also damage the SH-AWD system.

Avoiding Trouble

- **Check Out Your Vehicle** before you leave the pavement and make sure that all scheduled maintenance has been completed. Pay special attention to the condition of the tires, and check the tire pressures.
- **Remember** the route you choose presents limits (too steep or bumpy), you have limits (driving skill and comfort), and your vehicle has limits (traction, stability, and power). Failing to recognize these limits will likely put you and your passengers in a hazardous situation.
- **Accelerating and Braking** should be done slowly and gradually. Trying to start or stop too fast can cause a loss of traction and you could lose control.
- **Avoiding Obstacles and Debris** in the road reduces the likelihood of a rollover or damage to your suspension or other components.
- **Driving on Slopes** increases your risk of a rollover, particularly if you attempt to drive across a slope that is too steep. Going straight up or down a slope is usually the safest. If you can't clearly see all conditions or obstacles on a slope, walk it before you drive it. If there is any doubt whether you can safely pass, don't try it. Find another route. If you get stuck when climbing, do not try to turn around. Back down slowly following the same route you took up the hill.
- **Crossing a Stream** - Avoid driving through deep water. If you encounter water in your route (a small stream or large puddle, for example), evaluate it carefully before going ahead. Make sure it is shallow, flowing slowly, and has firm ground underneath. If you are not sure of the depth or the ground, turn around and find another route. Driving through deep water can also damage your vehicle. The water can get into the transmission and differential, diluting the lubricant and causing an eventual failure. It can also wash the grease out of the wheel bearings.
- **If You Get Stuck**, carefully go in the direction that you think will get you unstuck. Do not spin the tires as this will only make things worse and could damage the transmission. If you are unable to free yourself, your vehicle will need to be towed. Front and rear tow hooks are provided for this purpose.

Starting the Engine

QRG

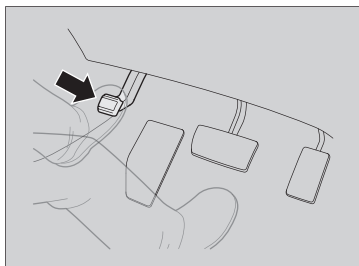

1. Make sure the parking brake is applied.

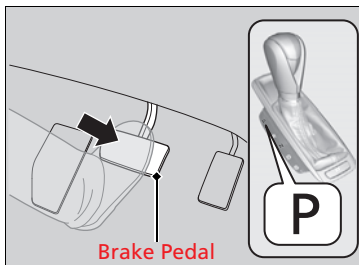

2. Check that the shift lever is in **P**, then depress the brake pedal.
 - ▶ Although it is possible to start the vehicle in **N**, it is safer to start it in **P**.

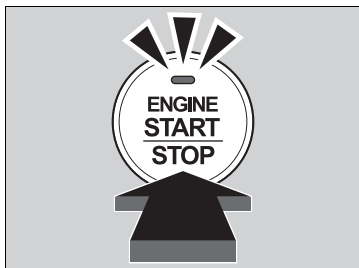

3. Press the **ENGINE START/STOP** button without depressing the accelerator pedal. The engine will crank until it starts.

Starting the Engine

Keep your foot firmly on the brake pedal when starting the engine.

The engine is harder to start in cold weather and in thinner air found at altitudes above 8,000 feet (2,400 meters).

When starting the engine in cold weather, turn off all electrical accessories such as the lights, climate control system, and rear defogger in order to reduce battery drain.

If you live in a region where winter is extremely cold, an engine block heater will improve starting and warming of the engine. If temperatures consistently below -22°F (-30°C) are expected, the coolant mixture should be changed to a higher concentration to prevent freezing. Consult a dealer for details. If the exhaust system sounds abnormal or you can smell exhaust gas inside the vehicle, have your vehicle checked by a dealer. There may be a problem with the engine or exhaust system.

Bring the keyless access remote close to the **ENGINE START/STOP** button if the battery in the keyless access remote is weak.

If the Keyless Access Remote Battery is Weak P. 458

The engine may not start if the keyless access remote is subjected to strong radio waves.

Do not hold the **ENGINE START/STOP** button to start the engine.

If the engine does not start, wait at least 10 seconds before trying again.

TOC

Driving

Index

Home

Stopping the Engine

You can turn the engine off when the vehicle is completely stopped.

1. Shift to **P**.
2. Press the **ENGINE START/STOP** button with your foot on the brake pedal.

Starting the Engine

The immobilizer system protects your vehicle from theft.

If an improperly coded device is used, the engine's fuel system is disabled.

[▶ Immobilizer System P. 135](#)



■ Remote Engine Start with Vehicle Feedback*

You can remotely start the engine using the two-way keyless access remote from distances up to 328 feet (100 meters) from the vehicle.

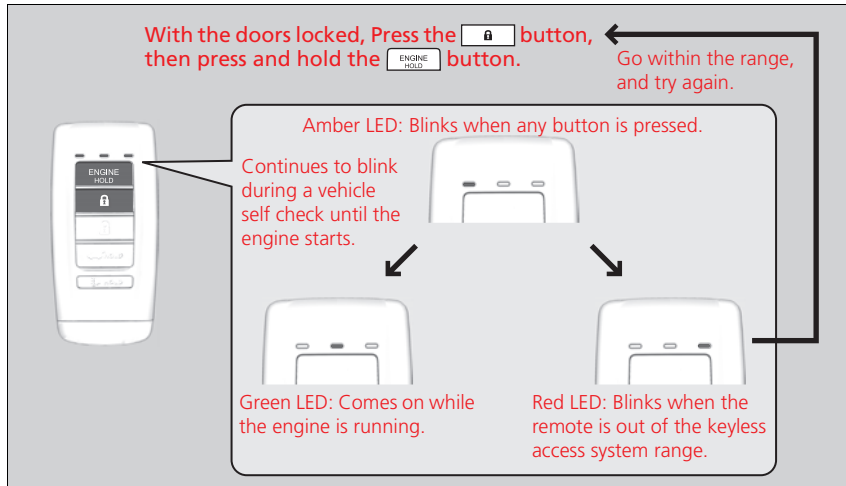
■ To start the engine



The engine runs for up to 10 minutes without you starting the vehicle.

To extend the run time for another 10 minutes during the first run, press the  button, then press and hold the  button.

▶ The amber LED blinks, then the green LED comes back on if a 10-minute extension request was transmitted successfully.

After pressing the (lock) button, wait for the green LED to blink. This indicates that all the doors and the tailgate are locked.

* Not available on all models

⊠ Remote Engine Start with Vehicle Feedback*

WARNING: Carbon monoxide gas is toxic and can rapidly accumulate in closed or even partly enclosed areas.

Breathing it can cause unconsciousness and even kill you.

Never use the remote engine starter with the vehicle parked in a garage or other areas with limited ventilation.

Operate the remote in an open space from distances up to 328 feet (100 meters) from the vehicle. If there are buildings and obstacles between your vehicle and the remote, the range will be reduced.

This distance may vary by external electrical interference.

The engine may not start by the remote engine start if:

- You have disabled a remote engine start setting using the multi-information display (MID).
- The power mode is not in VEHICLE OFF (LOCK).
- The shift lever is in a position other than **P**.
- The hood is open, or any door or the tailgate is unlocked.
- You have already used the remote twice to start the engine.
- Another registered keyless access remote is in the vehicle.
- There is any antenna failure.
- Door is unlocked with the built-in key.

■ To stop the engine

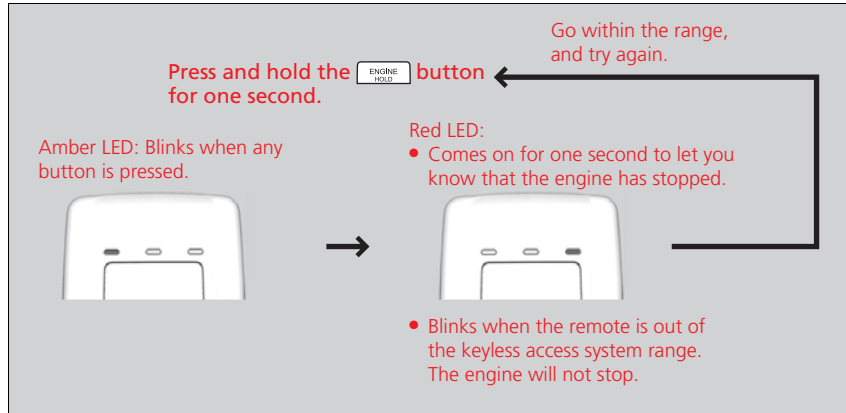

▶▶ Remote Engine Start with Vehicle Feedback*

- The engine oil pressure is low.
- The engine coolant temperature is extremely high.
- The telematics unit malfunctions.
- The security system alarm is not set.

Before starting the engine, make sure to check the door lock status using the remote. When you press the  button, wait for the green LED to blink. If the red LED turns on, the doors and tailgate did not lock, and the engine does not start.

While the engine is running, the vehicle will automatically precondition inside the vehicle.

When it is warm outside:

- The air conditioning is activated in recirculation mode.
- The seat ventilation is activated*.

When it is cold outside:

- The defroster is activated at a moderately warm temperature.
- The rear defogger and door mirror heaters are activated.
- The seat and heated steering wheel are activated*.

▶ [Heated Steering Wheel*](#) P. 181

▶ [Front Seat Heaters and Seat Ventilation*](#) P. 182

P. 183

* Not available on all models

■ Starting to Drive

When the engine was started using the two-way keyless access remote*

1. Depress the brake pedal and press the **ENGINE START/STOP** button simultaneously.

When the engine was started in any case

2. Keeping your right foot on the brake pedal, release the parking brake. Check that the parking brake indicator has gone off.
 **Parking Brake** P. 367
3. Put the shift lever in **[D]**. Select **[R]** when reversing.

4. Gradually release the brake pedal and gently depress the accelerator pedal to pull away.

■ Hill start assist system

Hill start assist keeps the brake engaged briefly to help prevent the vehicle from rolling on inclines as you move your foot from the brake pedal to the accelerator.

Move the shift lever to **[D]** or **[S]** when facing uphill, or **[R]** when facing downhill, then release the brake pedal.

The brakes remain engaged briefly as you release the brake pedal.

▶ Starting to Drive

When the engine was started using the two-way keyless access remote*

The engine stops when the shift lever is moved out of **[P]** before the **ENGINE START/STOP** button is pressed. Follow the step 1 when starting to drive.

▶ Hill start assist system

Hill start assist may not prevent the vehicle from rolling downhill on a very steep or slippery slope, and will not operate on small inclines.

Hill start assist is not a replacement for the parking brake.

Precautions While Driving

Driving Guidelines for Your Utility Vehicle

Utility vehicles have a significantly higher rollover rate than other types of vehicles.

To prevent rollovers or loss of control:

- Take corners at slower speeds than you would with a passenger vehicle.
- Avoid sharp turns and abrupt maneuvers whenever possible.
- Do not modify your vehicle in any way that you would raise the center of gravity.
- Do not carry heavy cargo on the roof.

In Rain

Avoid driving in deep water and on flooded roads. This can damage the engine, driveline, or cause electrical component failure.

Other Precautions

If there is a strong impact with something under the vehicle, stop in a safe location. Check the underside of the vehicle for damage or any fluid leaks.

Precautions While Driving

NOTICE

Do not operate the shift lever while pressing the accelerator pedal. You could damage the transmission.

NOTICE

If you repeatedly turn the steering wheel at an extremely low speed, or hold the steering wheel on the full left or right position for a while, the system heats up. The system goes into a protective mode, and limits its performance. The steering wheel becomes harder and harder to operate. Once the system cools down, the EPS system is restored. Repeated operation under these conditions can eventually damage the system.

If the power mode is set to ACCESSORY or VEHICLE OFF (LOCK) while driving, the engine will shut down and all steering and brake power assist functions will stop, making it difficult to control the vehicle.

Do not put the shift lever in **N**, as you will lose engine braking (and acceleration) performance.

During the first 600 miles (1,000 km) of operation, avoid sudden acceleration or full throttle operation so as not to damage the engine or powertrain.

Avoid hard braking for the first 200 miles (300 km). You should also follow this when the brake pads are replaced.

Automatic Transmission

■ Creeping

The engine runs at a higher idle speed and creeping increases. Keep the brake pedal firmly depressed when stopped.

■ Kickdown

Quickly depressing the accelerator pedal while driving uphill may cause the transmission to drop to a lower gear, unexpectedly increasing vehicle speed. Depress the accelerator pedal carefully, especially on slippery roads and curves.

» Driving Guidelines for Your Utility Vehicle

Failure to operate your vehicle correctly might result in a crash or a rollover.

- ▶ [Important Handling Information P. 28](#)
- ▶ [Precautions While Driving P. 327](#)

Shifting

Change the shift position in accordance with your driving needs.

■ Shift lever positions

Release Button

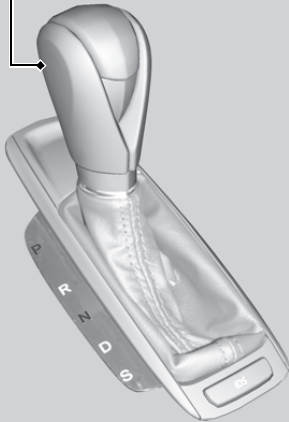

P **Park**
Used when parking or starting the engine

R **Reverse**
Used when reversing

N **Neutral**
Used when idling

D **Drive**
Used:

- For normal driving (gears change between 1st and 6th automatically)
- When temporarily driving in the sequential mode

S **Drive (S)**
Used for:

- Automatically changing gears between 1st and 5th (5th gear is used only at high speed)
- Driving in the sequential mode

▶ Shifting

You cannot change the power mode from ON to VEHICLE OFF (LOCK) unless the shift lever is in **P**.

The vehicle may move forward very slightly even in **N** while the engine is cold.

Depress the brake pedal firmly and, when necessary, apply the parking brake.

When shifting gears in extremely low temperatures (-22°F/-30°C), there may be a short delay before the shift indicated in the display. Always confirm you are in the correct gear before driving.

Continued

■ Shift Lever Operation

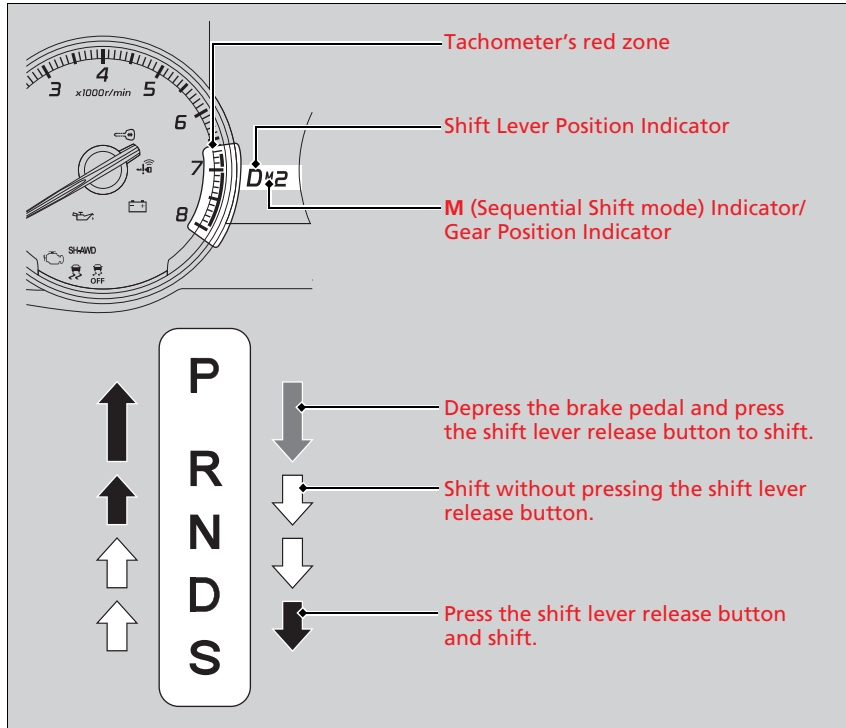

▶ Shift Lever Operation

NOTICE

When you change the shift lever from **D** to **R** and vice versa, come to a complete stop and keep the brake pedal depressed.

Operating the shift lever before the vehicle has come to a complete standstill can damage the transmission.

Use the shift lever position indicator to check the lever position before pulling away.

Whichever position the shift lever is in when driving, a blinking transmission indicator indicates a transmission problem.

Avoid sudden acceleration and have the transmission checked by a dealer as soon as possible.

The fuel supply may be cut off if you drive at engine speeds in or over the tachometer's red zone (engine speed limit). If this happens, you may experience a slight jolt.

It may not be possible to operate the shift lever if the brake pedal is applied while the shift lever release button is held down.

Depress the brake pedal first.

Sequential Shift Mode

Use the paddle shifters to change between 1st and 6th gears without removing your hands from the steering wheel. The transmission will switch to the sequential shift mode.

■ When the shift lever is in **D**:

The vehicle will go into the sequential shift mode momentarily, and the gear position indicator will come on.

Once you start traveling at a constant speed, the sequential shift mode will automatically switch off, and the gear position indicator will go off.

Hold the **+** paddle shifter for two seconds to return to normal drive.

■ When the shift lever is in **S**:

The vehicle will go into the sequential shift mode, and the **M** (sequential shift mode) indicator and gear position indicator will come on. At speeds of 6 mph (10 km/h) or less, the vehicle automatically shifts down into 1st gear. If you do not operate the paddle shifters while in 1st gear, the transmission automatically shifts up to 2nd gear.

You can only pull away in 1st or 2nd gear.

When switching out of the sequential shift mode, move the shift lever from **S** to **D**. When the sequential shift mode is canceled, the **M** indicator and gear position indicator go off.

■ Second gear lock mode

If you pull the **+** paddle shifter while stopped or driving at 6 mph (10 km/h) or less, the gear position will be locked in 2nd gear. This makes it easier to pull away on slippery surfaces such as snow covered roads.

To cancel the 2nd gear lock mode, pull the **-** paddle shifter, or move the shift lever from **S** to **D**.

■ Sequential Shift Mode Operation

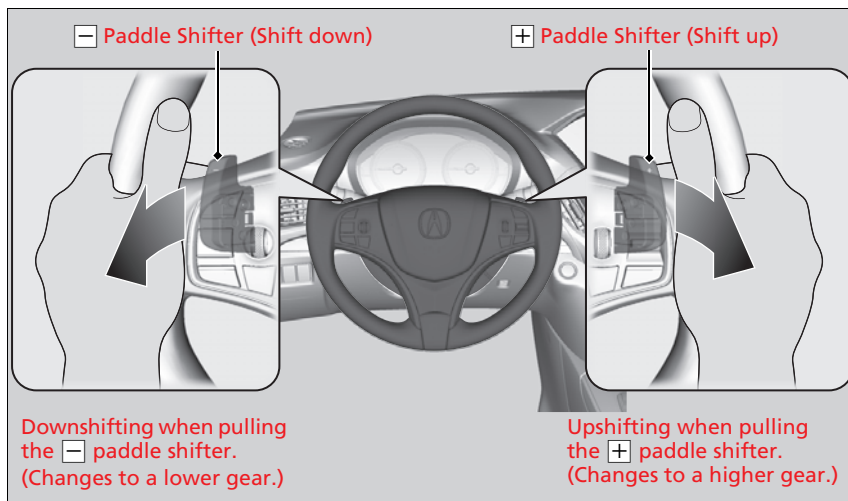

▣ Sequential Shift Mode Operation

Each paddle shift operation makes a single gear change.

To change gears continuously, release the paddle shifter before pulling it again for the next gear.

Recommended Shift Points

Use this table as a guideline for efficient fuel economy and effective emission control.

Shift Up	Normal Acceleration
1st to 2nd	15 mph (24 km/h)
2nd to 3rd	25 mph (40 km/h)
3rd to 4th	40 mph (64 km/h)
4th to 5th	45 mph (72 km/h)
5th to 6th	50 mph (80 km/h)

The gear position indicator blinks when you cannot shift up or down. It indicates that your vehicle speed is not in its allowable gear shifting range.

Slightly accelerate to shift up and decelerate to shift down while the indicator is blinking.

Integrated Dynamics System (IDS)

Modifies the dynamic character of the vehicle. There are three **IDS** modes to select from: **Comfort**, **Normal**, and **Sport**.

Press the IDS button to select a mode. The mode you have selected appears on the MID.

You can customize the IDS mode default setting using the MID.

[Customized Features P. 104](#)

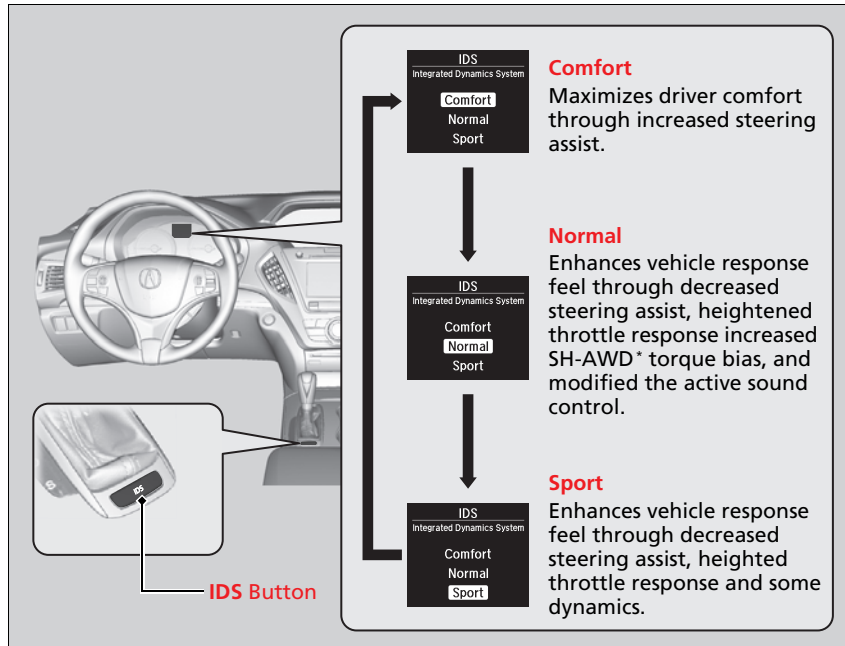

* Not available on all models

Cruise Control

Maintains a constant vehicle speed without having to keep your foot on the accelerator. Use cruise control on freeways or open roads where you can travel at a constant speed with little acceleration or deceleration.

When to use

■ **Vehicle speed for cruise control:**
Desired speed in a range above roughly 25 mph (40 km/h) ~

Always keep sufficient distance between you and the vehicle in front of you.

■ **Shift positions for cruise control:**
In **D** or **S**



How to use

■ Press the **CRUISE** button on the steering wheel.

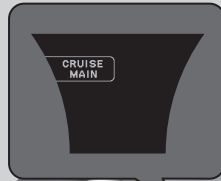

CRUISE MAIN is on in the instrument panel.
Cruise control is ready to use.

⌘ Cruise Control

⚠ WARNING

Improper use of the cruise control can lead to a crash.

Use the cruise control only when traveling on open highways in good weather.

It may not be possible to maintain a constant speed when driving uphill or downhill.

When not using cruise control:
Turn off cruise control by pressing the **CRUISE** button.

■ To Set the Vehicle Speed

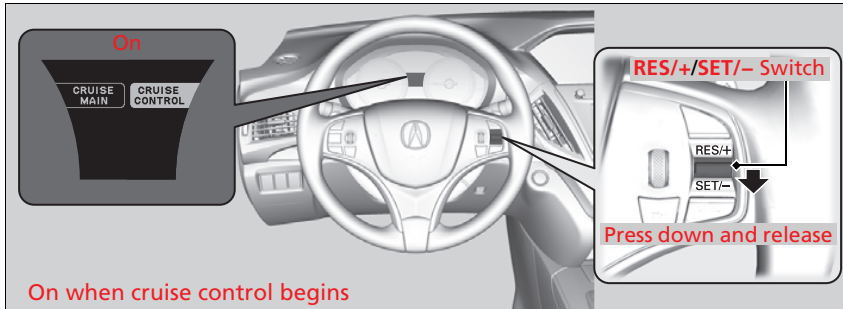

Take your foot off the pedal and press the **RES/+ / SET/-** switch down when you reach the desired speed.

The moment you release the **RES/+ / SET/-** switch, the set speed is fixed, and cruise control begins. The **CRUISE CONTROL** indicator comes on.

■ To Adjust the Vehicle Speed

Increase or decrease the vehicle speed using the **RES/+**/**SET/-** switch on the steering wheel.

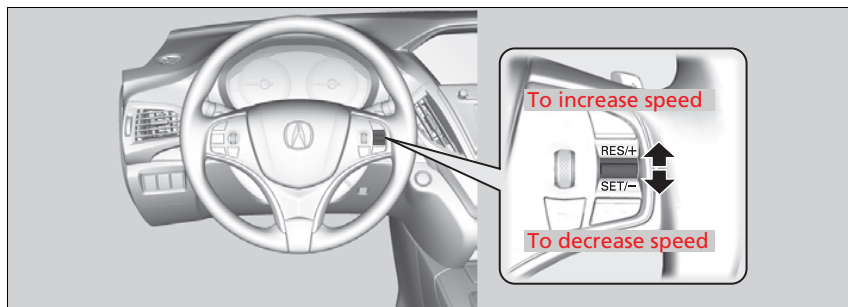

- Each time you press the switch up or down, the vehicle speed is increased or decreased by about 1 mph or 1 km/h accordingly.
- If you keep the switch pressed up or down, the vehicle speed increases or decreases until you release it. This speed is then set.

■ To Cancel

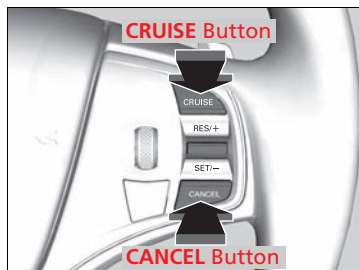

To cancel cruise control, do any of the following:

- Press the **CANCEL** button.
- Press the **CRUISE** button.
- Depress the brake pedal.

The **CRUISE CONTROL** indicator goes off.

▶▶ To Adjust the Vehicle Speed

You can set the vehicle speed pressing the **RES/+**/**SET/-** switch down on the steering wheel when adjusting the speed with the accelerator and brake pedals.

▶▶ To Cancel

Resuming the prior set speed:

After cruise control has been canceled, you can still resume the prior set speed by pressing the **RES/+**/**SET/-** switch up while driving at a speed of at least 25 mph (40 km/h) or more.

You cannot set or resume in the following situations:

- When vehicle speed is less than 25 mph (40 km/h)
- When the **CRUISE** button is turned off

At vehicle speeds of 22 mph (35 km/h) or less, cruise control is canceled automatically.

Adaptive Cruise Control (ACC) with Low Speed Follow (LSF)*

Helps maintain a constant vehicle speed and a set following distance behind a vehicle detected ahead of yours and, if the detected vehicle comes to a stop, decelerates and stops your vehicle, without you having to keep your foot on the brake or the accelerator.

ⓘ Adaptive Cruise Control (ACC) with Low Speed Follow (LSF)*

⚠ WARNING

Improper use of ACC with LSF can lead to a crash.

Use ACC with LSF only when driving on expressways or freeways and in good weather conditions.

⚠ WARNING

Exiting a vehicle that has been stopped while the ACC with LSF system is operating can result in the vehicle moving without operator control.

A vehicle that moves without operator control can cause a crash, resulting in serious injury or death.

Important Safety Reminder

As with any system, there are limits to ACC with LSF. Inappropriate use of ACC with LSF can result in a serious accident. Use the brake pedal whenever necessary, and always keep a safe distance between your vehicle and other vehicles.

The radar sensor for ACC with LSF is shared with the collision mitigation braking system™ (CMBS™).

➤ **Collision Mitigation Braking System™ (CMBS™)* P. 371**

When to use

The radar sensor is in the front grille.

- Vehicle speed for ACC with LSF: A vehicle is detected ahead within ACC with LSF range – ACC with LSF operates at any vehicle speed. No vehicle is detected within ACC with LSF range – ACC with LSF operates at the speed of 25 mph (40km/h) or above.
- Shift positions for ACC with LSF: In **D** or **S**.

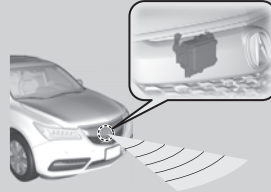

How to use

- Press the **MAIN** button on the steering wheel.

ACC (green) is on in the instrument panel. ACC with LSF is ready to use.

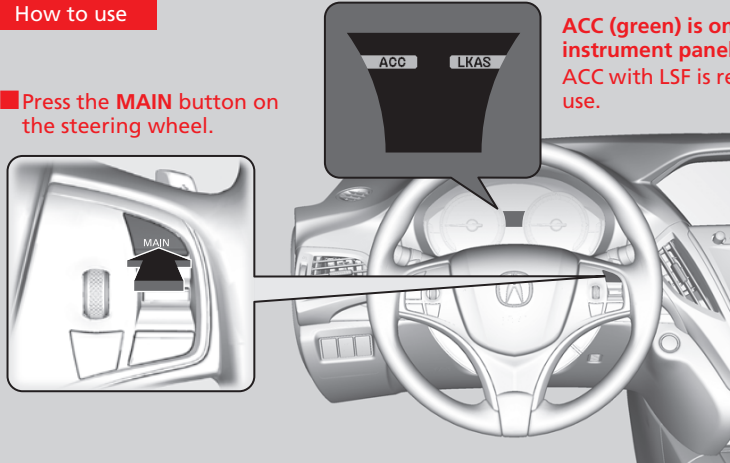

* Not available on all models

■ To Set the Vehicle Speed

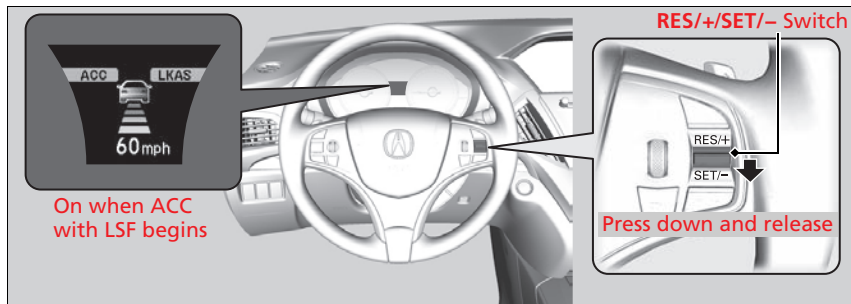

When driving at 25 mph (40 km/h) or above: Take your foot off the pedal and press down the **RES/+SET/-** switch when you reach the desired speed. The moment you release the switch, the set speed is fixed, and ACC with LSF begins.

When driving at slower than 25 mph (40 km/h): You can set the vehicle speed only when there is a vehicle detected ahead of you. If the vehicle is moving and the brake pedal is not depressed, pressing the switch fixes the set speed to 25 mph (40 km/h) regardless of current vehicle speed. If the vehicle is stationary, you can set the vehicle speed even with the brake pedal depressed.

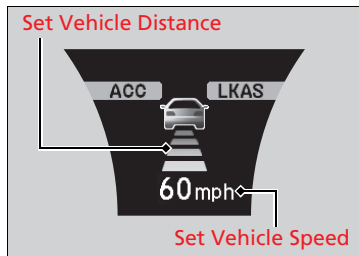

When ACC with LSF starts operating, the vehicle icon, distance bars and set speed appear on the MID.

▶ Adaptive Cruise Control (ACC) with Low Speed Follow (LSF)*

When the **MAIN** button is pressed, ACC with LSF and Lane Keeping Assist System (LKAS) are both turned on or off.

Do not use ACC with LSF under these conditions:

- In poor visibility (e.g., bad weather, such as rain, fog, and snow).
- When you must slow down and speed up repeatedly.
- On winding roads.
- When you enter a toll gate, interchange, service area, parking area, etc. In these areas, there is no vehicle ahead of you, but ACC with LSF would still try to accelerate to your set speed.
- On a slippery road (for example a road covered with ice or snow).
- When a spare tire* is installed.
- When going down a steep hill where the engine braking does not work sufficiently.

When not using ACC with LSF: Turn off adaptive cruise by pressing the **MAIN** button. This also will turn off the Lane Keeping Assist System (LKAS).

▶ To Set the Vehicle Speed

You can switch the displayed set speed measurements on the MID between mph and km/h.

[▶ Customizable Features P. 107](#)

■ When in Operation

■ There is a vehicle ahead

ACC with LSF monitors if a vehicle ahead of you enters the ACC with LSF range. If it does, the ACC with LSF system maintains or decelerates your vehicle's set speed in order to keep the vehicle's set following distance from the vehicle ahead.

[▶ To Set or Change Following Distance P. 342](#)

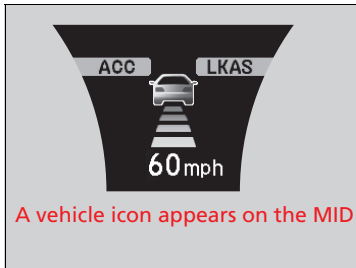
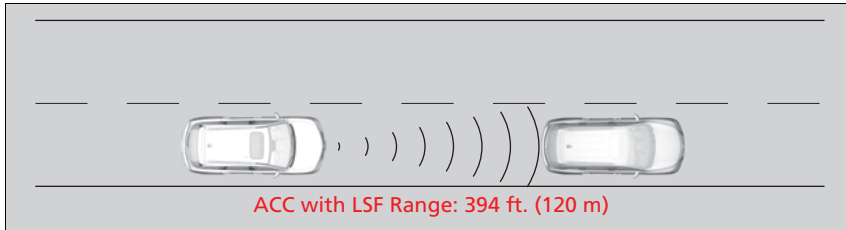

When a vehicle whose speed is slower than your set speed comes in front of you, your vehicle starts to slow down.

▶▶ When in Operation

If the vehicle ahead of you slows down abruptly, or if another vehicle cuts in front of you, the beeper sounds and a message appears on the multi-information display to alert you.

Depress the brake pedal, and keep an appropriate distance from the vehicle ahead.

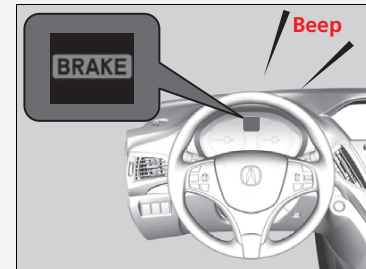

Even if the distance between your vehicle and the vehicle ahead is short, ACC with LSF may start accelerating your vehicle under the following circumstances:

- The vehicle ahead of you is going at almost the same speed as, or faster than, your vehicle.
- A vehicle that cuts in front of you is going faster than your vehicle, gradually increasing the distance between the vehicles.

If you do not want to hear a beep when the system detects a vehicle, or when the vehicle goes out of the ACC with LSF range, you can change the pre-running detect car beep setting.

[▶ Customizable Features P. 107](#)

■ There is no vehicle ahead

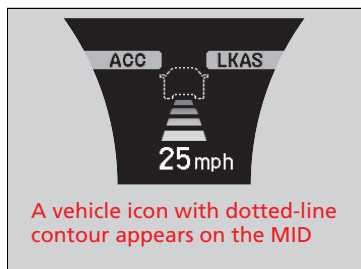

When driving at 22 mph (35 km/h) or above: Your vehicle maintains the set speed without having to keep your foot on the brake or accelerator pedal.

If there previously was a vehicle detected ahead that kept your vehicle from travelling at the set speed, ACC with LSF accelerates your vehicle to the set speed, and then maintains it.

When driving under 22 mph (35 km/h) and no vehicle is detected ahead: ACC with LSF automatically cancels. The beeper sounds once.

■ When you depress the accelerator pedal

You can temporarily increase the vehicle speed. In this case, there is no audible or visual alert even if a vehicle is in the ACC with LSF range.

ACC with LSF stays on unless you cancel it. Once you release the accelerator pedal, the system resumes the set speed.

■ A vehicle ahead is within ACC range and stops



Your vehicle also stops, automatically. The **Stopped** message appears on the multi-information display.

When the vehicle ahead of you starts again, the vehicle icon on the MID blinks. If you press the **RES/+SET/-** switch up or down, or depress the accelerator pedal, ACC with LSF operates again within the prior set speed.

⌘ When in Operation

Limitations

Use the brake pedal to maintain a safe distance with other vehicles in the following cases. ACC with LSF may not work properly when:

- A vehicle ahead of you is parked when your vehicle is moving.
- Motorcycles or other small vehicles are ahead of you.
- A vehicle cuts in front of you at a short distance.

ACC with LSF may momentarily apply brakes or sound a beep if there is a vehicle, or even a building, next to you if:

- You make a sudden turn or drive on a narrow road.
- You abruptly move the steering wheel.
- You are in an unusual position within your lane.

When your vehicle stops automatically because a vehicle detected ahead of you has stopped, the distance between the two vehicles will vary based on the ACC with LSF distance setting, as follows:

Short: 11.5 ft (3.5 m)

Middle: 14.1 ft (4.3 m)

Long, Extra Long: 16.4 ft (5.0 m)

[▶ To Set or Change Following Distance P. 342](#)

■ To Adjust the Vehicle Speed

Increase or decrease the vehicle speed using the **RES/+**/**SET/-** switch on the steering wheel.

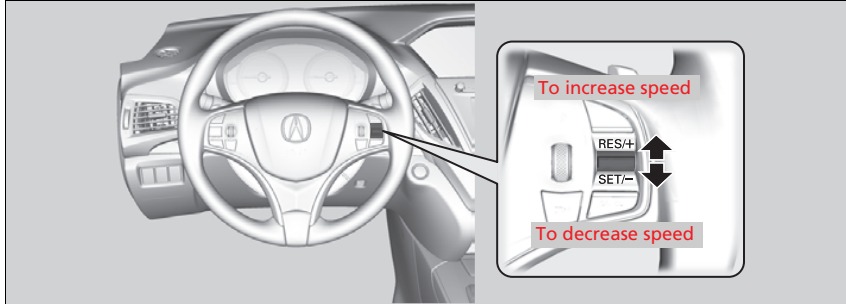

☒ To Adjust the Vehicle Speed

If a vehicle detected ahead is going at a speed slower than your increased set speed, ACC with LSF may not accelerate your vehicle. This is to maintain the set distance between your vehicle and the vehicle ahead.

- Each time you press the switch up or down, the vehicle speed is increased or decreased by about 1 mph or 1 km/h accordingly.
- If you keep the switch pressed up or down, the vehicle speed increases or decreases by about 5 mph or 5 km/h accordingly.

QRG



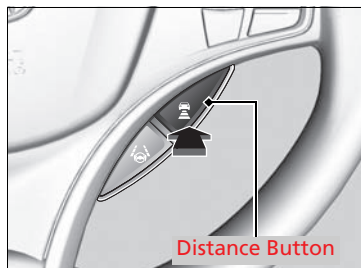

■ To Set or Change Following Distance



Press the  (distance) button to change the ACC with LSF following distance.

Each time you press the button, the following distance (the distance behind a vehicle detected ahead of you) setting cycles through short, middle, long, and extra long following distances.

The higher your selected set speed is, the longer the short, middle, long or extra long following distance becomes. See the following examples for your reference.

Following Distance		When the Set Speed is:	
		50 mph (80 km/h)	65 mph (104 km/h)
Short		83 feet 25 meters	100 feet 31 meters
Middle		110 feet 33 meters	137 feet 42 meters
Long		154 feet 47 meters	200 feet 61 meters
Extra Long		204 feet 62 meters	265 feet 81 meters

TOC

Driving

Index

Home

To Cancel

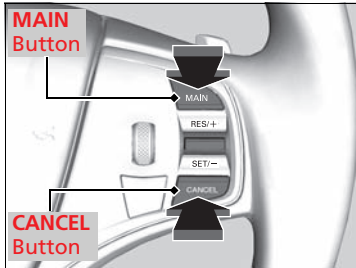

To cancel ACC with LSF, do any of the following:

- Press the **CANCEL** button.
- Press the **MAIN** button.
 - ▶ ACC with LSF indicator goes off.
- Depress the brake pedal.
 - ▶ When the LSF function has stopped the vehicle, you cannot cancel ACC with LSF by depressing the brake pedal.

To Cancel

Resuming the prior set speed: After you have canceled ACC with LSF, you can resume the prior set speed while it is still displayed. Press the **RES/+ / SET / -** switch up when driving at a speed of at least 25 mph (40 km/h) or more.

Even if your vehicle speed has gone down to less than 25 mph (40 km/h), you can still resume the prior set speed when ACC with LSF detects a vehicle ahead of you.

You cannot set or resume in the following situations:

- When the vehicle speed is less than 25 mph (40km/h) and there is no vehicle detected in front of your vehicle
- When the **MAIN** button is turned off

■ Automatic cancellation

The beeper sounds and a message appears on the MID when ACC with LSF is automatically canceled. Any of these conditions may cause the ACC with LSF to automatically cancel:

- Your vehicle speed slows to 22 mph (35 km/h) or below when a detected vehicle goes out of the ACC with LSF range.
- Bad weather (rain, fog, snow, etc.)
- When the radar sensor in the front grille gets dirty.
- The vehicle ahead of you cannot be detected.
- An abnormal tire condition is detected, or the tires are skidding.
- Driving on a mountainous road, or driving off road for extended periods.
- Abrupt steering wheel movement.
- When the ABS, VSA® or CMBS™ is activated.
- When the VSA® indicator comes on.
- When the vehicle is stopped on a very steep slope.
- When you manually apply the parking brake.
- When the detected vehicle within the ACC with LSF range is too close to your vehicle.
- The driver's seat belt is unfastened when the vehicle is stationary.
- The vehicle stops for more than 10 minutes.
- The engine is turned off.
- When trailer stability assist is activated.

 **Trailer Stability Assist* P. 317**

The ACC with LSF automatic cancellation can be also triggered by the following causes.

⌘ Automatic cancellation

Even though ACC with LSF has been automatically canceled, you can still resume the prior set speed. Wait until the condition that caused ACC with LSF to cancel improves, then press the **RES/+SET/-** switch down.

■ To Switch ACC with LSF to Cruise Control

Press and hold the  (distance) button for one second.

Cruise Mode Selected appears on the MID for two seconds, and then the mode switches to **Cruise**.

To switch back to ACC with LSF, press and hold the  button again for one second.

☒ To Switch ACC with LSF to Cruise Control

Always be aware which mode you are in. When you are driving in Cruise mode, be more cautious about keeping a safe distance from a vehicle ahead of you.

The current mode is displayed on the multi-information display.

[➤ Switching the Display P. 98](#)

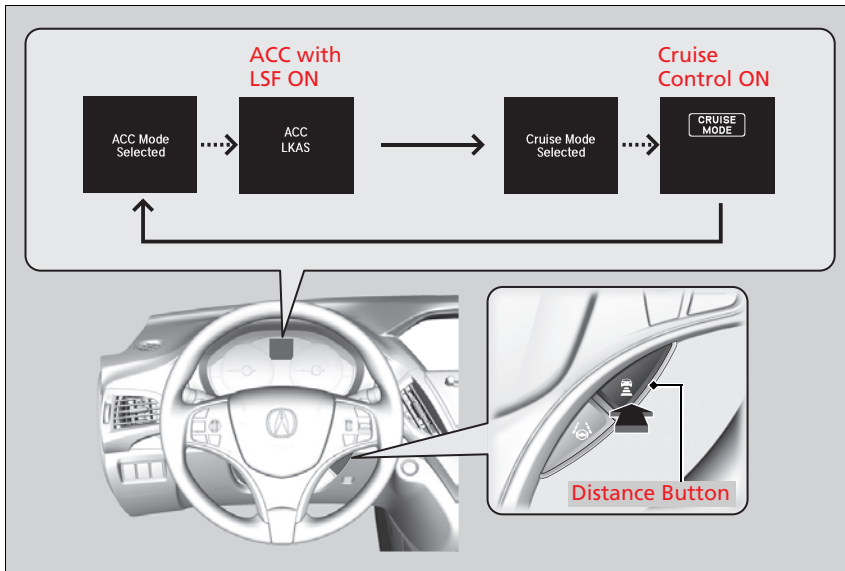

Forward Collision Warning (FCW)*

Alerts you when it detects the possibility of your vehicle colliding with the vehicle in front of yours.

If the system determines a collision is possible, it gives both visual and audible alerts.

- ▶ Take appropriate action to prevent a collision (apply the brakes, change lanes, etc.).

■ How the system works

The system may give warnings of potential collisions when your vehicle speed is above 10 mph (15 km/h).

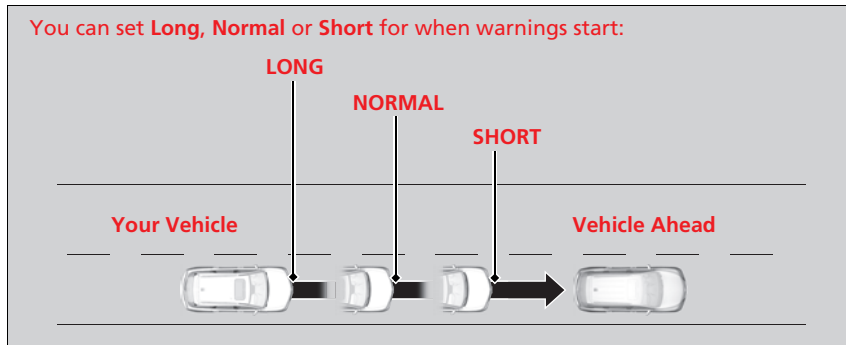

▶ Forward Collision Warning (FCW)*

Important Safety Reminder

FCW cannot detect all objects ahead and may not detect a given object; accuracy of the system will vary based on weather, speed and other factors. FCW does not include a braking function. It is always your responsibility to safely operate the vehicle and avoid collisions.

You can change the Forward Collision Warning Distance setting or turn the system on and off.

▶ [Customizable Features P. 107](#)

The camera is shared with Lane Departure Warning (LDW).

▶ [LDW Camera P. 351](#)

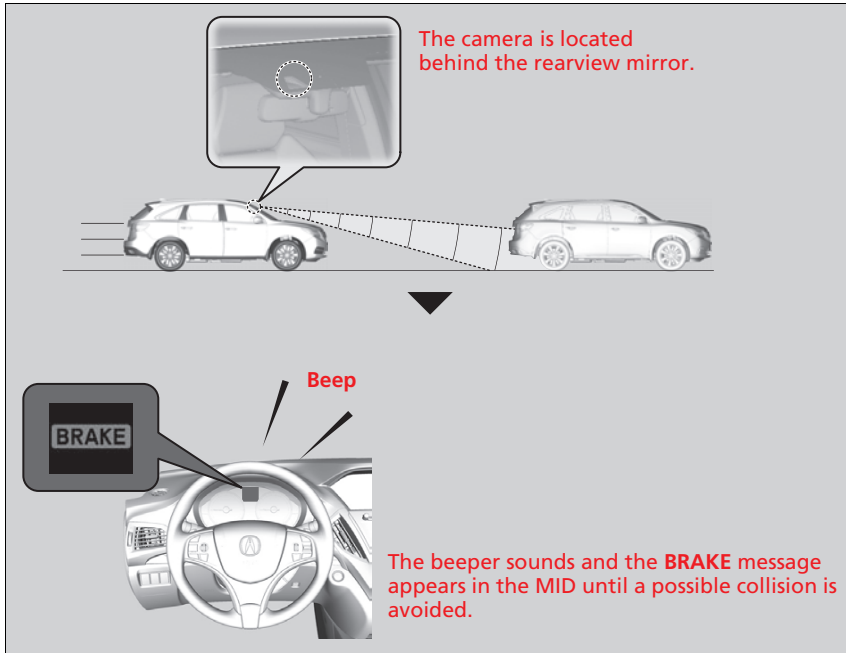

⊠ Forward Collision Warning (FCW)*

Never apply a film or attach any objects to the windshield that could obstruct the FCW camera's field of vision.

Scratches, nicks, and other damage to the windshield within the FCW camera's field of vision can cause the system to operate abnormally. If this occurs, we recommend that you replace the windshield with a genuine Acura replacement windshield. Making even minor repairs within the camera's field of vision or installing an aftermarket replacement windshield may also cause the system to operate abnormally. After replacing the windshield, have a dealer recalibrate the camera. Proper calibration of the FCW camera is necessary for the system to operate properly.

* Not available on all models

■ Automatic shutoff

FCW may automatically shut itself off and the **FCW** indicator comes and stays on when:

- The temperature inside the system is high.
- The windshield is blocked by dirt, mud, leaves, wet snow, etc.

Once the conditions that caused FCW to shut off improve or are addressed (e.g., cleaning), the system comes back on.

▶ Automatic shutoff

To help reduce the likelihood that high interior temperatures will cause the camera system to shut off, when parking, find a shady area or face the front of the vehicle away from the sun.

If you use a reflective sun shade, do not allow it to cover the camera housing. Covering the camera can concentrate heat on the camera.

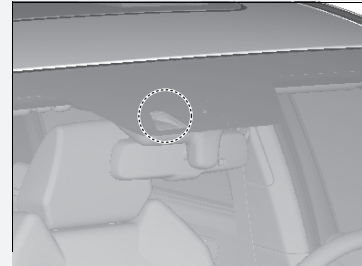

If the **Can Not Operate: Camera Too Hot** message appears:

- Use the climate control system to cool down the interior and, if necessary, the defroster mode when windows are fogged.
- Start driving the vehicle to lower the windshield temperature, which cools down the area around the FCW camera.

FCW Limitations

FCW may not activate or may not detect a vehicle in front of your vehicle, and may activate even when you are aware of a vehicle ahead of you, or when there is no vehicle ahead, under the following conditions.

Condition

- The distance between your vehicle and the vehicle ahead of you is too short.
- A vehicle cuts in front of you at a slow speed, and it brakes suddenly.
- A vehicle suddenly crosses in front of you.
- When either your vehicle or the vehicle ahead of you accelerates rapidly.
- The vehicle ahead of you is a motorcycle, a small vehicle, or a unique vehicle such as a tractor.
- When you drive off-road or on a mountain road, or curved and winding road for an extended period that makes it difficult for the sensor/camera to properly detect a vehicle in front of you.
- When there are pedestrians or animals in front of your vehicle.
- When you drive in bad weather (rain, fog, etc.).
- A heavy load in the rear or modifications to the suspension tilts your vehicle.
- An abnormal tire condition is detected (wrong tire size, flat tire, etc.).
- When the windshield is blocked by dirt, mud, leaves, wet snow, etc.
- When the temperature inside the system is high.
- A sudden change between light and dark such as an entrance or exit of a tunnel.
- You drive into the sunlight (e.g. at dawn or dusk).
- When the windshield is dirty or cloudy.
- When streetlights are perceived as the taillight of a vehicle in front of yours.
- When driving at night, the vehicle ahead of you is running with either taillight bulb burned out.
- When you drive in the shadows of trees, buildings, etc.
- When your vehicle is towing a trailer.

Lane Departure Warning (LDW)*

Alerts you when the system detects a possibility of your vehicle unintentionally crossing over left or right side lane markings.

How the System Works

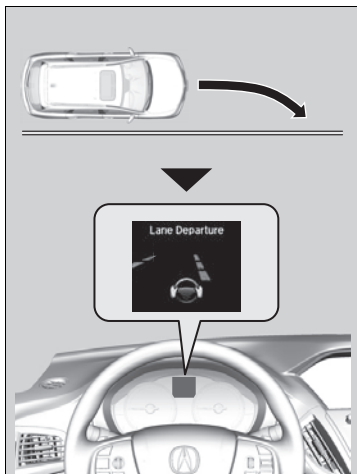

If your vehicle is getting too close to detected left or right side lane markings without a turn signal activated, LDW will give audible and visual alerts.

The beeper sounds and the **Lane Departure** message appears on the MID, letting you know that you need to take appropriate action.

How the System Activates

The system begins to search for lane markings when all the following conditions are met:

- The vehicle is traveling between 40 and 90 mph (64 and 145 km/h).
- The vehicle is on a straight or slightly curved road.
- The turn signals are off.
- The brake pedal is not depressed.

▶ Lane Departure Warning (LDW)*

Important Safety Reminder

Like all assistance systems, LDW has limitations. Over-reliance on LDW may result in a collision. It is always your responsibility to keep the vehicle within your driving lane.

LDW only alerts you when lane drift is detected without a turn signal in use. LDW may not detect all lane markings or lane departures; accuracy will vary based on weather, speed and lane marker condition. It is always your responsibility to safely operate the vehicle and avoid collisions.

▶ How the System Activates

LDW may automatically shut off and the **LDW** indicator comes and stays on.

[▶ Indicators P. 81](#)

LDW Camera

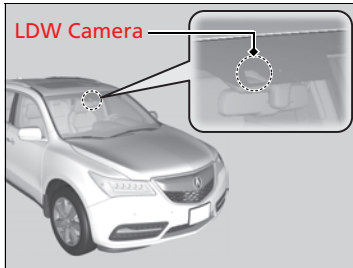

The camera is located behind the rearview mirror.

LDW On and Off

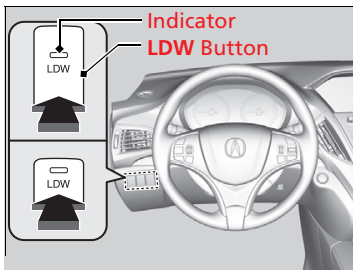

Press the **LDW** button to turn the system on and off.

- ▶ The indicator in the button comes on when the system is on.

LDW Camera

Never apply a film or attach any objects to the windshield that could obstruct the LDW camera's field of vision.

Scratches, nicks, and other damage to the windshield within the LDW camera's field of vision can cause the system to operate abnormally. If this occurs, we recommend that you replace the windshield with a genuine Acura replacement windshield. Making even minor repairs within the camera's field of vision or installing an aftermarket replacement windshield may also cause the system to operate abnormally. After replacing the windshield, have a dealer recalibrate the camera. Proper calibration of the LDW camera is necessary for the system to operate properly.

Do not place an object on the top of the instrument panel. It may reflect onto the windshield and prevent the system from detecting lane lines properly.

To help reduce the likelihood that high interior temperatures will cause the camera system to shut off, when parking, find a shady area or face the front of the vehicle away from the sun. Also, do not use a reflective sun shade that can concentrate heat on the camera.

If the **Can Not Operate: Camera Too Hot** message appears:

- Use the climate control system to cool down the interior and, if necessary, the defroster mode when windows are fogged.
- Start driving the vehicle to lower the windshield temperature, which cools down the area around the LDW camera.

LDW Limitations

LDW may not activate or may not recognize lanes, and may activate even when keeping in the middle of a lane, under the following conditions.

Condition

- When you drive in bad weather (rain, fog, etc.).
- A heavy load in the rear or modifications to the suspension tilts your vehicle.
- An abnormal tire condition is detected (wrong tire size, flat tire, etc.).
- When the windshield is blocked by dirt, mud, leaves, wet snow, etc.
- When the temperature inside the system is high.
- A sudden change between light and dark such as an entrance or exit of a tunnel.
- You drive into the sunlight (e.g. at dawn or dusk).
- When the windshield is dirty or cloudy.
- When you drive in the shadows of trees, buildings, etc.
- When your vehicle is towing a trailer.
- When you drive on a wet road surface following another vehicle.
 - ▶ The camera may perceive the tire tracks in the water as lane lines.
- When there is snow or wheel tracks on the side of the road.
- When the road has many repaired area or an erased lane line.
- When the vehicle is running over painted signs or crosswalk markings.
- When you drive in a lane with worn-out lane markings.

Lane Keeping Assist System (LKAS)*

Provides steering input to help keep the vehicle in the middle of a detected lane and provides audible and visual alerts if the vehicle is detected drifting out of its lane.

■ Audible and visual alerts
Beeps and a warning display alert you that the vehicle is drifting out of a detected lane.

■ Steering input assist
The system applies torque to the steering to keep the vehicle between the left and right lane lines. The applied torque becomes stronger as the vehicle gets closer to either of the lane lines.

■ LKAS camera
Monitors the lane lines

When you operate the turn signals to change lanes, the system is suspended, and resumes after the signals are off.
If you make a lane change without operating the turn signals, the LKAS alerts activate, and torque is applied to the steering.

☒ Lane Keeping Assist System (LKAS)*

Important Safety Reminders

The LKAS is for your convenience only. It is not a substitute for your vehicle control. The system does not work if you take your hands off the steering wheel or fail to steer the vehicle.

☒ Multi-Information Display (MID) Warning and Information Messages P. 96

Do not place an object on the top of the instrument panel. It may reflect onto the windshield and prevent the system from detecting lane lines properly.

The LKAS is convenient when it is used on freeways.

The LKAS may not work properly under the following conditions:

- Your tires are over or under inflated.
- Your tires or wheels are of varied size or construction.
- Your vehicle's suspension has been altered, changing the height of the vehicle.
- Your vehicle has heavy load in the trunk or on the rear seats.
- A compact spare tire* is mounted.
- Driving on snowy or wet roads.
- Roadway lane markers are difficult to see due to weather (rain, snow, fog, etc.) or road conditions.
- Driving on a road with temporary lane markings.
- Multiple or varied lane markings are visible on the pavement due to road repairs or old lane markings.
- Roadway objects or structures are misinterpreted as lane markers.
- On non-freeway roadways and on freeways with many curves.

■ When the System can be Used

The system can be used when the following conditions are met.

- The lane you are driving in has detectable lane markers on both sides, and your vehicle is in the center of the lane.
- The vehicle speed is between 45 and 90 mph (72 and 145 km/h).
- You are driving on a straight or slightly curved road.
- The turn signals are off.
- The brake pedal is not depressed.
- The wipers are not in continuous operation.

■ How to activate the system

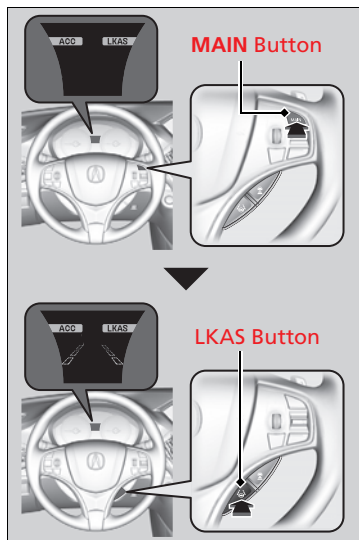

1. Press the **MAIN** button.

- ▶ The LKAS is on in the MID. The system is ready to use.

2. Press the LKAS button.

- ▶ Lane outlines appear on the multi-information display. The system is activated.

⌘ Lane Keeping Assist System (LKAS)*

- Shadows of adjacent objects are parallel to lane markings.
- The windshield is dirty.
- Where the roadway has crossing or other lines (e.g., such as at an intersection).

⌘ LKAS camera

Never apply a film or attach any objects to the windshield that could obstruct the LKAS camera's field of vision.

Scratches, nicks, and other damage to the windshield within the LKAS camera's field of vision can cause the system to operate abnormally. If this occurs, we recommend that you replace the windshield with a genuine Acura replacement windshield. Making even minor repairs within the camera's field of vision or installing an aftermarket replacement windshield may also cause the system to operate abnormally. After replacing the windshield, have a dealer recalibrate the camera. Proper calibration of the LKAS camera is necessary for the system to operate properly.

If the **Can Not Operate: Camera Too Hot** message appears:

- Use the climate control system to cool down the interior and, if necessary, the defroster mode when windows are fogged.
- Start driving the vehicle to lower the windshield temperature, which cools down the area around the LKAS camera.

⌘ When the System can be Used

If the vehicle drifts toward either left or right lane line due to the system applying torque, turn off the LKAS and have your vehicle checked by a dealer.

QRG

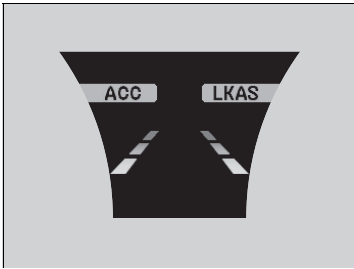

3. Keep your vehicle near the center of the lane while driving.
 - ▶ The dotted outer lines change to solid ones once the system starts operating after detecting the left and right lane markings.

⌘ When the System can be Used

The LKAS temporarily deactivates when it fails to detect lane lines. When the system detects the lines again, it comes back on automatically.

■ To cancel

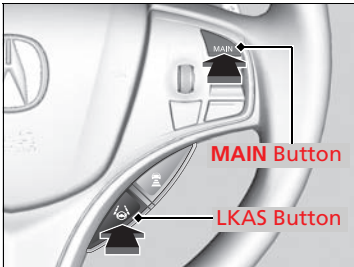

To cancel the LKAS:
Press the **MAIN** or LKAS button.

The LKAS is turned off every time you stop the engine, even if you turned it on the last time you drove the vehicle.

⌘ To cancel

Pressing the **MAIN** button also turns ACC with LSF on and off.

TOC

Driving

Index

Home

QRG

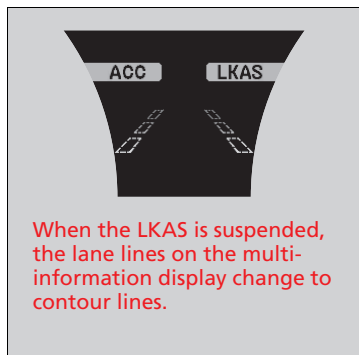

■ **The system operation is suspended if you:**

- Set the wipers to continuous operation.
 - ▶ Turning the wipers off resumes the LKAS.
- Decrease the vehicle speed to 40 mph (64 km/h) or less.
 - ▶ Increasing the vehicle speed to 45 mph (72 km/h) or more resumes the LKAS.
- Depress the brake pedal.
 - ▶ The LKAS resumes and starts detecting the lane lines again once you release the brake pedal.

TOC

Driving

■ **The LKAS may automatically be suspended when:**

- The system fails to detect lane lines.
- The steering wheel is quickly turned.
- You fail to steer the vehicle.
- The vehicle is driven on a curved road over the speed limit.
- The camera temperature gets extremely high or low.

Once these conditions no longer exist, the LKAS automatically resumes.

Index

Home

LKAS Limitations

The system may not detect lane markings and the position of your vehicle properly under the following conditions.

Condition

- The vehicle interior is reflected onto the front windshield.
- Headlight lenses are dirty or the headlights are not properly adjusted.
- The windshield is fogged.
- Driving on snowy or wet roads.
- The ambient brightness suddenly changes (e.g., at the entrance or exit of a tunnel).
- You drive into the low sun (e.g., at dawn or dusk).
- A strong light is reflected onto the roadway.
- Roadway lane markers are difficult to see due to weather (rain, snow, fog, etc.) or road conditions.
- Driving on a road with temporary lane markings.
- Multiple or varied lane markings are visible on the roadway due to road repairs or old lane markings.
- Roadway objects or structures are misinterpreted as lane markers.
- There is little contrast between lane lines and the roadway surface.
- The vehicle in front of you is driving near the lane lines.
- Driving over bumps.
- Where marked lanes merge or split.
- Where the lane is extremely narrow, wide or changing.
- Where the road is hilly or the vehicle is approaching the crest of a hill.

VSA® (Vehicle Stability Assist), aka ESC (Electronic Stability Control), System

VSA® helps to stabilize the vehicle during cornering if the vehicle turns more or less than what was intended. It also assists in maintaining traction on slippery surfaces. It does so by regulating engine output and selectively applying the brakes.

⚠ VSA® (Vehicle Stability Assist), aka ESC (Electronic Stability Control), System

The VSA® may not function properly if tire type and size are mixed. Make sure to use the same size and type of tire, and the air pressures as specified.

When the VSA® indicator comes on and stays on while driving, there may be a problem with the system. While this may not interfere with normal driving, have your vehicle checked by a dealer immediately.

VSA® cannot enhance stability in all driving situations and does not control the entire braking system. You still need to drive and corner at speeds appropriate for the conditions and always leave a sufficient margin of safety.

The main function of the VSA® system is generally known as Electronic Stability Control (ESC). The system also includes a traction control function.

■ VSA® Operation

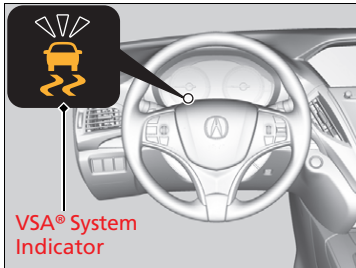

When VSA® activates, you may notice that the engine does not respond to the accelerator. You may also notice some noise from the hydraulic system. You will also see the indicator blink.

VSA® On and Off

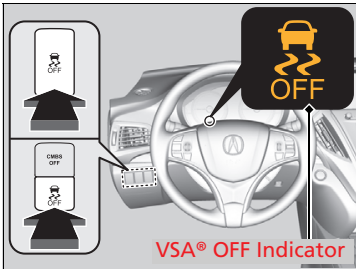

This button is on the driver side control panel. To turn the VSA® system on and off, press and hold it until you hear a beep.

VSA® will stop and the indicator will come on.

To turn it on again, press the  (VSA® OFF) button until you hear a beep.

VSA® is turned on every time you start the engine, even if you turned it off the last time you drove the vehicle.

 VSA® (Vehicle Stability Assist), aka ESC (Electronic Stability Control), System

Without VSA®, your vehicle will have normal braking and cornering ability, but it will not have VSA® traction and stability enhancement.

In certain unusual conditions when your vehicle gets stuck in shallow mud or fresh snow, it may be easier to free it with the VSA® temporarily switched off.

When the VSA® system is off, trailer stability assist is also off.

 [Trailer Stability Assist* P. 317](#)

When the VSA® system is off, the traction control system is also off. You should only attempt to free your vehicle with the VSA® off if you are not able to free it when the VSA® is on.

Immediately after freeing your vehicle, be sure to switch VSA® on again. We do not recommend driving your vehicle with the VSA® and traction control systems switched off.

If the low tire pressure/TPMS indicator comes on or blinks, the VSA® system turns on automatically. In this case, you cannot turn the system off by pressing the  button.

You may hear a motor sound coming from the engine compartment while system checks are being performed immediately after starting the engine or while driving. This is normal.

QRG

Agile Handling Assist System

Lightly brakes each of the front and rear wheels, as needed, when you turn the steering wheel, and helps support the vehicle's stability and performance during cornering.

Agile Handling Assist System

The agile handling assist system cannot enhance stability in all driving situations. You still need to drive and corner at speeds appropriate for the conditions and always leave a sufficient margin of safety.

When the VSA® indicator comes on and stays on while driving, the agile handling assist system does not activate.

You may hear a sound coming from the engine compartment while the system is activated. This is normal.

TOC

Driving

Index

Home

Blind Spot Information (BSI) System*

Is designed to detect vehicles in specified alert zones adjacent to your vehicle, particularly in harder to see areas commonly known as “blind spots.”

When the system detects vehicles approaching from behind in adjacent lanes, the appropriate indicator comes on for a few seconds, providing assistance when you change lanes.

■ How the system works

- The shift lever is in **D**.
- Your vehicle speed is between 20 mph (32 km/h) and 100 mph (160 km/h)

Alert zone range

- A: Approx. 1.6 ft. (0.5 m)
- B: Approx. 10 ft. (3 m)
- C: Approx. 10 ft. (3 m)

Radar Sensors:
underneath the
rear bumper
corners

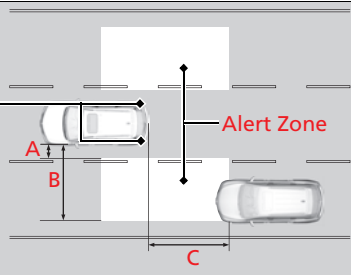

Blind Spot Information (BSI) System*

⚠ WARNING

Failure to visually confirm that it is safe to change lanes before doing so may result in a crash and serious injury or death. Do not rely only on the blind spot information system when changing lanes.

Always look in your mirrors, to either side of your vehicle, and behind you for other vehicles before changing lanes.

Important Safety Reminder

Like all assistance systems, BSI has limitations. Over reliance on BSI may result in a collision.

The system is for your convenience only. Even if an object is within the alert zone, the following situations may occur.

- The BSI alert indicator may not come on due to obstruction (splashes, etc.) even without the **Blind Spot Not Available** MID appearing.
- The BSI alert indicator may come on even with the message appearing.

The BSI alert indicator may not come on under the following conditions:

- A vehicle does not stay in the alert zone for more than two seconds.
- A vehicle is parked in a side lane.
- The speed difference between your vehicle and the vehicle you are passing is greater than 6 mph (10 km/h).
- An object not detected by the radar sensors approaches or passes your vehicle.

■ When the system detects a vehicle

BSI Alert Indicator: Located near the outside rearview mirror on both sides.

■ Comes on when

- A vehicle enters the alert zone from behind to overtake you with a speed difference of no more than 31 mph (50 km/h) from your vehicle.
- You pass a vehicle with a speed difference of no more than 12 mph (20 km/h).

■ Blinks and the beeper sounds when

You move the turn signal lever in the direction of the detected vehicle. The beeper sounds three times.

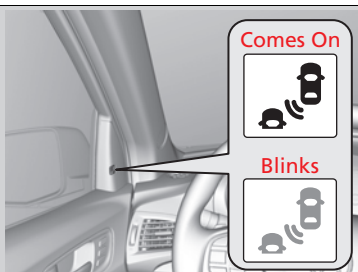

▶▶ Blind Spot Information (BSI) System*

You can change the setting for BSI.

▶ **Customizable Features P. 107**

Turn the system off when towing a trailer.

The system may not work properly for the following reasons:

- The added mass tilts the vehicle and changes the radar coverage.
- The trailer itself can be detected by the radar sensors, causing the BSI alert indicators to come on.

BSI may be adversely affected when:

- Objects (guard rails, poles, trees, etc.,) are detected.
- An object that does not reflect radio waves well, such as a motorcycle, is in the alert zone.
- Driving on a curved road.
- A vehicle is moving from a far lane to the adjacent lane.
- The system picks up external electrical interference.
- The rear bumper or the sensors have been improperly repaired or the rear bumper has been deformed.
- The orientation of the sensors has been changed.
- In bad weather (Heavy rain, snow, and fog).

For proper BSI use:

- Always keep the rear bumper corner area clean.
- Do not cover the rear bumper corner area with labels or stickers of any kind.
- Take your vehicle to a dealer if you need the rear bumper corner area or the radar sensors to be repaired, or the rear bumper corner area is strongly impacted.

Super Handling-All Wheel Drive™ (SH-AWD®)*

The system controls and transfers varying amounts of engine torque to each wheel in accordance with the driving conditions.

SH-AWD® helps to enhance driving stability, and lets you handle situations like slippery surfaces, such as snow, sand, mud, and steep hills, better than when driving with two wheel drive. However, the system does not help to enhance braking. Be precautious about the following:

- It is still your responsibility to drive safely when you steer, accelerate, and apply brakes.
- Leave a sufficient margin when braking on slippery surfaces.

Tire Pressure Monitoring System (TPMS)

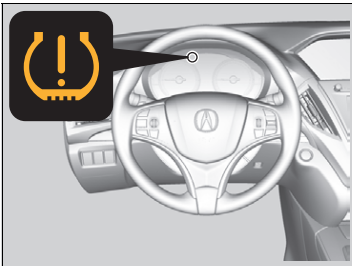

Monitors the tire pressure while you are driving. If your vehicle's tire pressure becomes significantly low, the low tire pressure/TPMS indicator comes on and a message appears on the MID.

Super Handling-All Wheel Drive™ (SH-AWD®)*

NOTICE

Avoid continuously driving in sand or mud where a wheel is likely to spin out, and do not drive once the SH-AWD® indicator starts blinking. Driving continuously under such conditions can damage the system's torque distribution unit.

Do not drive through deep water.

The SH-AWD® system may not function properly if tire type and size are mixed. Make sure to use the same size and type of tire, and the air pressures as specified.

➤ [Tire and Wheel Replacement P. 423](#)

Tire Pressure Monitoring System (TPMS)

Conditions such as low ambient temperature and altitude change directly affect tire pressure and can trigger the low tire pressure/TPMS indicator to come on.

➤ [If the Low Tire Pressure/TPMS Indicator Comes On or Blinks P. 468](#)

Tire pressure checked and inflated in:

- Warm weather can become under-inflated in colder weather.
- Cold weather can become over-inflated in warmer weather.

The low tire pressure/TPMS indicator will not come on as a result of over inflation.

■ Tire Pressure Monitor

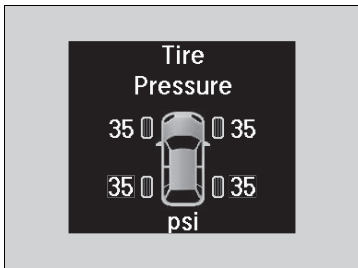

To select the tire pressure monitor, set the power mode to ON, and roll the multi-function steering-wheel controls until you see the tire pressure screen.

The pressure for each tire is displayed in psi (U.S.) or kPa (Canada).

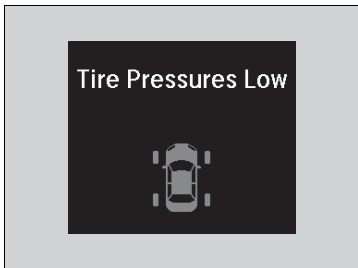

Tire Pressures Low is displayed when a tire has significantly low pressure. The specific tire is displayed on the screen.

▶▶ Tire Pressure Monitor

The pressure displayed on the MID can be slightly different from the actual pressure as measured by a gauge. If there is a significant difference between the two values, or if the low tire pressure/TPMS indicator and the message on the MID do not go off after you have inflated the tire to the specified pressure, have the system checked by a dealer.

Tire Pressure Monitor Problem may appear if you drive with the compact spare tire, or there is a problem with the TPMS.

QRG

Tire Pressure Monitoring System (TPMS) - Required Federal Explanation

Each tire, including the spare (if provided), should be checked monthly when cold and inflated to the inflation pressure recommended by the vehicle manufacturer on the vehicle placard or tire inflation pressure label.

(If your vehicle has tires of a different size than the size indicated on the vehicle placard or tire inflation pressure label, you should determine the proper tire inflation pressure for those tires.)

As an added safety feature, your vehicle has been equipped with a tire pressure monitoring system (TPMS) that illuminates a low tire pressure telltale when one or more of your tires is significantly under-inflated.



Accordingly, when the low tire pressure telltale illuminates, you should stop and check your tires as soon as possible, and inflate them to the proper pressure.

Driving on a significantly under-inflated tire causes the tire to overheat and can lead to tire failure. Under-inflation also reduces fuel efficiency and tire tread life, and may affect the vehicle's handling and stopping ability.

TOC

Driving

Index

Home

QRG

Please note that the TPMS is not a substitute for proper tire maintenance, and it is the driver's responsibility to maintain correct tire pressure, even if under-inflation has not reached the level to trigger illumination of the TPMS low tire pressure telltale.

Your vehicle has also been equipped with a TPMS malfunction indicator to indicate when the system is not operating properly. The TPMS malfunction indicator is combined with the low tire pressure telltale. When the system detects a malfunction, the telltale will flash for approximately one minute and then remain continuously illuminated. This sequence will continue upon subsequent vehicle start-ups as long as the malfunction exists.

When the malfunction indicator is illuminated, the system may not be able to detect or signal low tire pressure as intended.

TOC

Driving

TPMS malfunctions may occur for a variety of reasons, including the installation of replacement or alternate tires or wheels on the vehicle that prevent the TPMS from functioning properly.

Always check the TPMS malfunction telltale after replacing one or more tires or wheels on your vehicle to ensure that the replacement or alternate tires and wheels allow the TPMS to continue to function properly.

Index



Brake System

Parking Brake

Use the parking brake to keep the vehicle stationary when parking.

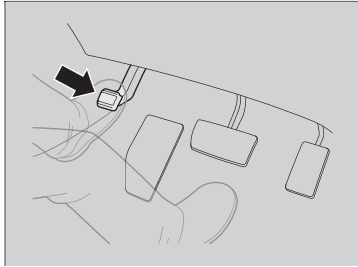

To apply:

Depress the parking brake pedal down with your foot.

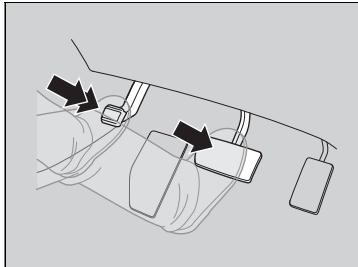

To release:

1. Depress the brake pedal.
2. Depress the parking brake.

⌘ Parking Brake

NOTICE

Release the parking brake fully before driving. The rear brakes and axle can be damaged if you drive with the parking brake applied.

If you start driving without fully releasing the parking brake, a buzzer sounds as a warning, and **Release Parking Brake** appears on the MID.

Always apply the parking brake when parking.

■ Foot Brake

Your vehicle is equipped with disc brakes at all four wheels. A vacuum power assist helps reduce the effort needed on the brake pedal. The brake assist system increases the stopping force when you depress the brake pedal hard in an emergency situation. The anti-lock brake system (ABS) helps you retain steering control when braking very hard.

➤ [Brake Assist System](#) P. 370

➤ [Anti-lock Brake System \(ABS\)](#) P. 369

☒ Foot Brake

Check the brakes after driving through deep water, or if there is a buildup of road surface water. If necessary, dry the brakes by lightly depressing the pedal several times.

If you hear a continuous metallic friction sound when applying the brakes, the brake pads need to be replaced. Have the vehicle checked by a dealer.

Constantly using the brake pedal while going down a long hill builds up heat, which reduces the brake effectiveness. Apply engine braking by taking your foot off the accelerator pedal and downshifting to a lower gear.

Do not rest your foot on the brake pedal while driving, as it will lightly apply the brakes and cause them to lose effectiveness over time and reduce pad life. It will also confuse drivers behind you.

Anti-lock Brake System (ABS)

ABS

Helps prevent the wheels from locking up, and helps you retain steering control by pumping the brakes rapidly, much faster than you.

The electronic brake distribution (EBD) system, which is part of the ABS, also balances the front-to-rear braking distribution according to vehicle loading.

You should never pump the brake pedal. Let the ABS work for you by always keeping firm, steady pressure on the brake pedal. This is sometimes referred to as “stomp and steer.”

■ ABS operation

The brake pedal may pulsate slightly when the ABS is working. Keep holding the pedal firmly down. On dry pavement, you will need to press on the brake pedal very hard before the ABS activates. However, you may feel the ABS activate immediately if you are trying to stop on snow or ice.

When the vehicle speed goes under 6 mph (10 km/h), the ABS stops.

ⓘ Anti-lock Brake System (ABS)

NOTICE

The ABS may not function correctly if you use an incorrect tire type and size.

When the **ABS** indicator comes on while driving, there may be a problem with the system. While normal braking is not affected, there is a possibility of the ABS not operating. Have the vehicle checked by a dealer immediately.

The ABS does not reduce the time or distance it takes to stop the vehicle. It only helps with steering control during hard braking.

In the following cases, your vehicle may need more stopping distance than a vehicle without the ABS:

- When driving on rough road surfaces, including when driving on uneven surfaces, such as gravel or snow.
- When tire chains are installed.

You may hear a motor sound coming from the engine compartment while system checks are being performed immediately after starting the engine or while driving. This is normal.

Brake Assist System

Designed to assist the driver by generating greater braking force when you depress the brake pedal hard during emergency braking.

■ Brake assist system operation

Press the brake pedal firmly for more powerful braking.

When brake assist operates, the pedal may wiggle slightly and an operating noise may be heard. This is normal. Keep holding the brake pedal firmly down.

Collision Mitigation Braking System™ (CMBS™)*

Can assist you when there is a possibility of your vehicle colliding with a vehicle detected in front of yours. The CMBS™ is designed to alert you when a potential collision is determined, as well as to reduce your vehicle speed when a collision is deemed unavoidable to help minimize collision severity.

■ How the system works

A radar sensor starts to monitor if there is a vehicle in front of you when your vehicle speed is above 10 mph (15 km/h).



The radar sensor is in the front grille.



The CMBS™ activates when the speed difference between your vehicle and a vehicle detected in front of you becomes more than 10 mph (15 km/h) with a chance of a collision.

▣ Collision Mitigation Braking System™ (CMBS™)*

Important Safety Reminder

The CMBS™ is designed to reduce the severity of an unavoidable collision. It does not prevent a collision nor stop the vehicle automatically. It is still your responsibility to operate the brake pedal and steering wheel appropriately according to the driving conditions.

The CMBS™ may not activate or may not detect a vehicle in front of your vehicle under the following conditions:

- The distance between your vehicle and the vehicle ahead of you is too short.
- A vehicle cuts in front of you at a slow speed, and it brakes suddenly.
- When you accelerate rapidly and approach the vehicle ahead of you at high speed.
- The vehicle ahead of you is a motorcycle or other small vehicle.
- A vehicle suddenly crosses in front of you.
- When you drive on a curved or winding road that makes it difficult for the sensor to properly detect a vehicle in front of you.
- When there are pedestrians or animals in front of your vehicle.

■ When the system activates

The system provides visual and audible alerts of a possible collision, and stops the alerts if the collision is avoided.

▶ Take appropriate action to prevent a collision (apply the brakes, change lanes, etc.)

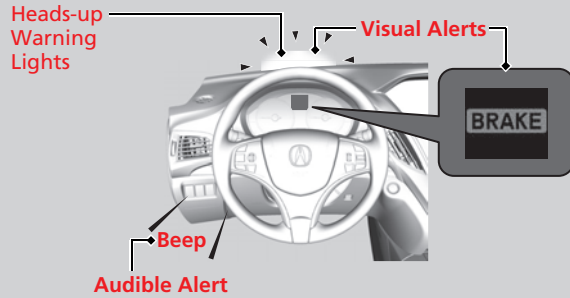

▶▶ When the system activates



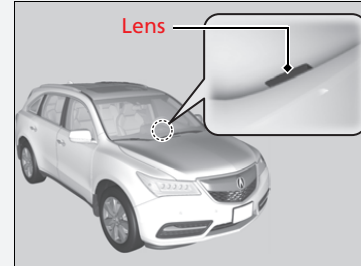

The heads-up warning uses a lens located at the front end of the dashboard. Do not cover the lens or spill any liquid on it.

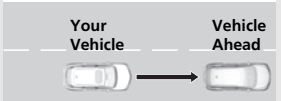

Collision Alert Stages

The system has three alert stages for a possible collision. However, depending on the circumstances, the CMBS™ may not go through all of the stages before initiating the last stage.

Distance between vehicles		CMBS™			
		The radar sensor detects a vehicle	E-pretensioner	Audible & Visual WARNINGS	Braking
Stage one	<p>The diagram shows two vehicles: 'Your Vehicle' on the left and 'Vehicle Ahead' on the right. A horizontal line with an arrow points from 'Your Vehicle' to 'Vehicle Ahead'. Three vertical dashed lines are drawn from the line to the text 'Normal', 'Long', and 'Short' above the line, indicating different distance thresholds.</p>	There is a risk of a collision with the vehicle ahead of you.	—	<p>You can change the distance between vehicles at which visual alerts will display (Long/Normal/Short).</p> <p>▶ Customizable Features P. 107</p> <p>When your setting is:</p> <ul style="list-style-type: none"> • Long: Visual alerts flash twice at Long distance. When the Short distance is reached, visual and audible alerts are provided. • Normal: Visual alerts flash twice at the Normal distance. When the Short distance is reached, visual and audible alerts are provided. • Short: Visual and audible alerts are provided immediately. 	—

Distance between vehicles		CMBS™			
		The radar sensor detects a vehicle	E-pretensioner	Audible & Visual WARNINGS	Braking
Stage two		The risk of a collision has increased, time to respond is reduced.	Retracts the driver's seat belt gently a few times, providing a physical warning. 	Visual and audible alerts.	Lightly applied
Stage three		The CMBS™ determines that a collision is unavoidable.	Forcefully tightens driver and front passenger seat belts. 		Forcefully applied

CMBS™ On and Off

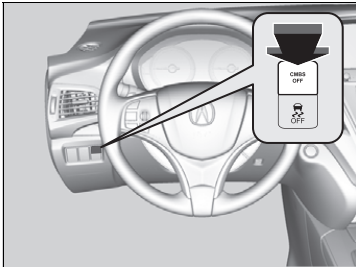

Press this button for about one second to turn on and off the system.

When the CMBS™ is off:

- The beeper sounds.
- The CMBS™ indicator in the instrument panel comes on.
- A message on the MID reminds you that the system is off.

The CMBS™ is in the previously selected ON or OFF setting each time you start the engine.

Collision Mitigation Braking System™ (CMBS™)*

The CMBS™ may automatically shut off, and the CMBS™ indicator will come and stay on when:

- You drive off-road or on a mountain road for an extended period.
- You drive with the parking brake applied.
- You drive in bad weather (rain, fog, snow, etc.)
- The radar sensor cover is blocked by dirt, mud, dry leaves, wet snow, etc.
- An abnormal tire condition is detected (wrong tire size, flat tire, etc.)

Once the conditions that caused the CMBS™ to shut off improve, the system comes back on.

* Not available on all models

■ With Little Chance of a Collision

The CMBS™ may activate even when you are aware of a vehicle ahead of you, or when there is no vehicle ahead. Some examples of this are:

■ When Passing

Your vehicle approaches another vehicle ahead of you and you change lanes to pass.

■ At an intersection

Your vehicle approaches or passes another vehicle that is making a left or right turn.

■ Through a low bridge at high speed

You drive under a low or narrow bridge at high speed.

■ Speed bumps, road work sites, train tracks, roadside objects, etc.

You drive over speed bumps, steel road plates, etc., or your vehicle approaches train tracks or roadside objects [such as a traffic sign and guard rail] on a curve.

ⓘ Collision Mitigation Braking System™ (CMBS™)*

Avoid the following conditions that may cause the radar aim to be temporarily out of range and prevent the CMBS™ from working properly.

- A heavy load in the rear or modifications to the suspension tilts your vehicle.
- The tire pressures are not correct, the tire sizes are incorrect, the tire types are different, and/or the tires are not in good condition.

For the CMBS™ to work properly:

- Always keep the radar sensor cover clean.
- Never use chemical solvents or polishing powder for cleaning the sensor cover. Clean it with water or a mild detergent.

Do not put a sticker on the emblem or replace the emblem.

Take your vehicle to a dealer if you need the radar sensor to be repaired, or removed, or the radar sensor cover is strongly impacted.

When Stopped

1. Depress the brake pedal firmly with the shift lever in **D**.
2. Firmly apply the parking brake.
3. Move the shift lever from **D** to **P**.
4. Turn off the engine.

Always set the parking brake firmly, in particular if you are parked on an incline.

» Parking Your Vehicle

Do not park your vehicle near flammable objects, such as dry grass, oil, or timber. Heat from the exhaust can cause a fire.

Raise the wiper arms when snow is expected.

» When Stopped

NOTICE

The following can damage the transmission:

- Depressing the accelerator and brake pedals simultaneously.
- Holding the vehicle in place when facing uphill by depressing the accelerator pedal.
- Moving the shift lever into **P** before the vehicle stops completely.

Parking Sensor System *

The corner and center sensors monitor obstacles near your vehicle. The beeper and audio/information screen let you know the approximate distance between your vehicle and the obstacle.

■ The sensor location and range

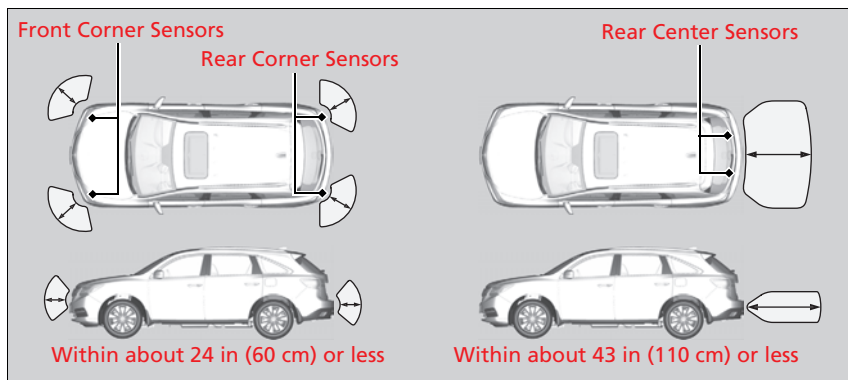

▣ Parking Sensor System *

Even when the system is on, always confirm if there is no obstacle near your vehicle before parking.

The system may not work properly when:

- The sensors are covered with snow, ice, mud or dirt, etc.
- The vehicle is on uneven surface, such as grass, bumpy road, or a hill.
- The vehicle has been out in hot or cold weather.
- The system is affected by some electronic devices that generate ultrasonic waves.
- Driving in bad weather.

The system may not sense:

- Thin or low objects.
- Sonic-absorptive materials, such as snow, cotton, or sponge.
- Objects directly under the bumper.

Do not put any accessories on or around the sensors.

■ Parking sensor system on and off

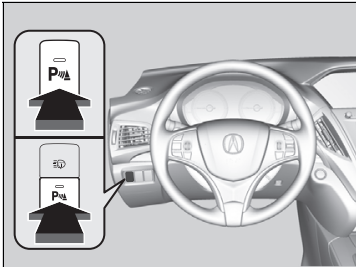

With the power mode in ON, press the parking sensor system button to turn on or off the system. The indicator in the button comes on and the beeper sounds when the system is on.

The rear center and corner sensors start to detect an obstacle when the shift lever is in **[R]**, and the vehicle speed is less than 5 mph (8 km/h).

The front corner sensors start to detect an obstacle when the shift lever is in any position other than **[P]**, and the vehicle speed is less than 5 mph (8 km/h).

■ When the distance between your vehicle and obstacles behind becomes shorter

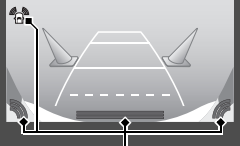
Length of the intermittent beep	Distance between the Bumper and Obstacle		Indicator	Audio/information screen
	Corner Sensors	Center Sensors		
Moderate	—	Rear: About 43-24 in (110-60 cm)	Blinks in Yellow*1	 <p>Indicators light where the sensor detects an obstacle</p>
Short	About 24-18 in (60-45 cm)	About 24-18 in (60-45 cm)	Blinks in Amber	
Very short	About 18-14 in (45-35 cm)	About 18-14 in (45-35 cm)		
Continuous	About 14 in (35 cm) or less	About 14 in (35 cm) or less	Blinks in Red	

*1: At this stage, only the center sensors detect obstacles.

■ Turning off All Rear Sensors

1. Make sure that the parking sensor system is not activated. Set the power mode to VEHICLE OFF (LOCK).
2. Press and hold the parking sensor system button, and set the power mode to ON.
3. Keep pressing the button for 10 seconds. Release the button when the indicator in the button flashes.
4. Press the button again. The indicator in the button goes off.
 - ▶ The beeper sounds twice. The rear sensors are now turned off.

To turn the rear sensors on again, follow the above procedure. The beeper sounds three times when the rear sensors come back on.

☒ Turning off All Rear Sensors

When you shift to **[R]**, the indicator in the parking sensor system button blinks as a reminder that the rear sensors have been turned off.

About Your Multi-View Rear Camera

Models with navigation system

For models with navigation system, see Navigation System Manual.

Models without navigation system

The audio/information screen can display your vehicle's rear view. The display automatically changes to a rear view when the shift lever is moved to **[R]**.

About Your Multi-View Rear Camera

The rear camera view is restricted. You cannot see the corner ends of the bumper or what is underneath the bumper. Its unique lens also makes objects appear closer or farther than they actually are.

Visually confirm that it is safe to drive before backing up. Certain conditions (such as weather, lighting, and high temperatures) may also restrict the rear view. Do not rely on the rearview display which does not give you all information about conditions at the back of your vehicle.

If the camera lens is covered with dirt or moisture, use a soft, moist cloth to keep the lens clean and free of debris.

Multi-View Rear Camera Display Area

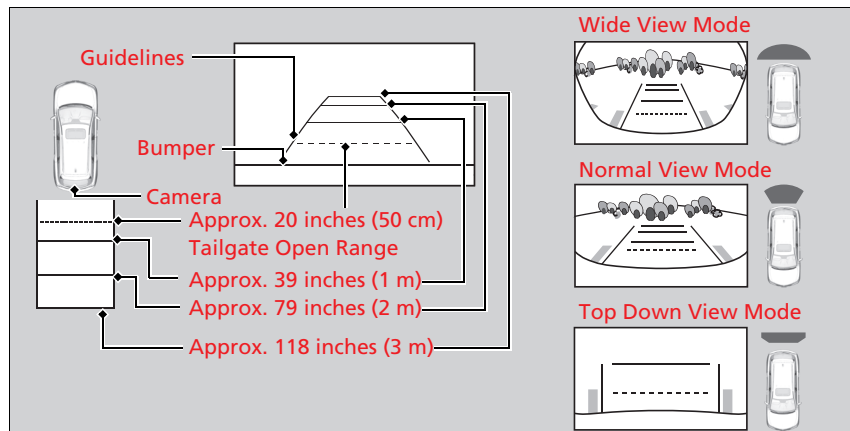

You can view three different camera angles on the rearview display. Press the selector knob to switch the angle.

If the last used viewing mode is Wide or Normal, the same mode is selected the next time you shift into **[R]**. If Top view was last used, Wide mode is selected.

Fuel Information

Fuel recommendation

Unleaded premium gasoline, pump octane number 91 or higher

Use of lower octane gasoline can cause occasional metallic knocking noise in the engine and will result in decreased engine performance.

Use of gasoline with a pump octane less than 87 can lead to engine damage.

Top tier detergent gasoline

Because the level of detergency and additives in gasoline vary in the market, Acura endorses the use of "TOP TIER Detergent Gasoline" where available to help maintain the performance and reliability of your vehicle. TOP TIER Detergent Gasoline meets a new gasoline standard jointly established by leading automotive manufacturers to meet the needs of today's advanced engines.

Qualifying gasoline retailers will, in most cases, identify their gasoline as having met "TOP TIER Detergent Gasoline" standards at the retail location. This fuel is guaranteed to contain the proper level of detergent additives and be free of metallic additives. The proper level of detergent additives, and absence of harmful metallic additives in gasoline, help avoid build-up of deposits in your engine and emission control system.

For further important fuel-related information for your vehicle, or on information on gasoline that does not contain MMT, visit Acura Owners at owners.acura.com In Canada, visit www.acura.ca for additional information on gasoline. For more information on top tier gasoline, visit www.toptiergas.com.

Fuel tank capacity: 19.5 US gal (74 liters)

Fuel Information

NOTICE

We recommend quality gasoline containing detergent additives that help prevent fuel system and engine deposits. In addition, in order to maintain good performance, fuel economy, and emissions control, we strongly recommend the use of gasoline that does NOT contain harmful manganese-based fuel additives such as MMT, if such gasoline is available.

Use of gasoline with these additives may adversely affect performance, and cause the malfunction indicator lamp on your instrument panel to come on. If this happens, contact a dealer for service. Some gasoline today is blended with oxygenates such as ethanol. Your vehicle is designed to operate on oxygenated gasoline containing up to 15% ethanol by volume. Do not use gasoline containing methanol. If you notice any undesirable operating symptoms, try another service station or switch to another brand of gasoline.

How to Refuel

QRG

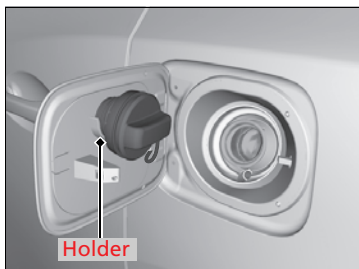

1. Stop your vehicle with the service station pump on the left side of the vehicle in the rear.
2. Turn off the engine.
3. Press the fuel fill door release button.
 - ▶ The fuel fill door opens.
4. Remove the fuel fill cap slowly. If you hear a release of air, wait until this stops, then turn the knob slowly to open the fuel fill cap.
5. Place the fuel fill cap in the holder.
6. Insert the filler nozzle fully.
 - ▶ When the tank is full, the filler nozzle will click off automatically. This leaves space in the fuel tank in case the fuel expands with a change in the temperature.
7. After filling, replace the fuel fill cap, tightening it until you hear it click at least once.
 - ▶ Shut the fuel fill door by hand.

How to Refuel

⚠ WARNING

Gasoline is highly flammable and explosive. You can be burned or seriously injured when handling fuel.

- Stop the engine, and keep heat, sparks, and flame away.
- Handle fuel only outdoors.
- Wipe up spills immediately.

The filler nozzle automatically stops to leave space in the fuel tank so that fuel does not overflow as a result of changes in air temperature.

If the fuel filler nozzle keeps turning off when the tank is not full, there may be a problem with the pump's fuel vapor recovery system. Try filling at another pump. If this does not fix the problem, consult a dealer.

Do not continue to add fuel after the nozzle has automatically stopped. Additional fuel can exceed the full tank capacity.

TOC

Driving

Index

Home

Improving Fuel Economy

Fuel economy depends on several conditions, including driving conditions, your driving habits, the condition of your vehicle, and loading. Depending on these and other conditions, you may or may not achieve the rated fuel economy of this vehicle.

Maintenance and Fuel Economy

You can optimize your fuel economy with proper maintenance of your vehicle. Always maintain your vehicle in accordance with the messages displayed on the MID.

- Use the recommended viscosity engine oil, displaying the API Certification Seal.
- Maintain the specified tire pressure.
- Do not load the vehicle with excess cargo.
- Keep your vehicle clean. A buildup of snow or mud on your vehicle's underside adds weight and increases wind resistance.

Improving Fuel Economy

Direct calculation is the recommended method to determine actual fuel consumed while driving.

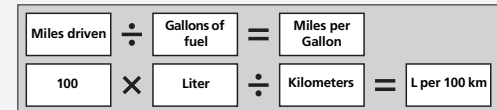

In Canada, posted fuel economy numbers are established following a simulated test. For more information on how this test is performed, please visit <http://oee.nrcan.gc.ca/>

Accessories

When installing accessories, check the following:

- Do not install accessories on the windshield. They can obstruct your view and delay your reaction to driving conditions.
- Do not install any accessories over areas marked SRS Airbag, on the sides or backs of the front seats, on front or side pillars, or near the side windows. Accessories installed in these areas may interfere with proper operation of the vehicle's airbags or may be propelled into you or another occupant if the airbags deploy.
- Be sure electronic accessories do not overload electrical circuits or interfere with proper operation of your vehicle.
[Fuses P. 469](#)
- Before installing any electronic accessory, have the installer contact a dealer for assistance. If possible, have a dealer inspect the final installation.

Modifications

Do not modify your vehicle or use non-Acura components that can affect its handling, stability, and reliability.

Overall vehicle performance can be affected. Always make sure all equipment is properly installed and maintained, and that it meets federal, state, province, territory, and local regulations.

Accessories and Modifications

WARNING

Improper accessories or modifications can affect your vehicle's handling, stability, and performance, and cause a crash in which you can be seriously hurt or killed.

Follow all instructions in this owner's manual regarding accessories and modifications.

Acura Genuine accessories are recommended to ensure proper operation on your vehicle.

Maintenance

This chapter discusses basic maintenance.



Before Performing Maintenance

- Inspection and Maintenance 388
- Safety When Performing Maintenance..389
- Parts and Fluids Used in Maintenance Service 390

Maintenance Minder™ 391

Maintenance Under the Hood

- Maintenance Items Under the Hood.. 395
- Opening the Hood 396
- Engine Compartment Cover..... 397
- Recommended Engine Oil 398
- Oil Check..... 399
- Adding Engine Oil..... 400

- Changing the Engine Oil and Oil Filter... 401
- Engine Coolant..... 403
- Transmission Fluid..... 405
- Brake Fluid..... 406
- Refilling Window Washer Fluid..... 406
- Replacing Light Bulbs** 407
- Checking and Maintaining Wiper Blades**... 413
- Checking and Maintaining Tires**
- Checking Tires 417
- Tire and Loading Information Label.. 418
- Tire Labeling 418
- DOT Tire Quality Grading (U.S. Vehicles).. 420
- Wear Indicators..... 422

- Tire Service Life..... 422
- Tire and Wheel Replacement 423
- Tire Rotation 424
- Winter Tires 425
- Battery**..... 426
- Remote Transmitter Care**
- Replacing the Button Battery 427
- Remote Control and Wireless Headphone Care*** 429
- Climate Control System Maintenance** ..431
- Cleaning**
- Interior Care 432
- Exterior Care..... 434

* Not available on all models

Inspection and Maintenance

For your safety, perform all listed inspections and maintenance to keep your vehicle in good condition. If you become aware of any abnormality (noise, smell, insufficient brake fluid, oil residue on the ground, etc.), have your vehicle inspected by a dealer. (Note, however, that service at a dealer is not mandatory to keep your warranties in effect.) Refer to the separate maintenance booklet for detailed maintenance and inspection information.

Types of Inspection and Maintenance

Daily inspections

Perform inspections before long distance trips, when washing the vehicle, or when refueling.

Periodic inspections

- Check the automatic transmission fluid level monthly.
[Automatic Transmission Fluid](#) P. 405
- Check the brake fluid level monthly.
[Checking the Brake Fluid](#) P. 406
- Check the tire pressure monthly. Examine the tread for wear and foreign objects.
[Checking and Maintaining Tires](#) P. 417
- Check the operation of the exterior lights monthly.
[Replacing Light Bulbs](#) P. 407
- Check the condition of the wiper blades at least every six months.
[Checking and Maintaining Wiper Blades](#) P. 413

Inspection and Maintenance

U.S. models

Maintenance, replacement, or repair of emissions control devices and systems may be done by any automotive repair establishment or individuals using parts that are "certified" to EPA standards.

According to state and federal regulations, failure to perform maintenance on the maintenance main items marked with # will not void your emissions warranties. However, all maintenance services should be performed in accordance with the intervals indicated by the multi-information display (MID).

[Maintenance Service Items](#) P. 393

If you want to perform complex maintenance tasks that require more skills and tools, you can purchase a subscription to the Service Express website at www.techinfo.honda.com.

[Authorized Manuals](#) P. 489

If you want to perform maintenance yourself, make sure that you have the necessary tools and skills first. After performing maintenance, update the records in the separate maintenance booklet.

Safety When Performing Maintenance

Some of the most important safety precautions are given here. However, we cannot warn you of every conceivable hazard that can arise in performing maintenance. Only you can decide whether or not you should perform a given task.

Maintenance Safety

- To reduce the possibility of fire or explosion, keep cigarettes, sparks, and flames away from the battery and all fuel related parts.
- Never leave rags, towels, or other flammable objects under the hood.
 - ▶ Heat from the engine and exhaust can ignite them causing a fire.
- To clean parts, use a commercially available degreaser or parts cleaner, not gasoline.
- Wear eye protection and protective clothing when working with the battery or compressed air.
- Engine exhaust contains carbon monoxide, which is poisonous and can kill you.
 - ▶ Only operate the engine if there is sufficient ventilation.

Vehicle Safety

- The vehicle must be in a stationary condition.
 - ▶ Make sure your vehicle is parked on level ground, the parking brake is set, and the engine is off.
- Be aware that hot parts can burn you.
 - ▶ Make sure to let the engine and exhaust system cool thoroughly before touching vehicle parts.
- Be aware that moving parts can injure you.
 - ▶ Do not start the engine unless instructed, and keep your hands and limbs away from moving parts.

⚠ Safety When Performing Maintenance

⚠ WARNING

Improperly maintaining this vehicle or failing to correct a problem before driving can cause a crash in which you can be seriously hurt or killed.

Always follow the inspection and maintenance recommendations according to the schedules in this owner's manual.

⚠ WARNING

Failure to properly follow maintenance instructions and precautions can cause you to be seriously hurt or killed.

Always follow the procedures and precautions in this owner's manual.

QRG

Parts and Fluids Used in Maintenance Service

The use of Acura genuine parts and fluids is recommended when maintaining and servicing your vehicle. Acura genuine parts are manufactured according to the same high quality standards used in Acura vehicles.

TOC

Maintenance

Index

Home

Maintenance items, which should be serviced at the same time that you replace the engine oil, appear on the MID.

You can view them on the engine oil life screen at any time.

To Use Maintenance Minder™

■ Displaying the Engine Oil Life and Maintenance Items

1. Set the power mode to ON.
2. Roll the multi-function steering-wheel controls until the engine oil life appears on the MID.

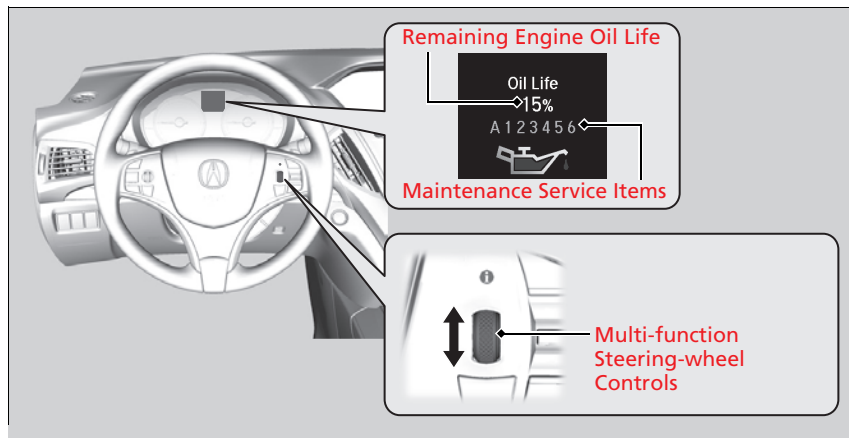

▣ Displaying the Engine Oil Life and Maintenance Items





Based on the engine operating conditions, the remaining engine oil life is calculated and displayed as a percentage.

Displayed Engine Oil Life (%)	Calculated Engine Oil Life (%)
100	100 to 91
90	90 to 81
80	80 to 71
70	70 to 61
60	60 to 51
50	50 to 41
40	40 to 31
30	30 to 21
20	20 to 16
15	15 to 11
10	10 to 6
5	5 to 1
0	0

There is a list of maintenance main and sub items you can view on the MID.

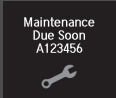
[▶ Maintenance Service Items P. 393](#)

■ Maintenance Minder Messages on the Multi-Information Display (MID)

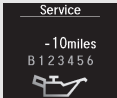
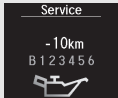
Maintenance Message	Oil Life Display	Explanation	Information
<p>Maintenance Due Soon</p> 	<p>15%</p> 	<p>The remaining engine oil life is 15 to 6 percent. Once you switch the display by rolling the multi-function steering-wheel controls, this message will go off.</p>	<p>The engine oil is approaching the end of its service life, and the maintenance items should be inspected and serviced soon.</p>
<p>Maintenance Due Now</p> 	<p>5%</p> 	<p>The remaining engine oil life is 5 to 1 percent. Roll the multi-function steering-wheel controls to switch to another display.</p>	<p>The engine oil has almost reached the end of its service life, and the maintenance items should be inspected and serviced as soon as possible.</p>
<p>Maintenance Past Due</p> 	<p>Negative Distance</p> <div style="display: flex; justify-content: space-around;"> <div style="text-align: center;"> <p>U.S.</p>  </div> <div style="text-align: center;"> <p>Canada</p>  </div> </div>	<p>The remaining engine oil life has passed its service life, and a negative distance appears after driving over 10 miles (U.S. models) or 10 km (Canadian models). Roll the multi-function steering wheel control to switch to another display.</p>	<p>The engine oil life has passed. The maintenance items must be inspected and serviced immediately.</p>

The system message indicator () comes on along with the Maintenance Minder message.

Maintenance Service Items

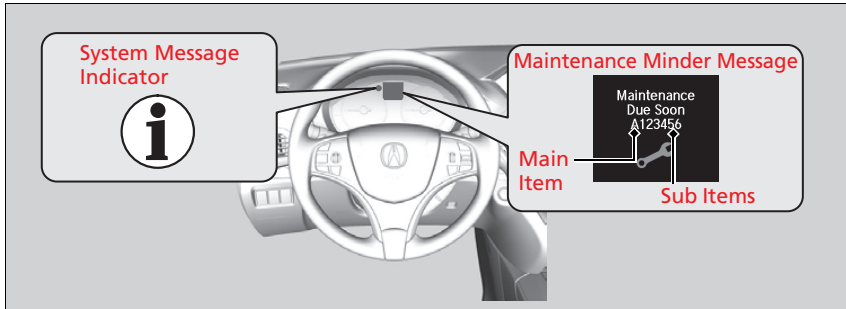

Maintenance Service Items

- Independent of the Maintenance Minder information, replace the brake fluid every 3 years.
- Inspect idle speed every 160,000 miles (256,000 km).
- Adjust the valves during services A, B, 1, 2, or 3 if they are noisy.

Driving in mountainous areas at very low vehicle speeds or trailer towing results in higher level of mechanical (Shear) stress to fluid. This requires differential fluid changes more frequently than recommended by the Maintenance Minder. If you regularly drive your vehicle under these conditions, have the differential fluid changed at 7,500 miles (12,000km), then every 15,000 miles (24,000 km).

CODE	Maintenance Main Items
A	<ul style="list-style-type: none"> • Replace engine oil*1
B	<ul style="list-style-type: none"> • Replace engine oil*1 and oil filter • Inspect front and rear brakes, service as necessary • Check parking brake adjustment • Inspect tie rod ends, steering gearbox, and boots • Inspect suspension components • Inspect driveshaft boots • Inspect brake hoses and lines (Including ABS/VSA) • Inspect all fluid levels and condition of fluids • Inspect exhaust system# • Inspect fuel lines and connections#

CODE	Maintenance Sub Items
1	<ul style="list-style-type: none"> • Rotate tires
2	<ul style="list-style-type: none"> • Replace air cleaner element*2 • Replace dust and pollen filter*3 • Inspect drive belt
3	<ul style="list-style-type: none"> • Replace transmission and transfer fluid*
4	<ul style="list-style-type: none"> • Replace spark plugs • Replace timing belt and inspect water pump*4 • Inspect valve clearance
5	<ul style="list-style-type: none"> • Replace engine coolant
6	<ul style="list-style-type: none"> • Replace rear differential fluid*

*1: If the message **SERVICE** does not appear more than 12 months after the display is reset, change the engine oil every year.

#: See information on maintenance and emissions warranty.

*2: If you drive in dusty conditions, replace the air cleaner element every 15,000 miles (24,000 km).

*3: If you drive primarily in urban areas that have high concentrations of soot in the air from industry and from diesel-powered vehicles, replace the dust and pollen filter every 15,000 miles (24,000 km).

*4: If you drive regularly in very high temperatures (over 110°F, 43°C), in very low temperatures (under -20°F, -29°C), or tow a trailer, replace every 60,000 miles/100,000 km.

* Not available on all models

■ Resetting the Display

Reset the engine oil life display if you have performed the maintenance service.

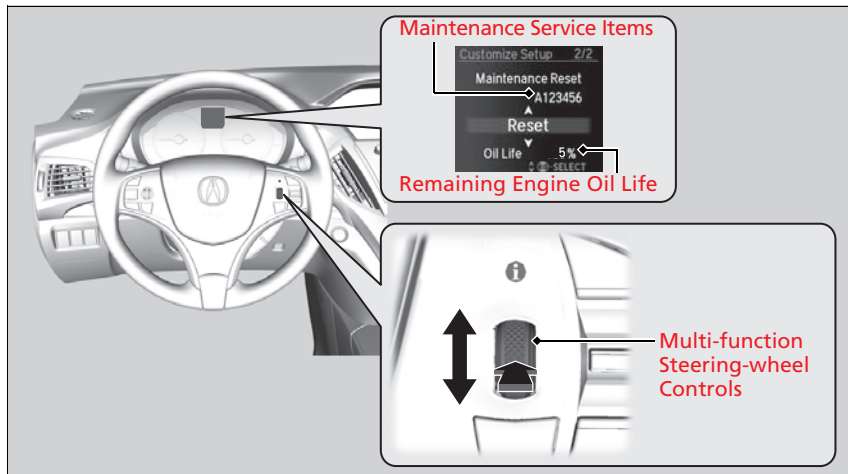

1. Set the power mode to ON.
2. Go to the **Maintenance Info.** group.
 - [Customized Features P. 104](#)
3. Push the multi-function steering-wheel controls.
 - The oil life reset mode is displayed on the MID.
4. Select **Reset** with the multi-function steering-wheel controls, then push the multi-function steering wheel control.
 - The displayed maintenance items disappear, and the engine oil life display returns to **100%**.
 - To cancel the oil life reset mode, select **Cancel**, then push the multi-function steering-wheel controls.

► Resetting the Display

NOTICE

Failure to reset the engine oil life after a maintenance service results in the system showing incorrect maintenance intervals, which can lead to serious mechanical problems.

The dealer will reset the engine oil life display after completing the required maintenance service. If someone other than a dealer performs maintenance service, reset the engine oil life display yourself.

Maintenance Items Under the Hood

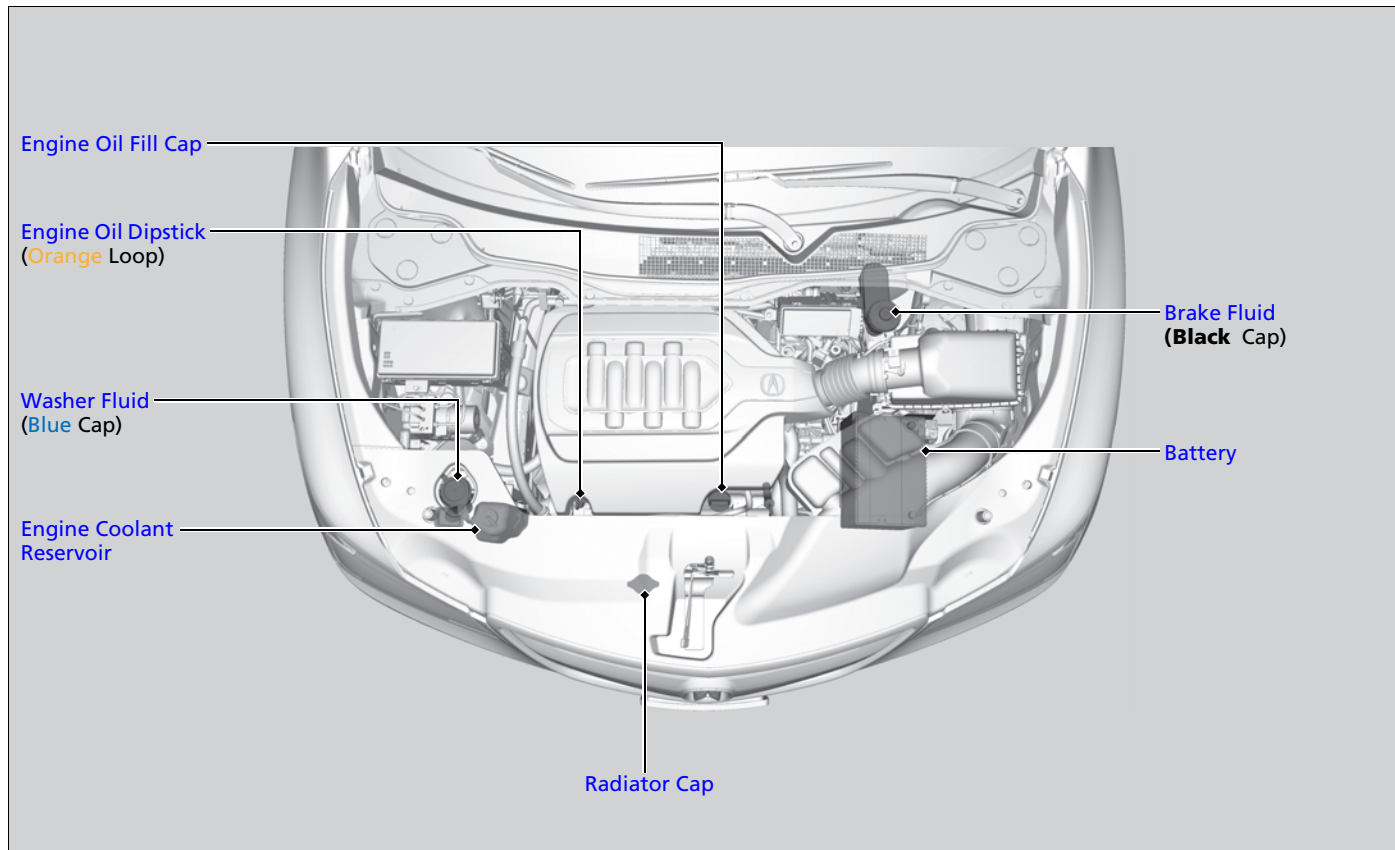

Opening the Hood

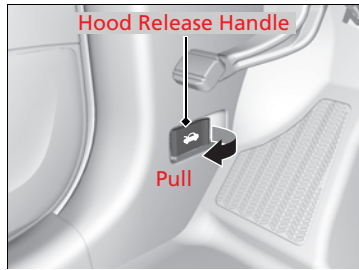

1. Park the vehicle on a level surface, and set the parking brake.
2. Pull the hood release handle under the lower left corner of the dashboard.
 - The hood will pop up slightly.

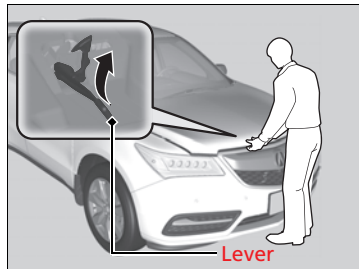

3. Push up the hood latch lever in the center of the hood to release the lock mechanism, and open the hood.



4. Lift the hood up most of the way.
 - The hydraulic supports will lift it up the rest of the way and hold it up.

When closing, lower it to approximately 12 inches (30 cm), then press down firmly with your hands.

Opening the Hood

NOTICE

Do not open the hood when the wiper arms are raised.

The hood will strike the wipers, and may damage either the hood or the wipers.

When closing the hood, check that the hood is securely latched.

If the hood latch lever moves stiffly, or if you can open the hood without lifting the lever, the latch mechanism should be cleaned and lubricated.

QRG

Engine Compartment Cover

The component parts in the engine compartment are protected by a cover. You may need to remove the cover when you perform certain maintenance work.

To remove the cover:

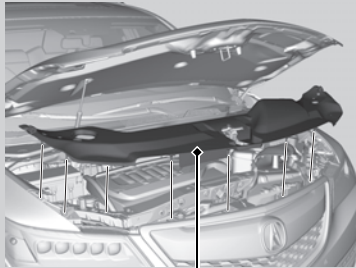

Remove the Engine Compartment Cover

TOC

Maintenance

Index

Home

Recommended Engine Oil

- **Genuine Acura Motor Oil**
- **Premium-grade 0W-20 detergent oil with an API Certification Seal on the container.**



Oil is a major contributor to your engine's performance and longevity. If you drive the vehicle with insufficient or deteriorated oil, the engine may fail or be damaged.

This seal indicates the oil is energy conserving and that it meets the American Petroleum Institute's latest requirements.

Use a Genuine Acura Motor Oil or another commercial engine oil of suitable viscosity for the ambient temperature as shown.

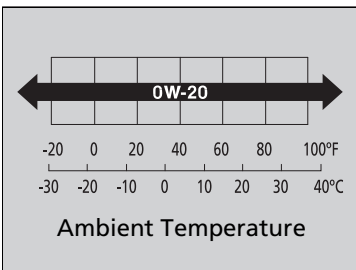

■ Synthetic oil

You may also use synthetic motor oil if it is labeled with the API Certification Seal and is the specified viscosity grade.

►► Recommended Engine Oil

Engine Oil Additives

Your vehicle does not require oil additives. In fact, they may adversely affect the engine performance and durability.

Oil Check

We recommend that you check the engine oil level every time you refuel. Park the vehicle on level ground.

Wait approximately three minutes after turning the engine off before you check the oil.

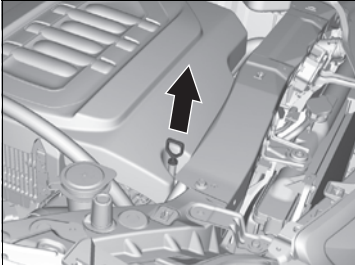

1. Remove the dipstick (orange loop).
2. Wipe the dipstick with a clean cloth or paper towel.
3. Insert the dipstick back all the way into its hole.

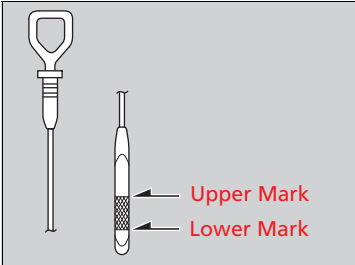

4. Remove the dipstick again, and check the level. It should be between the upper and lower marks. Add oil if necessary.

Oil Check

If the oil level is near or below the lower mark, slowly add oil being careful not to overfill.

Adding Engine Oil

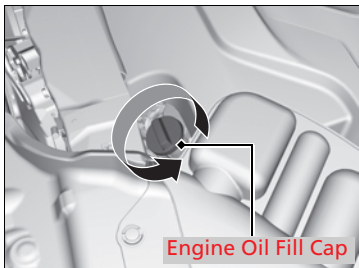

1. Unscrew and remove the engine oil fill cap.
2. Add oil slowly.
3. Reinstall the engine oil fill cap, and tighten it securely.
4. Wait for three minutes and recheck the engine oil dipstick.

Adding Engine Oil

If any oil spills, wipe it up immediately. Spilled oil may damage the engine compartment components.

NOTICE

Do not fill the engine oil above the upper mark. Overfilling the engine oil can result in leaks and engine damage.

Changing the Engine Oil and Oil Filter

You must change the engine oil and oil filter regularly in order to maintain the engine's lubrication. The engine may be damaged if they are not changed regularly.

Change the oil and filter in accordance with the maintenance message on the multi-information display.

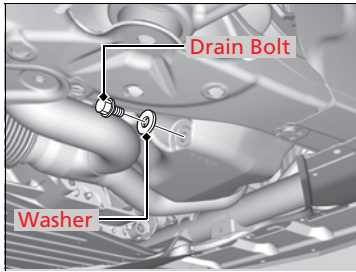

1. Run the engine until it reaches normal operating temperature, and then turn the engine off.
2. Open the hood and remove the engine oil fill cap.
3. Remove the drain bolt and washer from the bottom of the engine, and drain the oil into a suitable container.

Changing the Engine Oil and Oil Filter

NOTICE

You may damage the environment if you do not dispose of the oil in a suitable way. If you are changing the oil by yourself, appropriately dispose of the used oil. Put the oil in a sealed container and take it to a recycling center. Do not throw the oil away into a garbage can or onto the ground.

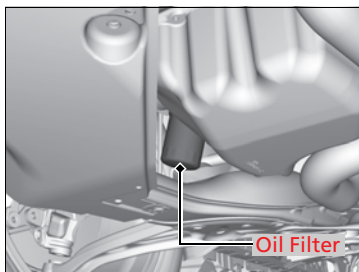

4. Remove the oil filter and dispose of the remaining oil.
5. Check that the filter gasket is not stuck to the engine contact surface.
 - If it is stuck, you must detach it.
6. Wipe away dirt and dust adhering to the contact surface of the oil filter base, and install a new oil filter.
 - Apply a light coat of new engine oil to the oil filter rubber seal.
7. Put a new washer on the drain bolt, then reinstall the drain bolt.
 - Tightening torque:
29 lbf-ft (39 N·m, 4.0 kgf·m)
8. Pour the recommended engine oil into the engine.
 - Engine oil change capacity (including filter):
5.7 US qt (5.4 ℓ)
9. Reinstall the engine oil fill cap securely and start the engine.
10. Run the engine for a few minutes, and then check that there is no leak from the drain bolt or oil filter.
11. Stop the engine, wait for three minutes, and then check the oil level on the dipstick.
 - If necessary, add more engine oil.

✎ Changing the Engine Oil and Oil Filter

You will need a special wrench to replace the oil filter. You can buy this wrench from a dealer.

When installing the new oil filter, follow the instructions supplied with the oil filter.

Reinstall the engine oil fill cap. Start the engine. The low oil pressure indicator should go off within five seconds. If it does not, turn off the engine, and check your work.

Engine Coolant

Specified coolant: Acura Long Life Antifreeze/Coolant Type 2

This coolant is premixed with 50% antifreeze and 50% water. Do not add any straight antifreeze or water.

We recommend you check the engine coolant level every time you refuel. Check the reserve tank first. If it is completely empty, also check the coolant level in the radiator. Add the engine coolant accordingly.

Reserve Tank

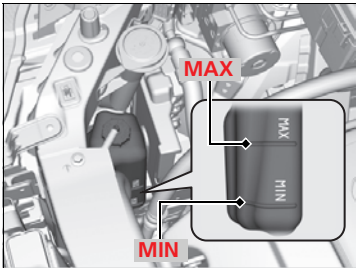

1. Check the amount of coolant in the reserve tank.

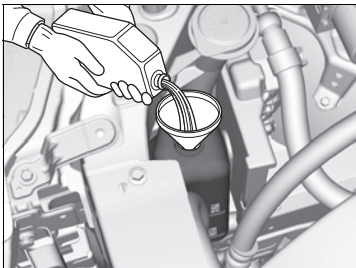

2. If the coolant level is below the **MIN** mark, add the specified coolant until it reaches the **MAX** mark.

3. Inspect the cooling system for leaks.

Engine Coolant

NOTICE

If temperatures consistently below -22°F (-30°C) are expected, the coolant mixture should be changed to a higher concentration. Consult a dealer for more information.

If Honda antifreeze/coolant is not available, you may use another major brand non-silicate coolant as a temporary replacement. Check that it is a high quality coolant recommended for aluminum engines. Continued use of any non-Honda coolant can result in corrosion, causing the cooling system to malfunction or fail. Have the cooling system flushed and refilled with Honda antifreeze/coolant as soon as possible.

Do not add rust inhibitors or other additives to your vehicle's cooling system. They may not be compatible with the coolant or with the engine components.

Radiator

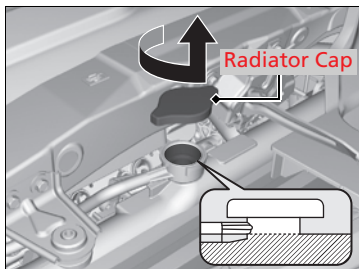

1. **Make sure the engine and radiator are cool.**
2. Remove the engine compartment cover.
 - [Engine Compartment Cover P. 397](#)
3. Turn the radiator cap counterclockwise and relieve any pressure in the coolant system. Do not push the cap down when turning.
4. Push down and turn the radiator cap counterclockwise to remove it.
5. The coolant level should be up to the base of the filler neck. Add coolant if it is low.
6. Put the radiator cap back on, and tighten it fully.
7. Pour coolant into the reserve tank until it reaches the **MAX** mark. Put the cap back on the reserve tank.

Radiator

WARNING

Removing the radiator cap while the engine is hot can cause the coolant to spray out, seriously scalding you.

Always let the engine and radiator cool down before removing the radiator cap.

NOTICE

Pour the fluid slowly and carefully so you do not spill any. Clean up any spills immediately; they can damage components in the engine compartment.

Transmission Fluid

Automatic Transmission Fluid

Specified fluid: Acura ATF DW-1 (automatic transmission fluid)

Have a dealer check the fluid level and replace if necessary.

Automatic Transmission Fluid

NOTICE

Do not mix Acura ATF DW-1 with other transmission fluids.

Using a transmission fluid other than Acura ATF DW-1 may adversely affect the operation and durability of your vehicle's transmission, and damage the transmission.

Any damage caused by using a transmission fluid that is not equivalent to Acura ATF DW-1 is not covered by Acura's new vehicle warranty.

Brake Fluid

Specified fluid: Acura Heavy Duty Brake Fluid DOT 3

■ Checking the Brake Fluid

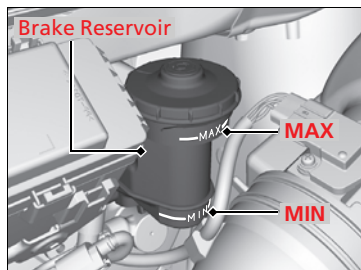

The fluid level should be between the **MIN** and **MAX** marks on the side of the reservoir.

» Brake Fluid

NOTICE

Brake fluid marked DOT 5 is not compatible with your vehicle's braking system and can cause extensive damage.

If the specified brake fluid is not available, you should use only DOT 3 or DOT 4 fluid from a sealed container as a temporary replacement.

Using any non-Acura brake fluid can cause corrosion and decrease the longevity of the system. Have the brake system flushed and refilled with Acura Heavy Duty Brake Fluid DOT 3 as soon as possible.

If the brake fluid level is at or below the **MIN** mark, have a dealer inspect for leaks or worn brake pads as soon as possible.

» Refilling Window Washer Fluid

NOTICE

Do not use engine antifreeze or a vinegar/water solution in the windshield washer reservoir.

Antifreeze can damage your vehicle's paint. A vinegar/water solution can damage the windshield washer pump.

Refilling Window Washer Fluid

If the washer fluid is low, a message appears on the MID. Pour the washer fluid carefully. Do not overflow the reservoir.

Headlight Bulbs

Headlight bulbs are LED type. Have an authorized Acura dealer inspect and replace the light assembly.

Daytime Running Light Bulbs

Daytime running light bulbs are LED type. Have an authorized Acura dealer inspect and replace the light assembly.

Headlight Bulbs

The headlight aim is set by the factory, and does not need to be adjusted. However, if you regularly carry heavy items in the cargo area or tow a trailer, have the aiming readjusted at a dealer or by a qualified technician.

The exterior lights' inside lenses (headlights, brake lamps, etc.) may fog temporarily after a car wash or while driving in the rain. This does not impact the exterior light function.

However, if you see a large amount of water or ice accumulated inside the lenses, have your vehicle inspected by a dealer.

Front Turn Signal/Front Side Marker/Parking Light Bulbs

When replacing, use the following bulbs.

Front Turn Signal/Side Marker/Parking Light: 28/8 W

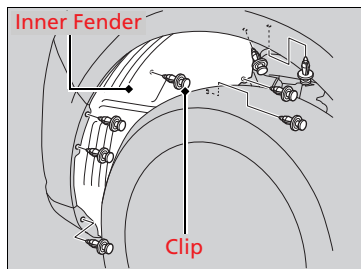

1. Remove the holding clips, and pull the inner fender back.

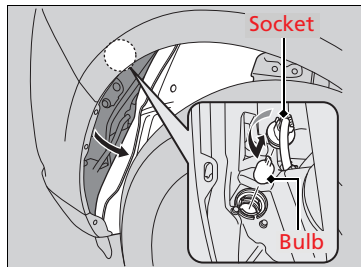

2. Turn the socket to the left and remove it.

3. Remove the old bulb and insert a new bulb.

Front Turn Signal/Front Side Marker/Parking Light Bulbs

Insert a flat-tip screwdriver, lift and remove the center pin to remove the clip.

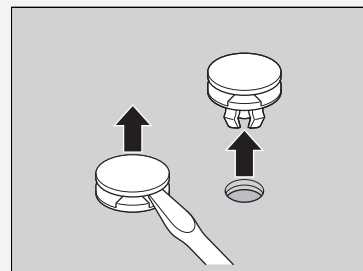

Insert the clip with the center pin raised, and push until it is flat.

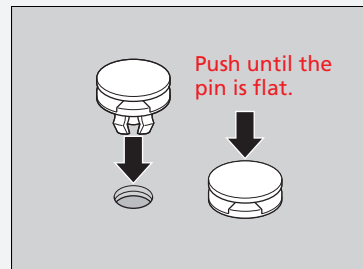

Side Turn Signal/Emergency Indicator Light Bulbs

Door mirrors have the side turn lights. Have an authorized Acura dealer inspect and replace the light assembly.

Brake Light and Turn Signal Light Bulbs

When replacing, use the following bulbs.

Brake Light: 21 W
Rear Turn Signal Light: 21 W

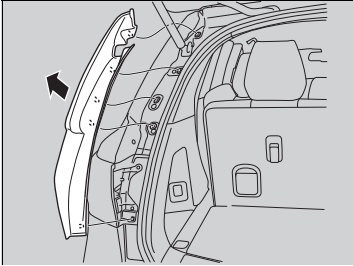

1. Remove the cover.
 - ▶ Starting at the bottom, carefully pull the cover straight out, working upward until all pins are removed from their the grommets.
 - ▶ The grommets should remain in the body.

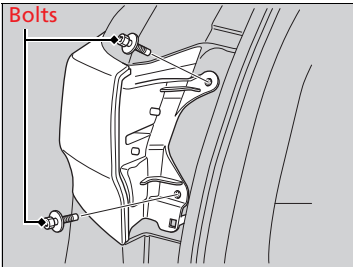

2. Use a Phillip-head screwdriver to remove the bolts.
3. Pull the light assembly out of the rear pillar.

QRG

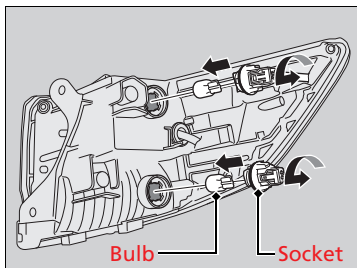

4. Turn the socket to the left and remove it. Remove the old bulb.
5. Insert a new bulb.
6. Slide the light assembly onto the guide on the body.
7. Align the pins with the body grommets, then push in until they fully seat.

Taillight and Rear Side Marker Light Bulbs

Taillight and rear side marker light bulbs are the LED type. Have an authorized Acura dealer inspect and replace the light assembly.

TOC

Maintenance

Index

Home

Back-Up Light

When replacing, use the following bulbs.

Back-Up Light: 21 W

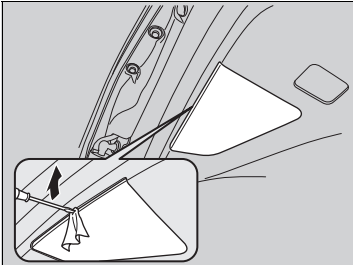

1. Remove the cover by prying on the edge using a flat-tip screwdriver.
 - ▶ Wrap the flat-tip screwdriver with a cloth to prevent scratches.

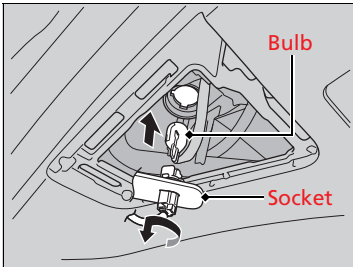

2. Turn the socket to the left and remove it. Remove the old bulb.
3. Insert a new bulb.

QRG

Rear License Plate Light Bulbs

Rear license plate light bulbs are the LED type. Have an authorized Acura dealer inspect and replace the light assembly.

High-Mount Brake Light Bulbs

High-mount brake light bulbs are the LED type. Have an authorized Acura dealer inspect and replace the light assembly.

LED Puddle Light Bulbs

LED puddle light bulbs are LED type. Have an authorized Acura dealer inspect and replace the light assembly.

TOC

Maintenance

Index

Home

Checking Wiper Blades

If the wiper blade rubber has deteriorated, it will leave streaks and the metal wiper arm may scratch the window glass.

Changing the Front Wiper Blade Rubber



1. Lift the driver side wiper arm first, then the passenger side.

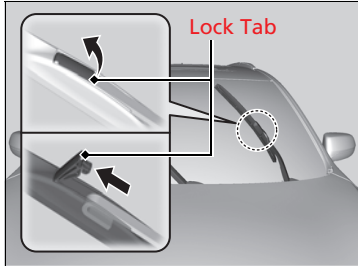

2. Place a cloth on the edge of the lock tab. Push the lock tab up with a flat-tip screw driver.
3. Slide the blade from the wiper arm.

Changing the Front Wiper Blade Rubber

NOTICE

Avoid dropping the wiper arm; it may damage the windshield.

QRG

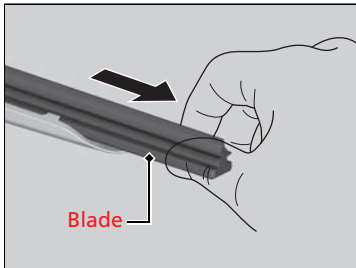

4. Slide the wiper blade out from its holder by pulling the tabbed end out.

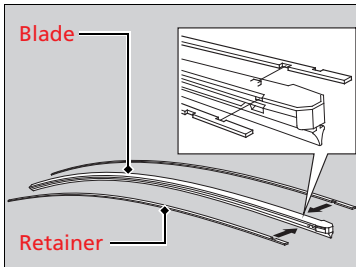

5. Remove the retainers from the rubber blade that has been removed, and mount to a new rubber blade.
▶ Correctly align the rubber protrusion and the retainer grooves.

TOC

Maintenance

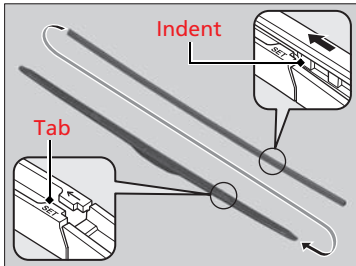

6. Slide the new wiper blade onto the holder from the bottom end.
▶ The tab on the holder should fit in the indent of the wiper blade.

7. Slide the wiper blade onto the wiper arm, then push down the lock tab.

8. Lower the passenger side wiper arm first, then the driver side.

Index

Home

Changing the Rear Wiper Blade Rubber

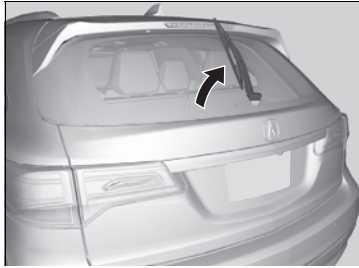

1. Raise the wiper arm off.

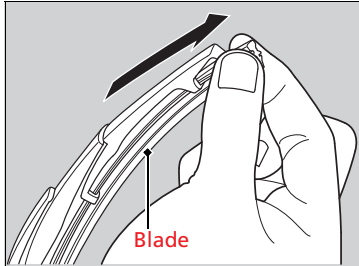

2. Slide the wiper blade out from the end with the indent.

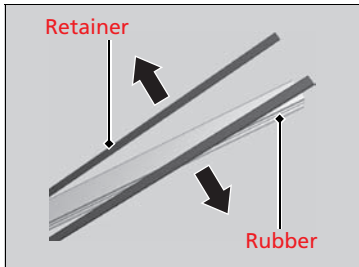

3. Remove the retainers from wiper blade and mount to a new rubber blade.

Changing the Rear Wiper Blade Rubber

NOTICE

Avoid dropping the wiper arm; it may damage the windshield.

QRG

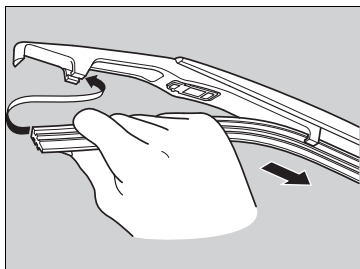

4. Slide the wiper blade onto the holder.
 - ▶ Make sure it is engaged correctly, then install the wiper blade assembly onto the wiper arm.

TOC

Maintenance

Index

Home

Checking Tires

To safely operate your vehicle, your tires must be of the proper type and size, in good condition with adequate tread, and properly inflated.

■ Inflation guidelines

Properly inflated tires provide the best combination of handling, tread life, and comfort. Refer to the driver's doorjamb label or specification's page for the specified pressure.

Underinflated tires wear unevenly, adversely affect handling and fuel economy, and are more likely to fail from overheating.

Overinflated tires make your vehicle ride harshly, are more prone to road hazards, and wear unevenly.

Every day before you drive, look at each of the tires. If one looks lower than the others, check the pressure with a tire gauge.

At least once a month and before long trips, use a gauge to measure the pressure in all tires, including the spare. Even tires in good condition can lose 1 to 2 psi (10 to 20 kPa, 0.1 to 0.2 kgf/cm²) per month.

■ Inspection guidelines

Every time you check inflation, also examine the tires and valve stems.

Look for:

- Bumps or bulges on the side or in the tread. Replace the tire if you find any cuts, splits, or cracks in the side of the tire. Replace it if you see fabric or cord.
- Remove any foreign objects and inspect for air leaks.
- Uneven tread wear. Have a dealer check the wheel alignment.
- Excessive tread wear.
 - [Wear Indicators P. 422](#)
- Cracks or other damage around valve stem.

☒ Checking Tires

⚠ WARNING

Using tires that are excessively worn or improperly inflated can cause a crash in which you can be seriously hurt or killed.

Follow all instructions in this owner's manual regarding tire inflation and maintenance.

Measure the air pressure when tires are cold. This means the vehicle has been parked for at least three hours, or driven less than 1 mile (1.6 km). If necessary, add or release air until the specified pressure is reached.

If checked when hot, tire pressure can be as much as 4–6 psi (30–40 kPa, 0.3–0.4 kgf/cm²) higher than if checked when cold.

Have a dealer check the tires if you feel a consistent vibration while driving. New tires and any that have been removed and reinstalled should be properly balanced.

QRG

Tire and Loading Information Label

The label attached to the driver's doorjamb provides necessary tire and loading information.

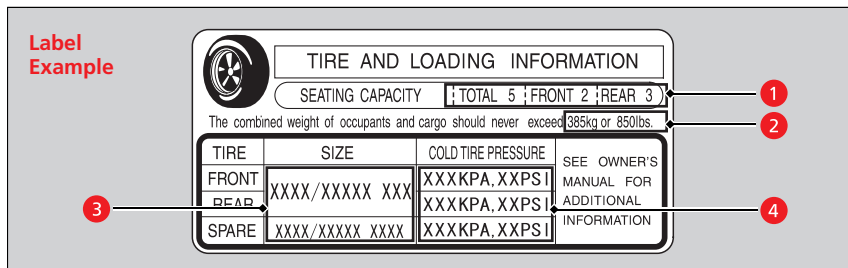

▶▶ Tire and Loading Information Label

The tire and loading information label attached to the driver's doorjamb contains:

- 1 The number of people your vehicle can carry.
- 2 The total weight your vehicle can carry. Do not exceed this weight.
- 3 The original tire sizes for front, rear, and spare.
- 4 The proper cold tire pressure for front, rear, and spare.

Tire Labeling

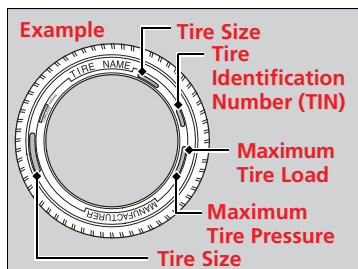

The tires that came on your vehicle have a number of markings. Those you should be aware of are described below.

▶▶ Tire Sizes

Following is an example of tire size with an explanation of what each component means.

P235/60R18 102V

- P:** Vehicle type (P indicates passenger vehicle).
- 235:** Tire width in millimeters.
- 60:** Aspect ratio (the tire's section height as a percentage of its width).
- R:** Tire construction code (R indicates radial).
- 18:** Rim diameter in inches.
- 102:** Load index (a numerical code associated with the maximum load the tire can carry).
- V:** Speed symbol (an alphabetical code indicating the maximum speed rating).

TOC

Maintenance

Index

Home

■ Tire Sizes

Whenever tires are replaced, they should be replaced with tires of the same size.

■ Tire Identification Number (TIN)

The tire identification number (TIN) is a group of numbers and letters that look like the example in the side column. TIN is located on the sidewall of the tire.

■ Glossary of Tire Terminology

Cold Tire Pressure – The tire air pressure when the vehicle has been parked for at least three hours or driven less than 1 mile (1.6 km).

Load Rating – Means the maximum load that a tire is rated to carry for a given inflation pressure.

Maximum Inflation Pressure – The maximum tire air pressure that the tire can hold.

Maximum Load Rating – Means the load rating for a tire at the maximum permissible inflation pressure for that tire.

Recommended Inflation Pressure – The cold tire inflation pressure recommended by the manufacturer.

Treadwear Indicators (TWI) – Means the projections within the principal grooves designed to give a visual indication of the degrees of wear of the tread.

☒ Tire Identification Number (TIN)

DOT B97R FW6X 2209

DOT: This indicates that the tire meets all requirements of the U.S. Department of Transportation.

B97R: Manufacturer's identification mark.

FW6X: Tire type code.

22 09: Date of manufacture.

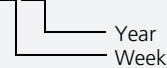

DOT Tire Quality Grading (U.S. Vehicles)

The tires on your vehicle meet all U.S. Federal Safety Requirements. All tires are also graded for treadwear, traction, and temperature performance according to Department of Transportation (DOT) standards. The following explains these gradings.

Uniform Tire Quality Grading

Quality grades can be found where applicable on the tire sidewall between tread houlder and maximum section width.

Treadwear

The treadwear grade is a comparative rating based on the wear rate of the tire when tested under controlled conditions on a specified government test course. For example, a tire graded 150 would wear one and one-half (1 1/2) times as well on the government course as a tire graded 100. The relative performance of tires depends upon the actual conditions of their use, however, and may depart significantly from the norm due to variations in driving habits, service practices and differences in road characteristics and climate.

Uniform Tire Quality Grading

For example:

Treadwear 200

Traction AA

Temperature A

All passenger car tires must conform to Federal Safety Requirements in addition to these grades.

■ Traction

The traction grades, from highest to lowest, are AA, A, B, and C. Those grades represent the tire's ability to stop on wet pavement as measured under controlled conditions on specified government test surfaces of asphalt and concrete. A tire marked C may have poor traction performance.

■ Temperature

The temperature grades are A (the highest), B, and C, representing the tire's resistance to the generation of heat and its ability to dissipate heat when tested under controlled conditions on a specified indoor laboratory test wheel. Sustained high temperature can cause the material of the tire to degenerate and reduce tire life, and excessive temperature can lead to sudden tire failure. The grade C corresponds to a level of performance which all passenger car tires must meet under the Federal Motor Vehicle Safety Standard No. 109. Grades B and A represent higher levels of performance on the laboratory test wheel than the minimum required by law.

☒ Traction

Warning: The traction grade assigned to this tire is based on straight-ahead braking traction tests, and does not include acceleration, cornering, hydroplaning, or peak traction characteristics.

☒ Temperature

Warning: The temperature grade for this tire is established for a tire that is properly inflated and not overloaded. Excessive speed, underinflation, or excessive loading, either separately or in combination, can cause heat buildup and possible tire failure.

QRG

Wear Indicators

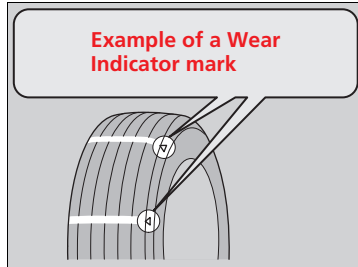

The groove where the wear indicator is located is 1/16 inch (1.6 mm) shallower than elsewhere on the tire. If the tread has worn so that the indicator is exposed, replace the tire.

Worn out tires have poor traction on wet roads.

Tire Service Life

The life of your tires is dependent on many factors, including driving habits, road conditions, vehicle loading, inflation pressure, maintenance history, speed, and environmental conditions (even when the tires are not in use).

In addition to regular inspections and inflation pressure maintenance, it is recommended that you have annual inspections performed once the tires reach five years old. All tires, including the spare, should be removed from service after 10 years from the date of manufacture, regardless of their condition or state of wear.

TOC

Maintenance

Index

Home

Tire and Wheel Replacement

Replace your tires with radials of the same size, load range, speed rating, and maximum cold tire pressure rating (as shown on the tire's sidewall). Using tires of a different size or construction can cause the ABS and VSA® (vehicle stability assist) system to work incorrectly.

It is best to replace all four tires at the same time. If that isn't possible, replace the front or rear tires in pairs.

If you replace a wheel, only use TPMS specified wheels approved for your vehicle.

Make sure that the wheel's specifications match those of the original wheels.

⚠ Tire and Wheel Replacement

⚠ WARNING

Installing improper tires on your vehicle can affect handling and stability. This can cause a crash in which you can be seriously hurt or killed.

Always use the size and type of tires recommended in this owner's manual.

Tire Rotation

Rotating tires according to the maintenance messages on the MID helps to distribute wear more evenly and increase tire life.

■ Tires without rotation marks

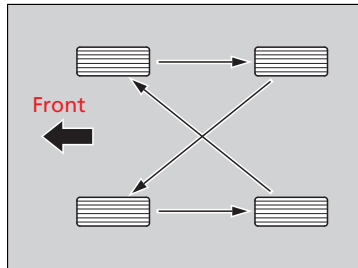

Rotate the tires as shown here.

■ Tires with rotation marks

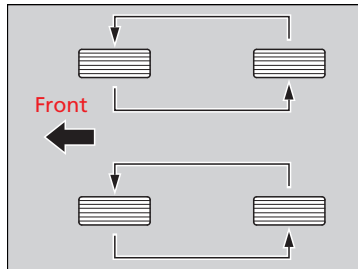

Rotate the tires as shown here.

►► Tire Rotation

Tires with directional tread patterns should only be rotated front to back (not from one side to the other). Directional tires should be mounted with the rotation indication mark facing forward, as shown below.

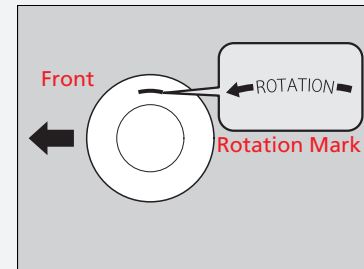

Winter Tires

If driving on snowy or frozen roads, mount all season marked "M+S" tires, snow tires, or tire chains; reduce speed; and maintain sufficient distance between vehicles when driving.

Be particularly careful when operating the steering wheel or brakes to prevent skidding.

Use tire chains, snow tires, or all season tires when necessary or according to the law.

When mounting, refer to the following points.

For winter tires:

- Select the size and load ranges that are the same as the original tires.
- Mount the tires to all four wheels.

For tire chains:

- Install them on the front tires only.
- Because your vehicle has limited tire clearance, we strongly recommend using the chains listed below:

Cable-type: SCC Cable Chain ZT735

- Follow the chain manufacturer's instruction when installing. Mount them as tightly as you can.
- Check that the chains do not touch the brake lines or suspension.
- Drive slowly.

Winter Tires

⚠ WARNING

Using the wrong chains, or not properly installing chains, can damage the brake lines and cause a crash in which you can be seriously injured or killed.

Follow all instructions in this owner's manual regarding the selection and use of tire chains.

NOTICE

Traction devices that are the wrong size or improperly installed can damage your vehicle's brake lines, suspension, body, and wheels. Stop driving if they are hitting any part of the vehicle.

When tire chains are mounted, follow the chain manufacturer's instructions regarding vehicle operational limits.

If your vehicle is equipped with summer tires, be aware that these tires are not designed for winter driving conditions. For more information, contact a dealer.

Checking the Battery

The battery condition is being monitored by the sensor on the negative terminal. If there is a problem with the sensor, the warning message on MID will let you know. Have your vehicle checked by a dealer.

If your vehicle's battery is disconnected or goes dead:

- The audio system is disabled.
 - [Audio System Theft Protection P. 201](#)
- The clock resets.
 - [Clock P. 114](#)
- The navigation system* is disabled.
 - [Refer to navigation system manual](#)

Charging the Battery

Disconnect both battery cables to prevent damaging your vehicle's electrical system. Always disconnect the negative (-) cable first, and reconnect it last.

ⓘ Battery

WARNING

The battery gives off explosive hydrogen gas during normal operation.

A spark or flame can cause the battery to explode with enough force to kill or seriously hurt you.

When conducting any battery maintenance, wear protective clothing and a face shield, or have a skilled technician do it.

WARNING: Battery post, terminals, and related accessories contain lead and lead compounds.

Wash your hands after handling.

When you find corrosion, clean the battery terminals by applying a baking powder and water solution. Clean the terminals with a damp towel. Cloth/towel dry the battery. Coat the terminals with grease to help prevent future corrosion.

When replacing the battery, the replacement must be of the same specifications.

Please consult a dealer for more information.

Replacing the Button Battery

Models without remote control engine start system

If the indicator does not come on when the button is pressed, replace the battery.

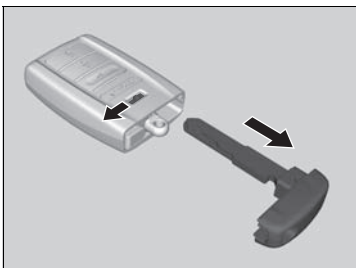

Battery type: CR2032

1. Remove the built-in key.
2. Remove the upper half by carefully prying on the edge with a coin.
▶ Wrap a coin with a cloth to prevent scratching the transmitter.
3. Make sure to replace the battery with the correct polarity.

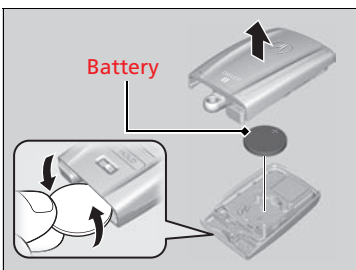

Replacing the Button Battery

NOTICE

An improperly disposed of battery can damage the environment. Always confirm local regulations for battery disposal.

Replacement batteries are commercially available or at a dealer.

Models with remote control engine start system

If the indicator does not come on when the button is pressed, replace the battery.

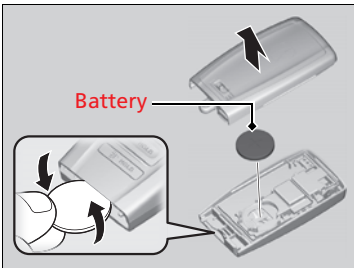
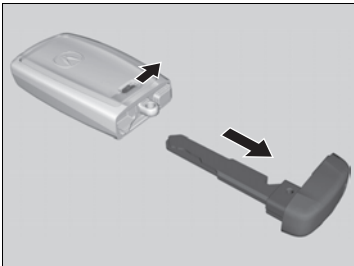

Battery type: CR2032

1. Remove the built-in key.
 - ▶ As a convenience, lightly place masking tape over the remote buttons to hold them in place.
2. Remove the upper half by carefully prying on the edge with a coin.
 - ▶ Wrap a coin with a cloth to prevent scratching the transmitter.
3. Press down on the center of the assembly and remove the battery.
 - ▶ When removing the button battery, be careful not to touch parts around it.
4. Make sure to replace the battery with the correct polarity.

▶▶ Replacing the Button Battery

Models with remote control engine start system

NOTICE

The Remote transmitter is equipped with two batteries: A standard replaceable CR2032 coin button battery and an integral non-replaceable rechargeable battery. To prevent permanent damage to the rechargeable battery, replace the CR2032 battery every three to four years.

Models with Rear Entertainment System

Replacing the Battery

Remote Control

If it takes several pushes on the remote control buttons to operate the rear entertainment system, replace the battery.

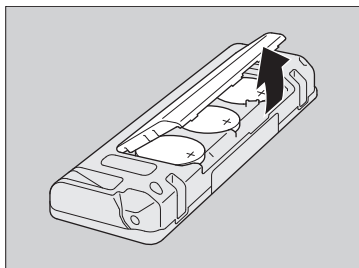

Battery type: BR3032

1. Remove the cover.
2. Make sure to replace the battery with the correct polarity.

Replacing the Battery

NOTICE

An improperly disposed of battery can damage the environment. Always confirm local regulations for battery disposal.

Replacement batteries are commercially available or at a dealer.

■ Wireless Headphone

If there is no sound coming from the wireless headphone, replace the battery.

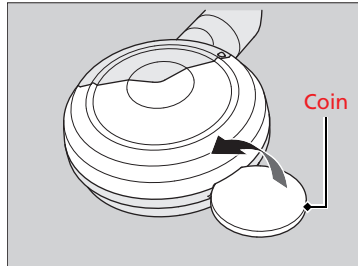

Battery type: AAA

1. To open the cover, insert a coin in the slot and twist it slightly to pry the cover away from the earpiece.
2. Make sure to replace the battery with the correct polarity.

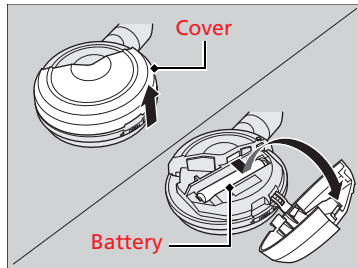

Dust and Pollen Filter

The climate control system is equipped with a dust and pollen filter that collects pollen, dust, and other debris in the air. The Maintenance Minder™ messages will let you know when to replace the filter.

We recommend that you replace the dust and pollen filter sooner when using your vehicle in areas with high concentrations of dust.

☒ Dust and Pollen Filter

If the airflow from the climate control system deteriorates noticeably, and the windows fog up easily, the filter may need to be replaced. Please contact a dealer for replacement.

Interior Care

Use a damp cloth with a mixture of mild detergent and warm water to remove dirt. Use a clean cloth to remove detergent residue.

■ Cleaning Seat Belts

Use a soft brush with a mixture of mild soap and warm water to clean the seat belts. Let the belts air dry. Wipe the openings of the seat belt anchors using a clean cloth.



▣ Interior Care

Do not spill liquids inside the vehicle.

Electrical devices and systems may malfunction if liquids are splashed on them.

Do not use silicone based sprays on electrical devices such as audio devices and switches.

Doing so may cause the items to malfunction or a fire inside the vehicle.

If a silicone based spray is inadvertently used on electrical devices, consult a dealer.

Depending on their composition, chemicals and liquid aromatics may cause discoloration, wrinkles, and cracking to resin-based parts and textiles.

Do not use alkali solvents or organic solvents such as benzene or gasoline.

After using chemicals, make sure to gently wipe them off using a dry cloth.

Do not place used cloths on top of resin based parts or textiles for long periods of time without washing.

Floor Mats

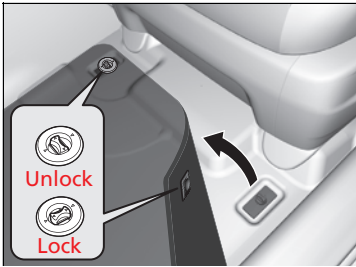

The front floor mats hook over the floor anchors, which keep the mats from sliding forward. To remove a mat for cleaning, turn the anchor knobs to the unlock position. When reinstalling the mat after cleaning, turn the knobs to the lock position.

Do not put additional floor mats on top of the anchored mat.

Maintaining Genuine Leather

Vacuum dirt and dust from the leather frequently. Pay close attention to the pleats and seams. Clean the leather with a soft cloth dampened with a 90% water and 10% neutral soap solution. Then buff it with a clean, dry cloth. Remove any dust or dirt on leather surfaces immediately.

Floor Mats

If you use any floor mats that were not originally provided with your vehicle, make sure they are designed for your specific vehicle, fit correctly, and are securely anchored by the floor anchors. Position the rear seat floor mats properly. If they are not properly positioned, the floor mats can interfere with the front seat functions.

Exterior Care

Dust off the vehicle body after you drive.

Regularly inspect your vehicle for scratches on painted surfaces. A scratch on a painted surface can result in body rust. If you find a scratch, promptly repair it.

■ Washing the Vehicle

Wash the vehicle regularly. Wash more frequently when driving in the following conditions:

- If driving on roads with road salt.
- If driving in coastal areas.
- If tar, soot, bird droppings, insects, or tree sap are stuck to painted surfaces.

■ Using an Automated Car Wash

Fold in the door mirrors.

Make sure to follow the instructions indicated on the automated car wash.

■ Using High Pressure Cleaners

- Keep sufficient distance between the cleaning nozzle and the vehicle body.
- Take particular care around the windows. Standing too close may cause water to enter the vehicle interior. Do not spray water into the engine compartment.

⌘ Washing the Vehicle

Do not spray water into the air intake vents or engine compartment. It can cause a malfunction.

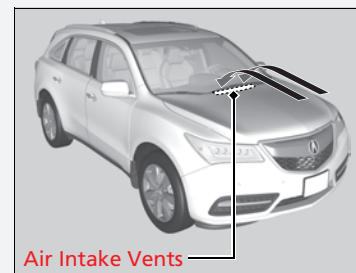

■ Applying Wax

A good coat of automotive body wax helps protect your vehicle's paint from the elements. Wax will wear off over time and expose your vehicle's paint to the elements, so reapply as necessary.

■ Maintaining the Bumpers and Other Resin Coated Parts

If you get gasoline, oil, engine coolant, or battery fluid on resin coated parts, they may be stained or the coating may peel. Promptly wipe it away using a soft cloth and clean water.

■ Cleaning the Window

Wipe using a glass cleaner.

■ Maintaining Aluminum Wheels

Aluminum is susceptible to deterioration caused by salt and other road contaminants. Use a sponge and mild detergent to wipe away promptly.

Be careful not to use harsh chemicals (including some commercial wheel cleaners) or a stiff brush. They can damage the clear coat of the aluminum alloy wheels that helps keep the aluminum from corroding and tarnishing.

☒ Applying Wax

NOTICE

Chemical solvents and strong cleaners can damage the paint, metal, and plastic on your vehicle. Wipe up spills immediately.

☒ Maintaining the Bumpers and Other Resin Coated Parts

Ask a dealer about the correct coating material when you want to repair the painted surface of the parts made of resin.

☒ Cleaning the Window

Wires are mounted to the inside of the rear window. Wipe along the same direction as the wires with a soft cloth so as not to damage them.

Handling the Unexpected

This chapter explains how to handle unexpected troubles.



Tools

Types of Tools..... 438

If a Tire Goes Flat

Changing a Flat Tire* 439

Temporarily Repairing a Flat Tire* 446

Engine Does Not Start

Checking the Engine 457

If the Keyless Access Remote Battery is

Weak 458

Emergency Engine Stop 459

Jump Starting 460

Shift Lever Does Not Move 462

Overheating

How to Handle Overheating..... 463

Indicator, Coming On/Blinking

If the Low Oil Pressure Indicator

Comes On 465

If the Charging System Indicator

Comes On 465

If the Malfunction Indicator Lamp

Comes On or Blinks 466

If the Brake System Indicator (Red)

Comes On 467

If the Speed-Sensitive Electric Power Steering

(EPS) System Indicator Comes On 467

If the Low Tire Pressure/TPMS Indicator

Comes On or Blinks 468

Fuses

Fuse Locations 469

Inspecting and Changing Fuses 474

Emergency Towing 475

When You Cannot Unlock the Fuel Fill

Door 476

When You Cannot Open the Tailgate .. 477

* Not available on all models

Types of Tools

Types of Tools

The tools are stored in the cargo area.

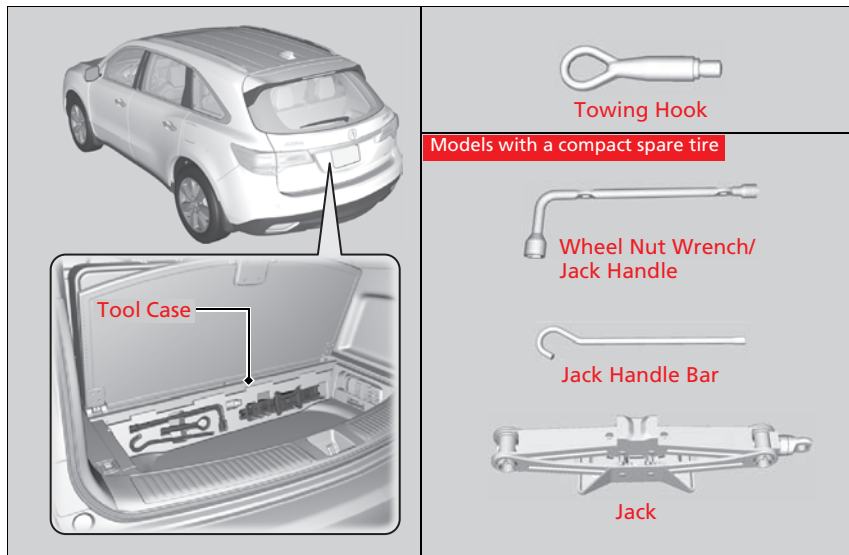

Changing a Flat Tire*

If a tire goes flat while driving, grasp the steering wheel firmly, and brake gradually to reduce speed. Then, stop in a safe place. Replace the flat tire with a compact spare tire. Go to a dealer as soon as possible to have the full-size tire repaired or replaced.

1. Park the vehicle on firm, level, non-slippery surface and apply the parking brake.
2. Move the shift lever to **P**.
3. Turn on the hazard warning lights and set the power mode to VEHICLE OFF (LOCK).

Changing a Flat Tire*

Periodically check the tire pressure of the compact spare. It should be set to the specified pressure.
Specified Pressure: 60 psi (420 kPa, 4.2 kgf/cm²)

When driving with the compact spare tire, keep the vehicle speed under 50 mph (80 km/h). Replace with a full-size tire as soon as possible.

The compact spare tire and wheel in your vehicle are specifically for this model.

Do not use them with another vehicle.

Do not use another type of compact spare tire or wheel with your vehicle.

Do not mount tire chains on a compact spare tire. If a chain-mounted front tire goes flat, remove one of the full-size rear tires and replace it with the compact spare tire. Remove the flat front tire and replace it with the full-size tire that was removed from the rear. Mount the tire chains on the front tire.

Do not use a puncture-repairing agent on a flat tire, as it can damage the tire pressure sensor.

* Not available on all models

■ Getting Ready to Replace the Flat Tire

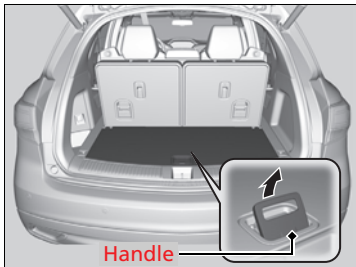

1. Push the rear edge of the handle on the floor lid and open the lid.



2. Take out the cargo floor box.

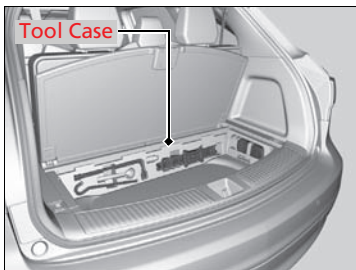

3. Take the jack, wheel nut wrench, and jack handle bar out of the tool case.

✕ Changing a Flat Tire*

NOTICE

Do not use the jack if it doesn't work properly. Call your dealer or a professional towing service.

QRG

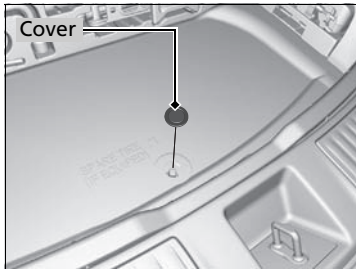

4. Remove the cover on the cargo area lining to access the shaft for the spare tire hoist.

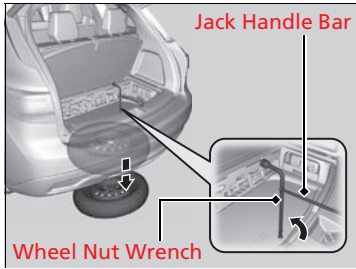

5. Put the wheel nut wrench with the jack handle bar on the hoist shaft. Turn the wrench to the left to lower the spare tire to the ground.

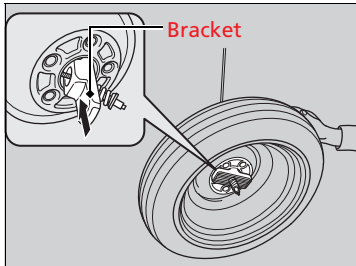

6. Keep turning the wheel nut wrench to create slack in the cable.
7. Remove the bracket from the spare tire.

Handling the Unexpected

TOC

Index

Home

QRG

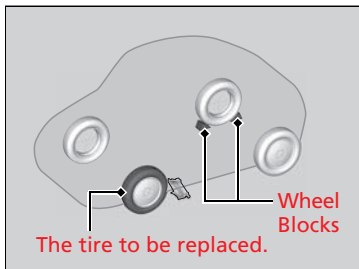

8. Place a wheel block or rock in front and rear of the wheel diagonal to the flat tire.

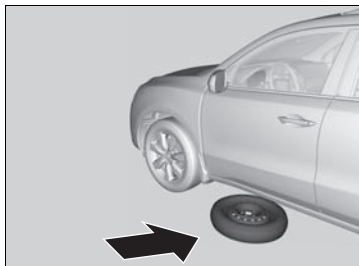

9. Place the compact spare tire wheel side up under the vehicle body, near the tire that needs to be replaced.



10. Loosen each wheel nut about one turn using the wheel nut wrench.

Handling the Unexpected

TOC

Index

Home

How to Set Up the Jack

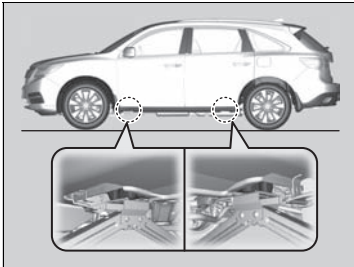

1. Place the jack under the jacking point closest to the tire to be changed.



2. Turn the end bracket clockwise as shown in the image until the top of the jack contacts the jacking point.
 - ▶ Make sure that the jacking point tab is resting in the jack notch.

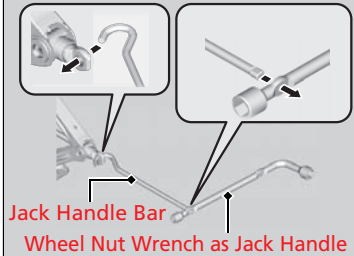

3. Raise the vehicle, using the jack handle bar and the jack handle, until the tire is off the ground.

How to Set Up the Jack

⚠ WARNING

The vehicle can easily roll off the jack, seriously injuring anyone underneath.

Follow the directions for changing a tire exactly, and never get under the vehicle when it is supported only by the jack.

Do not use the jack with people or luggage in the vehicle.

Use the jack provided in your vehicle.

Other jacks may not support the weight ("load") or may not fit in the jacking point.

The following instructions must be followed to use the jack safely.

- Do not use while the engine is running.
- Use only where the ground is firm and level.
- Use only at the jacking points.
- Do not get in the vehicle while using the jack.
- Do not put anything on top of or underneath the jack.

■ Replacing the Flat Tire

▣ Replacing the Flat Tire

Do not over tighten the wheel nuts by applying extra torque using your foot or a pipe.

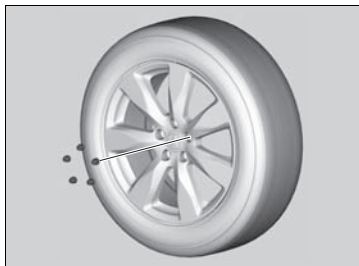

1. Remove the wheel nuts and flat tire.

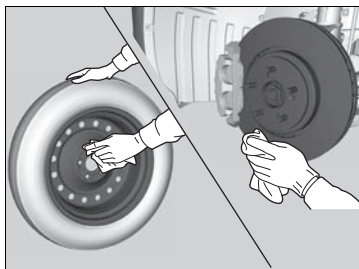

2. Wipe the mounting surfaces of the wheel with a clean cloth.

3. Mount the compact spare tire.

4. Screw the wheel nuts until they touch the lips around the mounting holes, then stop rotating.

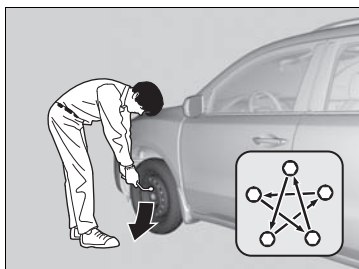

5. Lower the vehicle and remove the jack. Tighten the wheel nuts in the order indicated in the image. Go around, tightening the nuts, two to three times in this order.

Wheel nut torque:

80 lbf-ft (108 N·m, 11 kgf·m)

Storing the Flat Tire

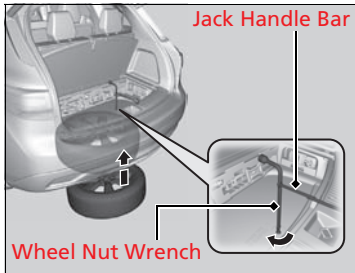

1. Remove the center cap and place the flat tire face up under the hoist.
2. Insert the hoist bracket into the center hole of the flat tire.
3. Turn the wheel nut wrench with the jack handle bar clockwise until the flat tire rests against the underbody of the vehicle and you hear the hoist click.
4. Securely put the jack and wheel nut wrench back in the tool case. Store the case in the cargo area.

TPMS and the Spare Tire

If you replace a flat tire with the spare tire, the low tire pressure/TPMS indicator comes on while you are driving. After driving for a few miles (kilometers), the indicator will start blinking for a short time and then stay on.

Tire Pressure Monitor Problem appears on the multi-information display (MID), but this is normal.

If you replace the tire with a specified regular tire, the warning message on the MID and the low tire pressure/TPMS indicator will go off after a few miles (kilometers).

Storing the Flat Tire

⚠ WARNING

Loose items can fly around the interior in a crash and can seriously injure the occupants.
Store the jack and tools securely before driving.

TPMS and the Spare Tire

The system cannot monitor the pressure of the spare tire. Manually check the spare tire pressure to be sure that it is correct.

Use the TPMS specific wheels. Each is equipped with a tire pressure sensor mounted inside the tire behind the valve stem.

Temporarily Repairing a Flat Tire*

If the tire has a large cut or is otherwise severely damaged, you will need to have the vehicle towed. If the tire only has a small puncture, from a nail for instance, you can use the temporary tire repair kit so that you can drive to the nearest service station for a more permanent repair.

If a tire goes flat while driving, grasp the steering wheel firmly, and brake gradually to reduce speed. Then stop in a safe place.

1. Park the vehicle on a firm, level, and non-slippery surface and apply the parking brake.
2. Move the shift lever to **P**.
3. Turn on the hazard warning lights and set the power mode to VEHICLE OFF OFF (LOCK).

Getting Ready to Temporarily Repair the Flat Tire

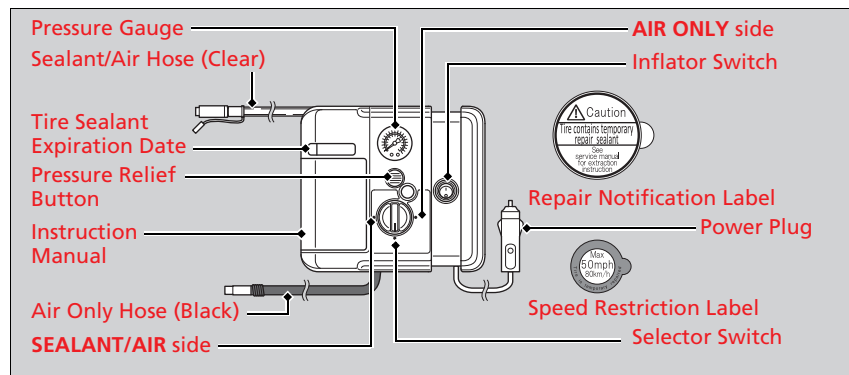

Temporarily Repairing a Flat Tire*

The kit should not be used in the following situations. Instead, contact a dealer or a roadside assistant to have the vehicle towed.

- The tire sealant has expired.
- More than two tires are punctured.
- The puncture or cut is larger than 3/16 inch (4mm).
- The tire side wall is damaged or the puncture is outside the contact area.

 <p>Contact Area</p>	When the puncture is:	Kit Use
	Smaller than 3/16 inch (4 mm)	Yes
	Larger than 3/16 inch (4 mm)	No

- Damage has been caused by driving with the tire extremely under inflated.
- The tire bead is no longer seated.
- The rim is damaged.

Do not remove a nail or screw that punctured the tire. If you remove it from the tire, you may not be able to repair the puncture using the kit.

NOTICE

Do not use a puncture-repairing agent other than the one provided in the kit that came with your vehicle. If a different agent is used, you may permanently damage the tire pressure sensor.



1. Pull the handle on the cargo area floor lid and open the lid.



2. Take out the cargo floor box.

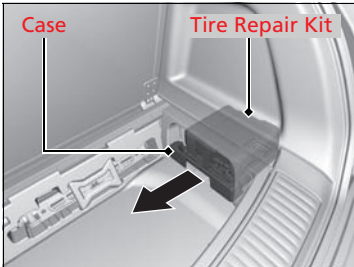

3. Take the kit out of the case.
 4. Place the kit face up, on flat ground near the flat tire, and away from traffic. Do not place the kit on its side.

► Getting Ready to Temporarily Repair the Flat Tire

When making a temporary repair, carefully read the instruction manual provided with the kit.

■ Injecting Sealant and Air

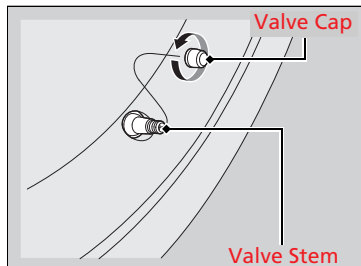

1. Remove the valve cap from the tire valve stem.

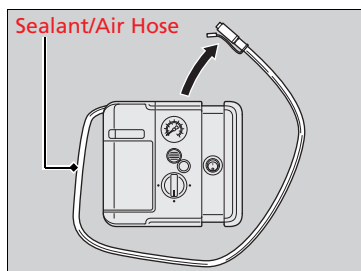

2. Remove the sealant/air hose from the packaging.

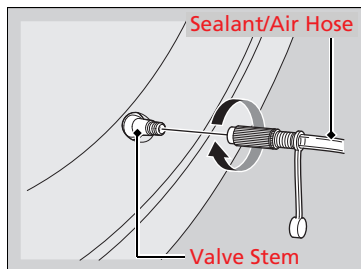

3. Attach the sealant/air hose onto the tire valve stem. Screw it until it is tight.

▶▶ Injecting Sealant and Air

⚠ WARNING

Tire sealant contains substances that are harmful and can be fatal if swallowed.

If accidentally swallowed, do not induce vomiting. Drink plenty of water and get medical attention immediately.

For skin or eye contact, flush with cool water and get medical attention if necessary.

In cold temperatures, the sealant may not flow easily. In this situation, warm it up for five minutes before using.

The sealant can permanently stain clothing and other materials. Be careful during handling and wipe away any spills immediately.

QRG

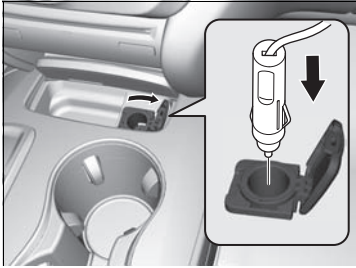

4. Plug in the compressor to the accessory power socket.

- ▶ Be careful not to pinch the cord in a door or window.
 - ▶ Do not plug any other electronic devices into other accessory power sockets.
- [Accessory Power Sockets P. 178](#)

5. Start the engine.

- ▶ Keep the engine running while injecting sealant and air.
- [Carbon Monoxide Gas P. 66](#)

6. Turn the selector switch to **SEALANT/AIR**.

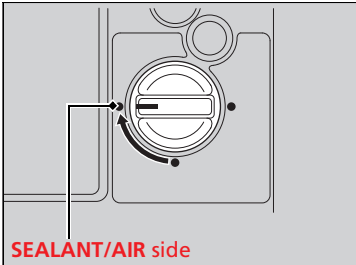

▶▶ Injecting Sealant and Air

⚠ WARNING

Running the engine with the vehicle in an enclosed or even partly enclosed area can cause a rapid build-up of toxic carbon monoxide.

Breathing this colorless, odorless gas can cause unconsciousness and even death. Only run the engine to power the air compressor with the vehicle outdoors.

NOTICE

Do not operate the temporary tire repair kit compressor for more than 15 minutes. The compressor can overheat and become permanently damaged.

Until the sealant injection is complete, the pressure shown on the pressure gauge will appear higher than actual. After the sealant injection is complete the pressure will drop and then begin to rise again as the tire is inflated with air. This is normal. To accurately measure the air pressure using the gauge, turn the air compressor off only after the sealant injection is complete.

Handling the Unexpected

TOC

Index

Home

QRG

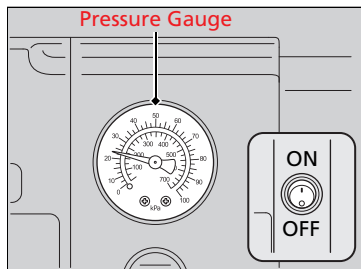

7. Press the inflator switch to turn on the compressor.
 - ▶ The compressor starts injecting sealant and air into the tire.
8. When the sealant injection is complete, continue to add air.
9. After the air pressure reaches 35 psi (240 kPa), turn off the kit.
 - ▶ To check the pressure, occasionally turn off the compressor and read the gauge.

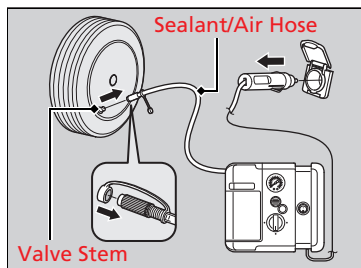

10. Unplug the power plug from the accessory power socket.
11. Unscrew the sealant/air hose from the tire valve stem. Reinstall the valve cap.

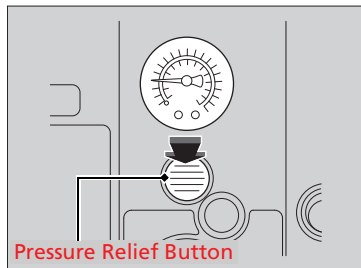

12. Press the pressure relief button until the gauge returns to 0 psi (0 kPa).

▶▶ Injecting Sealant and Air

If the required air pressure is not reached within 15 minutes, the tire may be too severely damaged for the kit to provide the necessary seal and your vehicle will need to be towed.

See an Acura dealer for a replacement sealant bottle and proper disposal of an empty bottle.

Handling the Unexpected

TOC

Index

Home

QRG

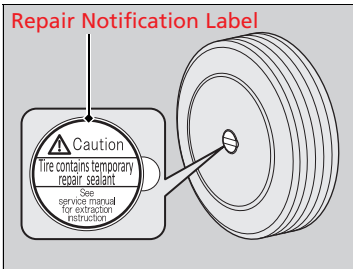

13. Apply the repair notification label to the flat surface of the wheel.
 - ▶ The wheel surface must be clean to ensure the label adheres properly.

Handling the Unexpected

■ Distributing the Sealant in the Tire

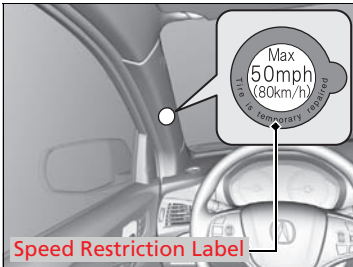

1. Apply the speed restriction label to the location as shown.
2. Drive the vehicle for about 10 minutes.
 - ▶ Do not exceed 50 mph (80 km/h).
3. Stop the vehicle in a safe place.

TOC

Index

Home

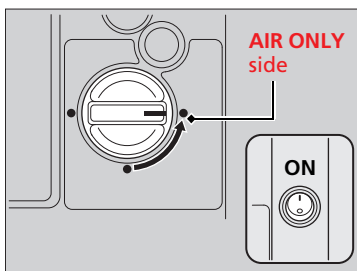
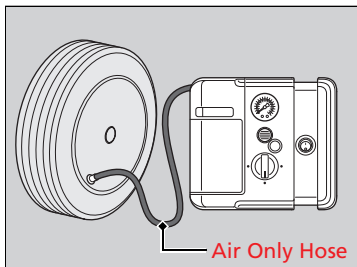

4. Recheck the air pressure using the air only hose on the compressor.

5. Turn the selector switch to **AIR ONLY**.

▶ Do not turn the air compressor on to check the pressure.

▶ [Inflating an Under-inflated Tire P. 454](#)

6. If the air pressure is

- Less than 19 psi (130 kPa):
Do not add air or continue driving. The leak is too severe. Call for help and have your vehicle towed.

▶ [Emergency Towing P. 475](#)

- 35 psi (240 kPa) or more:
Continue driving for another 10 minutes or until you reach the nearest service station. Do not exceed 50 mph (80 km/h).

▶ If the air pressure does not go down after the 10 minute driving, you do not need to check the pressure any more.

QRG

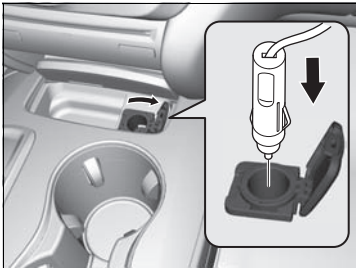

- Greater than 19 psi (130 kPa), but less than 35 psi (240 kPa):

Turn the air compressor on to inflate the tire until the tire pressure reaches 35 psi (240 kPa).

Turn the air compressor on to inflate the tire until the tire pressure reaches front: 35 psi (240 kPa)/rear: 33 psi (230 kPa).

► [Inflating an Under-inflated Tire P. 454](#)

Then drive carefully for 10 more minutes or until you reach the nearest service station. Do not exceed 50 mph (80 km/h).

► You should repeat this procedure as long as the air pressure is within this range.

7. Press the pressure relief button until the gauge returns to 0 psi (0 kPa).
8. Repackage and properly stow the kit.

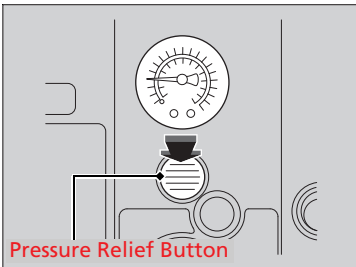

► Distributing the Sealant in the Tire

⚠ WARNING

Running the engine with the vehicle in an enclosed or even partly enclosed area can cause a rapid build-up of toxic carbon monoxide.

Breathing this colorless, odorless gas can cause unconsciousness and even death. Only run the engine to power the air compressor with the vehicle outdoors.

Handling the Unexpected

TOC

Index

Home

■ Inflating an Under-inflated Tire

You can use the kit to inflate a non-punctured under-inflated tire.

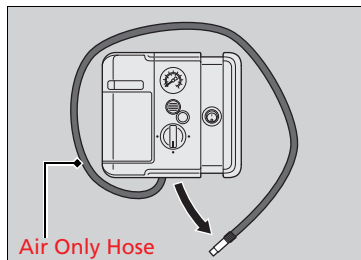

1. Open the cargo area floor lid.
 ▶ [Getting Ready to Temporarily Repair the Flat Tire P. 446](#)

2. Remove the kit from the case.
3. Place the kit, face up, on flat ground near the flat tire, away from traffic. Do not place the kit on its side.
4. Remove the air only hose from the kit.
5. Remove the valve cap.

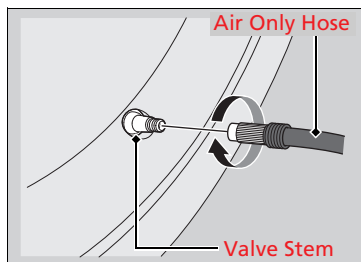
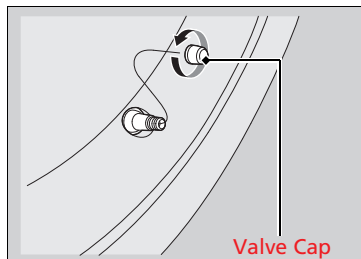

6. Attach the air only hose onto the tire valve stem. Screw it until it is tight.

▶▶ Inflating an Under-inflated Tire

NOTICE

Do not operate the temporary tire repair kit compressor for more than 15 minutes. The compressor can overheat and become permanently damaged.

QRG

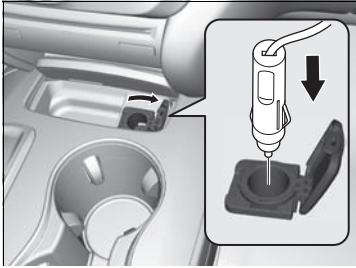

7. Plug in the kit to the accessory power socket.
 - ▶ Be careful not to pinch the cord in a door or window.
 - ▶ Do not plug any other electronic devices into other accessory power sockets.

➤ [Accessory Power Sockets P. 178](#)

8. Start the engine.
 - ▶ Keep the engine running while injecting air.

➤ [Carbon Monoxide Gas P. 66](#)

9. Turn the selector switch to **AIR ONLY**.
10. Press the inflator switch to turn on the kit.
 - ▶ The compressor starts to inject air into the tire.
11. Inflate the tire to the specified air pressure.

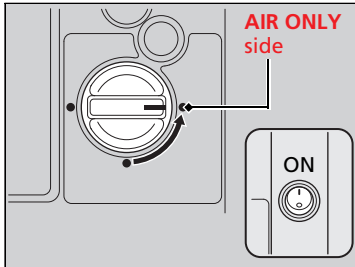

▶▶ Inflating an Under-inflated Tire

⚠ WARNING

Running the engine with the vehicle in an enclosed or even partly enclosed area can cause a rapid build-up of toxic carbon monoxide.

Breathing this colorless, odorless gas can cause unconsciousness and even death. Only run the engine to power the air compressor with the vehicle outdoors.

Handling the Unexpected

TOC

Index

Home

Continued

QRG

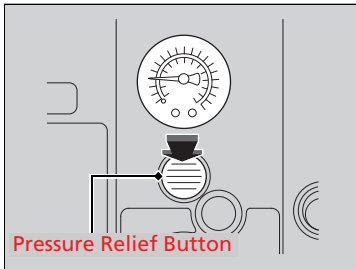

- 12.** Turn off the kit.
 - ▶ Check the pressure gauge on the air compressor.
 - ▶ If overinflated, press the pressure relief button.
- 13.** Unplug the kit from the accessory power socket.
- 14.** Unscrew the air only hose from the tire valve stem. Reinstall the valve cap.
- 15.** Press the pressure relief button until the gauge returns to 0 psi (0 kPa).
- 16.** Repackage and properly stow the kit.

Handling the Unexpected

TOC

Index

Home

Checking the Engine

If the engine does not start, check the starter.

Checking the Engine

If you must start the vehicle immediately, use an assisting vehicle to jump start it.

[Jump Starting P. 460](#)

Starter condition

Checklist

Starter doesn't turn or turns over slowly.

The battery may be dead. Check each of the items on the right and respond accordingly.

Check for a message on the MID.

- If the **To Start, Hold Remote Near Start Button** message appears
 - ▶ [If the Keyless Access Remote Battery is Weak P. 458](#)
- ▶ Make sure the keyless access remote is in its operating range.
 - ▶ [ENGINE START/STOP Button Operating Range P. 141](#)

Check the brightness of the interior lights.

Turn on the interior lights and check the brightness.

- If the interior lights are dim or do not come on at all
 - ▶ [Battery P. 426](#)
- If the interior lights come on normally ▶ [Fuses P. 469](#)

The starter turns over normally but the engine doesn't start.

There may be a problem with the fuse. Check each of the items on the right and respond accordingly.

Review the engine start procedure.

Follow its instructions, and try to start the engine again. ▶ [Starting the Engine P. 322](#)

Check the immobilizer system indicator.

When the immobilizer system indicator is blinking, the engine cannot be started.

▶ [Immobilizer System P. 135](#)

Check the fuel level.

There should be enough fuel in the tank. ▶ [Fuel Gauge P. 97](#)

Check the fuse.

Check all fuses, or have the vehicle checked by a dealer.

▶ [Inspecting and Changing Fuses P. 474](#)

If the problem continues:

▶ [Emergency Towing P. 475](#)

If the Keyless Access Remote Battery is Weak

If the beeper sounds, the **To Start, Hold Remote Near Start Button** message appears on the MID, the indicator on the **ENGINE START/STOP** button flashes, and the engine won't start, start the engine as follows.

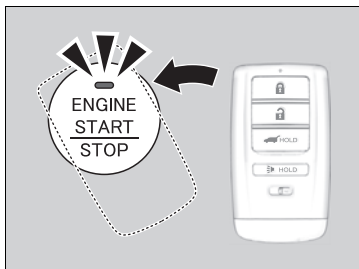

1. Touch the center of the **ENGINE START/STOP** button with the **A** logo on the keyless access remote while the indicator on the **ENGINE START/STOP** button is flashing. The buttons on the keyless access remote should be facing you.
 - The indicator flashes for about 30 seconds.

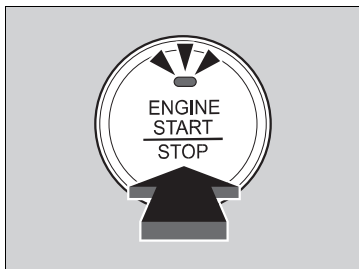

2. Depress the brake pedal and press the **ENGINE START/STOP** button within 10 seconds after the beeper sounds and the indicator changes from flashing to on.
 - If you don't depress the pedal, the mode will change to ACCESSORY.

Emergency Engine Stop

The **ENGINE START/STOP** button may be used to stop the engine due to an emergency situation even while driving. If you must stop the engine, do either of the following operations:

- Press and hold the **ENGINE START/STOP** button for about two seconds.
- Firmly press the **ENGINE START/STOP** button two times.
- The steering wheel will not lock. The power mode changes to VEHICLE OFF with the shift lever in **P**, and to ACCESSORY with the shift lever in any position other than **P**.
- Because turning off the engine also disables the power assist the engine provides to the steering and braking systems, it will require significantly more physical effort and time to steer and slow the vehicle. Downshift gears and use both feet on the brake pedal, if necessary, to slow the vehicle and stop immediately in a safe place.

Emergency Engine Stop

NOTICE

Do not press the button while driving unless it is absolutely necessary for the engine to be switched off.

Jump Starting Procedure

Turn the power to electric devices, such as audio and lights. Turn off the engine, then open the hood.

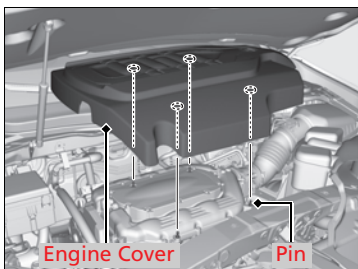

1. Pull up on the engine cover, remove it from the pins.

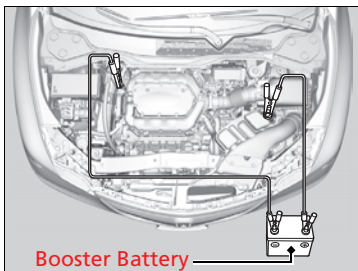

2. Connect the first jumper cable to your vehicle's battery \oplus terminal.
3. Connect the other end of the first jumper cable to the booster battery \oplus terminal.
▶ Use a 12-volt booster battery only.
4. Connect the second jumper cable to the booster battery \ominus terminal.

Jump Starting

WARNING

A battery can explode if you do not follow the correct procedure, seriously injuring anyone nearby.

Keep all sparks, open flames, and smoking materials away from the battery.

Securely attach the jumper cables clips so that they do not come off when the engine vibrates. Also be careful not to tangle the jumper cables or allow the cable ends to touch each other while attaching or detaching the jumper cables.

Battery performance degrades in cold conditions and may prevent the engine from starting.

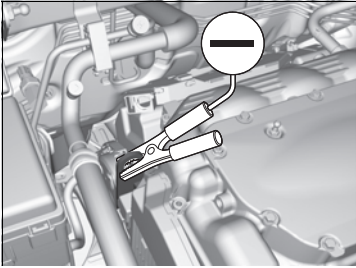

5. Connect the other end of the second jumper cable to the engine hanger as shown.
Do not connect this jumper cable to any other part.
6. If your vehicle is connected to another vehicle, start the assisting vehicle's engine and increase its rpm slightly.
7. Attempt to start your vehicle's engine. If it turns over slowly, check that the jumper cables have good metal-to-metal contact.

■ What to Do After the Engine Starts

Once your vehicle's engine has started, remove the jumper cables in the following order.

1. Disconnect the jumper cable from your vehicle's ground.
2. Disconnect the other end of the jumper cable from the booster battery \ominus terminal.
3. Disconnect the jumper cable from your vehicle's battery \oplus terminal.
4. Disconnect the other end of the jumper cable from the booster battery \oplus terminal.

Have your vehicle inspected by a nearby service station or a dealer.

Follow the procedure below if you cannot move the shift lever out of the **P** position.

Releasing the Lock

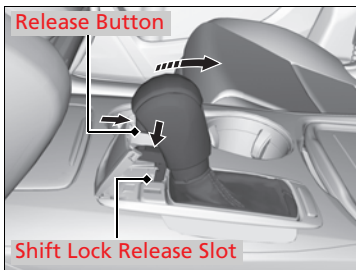
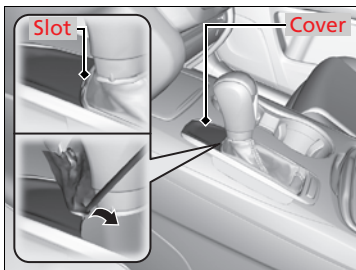

1. Set the parking brake.
2. Remove the built-in key from the keyless access remote.
3. Wrap a cloth around the tip of a small flat-tip screwdriver. Place it at the back of the release lock cover, and remove the cover.
4. Insert the key into the shift lock release slot.
5. While pushing the key down, press the shift lever release button and place the shift lever into **N**.
 - ▶ The lock is now released. Have the shift lever checked by a dealer as soon as possible.

How to Handle Overheating

Overheating symptoms are as follows:

- The temperature gauge needle is at the **H** mark or the engine suddenly loses power.
- Steam or spray comes out of the engine compartment.

■ First thing to do

1. Immediately park the vehicle in a safe place.
2. Turn off all accessories and turn on the hazard warning lights.
 - ▶ **No steam or spray present:** Keep the engine running and open the hood.
 - ▶ **Steam or spray is present:** Turn off the engine and wait until it subsides. Then, open the hood.

☒ How to Handle Overheating

⚠ WARNING

Steam and spray from an overheated engine can seriously scald you.

Do not open the hood if steam is coming out.

NOTICE

Continuing to drive with the temperature gauge needle at the **H** mark may damage the engine.

■ Next thing to do

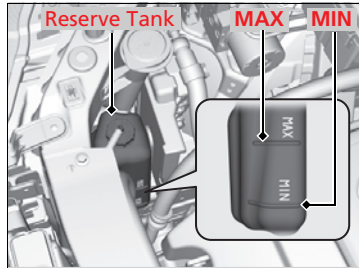

1. Check that the cooling fan is operating and stop the engine once the temperature gauge needle goes down.
 - If the cooling fan is not operating, immediately stop the engine.
2. Once the engine has cooled down, inspect the coolant level and check the cooling system components for leaks.
 - If the coolant level in the reserve tank is low, add coolant until it reaches the **MAX** mark.
 - If there is no coolant in the reserve tank, check that the radiator is cool. Cover the radiator cap with a heavy cloth and open the cap. If necessary, add coolant up to the base of the filler neck, and put the cap back on.

■ Last thing to do

Once the engine has cooled sufficiently, restart it and check the temperature gauge. If the temperature gauge needle has gone down, resume driving. If it has not gone down, contact a dealer for repairs.

► How to Handle Overheating

⚠ WARNING

Removing the radiator cap while the engine is hot can cause the coolant to spray out, seriously scalding you.

Always let the engine and radiator cool down before removing the radiator cap.

If the coolant is leaking, contact a dealer for repairs.

Use water as an emergency/temporary measure only. Have a dealer flush the system with proper antifreeze as soon as possible.

If the Low Oil Pressure Indicator Comes On



Reasons for the indicator to come on

Comes on when the engine oil pressure is low.

What to do as soon as the indicator comes on

1. Immediately park the vehicle on level ground in a safe place.
2. If necessary, turn the hazard warning lights on.

What to do after parking the vehicle

1. Stop the engine and let it sit for about three minutes.
 - ▶ [Oil Check P. 399](#)
2. Open the hood and check the oil level.
3. Start the engine and check the low oil pressure indicator.
 - ▶ The indicator goes off: Start driving again.
 - ▶ The indicator does not go off within 10 seconds: Stop the engine and contact a dealer for repairs immediately.

If the Charging System Indicator Comes On



Reasons for the indicator to come on

Comes on when the battery is not being charged.

What to do when the indicator comes on

Turn off the climate control system, rear defogger, and other electrical systems, and immediately contact a dealer for repairs.

If the Low Oil Pressure Indicator Comes On

NOTICE

Running the engine with low oil pressure can cause serious mechanical damage almost immediately.

If the Charging System Indicator Comes On

If you need to stop temporarily, do not turn off the engine. Restarting the engine may rapidly discharge the battery.

If the Malfunction Indicator Lamp Comes On or Blinks



■ Reasons for the indicator lamp to come on or blink

- Comes on when there is a problem with the engine emissions control system, or the fuel fill cap is missing, or loose.
- Blinks when engine misfiring is detected.

■ What to do when the indicator lamp comes on

Avoid high speeds and immediately get your vehicle inspected at a dealer.

■ What to do when the indicator lamp blinks

Park the vehicle in a safe place with no flammable items and wait at least 10 minutes or more with the engine stopped until it cools.

■ Tighten Fuel Cap Message

■ The message appears on when:

An evaporative system leak is detected. This may be caused by the fuel fill cap being loose or not being installed.

■ What to do when the message appears:

1. Stop the engine.
2. Check if the fuel fill cap is fully installed.
 - ▶ If not, loosen the cap, and then retighten it until it clicks at least once.
3. Drive for several days of normal driving.
 - ▶ The message should go off.

■ When the malfunction indicator lamp comes on

Malfunction indicator lamp comes on if the system continues to detect a leak of the gasoline vapor. If this happens, follow the procedures described earlier to check the fuel fill cap.

▶▶ If the Malfunction Indicator Lamp Comes On or Blinks

NOTICE

If you drive with the malfunction indicator lamp on, the emissions control system and the engine could be damaged.

If the malfunction indicator lamp blinks again when restarting the engine, drive to the nearest dealer at 31 mph (50 km/h) or less. Have your vehicle inspected.

If the Brake System Indicator (Red) Comes On

U.S.



Reasons for the indicator to come on

- The brake fluid is low.
- There is a malfunction in the brake system.

Canada



What to do when the indicator comes on while driving

Press the brake pedal lightly to check pedal pressure.

- If normal, check the brake fluid level the next time you stop.
- If abnormal, take immediate action. If necessary, downshift the transmission to slow the vehicle using engine braking.

If the Brake System Indicator (Red) Comes On

Have your vehicle repaired immediately. It is dangerous to drive with low brake fluid. If there is no resistance from the brake pedal, stop immediately in a safe place. If necessary downshift the gears.

If the brake system indicator and **ABS** indicator come on simultaneously, the electronic brake distribution system is not working. This can result in vehicle instability under sudden braking. Have your vehicle inspected by a dealer immediately.

If the Speed-Sensitive Electric Power Steering (EPS) System Indicator Comes On



Reasons for the indicator to come on

- Comes on when there is a problem with the EPS system.
- If you depress the accelerator pedal repeatedly to increase the engine speed while the engine is idling, the indicator comes on, and sometimes the steering wheel becomes harder to operate.

What to do when the indicator comes on

Stop the vehicle in a safe place and restart the engine.

If the indicator comes on and stays on, immediately have your vehicle inspected by a dealer.

If the Low Tire Pressure/TPMS Indicator Comes On or Blinks



■ Reasons for the indicator to come on or blink

A tire pressure is significantly low. If there is a problem with the TPMS or the compact spare tire* is installed, the indicator blinks for about one minute, and then stays on.

■ What to do when the indicator comes on

Stop your vehicle in a safe place. Check the tire pressure and adjust the pressure to the specified level. The specified tire pressure is on a label on the driver side doorjamb.

■ What to do when the indicator blinks

Have the tire inspected by a dealer as soon as possible. If the compact spare tire* causes the indicator to blink, change the tire to a full-size tire. The indicator goes off after driving for a few miles (kilometers).

▶▶ If the Low Tire Pressure/TPMS Indicator Comes On or Blinks

NOTICE

Driving on an extremely underinflated tire can cause it to overheat. An overheated tire can fail. Always inflate your tires to the prescribed level.

Fuse Locations

If any electrical devices are not working, set the power mode to VEHICLE OFF (LOCK) and check to see if any applicable fuse is blown.

Engine Compartment Fuse Box

There are two fuse boxes in the engine compartment.

Fuse locations are shown on the fuse box cover. Locate the fuse in question by the

fuse number and box cover number.

Located near the brake fluid reservoir. Push the tabs to open the box.

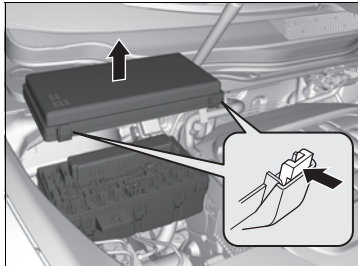

■ Circuit protected and fuse rating

	Circuit Protected	Amps
1	–	–
2	–	–
3	ACG FR	15 A
4	IG1 Washer	15 A
5	IG1 VBSOL	7.5 A
6	IG1 ECU FR	7.5 A
7	–	–
8	FI SUB	15 A
9	DBW	15 A
10	FI Main	15 A
11	IG Coil	15 A
12	DRL R	10 A
13	DRL L	10 A
14	INJ	20 A
15	Radio	20 A

	Circuit Protected	Amps
16	Back Up	10 A
17	MG Clutch	7.5 A
18	Front Fog*	(20 A)
19	–	–
20	Right Headlight High Beam	7.5 A
21	–	–
22	Small	10 A
23	–	–
24	Left Headlight High Beam	7.5 A
25	–	–
26	Right Headlight Low Beam	10 A
27	Left Headlight Low Beam	10 A
28	IGPS Oil LVL	7.5 A
29	Cooling Fan	30 A
30	Sub Fan	30 A
31	WIP Main	30 A

* Not available on all models

Located near the battery. Push the tabs to open the box.

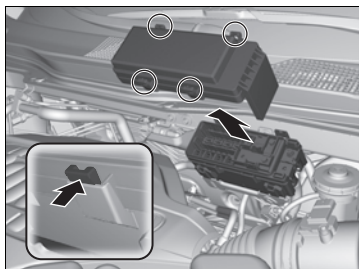

■ **Circuit protected and fuse rating**

	Circuit Protected	Amps
1	Main Fuse	150 A
	VSA MTR	40 A
	VSA FSR	20 A
2	Stop/Horn/Hazard	30 A
	Rear Blower/BMS	30 A
	FI Main	40 A
	Rear F/B 2	60 A
	AS F/B 2	60 A
	EPS	60 A
	H/L Washer	30 A
3	IG1B Main	30 A
	R/B Main	60 A
	DR F/B 1	50 A
	AS F/B 1	50 A
	Rear F/B 1	60 A
	IG1A Main	30 A
	DR F/B 2	50 A

	Circuit Protected	Amps
4	STM 4	30 A
5	Front Blower	40 A
6	Rear Def	40 A
7	IG Main 1	40 A
8	Stop & Horn	20 A
9	Hazard	15 A
10	BMS	7.5 A
11	–	–

Driver's Side Interior Fuse Box

Located under the dashboard.

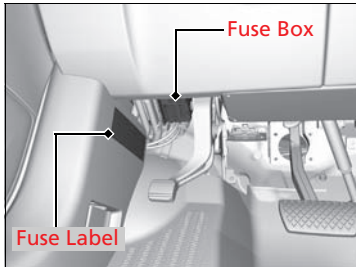

Fuse locations are shown on the label on the side panel.

Locate the fuse in question by the fuse number and label number.

Circuit protected and fuse rating

	Circuit Protected	Amps
1	Passenger's Side Door Lock	10 A
2	Rear Passenger's Side Door Lock	7.5 A
3	Driver's Side Door Lock	7.5 A
4	Passenger's Door Unlock	10 A
5	Rear Passenger's Side Door Unlock	7.5 A

	Circuit Protected	Amps
6	Driver's Side Door Unlock	7.5 A
7	Door Lock Main	20 A
8	HAC OP	10 A
9	ETS TELE	20 A
10	IG1 RR Box	15 A
11	IG1 Meter	7.5 A
12	IG1 FR Box	20 A
13	ACC	7.5 A
14	-	-
15	Driver's Power Seat Sliding	20 A
16	Moonroof	20 A
17	Rear Driver's Side Power Window	20 A
18	SMART	10 A
19	Driver's Power Window	20 A
20	-	-
21	Fuel Pump	20 A
22	AS Box	15 A
23	VSA	7.5 A
24	ACG AS	7.5 A
25	STRLD	7.5 A

	Circuit Protected	Amps
26	IG2 HAC	7.5 A
27	IG2 DRL	7.5 A
28	ACC Key Lock	7.5 A
29	Driver Power Lumber	7.5 A
30	Interior Lights Cut	7.5 A
31	ETS TILT	20 A
32	Driver's Power Seat Reclining	20 A
33	-	-
34	-	-

■ Passenger's Side Interior Fuse Box

Located on the lower side panel. Take off the cover to open.

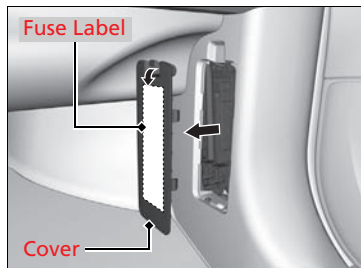

Fuse locations are shown on the cover.

■ Circuit protected and fuse rating

	Circuit Protected	Amps
1	Right e-pretensioner*	(30 A)
2	Rear Passenger's Side Power Window	20 A
3	ACM	20 A
4	Front DEF*	(15 A)
5	AVS/Seat Heaters	20 A
6	Front Passenger's Power Window	20 A
7	Passenger's Power Seat Sliding	20 A
8	Passenger's Power Seat Reclining	20 A
9	Passenger's Lumber*	(7.5 A)
10	–	–
11	HSW*	(10 A)
12	–	–
13	–	–
14	Rear Accessory Power Socket	20 A
15	Console Accessory Power Socket	20 A

	Circuit Protected	Amps
16	–	–
17	–	–
18	Premium AMP	30 A
19	SRS1	10 A
20	Passenger's ECU	7.5 A
21	SVTM4	7.5 A
22	–	–
23	–	–
24	IG1 OPDS	7.5 A
25	Illumination	7.5 A
26	Left e-pretensioner*	(30 A)
27	Front Accessory Power Socket	20 A
28	AC Inverter	(30 A)

■ Rear Fuse Box

Located on the left side of cargo area.
Remove the cover by prying on the edge of the cover using a flat-tip screwdriver.

► Wrap the flat-tip screwdriver with a cloth to prevent scratches.

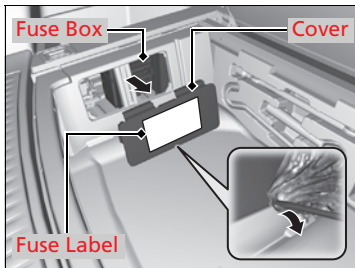

Fuse locations are shown on the cover.
Locate the fuse in question by the fuse number and box cover number.

■ Circuit protected and fuse rating

	Circuit Protected	Amps
1	Power Tailgate Closer	20 A
2	Trailer Small Light *	(20 A)
3	–	–
4	Fuel Lid	7.5 A
5	Seat Slide	20 A
6	–	–
7	Rear H/Seat *	(20 A)
8	–	–
9	Trailer Charge *	(20 A)
10	Trailer Back Light *	(7.5 A)
11	Trailer Hazard *	(7.5 A)
12	Rear Wiper	10 A
13	ECU RR	7.5 A
14	–	–
15	–	–
16	–	–
17	Trailer E-Brake *	(20 A)
18	Power Tailgate Motor	40 A

* Not available on all models

Inspecting and Changing Fuses

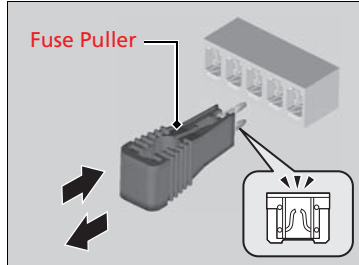
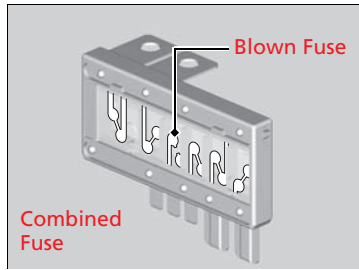

1. Set the power mode to VEHICLE OFF (LOCK). Turn headlights and all accessories off.
2. Remove the fuse box cover.
3. Check the large fuse in the engine compartment.
 - If the fuse is blown, use a Phillips-head screwdriver to remove the screw and replace it with a new one.
4. Inspect the small fuses in the engine compartment and the vehicle interior.
 - If there is a burned out fuse, remove it with the fuse puller and replace it with a new one.

Inspecting and Changing Fuses

NOTICE

Replacing a fuse with one that has a higher rating greatly increases the chances of damaging the electrical system.

Replace fuse with a spare fuse of the same specified amperage
Confirm the specified amperage using the charts on [P. 469](#) to [P. 473](#).

There is a fuse puller on the back of the engine compartment fuse box cover.

Call a professional towing service if you need to tow your vehicle.

All models

■ Flat bed equipment

The operator loads your vehicle on the back of a truck.

This is the best way to transport your vehicle.

2WD models

■ Wheel lift equipment

The tow truck uses two pivoting arms that go under the front tires and lift them off the ground. The rear tires remain on the ground. **This is an acceptable way to tow your vehicle.**

»Emergency Towing

NOTICE

Trying to lift or tow your vehicle by the bumpers will cause serious damage. The bumpers are not designed to support the vehicle's weight.

NOTICE

Improper towing such as towing behind a motorhome or other motor vehicle can damage the transmission.

Never tow your vehicle with just a rope or chain. It is very dangerous since ropes or chains may shift from side to side or break.

■ What to Do When Unable to Unlock the Fuel Fill Door

If you cannot unlock the fuel fill door, use the following procedure.

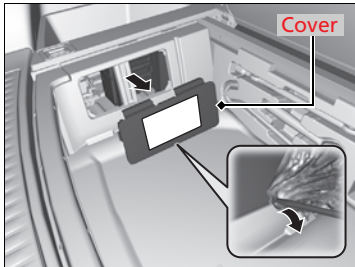

1. Open the tailgate.
2. Lift the cargo floor lid by the handle in the center.
3. Remove the cargo floor box and set it aside.
4. Wrap a cloth around the flat-tip screwdriver. Put it into the cover slot as shown in the image, and remove the cover.
5. Pull the release lever toward you.
 - ▶ The release lever unlocks the fuel fill door when it is pulled.

▣ What to Do When Unable to Unlock the Fuel Fill Door

After taking these steps, contact a dealer to have the vehicle checked.

What to Do When Unable to Open the Tailgate

If you cannot open the tailgate, use the following procedure.

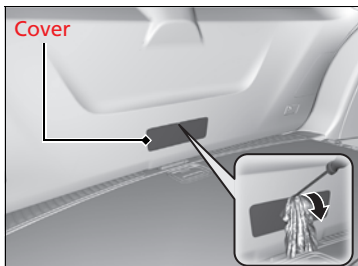

1. Wrap a cloth around the flat-tip screwdriver. Put it into the cover as shown in the image, and remove the cover.

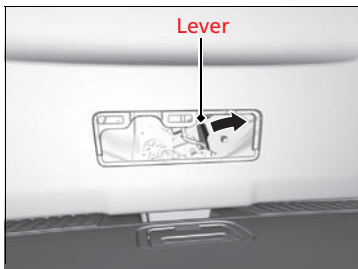

2. To open the tailgate, push the tailgate while sliding the lever to the right.

What to Do When Unable to Open the Tailgate

After taking these steps, contact a dealer to have the vehicle checked.

When you open the tailgate from inside, make sure there is enough space around the tailgate, and it does not hit anyone or any object.

Information

This chapter includes your vehicle’s specifications, locations of identification numbers, and other information required by regulation.



- Specifications** 480
- Identification Numbers**
 - Vehicle Identification Number (VIN).. 482
 - Engine Number and Transmission Number..... 482
- Devices that Emit Radio Waves** 483
- Reporting Safety Defects** 484
- Emissions Testing**
 - Testing of Readiness Codes..... 485
- Warranty Coverages** 487
- Authorized Manuals** 489
- Client Service Information** 490

■ Vehicle Specifications

Model	Acura MDX	
No. of Passengers:		
Front	2	
Rear	2nd Row	3
	3rd Row	2
Total		7
Weights:		
Gross Vehicle Weight Rating	U.S.:	5,368 lbs (2,435 kg) ^{*1} 5,677 lbs (2,575 kg) ^{*2}
	Canada:	2,575 kg
Gross Axle Weight Rating (Front)	U.S.:	2,811 lbs (1,275 kg) ^{*1} 2,910 lbs (1,320 kg) ^{*2}
	Canada:	1,320 kg
Gross Axle Weight Rating (Rear)	U.S.:	2,734 lbs (1,240 kg) ^{*1} 2,965 lbs (1,345 kg) ^{*2}
	Canada:	1,345 kg
Gross Combined Weight Rating	U.S.:	8,036 lbs (3,645 kg) ^{*1} 9,833 lbs (4,460 kg) ^{*2}
	Canada:	4,460 kg
Air Conditioning:		
Refrigerant Type	HFC-134a (R-134a)	
Charge Quantity	23.8 – 25.6 oz (675 – 725 g)	
Lubricant Type	RL897PAG	

*1: 2WD models

*2: AWD models

■ Engine Specifications

Displacement	211.8 cu-in (3,471 cm ³)	
Spark Plugs	NGK	D1LZKR7B11G

■ Fuel

Type	Unleaded premium gasoline, Pump octane number of 91 or higher	
Fuel Tank Capacity	19.5 US gal (74 ℓ)	

■ Washer Fluid

Tank Capacity	U.S.: 4 US qt (3.8 ℓ) Canada: 6.3 US qt (6.0 ℓ)	
---------------	--	--

■ Light Bulbs

Headlights (High/Low Beam)	LED
Front Turn Signal/Side Marker/ Parking Lights	28/8W (Amber)
Daytime Running Lights	LED
Side Turn Signal Lights (on Door Mirrors)	LED
Brake Lights	21W
Rear Side Marker Lights	LED
Taillights	LED
Back-Up Lights	21W
Rear Turn Signal Lights	21W
High-Mount Brake Light	LED
Rear License Plate Light	LED
LED Puddle Lights	LED
Interior Lights	
Front, Second Row and Third Row Lights	LED
Front and Rear Ambient Lights	LED
Vanity Mirror Lights	1.4W
Door Courtesy Lights	3.4W
Console Compartment Light	1.4W
Glove Box Light	1.4W
Foot Lights	5W
Cargo Area Lights	5W

■ Brake Fluid

Specified	Acura Heavy Duty Brake Fluid DOT 3
-----------	------------------------------------

Automatic Transmission Fluid

Specified	Acura ATF DW-1(automatic transmission fluid)	
Capacity	Change	3.3 US qt (3.1 ℓ)

Rear Differential Fluid*

Specified	Acura All Wheel Drive Fluid (DPSF)	
Capacity	Change	2.7 US qt (2.5 ℓ)

Transfer Assembly Fluid*

Specified	Acura HGO-Type1 to be applied.	
Capacity	Change	0.45 US qt (0.43 ℓ)

Engine Oil

Recommended	·Genuine Acura Motor Oil 0W-20 ·API Premium-grade 0W-20 detergent oil	
Capacity	Change	5.4 US qt (5.1 ℓ)
	Change including filter	5.7 US qt (5.4 ℓ)

Engine Coolant

Specified	Acura Long Life Antifreeze/Coolant Type 2	
Ratio	50/50 with distilled water	
	1.93 US gal (7.3 ℓ)	
Capacity	(change including the remaining 0.19 US gal (0.72 ℓ) in the reserve tank)	

Tire

Regular	Size	245/60R18 105H ^{*1} 245/55R19 103H ^{*2}
	Pressure psi (kPa [kgf/cm ²])	35 (240 [2.4])
Compact Spare [*]	Size	T165/80D17 104M
	Pressure psi (kPa [kgf/cm ²])	60 (420 [4.2])
Wheel Size	Regular	18 x 8J ^{*1} 19 x 8J ^{*2}
	Compact Spare [*]	17 x 4T

*1: BASE models

*2: Except BASE models

* Not available on all models

Vehicle Identification Number (VIN)

Your vehicle has a 17-digit vehicle identification number (VIN) used to register your vehicle for warranty purposes, and for licensing and insuring your vehicle. See the image below for the VIN locations.

Engine Number and Transmission Number

See the image below for the locations of your vehicle's engine number and transmission number.

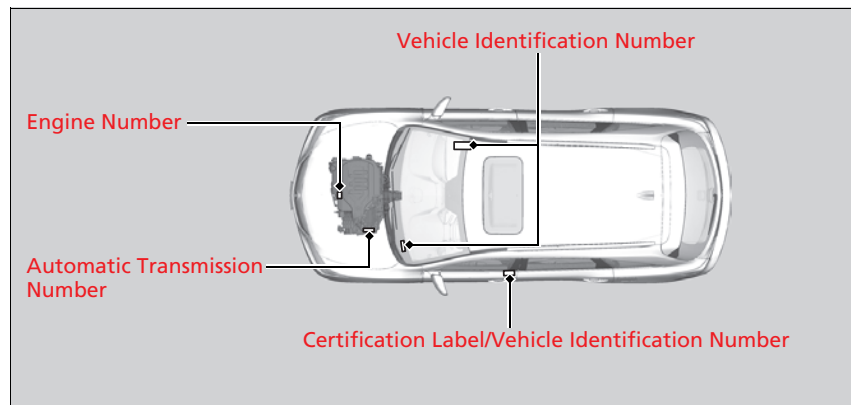

Vehicle Identification Number (VIN)

The interior vehicle identification number (VIN) is located under the cover.



QRG

The following products and systems on your vehicle emit radio waves when in operation.

AcuraLink

Audio System

Blind Spot Information System

Bluetooth® Audio

Bluetooth® HandsFreeLink®

HomeLink® Universal Transceiver

Collision Mitigation Braking System™

Immobilizer System

Remote Transmitter

Keyless Access System

Tire Pressure Monitoring System (TPMS)

Each of the above complies with the appropriate requirements or the required standards of FCC (Federal Communications Commission) and Industry Canada Standard, described below:

As required by the FCC:

This device complies with Part 15 of the FCC rules. Operation is subject to the following two conditions: (1) This device may not cause harmful interference, and (2) this device must accept any interference received, including interference that may cause undesired operation.

Changes or modifications not expressly approved by the party responsible for compliance could void the user's authority to operate the equipment.

This device complies with Industry Canada Standard RSS-Gen/210/310. Operation is subject to the following two conditions: (1) this device may not cause interference, and (2) this device must accept any interference, including interference that may cause undesired operation of the device.

Information

TOC

Index

Home

In the U.S.

If you believe that your vehicle has a defect which could cause a crash or could cause injury or death, you should immediately inform the National Highway Traffic Safety Administration (NHTSA) in addition to notifying American Honda Motor Co., Inc.

If NHTSA receives similar complaints, it may open an investigation, and if it finds that a safety defect exists in a group of vehicles, it may order a recall and remedy campaign. However, NHTSA cannot become involved in individual problems between you, your dealer, or American Honda Motor Co., Inc.

To contact NHTSA, you may call the Vehicle Safety Hotline toll-free at 1-888-327-4236 (TTY: 1-800-424-9153);

go to <http://www.safercar.gov>

or write to: Administrator, NHTSA,
1200 New Jersey Avenue, SE.,
Washington, DC 20590.

You can also obtain other information about motor vehicle safety from <http://www.safercar.gov>.

In Canada

If you believe that your vehicle has a defect which could cause a crash or could cause injury or death, you should immediately inform Honda Canada Inc. and you may also inform Transport Canada.

If Transport Canada receives similar complaints, it may open an investigation, and if it finds that a safety defect exists in a group of vehicles, it may lead to a recall and remedy campaign. However, Transport Canada cannot become involved in individual problems between you, your dealer, or Honda Canada Inc.

To contact Transport Canada's Defect Investigations and Recalls Division, you may call 1-800-333-0510. For more information on reporting safety defects or about motor vehicle safety, go to <http://www.tc.gc.ca/roadsafety>.

QRG

Testing of Readiness Codes

Your vehicle uses “readiness codes,” as part of its onboard self diagnostic system. Some states refer to these codes during testing to see if your vehicle’s emissions components are working properly. The codes may not be read if you go through the testing just after the battery has gone dead or been disconnected.

To check if they are set, set the power mode to ON, without starting the engine. The malfunction indicator lamp will come on for several seconds. If it then goes off, the readiness codes are set. If it blinks five times, the readiness codes are not set.

If you are required to have your vehicle tested before the readiness codes are ready, prepare the vehicle for retesting by doing the following:

1. Fill the gas tank to approximately 3/4 full.
2. Park the vehicle and leave the engine off for 6 hours or more.
3. Make sure the ambient temperature is between 40°F and 95°F (4°C and 35°C).
4. Start the engine without touching the accelerator pedal, and let it idle for 20 seconds.
5. Keep the vehicle in **P**. Increase the engine speed to 2,000 rpm, and hold it there for about 3 minutes.
6. Let the engine idle with your foot off the accelerator for 20 seconds.

Testing of Readiness Codes

The readiness codes are erased when the battery is disconnected, and set again only after several days of driving under a variety of conditions.

If a testing facility determines that the readiness codes are not set, you may be requested to return at a later date to complete the test.

If the testing facility determines the readiness codes are still not set, see a dealer.

Information

TOC

Index

Home

Continued

7. Select a nearby, lightly traveled major highway where you can maintain a speed of 50 to 60 mph (80 to 97 km/h) for at least 20 minutes. Drive on the highway in **D**. Do not use cruise control. When traffic allows, drive for 90 seconds without moving the accelerator pedal. (Vehicle speed may vary slightly; this is okay.) If you cannot do this for a continuous 90 seconds because of traffic conditions, drive for at least 30 seconds, then repeat it two more times (for a total of 90 seconds).
8. Drive in city/suburban traffic for at least 10 minutes. When traffic conditions allow, let the vehicle coast for several seconds without using the accelerator pedal or the brake pedal.
9. Park the vehicle and leave the engine off for 30 minutes.

■ U.S. Owners

Your new vehicle is covered by these warranties:

New Vehicle Limited Warranty – covers your new vehicle, except for the emissions control systems and accessories, against defects in materials and workmanship.

Emissions Control Systems Defects Warranty and Emissions Performance Warranty – these two warranties cover your vehicle's emissions control systems. Time, mileage, and coverage are conditional. Please read your warranty booklet for exact information.

Seat Belt Limited Warranty – a seat belt that fails to function properly is covered by a limited warranty. Please read your warranty booklet for details.

Rust Perforation Limited Warranty – all exterior body panels are covered for rust-through from the inside for the specified time period with no mileage limit.

Accessory Limited Warranty – Acura accessories are covered under this warranty. Time and mileage limits depend on the type of accessory and other factors. Please read your warranty booklet for details.

Replacement Parts Limited Warranty – covers all Acura replacement parts against defects in materials and workmanship.

Replacement Battery Limited Warranty – provides prorated coverage for a replacement battery purchased from a dealer.

Replacement Muffler Lifetime Limited Warranty – provides coverage for as long as the purchaser of the muffler owns the vehicle.

Restrictions and exclusions apply to all these warranties. Please read the Acura warranty information booklet that came with your vehicle for precise information on warranty coverages. Your vehicle's original tires are covered by their manufacturer. Tire warranty information is in a separate booklet.

■ **Canadian Owners**

Please refer to the warranty manual that came with your vehicle.

■ Service Express

For electronic copies of service publications, you can purchase a subscription to Service Express. Visit www.techinfo.honda.com for pricing and options.

■ For U.S. Owners:

Manuals be purchased from Helm Incorporated. You can order a manual by phone at (800) 782-4356 (credit card orders only), or online at www.helminc.com.

» Authorized Manuals

For Canadian Owners:

Please contact a dealer to order any manuals that you may require.

Acura dealer personnel are trained professionals.

They should be able to answer all your questions. If you encounter a problem that your dealership does not solve to your satisfaction, please discuss it with the dealership's service manager or general manager. If you are dissatisfied with the decision made by the dealership's management, contact Acura Client Relations/Services.

U.S. Owners:

American Honda Motor Co., Inc.
Acura Client Relations
Mail Stop 500-2N-7E
1919 Torrance Blvd.
Torrance, CA 90501-2746
Tel: (800) 382-2238

Canadian Owners:

Honda Canada Inc.
Acura Client Services
180 Honda Boulevard
Markham, ON
L6C 0H9
Tel: 1-888-9-ACURA-9
Fax: 1-877-939-0909
E-Mail: acura_cr@ch.honda.com

In Puerto Rico and the U.S. Virgin Islands:

Bella International
P.O. Box 190816
San Juan, PR 00919-0816
Tel: (787) 620-7546

Client Service Information

When you call or write, please give us the following information:

- Vehicle Identification Number
 - **Vehicle Identification Number (VIN)**
P. 482
- Date of purchase
- Odometer reading of your vehicle
- Your name, address, and telephone number
- A detailed description of the problem
- Name of the dealer who sold the vehicle to you

A

AAC..... 224, 234

ABS (Anti-lock Brake System)..... 369

AC Power Outlet..... 179

Accessories and Modifications..... 386

Accessory Power Sockets..... 178

Adaptive Cruise Control (ACC) with Low Speed Follow (LSF)..... 337

 Indicator..... 82

Additives

 Coolant..... 403

 Engine Oil..... 398

 Washer..... 406

Additives, Engine Oil..... 398

Adjusting

 Armrest..... 171

 Front Seats..... 161

 Head Restraints..... 164, 165, 166

 Headlights..... 407

 Mirrors..... 158

 Rear Seats..... 168

 Second Row Seat..... 162

 Steering Wheel..... 157

 Temperature..... 100

Agile Handling Assist System..... 360

Aha™ Menu..... 233

Aha™ Radio..... 243

Air Conditioning System (Climate Control System)..... 185

 Changing the Mode..... 188

 Defrosting the Windshield and Windows..... 191

 Dust and Pollen Filter..... 431

 Rear Climate Control System..... 192

 Recirculation/Fresh Air Mode..... 190

 Sensors..... 196

 Synchronized Mode..... 189

 Using Automatic Climate Control..... 185

Air Pressure..... 418, 481

Airbags..... 39

 Advanced Airbags..... 45

 After a Collision..... 43

 Airbag Care..... 53

 Driver's Knee Airbag..... 46

 Event Data Recorder..... 22

 Front Airbags (SRS)..... 42

 Indicator..... 51, 74

 Passenger Airbag Off Indicator..... 52

 Sensors..... 39

 Side Airbags..... 48

 Side Curtain Airbags..... 50

AM/FM Radio..... 217

Anti-lock Brake System (ABS)..... 369

 Indicator..... 74

Armrest..... 171

Audio Remote Controls..... 202

Audio System..... 198

 Adjusting the Sound..... 215

 Auxiliary Input Jack..... 200

 Error Messages..... 239

 General Information..... 244

 Internet Radio..... 231

 iPod®..... 227

 MP3/WMA/AAC..... 224, 234

 Reactivating..... 201

 Recommended CDs..... 245

 Recommended Devices..... 247

 Remote Controls..... 202

 Security Code..... 201

 Shortcuts..... 205

 Theft Protection..... 201

 USB Flash Drives..... 234, 247

 USB Port..... 199

Authorized Manuals..... 489

Auto Door Locking/Unlocking..... 127

 Customize..... 109, 259

Automatic Intermittent Wipers..... 150

Automatic Lighting..... 146

Automatic Transmission..... 328

 Creeping..... 328

 Fluid..... 405

 Kickdown..... 328

 Operating the Shift Lever..... 15, 330

 Sequential Shift Mode..... 331

 Shift Lever Does Not Move..... 462

 Shifting..... 329

Auxiliary Input Jack..... 200

Average Fuel Economy..... 100

Average Speed..... 101

AWD..... 363



B

Back-Up Light..... 411

Battery..... 426

 Charging System Indicator..... 71, 465

 Jump Starting..... 460

 Maintenance (Checking the Battery)..... 426

Belts (Seat)..... 31

Beverage Holders..... 177

Blind Spot Information (BSI) System..... 361

 Indicator..... 83

Bluetooth® Audio..... 237

Bluetooth® HandsFreeLink®..... 268

Booster Seats (For Children)..... 65

Brake System..... 367

 Anti-lock Brake System (ABS)..... 369

 Brake Assist System..... 370

 Brake System Indicator..... 70

 Fluid..... 406

 Foot Brake..... 368

 Indicator..... 70, 467

 Parking Brake..... 367

Brightness Control (Instrument Panel).... 153

BSI (Blind Spot Information) System..... 361

Bulb Replacement..... 407

 Back-Up Light..... 411

 Brake Light and Turn Signal Light..... 409

 Daytime Running Light..... 148

 Front Turn Signal/Front Side Marker/
 Parking Light..... 408

 Headlights..... 407

 High-Mount Brake Light..... 412

LED Puddle Light..... 412

Rear License Plate Light..... 412

Side Turn Signal/Emergency Indicator
Light..... 408

Taillight and Rear Side Marker Light..... 410

Bulb Specifications..... 480

C

Carbon Monoxide Gas..... 66

Carrying Cargo..... 305, 307

CD Player..... 224

Center Pocket..... 176

Certification Label..... 482

Changing Bulbs..... 407

Charging System Indicator..... 71, 465

Child Safety..... 54

 Childproof Door Locks..... 126

Child Seat..... 54

 Booster Seats..... 65

 Child Seat for Infants..... 56

 Child Seat for Small Children..... 57

 Installing a Child Seat with a Lap/Shoulder
 Seat Belt..... 61

 Larger Children..... 64

 Rear-facing Child Seat..... 56

 Selecting a Child Seat..... 58

Childproof Door Locks..... 126

Cleaning the Exterior..... 434

Cleaning the Interior..... 432

Client Service Information..... 490

Climate Control System..... 185

 Changing the Mode..... 188

 Defrosting the Windshield and
 Windows..... 191

 Dust and Pollen Filter..... 431

 Rear Climate Control System..... 192

 Recirculation/Fresh Air Mode..... 190

 Sensors..... 196

 Synchronized Mode..... 189

 Using Automatic Climate Control..... 185

Clock..... 114

CMBS™ (Collision Mitigation Braking
System™)..... 371

Coat Hook..... 180

Collision Mitigation Braking System™
(CMBS™)..... 371

 Indicator..... 83

Compact Spare Tire..... 439, 481

Compass..... 301

Console Compartment..... 175

Controls..... 113

Coolant (Engine)..... 403

 Adding to the Radiator..... 404

 Adding to the Reserve Tank..... 403

 Overheating..... 463

Creeping (Automatic Transmission)..... 328

Cruise Control..... 334

 Indicator..... 78

Cup Holders..... 177

Customized Features..... 104, 248

QRG

D

- Daytime Running Lights 148
- Dead Battery 460
- Defrosting the Windshield and Windows 191
- Detachable Anchor 36
- Devices that Emit Radio Waves 483
- Dimming
 - Headlights 145
 - Rearview Mirror 158
- Dipstick (Engine Oil) 399
- Directional Signals (Turn Signal) 144
- Door Mirrors 159
- Doors 115
 - Auto Door Locking 127
 - Auto Door Unlocking 127
 - Door Open Message 30
 - Keys 115
 - Locking/Unlocking the Doors from the Inside 10, 124
 - Locking/Unlocking the Doors from the Outside 117
 - Lockout Prevention System 121
- DOT Tire Quality Grading 420
- Driver's Knee Airbag 46
- Driving 303
 - Automatic Transmission 328
 - Braking 367
 - Cruise Control 334
 - Off-Highway Driving Guidelines 320
 - Shifting Gear 329

- Starting the Engine 322
- Driving Position Memory System 155
- Dust and Pollen Filter 431

E

- Elapsed Time 101
- Electronic Stability Control (ESC) 358
- Emergency 475
- Emissions Testing (Readiness Codes) 485
- Engine 482
 - Coolant 403
 - Jump Starting 460
 - Oil 398
 - Remote Engine Start 324
 - Starting 322
- Engine Compartment Cover 397
- Engine Coolant 403
 - Adding to the Radiator 404
 - Adding to the Reserve Tank 403
 - Overheating 463
 - Temperature Gauge 97
- Engine Oil 398
 - Adding 400
 - Checking 399
 - Displaying Oil Life 391
 - Low Oil Pressure Indicator 71, 465
 - Recommended Engine Oil 398
- ENGINE START/STOP Button 141
- e-pretensioners 33

- EPS (Electric Power Steering) System 76, 467
- Exhaust Gas Hazard (Carbon Monoxide) .. 66
- Exterior Care (Cleaning) 434
- Exterior Mirrors 159

F

- FCW (Forward Collision Warning) 346
- Features 197
- Filters
 - Dust and Pollen 431
 - Oil 401
- Flat Tire 439, 446
- Floor Mats 433
- Fluids
 - Automatic Transmission 405
 - Brake 406
 - Engine Coolant 403
 - Windshield Washer 406
- Folding Down the Second Row Seat 169
- Folding Down the Third Row Seat 170
- Foot Brake 368
- Forward Collision Warning (FCW) 346
 - Indicator 80
- Front Airbags (SRS) 42
- Front Seats 161
 - Adjusting 161



QRG

Fuel 16, 383
 Economy 385
 Gauge 97
 Instant Fuel Economy 101
 Low Fuel Indicator 73
 Range 101
 Recommendation 383
 Refueling 383
Fuel Economy 385
Fuel Fill Cap 16, 384
 Message 466
Fuel Fill Door 16, 384
 Unable to Unlock 476
Fuses 469
 Inspecting and Changing 474
 Locations 469, 471, 472, 473

G

Gasoline (Fuel)
 Economy 385
 Gauge 97
 Information 383
 Low Fuel Indicator 73
 Refueling 383
Gauges 97
Gear Shift Lever Positions
 Automatic Transmission 329
Glass (care) 435
Glove Box 174

H

Handling the Unexpected 437
HandsFreeLink® (HFL) 268
 Auto Answer 282
 Automatic Import of Cellular Phonebook
 and Call History 284
 Automatic Transferring 282
 Displaying Messages 297
 Editing User Name 281
 HFL Buttons 268
 HFL Menus 270
 HFL Status Display 269
 Limitations for Manual Operation 269
 Making a Call 288
 Options During a Call 294
 Phone Setup 274
 Receiving a Call 293
 Receiving a Text Message/E-mail 295
 Ring Tone 283
 Selecting a Mail Account 296
 Speed Dial 285
 To Create a Security PIN 280
 To Set Up a Text Message/E-mail
 Options 279
 Use Contact Photo 283
Hazard Warning Button 2
HDMI Jack 5
Head Restraints 164, 165, 166
Headlight Washers 152
Headlights 145
 Aiming 407

Automatic Operation 146
 Dimming 145, 148
 Operating 145
Heated Door Mirrors 154
Heated Steering Wheel 181
Heated Windshield Button 154
Heater (Steering Wheel) 181
Heaters (Seat) 182, 183
HFL (HandsFreeLink®) 268
High Beam Indicator 76
Hill Start Assist System 326
HomeLink® Universal Transceiver 266

I

Identification Numbers 482
 Engine and Transmission 482
 Vehicle Identification 482
IDS (Integrated Dynamics System) 333
IDS Button 333
Illumination Control 153
 Button 153
Immobilizer System 135
 Indicator 77
Indicators 70
 Adaptive Cruise Control (ACC) with
 Low Speed Follow (LSF) 82, 337
 Anti-lock Brake System (ABS) 74
 Blind Spot Information (BSI) 83, 362
 Brake System 70
 Charging System 71, 465

QRG

Collision Mitigation Brake System™
 (CMBS™) 83

CRUISE CONTROL 78, 335

CRUISE MAIN 78, 334

Forward Collision Warning (FCW) 80

High Beam 76

Immobilizer System 77

Keyless Access System 79

Lane Departure Warning (LDW) 81

Lane Keeping Assist System (LKAS) ... 82, 354

Lights On 77

Low Fuel 73

Low Oil Pressure 71, 465

Low Tire Pressure/TPMS 76

Malfunction Indicator Lamp 71, 466

Parking Brake and Brake System 70, 467

Seat Belt Reminder 32, 73

Security System Alarm 78

Shift Lever Position 72

Speed-sensitive Electric Power
 Steering (EPS) System 76, 467

Super Handling-All Wheel Drive™
 (SH-AWD®) 79

Supplemental Restraint System 51, 74

System Message 78

Transmission 72

Turn Signal 76

Vehicle Stability Assist (VSA®)
 System 75, 358

VSA® OFF 75, 359

Information 479

Instrument Panel 69

Brightness Control 153

Integrated Dynamics System (IDS) 333

IDS Button 333

Interface Dial 203

Interior Lights 172

Interior Rearview Mirror 158

J

Jack (Wheel Nut Wrench) 443

Jump Starting 460

K

Key Number Tag 116

Keyless Access System 118

Keyless Lockout Prevention 121

Keys 115

Lockout Prevention 121

Number Tag 116

Rear Door Won't Open 126

Remote Transmitter 117

Two-way Keyless Access Remote 115

Types and Functions 115

Kickdown (Automatic Transmission) 328

L

Lane Departure Warning (LDW) 350

Indicator 81

Lane Keeping Assist System (LKAS) 353

Indicator 82

Language (HFL) 269

LATCH (Child Seats) 59, 62

LED Puddle Light 120

Lights 145, 407

Automatic 146

Bulb Replacement 407

Daytime Running Lights 148

High Beam Indicator 76

Interior 172

Light Switches 145

Lights On Indicator 77

Turn Signals 144

LKAS (Lane Keeping Assist System) 353

Load Limits 307

Locking/Unlocking 115

Auto Door Locking/Unlocking 127

Childproof Door Locks 126

From Inside 124

From Outside 117

Keys 115

Using a Key 121

Lockout Prevention System 121

Low Battery Charge 465

Low Fuel Indicator 73

Low Oil Pressure Indicator 71, 465

Lower Anchors 59, 62

Lubricant Specifications Chart 481

Luggage (Maximum Load Limit) 307

Lumbar Support 161



M

Maintenance 387

- Battery..... 426
- Brake Fluid..... 406
- Cleaning..... 432
- Climate Control System 431
- Coolant 403
- Maintenance Minder™ 391
- Oil 399
- Precautions..... 388
- Radiator..... 404
- Remote Control..... 429
- Remote Transmitter 427, 428
- Replacing Light Bulbs..... 407
- Safety..... 389
- Service Items..... 393
- Tires 417
- Transmission Fluid..... 405
- Under the Hood..... 395
- Wireless Headphone 430

Malfunction Indicator Lamp 71, 466

Map Lights 173

Maximum Load Limit..... 307

Meters, Gauges..... 97

MID (Multi-information Display) 98

Mirrors..... 158

- Adjusting..... 158
- Door..... 159
- Exterior..... 159
- Interior Rearview..... 158

Modifications (and Accessories)..... 386

Moonroof 140

MP3 224, 234

Multi-function Steering-wheel Controls... 98

Multi-Information Display (MID)..... 98

Multi-View Rear Camera..... 382

N

Numbers (Identification)..... 482

O

Odometer 99

Off-Highway Driving Guidelines 320

Oil (Engine)..... 398

- Adding..... 400
- Checking..... 399
- Displaying Oil Life..... 391
- Low Oil Pressure Indicator 71, 465
- Recommended Engine Oil 398
- Viscosity 398

On Demand Multi-Use Display™ 204

Opening/Closing

- Hood..... 396
- Moonroof 140
- Power Windows..... 138
- Tailgate..... 128

Outside Temperature Display..... 100

Overheating..... 463

P Q

Paddle Shifters (Sequential Shift Mode) 331

Pandora®..... 232

Panic Mode..... 137

Parking 377

Parking Brake 367

Parking Brake and Brake System Indicator 70, 467

Parking Sensor System 378

Passenger Airbag Off Indicator..... 52

Passing Indicators..... 145

Power Tailgate 130

Power Windows 138

Precautions While Driving 327

- Driving Guidelines for Your Utility Vehicle..... 327
- Rain 327

Pregnant Women..... 37

Puncture (Tire) 439, 446

R

Radiator..... 404

Radio (AM/FM) 217

Radio (XM®)..... 221

Radio Data System (RDS) 219

Range..... 101

RDS (Radio Data System) 219

Readiness Codes (Emissions Testing) 485



QRG

Rear Climate Control System.....	192	Safety Check	30	Select Lever.....	15, 329
From the Front Panel.....	192	Safety Labels.....	67	Operation.....	15, 330
From the Rear Panel.....	195	Safety Message	23	Releasing.....	462
Rear Defogger/Heated Door Mirror		Seat Belts.....	31	Won't Move.....	462
Button.....	154	Adjusting the Shoulder Anchor.....	35	Selecting a Child Seat.....	58
Rear Seats.....	168	Automatic Seat Belt Tensioners.....	33	Sequential Shift Mode	331
Second Row Seat	168, 169	Checking.....	38	Setting the Clock	114
Third Row Seat	170	Detachable Anchor.....	36	SH-AWD® (Super Handling-All Wheel	
Rearview Mirror	158	e-pretensioners.....	33	Drive™)	363
Refueling.....	383	Fastening.....	34	SH-AWD® Torque Distribution Monitor..	102
Fuel Gauge	97	Installing a Child Seat with a Lap/Shoulder		Shift Lever.....	15, 329
Gasoline	383, 480	Seat Belt	61	Shift Lever Position Indicator	72, 330
Low Fuel Indicator.....	73	Pregnant Women	37	Shifting (Transmission).....	329
Regulations	365, 420, 483	Reminder.....	32	Shoulder Anchor	35
Remote Engine Start with Vehicle		Warning Indicator.....	32, 73	Side Airbags.....	48
Feedback.....	324	Seat Heaters.....	182, 183	Side Curtain Airbags	50
Checking Door Lock Status	122	Seat Ventilation	182	Snow Tires.....	425
Remote Transmitter.....	117	Seats.....	161	Spare Tire	439, 481
Replacement		Adjusting.....	161	Spark Plugs	480
Battery.....	427, 428, 429, 430	Driver's Seat Lumbar Support	161	Specifications.....	480
Bulbs	407	Front Seats	161	Specified Fuel	383, 480
Front Wiper Blade Rubber.....	413	Rear Seats	168	Speedometer	97
Fuses	469, 471, 472, 473	Seat Heaters	182, 183	Speed-sensitive Electric Power Steering	
Rear Wiper Blade Rubber	415	Seat Ventilation	182	(EPS) System	
Tires.....	423	Second Row Seat.....	168, 169	Indicator.....	76, 467
Reporting Safety Defects.....	484	Third Row Seat	170	SRS Airbags (Airbags).....	42
Resetting a Trip Meter.....	100	Second Row Outer Seats Heaters	183	Starting the Engine.....	322
		Second Row Seat (Folding Down)	169	Does Not Start.....	457
		Security System	135	Jump Starting.....	460
		Immobilizer System Indicator	77	Remote Engine Start.....	324
		Security System Alarm Indicator.....	78		

S

Home

Safe Driving.....	25
-------------------	----

QRG

Steering Wheel 157
 Adjusting 157
 Heater 181
 Stopping 377
 Summer Tires 425
 Sunglasses Holder 181
 Super Handling-All Wheel Drive™
 (SH-AWD®) 363
 Indicator 79
 Supplemental Restraint System (SRS) 42
 Switches (Around the Steering
 Wheel) 2, 3, 141
 Synchronized Mode 189
 System Message Indicator 78

T

Tachometer 97
 Tailgate 128
 Unable to Open 477
 Temperature
 Gauge 97
 Outside Temperature Display 100
 Temperature Gauge 97
 Temperature Sensor 100, 196
 Temporary Tire Repair Kit 446
 Third Row Seat (Folding Down) 170
 Third Row Seat Access 168
 Tie-down Anchors 180
 Time (Setting) 114

Tire Pressure Monitoring System
 (TPMS) 363
 Indicator 76, 468
 Tire Repair Kit 446
 Tires 417
 Air Pressure 418, 481
 Checking and Maintaining 417
 Inspection 417
 Labeling 418
 Puncture (Flat Tire) 439, 446
 Regulations 420
 Rotation 424
 Spare Tire 439, 481
 Summer 425
 Temporary Tire Repair Kit 446
 Tire Chains 425
 Tire Repair Kit 446
 Wear Indicators 422
 Winter 425
 Tools 438
 Towing a Trailer 309
 Equipment and Accessories 313
 Load Limits 309
 Towing Your Vehicle 319
 Emergency 475
 TPMS (Tire Pressure Monitoring
 System) 363
 Indicator 76, 468
 Trailer Stability Assist 317
 Transmission 329
 Automatic 329

Fluid 405
 Number 482
 Sequential Shift Mode 331
 Shift Lever Position Indicator 72, 330
 TRIP Button 98
 Trip Meter 100
 Troubleshooting 437
 Blown Fuse 469, 471, 472, 473
 Brake Pedal Vibrates 19
 Buzzer Sounds When Opening Door 20
 Emergency Towing 475
 Engine Won't Start 457
 Noise When Braking 21
 Overheating 463
 Puncture/Flat Tire 439, 446
 Rear Door Won't Open 20, 126
 Select Lever Won't Move 462
 Warning Indicators 70
 Turn Signals 144
 Indicators (Instrument Panel) 76
 Turn-by-Turn Directions 102
 Two-way Keyless Access Remote 115

U

Under-floor Storage Area 176
 Unlocking the Doors 117
 Unlocking the Front Doors from the
 Inside 10, 124
 USB Flash Drives 247
 USB Port 199

QRG

V

Vanity Mirrors 5
 Vehicle Identification Number 482
 Vehicle Stability Assist (VSA®) 358
 Off Button 359
 Off Indicator 75
 System Indicator 75, 358
 Viscosity (Oil) 398, 481
 VSA® (Vehicle Stability Assist) 358

W

Warning and Information Messages 84
 Warning Indicator On/Blinking 465
 Warning Labels 67
 Warranties (Warranty Manual provided separately) 487
 Watts 480
 Wear Indicators (Tire) 422
 Wheel Nut Wrench (Jack Handle) 443
 Window Washers 149
 Adding/Refilling Fluid 406
 Switch 149
 Windows (Opening and Closing) 138
 Windshield 149
 Cleaning 435
 Defrosting/Defogging 191
 Washer Fluid 406
 Wiper Blades 413
 Wipers and Washers 149

Winter Tires 425
 Snow Tires 425
 Tire Chains 425
 Wipers and Washers 149
 Checking and Replacing Wiper Blades 413
 Front 149
 Rear 151
 WMA 224, 234
 Worn Tires 417

X Y Z

XM® Radio 221

