

Congratulations! Your selection of a 2008 Acura RDX was a wise investment. It will give you years of driving pleasure.

One of the best ways to enhance the enjoyment of your new vehicle is to read this manual. In it, you will learn how to operate its driving controls and convenience items. Afterwards, keep this owner's manual in your vehicle so you can refer to it at any time.

Several warranties protect your new vehicle. Read the warranty booklet thoroughly so you understand the coverages and are aware of your rights and responsibilities.

Maintaining your vehicle according to the maintenance minder shown in the instrument panel helps to keep your driving trouble-free while it preserves your investment. When your vehicle needs maintenance, keep in mind that your dealer's staff is specially trained in servicing the many systems unique to your vehicle. Your dealer is dedicated to your satisfaction and will be pleased to answer any questions and concerns.

As you read this manual, you will find information that is preceded by a **NOTICE** symbol. This information is intended to help you avoid damage to your vehicle, other property, or the environment.

# Introduction

---

## California Proposition 65 Warning

**WARNING:** This product contains or emits chemicals known to the State of California to cause cancer and birth defects or other reproductive harm.

## Event Data Recorders

**This vehicle is equipped with one or more devices commonly referred to as event data recorders. These devices record front seat belt use, front passenger seat occupancy, airbag deployment data, and the failure of any airbag system component.** This data belongs to the vehicle owner and may not be accessed by anyone else except as legally required or with the permission of the vehicle owner.

## Service Diagnostic Recorders

This vehicle is equipped with service-related devices that record information about powertrain performance. The data can be used to verify emissions law requirements and/or help technicians diagnose and solve service problems. It may also be combined with data from other sources for research purposes, but it remains confidential.

Your safety, and the safety of others, is very important. And operating this vehicle safely is an important responsibility.

To help you make informed decisions about safety, we have provided operating procedures and other information on labels and in this manual. This information alerts you to potential hazards that could hurt you or others.

Of course, it is not practical or possible to warn you about all the hazards associated with operating or maintaining your vehicle. You must use your own good judgement.

You will find this important safety information in a variety of forms, including:

- **Safety Labels** – on the vehicle.
- **Safety Messages** – preceded by a safety alert symbol  and one of three signal words: **DANGER**, **WARNING**, or **CAUTION**. These signal words mean:

 **DANGER**

You **WILL** be **KILLED** or **SERIOUSLY HURT** if you don't follow instructions.

 **WARNING**

You **CAN** be **KILLED** or **SERIOUSLY HURT** if you don't follow instructions.

 **CAUTION**

You **CAN** be **HURT** if you don't follow instructions.

- **Safety Headings** – such as Important Safety Reminders or Important Safety Precautions.
- **Safety Section** – such as Driver and Passenger Safety.
- **Instructions** – how to use this vehicle correctly and safely.

This entire book is filled with important safety information – please read it carefully.

## Important Handling Information

---

Your RDX has higher ground clearance than a passenger vehicle designed for use only on pavement. Higher ground clearance has many advantages for off-highway driving. It allows you to travel over bumps, obstacles, and rough terrain. It also provides good visibility so you can anticipate problems earlier.

These advantages come at some cost. Because your vehicle is taller and rides higher off the ground, it has a high center of gravity. This means your vehicle can tip or roll over if you make abrupt turns. Utility vehicles have a significantly higher rollover rate than other types of vehicles. In a rollover crash, an unbelted person is significantly more likely to die than a person wearing a seat belt. As a reminder, make sure you and your passengers always wear seat belts.

For information on how to reduce the risk of rollover, read “Driving Guidelines” on page 290 of this manual and the *Off-Highway Driving Guidelines* section on page 321. Failure to operate your vehicle correctly might result in loss of control or an accident.

### Owner's Identification Form

<b>Introduction</b> .....	<b>i</b>
<b>A Few Words About Safety</b> .....	<b>iii</b>
<b>Important Handling Information</b> .....	<b>iv</b>
<b>Your Vehicle at a Glance</b> (main controls) .....	<b>3</b>
<b>Driver and Passenger Safety</b> (seat belts, SRS, and child protection) .....	<b>5</b>
<b>Instruments and Controls</b> (indicators, gauges, multi-information display, dashboard, and steering column) ....	<b>59</b>
<b>Features</b> (climate control, audio, steering wheel, security, cruise control, HomeLink, and other convenience items) ..	<b>159</b>
<b>Before Driving</b> (fuel, vehicle break-in, and cargo loading) .....	<b>271</b>
<b>Driving</b> (engine and transmission operation) .....	<b>289</b>
<b>Maintenance</b> (minders, fluid checking, minor services, and vehicle storage).....	<b>325</b>
<b>Taking Care of the Unexpected</b> (flat tire, dead battery, overheating, and fuses) .....	<b>369</b>
<b>Technical Information</b> (vehicle specifications, tires, and emissions controls) .....	<b>393</b>
<b>Warranty and Customer Relations</b> (U. S. and Canada only) (warranty and contact information) ..	<b>409</b>
<b>Authorized Manuals</b> (U. S. only) (how to order) .....	<b>413</b>
<b>Index</b> .....	<b>I</b>

### Service Information Summary (fluid capacities and tire pressures)

# Overview of Contents

---

## **Contents**

A convenient reference to the sections in this manual.

## **Your Vehicle at a Glance**

A quick reference to the main controls in your vehicle.

## **Driver and Passenger Safety**

Important information about the proper use and care of your vehicle's seat belts, an overview of the supplemental restraint system, and valuable information on how to protect children with child restraints.

## **Instruments and Controls**

Explains the purpose of each instrument panel indicator and gauge, and how to use the controls on the dashboard and steering column.

## **Features**

How to operate the climate control system, the audio system, and other convenience features.

## **Before Driving**

What gasoline to use, how to break-in your new vehicle, and how to load luggage and other cargo.

## **Driving**

The proper way to start the engine, shift the transmission, and park; plus what you need to know if you're planning to tow a trailer.

## **Maintenance**

The maintenance minder shows you when you need to take your vehicle to the dealer for maintenance service. There is also a list of things to check and instructions on how to check them.

## **Taking Care of the Unexpected**

This section covers several problems motorists sometimes experience, and details how to handle them.

## **Technical Information**

ID numbers, dimensions, capacities, and technical information.

## **Warranty and Client Relations (U.S. and Canada only)**

A summary of the warranties covering your new vehicle, and how to contact us for any reason. Refer to your warranty manual for detailed information.

## **Authorized Manuals (U.S. only)**

How to order manuals and other technical literature.

## **Index**

## **Service Information Summary**

A summary of the information you need when you pull up to the fuel pump.

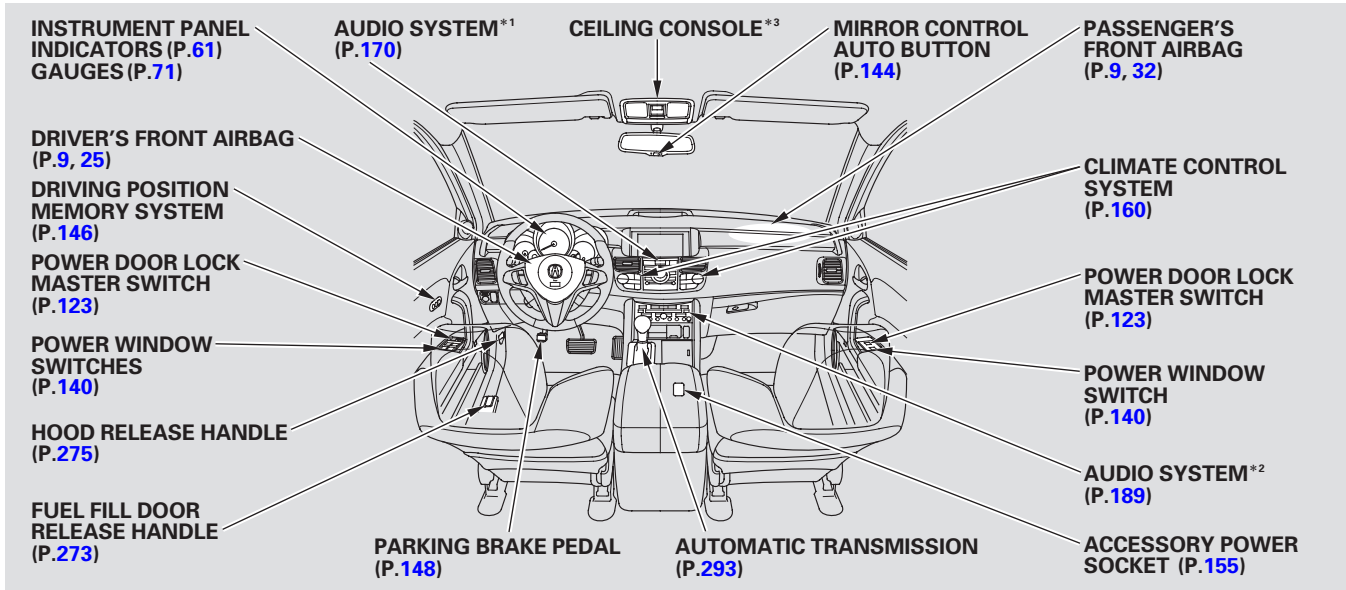

- \* 1: On RDX model only
- \* 2: On RDX with Technology Package model only
- \* 3: HomeLink Buttons (P.247)  
Moonroof Switch (P.142)  
Front Ceiling Light Switch (P.149)

# Your Vehicle at a Glance

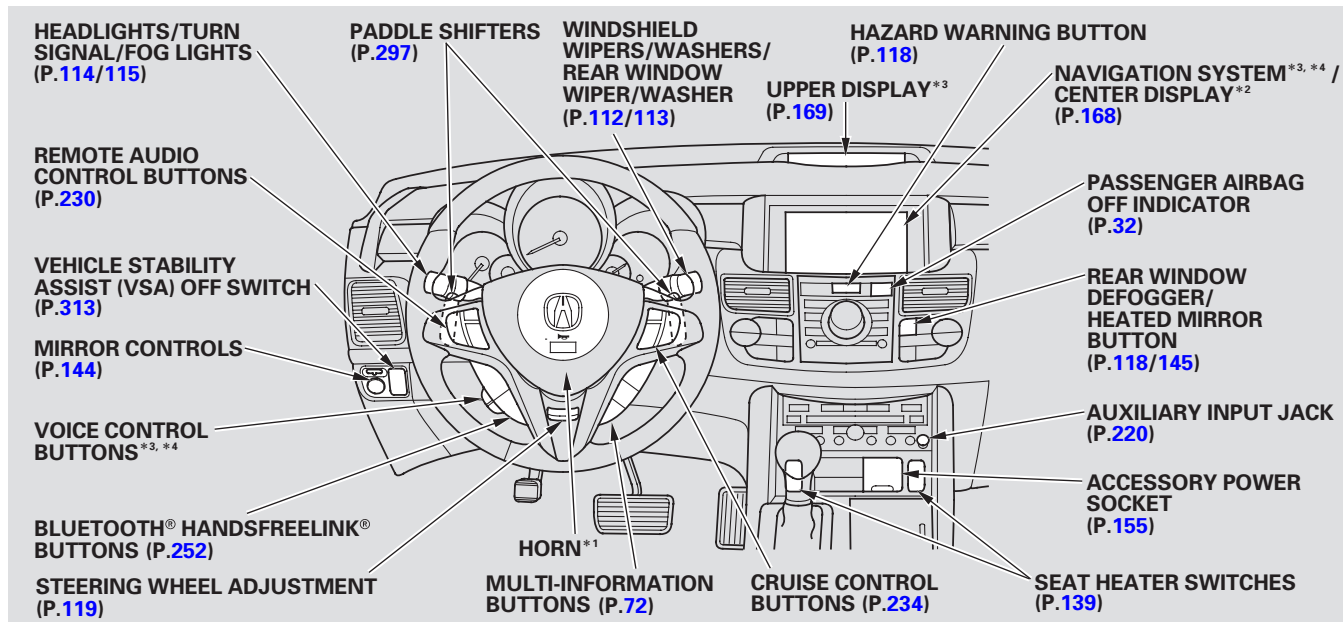

\* 1 : To use the horn, press the center pad of the steering wheel.

\* 2 : On RDX model only

\* 3 : On RDX with Technology Package model only

\* 4 : Refer to the navigation system manual.



This section gives you important information about how to protect yourself and your passengers. It shows you how to use seat belts properly. It explains how your airbags work, and it tells you how to properly restrain infants and children in your vehicle.

- Important Safety Precautions ..... 6
- Your Vehicle's Safety Features..... 7
  - Seat Belts..... 8
  - Airbags..... 9
- Protecting Adults and Teens..... 11
  - 1. Close and Lock the Doors ..... 11
  - 2. Adjust the Front Seats ..... 12
  - 3. Adjust the Seat-Backs ..... 13
  - 4. Adjust the Head Restraints .... 14
  - 5. Fasten and Position the Seat Belts..... 14
  - 6. Maintain a Proper Sitting Position ..... 16
- Advice for Pregnant Women..... 17
- Additional Safety Precautions.... 18

- Additional Information About Your Seat Belts ..... 19
- Seat Belt System Components... 19
- Lap/Shoulder Belt ..... 20
- Automatic Seat Belt Tensioners..... 21
- Seat Belt Maintenance..... 22
- Additional Information About Your Airbags ..... 23
- Airbag System Components..... 23
- How Your Front Airbags Work..... 25
- How Your Side Airbags Work.... 29
- How Your Side Curtain Airbags Work..... 30
- How the SRS Indicator Works... 31
- How the Side Airbag Off Indicator Works..... 31
- How the Passenger Airbag Off Indicator Works..... 32
- Airbag Service..... 33
- Additional Safety Precautions.... 34
- Protecting Children – General Guidelines..... 35
- All Children Must Be Restrained ..... 35

- All Children Should Sit in a Back Seat ..... 36
- The Passenger's Front Airbag Can Pose Serious Risks ..... 36
- If You Must Drive with Several Children ..... 38
- If a Child Requires Close Attention ..... 38
- Additional Safety Precautions.... 39
- Protecting Infants and Small Children ..... 40
- Protecting Infants..... 40
- Protecting Small Children ..... 41
- Selecting a Child Seat..... 43
- Installing a Child Seat ..... 44
  - With LATCH..... 45
  - With a Lap/Shoulder Belt ..... 49
  - With a Tether..... 50
- Protecting Larger Children ..... 52
- Checking Seat Belt Fit..... 52
- Using a Booster Seat..... 53
  - When Can a Larger Child Sit in Front..... 54
- Additional Safety Precautions.... 55
- Carbon Monoxide Hazard ..... 56
- Safety Labels ..... 57

## Important Safety Precautions

---

You'll find many safety recommendations throughout this section, and throughout this manual. The recommendations on this page are the ones we consider to be the most important.

### **Always Wear Your Seat Belt**

A seat belt is your best protection in all types of collisions. Airbags are designed to supplement seat belts, not replace them. So even though your vehicle is equipped with airbags, make sure you and your passengers always wear your seat belts, and wear them properly (see page 14).

### **Restrain All Children**

Children age 12 and under should ride properly restrained in a back seat, not the front seat. Infants and small children should be restrained in a child seat. Larger children should use a booster seat and a lap/shoulder belt until they can use the belt properly without a booster seat (see pages 35 – 55).

### **Be Aware of Airbag Hazards**

While airbags can save lives, they can cause serious or fatal injuries to occupants who sit too close to them, or are not properly restrained. Infants, young children, and short adults are at the greatest risk. Be sure to follow all instructions and warnings in this manual.

### **Don't Drink and Drive**

Alcohol and driving don't mix. Even one drink can reduce your ability to respond to changing conditions, and your reaction time gets worse with

every additional drink. So don't drink and drive, and don't let your friends drink and drive, either.

### **Control Your Speed**

Excessive speed is a major factor in crash injuries and deaths. Generally, the higher the speed, the greater the risk, but serious injuries can also occur at lower speeds. Never drive faster than is safe for current conditions, regardless of the maximum speed posted.

### **Keep Your Vehicle in Safe Condition**

Having a tire blowout or a mechanical failure can be extremely hazardous. To reduce the possibility of such problems, check your tire pressures and condition frequently, and perform all regularly scheduled maintenance (see page 360).

## Your Vehicle's Safety Features

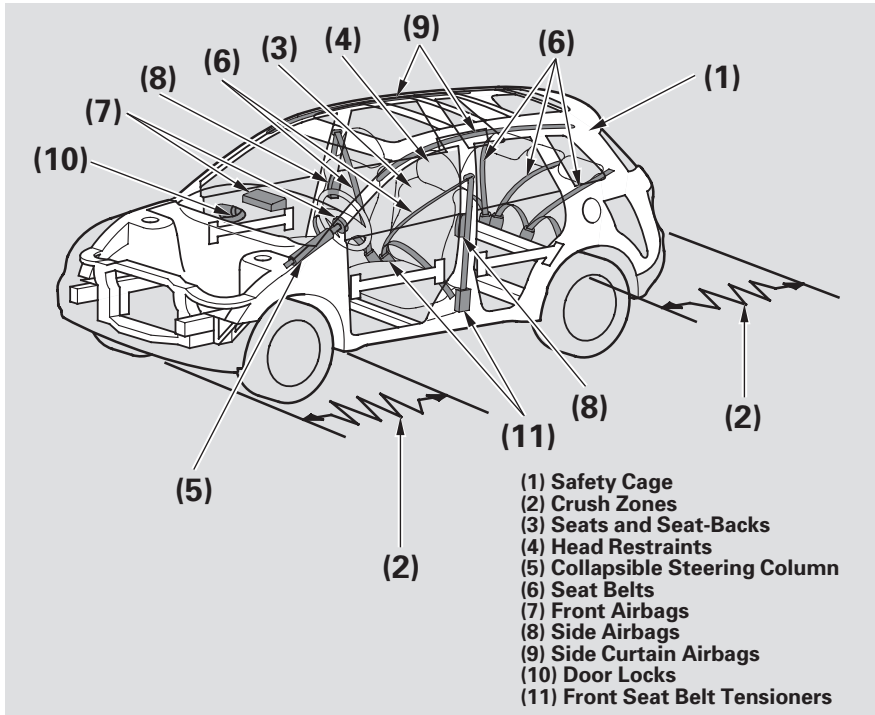

Your vehicle is equipped with many features that work together to protect you and your passengers during a crash.

Some features do not require any action on your part. These include a strong steel framework that forms a safety cage around the passenger compartment, front and rear crush zones, a collapsible steering column, and tensioners that tighten the front seat belts in a crash.

However, you and your passengers can't take full advantage of these features unless you remain sitting in a proper position and ***always wear your seat belts***. In fact, some safety features can contribute to injuries if they are not used properly.

The following pages explain how you can take an active role in protecting yourself and your passengers.

## Your Vehicle's Safety Features

---

### Seat Belts

Your vehicle is equipped with seat belts in all seating positions.

Your seat belt system also includes an indicator on the instrument panel and a beeper to remind you and your passengers to fasten your seat belts.

#### *Why Wear Seat Belts*

Seat belts are the single most effective safety device for adults and larger children. (Infants and smaller children must be properly restrained in child seats.)

Not wearing a seat belt properly increases the chance of serious injury or death in a crash, even though your vehicle has airbags.

In addition, most states and all Canadian provinces require you to wear seat belts.

### **WARNING**

Not wearing a seat belt properly increases the chance of serious injury or death in a crash, even though your vehicle has airbags.

Be sure you and your passengers always wear seat belts and wear them properly.

When properly worn, seat belts:

- Keep you connected to the vehicle so you can take advantage of the vehicle's built-in safety features.
- Help protect you in almost every type of crash, including frontal, side, and rear impacts and rollovers.

- Help keep you from being thrown against the inside of the vehicle and against other occupants.
- Keep you from being thrown out of the vehicle.
- Help keep you in a good position should the airbags ever deploy. A good position reduces the risk of injury from an inflating airbag and allows you to get the best advantage from the airbag.

Of course, seat belts cannot completely protect you in every crash. But in most cases, seat belts can reduce your risk of serious injury.

#### *What You Should Do:*

Always wear your seat belt, and make sure you wear it properly.

## Airbags

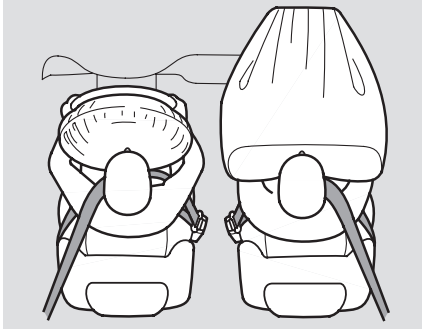

Your vehicle has a supplemental restraint system (SRS) with front airbags to help protect the heads and chests of the driver and a front seat passenger during a moderate to severe frontal collision (see page 25 for more information on how your front airbags work).

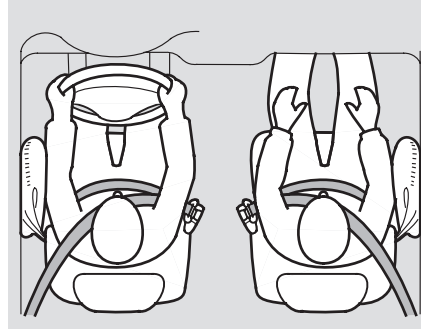

Your vehicle also has side airbags to help protect the upper torso of the driver or a front seat passenger during a moderate to severe side impact (see page 29 for more information on how your side airbags work).

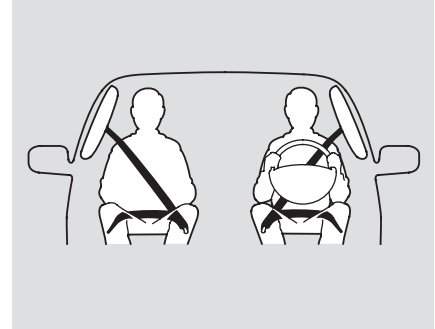

In addition, your vehicle has side curtain airbags to help protect the heads of the driver, front passenger, and passengers in the outer rear seating positions during a moderate to severe side impact or rollover (see page 30 for more information on how your side curtain airbags work).

*CONTINUED*

## Your Vehicle's Safety Features

---

The most important things you need to know about your airbags are:

- ***Airbags do not replace seat belts.*** They are designed to supplement the seat belts.
- ***Airbags offer no protection in rear impacts, or minor frontal or side collisions.***
- ***Airbags can pose serious hazards.*** To do their job, airbags must inflate with tremendous force. So while airbags help save lives, they can cause minor injuries or more serious or even fatal injuries if occupants are not properly restrained or sitting properly.

***What you should do:*** Always wear your seat belt properly, and sit upright and as far back from the steering wheel as possible while allowing full control of the vehicle. A front passenger should move their seat as far back from the dashboard as possible.

The rest of this section gives more detailed information about how you can maximize your safety.

Remember, however, that no safety system can prevent all injuries or deaths that can occur in a severe crash, even when seat belts are properly worn and the airbags deploy.

### Introduction

The following pages provide instructions on how to properly protect the driver, adult passengers, and teenage children who are large enough and mature enough to drive or ride in the front.

See pages 35 – 39 for important guidelines on how to properly protect infants, small children, and larger children who ride in your vehicle.

### 1. Close and Lock the Doors

After everyone has entered the vehicle, be sure the doors and the tailgate are closed and locked.

Your vehicle has a door and tailgate monitor on the multi-information display to indicate when a specific door or the tailgate is not tightly closed. You will see the appropriate indicator and the message for each condition.



When one or more doors are not tightly closed, the “DOOR OPEN” message will come on.

When the tailgate is not tightly closed, the “TAILGATE OPEN” message will come on.



When both tailgate and one or more doors are not tightly closed, the “DOOR & TAILGATE OPEN” message will come on.

*CONTINUED*

## Protecting Adults and Teens

---

Locking the doors and the tailgate reduces the chance of someone being thrown out of the vehicle during a crash, and it helps prevent passengers from accidentally opening a door or the tailgate and falling out.

Locking the doors and the tailgate also helps prevent an outsider from unexpectedly opening a door or the tailgate when you come to a stop.

See page [123](#) for how to lock the doors and the tailgate.

This vehicle has auto door locking/unlocking features. See pages [101](#) and [109](#) for how to set them.

### 2. Adjust the Front Seats

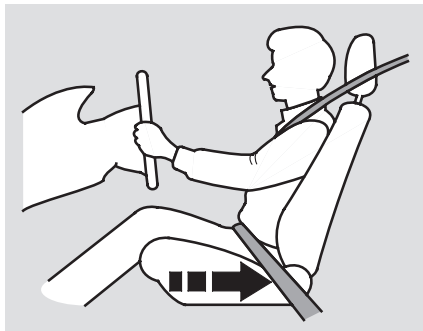

Adjust the driver's seat as far to the rear as possible while allowing you to maintain full control of the vehicle. Have a front passenger adjust their seat as far to the rear as possible.

If you sit too close to the steering wheel or dashboard, you can be seriously injured by an inflating front airbag, or by striking the steering wheel or dashboard.

The National Highway Traffic Safety Administration and Transport Canada recommend that drivers allow at least 10 inches (25 cm) between the center of the steering wheel and the chest. In addition to adjusting the seat, you can adjust the steering wheel up and down, and in and out (see page [119](#)).

If you cannot get far enough away from the steering wheel and still reach the controls, we recommend that you investigate whether some type of adaptive equipment may help.



### **⚠ WARNING**

Sitting too close to a front airbag can result in serious injury or death if the front airbags inflate.

Always sit as far back from the front airbags as possible.

Once your seat is adjusted correctly, rock it back and forth to make sure the seat is locked in position.

See pages [131](#) and [132](#) for how to adjust the front seats.

### 3. Adjust the Seat-Backs

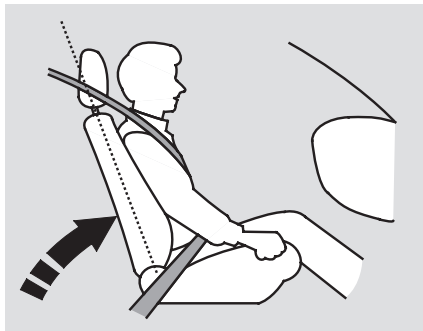

Adjust the driver's seat-back to a comfortable, upright position, leaving ample space between your chest and the airbag cover in the center of the steering wheel.

Passengers with adjustable seat-backs should also adjust their seat-back to a comfortable, upright position.

### **⚠ WARNING**

Reclining the seat-back too far can result in serious injury or death in a crash.

Adjust the seat-back to an upright position, and sit well back in the seat.

Reclining a seat-back so that the shoulder part of the belt no longer rests against the occupant's chest reduces the protective capability of the belt. It also increases the chance of sliding under the belt in a crash and being seriously injured. The farther a seat-back is reclined, the greater the risk of injury.

See pages [131](#) and [132](#) for how to adjust the seat-backs.

## Protecting Adults and Teens

### 4. Adjust the Head Restraints

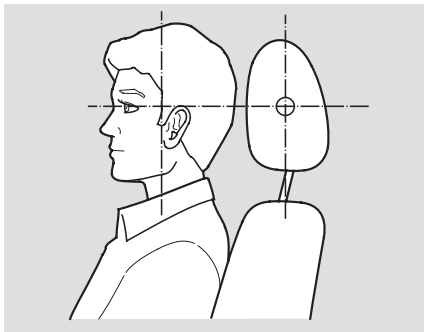

Adjust the driver's head restraint so the center of the back of your head rests against the center of the restraint.

Have passengers adjust their head restraints properly as well. Taller persons should adjust their restraint as high as possible.

### **⚠ WARNING**

Improperly positioning head restraints reduces their effectiveness and you can be seriously injured in a crash.

Make sure head restraints are in place and positioned properly before driving.

Properly adjusted head restraints will help protect occupants from whiplash and other crash injuries.

See page [133](#) for how to adjust the head restraints and how the driver's and front passenger's active head restraints work.

### 5. Fasten and Position the Seat Belts

Insert the latch plate into the buckle, then tug on the belt to make sure the belt is securely latched. Check that the belt is not twisted, because a twisted belt can cause serious injuries in a crash.



Position the lap part of the belt as low as possible across your hips, then pull up on the shoulder part of the belt so the lap part fits snugly. This lets your strong pelvic bones take the force of a crash and reduces the chance of internal injuries.

If necessary, pull up on the shoulder belt again to remove any slack, then check that the belt rests across the center of your chest and over your shoulder.

This spreads the forces of a crash over the strongest bones in your upper body.

**⚠ WARNING**

Improperly positioning the seat belts can cause serious injury or death in a crash.

Make sure all seat belts are properly positioned before driving.

If the seat belt touches or crosses your neck, or if it crosses your arm instead of your shoulder, you need to adjust the seat belt anchor height.



The front seats have adjustable seat belt anchors. To adjust the height of an anchor, press and hold the release button and slide the anchor up or down as needed (it has four positions).

*CONTINUED*

## Protecting Adults and Teens

---

***Never place the shoulder portion of a lap/shoulder belt under your arm or behind your back.*** This could cause very serious injuries in a crash.

If a seat belt does not seem to work properly, it may not protect the occupant in a crash.

***No one should sit in a seat with an inoperative seat belt.*** Using a seat belt that is not working properly can result in serious injury or death. Have your dealer check the belt as soon as possible.

See page 19 for additional information about your seat belts and how to take care of them.

### **6. Maintain a Proper Sitting Position**

After all occupants have adjusted their seats and head restraints, and put on their seat belts, it is very important that they continue to sit upright, well back in their seats, with their feet on the floor, until the vehicle is parked and the engine is off.

Sitting improperly can increase the chance of injury during a crash. For example, if an occupant slouches, lies down, turns sideways, sits forward, leans forward or sideways, or puts one or both feet up, the chance of injury during a crash is greatly increased.

In addition, an occupant who is out of position in the front seat can be seriously or fatally injured in a crash by striking interior parts of the vehicle or being struck by an inflating front airbag.

#### **WARNING**

Sitting improperly or out of position can result in serious injury or death in a crash.

Always sit upright, well back in the seat, with your feet on the floor.

### Advice for Pregnant Women



If you are pregnant, the best way to protect yourself and your unborn child when driving or riding in a vehicle is to always wear a seat belt, and keep the lap part of the belt as low as possible across the hips.

When driving, remember to sit upright and adjust the seat as far back as possible while allowing full control of the vehicle. When riding as a front passenger, adjust the seat as far back as possible.

This will reduce the risk of injuries to both you and your unborn child that can be caused by a crash or an inflating front airbag.

Each time you have a checkup, ask your doctor if it's okay for you to drive.

## Protecting Adults and Teens

---

### Additional Safety Precautions

- **Never let passengers ride in the cargo area or on top of a folded-down back seat.** If they do, they could be very seriously injured in a crash.
- **Passengers should not stand up or change seats while the vehicle is moving.** A passenger who is not wearing a seat belt during a crash or emergency stop can be thrown against the inside of the vehicle, against other occupants, or out of the vehicle.
- **Two people should never use the same seat belt.** If they do, they could be very seriously injured in a crash.
- **Do not put any accessories on seat belts.** Devices intended to improve occupant comfort or reposition the shoulder part of a seat belt can reduce the protective capability of the belt and increase the chance of serious injury in a crash.
- **Do not place hard or sharp objects between yourself and a front airbag.** Carrying hard or sharp objects on your lap, or driving with a pipe or other sharp object in your mouth, can result in injuries if your front airbag inflates.
- **Keep your hands and arms away from the airbag covers.** If your hands or arms are close to an airbag cover, they could be injured if the airbag inflates.
- **Do not attach or place objects on the front airbag covers.** Objects on the covers marked “SRS AIRBAG” could interfere with the proper operation of the airbags or be propelled inside the vehicle and hurt someone if the airbags inflate.
- **Do not attach hard objects on or near a door.** If a side airbag or a side curtain airbag inflates, a cup holder or other hard object attached on or near the door could be propelled inside the vehicle and hurt someone.

## Additional Information About Your Seat Belts

### Seat Belt System Components

Your seat belt system includes lap/shoulder belts in all five seating positions. The front seat belts are also equipped with automatic seat belt tensioners.

This system uses the same sensors as the front airbags to monitor whether the front seat belts are latched or unlatched, and how much weight is on the front passenger's seat (see pages [27](#) and [28](#)).



The seat belt system includes an indicator on the instrument panel and a beeper to remind you and your passengers to fasten your seat belts.

This system monitors the front seat belts. If you turn the ignition switch to the ON (II) position before your seat belt is fastened, the beeper will sound and the indicator will flash. If your seat belt is not fastened before the beeper stops, the indicator will stop flashing but remain on.

If a front passenger does not fasten their seat belt, the indicator will come on about 6 seconds after the ignition switch is turned to the ON (II) position.

If either the driver or a front passenger does not fasten their seat belt while driving, the beeper will sound and the indicator will flash again at regular intervals.

You will also see a “FASTEN SEAT BELT” or “FASTEN PASSENGER SEAT BELT” message on the multi-information display (see page [77](#)).

When no one is sitting in the front passenger's seat, or a child or small adult is riding there, the indicator should not come on and the beeper should not sound.

*CONTINUED*

## Additional Information About Your Seat Belts

---

If the indicator comes on or the beeper sounds when the driver's seat belt is latched and there is no front seat passenger and no items on the front seat, something may be interfering with the monitoring system. Look for and remove:

- Any items under the front passenger's seat.
- Any object(s) hanging on the seat or in the seat-back pocket.
- Any object(s) touching the rear of the seat-back.

If no obstructions are found, have your vehicle checked by a dealer.

### Lap/Shoulder Belt

The lap/shoulder belt goes over your shoulder, across your chest, and across your hips.

To fasten the belt, insert the latch plate into the buckle, then tug on the belt to make sure the buckle is latched (see page 14 for how to properly position the belt).

To unlock the belt, press the red PRESS button on the buckle. Guide the belt across your body so that it retracts completely. After exiting the vehicle, be sure the belt is out of the way and will not get closed in the door.

All seat belts have an emergency locking retractor. In normal driving, the retractor lets you move freely in your seat while it keeps some tension on the belt. During a collision or sudden stop, the retractor automatically locks the belt to help restrain your body.

The seat belts in all positions except the driver's have a lockable retractor that must be activated to secure a child seat (see page 49).



## Additional Information About Your Seat Belts

If the shoulder part of the belt is pulled all the way out, the lockable retractor will activate. The belt will retract, but it will not allow the passenger to move freely.

To deactivate the lockable retractor, unlatch the buckle and let the seat belt fully retract. To refasten the seat belt, pull it out only as far as needed.

### Automatic Seat Belt Tensioners

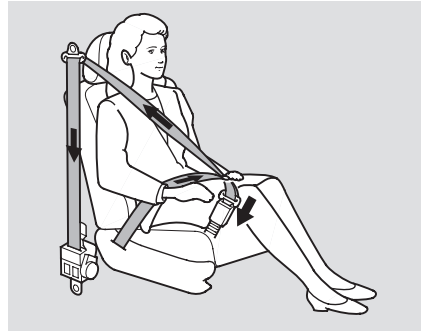

For added protection, the front seat belts are equipped with automatic seat belt tensioners. When activated, the tensioners immediately tighten the belts to help hold the driver and a front passenger in position.

The tensioners are designed to activate in any collision severe enough to cause the front airbags to deploy, or if a sensor detects your vehicle is about to roll over (see page 30).

If a side airbag or side curtain airbag deploys during a side impact, the tensioner on that side of the vehicle will also deploy.

The tensioners can also be activated during a collision in which the front airbags *do not deploy*. In this case, the airbags would not be needed, but the additional restraint could be helpful.

When the tensioners are activated, the seat belts will remain tight until they are unbuckled.

## Additional Information About Your Seat Belts

---

### Seat Belt Maintenance

For safety, you should check the condition of your seat belts regularly.

Pull each belt out fully, and look for frays, cuts, burns, and wear. Check that the latches work smoothly and the belts retract easily. If a belt does not retract easily, cleaning the belt may correct the problem (see page 354). Any belt that is not in good condition or working properly will not provide good protection and should be replaced as soon as possible.

Acura provides a limited warranty on seat belts. See your *Acura Warranty Information* booklet for details.

If a seat belt is worn during a crash, it must be replaced by your dealer. A belt that has been worn during a crash may not provide the same level of protection in a subsequent crash.

The dealer should also inspect the anchors for damage and replace them if needed. If the automatic seat belt tensioners activate during a crash, they must be replaced.

### WARNING

Not checking or maintaining seat belts can result in serious injury or death if the seat belts do not work properly when needed.

Check your seat belts regularly and have any problem corrected as soon as possible.

## Additional Information About Your Airbags

### Airbag System Components

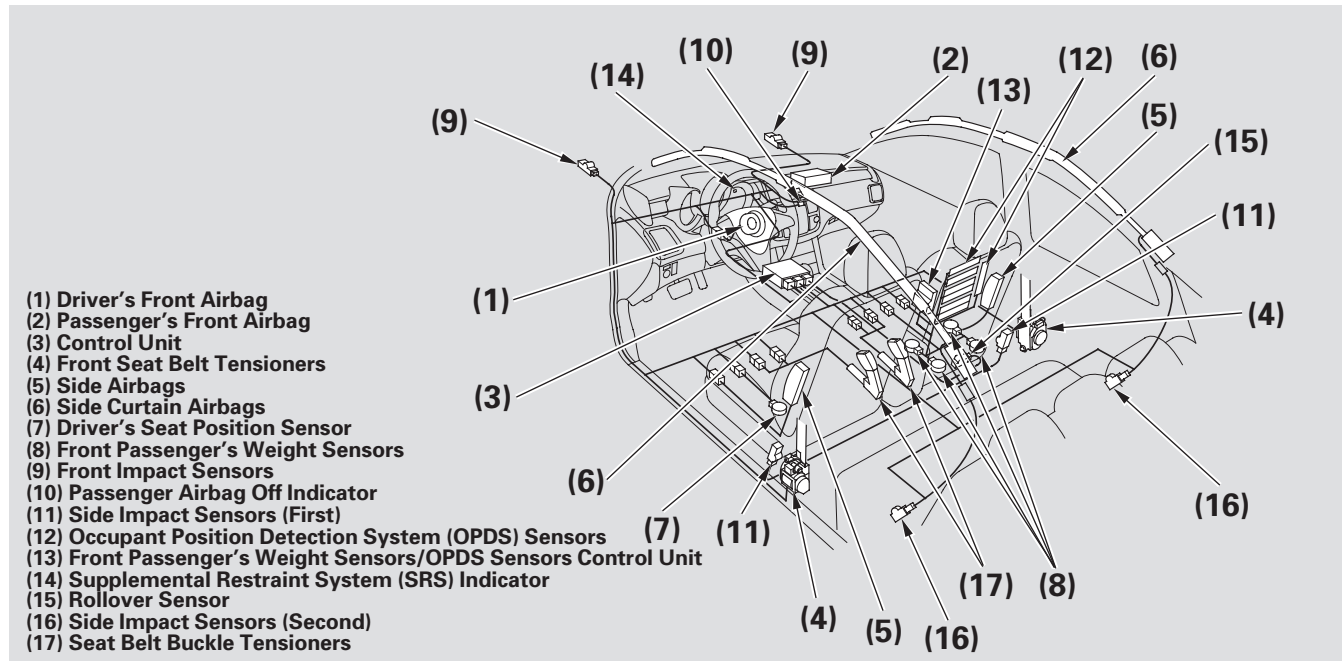

CONTINUED

## Additional Information About Your Airbags

---

Your airbag system includes:

- Two SRS (supplemental restraint system) front airbags. The driver's airbag is stored in the center of the steering wheel; the front passenger's airbag is stored in the dashboard. Both are marked "SRS AIRBAG" (see page 25).
- Two side airbags, one for the driver and one for a front passenger. The airbags are stored in the outer edges of the seat-backs. Both are marked "SIDE AIRBAG" (see page 29).
- Two side curtain airbags, one for each side of the vehicle. The airbags are stored in the ceiling, above the side windows. The front and rear pillars are marked "SIDE CURTAIN AIRBAG" (see page 30).
- Automatic front seat belt tensioners (see page 21).
- Sensors that can detect a moderate to severe front impact, side impact, or rollover.
- Sensors that can detect whether a child is in the passenger's side airbag path and signal the control unit to turn the airbag off (see page 29).
- Sensors that can detect whether the driver's seat belt and the front passenger's seat belt are latched or unlatched (see page 19).
- A driver's seat position sensor that monitors the distance of the seat from the front airbag. If the seat is too far forward, the airbag will inflate with less force (see page 27).
- Weight sensors that monitor the weight on the front passenger's seat. If the weight is about 65 lbs (29 kg) or less (the weight of an infant or small child), the passenger's front airbag will be turned off (see page 28).
- A rollover sensor that can detect if your vehicle is about to roll over and signal the control unit to deploy both side curtain airbags and front seat belt tensioners (see page 30).
- A sophisticated electronic system that continually monitors and records information about the sensors, the control unit, the airbag activators, the seat belt tensioners, and driver and front passenger seat belt use when the ignition switch is in the ON (II) position.

## Additional Information About Your Airbags

- An indicator on the instrument panel that alerts you to a possible problem with your airbags, sensors, or seat belt tensioners (see page 31).
- An indicator on the instrument panel that alerts you that the passenger's side airbag has been turned off (see page 31).
- An indicator on the dashboard that alerts you that the passenger's front airbag has been turned off (see page 32).
- Emergency backup power in case your vehicle's electrical system is disconnected in a crash.

### How Your Front Airbags Work

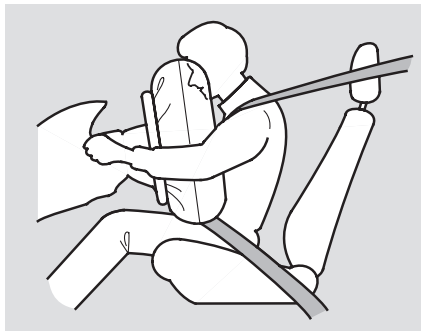

If you ever have a moderate to severe frontal collision, sensors will detect the vehicle's rapid deceleration.

If the rate of deceleration is high enough, the control unit will instantly inflate the driver's and front passenger's airbags, at the time and with the force needed.

During a frontal crash, your seat belt restrains your lower body and torso, and the front airbag helps protect your head and chest.

Although both airbags normally inflate within a split second of each other, it is possible for only one airbag to deploy.

This can happen if the severity of a collision is at the margin, or threshold, that determines whether or not the airbags will deploy. In such cases, the seat belt will provide sufficient protection, and the supplemental protection offered by the airbag would be minimal.

Only the driver's airbag will deploy if there is no passenger in the front seat, or if the advanced airbag system has turned the passenger's airbag off (see page 32).

*CONTINUED*

## Additional Information About Your Airbags

---

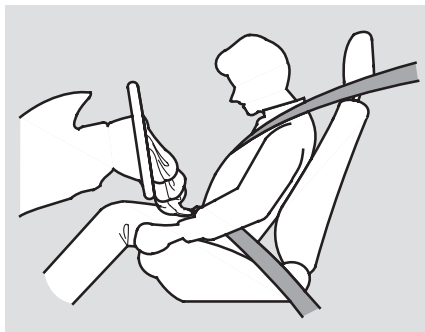

After inflating, the front airbags immediately deflate, so they won't interfere with the driver's visibility, or the ability to steer or operate other controls.

The total time for inflation and deflation is one-tenth of a second, so fast that most occupants are not aware that the airbags deployed until they see them lying in their laps.

After a crash, you may see what looks like smoke. This is actually powder from the airbag's surface. Although the powder is not harmful, people with respiratory problems may experience some temporary discomfort. If this occurs, get out of the vehicle as soon as it is safe to do so.

### ***Dual-Stage Airbags***

Your front airbags are dual-stage airbags. This means they have two inflation stages that can be ignited sequentially or simultaneously, depending on crash severity.

In a ***more severe*** crash, both stages will ignite simultaneously to provide the quickest and greatest protection.

In a ***less severe*** crash, one stage will ignite first, then the second stage will ignite a split second later. This provides longer airbag inflation time with a little less force.

## Additional Information About Your Airbags

### **Dual-Threshold Airbags**

Your front airbags are also dual-threshold airbags. Airbags with this feature have two deployment thresholds that depend on whether sensors detect the occupant is wearing a seat belt or not.

If the occupant's belt is **not latched**, the airbag will deploy at a slightly lower threshold, because the occupant would need extra protection.

If the occupant's belt is **latched**, the airbag will inflate at a slightly higher threshold, when the airbag would be needed to supplement the protection provided by the seat belt.

### **Advanced Airbags**

Your front airbags are also advanced airbags. The main purpose of this feature is to help prevent airbag-caused injuries to short drivers and children who ride in front.

For both advanced airbags to work properly:

- Occupants must sit upright and wear their seat belts properly.
- Do not spill any liquids on or under the seats, cover the sensors, or put any cargo or metal objects under the front seats.
- Back-seat passengers should not put their feet under the front seats.

Failure to follow these instructions could damage the sensors or prevent them from working properly.

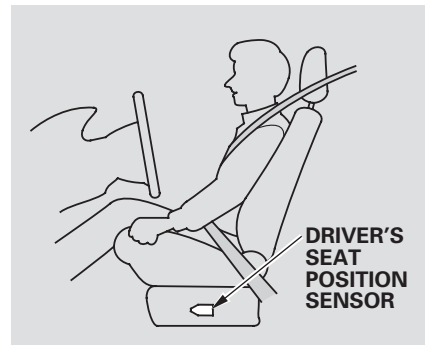

The driver's advanced front airbag system includes a seat position sensor under the seat. If the seat is too far forward, the airbag will inflate with less force, regardless of the severity of the impact.

If there is a problem with the sensor, the SRS indicator will come on, and the airbag will inflate in the normal manner regardless of the driver's seating position.

*CONTINUED*

## Additional Information About Your Airbags

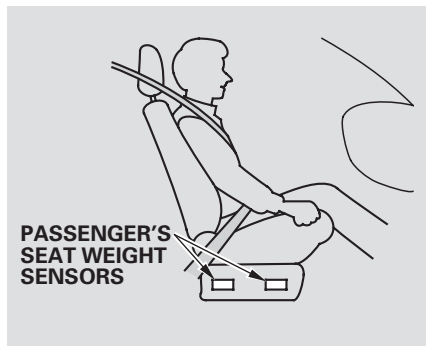

The passenger's advanced front airbag system has weight sensors under the seat. Although Acura does not encourage carrying an infant or small child in front, if the sensors detect the weight of an infant or small child (up to about 65 lbs or 29 kg), the system will automatically turn the passenger's front airbag off.

Be aware that objects placed on the passenger's seat can also cause the airbag to be turned off.

When the airbag is turned off, a "passenger airbag off" indicator in the center of the dashboard comes on (see page 32).

If the weight sensors detect there is no passenger in the front seat, the airbag will be off. However, the passenger airbag off indicator will not come on.

To ensure that the passenger's advanced front airbag system will work properly, ***do not do anything that would increase or decrease the weight on the front passenger's seat.*** This includes:

- A rear passenger pushing or pulling on the back of the front passenger's seat.

- Moving the front seat forcibly back against cargo on the seat or floor behind it.
- Hanging heavy items on the front passenger seat, or placing heavy items in the seat-back pocket.
- Moving the front seat or seat-back forcibly back against the folded rear seat.

Also, make sure the floor mat behind the front passenger's seat is properly positioned on the floor (see page 354). If it is not, the mat may interfere with the proper operation of the front passenger's seat and its sensors.



## Additional Information About Your Airbags

### How Your Side Airbags Work

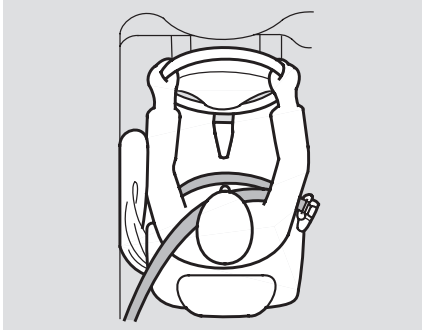

If you ever have a moderate to severe side impact, sensors will detect rapid acceleration and signal the control unit to instantly inflate either the driver's or the passenger's side airbag and activate the seat belt tensioner on the affected side.

Only one airbag will deploy during a side impact. If the impact is on the passenger's side, the passenger's side airbag will deploy even if there is no passenger.

To get the best protection from the side airbags, front seat occupants should wear their seat belts and sit upright and well back in their seats.

### *Side Airbag Cutoff System*

Your vehicle has a side airbag cutoff system designed primarily to protect a child riding in the front passenger's seat.

Although Acura does not encourage children to ride in front, if the position sensors detect a child has leaned into the side airbag's deployment path, the airbag will shut off.

The side airbag may also shut off if a short adult leans sideways, or a larger adult slouches and leans sideways into the airbag's deployment path.

Objects placed on the front passenger seat can also cause the side airbag to be shut off.

*CONTINUED*

## Additional Information About Your Airbags

---

If the side airbag off indicator comes on (see page 31), have the passenger sit upright. Once the passenger is out of the airbag's deployment path, the system will turn the airbag back on, and the indicator will go out.

There will be some delay between the moment the passenger moves into or out of the airbag deployment path and when the indicator comes on or goes off.

A front seat passenger should not use a cushion or other object as a backrest. It may prevent the cutoff system from working properly.

### How Your Side Curtain Airbags Work

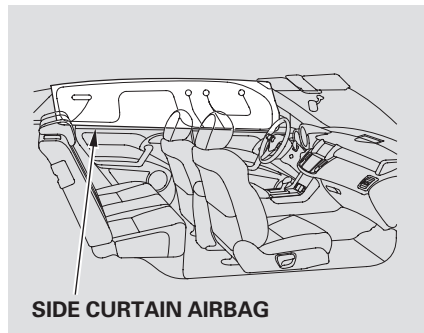

#### *In a Side Impact*

In a moderate to severe side impact, sensors will detect rapid acceleration and signal the control unit to instantly inflate the side curtain airbag and activate the seat belt tensioner on the driver's or the passenger's side of the vehicle.

If the impact is on the passenger's side, the passenger's side curtain airbag will inflate even if there are no occupants on that side of the vehicle.

#### *In a Rollover*

If the rollover sensor detects your vehicle is about to roll over, it signals the control unit, which immediately deploys both side curtain airbags and activates both front seat belt tensioners.

The airbag on the passenger's side will deploy, and the seat belt tensioner will activate, even if there are no passengers on that side of the vehicle.

To get the best protection from the side curtain airbags, occupants should wear their seat belts and sit upright and well back in their seats.

### How the SRS Indicator Works



The SRS indicator alerts you to a potential problem with your airbags or seat belt tensioners.

When you turn the ignition switch to the ON (II) position, this indicator comes on for several seconds then goes off. This tells you the system is working properly.

If the indicator comes on at any other time, or does not come on at all, you should have the system checked by your dealer. For example:

- If the SRS indicator does not come on after you turn the ignition switch to the ON (II) position.
- If the indicator stays on after the engine starts.
- If the indicator comes on or flashes on and off while you drive.

You will also see a “CHECK AIRBAG SYSTEM” message on the multi-information display (see page 78 ).

If you see any of these indications, the airbags and seat belt tensioners may not work properly when you need them.

### WARNING

Ignoring the SRS indicator can result in serious injury or death if the airbag systems or tensioners do not work properly.

Have your vehicle checked by a dealer as soon as possible if the SRS indicator alerts you to a possible problem.

### How the Side Airbag Off Indicator Works

U.S.

Canada



This indicator alerts you that the passenger's side airbag has been automatically shut off. It does *not* mean there is a problem with your side airbags.

When you turn the ignition switch to the ON (II) position, the indicator should come on for several seconds and then go off (see page 64 ). If it doesn't come on, stays on, or comes on while driving without a passenger in the front seat, have the system checked.

You will also see a “PASSENGER SIDE AIRBAG OFF” message on the multi-information display (see page 78 ).

## Additional Information About Your Airbags

### How the Passenger Airbag Off Indicator Works

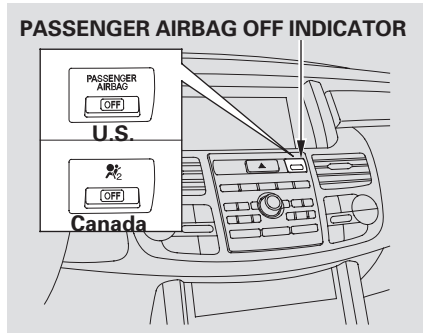

This indicator alerts you that the passenger's front airbag has been shut off because weight sensors detect about 65 lbs (29 kg) or less (the weight of an infant or small child) on the front passenger's seat. It does **not mean** there is a problem with the airbag.

Be aware that objects placed on the front seat can cause the indicator to come on.

If no weight is detected in the front seat, the airbag will be automatically shut off. However, the indicator will not come on.

The passenger airbag off indicator may come on and off repeatedly if the total weight on the seat is near the airbag cutoff threshold.

If an adult or teenage passenger is riding in front, move the seat as far to the rear as possible, and have the passenger sit upright and wear the seat belt properly.

If the indicator comes on with no front seat passenger and no objects on the seat, or with an adult riding there, something may be interfering with the weight sensors. Look for and remove:

- Any items under the front passenger's seat.
- Any object(s) hanging on the seat or in the seat-back pocket.
- Any object, such as a folded-down back seat, that is touching the rear of the seat-back.

If no obstructions are found, have your vehicle checked by a dealer as soon as possible.

### Airbag Service

Your airbag systems are virtually maintenance free, and there are no parts you can safely service. However, you must have your vehicle serviced if:

- **An airbag ever inflates.** Any airbag that has deployed must be replaced along with the control unit and other related parts. Any seat belt tensioner that activates must also be replaced.

Do not try to remove or replace any airbag by yourself. This must be done by an authorized dealer or a knowledgeable body shop.

- **The SRS indicator alerts you to a problem.** Take your vehicle to an authorized dealer as soon as possible. If you ignore this indication, your airbags may not operate properly.

- **If your vehicle has a moderate to severe impact.** Even if your airbags do not inflate, your dealer should inspect the driver's seat position sensor, the front passenger's weight sensors, the front seat belt tensioners, and all seat belts worn during a crash to make sure they are operating properly.

## Additional Information About Your Airbags

---

### Additional Safety Precautions

- **Do not attempt to deactivate your airbags.** Together, airbags and seat belts provide the best protection.
  - **Do not tamper with airbag components or wiring for any reason.** Tampering could cause the airbags to deploy, possibly causing very serious injury.
  - **Do not expose the front passenger's seat-back to liquid.** If water or another liquid soaks into a seat-back, it can prevent the side airbag cutoff system from working properly.
- **Do not cover or replace front seat-back covers without consulting your dealer.** Improperly replacing or covering front seat-back covers can prevent your side airbags from inflating during a side impact.
- **Do not remove or modify a front seat without consulting your dealer.** This could make the driver's seat position sensor or the front passenger's weight sensors ineffective. If it is necessary to remove or modify a front seat to accommodate a person with disabilities, first contact Acura Client Services at 800-382-2238.

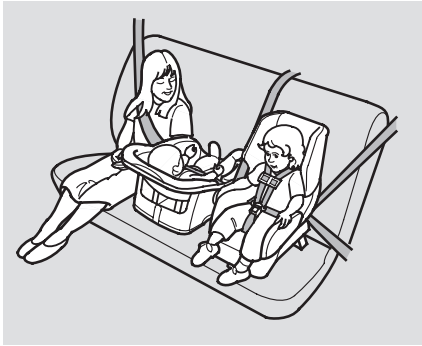

Children depend on adults to protect them. However, despite their best intentions, many adults do not know how to *properly* protect child passengers.

If you have children, or ever need to drive with a child in your vehicle, be sure to read this section. It begins with important general guidelines, then presents special information for infants, small children, and larger children.

### All Children Must Be Restrained

Each year, many children are injured or killed in vehicle crashes because they are either unrestrained or not properly restrained. In fact, vehicle accidents are the number one cause of the death of children aged 12 and under.

To reduce the number of child deaths and injuries, every state and Canadian province requires that infants and children be properly restrained when they ride in a vehicle.

***Infants and small children must be restrained in an approved child seat that is properly secured to the vehicle*** (see pages 40 – 55 ).

### **⚠ WARNING**

Children who are unrestrained or improperly restrained can be seriously injured or killed in a crash.

Any child too small for a seat belt should be properly restrained in a child seat. A larger child should be properly restrained with a seat belt and use a booster seat if necessary.

***Larger children must be restrained with a lap/shoulder belt and ride on a booster seat until the seat belt fits them properly*** (see pages 52 – 55 ).

## Protecting Children – General Guidelines

---

### All Children Should Sit in a Back Seat

According to accident statistics, children of all ages and sizes are safer when they are restrained in a back seat.

The National Highway Traffic Safety Administration and Transport Canada recommend that all children aged 12 and under be properly restrained in a back seat. Some states have laws restricting where children may ride.

Children who ride in back are less likely to be injured by striking interior vehicle parts during a collision or hard braking. Also, children cannot be injured by an inflating front airbag when they ride in the back.

### The Passenger's Front Airbag Can Pose Serious Risks

Front airbags have been designed to help protect adults in a moderate to severe frontal collision. To do this, the passenger's front airbag is quite large, and it can inflate with enough force to cause very serious injuries.

Even though your vehicle has an advanced front airbag system that automatically turns the passenger's front airbag off (see page 32), please follow these guidelines:

#### ***Infants***

***Never put a rear-facing child seat in the front seat of a vehicle equipped with a passenger's front airbag.*** If the airbag inflates, it can hit the back of the child seat with enough force to kill or very seriously injure an infant.

#### ***Small Children***

***Placing a forward-facing child seat in the front seat of a vehicle equipped with a passenger's front airbag can be hazardous.*** If the vehicle seat is too far forward, or the child's head is thrown forward during a collision, an inflating front airbag can strike the child with enough force to kill or very seriously injure a small child.

#### ***Larger Children***

***Children who have outgrown child seats are also at risk of being injured or killed by an inflating passenger's front airbag.*** Whenever possible, larger children should sit in the back seat, on a booster seat if needed, and be properly restrained with a seat belt (see page 52 for important information about protecting larger children).



To remind you of the passenger's front airbag hazards, and that children must be properly restrained in a back seat, your vehicle has warning labels on the dashboard (U.S. models) and on the front visors. Please read and follow the instructions on these labels.

## U.S. Models

### SUN VISORS



## Canadian Models

### SUN VISORS

<p><b>CAUTION</b> TO AVOID SERIOUS INJURY:</p> <ul style="list-style-type: none"><li>• FOR MAXIMUM SAFETY PROTECTION IN ALL TYPES OF CRASHES, YOU MUST ALWAYS WEAR YOUR SAFETY BELT.</li><li>• DO NOT INSTALL REARWARD-FACING CHILD SEATS IN ANY FRONT PASSENGER SEAT POSITION.</li><li>• DO NOT SIT OR LEAN UNNECESSARILY CLOSE TO THE AIR BAG.</li><li>• DO NOT PLACE ANY OBJECTS OVER THE AIR BAG OR BETWEEN THE AIR BAG AND YOURSELF.</li><li>• SEE THE OWNER'S MANUAL FOR FURTHER INFORMATION AND EXPLANATIONS.</li></ul>	<p><b>PRÉCAUTION:</b> POUR ÉVITER DES BLESSURES GRAVES:</p> <ul style="list-style-type: none"><li>• POUR PROFITER D'UNE PROTECTION MAXIMALE LORS D'UNE COLLISION BOUCLEZ TOUJOURS VOTRE CEINTURE DE SÉCURITÉ.</li><li>• N'INSTALLEZ JAMAIS UN SIÈGE POUR ENFANTS FAISANT FACE À L'ARRIÈRE SUR LE SIÈGE DU PASSAGER AVANT.</li><li>• NE VOUS APPUYEZ PAS ET NE VOUS ASSEYEZ PAS PRES DU COUSSIN GONFLABLE.</li><li>• NE DEPOSEZ AUCUN OBJET SUR LE COUSSIN GONFLABLE OU ENTRE LE COUSSIN GONFLABLE ET VOUS.</li><li>• LISEZ LE GUIDE UTILISATEUR POUR DE PLUS AMPLES RENSEIGNEMENTS.</li></ul>
------------------------------------------------------------------------------------------------------------------------------------------------------------------------------------------------------------------------------------------------------------------------------------------------------------------------------------------------------------------------------------------------------------------------------------------------------------------------------------------------------------------------------------	---------------------------------------------------------------------------------------------------------------------------------------------------------------------------------------------------------------------------------------------------------------------------------------------------------------------------------------------------------------------------------------------------------------------------------------------------------------------------------------------------------------------------------------------------------------------------------------------------

### DASHBOARD

This Vehicle is Equipped with Advanced Air Bags

#### Even with Advanced Air Bags

Children can be killed or seriously injured by the air bag.  
The back seat is the safest place for children.  
Never put a rear-facing child seat in the front.  
Always use seat belts and child restraints.  
See owner's manual for more information about air bags.

To be removed by owner only.

## Protecting Children – General Guidelines

---

### **If You Must Drive with Several Children**

Your vehicle has a back seat where children can be properly restrained. If you ever have to carry a group of children, and a child must ride in front:

- Place the largest child in the front seat, provided the child is large enough to wear the lap/shoulder belt properly (see page [52](#)).
- Move the vehicle seat as far to the rear as possible (see page [132](#)).
- Have the child sit upright and well back in the seat (see page [16](#)).
- Make sure the seat belt is properly positioned and secured (see page [14](#)).

### **If a Child Requires Close Attention**

Many parents say they prefer to put an infant or a small child in the front passenger seat so they can watch the child, or because the child requires attention.

Placing a child in the front seat exposes the child to hazards in a frontal collision, and paying close attention to a child distracts the driver from the important tasks of driving, placing both of you at risk.

If a child requires close physical attention or frequent visual contact, we strongly recommend that another adult ride with the child in a back seat. The back seat is far safer for a child than the front.

### Additional Safety Precautions

- **Never hold an infant or child on your lap.** If you are not wearing a seat belt in a crash, you could be thrown forward and crush the child against the dashboard or a seat-back. If you are wearing a seat belt, the child can be torn from your arms and be seriously hurt or killed.
- **Never put a seat belt over yourself or a child.** During a crash, the belt could press deep into the child and cause serious or fatal injuries.
- **Never let two children use the same seat belt.** If they do, they could be very seriously injured in a crash.
- **Use the childproof door locks to prevent children from opening the rear doors.** This can prevent children from accidentally falling out (see page [124](#)).

- **Make sure any unused seat belt that a child can reach is buckled, the lockable retractor is activated, and the belt is fully retracted and locked.** If a child wraps a loose seat belt around their neck, they can be seriously or fatally injured. (See pages [49](#) and [50](#) for how to activate and deactivate the lockable retractor.)

- **Do not leave children alone in a vehicle.** Leaving children without adult supervision is illegal in most states and Canadian provinces, and can be very hazardous.

For example, infants and small children left in a vehicle on a hot day can die from heatstroke. A child left alone with the key in the ignition switch can accidentally set the vehicle in motion, possibly injuring themselves or others.

- **Lock all doors and the tailgate when your vehicle is not in use.** Children who play in vehicles can accidentally get trapped inside. Teach your children not to play in or around vehicles.
- **Keep vehicle keys/remote transmitters out of the reach of children.** Even very young children learn how to unlock vehicle doors, turn on the ignition switch, and open the tailgate, which can lead to accidental injury or death.

## Protecting Infants and Small Children

---

### Protecting Infants

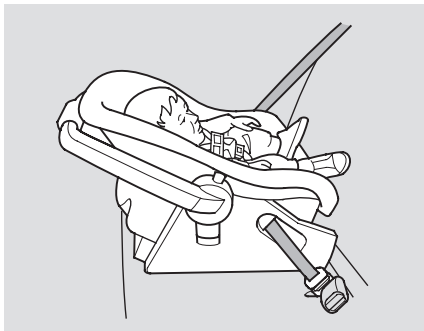

#### ***Child Seat Type***

An infant must be properly restrained in a rear-facing, reclining child seat until the child reaches the seat maker's weight or height limit for the seat, and the child is at least one year old.

Only a rear-facing child seat provides proper support for a baby's head, neck, and back.

Two types of seats may be used: a seat designed exclusively for infants, or a convertible seat used in the rear-facing, reclining mode.

***Do not put a rear-facing child seat in a forward-facing position.*** If placed facing forward, an infant could be very seriously injured during a frontal collision.

#### ***Rear-facing Child Seat Placement***

A rear-facing child seat can be placed in any seating position in the back seat, but not in the front. ***Never put a rear-facing child seat in the front seat.***

If the passenger's front airbag inflates, it can hit the back of the child seat with enough force to kill or seriously injure an infant.

When properly installed, a rear-facing child seat may prevent the driver or a front passenger from moving their seat as far back as recommended, or from locking their seat-back in the desired position.

It could also interfere with proper operation of the passenger's advanced front airbag system.

In any of these situations, we strongly recommend that you install the child seat directly behind the front passenger's seat, move the seat as far forward as needed, and leave it unoccupied. Or, you may wish to get a smaller rear-facing child seat.

## **⚠ WARNING**

Placing a rear-facing child seat in the front seat can result in serious injury or death during a collision.

Always place a rear-facing child seat in the back seat, not the front.

## Protecting Small Children



### *Child Seat Type*

A child who is at least one year old, and who fits within the child seat maker's weight and height limits, should be restrained in a forward-facing, upright child seat.

Of the different seats available, we recommend those that have a five-point harness system as shown.

We also recommend that a small child use the child seat until the child reaches the weight or height limit for the seat.

CONTINUED

## Protecting Infants and Small Children

---

### *Child Seat Placement*

We strongly recommend placing a forward-facing child seat in a back seat, not the front.

***Placing a forward-facing child seat in the front seat of a vehicle equipped with a passenger's airbag can be hazardous.*** If the vehicle seat is too far forward, or the child's head is thrown forward during a collision, an inflating airbag can strike the child with enough force to cause very serious or fatal injuries.

Even with advanced front airbags that automatically turn the passenger's front airbag off (see page 32), a back seat is the safest place for a small child.

If it is necessary to put a forward-facing child seat in the front, move the vehicle seat as far to the rear as possible, and be sure the child seat is firmly secured to the vehicle and the child is properly strapped in the seat.

### **WARNING**

Placing a forward-facing child seat in the front seat can result in serious injury or death if the front airbag inflates.

If you must place a forward-facing child seat in front, move the vehicle seat as far back as possible, and properly restrain the child.

When buying a child seat, you need to choose either a conventional child seat, or one designed for use with the lower anchors and tethers for children (LATCH) system.

Conventional child seats must be secured to a vehicle with a seat belt, whereas LATCH-compatible seats are secured by attaching the seat to hardware built into the rear seating positions.

Since LATCH-compatible child seats are easier to install and reduce the possibility of improper installation, we recommend selecting this style.

In seating positions and vehicles not equipped with LATCH, a LATCH-compatible child seat can be installed using a seat belt.

Whatever type of seat you choose, to provide proper protection, a child seat should meet three requirements:

- 1. *The child seat should meet U.S. or Canadian Motor Vehicle Safety Standard 213.*** Look for FMVSS 213 or CMVSS 213 on the box.
- 2. *The child seat should be of the proper type and size to fit the child.*** Rear-facing for infants, forward-facing for small children.
- 3. *The child seat should fit the vehicle seating position (or positions) where it will be used.***

Before purchasing a conventional child seat, or using a previously purchased one, we recommend that you test the seat in the specific vehicle seating position or positions where the seat will be used.

## Installing a Child Seat

---

After selecting a proper child seat and a good place to install the seat, there are three main steps in installing the seat:

**1. Properly secure the child seat to the vehicle.** All child seats must be secured to the vehicle with the lap part of a lap/shoulder belt or with the LATCH (lower anchors and tethers for children) system. A child whose seat is not properly secured to the vehicle can be endangered in a crash.

**2. Make sure the child seat is firmly secured.** After installing a child seat, push and pull the seat forward and from side-to-side to verify that it is secure.

A child seat secured with a seat belt should be installed as firmly as possible. However, it does not need to be “rock solid.” Some side-to-side movement can be expected and should not reduce the child seat’s effectiveness.

If the child seat is not secure, try installing it in a different seating position, or use a different style of child seat that can be firmly secured.

**3. Secure the child in the child seat.** Make sure the child is properly strapped in the child seat according to the child seat maker’s instructions. A child who is not properly secured in a child seat can be seriously injured in a crash.

The following pages provide guidelines on how to properly install a child seat. A forward-facing child seat is used in all examples, but the instructions are the same for rear-facing child seats.



### Installing a Child Seat with LATCH

Your vehicle is equipped with LATCH (lower anchors and tethers for children) at the rear seats to secure a child seat in any seating position: one in each outer seating position, or one in the center.

The five lower anchors are located between the seat-back and seat bottom, and are to be used only with a child seat designed for use with LATCH.

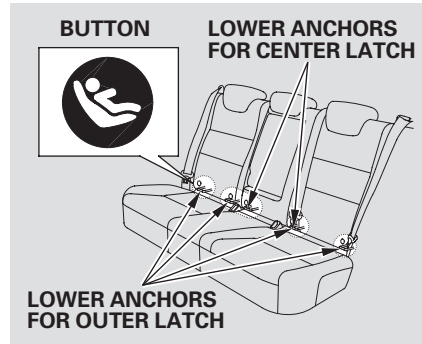

The location of each lower anchor is indicated by a small button above the anchor point.

When you install a child seat in the rear center seating position, use the center LATCH as shown in the illustration. To install a child seat in the outer seating position, use either LATCH. You can install up to two child seat at a time with outer LATCH.

### Using the Outer LATCH

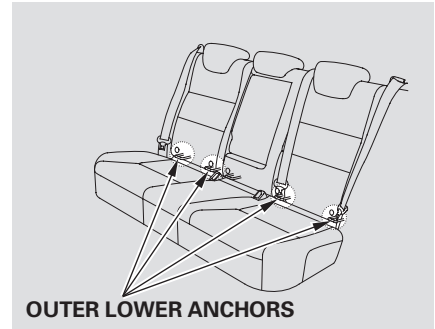

To install a LATCH-compatible child seat in either of the rear outer seats:

1. Move the seat belt buckle or tongue away from the lower anchors.
2. Make sure there are no objects near the anchors that could prevent a secure connection between the child seat and the anchors.

*CONTINUED*

## Installing a Child Seat

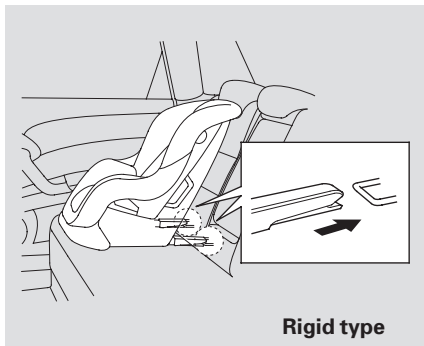

3. Place the child seat on the vehicle seat, then attach the seat to the lower anchors according to the child seat maker's instructions.

Some LATCH-compatible seats have a rigid-type connector as shown above.

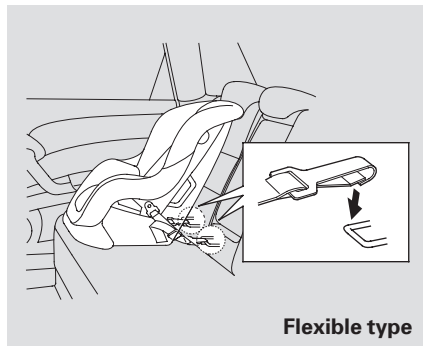

Other LATCH-compatible seats have a flexible-type connector as shown above.

4. Whatever type you have, follow the child seat maker's instructions for adjusting or tightening the fit.
5. Remove the cargo area cover, and place it on the cargo area floor (see page [158](#)).

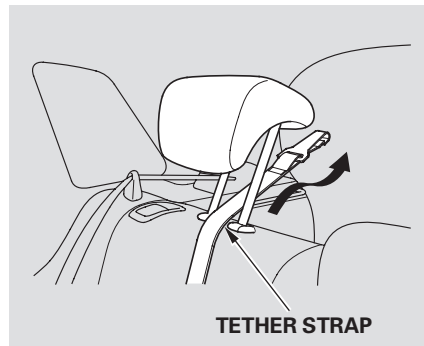

6. Lift the head restraint (see page [133](#)), then route the tether strap through the legs of the head restraint and over the seat-back, making sure the strap is not twisted.

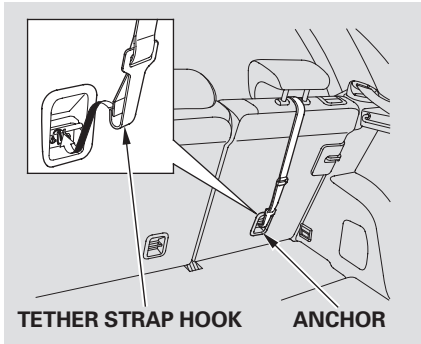

7. Attach the tether strap hook to the tether anchor, then tighten the strap as instructed by the child seat maker.
8. Push and pull the child seat forward and from side-to-side to verify that it is secure.

## Using the Center LATCH

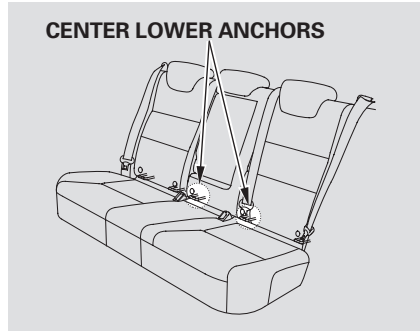

To install a LATCH-compatible child seat in the rear center seating position, use the center lower anchors as shown above.

Remove the head restraint (see page [134](#)). Make sure the removed head restraint is secured in the cargo area. Reinstall the head restraint when the child seat is removed.

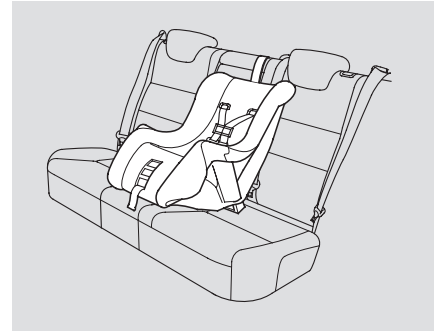

Follow step 1 through 8 as described previously to secure the child seat.

When you install the child seat in the rear center seating position, you cannot use the seat belt behind the driver's seat.

CONTINUED

## Installing a Child Seat

---

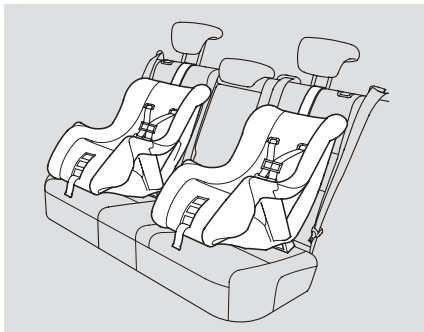

If you want to install two child seats in the back seats, place each child seat in the outer seat, as shown in the above illustration.

Do not attach two child seat connectors to a single lower anchor at a time.

The LATCH system or the child seats might be damaged if you try to install three child seats in the rear seats.

### Installing a Child Seat with a Lap/Shoulder Belt

When not using the LATCH system, all child seats must be secured to the vehicle with the lap part of a lap/shoulder belt.

In addition, the lap/shoulder belts in all seating positions except the driver's have a lockable retractor that must be activated to secure a child seat.

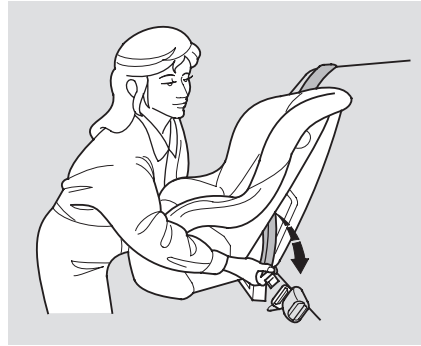

1. With the child seat in the desired seating position, route the belt through the child seat according to the seat maker's instructions, then insert the latch plate into the buckle.

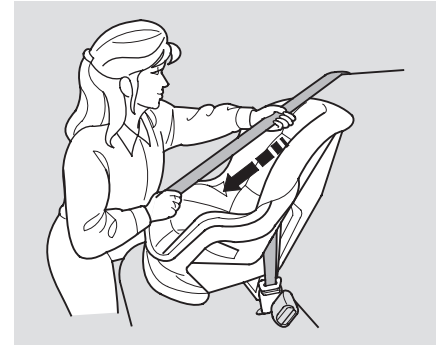

2. To activate the lockable retractor, slowly pull the shoulder part of the belt all the way out until it stops, then let the belt feed back into the retractor.
3. After the belt has retracted, tug on it. If the belt is locked, you will not be able to pull it out. If you can pull the belt out, it is not locked, and you will need to repeat these steps.

*CONTINUED*

## Installing a Child Seat



4. After confirming that the belt is locked, grab the shoulder part of the belt near the buckle, and pull up to remove any slack from the lap part of the belt. Remember, if the lap part of the belt is not tight, the child seat will not be secure.

To remove slack, it may help to put weight on the child seat, or push on the back of the seat while pulling up on the belt.



5. Push and pull the child seat forward and from side-to-side to verify that it is secure enough to stay upright during normal driving maneuvers. If the child seat is not secure, unlatch the belt, allow it to retract fully, then repeat these steps.

To deactivate the lockable retractor and remove a child seat, unlatch the buckle, unrout the seat belt, and let the belt fully retract.

### Installing a Child Seat with a Tether

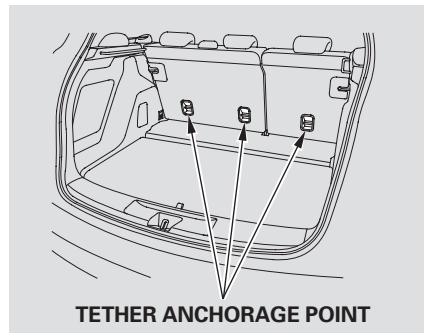

A child seat with a tether can be installed in any seating position in the back seat.

Since a tether can provide additional security to the lap/shoulder belt installation, we recommend using a tether whenever one is required or available.

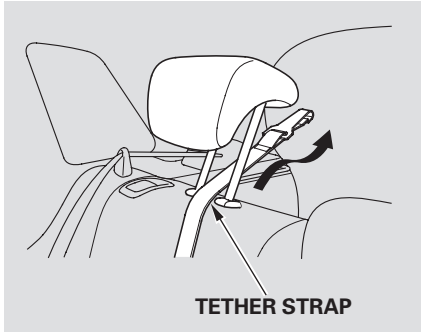

1. Remove the cargo area cover, and place it on the cargo area floor (see page 158).

2. (Outer seating position)  
After properly securing the child seat (see page 49), lift the head restraint, then route the tether strap over the seat-back and through the head restraint legs.

(Rear center seating position)  
Remove the head restraint (see page 134). Make sure the removed head restraint is secured in the cargo area. Reinstall the head restraint when the child seat is removed.

After properly securing the child seat (see page 49), route the tether strap over the top of the seat-back.

When you install the child seat in the rear center seating position, you cannot use the seat belt behind the driver's seat.

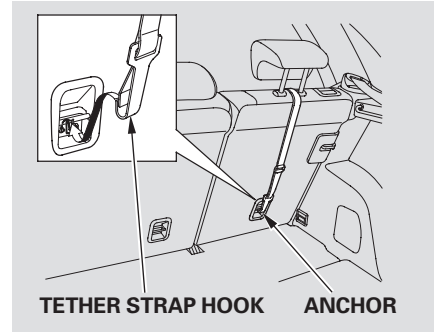

3. Attach the tether strap hook to the anchor, making sure the tether strap is not twisted.
4. Tighten the strap according to the seat maker's instructions.

## Protecting Larger Children

When a child reaches the recommended weight or height limit for a forward-facing child seat, the child should sit in a back seat on a booster seat and wear a lap/shoulder belt.

The following pages give instructions on how to check proper seat belt fit, what kind of booster seat to use if one is needed, and important precautions for a child who must sit in front.

### **⚠ WARNING**

Allowing a child age 12 or under to sit in front can result in injury or death if the passenger's front airbag inflates.

If a child must ride in front, move the vehicle seat as far back as possible, use a booster seat if needed, have the child sit up properly and wear the seat belt properly.

### Checking Seat Belt Fit



To determine if a lap/shoulder belt properly fits a child, have the child put on the seat belt, then ask yourself:

1. Does the child sit all the way back against the seat?
2. Do the child's knees bend comfortably over the edge of the seat?



3. Does the shoulder belt cross between the child's neck and arm?
4. Is the lap part of the belt as low as possible, touching the child's thighs?
5. Will the child be able to stay seated like this for the whole trip?

If you answer yes to all these questions, the child is ready to wear the lap/shoulder belt correctly. If you answer no to any question, the child needs to ride on a booster seat.

### Using a Booster Seat



A child who has outgrown a forward-facing child seat should ride in a back seat and use a booster seat until the lap/shoulder belt fits them properly without the booster.

Some states and Canadian provinces also require children to use a booster seat until they reach a given age or weight (e.g., 6 years or 60 lbs). Be sure to check current laws in the states or provinces where you intend to drive.

Booster seats can be high-back or low-back. Whichever style you select, make sure the booster seat meets federal safety standards (see page 43) and that you follow the booster seat maker's instructions.

*CONTINUED*

## Protecting Larger Children

---

If a child who uses a booster seat must ride in front, move the vehicle seat as far back as possible and be sure the child is wearing the seat belt properly.

A child may continue using a booster seat until the tops of their ears are even with the top of the vehicle's or booster's seat-back. A child of this height should be tall enough to use the lap/shoulder belt without a booster seat.

### **When Can a Larger Child Sit in Front**

The National Highway Traffic Safety Administration and Transport Canada recommend that all children aged 12 and under be properly restrained in a back seat.

If the passenger's front airbag inflates in a moderate to severe frontal collision, the airbag can cause serious injuries to a child who is unrestrained, improperly restrained, sitting too close to the airbag, or out of position.

A side airbag also poses risks. If any part of a larger child's body is in the path of a deploying side airbag, the child could receive possibly serious injuries.

Of course, children vary widely. And while age may be one indicator of when a child can safely ride in front, there are other important factors you should consider.

### ***Physical Size***

Physically, a child must be large enough for the lap/shoulder belt to properly fit (see pages 14 and 52). If the seat belt does not fit properly, with or without the child sitting on a booster seat, the child should not sit in front.

### ***Maturity***

To safely ride in front, a child must be able to follow the rules, including sitting properly, and wearing the seat belt properly throughout a ride.

If you decide that a child can safely ride up front, be sure to:

- Carefully read the owner's manual, and make sure you understand all seat belt instructions and all safety information.
- Move the vehicle seat to the rear-most position.
- Have the child sit up straight, back against the seat, and feet on or near the floor.
- Check that the child's seat belt is properly and securely positioned.
- Supervise the child. Even mature children sometimes need to be reminded to fasten the seat belts or sit properly.

### Additional Safety Precautions

- ***Do not let a child wear a seat belt across the neck.*** This could result in serious neck injuries during a crash.
- ***Do not let a child put the shoulder part of a seat belt behind the back or under the arm.*** This could cause very serious injuries during a crash. It also increases the chance that the child will slide under the belt in a crash and be injured.
- ***Two children should never use the same seat belt.*** If they do, they could be very seriously injured in a crash.

- ***Do not put any accessories on a seat belt.*** Devices intended to improve a child's comfort or reposition the shoulder part of a seat belt can make the belt less effective and increase the chance of serious injury in a crash.

## Carbon Monoxide Hazard

---

Your vehicle's exhaust contains carbon monoxide gas. Carbon monoxide should not enter the vehicle in normal driving if you maintain your vehicle properly and follow the information on this page.

Have the exhaust system inspected for leaks whenever:

- The vehicle is raised for an oil change.
- You notice a change in the sound of the exhaust.
- The vehicle was in an accident that may have damaged the underside.

### **WARNING**

Carbon monoxide gas is toxic. Breathing it can cause unconsciousness and even kill you.

Avoid any enclosed areas or activities that expose you to carbon monoxide.

High levels of carbon monoxide can collect rapidly in enclosed areas, such as a garage. Do not run the engine with the garage door closed. Even with the door open, run the engine only long enough to move the vehicle out of the garage.

With the tailgate open, airflow can pull exhaust gas into your vehicle's interior and create a hazardous condition. If you must drive with the tailgate open, open all the windows, and set the climate control system as shown below.

If you must sit in your parked vehicle with the engine running, even in an unconfined area, adjust the climate control system as follows:

1. Select the fresh air mode.
2. Select the  mode.
3. Set the fan speed to high.
4. Set the temperature control to a comfortable setting.

These labels are in the locations shown. They warn you of potential hazards that could cause serious injury or death. Read these labels carefully.

If a label comes off or becomes hard to read (except for the U.S. dashboard label which may be removed by the owner), contact your dealer for a replacement.

## DASHBOARD

*U.S. models only*

This Vehicle is Equipped with  
Advanced Air Bags

### Even with Advanced Air Bags

Children can be killed or seriously injured by the air bag. The back seat is the safest place for children. Never put a rear-facing child seat in the front. Always use seat belts and child restraints. See owner's manual for more information about air bags.

To be removed by owner only.

## SUN VISORS

*U.S. models*



*Canadian models*

<p><b>CAUTION</b> TO AVOID SERIOUS INJURY: • FOR MAXIMUM SAFETY PROTECTION IN ALL TYPES OF CRASHES YOU MUST ALWAYS WEAR YOUR SAFETY BELT. • DO NOT INSTALL REARWARD-FACING CHILD SEATS IN ANY FRONT-PASSENGER SEAT POSITION. • DO NOT SIT OR LEAN UNNECESSARILY CLOSE TO THE AIR BAG. • DO NOT PLACE ANY OBJECTS OVER THE AIR BAG OR BETWEEN THE AIR BAG AND YOURSELF. • SEE THE OWNER'S MANUAL FOR FURTHER INFORMATION AND EXPLANATIONS.</p>	<p><b>PRECAUTIONS:</b> POUR ÉVITER DES BLESSURES GRAVES: • POUR PROFITER D'UNE PROTECTION MAXIMALE LORS D'UNE COLLISION BOUCLEZ TOUJOURS VOTRE CEINTURE DE SÉCURITÉ. • N'INSTALLEZ JAMAIS UN SIÈGE POUR ENFANTS FAISANT FACE À L'ARRIÈRE SUR LE SIÈGE DU PASSAGER AVANT. • NE VOUS APPUYEZ PAS ET NE VOUS ASSOYEZ PAS PRES DE LA COLLISION GONFLABLE. • NE DÉPOSEZ AUCUN OBJET SUR LE COUSSIN GONFLABLE ET VOUS. • Lisez le guide utilisateur pour de plus amples renseignements.</p>
-----------------------------------------------------------------------------------------------------------------------------------------------------------------------------------------------------------------------------------------------------------------------------------------------------------------------------------------------------------------------------------------------------------------------------------------------------------------------	---------------------------------------------------------------------------------------------------------------------------------------------------------------------------------------------------------------------------------------------------------------------------------------------------------------------------------------------------------------------------------------------------------------------------------------------------------------------------------------------------------------

## SUN VISOR

*U.S. models only*

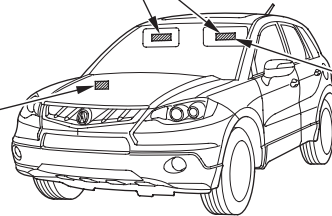
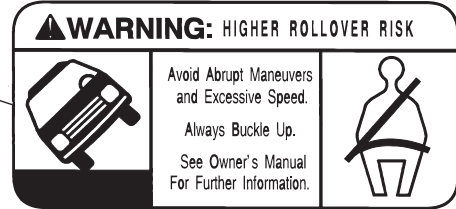

CONTINUED

# Safety Labels

## HOOD

### U.S. models

**SUPPLEMENTAL RESTRAINT SYSTEM (SRS)**  
 This vehicle is equipped with front air bags, side air bags in the front seats, and side curtain air bags. Always wear your seat belt and follow all other safety rules.  
 Toujours utiliser votre ceinture de sécurité, toujours porter votre SRS (côté et rideau) et respecter toutes les autres règles de sécurité.

**▲ WARNING**  
 Accidental deployment can seriously hurt or kill you. Follow Service Manual instructions carefully.

### Canadian models

**SUPPLEMENTAL RESTRAINT SYSTEM (SRS)**  
 This vehicle is equipped with front air bags, side air bags in the front seats, front curtain air bags, and side curtain air bags. Always wear your seat belt and follow all other safety rules. Toujours utiliser votre ceinture de sécurité, toujours porter votre SRS (côté et rideau) et respecter toutes les autres règles de sécurité.

**▲ WARNING**  
 Accidental deployment can seriously hurt or kill you. Follow Service Manual instructions carefully.

**SYSTÈME DE RETENUE SUPPLÉMENTAIRE (SRS)**  
 Ce véhicule est équipé de coussins gonflables (frontaux, latéraux en face avant, latéraux de côté et rideaux de côté). Toujours utiliser votre ceinture de sécurité, toujours porter votre SRS (côté et rideau) et respecter toutes les autres règles de sécurité.

**▲ ATTENTION**  
 Un déploiement accidentel peut entraîner des blessures graves ou la mort. Consultez le manuel de réparation attentivement.

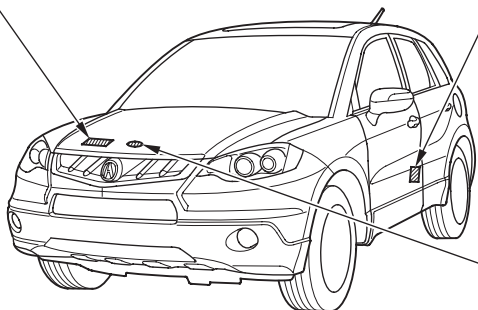

## DOORJAMBS

### U.S. models

**SIDE AIRBAG**

- This car is equipped with side airbags in the front seats and side curtain airbags.
- Do not lean against the door.
- See owner's manual for more information.

### Canadian models

**SIDE AIRBAG**

- This car is equipped with side airbags in the front seats and side curtain airbags.
- Do not lean against the door.
- See owner's manual for more information.

**COUSSIN GONFLABLE LATÉRAL**

- Cette automobile est équipée de coussins gonflables latéraux dans les sièges avant ainsi que de coussins gonflables latéraux de type rideau.
- Ne vous appuyez pas sur la porte.
- Consultez le Manuel du propriétaire pour en savoir plus.

## RADIATOR CAP

**DANGER**  
**WARNUNG**  
 危 険  
 危 険

- ▶ NEVER OPEN WHEN HOT. Hot coolant will scald you.
- ▶ N'OUVREZ PAS QUAND CHAUD. N'ICHT BEI HEISSEM MOTOR ÖFFNEN.
- ▶ 熱い時あけないで下さい。
- ▶ 高温時、請勿打开

**1.1**

This section gives information about the controls and displays that contribute to the daily operation of your vehicle. All the essential controls are within easy reach.

Control Locations .....	60	Customized Settings.....	80	Armrests .....	136
Instrument Panel .....	61	Controls Near the Steering		Folding the Rear Seats Down ..	136
Instrument Panel Indicators.....	62	Wheel .....	111	Seat Heaters .....	139
Gauges .....	71	Windshield Wipers and		Power Windows .....	140
Turbo Boost Meter.....	71	Washers.....	112	Moonroof .....	142
Fuel Gauge .....	71	Rear Window Wiper and		Mirrors.....	144
Multi-Information Display .....	72	Washer.....	113	Adjusting the Power Mirrors ...	144
System Messages .....	77	Turn Signal and Headlights.....	114	Reverse Mirror Tilt .....	145
		Instrument Panel Brightness .....	117	Heated Mirrors .....	145
		Rear Window Defogger .....	118	Driving Position Memory	
		Hazard Warning Button.....	118	System.....	146
		Steering Wheel Adjustment .....	119	Parking Brake .....	148
		Keys and Locks.....	119	Interior Lights .....	149
		Immobilizer System.....	121	Ceiling Lights.....	149
		Ignition Switch .....	122	Individual Map Lights .....	150
		Door Locks .....	123	Courtesy Lights .....	151
		Power Door Locks.....	123	Cargo Area Light .....	151
		Childproof Door Locks .....	124	Interior Convenience Items.....	152
		Tailgate .....	125	Glove Box .....	153
		Remote Transmitter .....	127	Front Door Pockets.....	153
		Seats .....	131	Beverage Holders.....	154
		Driver's Seat Adjustments.....	131	Accessory Power Sockets.....	155
		Front Passenger's Seat		Sun Visor .....	155
		Adjustments .....	132	Vanity Mirror .....	156
		Head Restraints .....	133	Console Compartment .....	156
		Active Head Restraints.....	135	Cargo Area Cover .....	158

## Control Locations

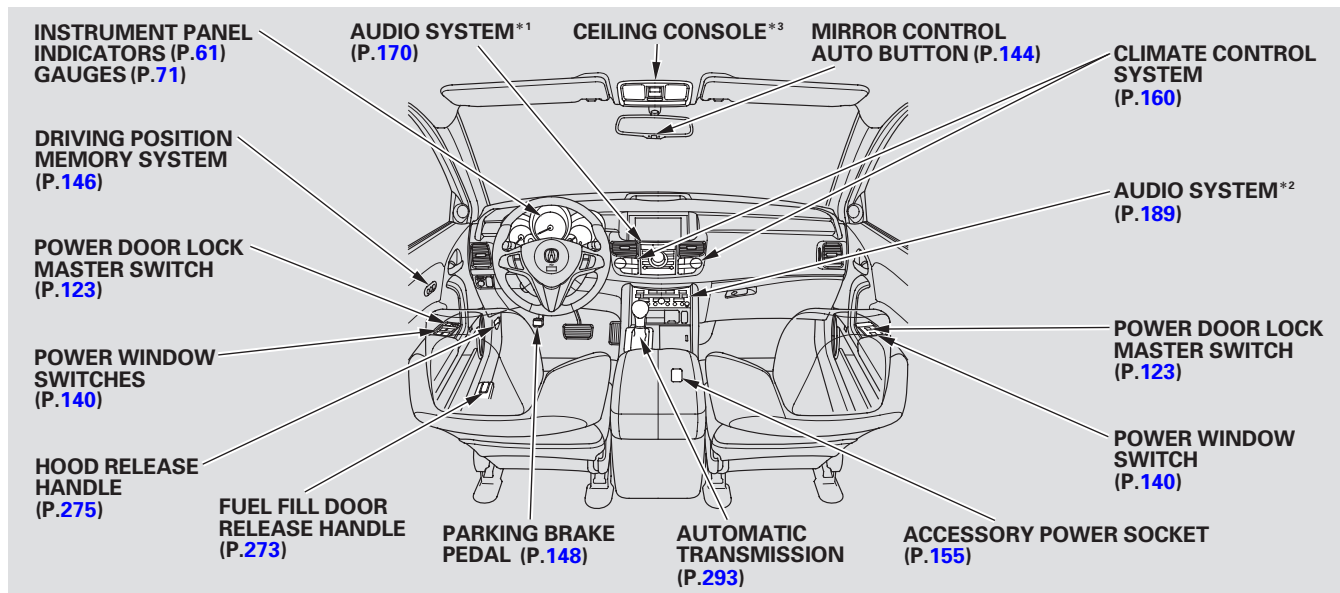

\* 1: On RDX model only

\* 2: On RDX Technology Package model only

\* 3: HomeLink Buttons (P.274)

Moonroof Switch (P.142)

Front Ceiling Light Switch (P.149)



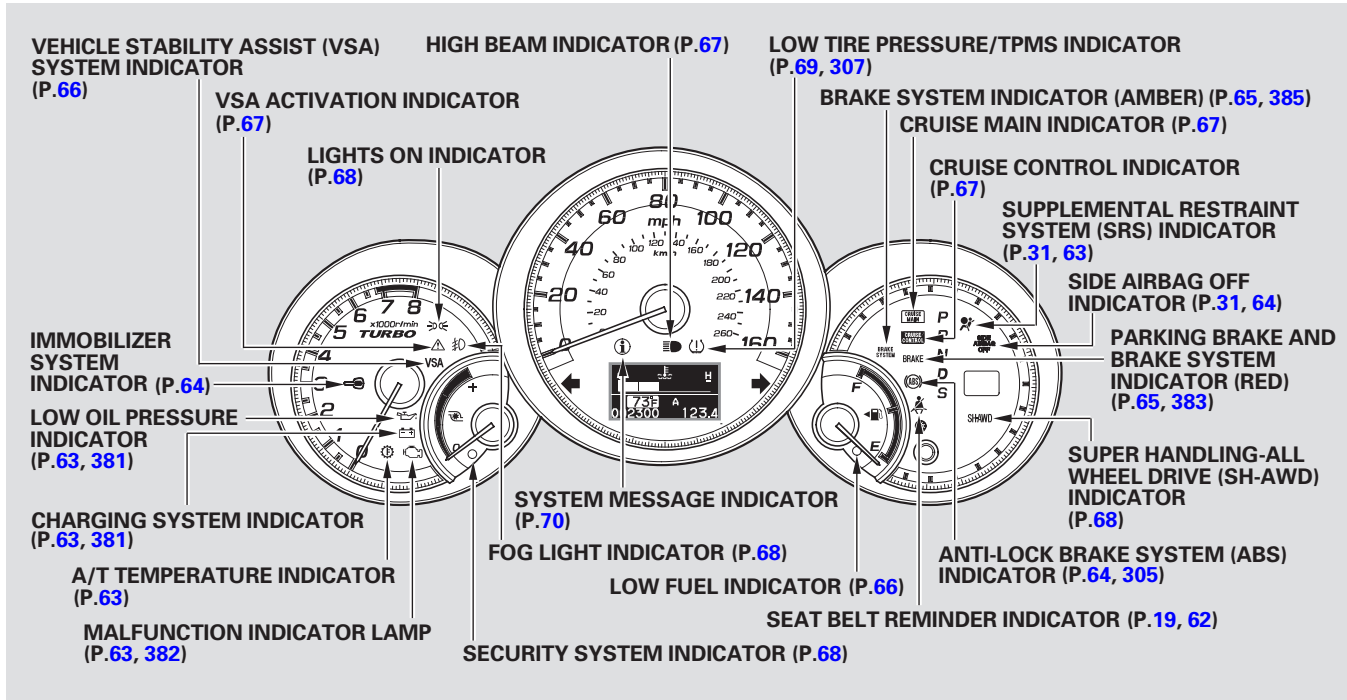

The U.S. instrument panel is shown. Differences for the Canadian models are noted in the text.

## Instrument Panel Indicators

---

The instrument panel has many indicators that give you important information about your vehicle.



### Seat Belt Reminder Indicator

This indicator reminds you and your passengers to fasten your seat belts.

If you turn the ignition switch to the ON (II) position before fastening your seat belts, the beeper sounds, and the indicator flashes. If you do not fasten your seat belts before the beeper stops, the indicator stops flashing but remains on.

If your front passenger does not fasten their seat belt, the indicator comes on about 6 seconds after the ignition switch is turned to the ON (II) position.

If either of you do not fasten your seat belt while driving, the beeper will sound and the indicator will flash again at regular intervals. For more information, see page [19](#).

You will also see a “FASTEN SEAT BELT” or “FASTEN PASSENGER SEAT BELT” message on the multi-information display (see page [77](#)).



### Malfunction Indicator Lamp

You will also see a “CHECK EMISSION SYSTEM” message on the multi-information display. For more information, see page [382](#).



### Low Oil Pressure Indicator

The engine can be severely damaged if this indicator flashes or stays on when the engine is running. For more information, see page [381](#). You will also see a “OIL PRESSURE LOW” message on the multi-information display (see page [77](#)).



### Charging System Indicator

If this indicator comes on when the engine is running, the battery is not being charged, and you will also see a “CHECK CHARGING SYSTEM” message on the multi-information display. For more information, see page [381](#).



### A/T Temperature Indicator

This indicator monitors the temperature of the automatic transmission fluid. If it comes on while driving, it means the transmission fluid temperature is too high. Pull to the side of the road when it is safe, shift to Park, and let the engine idle until the indicator goes out.

You will also see a “CHECK TRANSMISSION” message on the multi-information display (see page [78](#)).

### NOTICE

*Continuing to drive with the A/T temperature indicator on may cause serious damage to the transmission.*



### Supplemental Restraint System (SRS) Indicator

This indicator comes on for several seconds when you turn the ignition switch to the ON (II) position. If it comes on at any other time, it indicates a potential problem with your front airbags. This indicator will also alert you to a potential problem with your side airbags, passenger’s side airbag automatic cutoff system, automatic seat belt tensioners, side curtain airbags, driver’s seat position sensor, and the front passenger’s weight sensors. You will also see a “CHECK AIRBAG SYSTEM” message on the multi-information display (see page [78](#)). For more information, see page [31](#).

## Instrument Panel Indicators

---

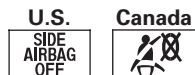

### Side Airbag Off Indicator

This indicator comes on when you turn the ignition switch to the ON (II) position. If it comes on at any other time, it indicates that the passenger's side airbag has automatically shut off. You will also see a "PASSENGER SIDE AIRBAG OFF" message on the multi-information display (see page [78](#)). For more information, see page [31](#).



### Anti-lock Brake System (ABS) Indicator

This indicator normally comes on for a few seconds when you turn the ignition switch to the ON (II) position, and when the ignition switch is turned to the START (III) position. If this indicator comes on at any other time, there is a problem in the ABS. If this happens, take the vehicle to your dealer to have it checked. With this indicator on, your vehicle still has normal braking ability but no anti-lock function. You will also see a "CHECK ABS SYSTEM" message on the multi-information display (see page [78](#)). For more information, see page [305](#).



### Immobilizer System Indicator

This indicator comes on briefly when you turn the ignition switch to the ON (II) position. It will then go off if you have inserted a properly-coded ignition key. If it is not a properly-coded key, the indicator will blink, and the engine's fuel system will be disabled (see page [121](#)).

U.S. Canada



### Parking Brake and Brake System Indicator (Red)

This indicator has two functions:

1. It comes on when you turn the ignition switch to the ON (II) position. It is a reminder to check the parking brake. Driving with the parking brake not fully released can damage the brakes and tires.

If you drive without releasing the parking brake, a beeper will sound, and you will also see a “RELEASE PARKING BRAKE” message on the multi-information display (see page [77](#) ).

2. If it stays on after you have fully released the parking brake while the engine is running, or if it comes on while driving, it can indicate a problem in the brake system. You will also see a “BRAKE FLUID LOW” or “CHECK BRAKE SYSTEM” message on the multi-information display. For more information, see page [383](#) .

U.S. Canada



### Brake System Indicator (Amber)

The brake system indicator (amber) normally comes on for a few seconds when you turn the ignition switch to the ON (II) position. If the indicator is still on or comes on again after the engine starts, there is a problem in the brake system including the electric vacuum pump. If this happens, have your vehicle checked by your dealer. For more information, see page [384](#) .

You will also see a “CHECK BRAKE SYSTEM” message on the multi-information display (see page [77](#) ).

## Instrument Panel Indicators

### Low Fuel Indicator

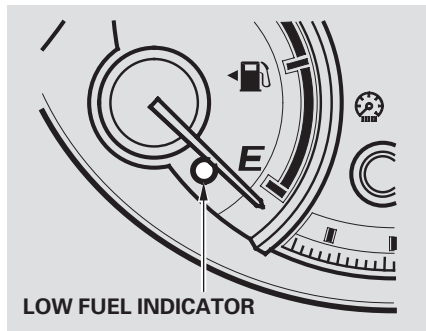

This indicator is in the fuel gauge. It comes on as a reminder that you must refuel soon. When the indicator comes on, there is about 2.5 US gal (9.5 l) of fuel remaining in the tank before the reading reaches E. There is a small reserve of fuel remaining in the tank when the reading does reach E.

You will also see a “FUEL LOW” message on the multi-information display (see page [78](#) ).

### **VSA** Vehicle Stability Assist (VSA) System Indicator

This indicator normally comes on for a few seconds when you turn the ignition switch to the ON (II) position.

If it comes on and stays on at any other time, or it does not come on when you turn the ignition switch to the ON (II) position, there is a problem with the VSA system. You will also see a “CHECK VSA SYSTEM” message on the multi-information display (see page [78](#) ). Take your vehicle to a dealer to have it checked. Without VSA, your vehicle still has normal driving ability, but will not have VSA traction and stability enhancement. For more information, see page [312](#) .



### VSA Activation Indicator

This indicator has three functions:

1. It comes on as a reminder that you have turned off the vehicle stability assist (VSA) system.
2. It flashes when VSA is active (see page 312).
3. It comes on along with the VSA system indicator if there is a problem with the VSA system. You will also see a “CHECK VSA SYSTEM” message on the multi-information display (see page 78).

This indicator normally comes on for a few seconds when you turn the ignition switch to the ON (II) position. For more information, see page 312.



### Cruise Main Indicator

This indicator comes on when you turn on the cruise control system by pressing the CRUISE button (see page 234).



### Cruise Control Indicator

This indicator comes on when you set the cruise control. See page 234 for information on operating the cruise control.



### High Beam Indicator

This indicator comes on with the high beam headlights. For more information, see page 115.

This indicator also comes on with reduced brightness when the daytime running lights (DRL) are on (see page 116).



### Turn Signal and Hazard Warning Indicators

The left or right turn signal indicator blinks when you signal a lane change or turn. If an indicator does not blink or blinks rapidly, it usually means one of the turn signal bulbs is burned out (see pages 348 and 350). Replace the bulb as soon as possible, since other drivers cannot see that you are signaling.

When you press the hazard warning button, both turn signal indicators and all turn signals on the outside of the vehicle flash.

## Instrument Panel Indicators

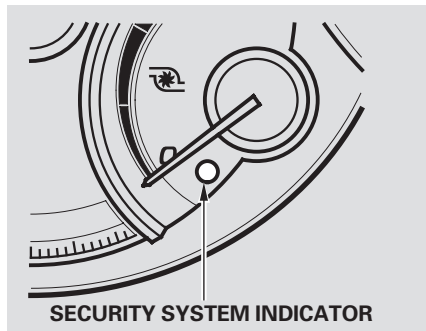

### Security System Indicator



This indicator comes on when the security system is set. For more information, see page [233](#).



### Lights On Indicator

This indicator reminds you that the exterior lights are on. It comes on when the light switch is in either the  or  position. If you turn the ignition switch to the ACCESSORY (I) or the LOCK (0) position without turning off the light switch, this indicator will remain on. A reminder chime will also sound when you open the driver's door and remove the key from the ignition switch.



### Fog Light Indicator

This indicator comes on when you turn on the fog lights. For more information, see page [115](#).



### Super Handling-All Wheel Drive (SH-AWD) Indicator

This indicator normally comes on for a few seconds when you turn the ignition switch to the ON (II) position. If this indicator comes on at any other time, there is a problem in the SH-AWD system. You will also see a "CHECK SH-AWD SYSTEM" message on the multi-information display (see page [78](#)). Take your vehicle to a dealer to have it checked. For more information, see page [301](#).



If this indicator blinks while driving, it indicates the differential temperature is too high. You will also see an “SH-AWD DIFF TEMP HIGH” message on the multi-information display (see page [78](#) ).

Pull to the side of the road when it is safe, shift to Park, and let the engine idle until the indicator goes out. If the indicator does not go out, take your vehicle to a dealer to have it checked.

For more information, see page [301](#) .

### NOTICE

*Continuing to drive with the SH-AWD indicator blinking may cause serious damage to the system.*



### Low Tire Pressure/ TPMS Indicator

This indicator normally comes on for a few seconds when you turn the ignition switch to the ON (II) position.

This indicator has two functions:

1. If it comes on while driving, it indicates that one or more of your vehicle's tires are significantly low on pressure.

You will also see a “CHECK TIRE PRESSURE” message on the multi-information display (see page [77](#) ).

Check the tire pressure monitor on the multi-information display and determine the cause (see page [308](#) ).

If this happens, pull to the side of the road when it is safe, check which tire has lost pressure on the multi-information display, and determine the cause. If it is because of a flat tire, have the flat tire repaired as soon as possible. If two or more tires are underinflated, call a professional towing service. For more information, see page [391](#) .

CONTINUED

## Instrument Panel Indicators

---

2. If this indicator begins to flash, there is a problem with the tire pressure monitoring system (TPMS). You will also see a “CHECK TPMS SYSTEM” message on the multi-information display. The indicator continues to flash for a while (approximately 1 minute), then stays on. If this happens, have your dealer check the system as soon as possible. For more information, see page [310](#).



### **System Message Indicator**

This indicator comes on when there is a system message on the multi-information display. Press the INFO button on the steering wheel (see page [72](#)) to see the message (see page [79](#)).

Most of the time, this indicator comes on along with other indicators in the instrument panel such as the seat belt reminder indicator, SRS indicator, VSA system indicator, etc.

**Turbo Boost Meter**

When the turbo charger is activated, this meter shows the boost pressure.

**Fuel Gauge**

This shows how much fuel you have. It may show slightly more or less than the actual amount. The needle returns to the bottom after you turn off the ignition.

**NOTICE**

*Avoid driving with an extremely low fuel level. Running out of fuel could cause the engine to misfire, damaging the catalytic converter.*

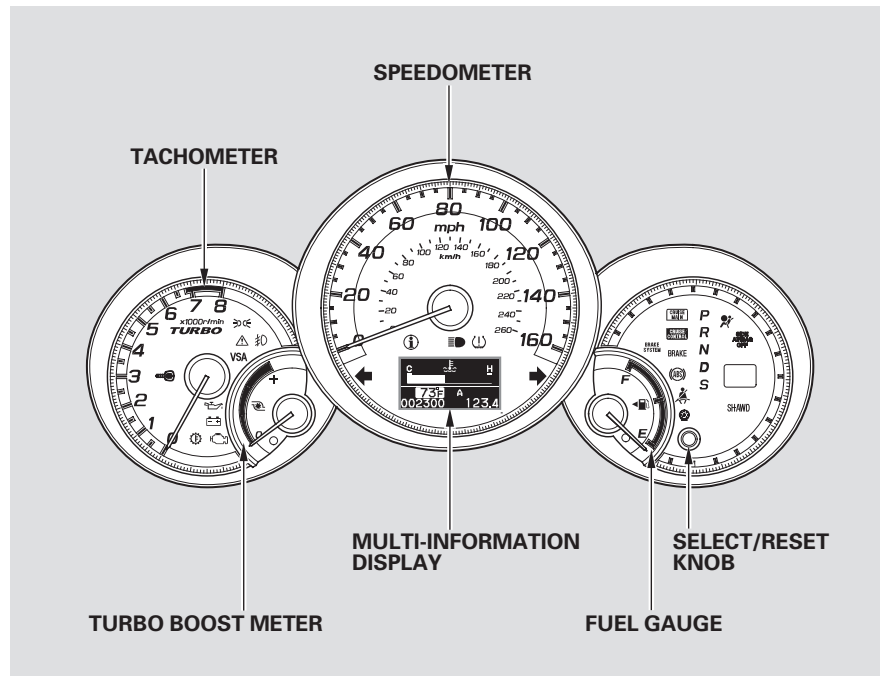

CONTINUED

## Multi-Information Display

The multi-information display in the instrument panel displays various information and messages when the ignition switch is in the ON (II) position. Some of the messages help you operate your vehicle more comfortably.

Others help to keep you aware of the periodic maintenance your vehicle needs for continued trouble-free driving.

When you open the driver's door, a "Welcome" message is shown on the multi-information display. When you turn the ignition switch from the ON (II) position to the ACCESSORY (I) position, a "Goodbye" message is shown on the display.

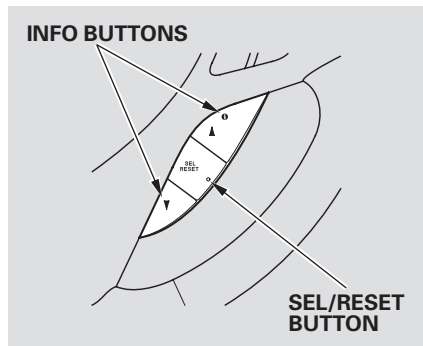

To change the display, press the SEL/RESET button or INFO (▲/▼) button on the steering wheel repeatedly until the desired information appears (see page 73 ).

You can also change the display by pressing the Select/Reset knob in the instrument panel.

When you turn the ignition switch to the ON (II) position, what you last selected is displayed.

In the multi-information display, the system message is also displayed (see page 77 ) and you can customize your vehicle control settings (see page 80 ).

U.S. model is shown.

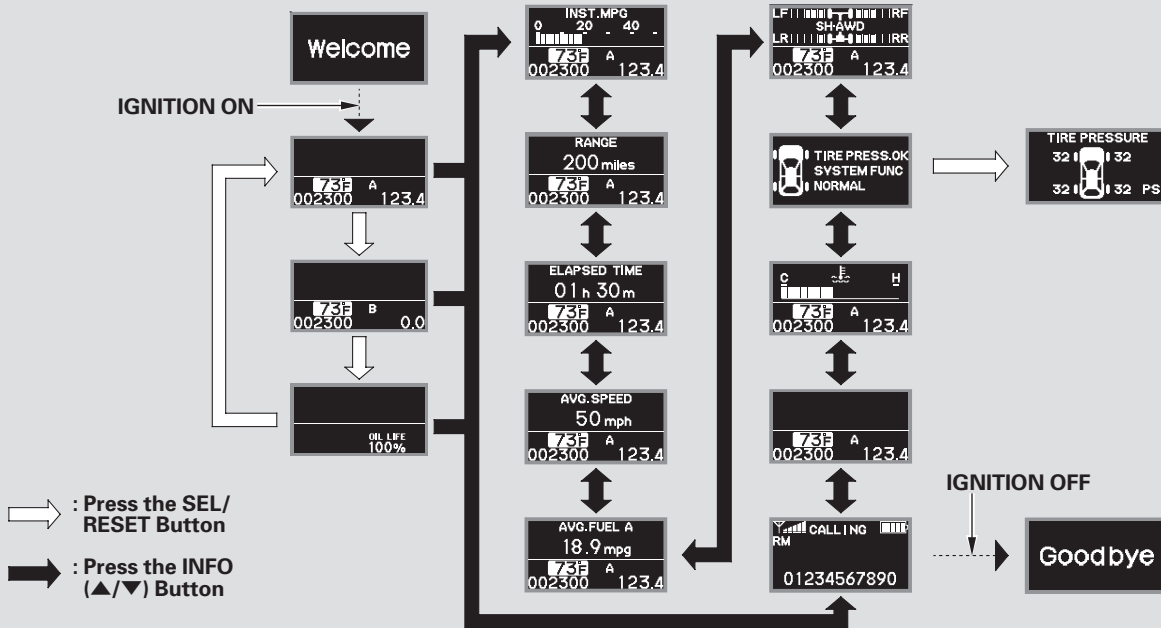

## Multi-Information Display

---

### Odometer

The odometer shows the total distance your vehicle has been driven. It measures miles in U.S. models and kilometers in Canadian models. It is illegal under U.S. federal law and Canadian provincial regulations to disconnect, reset, or alter the odometer with the intent to change the number of miles or kilometers indicated.

### Trip Meter

This meter shows the number of miles (U.S.) or kilometers (Canada) driven since you last reset it. There are two trip meters: Trip A and Trip B. Each trip meter works independently, so you can keep track of two different distances.

To reset a trip meter, display it, then press and hold the SEL/RESET button until the number resets to "0.0".

When you reset Trip A, AVG. FUEL A is reset at the same time. When you reset Trip B, AVG. FUEL B is reset.

You can customize the Trip A and AVG. FUEL A reset condition in the multi-information display (see page [91](#) ).

### Outside Temperature Display

This shows the outside temperature in Fahrenheit (U.S. models), or in Centigrade (Canadian models).

The temperature sensor is in the front bumper. The temperature reading can be affected by heat reflection from the road surface, engine heat, and the exhaust from surrounding traffic. This can cause an incorrect temperature reading when your vehicle speed is under 19 mph (30 km/h). When you start your trip, the sensor is not fully acclimatized, therefore it may take several minutes until the proper temperature is displayed.

In certain weather conditions, temperature readings near freezing (32°F, 0°C) could mean that ice is forming on the road surface.

You can adjust the outside temperature display (see page [89](#) ).

### Maintenance Minder

The multi-information display in the instrument panel shows you the engine oil life and maintenance service items when the ignition switch is in the ON (II) position. This information helps to keep you aware of the periodic maintenance your vehicle needs for continued trouble-free driving. Refer to page [327](#) for more information.

### INST. MPG (U.S. models)/INST. L/100km (Canadian models)

This shows your current fuel mileage.

When you turn off the engine, INST. MPG or INST. L/100 km is also reset.

### RANGE

This shows the estimated distance you can travel on the fuel remaining in the fuel tank. This distance is estimated from the fuel economy you received over the last several miles (U.S.) or kilometers (Canada), so it will vary with changes in speed, traffic, etc.

When the battery is disconnected, or you refuel, RANGE is also reset.

### ELAPSED TIME

This shows the time passed traveled since you last reset it. When you turn the ignition switch to the ON (II) position, ELAPSED TIME is reset.

You can customize the ELAPSED TIME reset condition on the multi-information display (see page [93](#) ).

### AVG. SPEED

This shows the average speed you are traveling in miles per hour (mph) for U.S. models or kilometers per hour (km/h) for Canadian models.

When you reset Trip A, AVG. SPEED is also reset.

### AVG. FUEL A/B

This shows your vehicle's average fuel economy in mpg (U.S. models) or liter/100 km (Canadian models) since you last reset the Trip A or Trip B.

You can customize the Trip A and AVG. FUEL A reset condition on the multi-information display (see page [91](#) ).

The average fuel mileage will be reset when you reset the trip meter, or if the vehicle's battery goes dead or is disconnected.

## Multi-Information Display

---

### SH-AWD Torque Distribution Monitor

This monitor shows how much torque is being delivered to each wheel. For more information, see page [301](#).

### Tire Pressure Monitor

You can see the pressure of each tire in this monitor. If one or more tire pressure are low, inflate them to the correct pressure. For more information, see page [308](#).

### Temperature Gauge

This shows the temperature of the engine's coolant. During normal operation, the reading should rise from the "C (Cold)" mark to about the middle of the gauge. In severe driving conditions, such as very hot weather or a long period of uphill driving, the reading may rise to near the "H (Hot)" mark of the gauge. If it reaches the "H" mark, pull safely to the side of the road. See page [379](#) for instructions and precautions on checking the engine's coolant system.

### Bluetooth® HandsFreeLink®

You can receive or make phone calls from your cell phone through your vehicle's Bluetooth® HandsFreeLink® (HFL) system without touching your cell phone.















To use the system, your cell phone and the HFL system must be linked. Not all cell phones are compatible with this system. Refer to page [257](#) for instructions on how to link your cell phone to the HFL and how to receive or make phone calls, or visit the [handsfreelink.com](http://handsfreelink.com) website.



## System Messages





If there is a problem with your vehicle, for example, the engine oil level is low or a door is not fully closed, the multi-information display will show you the problem. It does this by interrupting the current display with one or more messages.







Here is a list of messages shown on the multi-information display:





 FASTEN SEATBELT	 FASTEN PASSENGER SEATBELT	See page 19	 CHECK TPMS SYSTEM	See page 310
 DOOR OPEN		See page 11	 CHECK TIRE PRESSURE	See page 309
 RELEASE PARKING BRAKE	 RELEASE PARKING BRAKE	See page 65	 OIL PRESSURE LOW	See page 381
<b>U.S. Canada</b>				
 BRAKE FLUID LOW	 BRAKE FLUID LOW	See page 383	 CHECK CHARGING SYSTEM	See page 381
<b>U.S. Canada</b>				
 CHECK BRAKE SYSTEM	 CHECK BRAKE SYSTEM	See pages 383, 384	 CHECK EMISSION SYSTEM	See page 382
<b>U.S. Canada</b>				

CONTINUED

## Multi-Information Display

	See page <a href="#">293</a>
	See page <a href="#">302</a>
	See page <a href="#">302</a>
	See page <a href="#">31</a>
	See page <a href="#">305</a>

	See page <a href="#">312</a>
  <b>U.S.</b> <b>Canada</b>	See page <a href="#">31</a>
	See page <a href="#">116</a>
	See page <a href="#">66</a>
	See page <a href="#">11</a>

	See page <a href="#">274</a>
	See page <a href="#">342</a>
	See page <a href="#">327</a>
	See page <a href="#">122</a>

The system message(s) triggers the appropriate indicator(s) on the instrument panel, including the system message indicator, to come on. The system message indicator does not go off until the problem(s) is corrected.

You will also hear a beep when the system message comes on for the first time.

Most of the messages are displayed for about 5 seconds, and then the normal display returns. If there are several system messages to be shown, the display switches these messages every 5 seconds.

To cancel the message(s) before 5 seconds elapsed, press the INFO (▲/▼) button on the steering wheel.

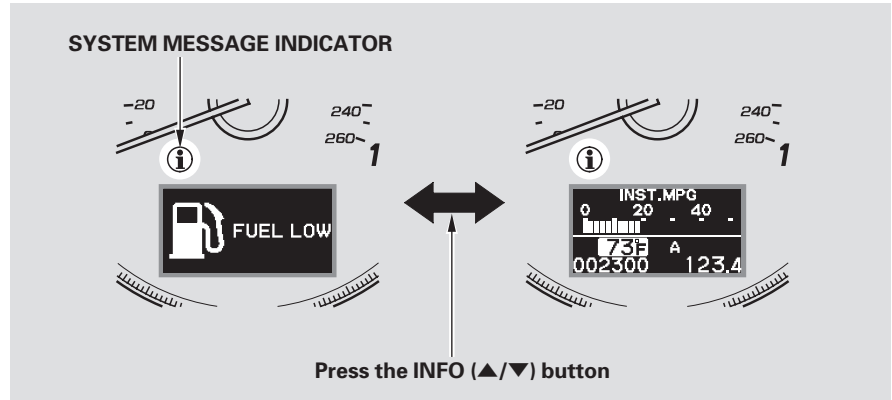

Even if you press the INFO (▲/▼) button, some messages stay on or come on again at regular intervals until the problem is corrected.

- FASTEN SEAT BELT
- FASTEN PASSENGER SEAT BELT
- RELEASE PARKING BRAKE
- Door and Tailgate Open

You can see the message(s) again by pressing the INFO (▲/▼) button repeatedly if the system message indicator remains lit on the instrument panel.

## Multi-Information Display

---

### Customized Settings

With the multi-information display and the INFO (▲/▼) and SEL/RESET buttons on the right side of the steering wheel, you can customize some vehicle control settings.

To enter the customizing mode, press and hold the INFO (▲/▼) button for more than 3 seconds.

To change the settings, the ignition switch must be in the ON (II) position, and the vehicle must be stopped with the transmission in Park.

You cannot customize the settings under these conditions:

- If you turn the ignition switch to the ACCESSORY (I) or the LOCK (0) position.
- If you move the shift lever out of Park.

The first customizing menu is:

- DEFAULT ALL
- CHG SETTING

If you want the settings as they were when the vehicle left the factory, select DEFAULT ALL, as described on page 83 .

If you want to change any vehicle control settings, select CHG SETTING, then press the SEL/RESET button (see page 84).

Refer to the table on the following pages about the settings you want to customize.

# Multi-Information Display

Customize Entry	Customize Group	Customize Menu	Description	Customize Setup	Page
CHG SETTING (P.84)	METER SETUP (P.86)	LANGUAGE SELECTION	Changes the language used in the display.	ENGLISH*	87
				FRENCH	
				SPANISH	
		ADJUST OUTSIDE TEMP. DISPLAY	Changes the outside temperature reading above or below its current reading.	-5°F ~ ±0°F* ~ 5°F -3°C ~ ±0°C* ~ 3°C	89
		TRIP A & AVG. FUEL RESET with REFUEL	Causes trip meter A and the average fuel economy to reset when you refuel.	ON OFF*	91
		ELAP. TIME RESET CONDITION	Resets the elapsed time of your current trip.	IGN RESET* TRIP A RESET TRIP B RESET	93
	LIGHTING SETUP (P.95)	INTERIOR LIGHT DIMMING TIME	Changes how long (in seconds) the interior lights stay on after you close the doors.	15 sec	96
				30 sec*	
				60 sec	
		HEADLIGHT AUTO OFF TIMER	Changes how long (in seconds) the exterior lights stay on after you close the driver's door.	0 sec	98
				15 sec*	
				30 sec	
	60 sec				
	DOOR SETUP (P.100)	AUTO DOOR LOCK	Changes when the system automatically locks the doors.	SHIFT FROM P	101
WITH VEH SPEED*					
OFF					

\* : Default setting

CONTINUED

## Multi-Information Display

Customize Entry	Customize Group	Customize Menu	Description	Customize Setup	Page
CHG SETTING (P.84)	DOOR SETUP (P.100)	DOOR LOCK MODE	Changes which doors unlock with the remote transmitter in a first push.	DRIVER DOOR*	103
				ALL DOORS	
		KEYLESS LOCK ACKNOWLEDGEMENT	The exterior lights flash each time you press the LOCK or UNLOCK button. A beeper will also sound when you press the LOCK button twice.	ON*	105
				OFF	
		SECURITY RELOCK TIMER	Changes how long it takes (in seconds) for the doors to relock and the security system to set after you unlock but do not open the door.	30 sec*	107
				60 sec	
				90 sec	
		AUTO DOOR UNLOCK	Changes when the system automatically unlock the driver's/all of the doors.	DRIVER'S DOOR WITH SHIFT TO P*	109
				ALL DOORS WITH SHIFT TO P	
				DRIVER'S DOOR WITH IGN OFF	
	ALL DOORS WITH IGN OFF				
	OFF				
DEFAULT ALL		Returns all settings to the factory default.	SET	83	
			EXIT		

\* : Default setting

## DEFAULT ALL

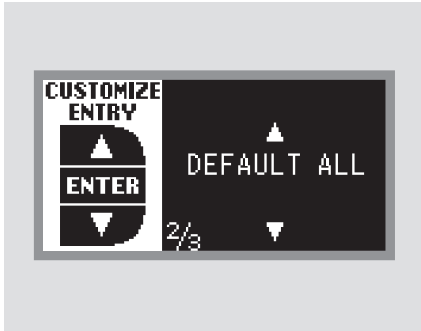

To enter the customizing mode, press and hold the INFO (▲/▼) button for more than 3 seconds.

If you want to set the default settings, press the INFO (▲/▼) button to select DEFAULT ALL, then press the SEL/RESET button.

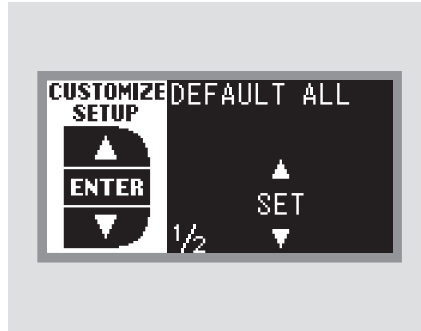

To set the default settings, press the INFO (▲/▼) button to select SET then press the SEL/RESET button.



When DEFAULT ALL is set, you will see the above display for several seconds, then the screen returns to CUSTOMIZE ENTRY.

CONTINUED

## Multi-Information Display



If DEFAULT ALL is not set, you will see the above display for several seconds, then the screen goes back to CUSTOMIZE ENTRY. Repeat the procedure to select DEFAULT ALL.

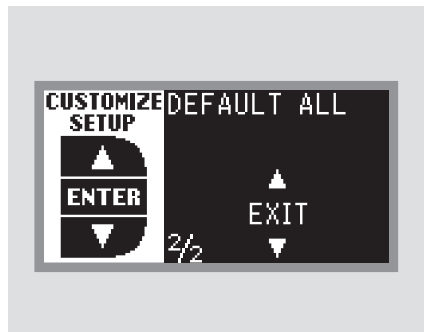

If you want to cancel DEFAULT ALL, select EXIT, then press the SEL/RESET button. The screen goes back to CUSTOMIZE ENTRY.

### Change Settings

You can customize some of the vehicle control settings to your preference. Here are the settings you can customize:

- METER SETUP
- LIGHTING SETUP
- DOOR SETUP

While CHG SETTING in the CUSTOMIZE ENTRY is shown in the multi-information display, press the SEL/RESET button. The screen changes to METER SETUP in the CUSTOMIZE GROUP.

Each time you press the INFO (▲/▼) button, the screen changes as shown on the next page. Press the INFO (▲/▼) button, until you see the setup you want to customize, then press the SEL/RESET button to enter your selection.



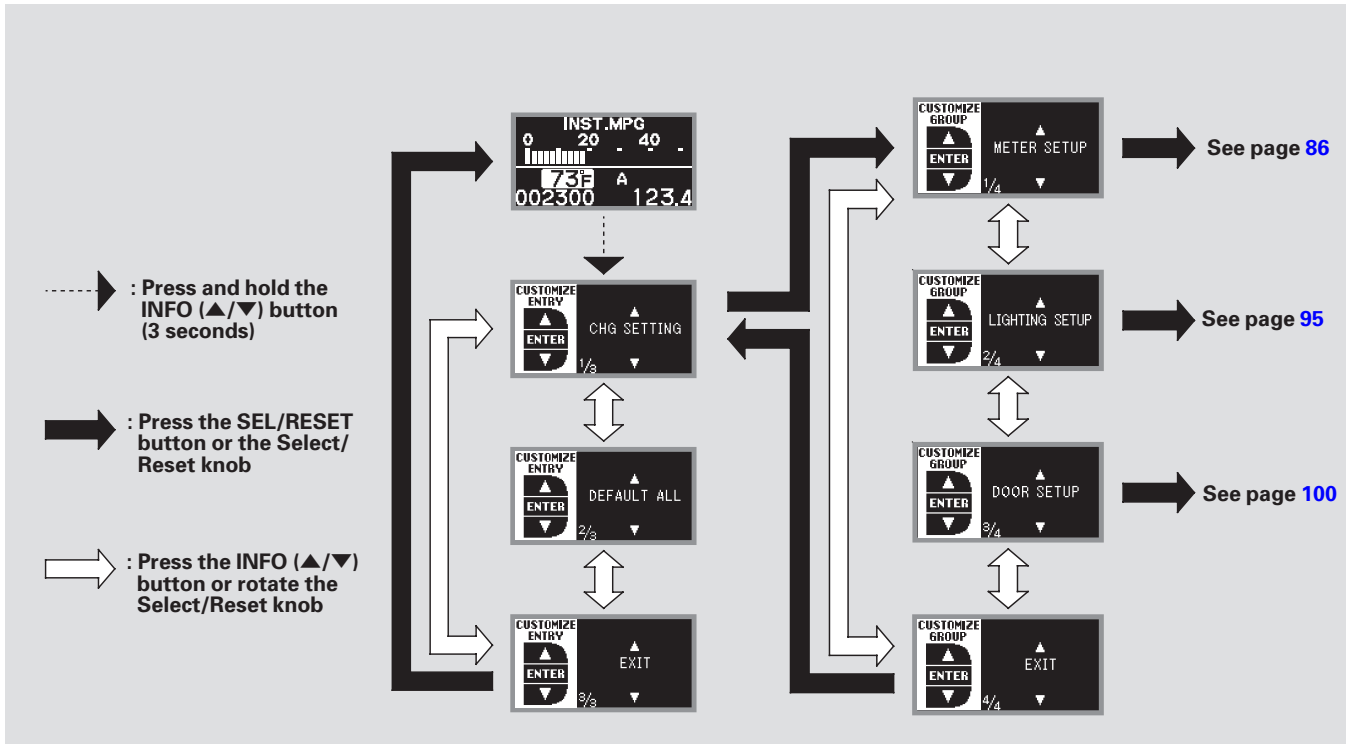

## Multi-Information Display

### Meter Setup

Here are the four custom settings for the meter setup:

- LANGUAGE SELECTION
- ADJUST OUTSIDE TEMP. DISPLAY
- TRIP A & AVG. FUEL RESET with REFUEL
- ELAP. TIME RESET CONDITION

While METER SETUP is shown in the CUSTOMIZE GROUP of the multi-information display, press the SEL/RESET button.

Each time you press the INFO (▲/▼) button, the screen changes as shown in the illustration. Press the INFO (▲/▼) button until you see the setting you want to customize, then press the SEL/RESET button to enter your selection.

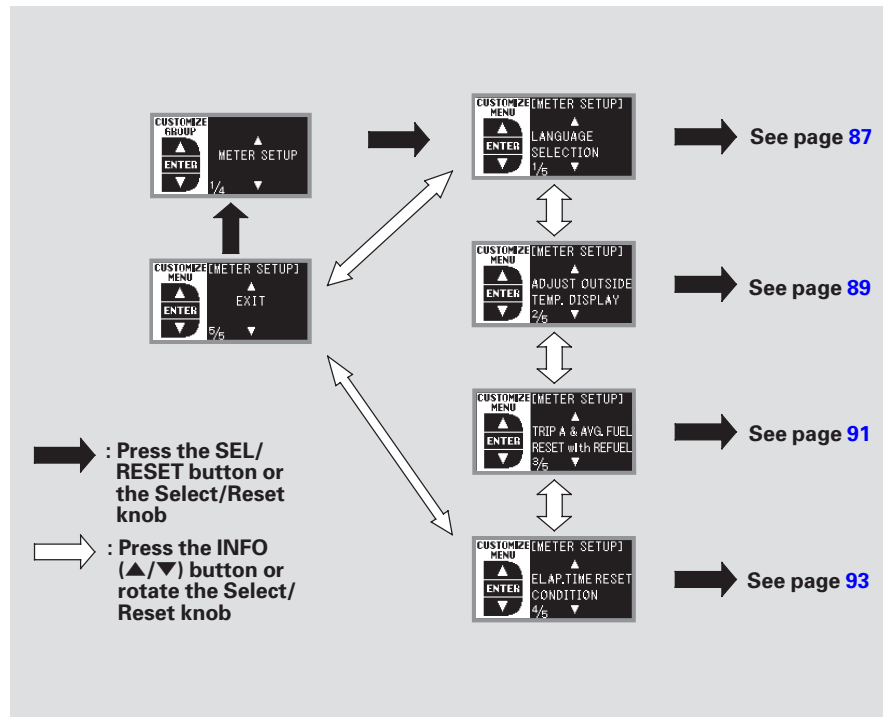

### *Language Selection*

There are three language selections you can make: English, French, and Spanish. To choose the language you want, follow these instructions:

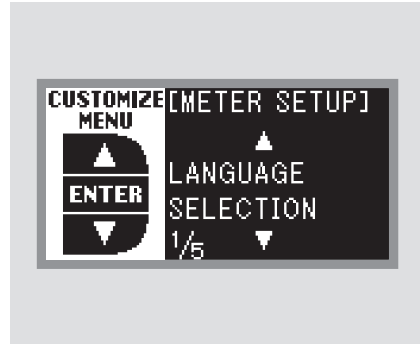

While METER SETUP is shown in the CUSTOMIZE GROUP of the multi-information display, press the SEL/RESET button. You will see the above display.

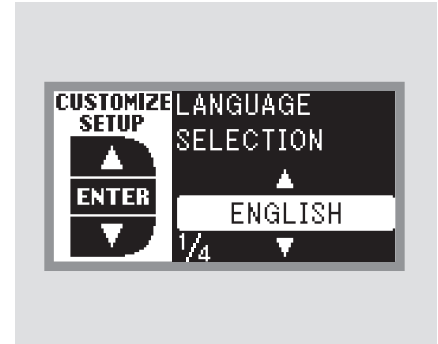

Select the desired language by pressing the INFO (▲/▼) button, then enter your selection by pressing the SEL/RESET button.

CONTINUED

## Multi-Information Display

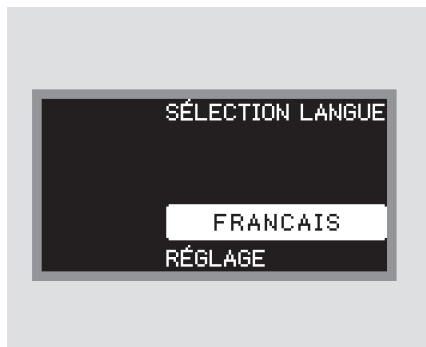

When your choice is set, you will see the above display for several seconds, then the screen goes back to CUSTOMIZE MENU.

All messages on the multi-information display will be shown in the language you selected.

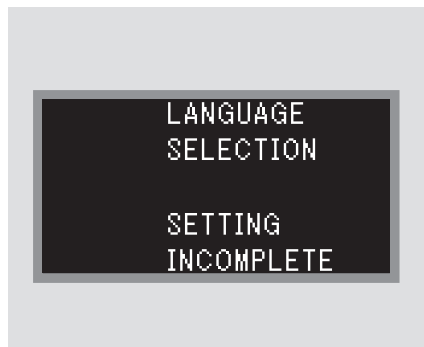

If your choice is not set, you will see the above display for several seconds, then the screen goes back to CUSTOMIZE MENU. If this happens, you need to repeat the same procedure.

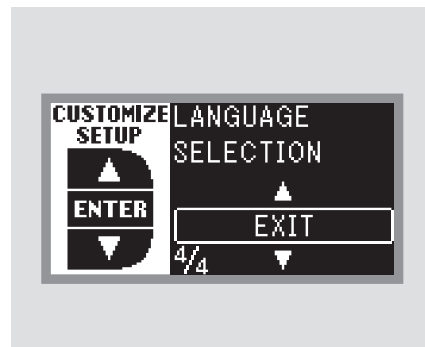

To exit LANGUAGE SELECTION without changing the current setting, select EXIT by pressing the INFO (▲/▼) button, then press the SEL/RESET button. The screen goes back to CUSTOMIZE MENU.

### *Adjust Outside Temp. Display*

If you sometimes find that the temperature reading is a few degrees above or below the actual temperature, you can adjust it by following these instructions:

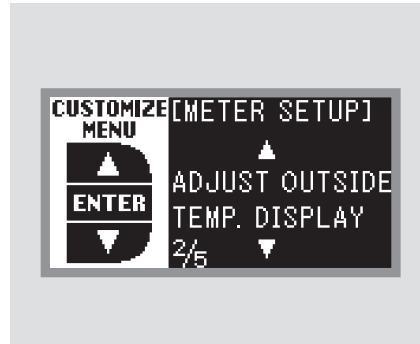

While METER SETUP is shown in the CUSTOMIZE GROUP of the multi-information display, press the SEL/RESET button. The screen changes to CUSTOMIZE MENU. Press the INFO (▲/▼) button until you see the above display.

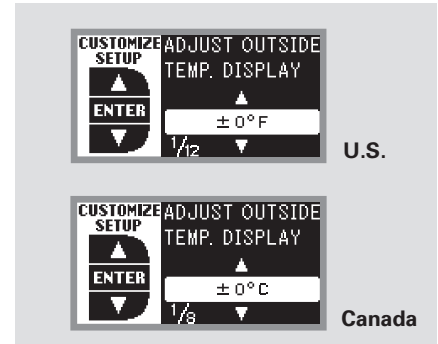

Press the SEL/RESET button. The screen changes as shown above. The highlighted number is the current setting above or below the outside temperature. Press the INFO (▲/▼) button repeatedly until the number you want appears, then press the SEL/RESET button to enter your selection.

CONTINUED

## Multi-Information Display

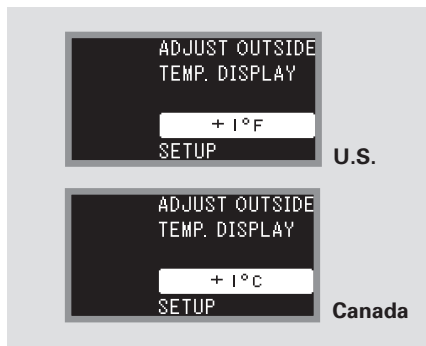

When your choice is set, you will see the above display for several seconds, then the screen goes back to CUSTOMIZE MENU.

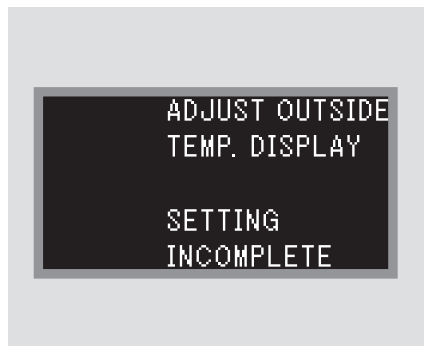

If your choice is not set, you will see the above display for several seconds, then the screen goes back to CUSTOMIZE MENU. If this happens, you need to repeat the same procedure.

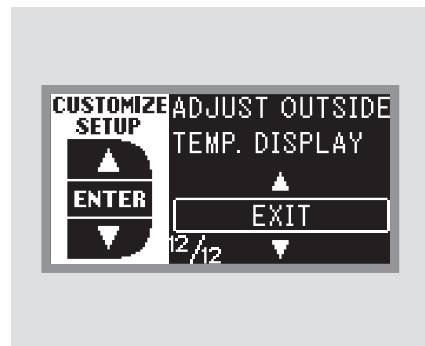

To exit ADJUST OUTSIDE TEMP. DISPLAY without changing the current setting, select EXIT by pressing the INFO (▲/▼) button, then press the SEL/RESET button. The screen goes back to CUSTOMIZE MENU.

***Trip A & Avg. Fuel Reset with Refuel***  
To cause Trip A and AVG. FUEL A to reset every time you refuel your vehicle, follow these instructions:

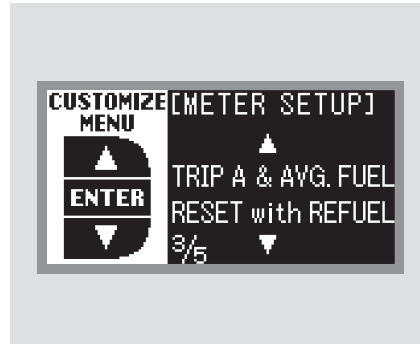

While METER SETUP is shown in the CUSTOMIZE GROUP of the multi-information display, press the SEL/RESET button. The screen changes to CUSTOMIZE MENU. Press the INFO (▲/▼) button until you see the above display.

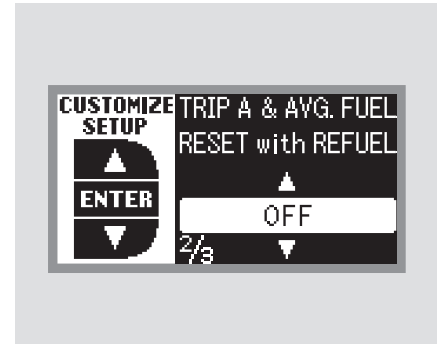

Press the SEL/RESET button. The screen changes as shown above. Select ON or OFF by pressing the INFO (▲/▼) button, then press the SEL/RESET button to enter your selection.

CONTINUED

## Multi-Information Display

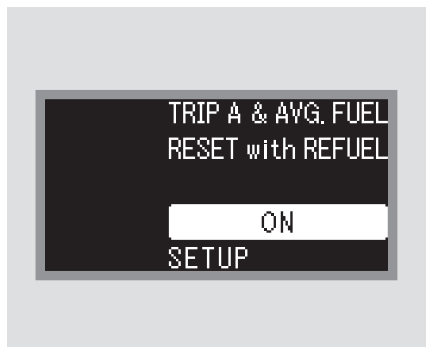

When your choice is set, you will see the above display for several seconds, then the screen goes back to CUSTOMIZE MENU.

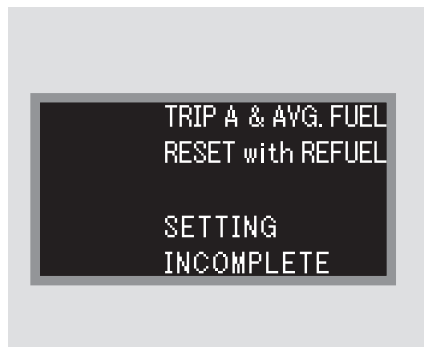

If your choice is not set, you will see the above display for several seconds, then the screen goes back to CUSTOMIZE MENU. If this happens, you need to repeat the same procedure.

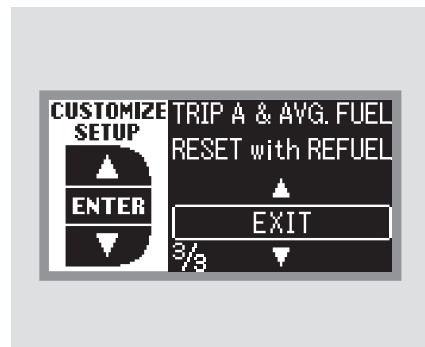

To exit TRIP A & AVG. FUEL RESET with REFUEL without changing the current setting, select EXIT by pressing the INFO (▲/▼) button, then press the SEL/RESET button. The screen goes back to CUSTOMIZE MENU.



### ***Elap. Time Reset Condition***

There are three elapsed time reset choices you can make:

**IGN RESET** – The elapsed time is reset when you turn the ignition switch to the LOCK (0) position.

**TRIP A** – The elapsed time is reset when the Trip A is reset.

**TRIP B** – The elapsed time is reset when the Trip B is reset.

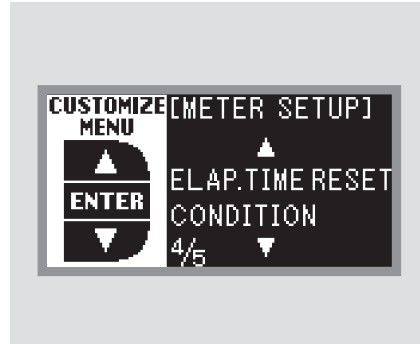

While METER SETUP is shown in the CUSTOMIZE GROUP of the multi-information display, press the SEL/RESET button. The screen changes to CUSTOMIZE MENU. Press the INFO (▲/▼) button until you see the above display.

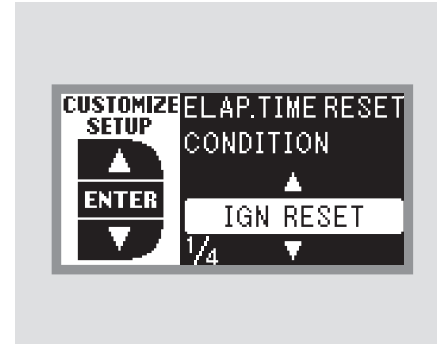

Press the SEL/RESET button. The screen changes as shown above. Select the desired setting by pressing the INFO (▲/▼) button, then press the SEL/RESET button to enter your selection.

*CONTINUED*

## Multi-Information Display



When your choice is set, you will see the above display for several seconds, then the screen goes back to CUSTOMIZE MENU.

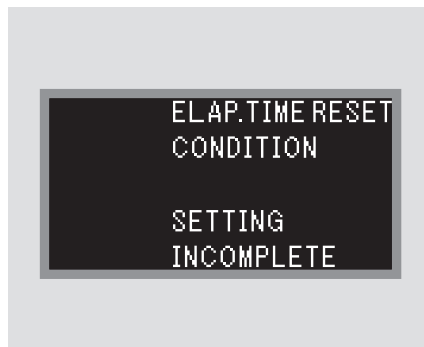

If your choice is not set, you will see the above display for several seconds, then the screen goes back to CUSTOMIZE MENU. If this happens, you need to repeat the same procedure.

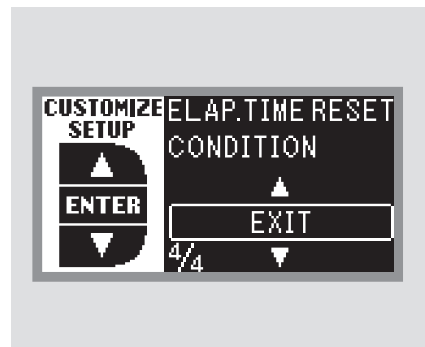

To exit ELAP. TIME RESET CONDITION without changing the current setting, select EXIT by pressing the INFO (▲/▼) button, then press the SEL/RESET button. The display goes back to CUSTOMIZE MENU.

## Lighting Setup

There are two settings in the lighting setup:

- INTERIOR LIGHT DIMMING TIME
- HEADLIGHT AUTO OFF TIMER

While CUSTOMIZE GROUP is shown on the multi-information display, select LIGHTING SETUP by pressing the INFO (▲/▼) button, then press the SEL/RESET button.

Each time you press the INFO (▲/▼) button, the screen changes as shown in the illustration. Press the INFO (▲/▼) button until you see the setting you want to customize, then press the SEL/RESET button to enter your selection.

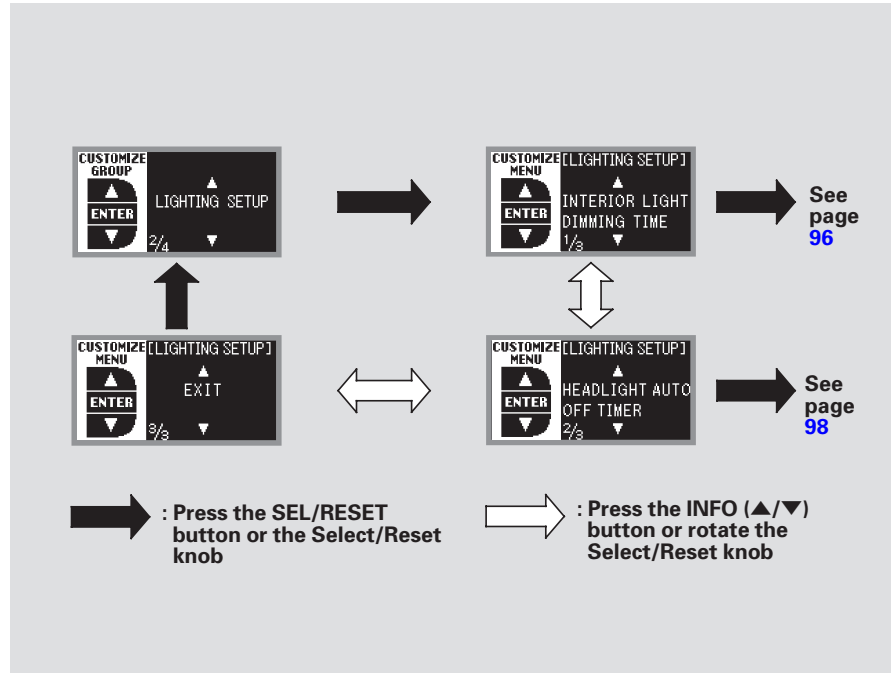

CONTINUED

## Multi-Information Display

### *Interior Light Dimming Time*

The interior lights fade out when you close all doors. You can change the time that the interior lights fade out.

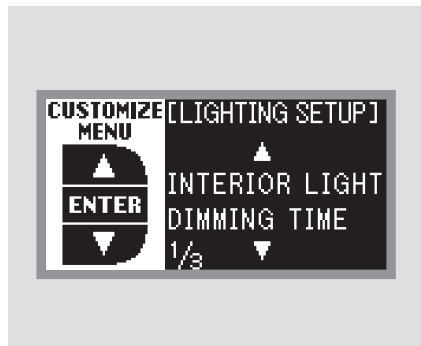

While LIGHTING SETUP is shown in the CUSTOMIZE GROUP of the multi-information display, press the SEL/RESET button. You will see the above display.

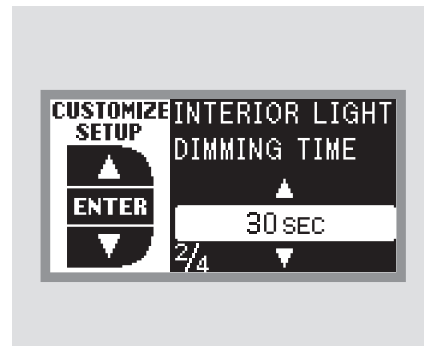

Press the SEL/RESET button. The screen changes as shown above. Select how long you want the lights to stay on before they fade out (15, 30, or 60 seconds) by pressing the INFO ( $\blacktriangle$ / $\blacktriangledown$ ) button, then press the SEL/RESET button to enter your selection.

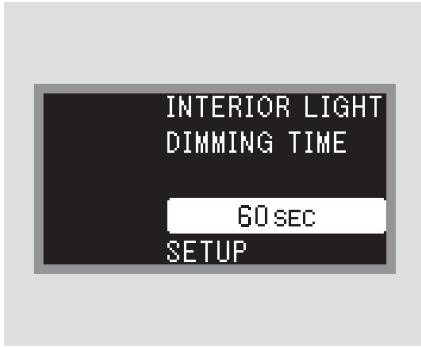

When your choice is set, you will see the above display for several seconds, then the screen goes back to CUSTOMIZE MENU.

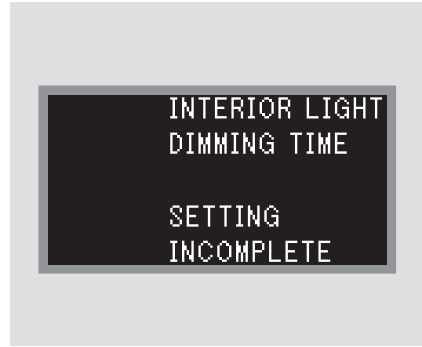

If your choice is not set, you will see the above display for several seconds, then the screen goes back to CUSTOMIZE MENU. If this happens, you need to repeat the same procedure.

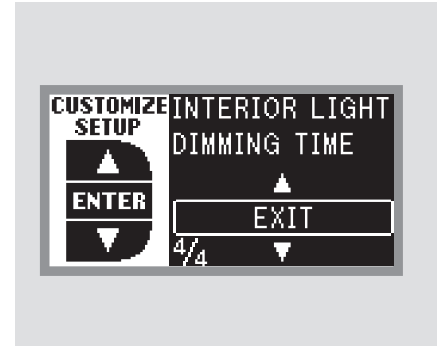

To exit INTERIOR LIGHT DIMMING TIME without changing the current setting, select EXIT by pressing the INFO (▲/▼) button, then press the SEL/RESET button. The screen goes back to CUSTOMIZE MENU.

*CONTINUED*

## Multi-Information Display

### *Headlight Auto Off Timer*

The headlights, parking lights, side marker lights, taillights, and license plate lights go off after the selected time when you close the driver's door and take the remote with you. To change how long the lights stay on before they go off, follow these instructions:

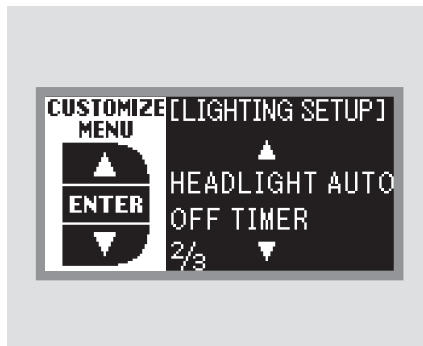

While LIGHTING SETUP is shown in the CUSTOMIZE GROUP of the multi-information display, press the SEL/RESET button. The screen changes to CUSTOMIZE MENU. Press the INFO (▲/▼) button until you see the above display.

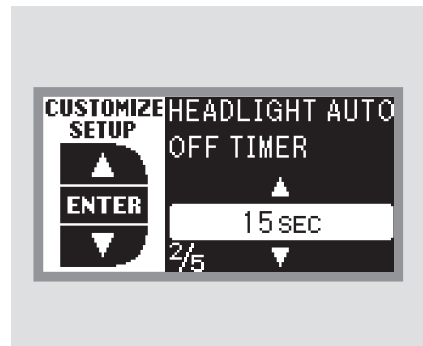

Press the SEL/RESET button. The screen changes as shown above. Select how long you want the lights to stay on before they go off (0, 15, 30, or 60 seconds) by pressing the INFO (▲/▼) button, then press the SEL/RESET button to enter your selection.

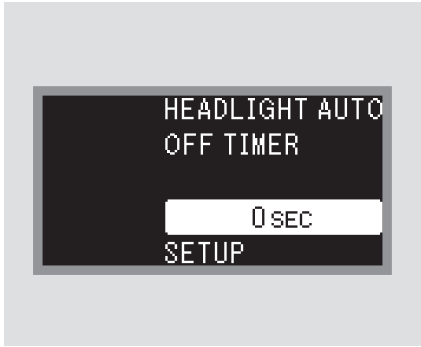

When your choice is set, you will see the above display for several seconds, then the screen goes back to CUSTOMIZE MENU.

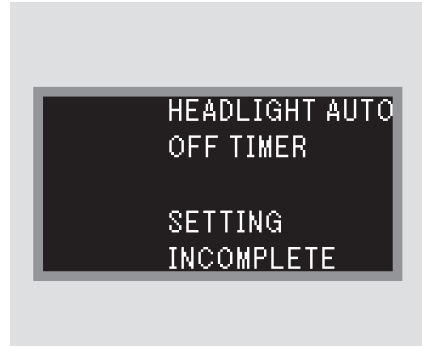

If your choice is not set, you will see the above display for several seconds, then the screen goes back to CUSTOMIZE MENU. If this happens, you need to repeat the same procedure.

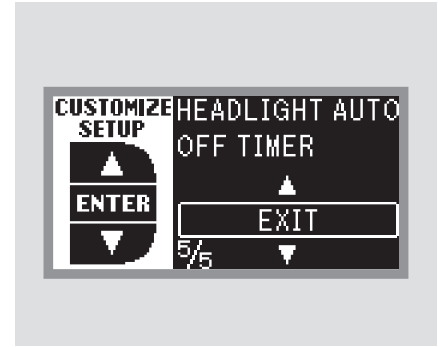

To exit HEADLIGHT AUTO OFF TIMER without changing the current setting, select EXIT by pressing the INFO (▲/▼) button, then press the SEL/RESET button. The screen goes back to CUSTOMIZE MENU.

## Multi-Information Display

### Door Setup

There are five settings to choose from in the door setup:

- AUTO DOOR LOCK
- DOOR LOCK MODE
- KEYLESS LOCK ACKNOWLEDGEMENT
- SECURITY RELOCK TIMER
- AUTO DOOR UNLOCK

While CUSTOMIZE GROUP is shown in the multi-information display, select DOOR SETUP by pressing INFO (▲/▼) button, then press the SEL/RESET button.

Each time you press the INFO (▲/▼) button, the screen changes as shown in the illustration. Press the INFO (▲/▼) button until you see the setting you want to customize, then press the SEL/RESET button to enter your selection.

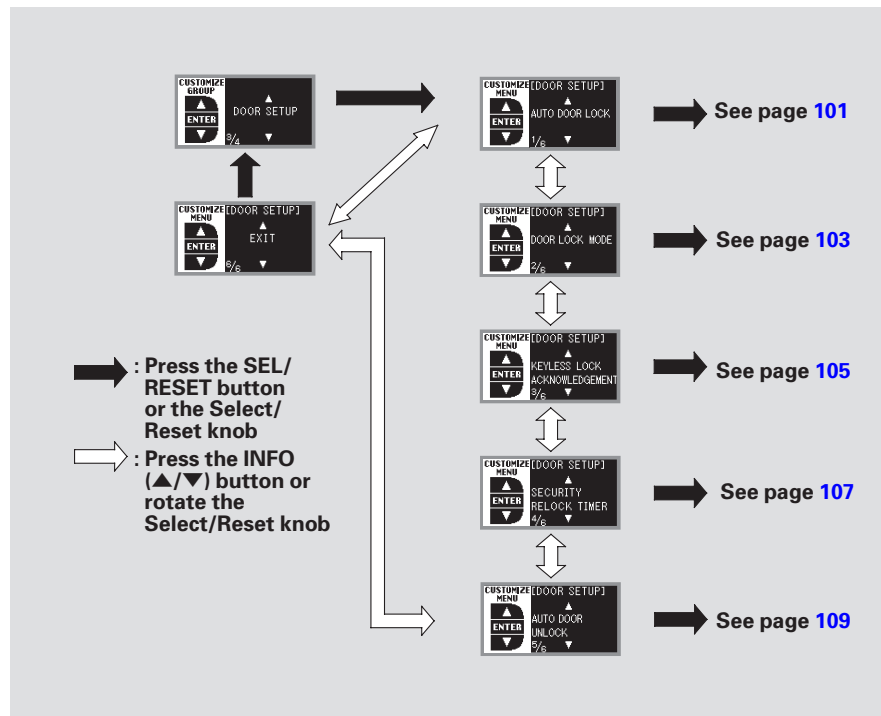



### **Auto Door Lock**

There are three settings you can choose from:

#### **OFF** –

The auto door lock is deactivated all the time.

#### **WITH VEH SPD** –

The doors lock when the vehicle speed reaches about 9 mph (about 15 km/h).

#### **SHIFT FROM P** –

The doors lock whenever you move the shift lever out of Park.

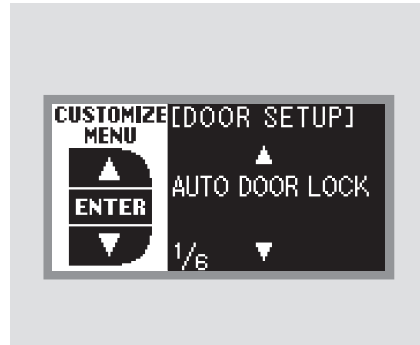

While DOOR SETUP is shown in the CUSTOMIZE GROUP of the multi-information display, press the SEL/RESET button. You will see the above display.



Press the SEL/RESET button. The screen changes as shown above. Select the desired setting by pressing the INFO (▲/▼) button, then press the SEL/RESET button to enter your selection.

CONTINUED

## Multi-Information Display



When your choice is set, you will see the above display for several seconds, then the screen goes back to CUSTOMIZE MENU.

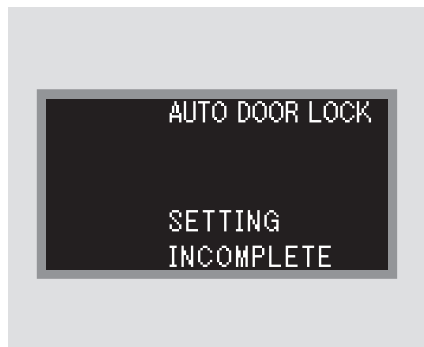

If your choice is not set, you will see the above display for several seconds, then the screen goes back to CUSTOMIZE MENU. If this happens, you need to repeat the same procedure.

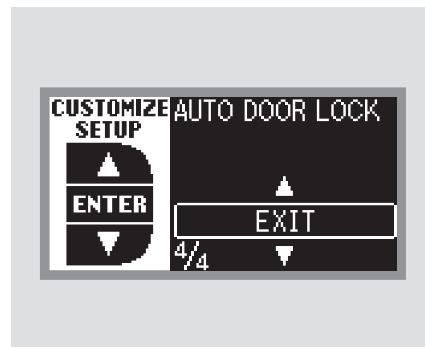

To exit AUTO DOOR LOCK without changing the current setting, select EXIT by pressing the INFO (▲/▼) button, then press the SEL/RESET button. The screen goes back to CUSTOMIZE MENU.

### *Door Lock Mode*

To select whether the driver's door unlocks or all the doors unlock when you unlock the doors with the remote transmitter or the key, follow these instructions.

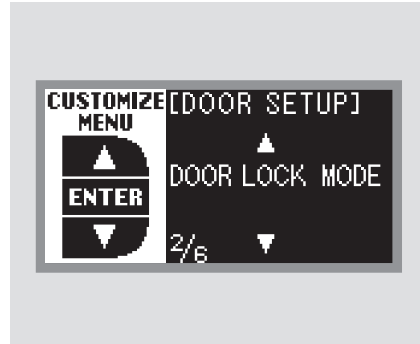

While DOOR SETUP is shown in the CUSTOMIZE GROUP of the multi-information display, press the SEL/RESET button. The screen changes to CUSTOMIZE MENU. Press the INFO (▲/▼) button until you see the above display.

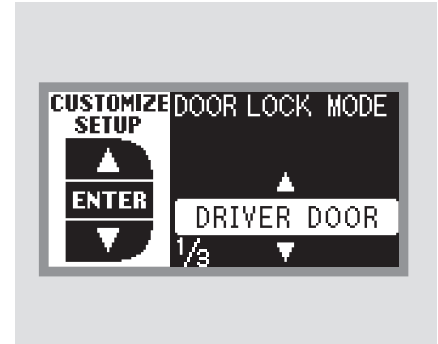

Press the SEL/RESET button. The screen changes as shown above. Select DRIVER DOOR or ALL DOORS by pressing the INFO (▲/▼) button, then press the SEL/RESET button to enter your selection.

*CONTINUED*

## Multi-Information Display



When your choice is set, you will see the above display for several seconds, then the screen goes back to CUSTOMIZE MENU.



If your choice is not set, you will see the above display for several seconds, then the screen goes back to CUSTOMIZE MENU. If this happens, you need to repeat the same procedure.

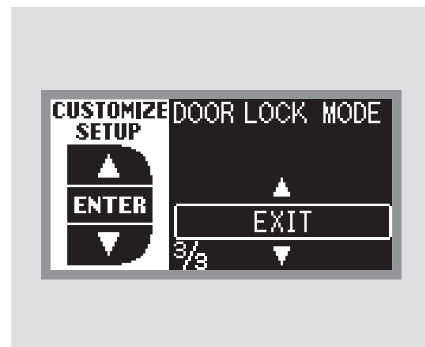

To exit DOOR LOCK MODE without changing the current setting, select EXIT by pressing the INFO (▲/▼) button, and then press the SEL/RESET button. The screen goes back to CUSTOMIZE MENU.

### *Keyless Lock Acknowledgement*

When you press the UNLOCK button on the remote transmitter to unlock the doors and the tailgate, the exterior lights blink twice to verify that the doors and the tailgate are unlocked and the security system is turned off.

When you push the LOCK button on the remote transmitter, some exterior lights flash, and a beeper sounds when you push the LOCK button again within 5 seconds to verify that the doors and the tailgate are locked and the security system has set (see page 127). You can customize the exterior lights not to flash and the beeper not to sound.

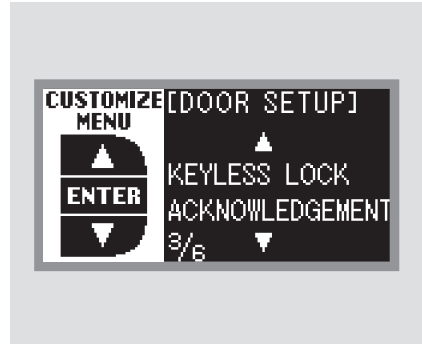

While DOOR SETUP is shown in the CUSTOMIZE GROUP of the multi-information display, press the SEL/RESET button. The screen changes to CUSTOMIZE MENU. Press the INFO (▲/▼) button until you see the above display.

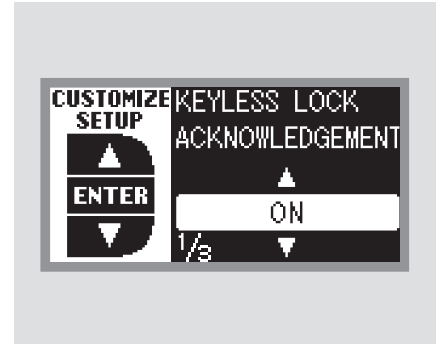

Press the SEL/RESET button. The screen changes as shown above. Select ON or OFF by pressing the INFO (▲/▼) button, then press the SEL/RESET button to enter your selection.

CONTINUED

## Multi-Information Display



When your choice is set, you will see the above display for several seconds, then the screen goes back to CUSTOMIZE MENU.

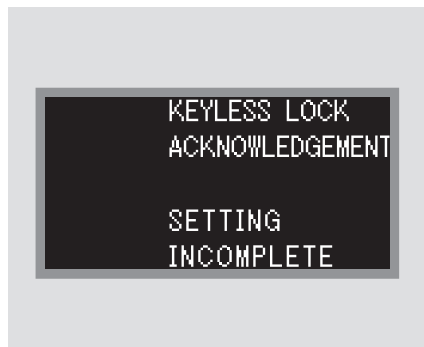

If your choice is not set, you will see the above display for several seconds, then the screen goes back to CUSTOMIZE MENU. If this happens, you need to repeat the same procedure.

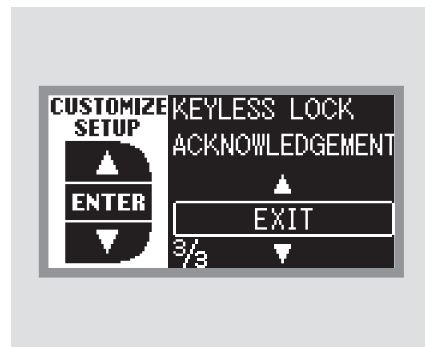

To exit KEYLESS LOCK ACKNOWLEDGEMENT without changing the current setting, select EXIT by pressing the INFO (▲/▼) button, then press the SEL/RESET button. The screen goes back to CUSTOMIZE MENU.

### **Security Relock Timer**

If you unlock the doors and the tailgate with the remote transmitter, but do not open any of the doors or the tailgate within 30 seconds, the doors and the tailgate automatically relock and the security system sets.

You can change this relock time from 30 seconds to 60 or 90 seconds.

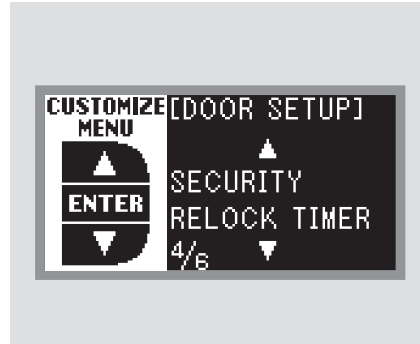

While DOOR SETUP is shown in the CUSTOMIZE GROUP of the multi-information display, press the SEL/RESET button. The screen changes to CUSTOMIZE MENU. Press the INFO (▲/▼) button until you see the above display.

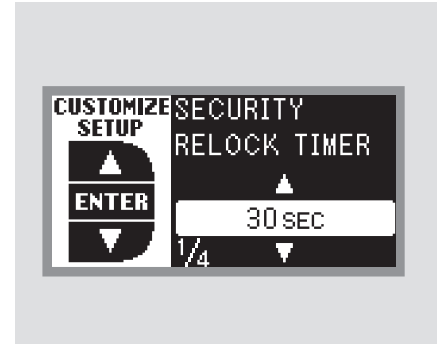

Press the SEL/RESET button. The screen changes as shown above. Select the relock time you want (30, 60, or 90 seconds) by pressing the INFO (▲/▼) button, then press the SEL/RESET button to enter your selection.

*CONTINUED*

## Multi-Information Display



When your choice is set, you will see the above display for several seconds, then the screen goes back to CUSTOMIZE MENU.



If your choice is not set, you will see the above display for several seconds, then the screen goes back to CUSTOMIZE MENU. If this happens, you need to repeat the same procedure.

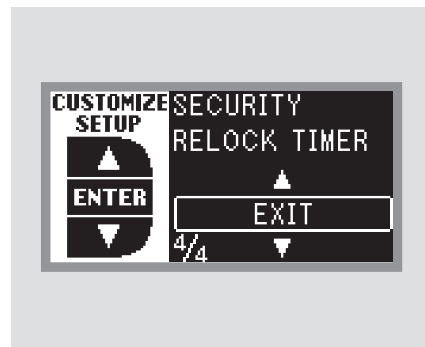

To exit SECURITY RELOCK TIMER without changing the current setting, select EXIT by pressing the INFO (▲/▼) button, then press the SEL/RESET button. The screen goes back to CUSTOMIZE MENU.



### **Auto Door Unlock**

There are three settings you can choose from:

**SHIFT TO P** – The driver's door or all the doors unlock when you move the shift lever to Park.

**IGN OFF** – The driver's door or all the doors unlock when you turn the ignition switch to the LOCK (0) position.

**OFF** – The auto door unlock is deactivated all the time.

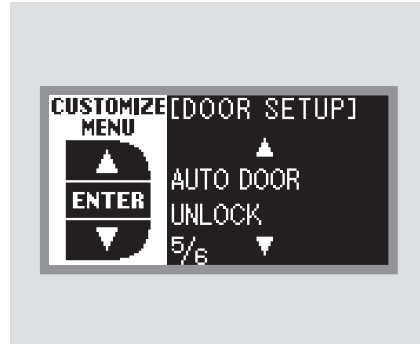

While DOOR SETUP is shown in the CUSTOMIZE GROUP of the multi-information display, press the SEL/RESET button. The screen changes to CUSTOMIZE MENU. Press the INFO (▲/▼) button until you see the above display.



Press the SEL/RESET button. The screen changes as shown above. Select the desired setting by pressing the INFO (▲/▼) button, then press the SEL/RESET button to enter your selection.

*CONTINUED*

## Multi-Information Display



When your choice is set, you will see the above display for several seconds, then the screen goes back to CUSTOMIZE MENU.

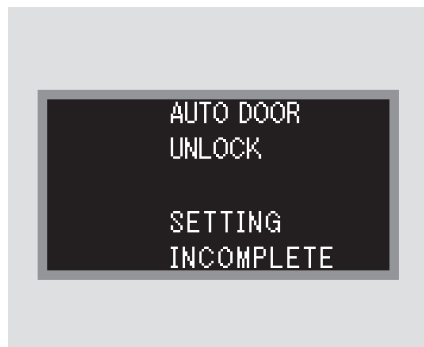

If your choice is not set, you will see the above display for several seconds, then the screen goes back to CUSTOMIZE MENU. If this happens, you need to repeat the same procedure.

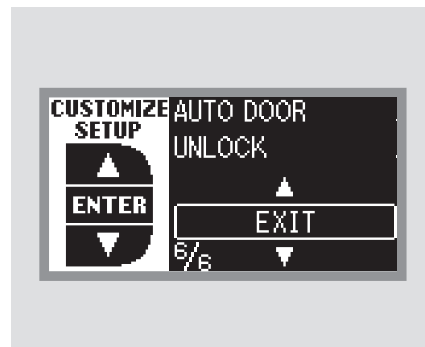

To exit AUTO DOOR UNLOCK without changing the current setting, select EXIT by pressing the INFO (▲/▼) button, then press the SEL/RESET button. The screen goes back to CUSTOMIZE MENU.

## Controls Near the Steering Wheel

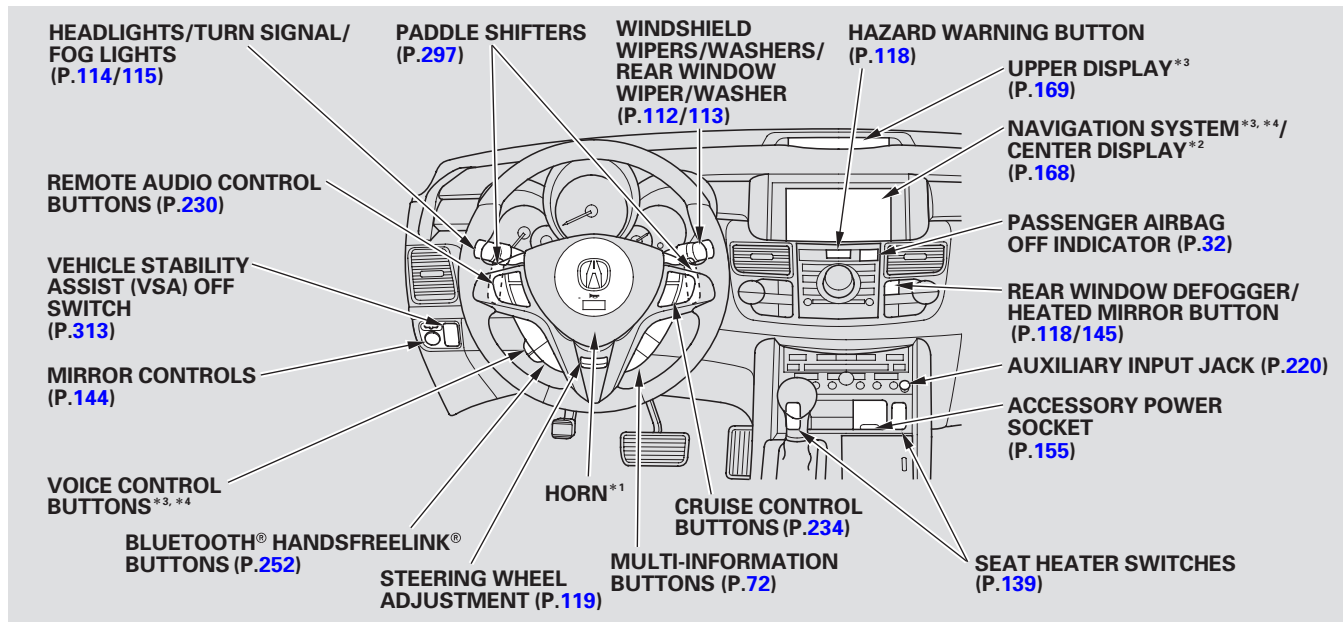

\* 1 : To use the horn, press the center pad of the steering wheel.

\* 2 : On RDX model only

\* 3 : On RDX with Technology Package model only

\* 4 : Refer to the navigation system manual.

## Windshield Wipers and Washers

### Windshield Wiper

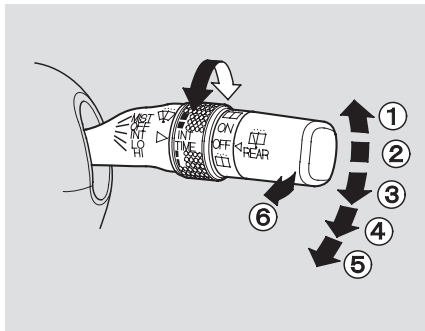

1. MIST
2. OFF
3. INT – Intermittent
4. LO – Low speed
5. HI – High speed
6. Windshield washers

Push the right lever up or down to select a position.

**MIST** – The wipers run at high speed until you release the lever.

**OFF** – The wipers are not activated.

**INT** – The length of the wiper interval is varied automatically according to the vehicle's speed. Vary the delay by turning the INT TIME ring. If you turn it to the shortest delay, the wiper speed will increase to low speed operation when the vehicle speed exceeds 12 mph (20 km/h).

While the vehicle is stopped and in gear, the wipers sweep the windshield whenever you remove your foot from the brake pedal.

**LO** – The wipers run at low speed.

**HI** – The wipers run at high speed.

**Windshield Washers** – Pull the wiper control lever toward you, and hold it. The washers spray until you release the lever. The wipers run at low speed, then complete one more sweep after you release the lever.

## Rear Window Wiper and Washer

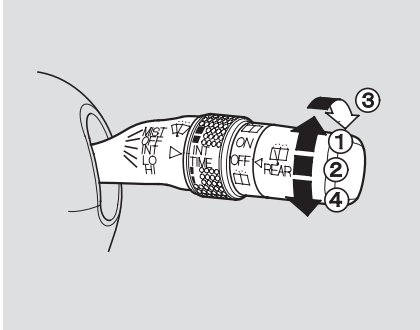

1. ON
2. OFF
3. Rear Window Washer with Wiper
4. Rear Window Washer Only.

**ON** — Rotate the switch clockwise to turn the rear window wiper ON. The wiper operates intermittently.

**OFF** — The wiper is not activated. When you turn the wiper switch to OFF while the rear window wiper is in action, it will return to its parked position.

When you shift the transmission to the reverse position with the front windshield wipers activated, the rear window wiper operates automatically. When the wiper control lever position is INT, the rear wiper operates intermittently. When it is LO or HI, the rear wiper operates continuously.

## Rear Window Washer with Wiper

— Hold past ON to turn the rear window wiper on and to spray the rear window washer. The rear window wiper makes one more sweep after you release the switch.

## Rear Window Washer Only

— Rotate the switch counterclockwise from OFF to spray the window washer without activating the wiper. The washer will operate until you release the switch.

The rear window washer uses the same fluid reservoir as the windshield washer.

## Turn Signals and Headlights

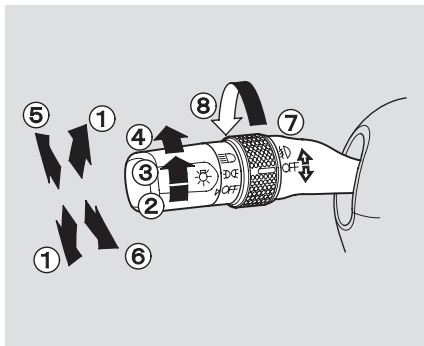



1. Turn signal
2. Off
3. Parking and interior lights
4. Headlights
5. High beams
6. Flash high beams
7. Fog lights off
8. Fog lights on

**Turn Signal** — Push down on the lever to signal a left turn and up to signal a right turn. To signal a lane change, push lightly on the lever, and hold it. The lever will return to center when you release it or complete a turn.

**Headlights** — Turning the switch to the “” position turns on the parking lights, taillights, instrument panel lights, side-marker lights, and rear license plate lights.

Turning the switch to the “” position turns on the headlights.

When the light switch is in the “” or “” position, the lights on indicator comes on as a reminder. This indicator stays on if you leave the light switch on and turn the ignition switch to the ACCESSORY (I) or the LOCK (0) position.

If you leave the lights on with the key removed from the ignition switch, you will hear a reminder beeper when you open the driver's door.

**High Beams** — Push the lever forward and the high beam indicator will come on (see page 67). Pull it back to return to low beams.

To flash the high beams, pull the lever back lightly, then release it. The high beams will stay on as long as you hold the lever back.



## Fog Lights

Turn the fog lights on and off by turning the switch next to the headlight switch.

You can use the fog lights only when the headlights are on low beam. They will go off when the headlights are turned off.

## Automatic Lighting Off Feature

This feature turns off the headlights, parking lights, taillights, side marker lights, license plate lights, and instrument panel lights within 15 seconds of removing the key from the ignition switch and closing the driver's door.

This feature activates if you leave the headlight switch in the  or  position, remove the key, then open and close the driver's door.

If you remove the key from the ignition switch with the headlight switch on, but do not open the door, the lights will turn off after 10 minutes.

*CONTINUED*

## Headlights

---

The lights will turn on again when you unlock or open the driver's door. If you unlock the door, but do not open it within 15 seconds, the lights will go off. With the driver's door open, you will hear a lights on reminder beeper.

You can change the "HEADLIGHT AUTO OFF TIMER" setting on the multi-information display (see page [98](#) ).

### **Daytime Running Lights**

With the headlight switch off or in the  position, the high beam headlights and the high beam indicator come on with reduced brightness when you turn the ignition switch to the ON (II) position and release the parking brake. They remain on until you turn the ignition switch off, even if you set the parking brake.

The headlights revert to normal operation when you turn them on with the switch.



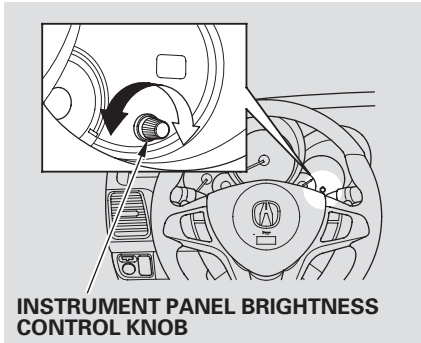



The knob on the instrument panel controls the brightness of the instrument panel lights. Turn the knob to adjust the brightness.

Separate adjustments can be made when the headlights are on and off.

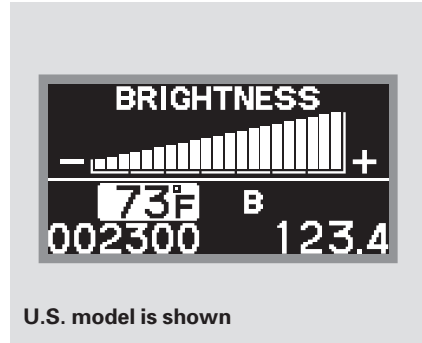
You will hear a beep when maximum or minimum brightness is reached. You will also hear a beep when the maximum level is canceled by turning the knob a click to the left.



To reduce glare at night, the instrument panel illumination dims when you turn the light switch to the  or  position.

The level of brightness is shown on the multi-information display while you adjust it. It goes out 5 seconds after you finish adjusting.

## Rear Window Defogger, Hazard Warning Button

### Rear Window Defogger



The rear window defogger clears fog, frost, and thin ice from the window. Push the defogger button to turn it on and off. Pushing this button also turns the mirror heaters on and off. The indicator in the button comes on to show the defogger is on.

If you do not turn it off, the defogger will automatically shut itself off after a certain period depending on the ambient temperature. It also shuts off when you turn off the ignition switch. You have to turn it on again when you restart the vehicle.

In cold weather, the defogger will not automatically shut itself off. You must manually shut off the rear window defogger when it is no longer needed.

Make sure the rear window is clear and you have good visibility before starting to drive.

The defogger wires on the inside of the rear window can be accidentally damaged. When cleaning the glass, always wipe side-to-side.

### Hazard Warning Button

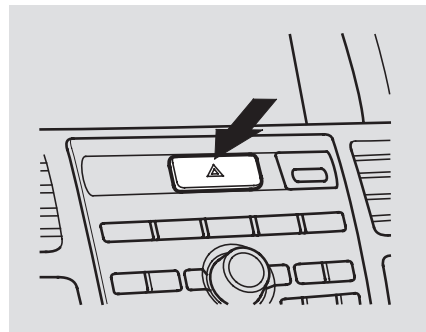

Push the button between the center vents to turn on the hazard warning lights (four-way flashers). This causes all outside turn signals and both indicators in the instrument panel to flash. Use the hazard warning lights if you need to park in a dangerous area near heavy traffic, or if your vehicle is disabled.

# Steering Wheel Adjustment, Keys and Locks

## Steering Wheel Adjustment

Make any steering wheel adjustment before you start driving.

### **⚠ WARNING**

Adjusting the steering wheel position while driving may cause you to lose control of the vehicle and be seriously injured in a crash.

Adjust the steering wheel only when the vehicle is stopped.

1. Push the lever under the steering column all the way down.
2. Move the steering wheel up or down, and in or out, so it points toward your chest, not toward your face. Make sure you can see the instrument panel gauges and indicators.

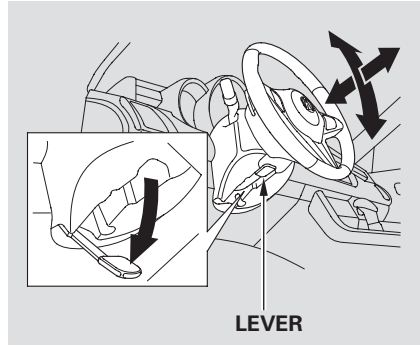

3. Push the lever up to lock the steering wheel in position.
4. Make sure you have securely locked the steering wheel in place by trying to move it up, down, in, and out.

## Keys

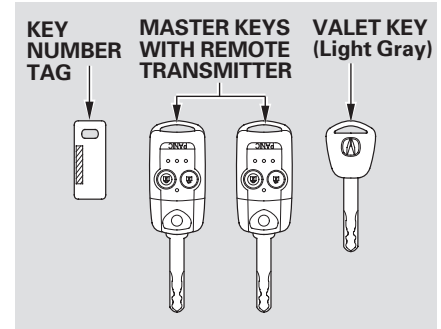

The master key fits all the locks on your vehicle. The valet key works only in the ignition and the door locks. You can keep the glove box and console compartment locked when you leave your vehicle and the valet key at a parking facility.

*CONTINUED*

## Keys and Locks

You should have received a key number tag with your keys. You will need this key number if you ever have to get a lost key replaced. Use only Acura-approved key blanks.

These keys contain electronic circuits that are activated by the immobilizer system. They will not work to start the engine if the circuits are damaged.

- Protect the keys from direct sunlight, high temperature, and high humidity.
- Do not drop the keys or set heavy objects on them.
- Keep the keys away from liquids. If they get wet, dry them immediately with a soft cloth.

The valet key does not contain a battery. Do not try to take it apart.

### *Retractable Master Key*

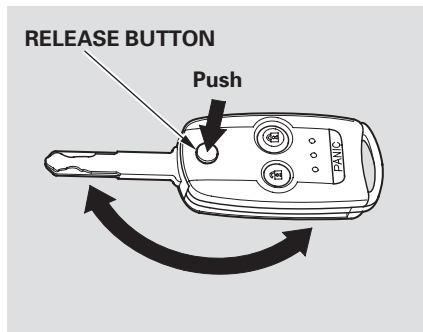

The master key can be retracted into the remote transmitter. To use the key, push the release button to release the key from the transmitter. The key should be fully extended. To retract the key, push the release button and at the same time push the key into the remote transmitter until it is securely latched.

Always use the fully-extended key when you insert it to the ignition switch. If the key does not fully extend, the immobilizer system may not operate properly and prevents from starting the engine.

The key may come in contact with your finger while being retracted or extended. Make sure your fingers do not touch the pivot of the key when retracting or extending the key.

The immobilizer system protects your vehicle from theft. If an improperly-coded key (or other device) is used, the engine's fuel system is disabled.

When you turn the ignition switch to the ON (II) position, the immobilizer system indicator should come on briefly, then go off. If the indicator starts to blink, it means the system does not recognize the coding of the key. Turn the ignition switch to the LOCK (0) position, remove the key, reinsert it, and turn the ignition switch to the ON (II) position again.

The system may not recognize your key's coding if another immobilizer key or other metal object (i.e. key fob) is near the ignition switch when you insert the key.

If the system repeatedly does not recognize the coding of your key, contact your dealer.

Do not attempt to alter this system or add other devices to it. Electrical problems could result that may make your vehicle undrivable.

If you have lost your key and cannot start the engine, contact your dealer.

### NOTICE

*Always take the ignition key with you whenever you leave the vehicle alone.*

*As required by the FCC:*

*This device complies with Part 15 of the FCC rules. Operation is subject to the following two conditions: (1) This device may not cause harmful interference, and (2) this device must accept any interference received, including interference that may cause undesired operation.*

*Changes or modifications not expressly approved by the party responsible for compliance could void the user's authority to operate the equipment.*

*This device complies with Industry Canada Standard RSS-210. Operation is subject to the following two conditions: (1) this device may not cause interference, and (2) this device must accept any interference that may cause undesired operation of the device.*

## Ignition Switch

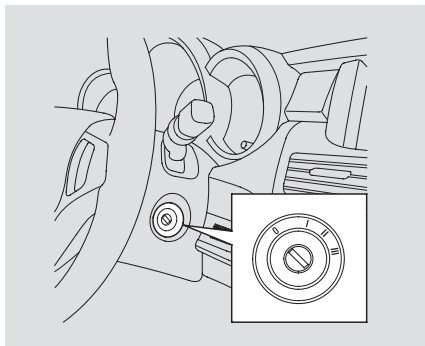

The ignition switch has four positions: **LOCK (0)**, **ACCESSORY (I)**, **ON (II)**, and **START (III)**.

**LOCK (0)** – You can insert or remove the key only in this position. To turn the key, the shift lever must be in Park, and you must push the key in slightly.

If the front wheels are turned, the anti-theft lock may make it difficult to turn the key. Firmly turn the steering wheel to the left or right as you turn the key.

**ACCESSORY (I)** – You can operate the audio system and the accessory power sockets in this position.

**ON (II)** – This is the normal key position when driving. Several of the indicators on the instrument panel come on as a test when you turn the ignition switch from the **ACCESSORY (I)** to the **ON (II)** position.

**START (III)** – Use this position only to start the engine. The switch returns to the **ON (II)** position when you let go of the key.

You will hear a reminder beeper if you leave the key in the ignition switch in the **LOCK (0)** or the **ACCESSORY (I)** position and open the driver's door. Remove the key to turn off the beeper.

You will also see a “REMOVE KEY” message on the multi-information display (see page [78](#) ).

The shift lever must be in Park before you can remove the key from the ignition switch.

## Power Door Locks

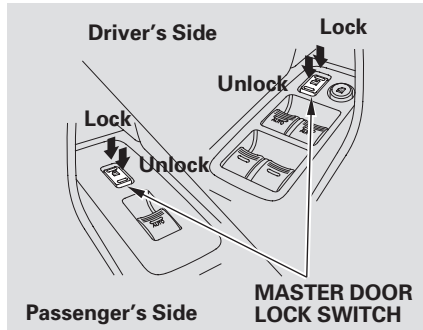

Each front door has a master door lock switch. Either switch locks and unlocks all doors and the tailgate. Push the top of the switch to lock all doors and the tailgate; push the bottom to unlock them.

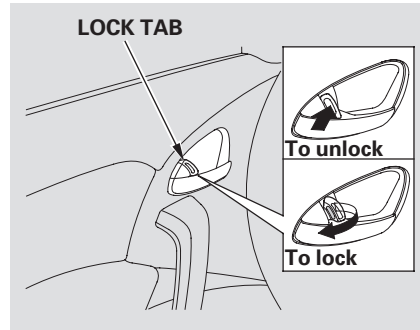

Each door has a lock tab next to the inside door handle. When you pull backward on the lock tab on the driver's door, all the doors and the tailgate lock. Pushing forward on the lock tab on the driver's door unlocks only that door. The lock tab on the each passenger's door locks and unlocks only that door.

When the door is unlocked, you can see the red indicator on the lock tab next to the inside door handle.

All doors and the tailgate can be locked from the outside by using the key in the driver's door lock. To unlock only the driver's door, insert the key, turn the key, and release it. The remaining doors and the tailgate unlock when you turn the key a second time within a few seconds.

You can change the "DOOR LOCK MODE" setting on the multi-information display (see page 103).

*CONTINUED*

## Door Locks

When the vehicle speed reaches about 9 mph (about 15 km/h) or more, all the doors lock automatically.

You can change the “AUTO DOOR LOCK” setting in the multi-information display (see page 101).

When you shift to P after driving, the driver’s door unlocks.

You can change the “AUTO DOOR UNLOCK” setting in the multi-information display (see page 109).

To lock any passenger’s door when getting out of the vehicle, pull backward on the lock tab and close the door. To lock the driver’s door, remove the key from the ignition switch and pull backward on the lock tab. Then close the door.

### ***Lockout Prevention***

With the driver’s door open and the key in the ignition, both master door lock switches are disabled. They are not disabled if the driver’s door is closed. Pushing the switch down on the open front passenger’s door will lock all doors and the tailgate.

## Childproof Door Locks

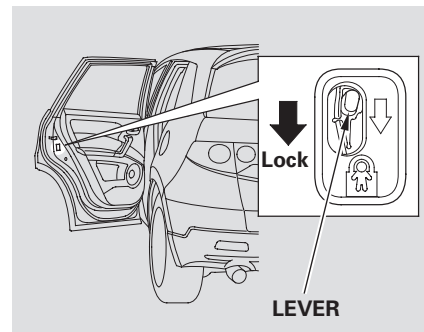

The childproof door locks are designed to prevent children seated in the rear from accidentally opening the rear doors. Each rear door has a lock lever near the edge. With the lever in the LOCK position (lever is down), the door cannot be opened from the inside regardless of the position of the lock tab. To open the door, push the lock tab forward and use the outside door handle.



The tailgate will lock when you lock the driver's door, and will unlock when you unlock all doors.

You can change the "DOOR LOCK MODE" setting on the multi-information display (see page 103).

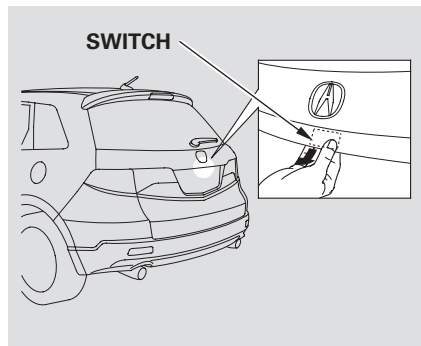

To open the tailgate, press and hold the switch, then lift up.

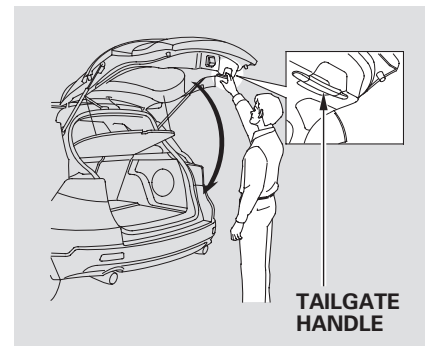

To close the tailgate, hold the tailgate handle, lower the tailgate, then press down on the back edge.

Keep the tailgate closed at all times while driving to avoid damaging the tailgate and to prevent exhaust gas from getting into the interior. See **Carbon Monoxide Hazard** on page 56.

# Tailgate

---

## Unlocking the Tailgate

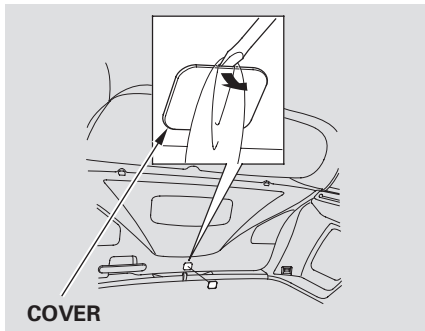

If the power door lock system cannot unlock the tailgate, unlock it manually.

Use a small flat-tip screwdriver to remove the cover on the back of the tailgate.

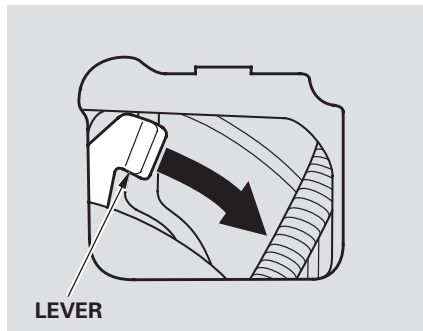

Push and hold the release lever to the right as shown, then push the tailgate to open it.

If you need to unlock the tailgate manually, it means there is a problem with the tailgate. Have the vehicle checked by your dealer.

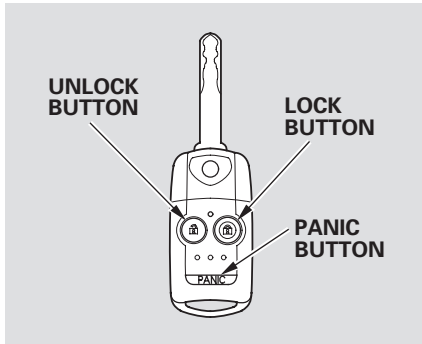

**LOCK** — Press this button once to lock all doors and the tailgate. Some exterior lights will flash. When you push LOCK twice within 5 seconds, you will hear a beep to verify that the doors and tailgate are locked and the security system has set. This button does not work if any door or tailgate is not fully closed.

To change the “KEYLESS LOCK ACKNOWLEDGEMENT” setting, see page [105](#).

**UNLOCK** — Press this button once to unlock the driver’s door. Push it twice to unlock the other doors. Some exterior lights will flash twice when you push the button. If you do not open any door or the tailgate within 30 seconds, they will automatically relock.

To change the “DOOR LOCK MODE” setting, see page [103](#).

To change the “SECURITY RELOCK TIMER” setting, see page [107](#).

When you press the UNLOCK button, the ceiling lights (if the front and rear ceiling light switches are in the door activated position) will come on. If you do not open any door, the lights stay on for about 30 seconds, then fade out. If you relock the doors with the remote transmitter before 30 seconds have elapsed, the lights go off immediately.

To change the “INTERIOR LIGHT DIMMING TIME” setting, see page [96](#).

**PANIC** — Press this button for about 1 second to attract attention; the horn will sound, and the exterior lights will flash for about 30 seconds. To cancel panic mode, press any button on the remote transmitter, or turn the ignition switch to the ON (II) position.

## Remote Transmitter

### Remote Transmitter Care

- Avoid dropping or throwing the transmitter.
- Protect the transmitter from extreme temperature.
- Do not immerse the transmitter in any liquid.
- If you lose a transmitter, the replacement needs to be reprogrammed by your dealer.

### Replacing the Transmitter Battery

If it takes several pushes on the button to lock or unlock the doors and the tailgate, replace the battery as soon as possible.

Battery type: CR1616

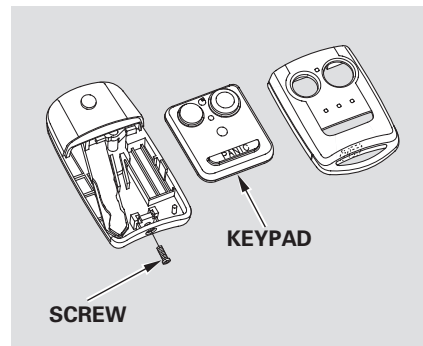

To replace the battery:

1. Remove the screw at the base of the transmitter with a small Phillips-head screwdriver.
2. Separate the keypad from the transmitter by pushing any button from outside.

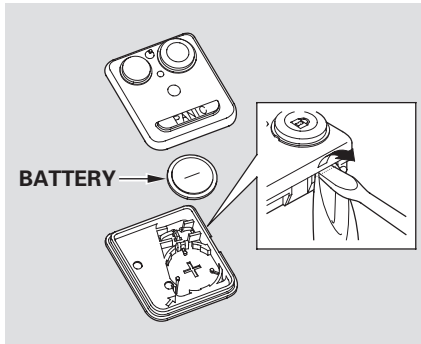

3. Place a cloth on the edge of the keypad, and remove the upper half by carefully prying on the edge with a small flat-tip screwdriver.

4. Remove the old battery and note the polarity. Make sure the polarity of the new battery is the same (– side facing up), then insert it in the keypad.

An improperly disposed of battery can hurt the environment. Always confirm local regulations for battery disposal.

5. Snap the two halves of the keypad, then install the parts in reverse order.

*As required by the FCC:*

*This device complies with Part 15 of the FCC rules. Operation is subject to the following two conditions: (1) This device may not cause harmful interference, and (2) this device must accept any interference received, including interference that may cause undesired operation.*

*Changes or modifications not expressly approved by the party responsible for compliance could void the user's authority to operate the equipment.*

*This device complies with Industry Canada Standard RSS-210.*

*Operation is subject to the following two conditions: (1) this device may not cause interference, and (2) this device must accept any interference that may cause undesired operation of the device.*

## Remote Transmitter

### Keyless Memory Settings™

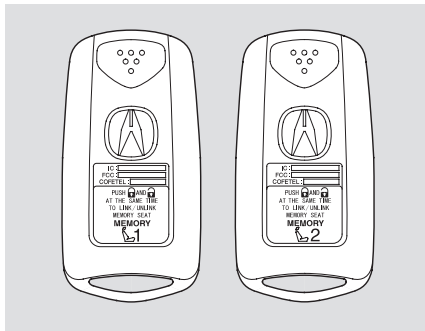

When you unlock the driver's door with your remote, each remote activates the keyless memory settings related to that remote. The driver's ID (MEMORY 1 or MEMORY 2) is shown on the back of each remote.

Here are the settings activated with the remote;

- Driving position memory (see page 146).

When you unlock and open the driver's door with the remote transmitter, the driver's seat (except the power lumbar feature) and outside mirrors start to move to the positions stored in memory. The indicator in the related memory button to the remote comes on.

To turn off this feature, press and hold the LOCK and UNLOCK buttons at the same time. The LED in the remote will blink twice. Then release the buttons. Doing this cancels the keyless memory settings for that remote.

To turn the keyless memory settings back on, repeat this procedure. The LED will blink once to indicate the feature has been turned on.

## Driver's Seat Adjustments

See pages 12 – 13 for important safety information and warnings about how to properly position the seats and seat-backs.

The controls for the power adjustable driver's seat are on the outside edge of the seat bottom. You can adjust the seat with the ignition switch in any position. Make all seat adjustments before you start driving.

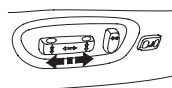
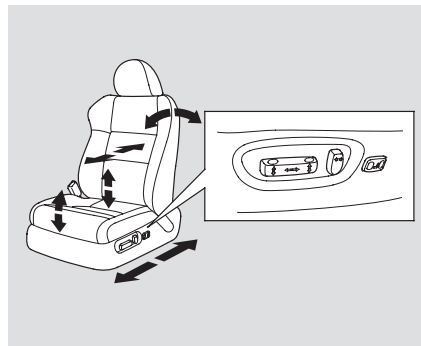

Moves the seat forward and backward.

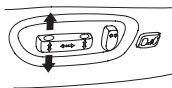

Moves the front of the seat up or down.

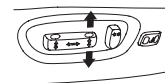

Raises or lowers the seat.

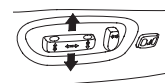

Moves the whole seat up and forward, or down and backward. The front of the seat also tilts up or down at the same time.

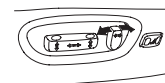

Adjusts the seat-back angle forward or backward.

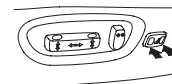

Increases or decreases the lumbar support.

## Seats

### Front Passenger's Seat Adjustments

See pages 12 – 13 for important safety information and warnings about how to properly position the seats and seat-backs.

Make all seat adjustments before you start driving.

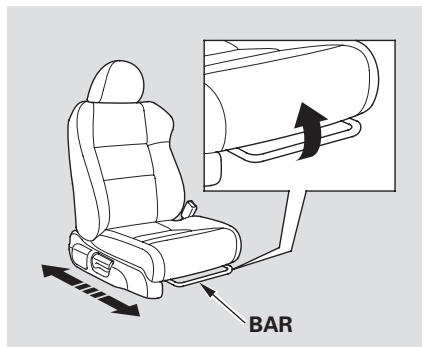

To adjust the seat forward or backward, pull up on the bar under the seat cushion's front edge. Move the seat to the desired position, and release the bar. Try to move the seat to make sure it is locked in position.

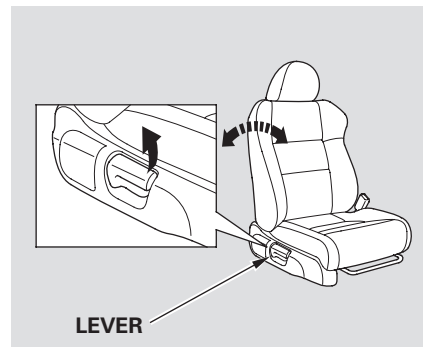

To change the seat-back angle, pull up on the lever on the outside of the seat bottom.

Once your seat is adjusted correctly, rock it back and forth to make sure the seat is locked in position.



## Head Restraints

See page 14 for important safety information and a warning about improperly positioning head restraints.

Your vehicle is equipped with head restraints in all seating positions to help protect you and your passengers from whiplash and other injuries.

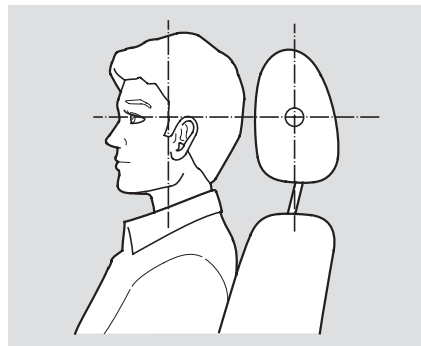

They are most effective when you adjust them so the center of the back of the occupant's head rests against the center of the restraint.

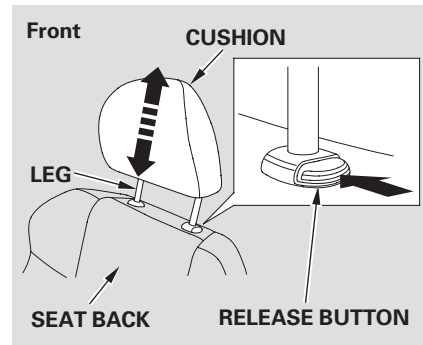

### *Adjusting the Head Restraint*

The front and rear head restraints adjust for height. You need both hands to adjust the restraint. Do not attempt to adjust it while driving. To raise it, pull upward. To lower the restraint, push the release button and push the restraint down.

*CONTINUED*

## Seats

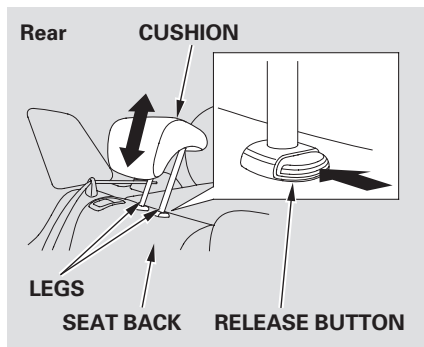

### *Removing the Head Restraint*

To remove a head restraint for cleaning or repair, pull it up as far as it will go. Push the release button, then pull the restraint out of the seat-back.

When reinstalling a head restraint, put the legs back in place. Then adjust it to the appropriate height while pressing the release button.

Make sure the removed head restraints are securely stored.

### **⚠ WARNING**

Failure to reinstall the head restraints can result in severe injury during a crash.

Always replace the head restraints before driving.

### Active Head Restraints

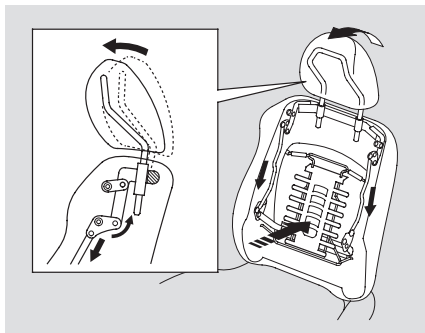

The driver's and front passenger's seats have active head restraints. If the vehicle is struck severely from the rear, the occupant properly secured with the seat belt will be pushed against the seat-back and the head restraint will automatically move forward.

This reduces the distance between the restraint and the occupant's head. It also helps protect the occupants against whiplash and injuries to the neck and upper spine.

After a collision, the activated restraint should return to its normal position.

If the restraints do not return to their normal position, or in the event of a severe collision, have the vehicle inspected by a Acura dealer.

For a head restraint system to work properly:

- Do not hang any items on the head restraints, or from the restraint legs.
- Do not place any object between an occupant and the seat-back.
- Install each restraint in its proper location.
- Only use genuine Acura replacement head restraints.

## Seats

---

### Armrests

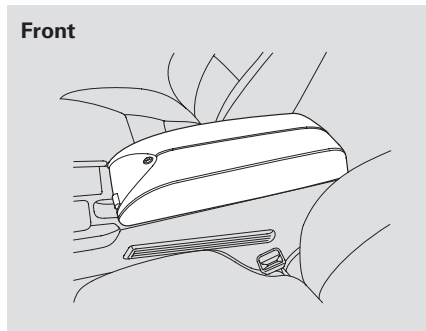

The lid of the console compartment can be used as an armrest.

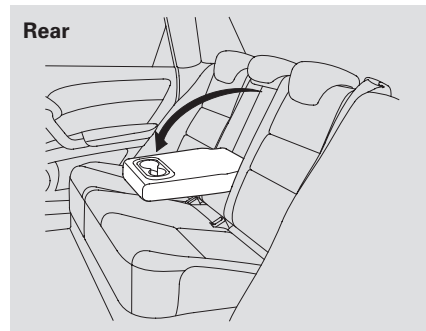

The rear seat armrest is in the center of the rear seat. Pivot it down to use it.

### Folding the Rear Seats Down

The rear seat-backs can be folded down to give more cargo room. Each side folds down separately. So you can still carry a passenger in the rear seat.

Remove any items from the seat before folding down the seat-back.

Make sure there are no items on the floor before folding down the seats.

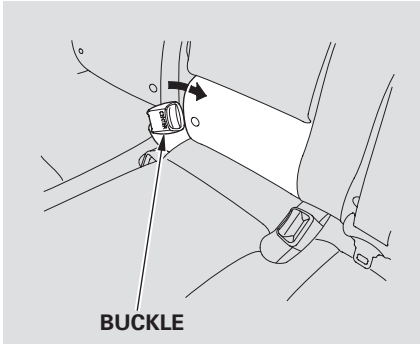

1. Move the front seats as far forward as possible. Make sure the front seat-backs are in the upright positions.
2. Store the center seat belt buckle into the pocket in the rear seat-back.
3. Lower the head restraints to their lowest positions.

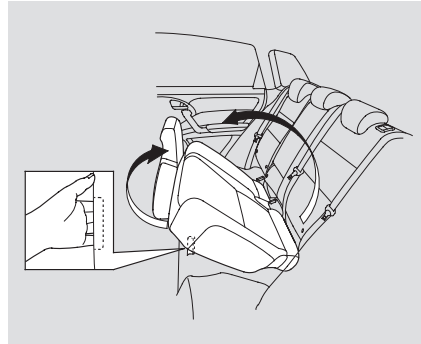

4. Push the armrest back in place.
5. Lift the front edge of the rear seat cushion, then pull up on the rear of the seat cushion, then fold the cushion forward.

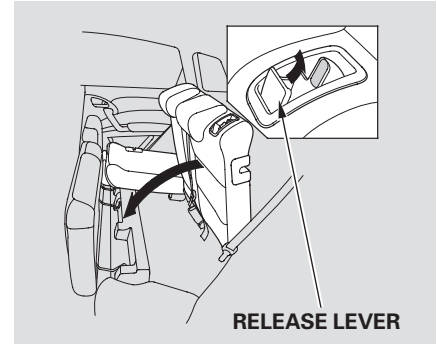

6. Pull up the release lever on the outside of the seat-back. Fold the seat-back forward.
7. Move the front seats backward to the desired position. Make sure the front passenger's seat is locked in place.

*CONTINUED*

## Seats

Do not put any heavy items on the seat-back when it is folded down.

Make sure all items in the cargo area are secured. Loose items can fly forward and cause injury if you have to brake hard (See **Carrying Cargo** on page 283).

Make sure that the folded down rear seat does not interfere with the front passenger's seat-back. This will cause the front passenger's weight sensors and the front passenger's seat belt reminder indicator to work improperly (see pages 20 and 32). Also check the passenger airbag off indicator to assure proper operation of the passenger's front airbag.

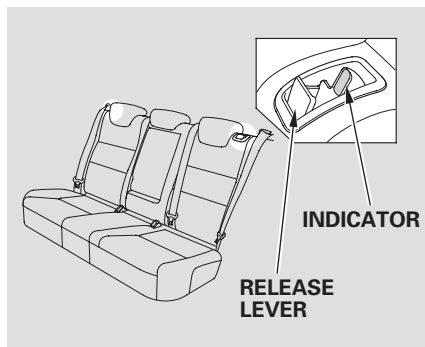

After returning the seat-back to the upright position, tug on the seat-back to make sure it is latched. If the seat-back is not latched fully, the seat belt will not work properly and you will see the red indicator behind the release lever as shown.

To return the seat cushion to its original position, lift up the seat cushion, then place the rear of the seat cushion at the base of the seat-back. Use the seat buckles as guides. Lower the front of the seat cushion until it locks into place.

Make sure the seat-back and seat cushion are locked securely and all rear shoulder belts are positioned in front of the rear seat-backs.

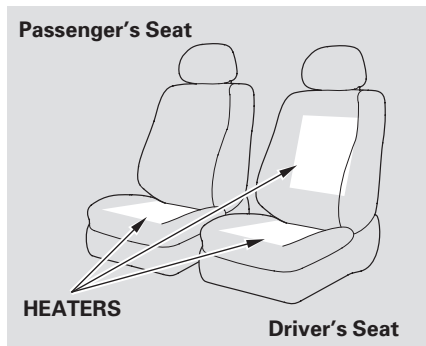

Both front seats are equipped with seat heaters. The passenger seat is only heated in the seat bottom because of the side airbag cutoff system.

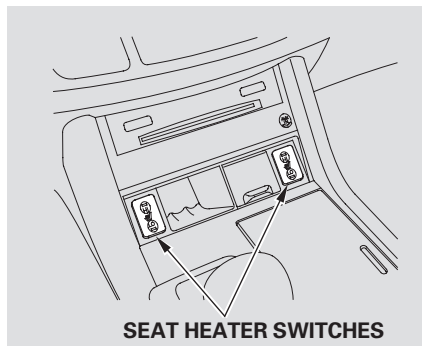

The ignition switch must be in the ON (II) position to use seat heaters. Push the top of the switch, HI, to rapidly heat up the seat. After the seat reaches a comfortable temperature, select LO by pushing the bottom of the switch. This will keep the seat warm.

In the HI setting, the heater turns off when the seat gets warm, and turns back on after the seat's temperature drops.

In the LO setting, the heater runs continuously. It does not cycle with temperature changes.

Follow these precautions whenever you use the seat heaters:

- Use the HI setting only to heat the seats quickly, because it draws large amounts of current from the battery.
- If the engine is left idling for an extended period, do not use the seat heaters, even on the LO setting. It can weaken the battery, causing hard starting.

## Power Windows

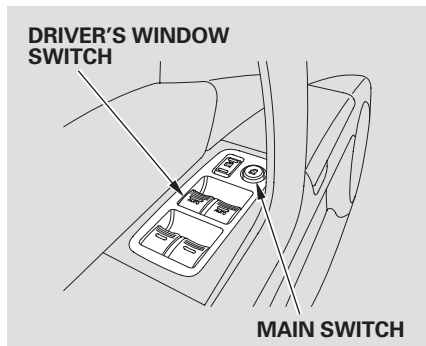

Turn the ignition switch to the ON (II) position to raise or lower any window. To open the window, push the switch down and hold it. Release the switch when you want to stop the window. To close the window, pull back on the switch and hold it.

The windows will operate for up to 10 minutes after you turn off the ignition switch. Opening either front door cancels this function.

### **⚠ WARNING**

Closing a power window on someone's hands or fingers can cause serious injury.

Make sure your passengers are away from the windows before closing them.

When you push the MAIN switch in, the switch is off, and the passenger windows cannot be raised or lowered. To cancel this feature, push on the switch again to get it to pop out. Keep the MAIN switch off when you have children in the vehicle so they do not injure themselves by operating the windows unintentionally.



**AUTO** — To open or close either front window fully, push or pull the window switch firmly down or up to the second detent, and release it. The window will automatically go up or down all the way. To stop the window, pull or push the window switch briefly.

To open or close either front window partially, push down or pull back on the window switch lightly to the first detent and hold it. The window will stop when you release the switch.

**AUTO REVERSE** — If either front window senses any obstacle while it is closing automatically, it will reverse direction and then stop. To close the window, remove the obstacle, then use the window switch again.

Auto reverse stops sensing when the window is almost closed. You should always check that all passengers and objects are away from the window before closing it.

## Moonroof

Turn the ignition switch to the ON (II) position before operating the moonroof switch on the ceiling console.

To open the moonroof fully, pull back the moonroof switch firmly. The moonroof opens all the way. To stop the moonroof from opening fully, briefly move the switch in either direction.

To tilt the moonroof, push the center of the moonroof switch straight up. To stop the moonroof from tilting fully open, push the moonroof switch forward.

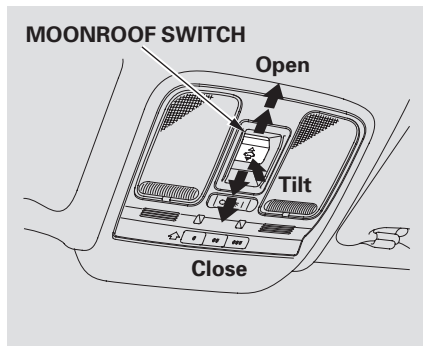

To open or close the moonroof partially, pull or push the moonroof switch lightly to the first detent and hold it. The moonroof will stop when you release the switch.

To close the moonroof fully, push the moonroof switch forward to the second detent, then release it. The moonroof closes all the way. To stop the moonroof from closing all the way, briefly move the switch in either direction.

**⚠ WARNING**

Opening or closing the moonroof on someone's hands or fingers can cause serious injury.

Make sure all hands and fingers are clear of the moonroof before opening or closing it.

The moonroof has a key-off delay. You can open and close the moonroof for up to 10 minutes after you turn off the ignition switch. The key-off delay cancels as soon as you open either front door. You must then turn the ignition switch to the ON (II) position for the moonroof to operate.

**NOTICE**

*If you try to open the moonroof in below-freezing temperatures, or when it is covered with snow or ice, you can damage the moonroof panel or motor.*

**Auto Reverse**

If the moonroof runs into any obstacle while it is closing automatically, it will reverse direction, and then stop. To close the moonroof, remove the obstacle, then use the moonroof switch again.

Auto reverse stops sensing when the moonroof is almost closed. You should always check that all passengers and objects are away from the moonroof before closing it.

## Mirrors

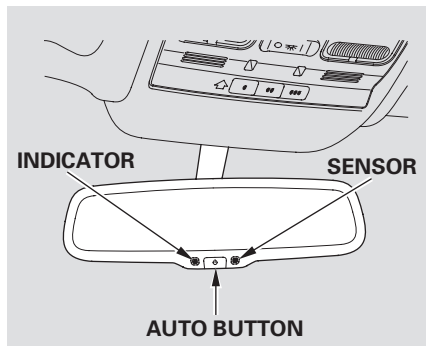

Keep the inside and outside mirrors clean and adjusted for best visibility. Be sure to adjust the mirrors before you start driving.

The inside mirror can automatically darken to reduce glare. To turn on this feature, press the button on the bottom of the mirror. The AUTO indicator comes on as a reminder. When it is on, the mirror darkens when it senses the headlights of a vehicle behind you, then returns to normal visibility when the lights are gone. Press the button again to turn off this feature.

### NOTICE

*There is also a sensor on the back of the mirror. Items hung on the mirror may block this sensor and affect its performance.*

## Adjusting the Power Mirrors

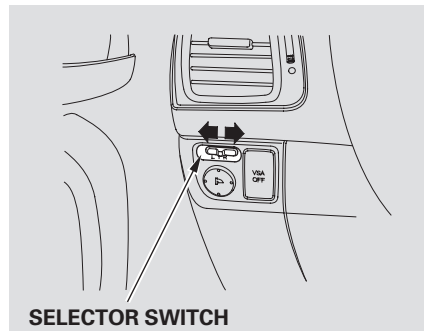

1. Turn the ignition switch to the ON (II) position.
2. Move the selector switch to L (driver's side) or R (passenger's side).

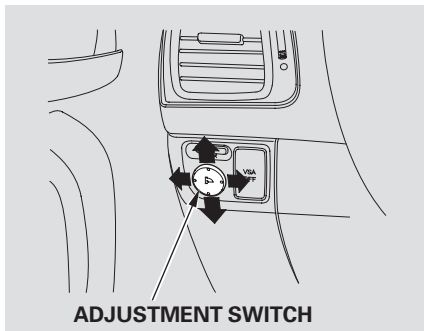

3. Push the appropriate edge of the adjustment switch to move the mirror right, left, up, or down.
4. When you finish, move the selector switch to the center (off) position. This turns the adjustment switch off to keep your setting.

Outside mirror positions can be stored in the driving position memory system (see page 146).

### Reverse Tilt Door Mirror

The passenger outside mirror has a reverse tilt feature. When in reverse, the mirror will tilt down slightly to improve your view as you parallel park. Shifting out of reverse will return the mirror to its original position.

- To tilt the passenger mirror, place the selector switch in the right position.
- To turn the feature off, place the switch in the center or left position.

### Heated Mirrors

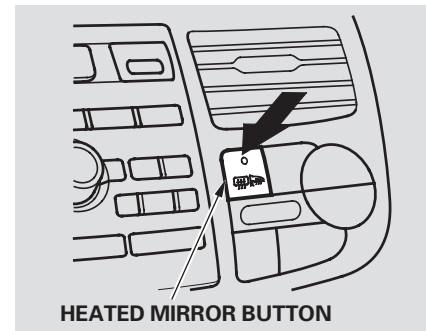

The outside mirrors are heated to remove fog and frost. With the ignition switch in the ON (II) position, turn on the heaters by pressing the button. The indicator in the button comes on as a reminder. Press the button again to turn the heaters off. Pressing this button also turns the rear window defogger on and off.

## Driving Position Memory System

Your vehicle has a memory feature for the driver's seat and outside mirror positions.

Seat, except for power lumbar, and outside mirror positions, can be stored in separate memories. You select a memorized position by pushing the appropriate button or using the appropriate remote transmitter (Memory 1 or Memory 2).

### Storing a Driving Position in Memory

Store a driving position only when the vehicle is parked.

1. Turn the ignition switch to the ON (II) position. You cannot add a new driving position to the memory unless the ignition switch is in the ON (II) position. You can recall a memorized position with the ignition switch in any position.
2. Adjust the seat to a comfortable position (see page [131](#) ). Adjust the outside mirrors for best visibility (see page [144](#) ).

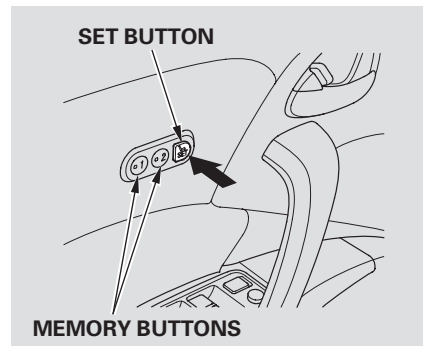

3. Press and release the SET button on the control panel. You will hear a beep. Immediately press and hold one of the memory buttons (1 or 2) until you hear two beeps. The indicator in the memory button will come on. The current positions of the driver's seat and outside mirrors are now stored.

Doing any of the following after pressing the SET button will cancel the storing procedure.

- Not pressing a memory button within 5 seconds.
- Readjusting the seat position.
- Readjusting the outside mirror position.

Each memory button stores only one driving position. Storing a new position erases the previous setting stored in that button's memory. If you want to add a new position while retaining the current one, use the other memory button.

### Selecting a Memorized Position

To select a memorized position, do this:

1. Make sure the vehicle is parked.
2. Press the desired memory button (1 or 2) until you hear a beep, then release the button.

The system will move the seat and outside mirrors to the memorized positions. The indicator in the selected memory button will flash during movement. When the adjustments are complete, you will hear two beeps, and the indicator will remain on.

To stop the system's automatic adjustment, do any of these actions:

- Press any button on the control panel: SET, 1, or 2.
- Push any of the adjustment switches for the seat.
- Shift out of Park.
- Adjust the outside mirrors.

If desired, you can use the adjustment switches to change the positions of the seat or outside mirrors after they are in their memorized position. If you change the memorized position, the indicator in the memory button will go out. To keep this driving position for later use, you must store it in the driving position memory.

## Parking Brake

---

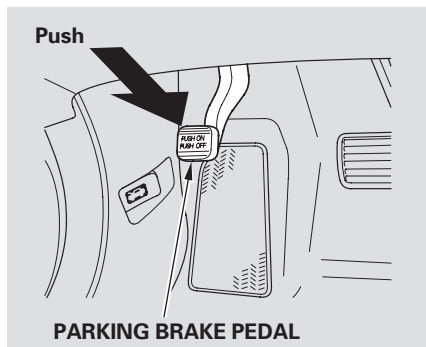

To apply the parking brake, push the pedal down with your foot. To release it, push on the pedal again. The parking brake indicator on the instrument panel should go out when the parking brake is fully released (see page [65](#)).

### NOTICE

*Driving the vehicle with the parking brake applied can damage the rear brakes and axles. A beeper will sound if the vehicle is driven with the parking brake on.*

You will also see a “RELEASE PARKING BRAKE” message on the multi-information display (see page [77](#)).



## Ceiling Lights

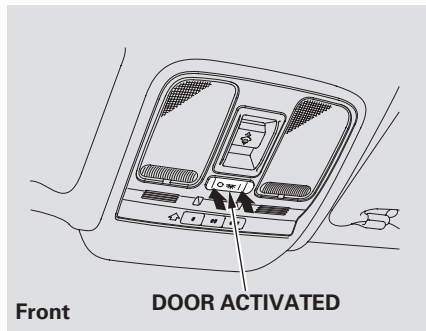

Each front and rear ceiling light has a three-position switch.

### Front ceiling lights:

In the “ | ” position, both front and rear ceiling lights are on all the time except when the rear ceiling light switch is in the OFF position.

In the “ ○ ” position, both front and rear ceiling lights are off all the time.

With the front ceiling lights switch in this position, the rear ceiling light does not work, and both front and rear ceiling lights do not come on when you open any door.

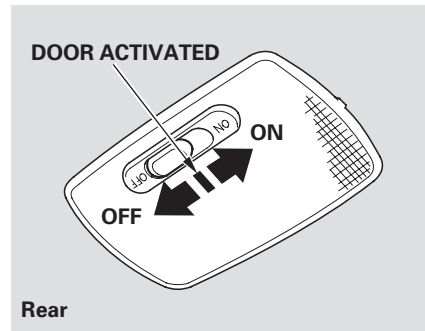

### Rear ceiling light:

You can use the rear ceiling light independently. In the OFF position, the light does not come on even if the front ceiling light switch is in the “ | ” position. In the ON position, the light stays on continuously except when the front ceiling light switch is in the “ ○ ” position.

*CONTINUED*

## Interior Lights

---

In the door activated position, both front and rear ceiling lights come on when you:

- Open any door.
- Remove the key from the ignition switch.
- Unlock the doors with the key, lock tab on the driver's door, master door lock switch, or remote transmitter.

After all doors are closed tightly, the light(s) dims slightly, then fades out in about 30 seconds.

If you do not open any door after unlocking the driver's door or removing the key from the ignition switch, the light(s) fade out in about 30 seconds. If you leave any door open without the key in the ignition switch, the light(s) will go off after 3 minutes.

To change the "INTERIOR LIGHT DIMMING TIME" setting, see page [96](#).

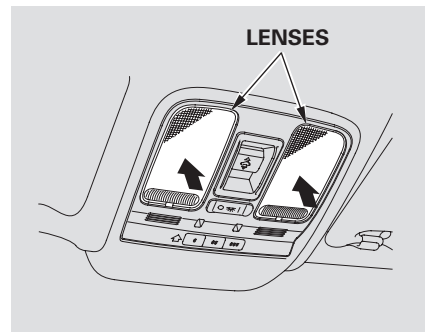

### Individual Map Lights

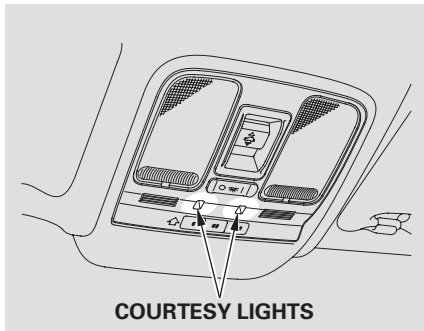

You can use the front ceiling lights whenever the lights are off. To turn a light on or off, push its lens.

### Courtesy Lights



The courtesy lights in the ceiling console come on when the light switch is in the  or the  position. You can adjust their brightness by turning the Select/Reset knob on the instrument panel.

The courtesy light in each front door comes on when the door is opened, and goes out when the door is closed.

Your vehicle also has a courtesy light in the ignition switch. This light comes on when you;

- Open any door.
- Unlock the driver's door.
- Remove the key from the ignition switch.

After all doors are closed tightly, the light fades out in about 30 seconds.

To change the “INTERIOR LIGHT DIMMING TIME” setting, see page [96](#) .

### Cargo Area Light

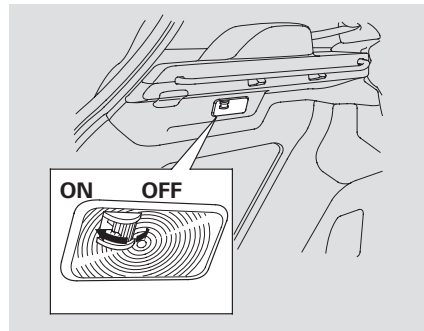

The cargo area light has a two position switch. In the OFF (right) position, the light does not come on. In the ON (left) position, the light comes on when you open the tailgate.

## Interior Convenience Items

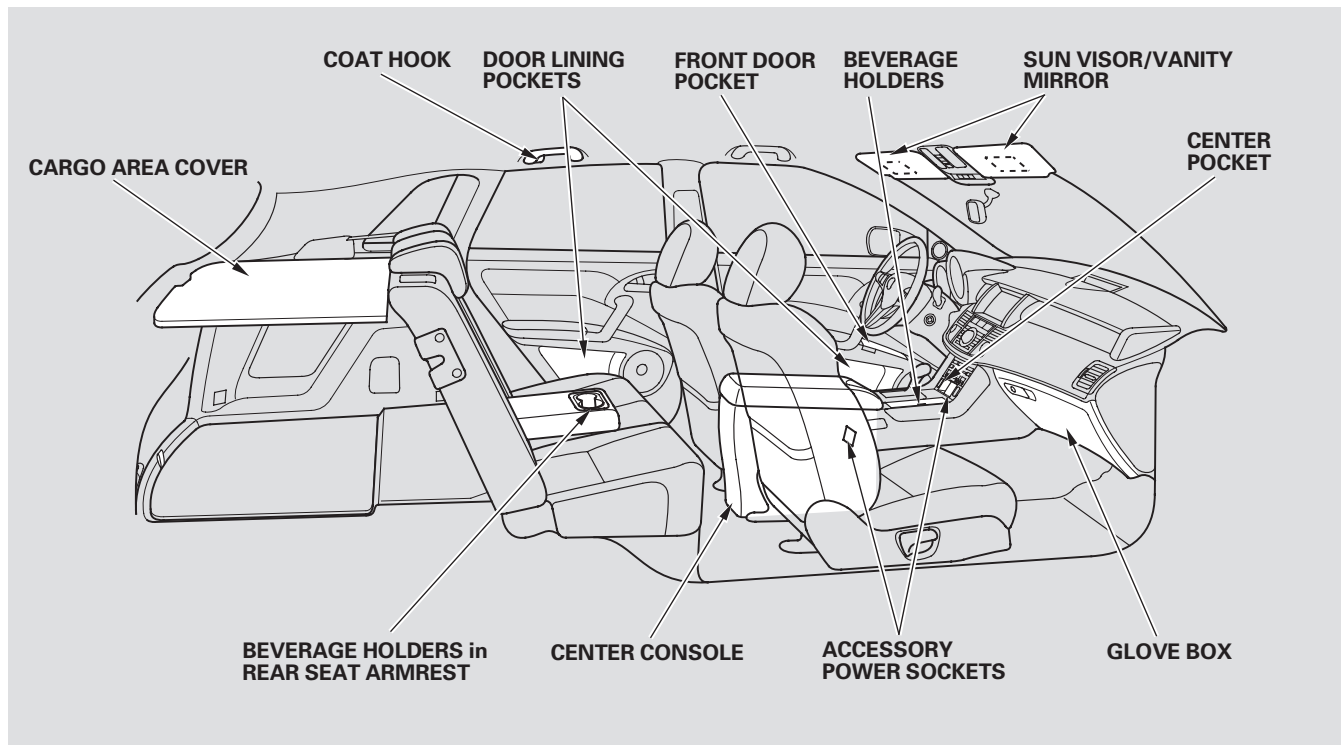

### Glove Box

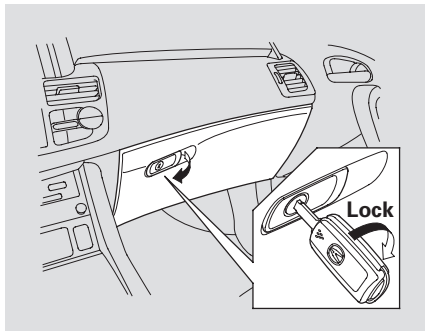

Open the glove box by pulling the handle to the left. Close it with a firm push. Lock or unlock the glove box with the master key.

### **⚠ WARNING**

An open glove box can cause serious injury to your passenger in a crash, even if the passenger is wearing the seat belt.

Always keep the glove box closed while driving.

The glove box light comes on when the parking lights are on.

### Front Door Pockets

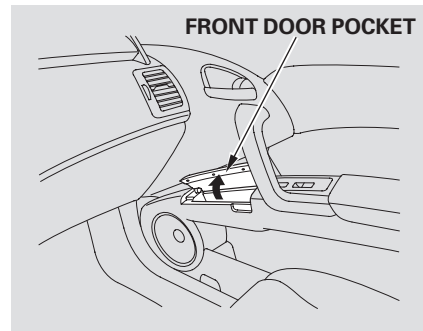

The interior of each front door has an extendable pocket for maps and other small, lightweight items. For safety, be sure both front door pockets are closed while driving.

## Interior Convenience Items

---

### Beverage Holders

Be careful when you are using the beverage holders. A spilled liquid that is very hot can scald you or your passengers. Spilled liquids can damage the upholstery, carpeting, and electrical components in the interior.

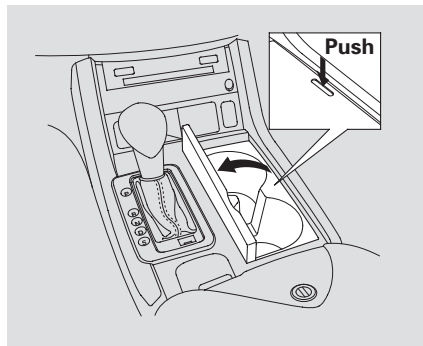

To use the front beverage holder, push on the lid. It will swing open. To close the lid, push it down until it latches.

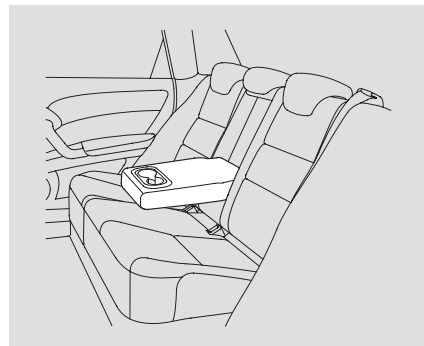

The rear seat also has a beverage holder in the center armrest. To use it, pivot the armrest down.

## Accessory Power Sockets

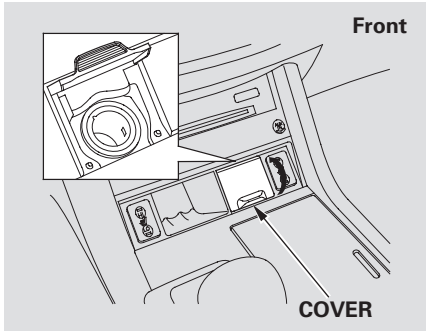

To use the accessory power socket, pull up the cover. The ignition switch must be in the ACCESSORY (I) or ON (II) position.

These sockets are intended to supply power for 12 volt DC accessories that are rated 120 watts or less (10 amps).

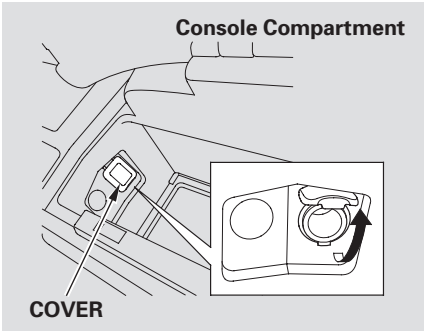

None of the sockets will power an automotive type cigarette lighter element. When both sockets are being used, the combined power rating of the accessories should be 120 watts or less (10 amps).

## Sun Visor

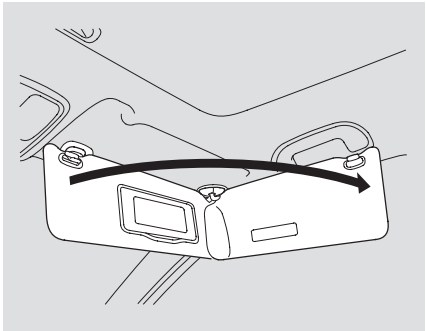

To use the sun visor, pull it down. You can also use the sun visor at the side window. Remove the support rod from the clip and swing the sun visor toward the side window.

Make sure you put the sun visor back in place when you are getting into or out of the vehicle.

## Interior Convenience Items

### Vanity Mirror

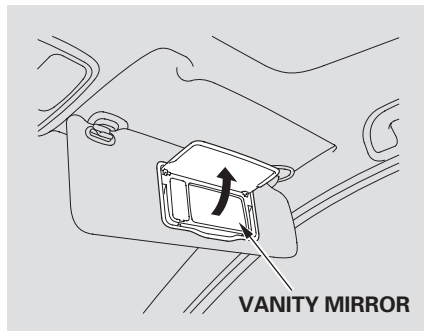

To use the vanity mirror on the back of the sun visor, pull up the cover.

The light comes on when you pull up the cover.

### Console Compartment

Your vehicle has a multi-function console compartment. It includes an armrest, a coin holder, a pen holder, a card holder and a console compartment with two separable shelves.

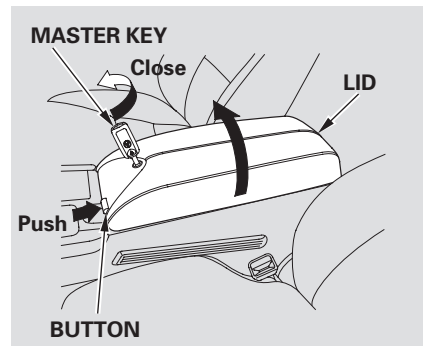

To open the console compartment, push the button and lift the lid.  
To close, lower the lid, and push it down until it latches.

You can lock or unlock the console compartment lid with the master key.



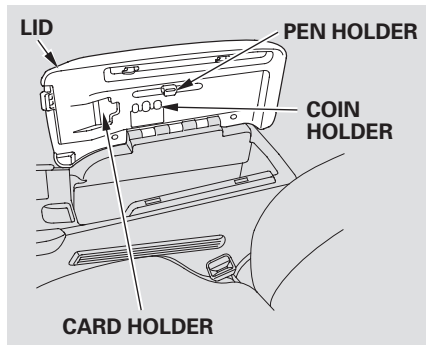

You can use the inside of the lid for a pen holder, a coin holder and a card holder.

The console compartment light comes on when the parking lights are on.

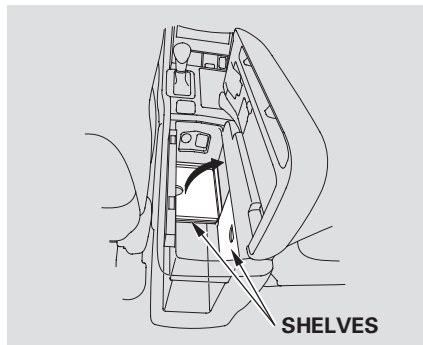

The console compartment has two shelves to divide it into two levels. To store small items, you can use the upper half of the space by putting the shelves down until they latch. The front and rear shelves can be used separately.

The items on each shelves should not exceed 11 lbs (5 kg). Heavy items may damage the shelves.

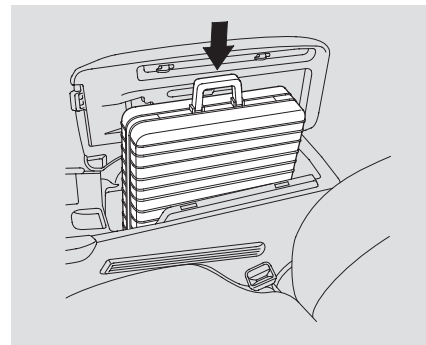

When you store a large item like a briefcase, lift the shelves up to create a large space.

The maximum dimensions of the item you can store in the console compartment are:  
Length: 16.9 in (430 mm)  
Height: 12.2 in (310 mm)  
Width: 5.5 in (140 mm)

## Interior Convenience Items

### Cargo Area Cover

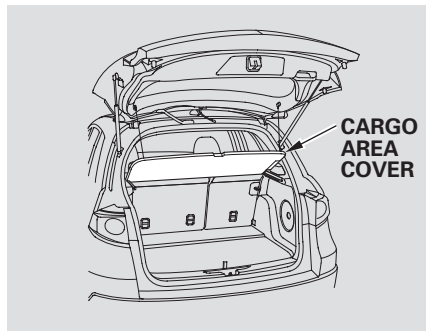

Your vehicle has a cargo area cover to conceal your luggage and protect them from direct sunlight.

Do not put any items on top of the cargo area cover. They can block your view and be thrown around the vehicle during a crash.

The cargo area cover may be removed to give you more cargo space.

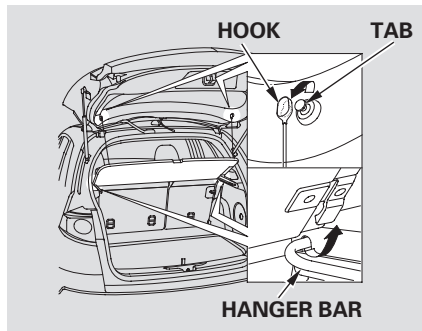

To remove it:

1. Open the tailgate. Remove the hook from the tab on the tailgate. Make sure you use both hands to prevent the cargo area cover from falling accidentally.
2. Lift and pull the rear edge of the cargo area cover slightly to unlock it from the hanger bars, then remove it straight out.

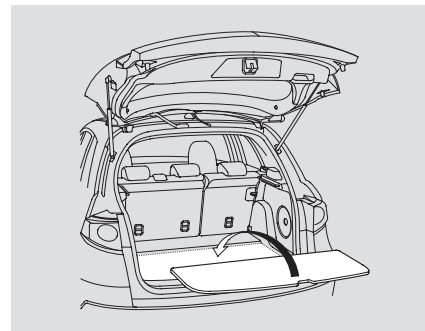

3. Place the cargo area cover on the cargo area floor.

Make sure the cargo area cover is securely placed so it will not move while you are driving.

Reverse this procedure to install the cargo area cover.

The climate control system in your vehicle provides a comfortable driving environment in all weather conditions.

The standard audio system has many features. This section describes those features and how to use them.

Your vehicle has an anti-theft audio system that requires a code number to enable it.

The security system helps to discourage vandalism and theft of your vehicle.

### *On RDX with Technology Package model*

The climate control system and the audio system have a voice control feature. Refer to the navigation system manual for more information.

Climate Control System.....	160	Cruise Control.....	234
Dual Temperature Control.....	165	AcuraLink.....	237
Climate Control Sensors.....	167	HomeLink® Universal	
Audio System.....	168	Tranceiver.....	247
Audio System (On RDX model) ..	170	Bluetooth® HandsFreeLink® .....	252
To Play the AM/FM Radio .....	170	Rear View Camera and Monitor ..	270
Operating the CD Changer .....	173		
XM® Satellite Radio.....	183		
Adjusting the Sound.....	186		
Setting the Clock .....	188		
Audio System (On RDX with			
Technology Package			
model) .....	189		
Interface Dial .....	189		
To Play the AM/FM Radio .....	190		
Operating the CD Changer .....	196		
XM® Satellite Radio.....	211		
Adjusting the Sound.....	217		
Auxiliary Input Jack.....	220		
Radio Reception.....	221		
Protecting Your Discs.....	223		
CD Changer Error Messages .....	226		
Playing the XM® Satellite Radio ..	228		
Remote Audio Controls.....	230		
Radio Theft Protection.....	232		
Security System .....	233		

# Climate Control System

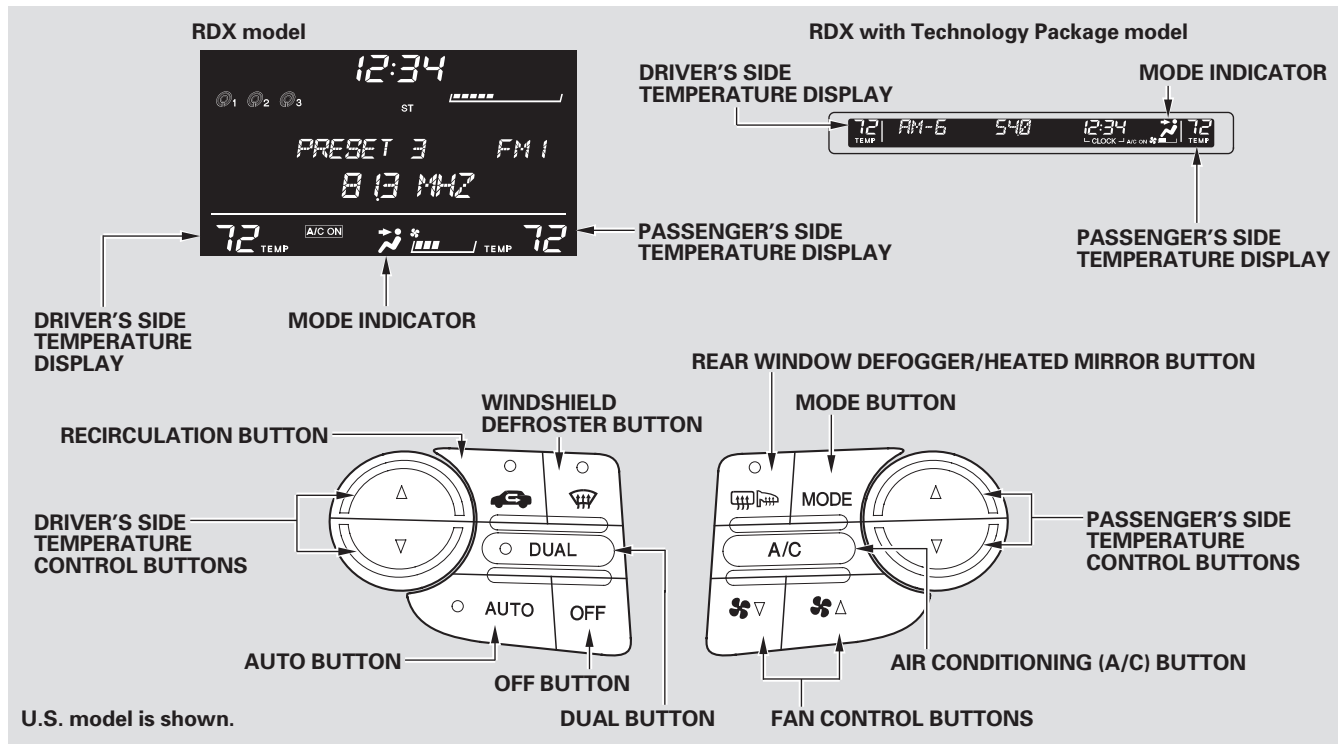

Proper use of the climate control system can make the interior dry and comfortable, and keep the windows clear for best visibility.

For the climate control system to provide heating and cooling, the engine must be running.

You can adjust the temperatures of the driver's side and the passenger's side independently (see page 165).

## Voice Control System

*On RDX with Technology Package model*

The climate control system for your vehicle can also be operated by voice control. See the navigation section in your quick start guide for an overview of this system, and the navigation system manual for complete details.

## Automatic Operation

The automatic climate control system adjusts the fan speed and airflow levels to maintain the interior temperature you select.

*On RDX with Technology Package model*

In AUTO mode, the vehicle's interior temperature is independently regulated for the driver and passenger. If the driver's side of the vehicle is getting too much sun, the system will adjust to a lower temperature.

1. Press the AUTO button. You will see AUTO on the display. The indicator in the button also comes on as a reminder.

2. Set the desired temperature by pushing the driver's side temperature control buttons (▲ or ▼). The selected temperature will show in the display.

When you push the passenger's side temperature control buttons, the indicator in the DUAL button comes on and the driver's side and passenger's side temperature can be controlled independently (see page 165).

The system automatically selects the proper mix of conditioned and/or heated air that will, as quickly as possible, raise or lower the interior temperature to your preference.

CONTINUED

## Climate Control System

---

When you set the temperature to its lowest limit ( **Lo** ) or its highest limit ( **Hi** ), the system runs at full cooling or heating only. It does not regulate the interior temperature.



In cold weather, the fan will not come on automatically until the heater starts to develop warm air.

### **Semi-automatic Operation**

You can manually select various functions of the climate control system when it is in the AUTO mode. All other features remain automatically controlled.

Making any manual selection causes the word AUTO in the display to go out.

### **Fan Control**

Select the fan speed by pressing the fan control buttons (  **▲** or  **▼** ). The fan speed is represented by vertical bars in the display.

### **Temperature Control**

To adjust the desired temperature, push the temperature control buttons (**▲** or **▼**).

### **Dual Button**

Press the DUAL button to select dual temperature control mode (see page 165). The indicator in the DUAL button comes on.

When you press the DUAL button again (indicator turns off), both sides adjust to the driver's side temperature.

### **Air Conditioning (A/C) Button**

Press the A/C button to turn the air conditioning on and off. You will see A/C ON or A/C OFF in the display.

When you turn the A/C off, the system cannot regulate the inside temperature if you set the temperature control below the outside temperature.

## Recirculation Button

When the indicator in the button is on, air from the vehicle's interior is sent throughout the system again. When the indicator is off, air is brought in from the outside of the vehicle (fresh air mode).

The outside air intakes for the climate control system are at the base of the windshield. Keep this area clear of leaves and other debris.

The system should be left in fresh air mode under almost all conditions. Keeping the system in recirculation mode, particularly with the A/C off, can cause the windows to fog up.

Switch to recirculation mode when driving through dusty or smoky conditions, then return to fresh air mode.

## Windshield Defroster Button

This button turns the windshield defrost on and off.

When you push this button, air flows from the defroster vents at the base of the windshield, and the system automatically switches to fresh air mode and turns on the A/C. When the indicator in the button is on, the passenger's temperature cannot be set separately from the driver's.

## Rear Window Defogger Button

This button turns the rear window defogger on and off. Pushing this button also turns the mirror heaters on and off (see page [118](#)).

*CONTINUED*

## Climate Control System

---

### Mode Button

Use the MODE button to select the vents the air flows from. Some air will flow from the dashboard corner vents in all modes.

The mode indicator in the display changes to the current mode each time you press the button.

 Air flows from the center and corner vents in the dashboard.

 Airflow is divided between the vents in the dashboard and the floor vents.

 Air flows from the floor vents.

 Airflow is divided between the floor vents and the defroster vents at the base of the windshield.

### To Turn Everything Off

If you press the OFF button, the climate control system shuts off completely.

- Keep the system off for short periods only.
- To keep stale air and mustiness from collecting, you should have the fan running at all times.

When the climate control system is turned off, the temperature in the display will also turn off.



Your vehicle has four temperature control buttons, two for the driver, and two for the front passenger.

The driver's side and the passenger's side can be controlled independently by adjusting these buttons when the indicator in the DUAL button is lit.

### Temperature Control Buttons

To set the driver's side temperature to a different value than the passenger's, press the DUAL button, then press the temperature control buttons (▲ or ▼) on the driver's side. To set the passenger's side to a different value than the driver's, press the temperature control buttons (▲ or ▼) on the passenger's side. You can adjust the passenger's side without pressing the DUAL button first.

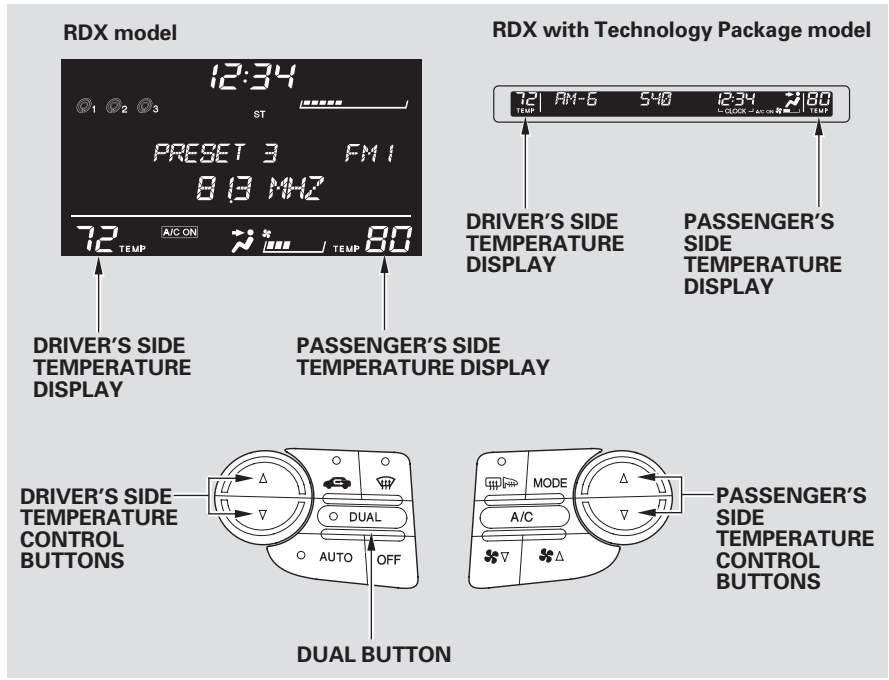



Features

CONTINUED

## Dual Temperature Control

When you set the temperature to its lower or upper limit, it is displayed as **Lo** or **Hi**.

Push **AUTO** or . The selected temperatures appear in the display. When the indicator in the **DUAL** button is off, you can adjust both sides to the same temperature by adjusting the driver's side temperature control buttons ( or ).

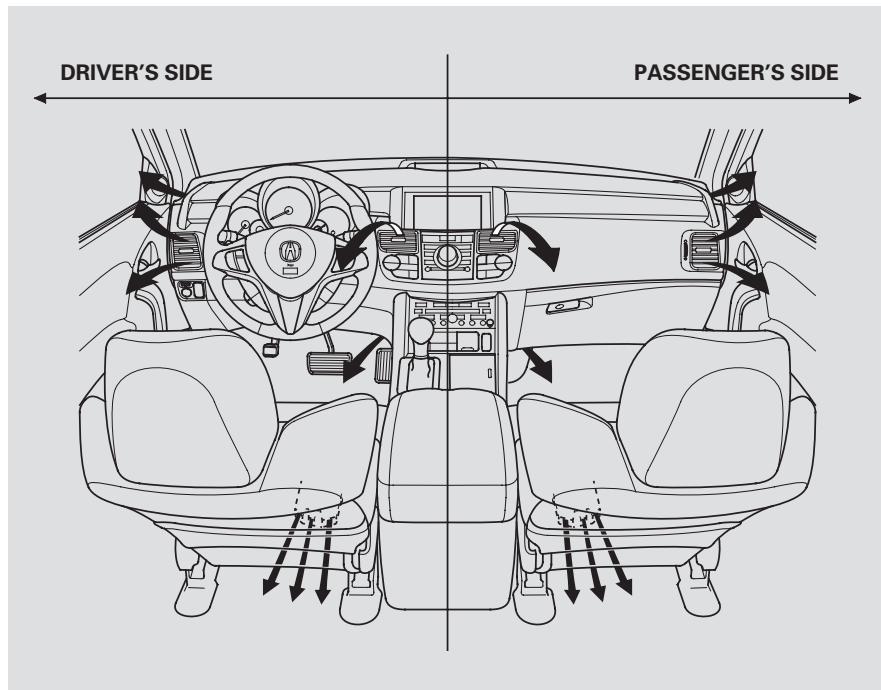

## Sunlight Sensor/Temperature Sensor

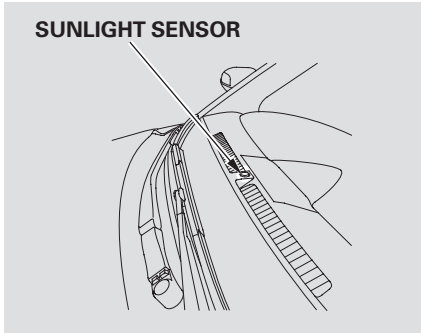

The climate control system has two sensors. A sunlight sensor is in the top of the dashboard, and a temperature sensor is next to the steering column. Do not cover the sensors or spill any liquid on them.

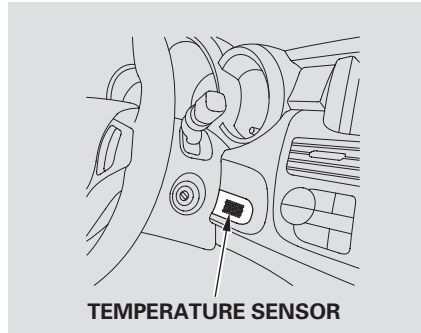

# Audio System

Read the appropriate pages in this section for operation of the audio systems installed in your vehicle.

- For RDX model, see pages 170 thru 188.
- For RDX with Technology Package model, see page 189 thru 220.

RDX model

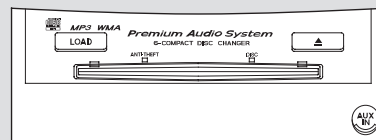
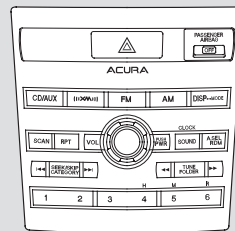
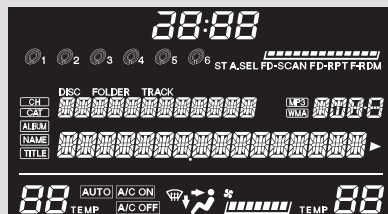

U.S. model is shown.

## RDX with Technology Package model

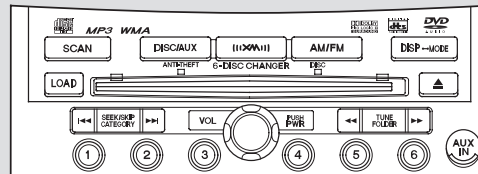
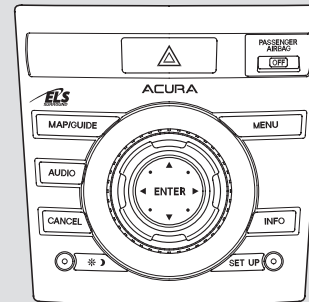
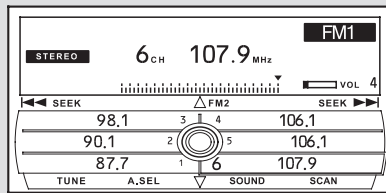

U.S. model is shown.

# Audio System

## To Play the AM/FM Radio

*On RDX model*

The ignition switch must be in the ACCESSORY (I) or the ON (II) position. Turn the system on by pushing the PWR/VOL knob, or the AM or FM button. Adjust the volume by turning the PWR/VOL knob.

The band and frequency that the radio was last tuned to is displayed. To change bands, press the AM or FM button. On the FM band, “ST” will be shown on the center display if the station is broadcasting in stereo. Stereo reproduction on AM is not available.

XM satellite radio information is available on page [183](#).

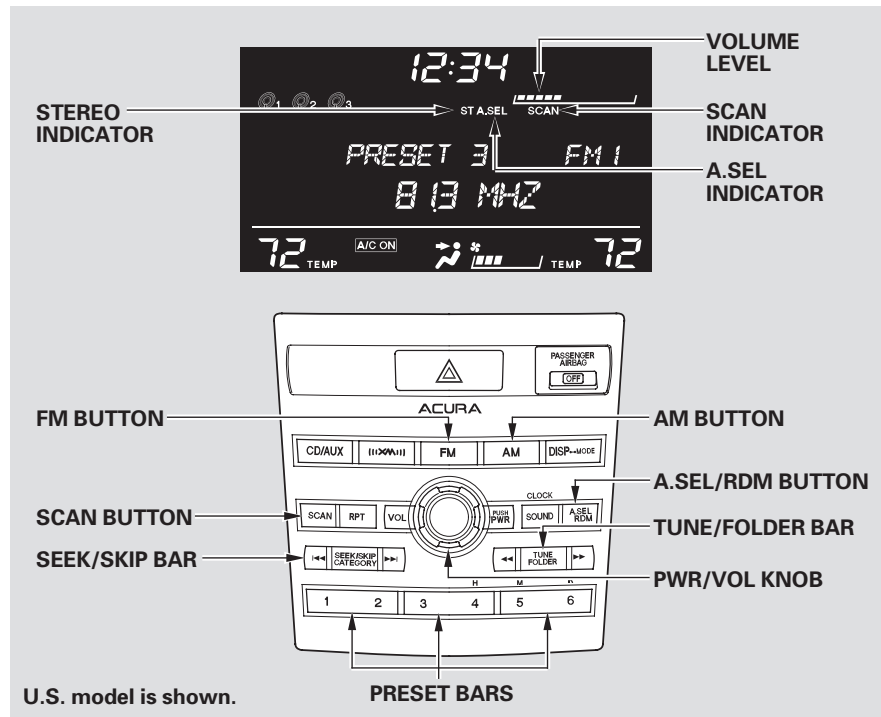

## To Select a Station

You can use any of five methods to find radio stations on the selected band: tune, seek, scan, the preset bars, and auto select.

**TUNE** — Use the TUNE/FOLDER bar to tune the radio to a desired frequency. Press the ►► side of the bar to tune to a higher frequency, and the ◀◀ side of the bar to tune to a lower frequency.

If you press and hold the ◀◀ or ►► side of the bar, the frequency will begin to change rapidly. It will stop when you release it.

**SEEK** — The SEEK function searches up and down from the current frequency to find a station with a strong signal. To activate it, press the ◀◀ or ►► side of the SEEK/SKIP bar, then release it.

**SCAN** — The SCAN function samples all stations with strong signals on the selected band. To activate it, press the SCAN button, then release it. You will see “SCAN” on the center display. The system will scan for a station with a strong signal. When it finds one, it will stop and play that station for about 10 seconds.

If you do nothing, the system will then scan for the next strong station and play it for 10 seconds. When it plays a station you want to listen to, press the SCAN button again.

**Preset** — Each side of the bars (1–6) can store one frequency on AM and two frequencies on FM.

1. Select the desired band, AM or FM. FM1 and FM2 let you store two frequencies with each side of the preset bar.
2. Use the TUNE, SEEK, or SCAN function to tune the radio to a desired station.
3. Pick the preset number (1–6), for the station you want to store. Press the left or right side of the bar, and hold it until you hear a beep.
4. Repeat steps 1 through 3 to store a total of six stations on AM and twelve stations on FM.

*CONTINUED*

## Audio System

---

**AUTO SELECT** — If you are traveling far from home and can no longer receive your preset stations, you can use the auto select feature to find stations in the local area.

To activate it, press the A. SEL/RDM button. “A. SEL” will flash on the center display, and the system will go into scan mode for several seconds. It stores the frequencies of six AM and twelve FM stations in the preset bars (1 – 6).

You will see “0” displayed if auto select cannot find a strong station for every preset bar.

If you do not like the stations auto select has stored, you can store other frequencies on the preset bars.

*To turn off auto select*, press the A. SEL/RDM button. This restores the presets you originally set.

### **Radio Frequencies and Reception**

For information on AM/FM radio frequencies and reception, see page [221](#) .

### **Adjusting the Sound**

For information, see page [186](#) .



## Operating the CD Changer

On RDX model

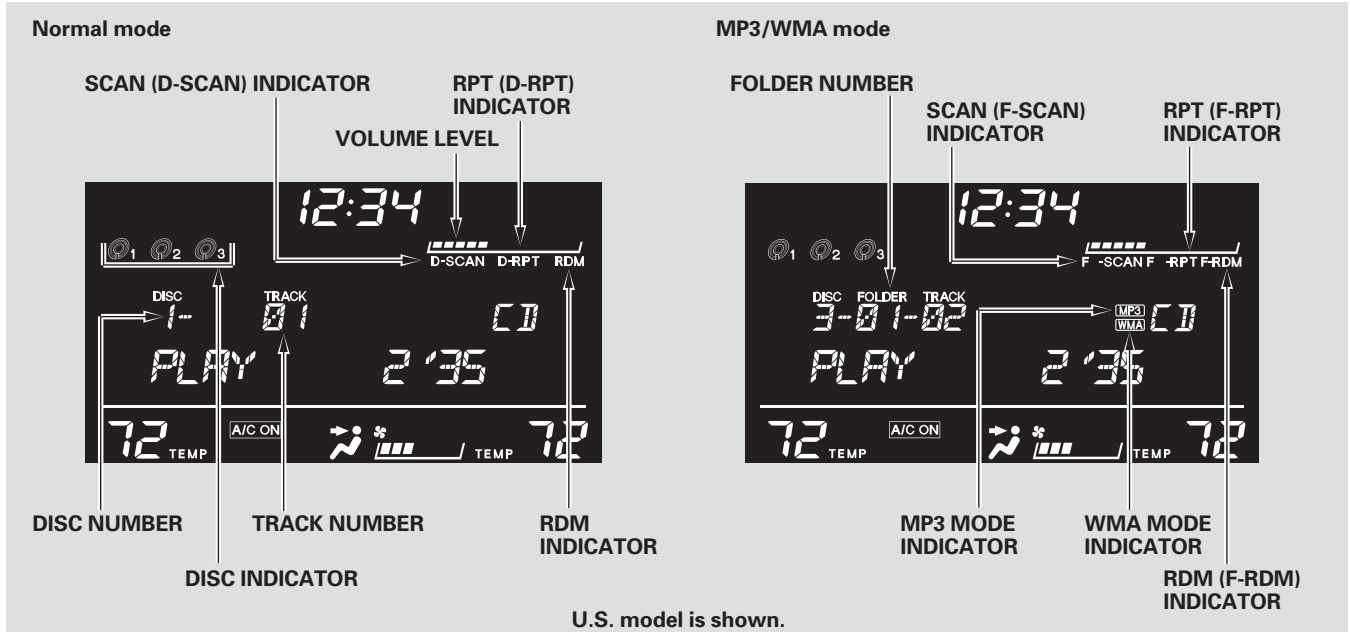

Features

CONTINUED

# Audio System

U.S. model is shown.

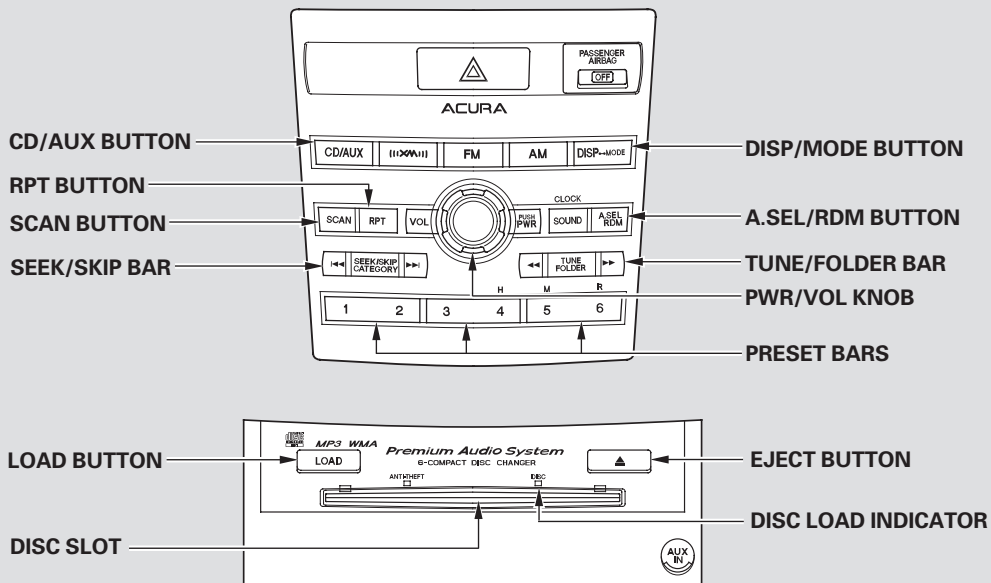

Your audio system has an in-dash CD changer that holds up to six CDs, providing several hours of continuous entertainment. You operate this CD changer with the same controls used for the radio.

To load CDs or operate the CD changer, the ignition switch must be in the ACCESSORY (I) or ON (II) position.

The disc changer can play these disc formats:

- CD (CD-DA)
- CD-R/RW

The disc packages or jackets should have one of these marks.



The changer can also play MP3 or WMA format (see page [177](#)).

For best results when using CD-R or CD-RW discs, use only high quality discs labeled for audio use. When recording a CD-R or CD-RW, the recording must be closed in order for the disc to be played by the CD player.

## NOTICE

*Do not use CDs with adhesive labels. The label can curl up and cause the CD to jam in the unit.*

You cannot load and play 3-inch (8-cm) discs in this system. Video CDs and DVDs will not work in this unit.

CONTINUED

## Audio System

---

### Loading CDs in the Changer

To load multiple discs in one operation:

1. Press and hold the LOAD button on the changer unit until you hear a beep. You will see “BUSY” on the center display, and disc load indicator turns red and starts blinking.
2. Insert the disc into the disc slot when the disc load indicator turns green and “LOAD” appears on the center display at the same time. Insert it only halfway; the drive will pull it in the rest of the way. You will see “BUSY” on the center display, and the disc load indicator turns red again and blinks as the CD is loaded.

3. When the disc load indicator turns green and “LOAD” appears on the center display again, insert the next CD in the slot.

Do not try to insert a disc until “LOAD” appears. You could damage the audio unit.

4. Repeat steps 1 through 3 until all six positions are loaded. If you are not loading all six positions, press the LOAD button again after the last CD has loaded. “DISC READ” appears on the center display, then the system begins playing the last CD loaded.

If you stop loading discs before all six positions are filled, the system will wait for 10 seconds, stop the load operation, and begin playing the last disc loaded.

To load a single disc:

1. Press and release the LOAD button on the changer unit. You will see “BUSY” on the center display, and the disc load indicator turns red and starts blinking.
2. Insert a disc into the disc slot when the disc load indicator turns green and “LOAD” appears on the center display at the same time. Insert the disc only about halfway; the drive will pull it in the rest of the way. You will see the disc indicator blinking on the center display.

Do not try to insert a disc until “LOAD” appears. You could damage the audio unit.

3. You will see “DISC READ” on the center display, then the system begins to play the CD.

You can load a CD into an empty position while a CD is playing. Select the empty position (the disc indicator is not shown on the center display) by pressing the appropriate side of the preset bars. The current CD stops playing and starts the loading sequence. The CD just loaded will play.

You can load a disc(s) in any mode (AM, FM, XM radio, or AUX) if you do not select an empty position.

If you press the LOAD button while a disc is playing, the system will stop playing that disc and start the loading sequence. It will then play the disc just loaded.

## To Play a CD

Select the CD changer by pressing the CD/AUX button. You will see “CD” on the center display. The system will begin playing the last selected CD in the CD changer. You will see the disc and track numbers displayed.

When the system reaches the end of the disc, the system will advance to the next disc and begin to play. To select a different disc, press an appropriate side of the preset bar (1 – 6). If you select an empty position in the CD changer, the system will try to load the CD in the empty slot.

## Playing an MP3/WMA Disc

The CD changer can play CD-Rs and CD-RWs compressed in MP3 and WMA format. When playing a disc in MP3 or WMA, you will see “MP3” or “WMA” on the center display. A disc can support more than 99 folders, and each folder can hold up to 255 playable files.

When there are more than 99 folders in a disc, the center display only shows two digits.

If the disc has a complex structure, it will take a while to read the disc before the system begins to play it.

*CONTINUED*

## Audio System

---

The specifications of the compatible MP3 file are:

Sampling frequency: 32/44.1/48 kHz  
(MPEG1), 24, 22.05, 16 kHz  
(MPEG2)

Bit rate: 32/40/48/56/64/80/96/  
112/128/160/192/224/256/320 kbps  
(MPEG1), 8/16/24/32/40/48/56/  
64/80/96/112/128/160 kbps  
(MPEG2)

Compatible with variable bit rate and multi-session.

Maximum layers  
(including ROOT): 8 layers

The specifications of the compatible WMA file are:

Sampling frequency: 32/44.1/48 kHz  
Bit rate: 48/64/80/96/128/160/192  
kbps

Compatible with variable bit rate and multi-session.

Maximum layers (including ROOT):  
8 layers

### ***Name Display Function***

Each time you press the DISP/MODE button while playing a CD (CD-DA), the center display changes from album name, to track name, to artist name, and then to normal display. If the disc was not recorded with CD-TEXT, “NO INFO” will be shown on the center display.

When playing a disc compressed in MP3/WMA format, the display changes from folder name, to file name, to artist tag, to album tag, to track tag, and then to normal display each time you press the DISP/MODE button. If the disc was not recorded with this information, “NO INFO” will be shown on the center display.

If the title is too long, it will not show all at once. Press and hold the DISP/MODE button, and the rest of the title will show on the center display.

You will also see the album and track name (CD-TEXT), or the folder and file name (MP3/WMA) under these conditions:

- When you insert a disc, and the system begins to play.
- Each time a new track, file, or folder plays.

### ***To Change or Select Tracks/Files***

While a disc is playing you can use the SEEK/SKIP bar to select passages and change tracks (files in MP3/WMA mode).

In MP3/WMA mode, use the TUNE/FOLDER bar to select folders in the disc, and use the SEEK/SKIP bar to change files.

**SEEK/SKIP** — Each time you press and release the ►► side of the SEEK/SKIP bar, the system skips forward to the beginning of the next track (file in MP3/WMA mode). Press and release the ◄◄ side of the bar to skip backward to the beginning of the current track/file. Press it again to skip to the beginning of the previous track/file.

To move rapidly within a track/file, press and hold the ►► or ◄◄ side of the SEEK/SKIP bar.

*In MP3/WMA mode*

**FOLDER SELECTION** — To select a different folder, press and release the ►► side of the TUNE/FOLDER bar to move to the beginning of the next folder. Press and release the ◄◄ side of the bar to move to the beginning of the current folder. Press it again to skip to the beginning of the previous folder.

**REPEAT** — This feature, when activated, continuously replays the current track (file in MP3/WMA mode). To activate it, press and release the RPT button. You will see “RPT” on the center display. To turn off this feature, press the RPT button for more than 2 seconds.

*CONTINUED*

## Audio System

---

*In MP3/WMA mode*

**FOLDER REPEAT** — This feature, when activated, replays all the files on the current folder in the order they are compressed in MP3/WMA. To activate folder repeat mode, press the RPT button twice. You will see “F-RPT” on the center display. Press and hold the RPT button for more than 2 seconds to turn off this feature.

**DISC REPEAT** — Press the RPT button twice to continuously replay the current CD. In MP3/WMA mode, press the RPT button three times. You will see “D-RPT” on the center display. Press and hold the RPT button for more than 2 seconds to turn off this feature.

Each time you press and release the RPT button, the mode changes from repeat to folder repeat, disc repeat then to normal playing.

**SCAN** — The scan function samples all the tracks (files in a folder in MP3/WMA mode) of the current disc in the order they are recorded on the CD. To activate this feature, press and release the SCAN button. You will see “SCAN” and the track/file number flashing on the center display. The system will then play the track/file for approximately 10 seconds. To hear the rest of the track/file, press and hold the SCAN button for more than 2 seconds. If you do nothing, the system will then play the following tracks/files for 10 seconds each. When the system finishes scanning all the tracks/files in the current disc, the system returns to the track/file it first started scanning with, scan is canceled and the system begins to play that track/file normally.

*In MP3/WMA mode*

**FOLDER SCAN** — The folder scan function samples the first file of each folder of the current disc in the order they are compressed in MP3/WMA. To activate this feature, press the SCAN button twice. The first file of each folder plays for about 10 seconds. You will see “F-SCAN” and the folder number flashing on the center display. To hear the rest of the file in the folder currently scanning, press and hold the SCAN button for more than 2 seconds. When the system finishes scanning all the folders of the current disc, the system returns to the folder it started scanning with, folder scan is canceled and the system begins to play that folder normally.



**DISC SCAN** — The disc scan function samples the first track (file in MP3/WMA mode) of each disc within the changer in numerical order. To activate this feature, press the SCAN button twice. In MP3/WMA mode, press the SCAN button three times. The first track/file of each disc plays for about 10 seconds. You will see “D-SCAN” and disc number flashing on the center display. To hear the rest of the track/file in the disc currently scanning, press and hold the SCAN button for more than 2 seconds. When the system finishes scanning all the discs, disc scan is canceled and the system begins to play the first track/file of that disc normally.

Each time you press and release the SCAN button, the mode changes from scan to folder scan, disc scan then to normal playing.

**RANDOM (Random within a Disc)** — This feature plays the tracks (all files in each folder in MP3/WMA mode) within a disc in random order. To activate it, press and release the A. SEL/RDM button. In MP3/WMA mode, press the A. SEL/RDM button twice to select within a disc random play. You will see “RDM” on the center display. Press and hold the A. SEL/RDM button for more than 2 seconds to return to normal play.

*In MP3/WMA mode*

**FOLDER RANDOM** — This feature plays the files within a folder in random order, rather than in the order they are compressed in MP3/WMA. To activate it, press the A. SEL/RDM button once. You will see “F-RDM” on the center display. The system will then select and play files randomly. This continues until you deactivate folder random play by pressing and holding the RDM button for more than 2 seconds.

Each time you press and release the A. SEL/RDM button, the mode changes from folder random to random, then to normal playing.

## Audio System

---

### To Pause a Disc

To pause a disc, press the corresponding number of the current disc on the appropriate side of the preset bars. To play the disc again, press the preset bar again.

### To Stop Playing a Disc

If you turn the system off while a CD is playing, either with the PWR/VOL knob or by turning off the ignition switch, the disc will stay in the drive. When you turn the system back on, the CD will begin playing where it left off.

To take the system out of CD mode, press the AM or FM, CD/AUX, or «(X/M)» button. To return to CD mode, press the CD/AUX button. The system will continue at the same point that it left off.

### Removing CDs from the Changer

To remove the disc that is currently playing, press and release the eject (▲) button. You will see “EJECT” on the center display. When you remove the disc from the slot, the system begins the load sequence so you can load another disc in that position. If you do not load another CD within 10 seconds, the system selects the previous mode (AM, FM1, FM2, or XM Radio).

If you do not remove the CD from the slot, the system will reload the CD after 10 seconds and put the CD changer in pause mode. To begin playing the CD, press the CD/AUX button.

To remove a different CD from the changer, select it with the appropriate side of the preset bar. When that CD begins playing, press the eject button.

Press and hold the eject button until you hear a beep to remove all the discs from the changer.

You can also eject discs when the ignition switch is off by pressing the eject button. The disc that was last selected is ejected first. You can eject the rest of the discs one at a time.

### Protecting Discs

For information on how to handle and protect compact discs, see page [223](#).

### CD Changer Error Messages

For information, see page [226](#).

### Adjusting the Sound

For information, see page [186](#).

## XM® Satellite Radio

*On RDX model*

Your vehicle is capable of receiving XM® Satellite Radio anywhere in the United States, and Canada, except Hawaii and Alaska. XM® is a registered trade mark of XM Satellite Radio, Inc.

XM Satellite Radio receives signals from two satellites to produce clear, high-quality digital reception. It offers many channels in several categories. Along with a large selection of different types of music, XM Satellite Radio also allows you to view channel and category selections on the center display.

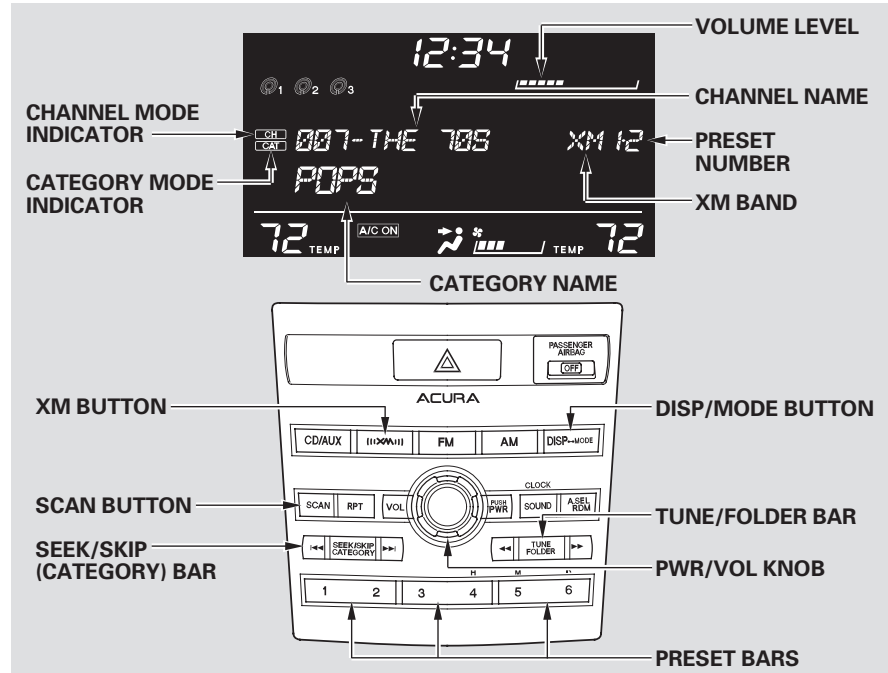

CONTINUED

## Audio System

---

### Operating the XM Radio

To listen to the XM satellite Radio, turn the ignition switch to the ACCESSORY (I) or ON (II) position. Push the PWR/VOL knob to turn on the audio system, and press the «» button. Adjust the volume by turning the PWR/VOL knob. The last channel you listened to will show on the center display.

**DISP** — Each time you press and release the DISP/MODE button, the center display changes in the following sequence: Channel name, category, artist name, and music title.

**MODE** — To switch between the category mode and channel mode, press and hold the DISP/MODE button until the mode changes. “CH (channel)” or “CAT (category)” mode indicator appears on the center display.

### To Select a Channel

When in the satellite radio mode, you can use any of four methods to find channels: TUNE, SEEK/SKIP (CATEGORY), SCAN, and the preset bars.

**TUNE** — Press the TUNE/FOLDER bar to change channel selections. Press the ►► side of the bar to tune to higher numbered channels, and the ◀◀ side of the bar to tune to lower numbered channels. In the category mode, you can only select channels within that category.

**SEEK/SKIP (CATEGORY)** — Press either side of the SEEK/SKIP (CATEGORY) bar (◀◀ or ►►) to select another category.

**SCAN** — The scan function gives you a sampling of all channels while in the channel mode. In the category mode, only the channels within that category are scanned. To activate scan, press the SCAN button. The system plays each channel in numerical order for a few seconds, then selects the next channel. When you hear a channel you want to continue listening to, press the button again.

**Preset** — You can store up to 12 preset channels using each side of the preset bar. Each side of the bar stores one channel from the XM1 band and one channel from the XM2 band.

To store a channel:

1. Press the «**⏮**» button. Either XM1 or XM2 will be shown on the center display.
2. Use the tune, seek, or scan function to tune to a desired channel.

In category mode, only channels within that category can be selected. In channel mode, all channels can be selected.

3. Pick a preset number for the channel you want to store. Press and hold the appropriate side of the preset bar until you hear a beep.
4. Repeat steps 2 and 3 to store the first six channels.
5. Press the «**⏮**» button again. The other XM band will be shown. Store the next six channels by repeating steps 2 and 3.

Once a channel is stored, press and release the proper side of the preset bar to tune to it.

## **Adjusting the Sound**

For information, see page [186](#).

## **XM Satellite Radio Reception**

For information, see page [228](#).

# Audio System

## Adjusting the Sound

*On RDX model*

Press the SOUND/CLOCK button repeatedly to display the BASS, TREBLE, FADER, BALANCE, SUBWOOFER and SVC (speed-sensitive volume compensation) settings.

Each mode is shown on the center display as it changes. Turn the PWR/VOL knob to adjust the setting to your liking. When the level reaches the center, you will see “ $\square$ ” on the center display. The system will automatically return the display to the selected audio mode about 5 seconds after you stop adjusting a mode.

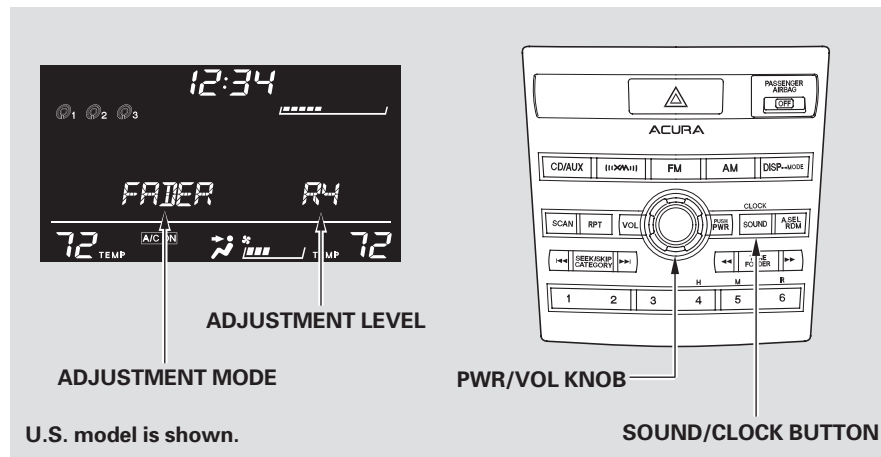

**Treble/Bass** — Use the TREBLE/BASS modes to adjust the tone to your liking. You can adjust each mode in levels between  $-6$  and  $+6$ .

**Balance/Fader** — These two modes adjust the strength of the sound coming from each speaker. BALANCE adjusts the side-to-side

strength, while FADER adjusts the front-to-back strength. BALANCE can be adjusted in levels between L9 and R9. FADER can be adjusted in levels between F9 and R9. When FADER adjustment level reaches F9, the subwoofer speaker will be turned off.

**SUBWOOFER** – Use the SUBWOOFER mode to adjust the strength of the sound from the subwoofer speaker. Turn the PWR/VOL knob to the desired level (–6 to +6). Even if the adjustment level reaches –6, the subwoofer is not turned off.

**Speed-sensitive volume compensation (SVC)** – The SVC mode controls the volume based on vehicle speed. The faster you go, the louder the audio volume becomes. As you slow down, the audio volume decreases.

The SVC has four modes; SVC OFF, SVC LOW, SVC MID, and SVC HIGH. The default setting is MID. Turn the PWR/VOL knob to adjust the setting to your liking.

### Audio System Lighting

You can use the instrument panel brightness control knob to adjust the illumination of the audio system (see page 117 ). The audio system illuminates when the parking lights are on, even if the system is turned off.

## Audio System

### Setting the Clock

*On RDX model*

To set the time, press the SOUND/CLOCK button until you hear a beep, then release the button. The displayed time begins to blink.

Change the hour by pressing the H (preset 4) side of the preset bar until the numbers advance to the desired time. Change the minute by pressing the M (preset 5) side of the bar until the numbers advance to the desired time.

You can quickly set the time to the nearest hour. If the displayed time is before the half hour, pressing the SOUND/CLOCK button until you hear a beep, then pressing the R (preset 6) side of the preset bar sets the clock back to the previous hour. If the displayed time is after the half hour, the clock sets forward to the beginning of the next hour.

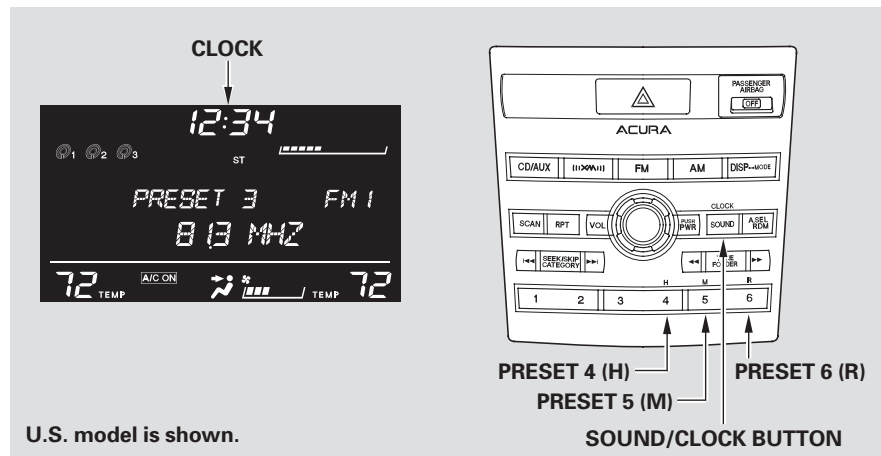

When you are finished, press the SOUND/CLOCK button again to set the time.



## Interface Dial

*On RDX with Technology Package model*

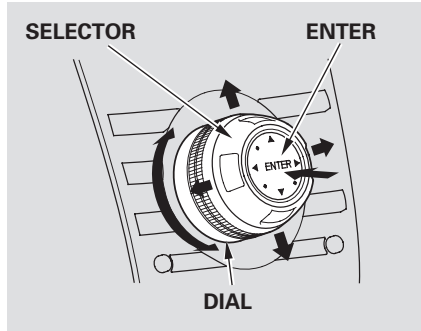

Your vehicle has the interface dial on the dashboard to operate the audio system and navigation system. Most functions of these systems can also be controlled with the appropriate buttons on the dashboard, but some functions can be accessed or selected with the interface dial only.

This dial consists of an upper part (selector) and a lower part (dial). Turning the dial left or right to select or scroll through a list or item(s) on the navigation display and adjust the level or condition. Push the selector to the left, right, up, and down to scroll through and select a list or item(s). The selected item will be highlighted on the display. To confirm the item or enter the setting, push on the center of the selector (ENTER).

When you operate the audio system with the interface dial, press the AUDIO button on the control panel to show the audio control display on the navigation display. You can scroll the display and enter the setting with the interface dial. You will see the indicator ▲, ▼, ►, or ◀ on the display. This indicates the direction to move the interface dial.

You can operate the audio system with the control buttons on the CD changer unit without displaying the audio control display on the navigation display. The audio setting will be shown on the upper display.

## Voice Control System

The audio system for your vehicle can also be operated by voice control. See the navigation section in your quick start guide for an overview of this system, and the navigation system manual for complete details.

# Audio System

## To Play the AM/FM Radio

*On RDX with Technology Package model*

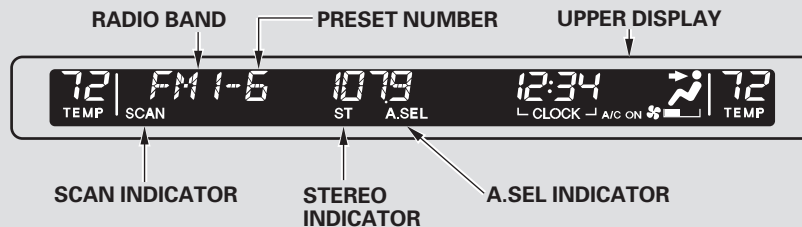

SCAN INDICATOR

STEREO INDICATOR

A.SEL INDICATOR

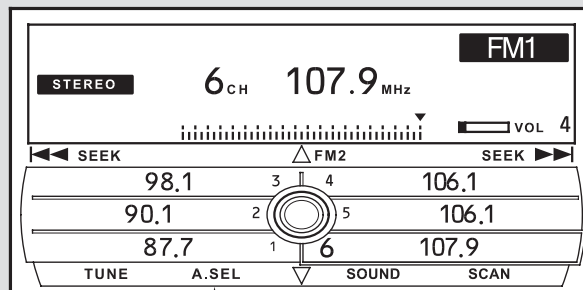

AUDIO CONTROL DISPLAY

U.S. model is shown.

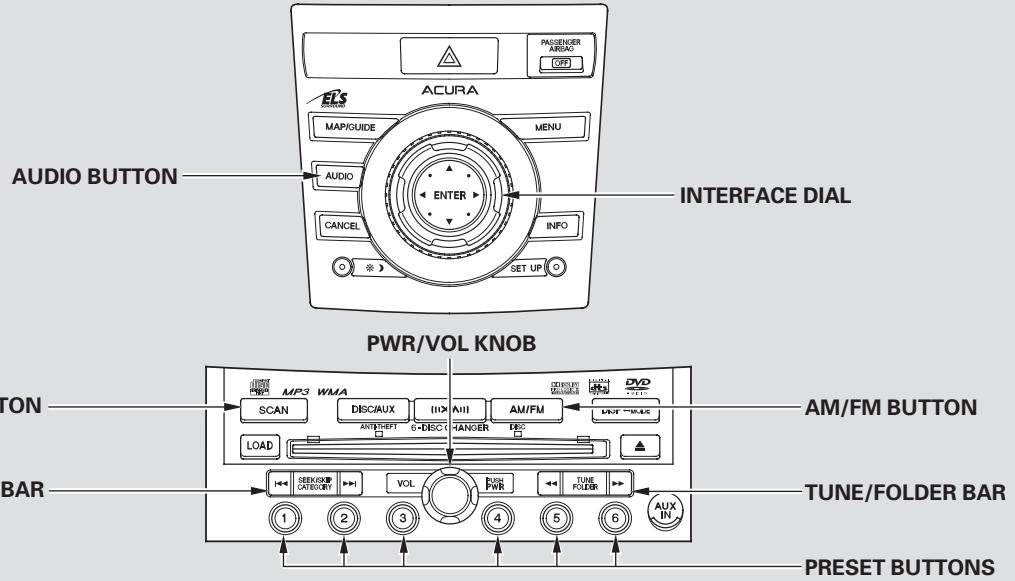

U.S. model is shown.

CONTINUED

## Audio System

The ignition switch must be in the ACCESSORY (I) or the ON (II) position. Press the AUDIO button to view the audio control display. Turn the system on by pressing the PWR/VOL knob or the AM/FM button. Adjust the volume by turning the PWR/VOL knob.

The band and frequency the radio was last tuned to are shown on the upper display. To change bands, press the AM/FM button. You can also change bands with the interface dial. Press the AUDIO button to view the audio control display and the band changes to FM1, FM2, or AM each time you push the selector up. On the FM bands, “STEREO” will be shown on the audio control display. “ST” will also appear on the upper display if the station is broadcasting in stereo. Stereo reproduction on AM is not available.

XM satellite radio information is available on page 211.

### To Select a Station

You can use any of five methods to find radio stations on the selected band: TUNE, SEEK, SCAN, the preset buttons or icons, and AUTO SELECT.

**TUNE** — Use the TUNE/FOLDER bar to tune the radio to a desired frequency. Press the ►► side of the bar to tune to a higher frequency, and the ◀◀ side of the bar to tune to a lower frequency.

If you press and hold the ◀◀ or ►► side of the bar, the frequency will begin to change rapidly. It will stop when you release it.

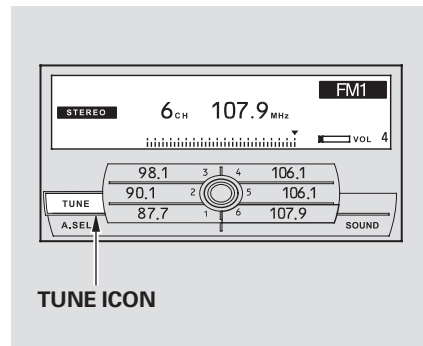

To tune with the interface dial, press the AUDIO button to view the audio control display, then push the selector down, and turn the dial to TUNE. Then press ENTER on the selector, and turn the dial to the desired frequency. To exit the TUNE mode, press ENTER again.

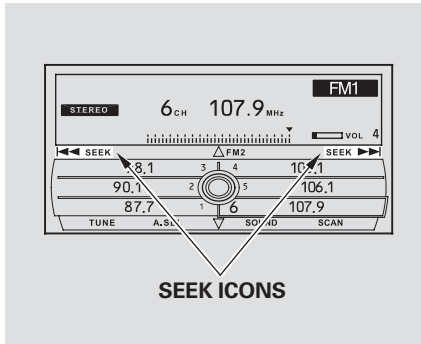

**SEEK** – The SEEK function searches up and down from the current frequency to find a station with a strong signal. To activate it, press the ◀◀ or ▶▶ side of the SEEK/SKIP bar, then release it.

To activate the seek function with the interface dial, press the AUDIO button to view the audio control display, then push the selector on the interface dial to the right or left.

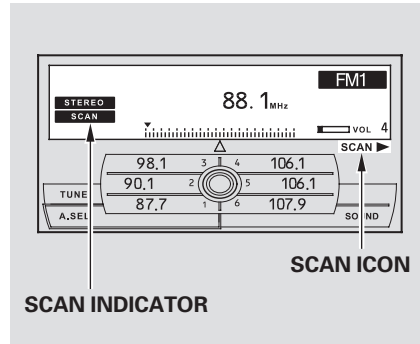

**SCAN** – The SCAN function samples all stations with strong signals on the selected band. To activate it, press the SCAN button, then release it. You will see “SCAN” on the upper display.

To activate the scan function with the interface dial, press the AUDIO button to view the audio control display, then push down the selector on the interface dial, and push the selector to the right. You will see “SCAN” on the audio control display.

The system will scan for a station with a strong signal. When it finds one, it will stop and play that station for about 10 seconds. If you do nothing, the system will then scan for the next strong station and play it for 10 seconds. When it plays a station that you want to listen to, press the SCAN button again, or push the interface selector to the right again.

*CONTINUED*

## Audio System

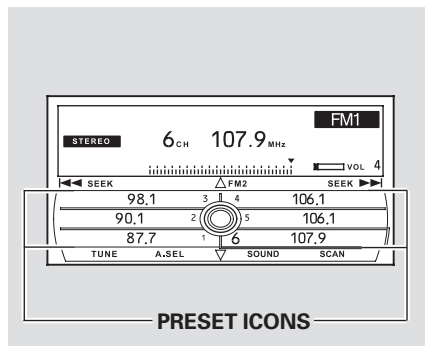

**Preset** — Each preset button/icon can store one frequency on AM and two frequencies on FM. To view the preset icons on the audio control display, push the AUDIO button.

1. Select the desired band, AM or FM. FM1 and FM2 let you store two sets of FM frequencies with the preset buttons (on-screen icons).
2. Use the TUNE, SEEK, or SCAN function to tune the radio to a desired station.
3. Pick a preset number (1–6), you want for that station. Press the preset button, and hold it until you hear a beep.

To store the frequency on a preset icon, turn the interface dial to select a desired preset icon. The selected preset icon will be highlighted. Press and hold ENTER on the selector for more than 2 seconds to store the frequency.

4. Repeat steps 1 through 3 to store a total of six stations on AM and twelve stations on FM.

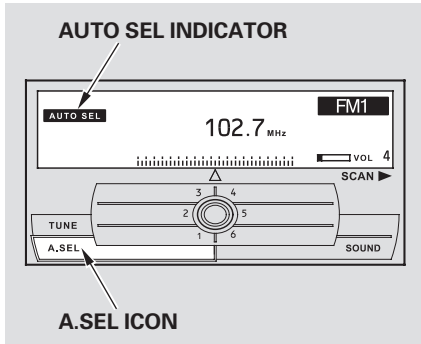

**AUTO SELECT** – If you are traveling far from home and can no longer receive your preset stations, you can use the auto select feature to find stations in the local area.

To activate AUTO SELECT, press the AUDIO button to view the audio control display. Push the interface selector down to scroll down the display, turn the dial to A. SEL, then press ENTER on the interface selector. You will see “AUTO SEL” flashing in the audio control display, and “A. SEL” on the upper display. Then, the system goes into scan mode for several seconds.

The system stores the frequencies of six AM and twelve FM stations in the preset buttons.

You will see “0” displayed if auto select cannot find a strong station for every preset button.

If you do not like the stations auto select has stored, you can store other frequencies on the preset buttons (icons) as previously described.

To turn off auto select, press ENTER on the interface selector again. This restores the presets you originally set.

## Radio Frequencies and Reception

For information on AM/FM radio frequencies and reception, see page [221](#).

## Adjusting the Sound

For information, see page [217](#).

# Audio System

## Operating the CD Changer

On RDX with Technology Package model

### Normal mode

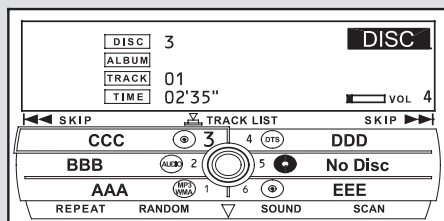
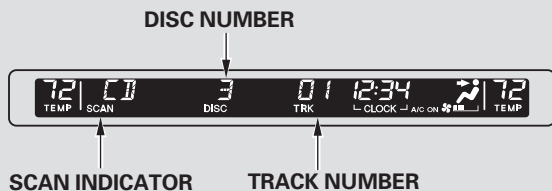

### MP3/WMA mode

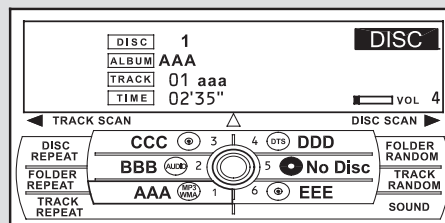
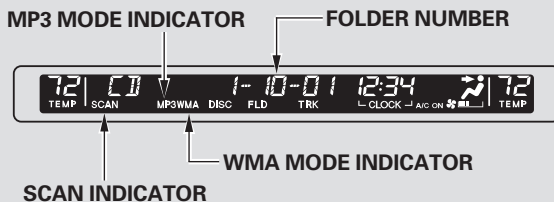

U.S. model is shown.



U.S. model is shown.

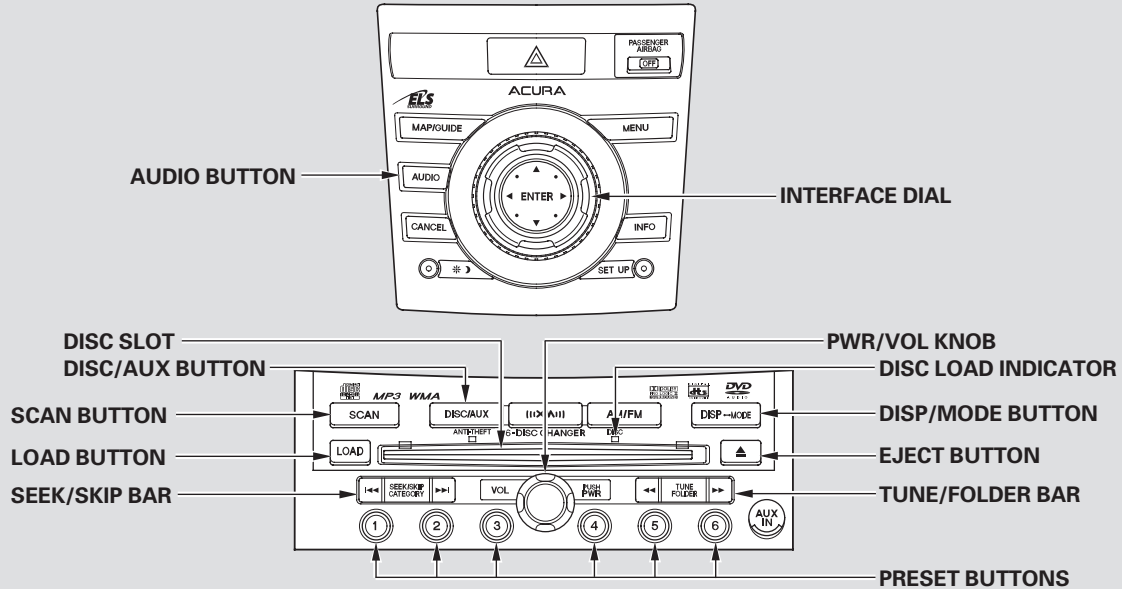

CONTINUED

## Audio System

Your vehicle's audio system has an in-dash disc changer with the same controls used for the radio. To operate the disc changer, the ignition switch must be in the ACCESSORY (I) or the ON (II) position.

The disc changer can play these disc formats:

- CD (CD-DA)
- CD-R/RW
- DVD-A
- DTS™

The disc packages or jackets should have one of these marks.



The changer can also play MP3 or WMA format (see page 202).

DVD-A discs not meeting DVD verification standards may not be playable.

The changer cannot play DVD-V or DVD-R/RW formats.

Some CD-DA and CD-ROM mixed discs are not playable.

“DTS” and “DTS Digital Surround” are registered trademarks of Digital Theater Systems, Inc.

You cannot load and play 3-inch (8-cm) discs in this system.

### NOTICE

*Do not use discs with adhesive labels. The label can curl up and cause the disc to jam in the unit.*

## Loading CDs in the Changer

To load multiple discs in one operation:

1. Press and hold the LOAD button on the changer unit until you hear a beep. You will see “BUSY” on the upper display, and the disc load indicator turns red and starts blinking.
2. Insert the disc into the disc slot when the disc load indicator turns green and “LOAD” appears in the upper display at the same time. Insert it only halfway; the drive will pull it in the rest of the way. You will see “BUSY” on the upper display, and the disc load indicator turns red again and blinks as the CD is loaded.
3. When the disc load indicator turns green and “LOAD” appears on the upper display again, insert the next CD in the slot.

Do not try to insert a disc until “LOAD” appears. You could damage the audio unit.

4. Repeat steps 1 through 3 until all six positions are loaded. If you are not loading all six positions, press the LOAD button again after the last CD has loaded. “DISC READ” appears on the upper display, then the system begins playing the last loaded.

If you stop loading discs before all six positions are filled, the system will wait for 10 seconds, stop the load operation, and begin playing the last disc loaded.

To load a single disc:

1. Press and release the LOAD button on the changer unit. You will see “BUSY” on the upper display, and the disc load indicator turns red and starts blinking.

2. Insert a disc into the disc slot when the disc load indicator turns green, and “LOAD” appears on the upper display at the same time. Insert the disc only about halfway; the drive will pull it in the rest of the way. You will see the disc number blinking on the upper display, and the disc load indicator turns red again and blinks as the CD is loaded.

Do not try to insert a disc until “LOAD” appears. You could damage the audio unit.

3. You will see “DISC READ” on the upper display, then the system begins to play the CD.

*CONTINUED*

## Audio System

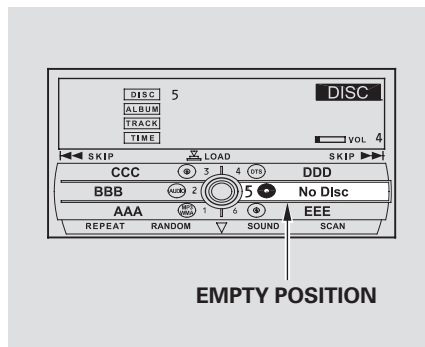

You can load a CD into an empty position while a CD is playing. Press the AUDIO button to view the audio control display. Select the empty position (“No Disc” is shown on the audio control display) by rotating the interface dial. Then press ENTER on the selector to enter your selection. The current CD stops playing and starts the loading sequence. The CD just loaded will play.

You can also select the empty position by pressing the appropriate preset button.

You can load a disc(s) in any mode (AM, FM, XM radio, or AUX) if you do not select an empty position.

You cannot select the empty position if there is no disc in the changer.

## To Play a Disc

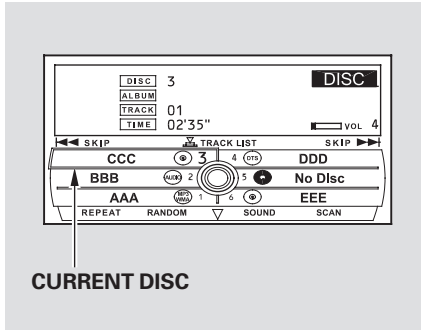

Select the changer by pressing the DISC/AUX button. You will see the “CD” on the upper display. The system will begin playing the last selected CD in the CD changer.

If you want to see the list of the discs in the CD changer, press the AUDIO button to view the audio control display. You will see the current disc position highlighted.

When playing a CD (CD-DA), the audio control display shows disc number, album name, track number, and elapsed time. When playing a CD without this information, the number of the disc and track playing and the elapsed time are shown on the audio control display.

When the system reaches the end of the disc, it will advance to the beginning of the first track/file (in MP3/WMA mode) in the next disc, then play that track/file.

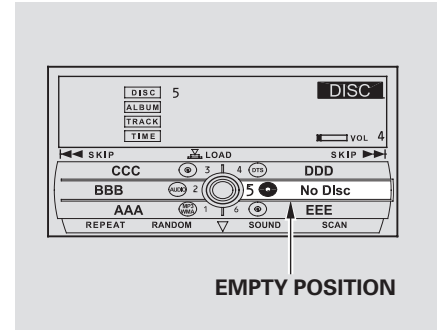

To select a disc, press an appropriate preset button (1–6), or select an appropriate preset icon by rotating the interface dial, then press ENTER on the interface selector. If you select an empty position (“No Disc” is shown) in the CD changer, the system will load a CD into the empty slot (see page 199).

## Audio System

---

### Playing an MP3/WMA Disc

The CD changer can also play CD-Rs and CD-RWs compressed in MP3 and WMA format. When playing a disc in MP3 or WMA, you will see “MP3” or “WMA” on the upper display. A disc can support more than 99 folders, and each folder can hold up to 255 playable files.

When there are more than 99 folders in a disc, the upper display only shows two digits.

When playing a CD compressed in MP3/WMA format, the audio control display shows disc number, folder name, file number, and elapsed time. When playing a CD without this information, the disc number, track number, and the elapsed time are shown on the audio control display.

If the disc has a complex structure, it will take a while to read the disc before the system begins to play it.

The specifications of the compatible MP3 file are:

Sampling frequency: 32/44.1/48 kHz  
(MPEG1), 24, 22.05, 16 kHz  
(MPEG2)

Bit rate: 32/40/48/56/64/80/96/  
112/128/160/192/224/256/320 kbps  
(MPEG1), 8/16/24/32/40/48/56/  
64/80/96/112/128/160 kbps  
(MPEG2)

Compatible with variable bit rate and multi-session.

Maximum layers  
(including ROOT): 8 layers

The specifications of the compatible WMA file are:

Sampling frequency: 32/44.1/48 kHz  
Bit rate: 48/64/80/96/128/160/192  
kbps

Compatible with variable bit rate and multi-session.

Maximum layers (including ROOT):  
8 layers

## *To Change or Select Tracks/Files*

While a disc is playing you can use the SEEK/SKIP bar to select passages and change tracks (files in MP3/WMA mode).

In MP3/WMA mode, use the TUNE/FOLDER bar to select folders in the disc, and use the SEEK/SKIP bar to change files.

**SEEK/SKIP** — Each time you press and release the ►► side of the SEEK/SKIP bar, the system skips forward to the beginning of the next track (file in MP3/WMA mode). Press and release the ◄◄ side of the bar to skip backward to the beginning of the current track/file. Press it again to skip to the beginning of the previous track/file.

To move rapidly within a track/file, press and hold the ◄◄ or ►► side of the SEEK/SKIP bar.

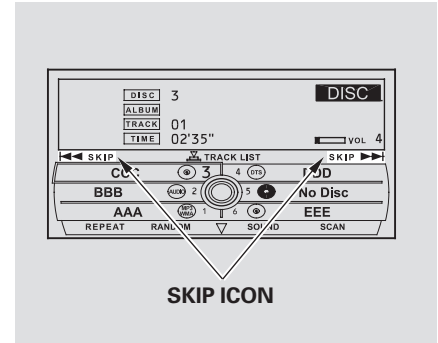

You can also change tracks/files on the audio control display. Press the AUDIO button to view the display, then push the selector on the interface dial to the right to skip forward to the beginning of the next track/file. Push the selector left to skip backward to the beginning of the current track/file. Press it again to skip to the beginning of the previous track/file.

*CONTINUED*

## Audio System

*In MP3/WMA mode*

**FOLDER SELECTION** – To select a different folder, press and release the ► side of the TUNE/FOLDER bar to move to the beginning of the next folder. Press and release the ◀ side of the bar to move to the beginning of the current folder. Press it again to skip to the beginning of the previous folder.

### *Using a Track List*

You can also select a track/file (in MP3/WMA) directly from the track list on the audio control display. Press the AUDIO button to view the display, then rotate the interface dial to the current disc. Press ENTER on the selector to view the track list on the display. The current disc is highlighted.

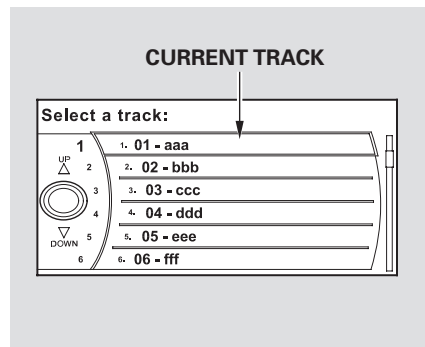

To select a track, rotate the interface dial or push up and down the selector on the interface dial. Then press ENTER on the selector to enter your selection.

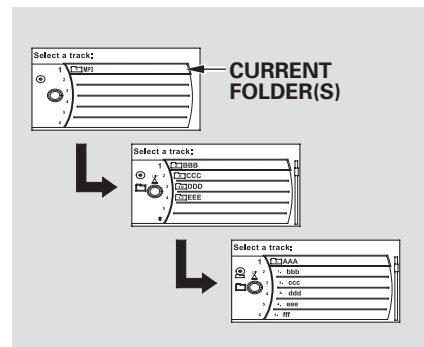

*In MP3/WMA mode*

You will see a list of the folder(s) in the current disc. To select a folder(s), rotate the interface dial or push up and down the selector on the interface dial. Then press ENTER on the selector to enter your selection. If the disc has several folders, the list advances to the next folder. When the list of the files is displayed, select it by rotating the dial, or pushing the selector up and down.



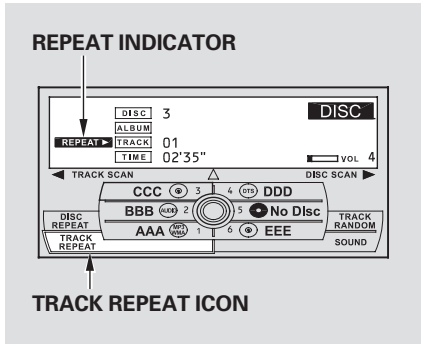

**REPEAT** – This feature, when activated, continuously replays the current track (file in MP3/WMA mode). To activate it, press the AUDIO button to view the display, then push down the selector on the interface dial. Rotate the interface dial to select track repeat. Press ENTER on the selector to enter your selection.

You will see “REPEAT” next to the TRACK icon on the audio control display. To turn off this feature, select track repeat as previously described, then press ENTER again.

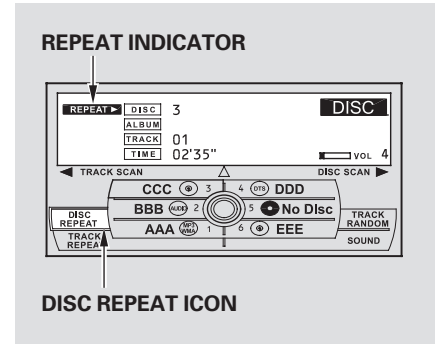

**DISC REPEAT** – This feature, when activated, continuously replays the current CD. Press the AUDIO button to view the audio control display, then push down the selector on the interface dial. Rotate the interface dial to select the disc repeat. Press ENTER on the selector to enter your selection. You will see “REPEAT” next to the DISC icon on the audio control display. To turn off this feature, select the disc repeat, then press ENTER again.

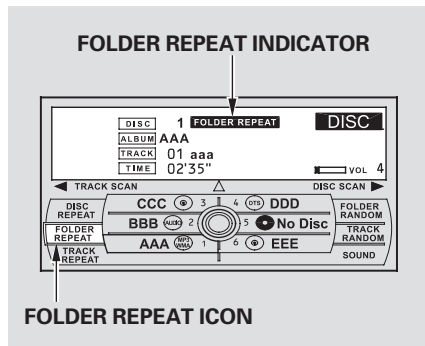

*In MP3/WMA mode*  
**FOLDER REPEAT** – This feature, when activated, replays all the files on the selected folder in the order they are compressed in MP3/WMA. To activate folder repeat, press the AUDIO button to view the display, then push down the selector on the interface dial, then push down the selector on the interface dial to select folder repeat. Press ENTER on the selector to enter your selection.

You will see “FOLDER REPEAT” on the audio control display. To turn off this feature, select folder repeat, then press ENTER again.

**SCAN** – The scan function samples all the tracks/files (in MP3/WMA mode) of the current disc/folder in the order they are recorded on the CD. To activate this feature, press and release the SCAN button. You will also see “SCAN” and the track/file number blinking on the upper display. To hear the rest of the track/file, press and hold the SCAN button for more than 2 seconds. If you don’t, the system advances to the next tracks/files, plays about 10 seconds of it, and continues through the rest of the track/file the same way. When the system finishes scanning all the tracks/files in the current disc, the system returns to the track/file it first started scanning with, scan is canceled, and the system begins to play that track/file

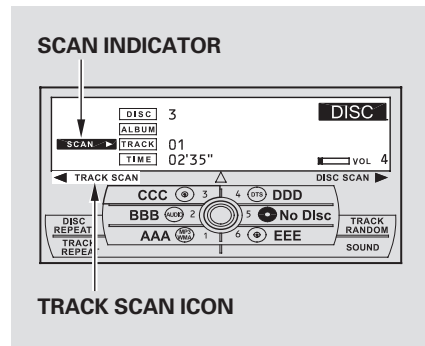

normally.

To activate scan feature on the audio control display, press the AUDIO button to view the display. Push down the selector on the interface dial, then push the selector to the left. You will see “SCAN” next to the TRACK icon on the audio control display. To turn off this feature, push the selector to the left again within 10 seconds.

*In MP3/WMA mode*

**FOLDER SCAN** – The folder scan function samples the first file of each folder in the current disc in the order they are compressed in MP3/WMA. To activate this feature, press the SCAN button twice. The first file of each folder plays for about 10 seconds. You will see “FOLDER SCAN” next to disc number on the audio control display. You will also see “SCAN” and the folder number blinking on the upper display. To hear the rest of the file in the folder currently scanning, press and hold the SCAN button for more than 2 seconds.

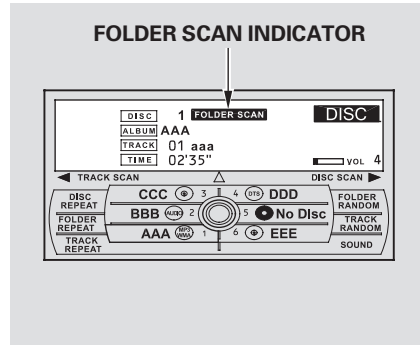

If you don't, the system advances to the next folder, plays about 10 seconds of it, and continues through the rest of the folders the same way. When the system finishes scanning all the folders of the current disc, the system returns to the folder it started scanning with, folder scan is canceled and the system begins to play that folder normally.

**DISC SCAN** – The disc scan function samples the first track/file (in MP3/WMA mode) of each disc within the changer in numerical order. To activate this feature, press the SCAN button twice. In the MP3/WMA mode, press the SCAN button three times. The first track/file of each disc plays for about 10 seconds. You will see “SCAN” next to the DISC icon on the audio control display. You will also see “SCAN” and the disc number blinking on the upper display. To hear the rest of the track/file in the disc currently scanning, press and hold the SCAN button for more than 2 seconds.

CONTINUED

## Audio System

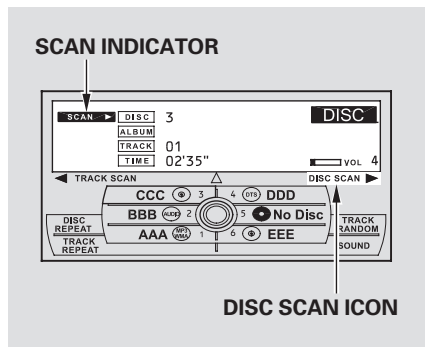

If you don't, the system advances to the next disc, plays about 10 seconds of it, and continues through the rest of the discs the same way. When the system finishes scanning all the discs, disc scan is canceled and the system begins to play the first track/file of that disc normally.

Each time you press and release the SCAN button, the mode changes from scan to folder scan, disc scan then to normal playing.

**RANDOM (Random within a disc)** – This feature plays the tracks (all files in each folder in MP3/WMA mode) within a disc in random order. To activate random play, press the AUDIO button to view the audio control display, then push down the selector on the interface dial. Rotate the interface dial to select random. Press ENTER on the selector to enter your selection.

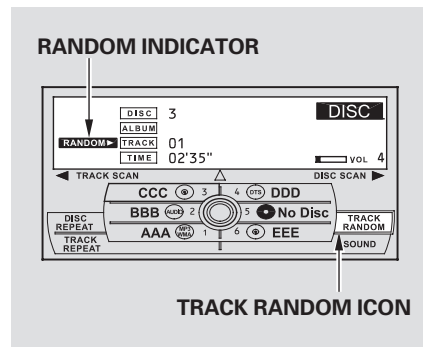

You will see "RANDOM" next to the TRACK/FILE icon on the audio display. To turn off this feature, select random, then press ENTER again.

*In MP3/WMA mode*

**FOLDER RANDOM** – This feature plays the files within a folder in random order, rather than in the order they are compressed in MP3/WMA. To activate folder random play, press the AUDIO button to view the audio control display, then push down the selector on the interface dial. Rotate the interface dial to select the folder random. Press ENTER on the selector to enter your selection.

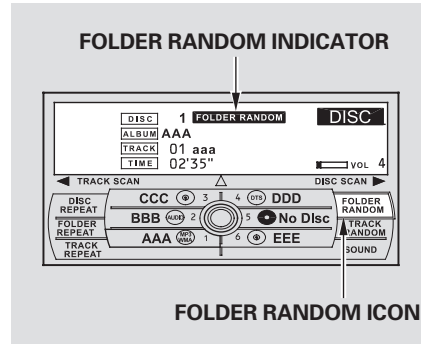

You will see “FOLDER RANDOM” on the audio control display. To turn off this feature, select the folder random then, press ENTER again.

## Playing a DVD-A Disc

You can play a DVD-A disc in the CD changer. The disc controls are same as previously described.

## To Pause a Disc

To pause a disc, press the preset button which corresponds to the current disc. To play the disc again, press the preset button again.

You can also pause a disc on the audio control display. Press the AUDIO button to view the display, select the corresponding number of the current disc on the preset icons by turning the interface knob, then press ENTER on the interface selector. To play the disc again, select the preset icon, then press ENTER again.

## Audio System

---

### To Stop Playing a Disc

If you turn the system off while a CD is playing, either with the PWR/VOL knob or by turning off the ignition switch, the disc will stay in the drive. When you turn the system back on, the CD will begin playing where it left off.

To take the system out of CD mode, press the AM/FM, or DISC/AUX, or «» button to switch to the radio, or satellite radio, or auxiliary input while a CD is playing. When you return to CD mode by pressing the DISC/AUX button, play will continue at the same point that it left off.

### Removing CDs from the Changer

To remove the disc that is currently playing, press and release the eject (▲) button. You will see “EJECT” on the upper display. When you remove the disc from the slot, the system begins the load sequence so you can load another disc in that position. If you do not load another disc within 10 seconds, the system selects the previous mode (AM, FM1, FM2, or XM Radio).

If you do not remove the disc from the slot, the system will reload the disc after 10 seconds and put the CD changer in pause mode. To begin playing the disc, press the DISC/AUX button.

To remove a different CD from the changer, select it with the appropriate preset button, or icon on the audio control display. When that disc begins playing, press the eject button.

Press and hold the eject button until you hear a beep to remove all the discs from the changer.

You can also eject discs when the ignition switch is off by pressing the eject button. The disc that was last selected is ejected first. You can eject the rest of the discs one at a time.

### Protecting Discs

For information on how to handle and protect compact discs, see page [223](#).

### CD Changer Error Messages

For information, see page [226](#).

### Adjusting the Sound

For information, see page [217](#).

## XM® Satellite Radio

On RDX with Technology Package model only

U.S. model is shown.

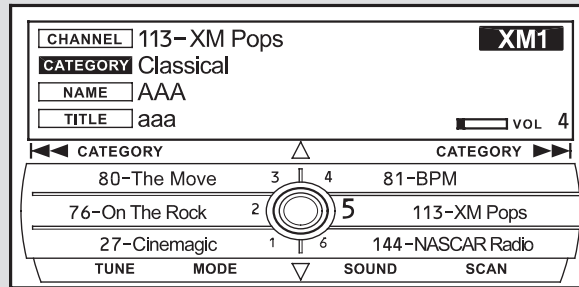
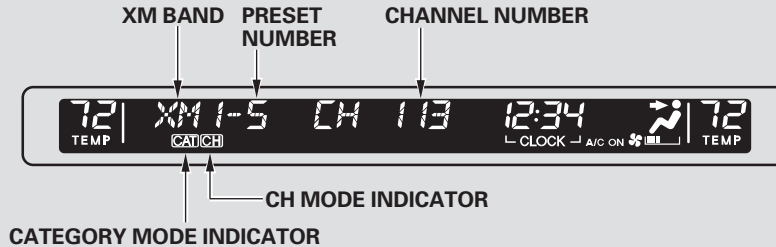

Features

CONTINUED

# Audio System

U.S. model is shown.

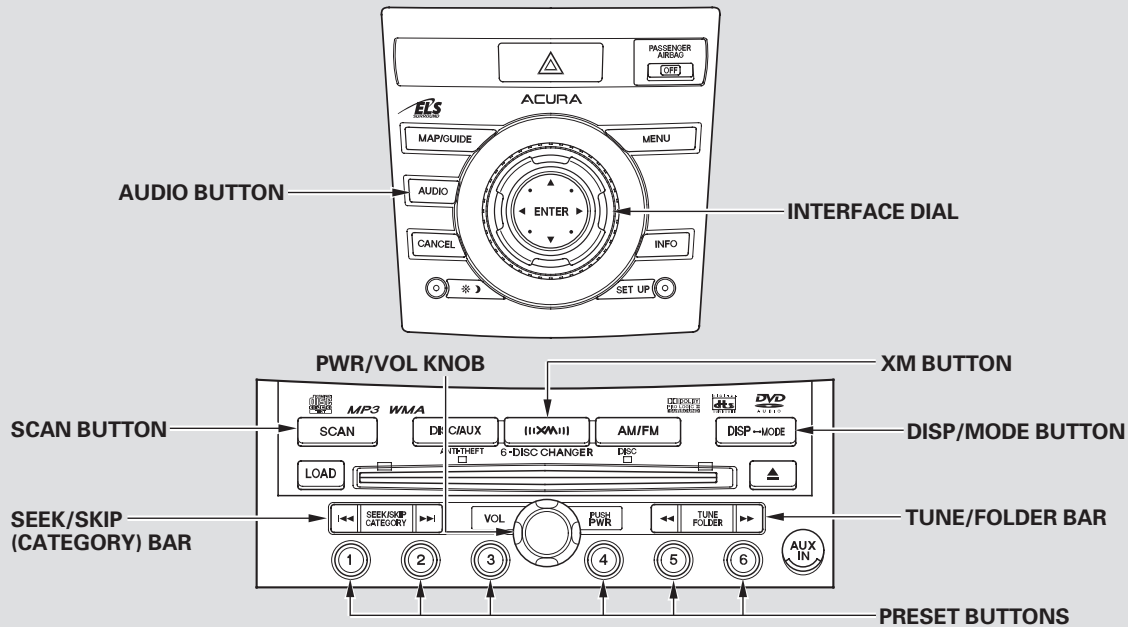



Your vehicle is capable of receiving XM<sup>®</sup> Satellite Radio anywhere in the United States, and Canada, except Hawaii and Alaska. XM<sup>®</sup> is a registered trade mark of XM Satellite Radio, Inc.

XM Satellite Radio receives signals from two satellites to produce clear, high-quality digital reception. It offers many channels in several categories. Along with a large selection of different types of music, XM Satellite Radio also allows you to view channel and category selections in the upper display and the audio control display.

## Operating the XM Radio

To listen to the XM satellite Radio, turn the ignition switch to the ACCESSORY (I) or ON (II) position. Push the PWR/VOL knob to turn on the audio system, and press the «XM» button. To view the audio control display, press the AUDIO button. Adjust the volume turning the PWR/VOL knob. The last channel you listened to will show on the upper display.

**DISP** — Each time you press and release the DISP/MODE button, the upper display changes in the following sequence: Channel name, category, artist name, and music title.

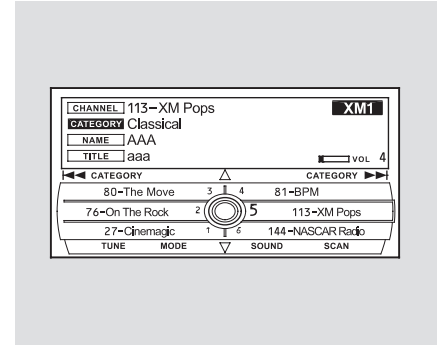

**MODE** — To switch between the category mode and channel mode, press and hold the DISP/MODE button until the mode changes. appears “CH” or “CAT” mode indicator appears on the upper display.

*CONTINUED*

## Audio System

### To Select a Channel

When in the satellite radio mode, you can use any of four methods to find channels: TUNE, SEEK/SKIP (CATEGORY), SCAN, and the preset icons.

You can also switch between the category mode and channel mode, on the audio control display. Press the AUDIO button to view the display, then push down the selector on the interface dial. Rotate the interface dial to select the mode. Press ENTER on the selector to enter your selection.

**TUNE** – Press the TUNE/FOLDER bar to change channel selections. Press the ►► side of the bar to tune to higher numbered channels, and the ◀◀ side of the bar to tune to lower numbered channels. In the category mode, you can only select channels within that category.

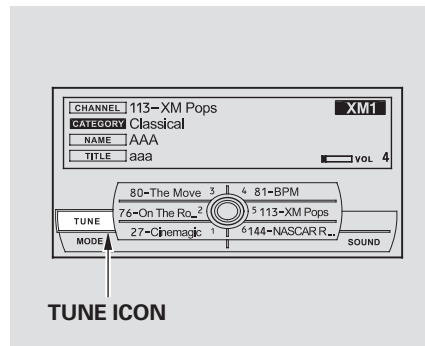

You can also change channel selections on the audio control display. Press the AUDIO button to view the display, then push down the selector on the interface dial. Rotate the interface dial to select the tune. Press ENTER on the selector to enter your selection. Rotate the interface knob to the desired channel. In the category mode, you can only select channels within that category.

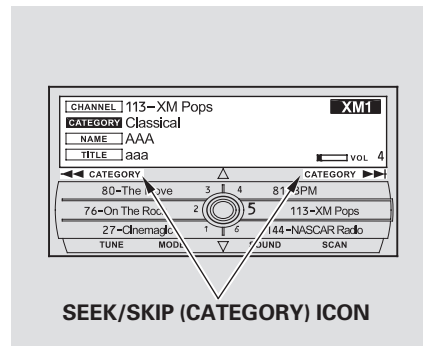

**SEEK/SKIP (CATEGORY)** – Press either side of the SEEK/SKIP (CATEGORY) bar (◀◀ or ►►) to select another category.

You can also change the category on the audio control display. Press the AUDIO button to view the display, then push the selector on the interface dial to the right side or left side to select another category.

**SCAN** – The scan function gives you a sampling of all channels while in the channel mode. In the category mode, only the channels within that category are scanned. To activate scan, press the SCAN button. The system plays each channel in numerical order for a few seconds, then selects the next channel. When you hear a channel you want to continue listening to, press the button again.

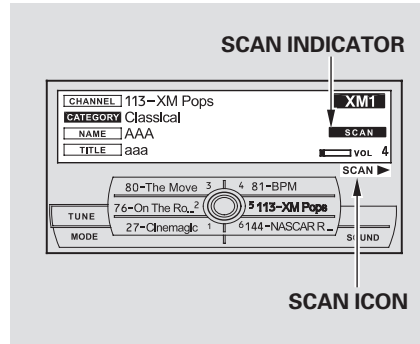

You can also scan the channels on the audio control display. Press the AUDIO button to view the display, then push down the selector on the interface dial. Push the selector to the right to activate scan feature.

**Preset** – You can store up to 12 preset channels using the preset buttons/icons. Each button/icon stores one channel from the XM1 band and one channel from the XM2 band.

To store a channel:

1. Press the «» button. To view the audio control display, press the AUDIO button. Either XM1 or XM2 will be shown on the display.
2. Use the tune, seek, or scan function to tune to a desired channel.

In category mode, only channels within that category can be selected. In channel mode, all channels can be selected.

CONTINUED

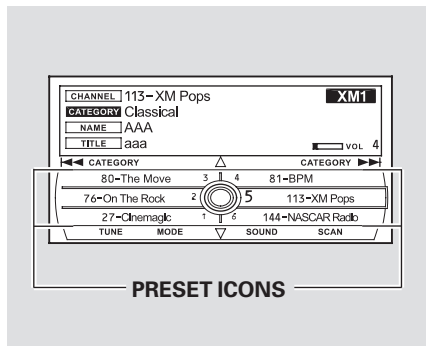

- Pick a preset number for the channel you want to store. Press and hold the appropriate button until you hear a beep.

To store the channel on a preset icon, rotate the interface dial to select a desired preset icon. The selected preset icon will be highlighted. Press and hold ENTER on the selector for more than 2 seconds to store the channel.

- Repeat steps 2 and 3 to store the first six channels.
- Press the «XM» button again. The other XM band will be shown. Store the next six channels by repeating steps 2 and 3.

Once a channel is stored, press and release the proper preset button to tune to it.

### Adjusting the Sound

For information, see page [217](#).

### XM Satellite Radio Reception

For information, see page [228](#).

## Adjusting the Sound

*On RDX with Technology Package model*

BASS, TREBLE, BALANCE, and FADER are each adjustable. You can also adjust the strength of the sound coming from the center and subwoofer speakers. In addition, you can set the Dolby PL (ProLogic) II and Speed-sensitive volume compensation (SVC).

To adjust each mode, press the AUDIO button to view the audio control display, push the interface selector down, and turn the interface dial to SOUND. Then press ENTER on the selector.

Select the mode you want to adjust by pushing the interface selector up or down, or by turning the interface dial.

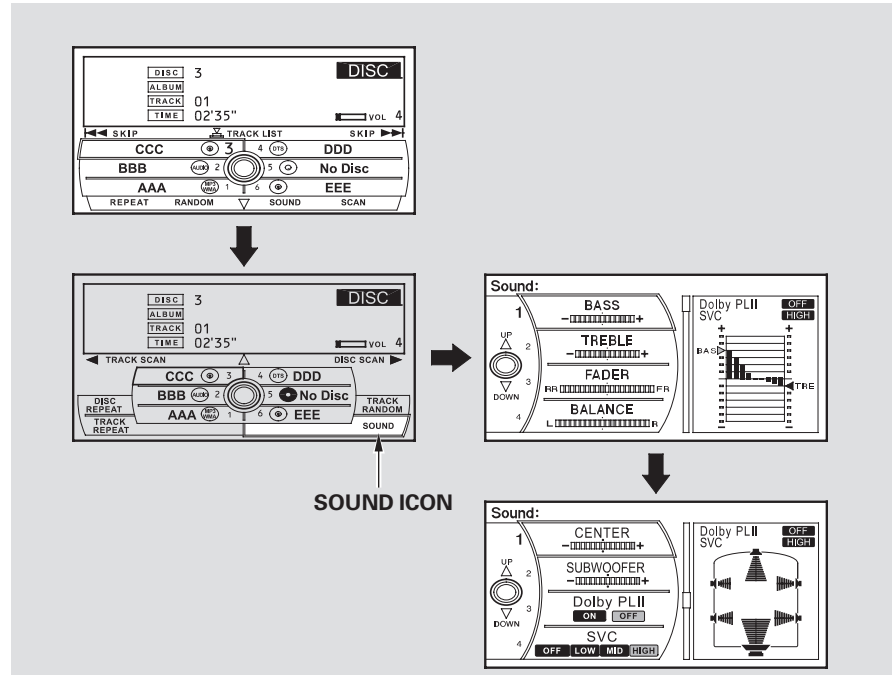

CONTINUED

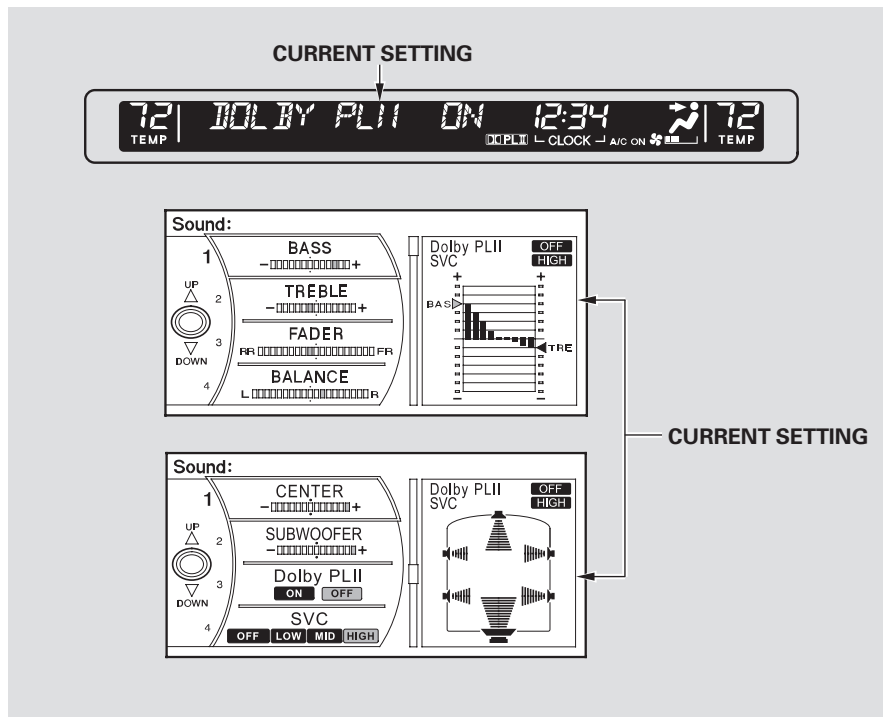

The current setting is also shown on the upper display.

The system will automatically return the display to the selected audio mode about 5 seconds after you stop adjusting a mode.

**BASS/TREBLE** – To adjust bass and treble, select **BASS** or **TREBLE**, and press **ENTER** on the interface selector. The current setting is shown on the audio control display. Turn the interface dial to the desired level (–6 to +6), and enter your selection by pressing **ENTER**.

**FADER/BALANCE** – These modes adjust the strength of the sound coming from each speaker. Fader adjusts the front-to-back strength, while balance adjusts the side-to-side strength. To adjust fader and balance, select FADER or BALANCE, then press ENTER on the interface selector. The current setting is shown on the audio control display. Turn the interface dial to the desired level (fader: F9 to R9, balance: L9 to R9), and enter your selection by pressing ENTER. To equalize the fader or balance, turn the interface dial until the readings on the sound grid come to the center of the adjustment bar.

**CENTER/SUBWOOFER** – To adjust the strength of the sound from the center or subwoofer speaker, select it and press ENTER on the interface selector. Turn the interface dial to the desired level (–6 to +6), and enter your selection by pressing ENTER. The current setting is shown on the audio control display. Even if the adjustment level reaches –6, the sub woofer is not turned off.

**Dolby PL (Prologic) II** – Dolby PL (Prologic) II signal processing creates multi-channel surround sound from the audio signal recorded with 2ch stereo sources. Dolby prologic II can only activate when listening to CD (CD-DA, MP3/WMA), XM radio, and AUX. When it activates, “DPL II” is shown on the upper display.

To set this feature on or off, select Dolby PL II, and press ENTER on the interface selector. Rotate the interface dial to ON or OFF, and press ENTER.

Manufactured under license from Dolby Laboratories. “Dolby”, “ProLogic”, and the double-D symbol are trademarks of Dolby Laboratories.

*CONTINUED*

## Audio System, Auxiliary Input Jack

---

**Speed-sensitive volume compensation (SVC)** – The SVC mode controls the volume based on vehicle speed. The faster you go, the louder the audio volume becomes. As you slow down, the audio volume decreases.

The SVC has four modes; OFF, LOW, MID, and HIGH. The default setting is MID.

Turn the interface dial to the desired setting, and enter your selection by pressing ENTER.

### Auxiliary Input Jack

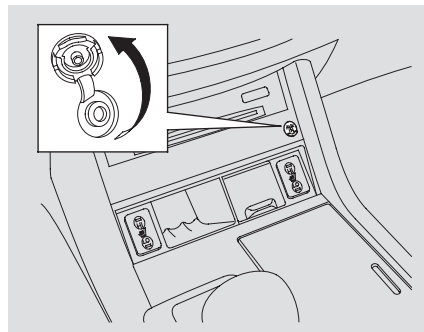

The auxiliary input jack is on the disc changer unit. The system will accept auxiliary input from standard audio accessories.

Connect a compatible audio unit to the jack, then select it by pressing:

- CD/AUX button (RDX model)
- DISC/AUX button (RDX with Technology Package model)



## Radio Frequencies

The radio can receive the complete AM and FM bands.

Those bands cover these frequencies:

AM band: 530 to 1,710 kHz

FM band: 87.7 to 107.9 MHz

Radio stations on the AM band are assigned frequencies at least 10 kHz apart (530, 540, 550). Stations on the FM band are assigned frequencies at least 0.2 MHz apart (87.9, 88.1, 88.3).

Stations must use these exact frequencies. It is fairly common for stations to round off the frequency in their advertising, so your radio could display a frequency of 100.9 even though the announcer may identify the station as "FM101."

## Radio Reception

How well the radio receives stations is dependent on many factors, such as the distance from the station's transmitter, nearby large objects, and atmospheric conditions.

A radio station's signal gets weaker as you get farther away from its transmitter. If you are listening to an AM station, you will notice the sound volume becoming weaker, and the station drifting in and out. If you are listening to an FM station, you will see the stereo indicator flickering off and on as the signal weakens. Eventually, the stereo indicator will go off and the sound will fade completely as you get out of range of the station's signal.

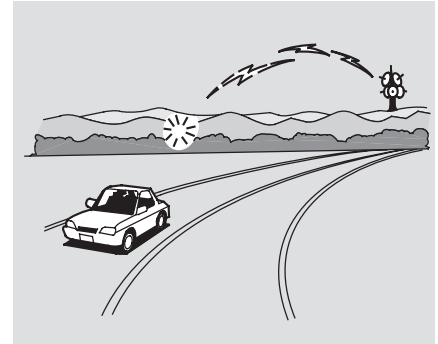

Driving very near the transmitter of a station that is broadcasting on a frequency close to the frequency of the station you are listening to can also affect your radio's reception. You may temporarily hear both stations, or hear only the station you are close to.

*CONTINUED*

## Radio Reception

---

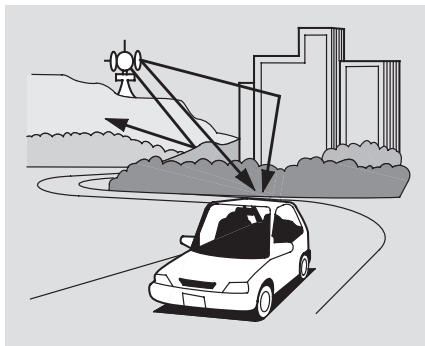

Radio signals, especially on the FM band, are deflected by large objects such as buildings and hills. Your radio then receives both the direct signal from the station's transmitter, and the deflected signal. This causes the sound to distort or flutter. This is a main cause of poor radio reception in city driving.



Radio reception can be affected by atmospheric conditions such as thunderstorms, high humidity, and even sunspots. You may be able to receive a distant radio station one day and not receive it the next day because of a change in conditions.

Electrical interference from passing vehicles and stationary sources (such as garages or parking structures) can cause temporary reception problems.

*As required by the FCC:  
Changes or modifications not expressly  
approved by the party responsible for  
compliance could void the user's  
authority to operate the equipment.*

### **General Information**

- When using CD-R/CD-RW discs, use only high quality CDs labeled for audio use.
- When recording a CD-R/CD-RW, the recording must be closed for it to be used by the system.
- Play only standard round CDs. Odd-shaped CDs may jam in the drive or cause other problems.
- Handle your CDs properly to prevent damage and skipping.

### **Protecting CDs**

When a CD is not being played, store it in its case to protect it from dust and other contamination. To prevent warpage, keep CDs out of direct sunlight and extreme heat.

To clean a CD, use a clean soft cloth. Wipe across the CD from the center to the outside edge.

A new CD may be rough on the inner and outer edges. The small plastic pieces causing this roughness can flake off and fall on the recording surface of the CD, causing skipping or other problems. Remove these pieces by rubbing the inner and outer edges with the side of a pencil or pen.

Never try to insert foreign objects in the disc changer.

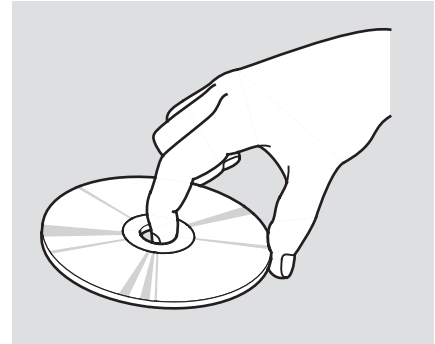

Handle a CD by its edges; never touch either surface. Do not place stabilizer rings or labels on the CD. These, along with contamination from fingerprints, liquids, and felt-tip pens, can cause the CD to not play properly or possibly jam in the drive.

# Protecting Your Discs

## Additional Information of Recommended Discs

The in-dash disc player/changer has a sophisticated and delicate mechanism. If you insert a damaged disc as indicated in this section, it may become stuck inside and damage the audio unit.

Examples of these discs are shown to the right:

### 1. Bubbled, wrinkled, labelled, and excessively thick discs

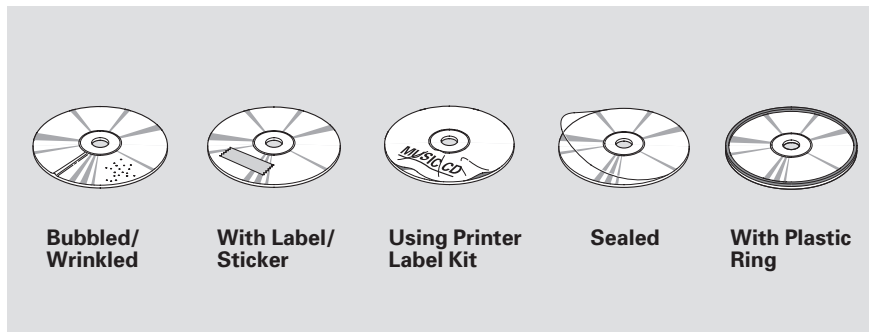

### 2. Damaged discs

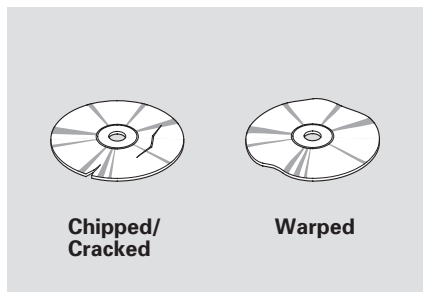

### 3. Poor quality discs

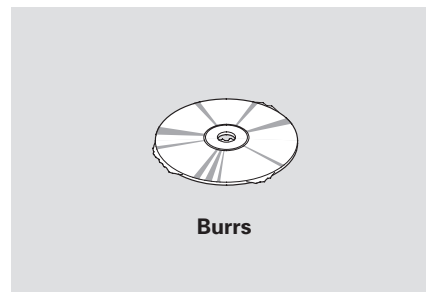

## 4. Small, irregular shaped discs

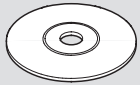

3-inch (8-cm) CD

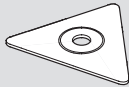

Triangle Shape

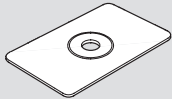

Can Shape

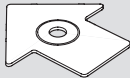

Arrow Shape

## 5. Discs with scratches, dirty discs

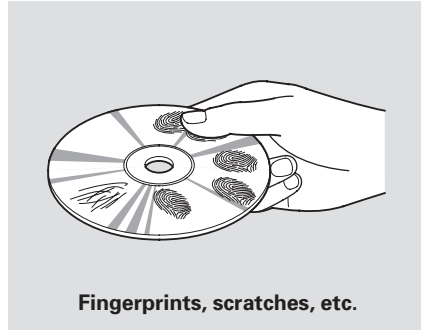

Fingerprints, scratches, etc.

- CD-R or CD-RW may not play due to the recording conditions.
- Scratches and fingerprints on the discs may cause the sound to skip.

- Recommended discs are printed with the following logo.



- Audio unit may not play the following formats.



## CD Changer Error Messages

If you see an error message in the display while playing a CD, find the cause in the chart to the right. If you cannot clear the error message, take the vehicle to your dealer.

Error Message	Cause	Solution
<i>CHECK DISC</i>	FOCUS Error	Press the EJECT button, and pull out the disc. Check if it is inserted correctly in the disc changer. Make sure the disc is not scratched or damaged. For more information, see page 224.
<i>MECH ERROR</i>	Mechanical Error	Press the EJECT button, and pull out the disc. Check the disc for damage or deformation. For more information, see page 224. If the disc cannot be pulled out, or the error message does not disappear after the disc is ejected, see your dealer.
<i>HOT</i>	High Temperature	Will disappear when the temperature returns to normal.
<i>CHECK DISC LOAD</i>	Check Disc	Press the EJECT button, and pull out the disc. Check if it is playable disc in the CD changer (see page 198).
<i>CHANGER ERROR</i>	Check Disc and Changer Error	Press the EJECT button, and pull out the disc. Check the disc for damage or deformation. For more information, see page 224. If the disc cannot be pulled out, or the error message does not disappear after the disc is ejected, see your dealer.

The chart on the right explains the error messages you may see in the display while playing a disc.

If you see an error message in the display while playing a disc, press the eject button. After ejecting the disc, check it for damage or deformation. If there is no damage, insert the disc again.

For additional information on damaged discs, see page [224](#).

The audio system will try to play the disc. If there is still a problem, the error message will reappear. Press the eject button, and pull out the disc. Insert a different disc. If the new disc plays, there is a problem with the first disc. If the error message cycle repeats and you cannot clear it, take your vehicle to a dealer.

Error Message	Cause	Solution
BAD DISC PLEASE CHECK OWNER'S MANUAL PUSH EJECT	Mechanical error	Press the EJECT button, and pull out the disc(s). Check the disc for serious damage, sign of deformation, excessive scratches, and/or dirt (see page <a href="#">224</a> .) Insert the disc again. If the code does not disappear, or the disc(s) cannot be removed, consult your dealer. Do not try to force the disc out of the player.
BAD DISC PLEASE CHECK OWNER'S MANUAL	Servo error	

## Playing the XM<sup>®</sup> Satellite Radio

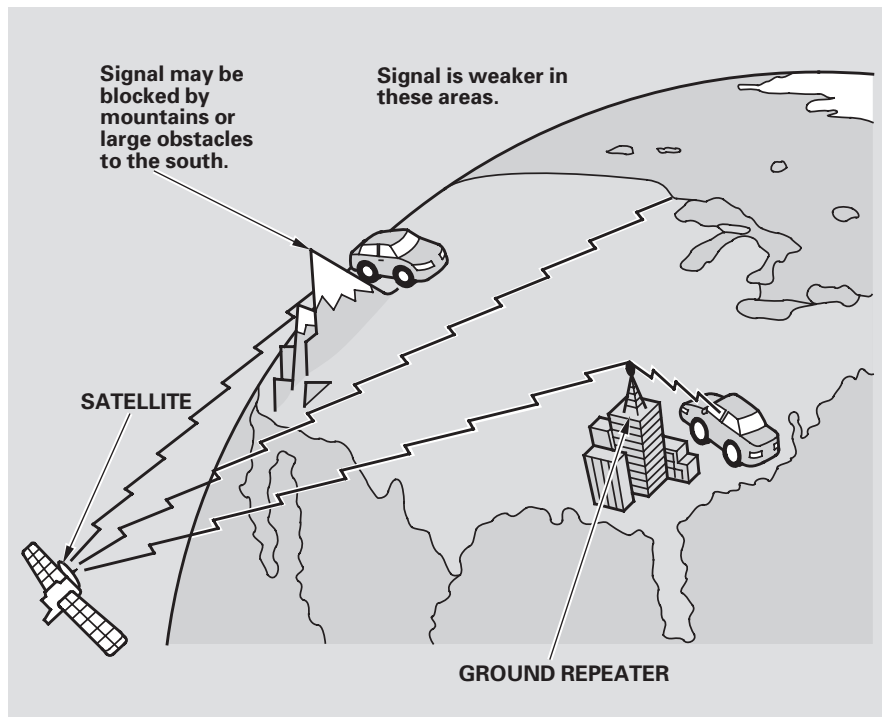

### Satellite Radio Signals

Satellite radio receives signals from two satellites to produce clear, high-quality digital reception. It offers many channels in several categories. Along with a large selection of different types of music, satellite radio also allows you to view channel and category selections in the audio display.

The XM satellites are in orbit over the equator; therefore, objects south of the vehicle may cause satellite reception interruptions. To help compensate for this, ground-based repeaters are placed in major metropolitan areas.

Satellite signals are more likely to be blocked by tall buildings and mountains the farther north you travel from the equator.



Depending on where you drive, you may experience reception problems. Interference can be caused by any of these conditions:

- Driving on the north side of an east/west mountain road.
- Driving on the north side of a large commercial truck on an east/west road.
- Driving in tunnels.
- Driving on a road beside a vertical wall, steep cliff, or hill to the south of you.
- Driving on the lower level of a multi-tiered road.
- Driving on a single lane road alongside dense trees taller than 50 ft. (15 m) to the south of you.

There may also be other geographic situations or structures that could affect satellite radio reception.

*As required by the FCC:  
Changes or modifications not expressly approved by the party responsible for compliance could void the user's authority to operate the equipment.*

### **Receiving Satellite Radio Service**

If your XM Radio service has expired or you purchased your vehicle from a previous owner, you can listen to a sampling of the broadcasts available on XM satellite radio. With the ignition switch in the ACCESSORY (I) or the ON (II) position, push the PWR/VOL knob to turn on the audio system, and press the CD/XM button. A variety of music types and styles will play.

If you decide to purchase XM satellite radio service, contact XM Radio at [www.xmradio.com](http://www.xmradio.com), or at 1-800-852-9696. In Canada, contact XM Canada at [www.xmradio.ca](http://www.xmradio.ca), or at 1-877-438-9677. You will need to give them your radio I.D. number and

your credit card number. To get your radio I.D. number, turn the TUNE knob until "0" appears in the display. Your I.D. will appear in the display.

After you've registered with XM Radio, keep your audio system in the satellite radio mode while you wait for activation. This should take about 30 minutes.

While waiting for activation, make sure your vehicle remains in an open area with good reception. Once your audio system is activated, "category" or "CH" will appear in the display, and you'll be able to listen to XM Radio broadcasts. XM Radio will continue to send an activation signal to your vehicle for at least 12 hours from the activation request. If the service has not been activated after 36 hours, contact XM Radio.

## Remote Audio Controls

---

Three controls for the audio system are mounted in the steering wheel hub. They let you control basic functions without removing your hand from the steering wheel.

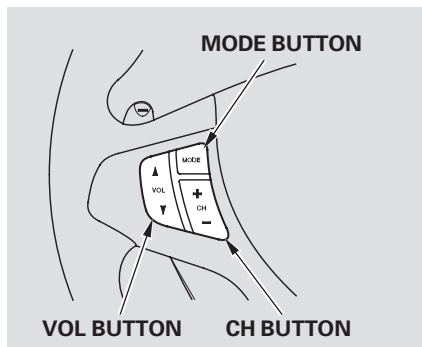

The VOL button adjusts the volume up (▲) or down (▼). Press the top or bottom of the button, hold it until the desired volume is reached, then release it.

The MODE button changes the mode. Pressing the button repeatedly selects FM1, FM2, AM, XM Satellite Radio, or CD (if a CD is loaded).

If you are listening to the radio, use the CH button to change stations. Each time you press and release the top (+) of the button, the system goes to the next preset station on the band you are listening to. Press and release the bottom (-) to go back to the previous station.

To activate the seek function, press and hold the top (+) or bottom (-) of the CH button until you hear a beep. The system searches up or down from the current frequency to find a station with a strong signal.

If you are playing CD, the system skips to the beginning of the next track (file in MP3/WMA mode) each time you press the top (+) of the CH button. Press the bottom (-) to return to the beginning of the current track/file. Press it again to return to the previous track/file.

To select a different disc (folder in MP3/WMA mode), press and hold the top (+) or bottom (-) of the CH button until you hear a beep.

If you are listening to XM Satellite Radio, use the CH button to change channels. Each time you press the top (+) of the button, the system goes to the next preset channel. Press the bottom (-) to go back to the previous preset channel.

To select a different channel of the category you are listening to, press and hold the top (+) or bottom (-) of the CH button until you hear a beep.

## Radio Theft Protection

---

Your vehicle's audio system will disable itself if it is disconnected from electrical power for any reason. To make it work again, you must enter a specific five-digit code with the preset bars or buttons (depending on models). Because there are hundreds of number combinations possible from the five digits, making the system work without knowing the exact code is nearly impossible.

You should have received a card that lists your audio system code number and serial number. It is best to store this card in a safe place at home. In addition, you should write the audio system's serial number in this owner's manual.

If you lose the card, you must obtain the code number from your dealer. To do this, you will need the audio system's serial number.

If your vehicle's battery is disconnected or goes dead, or the radio fuse is removed, the audio system will disable itself. If this happens, you will see "ENTER CODE" on the center or upper display (depending on models) the next time you turn on the system. Use the preset bars or buttons (depending on models) to enter the five-digit code. The code is located on the radio code card included in your owner's manual kit. When it is entered correctly, the radio will start playing.

If you make a mistake entering the code, do not start over; complete the five-digit sequence, then enter the correct code. You have 10 tries to enter the correct code. If you are unsuccessful in 10 attempts, you must then leave the system on for 1 hour before trying again.

The system will retain your AM and FM presets even if power is disconnected.

The security system helps to protect your vehicle and valuables from theft. The horn sounds and a combination of headlights, parking lights, side marker lights, and taillights flashes if someone attempts to break into your vehicle or remove the radio. This alarm continues for 2 minutes, then the system resets. To reset an alarming system before the 2 minutes have elapsed, unlock the driver's door with the key or the remote transmitter.

The security system automatically sets 15 seconds after you lock the doors, hood, and the tailgate. For the system to activate, you must lock the doors and the tailgate from the outside with the key, driver's lock tab, door lock master switch, or remote transmitter. The security system indicator on the instrument panel starts blinking immediately to show you the system is setting itself.



Once the security system is set, opening any door, the tailgate, or the hood without using the key or the remote transmitter, will cause it to alarm. It also alarms if the radio is removed from the dashboard or the wiring is cut.

The alarm will also be activated if the passenger inside the locked vehicle turns the ignition switch on.

The security system will not set if the hood, tailgate, or any door is not fully closed. Before you leave the vehicle, make sure the doors, tailgate, and hood are securely closed.

**NOTE:** To see if the system is set after you exit the vehicle, press the LOCK button on the remote transmitter within 5 seconds. If the system is set, a beep will sound.

Do not attempt to alter this system or add other devices to it.

## Cruise Control

Cruise control allows you to maintain a set speed above 25 mph (40 km/h) without keeping your foot on the accelerator pedal. It should be used for cruising on straight, open highways. It is not recommended for city driving, winding roads, slippery roads, heavy rain, or bad weather.

### WARNING

Improper use of the cruise control can lead to a crash.

Use the cruise control only when traveling on open highways in good weather.

### Using Cruise Control

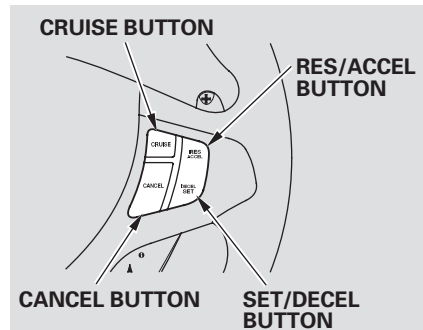

1. Push in the CRUISE button on the steering wheel. The CRUISE MAIN indicator on the instrument panel comes on.
2. Accelerate to the desired cruising speed above 25 mph (40 km/h).

3. Press and release the SET/DECEL button on the steering wheel. The CRUISE CONTROL indicator on the instrument panel comes on to show the system is now activated.

Cruise control may not hold the set speed when you are going up and down hills. If your vehicle speed increases going down a hill, use the brakes to slow down. This will cancel the cruise control. To resume the set speed, press the RES/ACCEL button. The CRUISE CONTROL indicator on the instrument panel will come back on.

When climbing a steep hill, the automatic transmission may downshift to hold the set speed.

### Changing the Set Speed

You can increase the set cruising speed in any of these ways:

- Press and hold the RES/ACCEL button. When you reach the desired cruising speed, release the button.
- Push on the accelerator pedal. Accelerate to the desired cruising speed, then press the SET/DECEL button.
- To increase your speed in very small amounts, tap the RES/ACCEL button. Each time you do this, the vehicle speeds up about 1 mph (1.6 km/h).

You can decrease the set cruising speed in any of these ways:

- Press and hold the SET/DECEL button. Release the button when you reach the desired speed.
- To slow down in very small amounts, tap the SET/DECEL button. Each time you do this, your vehicle will slow down about 1 mph (1.6 km/h).
- Tap the brake pedal lightly with your foot. The CRUISE CONTROL indicator on the instrument panel will go out. When the vehicle slows to the desired speed, press the SET/DECEL button.

Even with cruise control on, you can still use the accelerator pedal to speed up for passing. After completing the pass, take your foot off the accelerator pedal. The vehicle will return to the set cruising speed.

Resting your foot on the brake pedal causes cruise control to cancel.

# Cruise Control

---

## Canceling Cruise Control

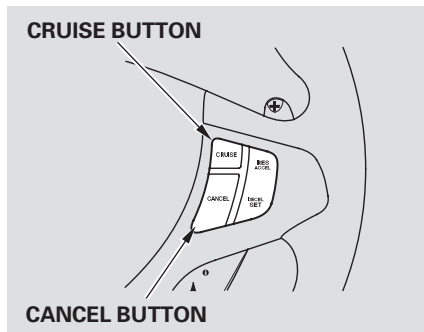

You can cancel cruise control in any of these ways:

- Tap the brake pedal.
- Push the CANCEL button on the steering wheel.
- Push the CRUISE button on the steering wheel.

The cruise control will be canceled when the vehicle speed reaches about 25 mph (40 km/h) or less.

Tapping either of the paddle shifters shifts the gear up or down, but the cruise control will be canceled if you downshift to first gear.

For more information on driving with paddle shifters, see page [297](#).

## Resuming the Set Speed

When you push the CANCEL button or tap the brake pedal, the system remembers the previously set speed. To return to that speed, accelerate to above 25 mph (40 km/h), then press and release the RES/ACCEL button. The CRUISE CONTROL indicator comes on. The vehicle accelerates to the same speed as before.

Pressing the CRUISE button turns the system completely off and erases the previous cruising speed.



On U.S. RDX with Technology Package model except Alaskan and Hawaiian AcuraLink enhances your ownership experience by providing a direct communication link between your vehicle and the Acura Server. Working through the XM radio satellite, AcuraLink works in conjunction with the navigation system, Bluetooth® HandsFreeLink® (HFL), and audio system in your vehicle. It displays and receives several kinds of messages, including:

- Operating tips and information on your vehicle's features.
- Important recall and safety information.
- Maintenance information to keep your vehicle in top condition.
- Diagnostic information to provide information about any problems with your vehicle.

## Interface Dial

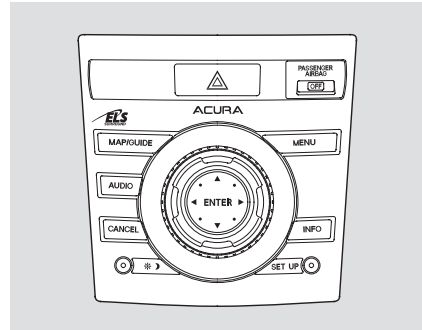

Most AcuraLink functions are controlled by the interface dial. The interface dial has two parts, a knob and a selector.

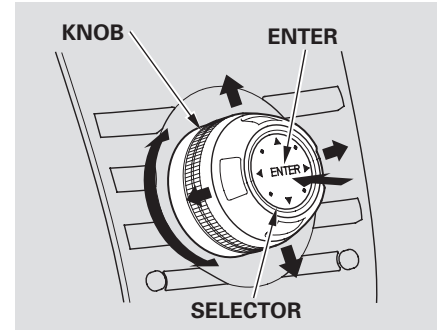

The knob turns left and right. Use it to make selections or adjustments to a list or menu on the screen.

The selector can be pushed left, right, up, down, and in. Use the selector to scroll through lists, to select menus, and to highlight menu items. When you make a selection, push the center of the selector (ENTER) to go to that selection.

## Reading Messages

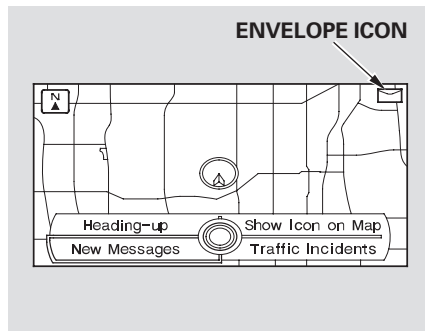

If you have new messages, an envelope icon appears in the top right corner of the navigation screen.

To open a message:

- Press ENTER on the interface selector, then select New Message from the navigation system map menu. If there is more than one message, stored in the system, you will see a list of message titles.

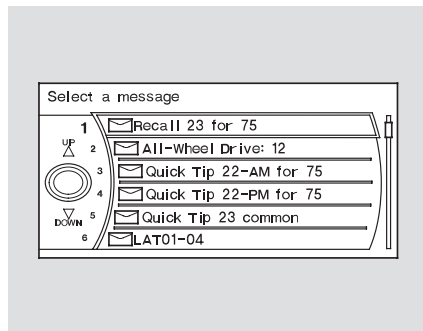

- Select Message to display the Select a message category screen. Then, select ALL MESSAGES.
- Scroll up or down, and select the message you want to read by pressing ENTER on the interface selector.

To view previously read messages, press the INFO button, then select messages.

Unread messages have a closed envelope icon next to them. The icon disappears when it has already been read.

**NOTE:** Only diagnostic info messages overlay the screen while driving. They indicate if your vehicle has a problem that may need immediate attention (see page 244).

After purchasing your vehicle, messages may not appear immediately. Your dealer has to register the vehicle identification before you can receive messages. This can take several days to process.

### Deleting Messages

**NOTE:** Diagnostic info and recall/campaign messages can only be deleted by your dealer.

To delete a single message:

- Press the INFO button to bring up the Information screen.
- Scroll to the Messages option, then select it by pressing ENTER on the interface selector.
- Use the interface knob to scroll up or down to the message title you want to delete, and select it by pressing ENTER on the interface selector.
- Scroll to Delete with the interface knob, and select it by pressing ENTER on the interface selector.

To delete all messages:

**NOTE:** The Delete All Messages command does not apply to Recall or Diagnostic Info messages. These messages must be deleted by your dealer.

- Press the SETUP button to view the setup screen.
- Select MORE by pushing the interface selector to the right.
- Use the interface knob to scroll to the AcuraLink/Messages button, and select it by pressing ENTER on the interface selector.
- Scroll to the Delete Messages option, and select it by pressing ENTER on the interface selector.
- Scroll to the category with the messages you want to delete, and select the category by pressing ENTER on the interface selector.

### Message Options

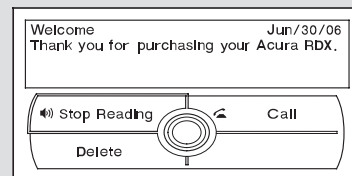

When you open a message, you can read a summary of it, and then choose one of several options. If an option is not available for a message, that button will not be highlighted.

*CONTINUED*

**Delete** — Select this button to delete the current message.

**Voice** — Select this button to hear a voice read the entire message. This gives you more information than the screen can display at one time. When you select the Voice button, it changes to a Stop Reading button. Select the button again to stop the voice.

**Call** — Select this button to call a phone number embedded in the message. When you select **Call**, the Bluetooth® HandsFreeLink® (HFL) dials the number for you.

To make a call, your Bluetooth compatible phone must be paired to your vehicle's HandsFreeLink system, have its power on, and be inside the vehicle (see page 252).

**Find Nearest Acura Dealer** — Select this button to find the nearest Acura dealer using the navigation system.

**Call Your Acura Dealer** — Select this button to call the Acura dealer you purchased your vehicle from. AcuraLink also directs you to this dealer so you can schedule a maintenance appointment or receive information about a message. If you visit another dealer for service two times within a 14-month period, AcuraLink will reset to call that dealer.

**Diagnostic Info** — Select this button to get more information about the current diagnostic message. To use this option, your cell phone must be linked to the HFL and have a compatible data service available. Access the Owner Link website to find out which data services are currently compatible with AcuraLink.

### Message Preferences

To set your AcuraLink preferences (the types of messages you want to receive, if any), visit the Owner Link website at [www.owners.acura.com](http://www.owners.acura.com), and choose what you would like to receive. If you do not have internet access, call Acura Client Services at (800) 382-2238; they can set your message preferences for you.

## AcuraLink/Message Screen

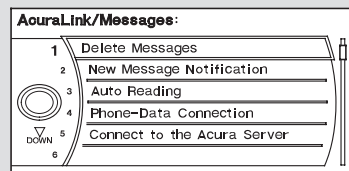
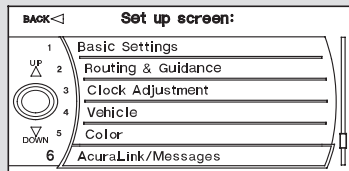

To access the following functions, press the SETUP button, push the interface selector to the right to select MORE, then rotate the interface knob to select AcuraLink/ Messages.

**Delete Messages** — Select this button to delete all stored messages within a category, except for diagnostic info and recall campaign messages. These messages can only be deleted by a certified technician after the recall is done or the problem is corrected, or through a broadcast message from Acura.

**New Message Notification** — Select ON if you want to be notified of new messages (envelope icon appears on the navigation screen). Select OFF if you do not want to be notified of new messages (envelope icon does not appear on the navigation screen).

**Auto Reading** — Select ON to have the system automatically read each message to you. Select OFF to manually select the Voice button when you want a message read to you.

**Phone-Data Connection** — Select this button to begin the process required to connect to Acura. This is used to access the most recent diagnostic information when a problem occurs.

CONTINUED

**NOTE:** For the Phone Data Connection button to be active, you need a Bluetooth® compatible and enabled cellphone paired to the Bluetooth® HandsFreeLink® (HFL). To complete the data connection setup, the paired phone must have a compatible data service.

**Connect to the Acura Server** — The default setting is prompt. When a diagnostic info message appears, and you select the Check Now button, the system will prompt you before connecting to the Acura server. If you do not wish to connect at that time, select No at the prompt, and you will see the information from the onboard database. The “Auto” setting will remove the prompt when you select the Check Now button and will automatically connect to the Acura server. This setting only applies when you have a Bluetooth® enabled phone that is paired with the HFL and you have completed the Phone-Data Connection setup.

### **Message Categories**

There are six message categories in AcuraLink: Quick Tips, Feature Guides, Maintenance Minders, Recalls/Campaigns, Diagnostic Info, and Dealer Appointment Reminders. The system can store up to 256 messages.

Message categories can be added, revised, or deleted through broadcast messages from Acura.

## Quick Tips

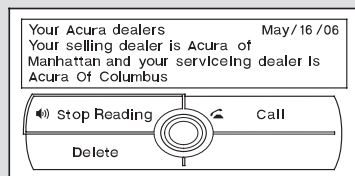

These messages, based on updated vehicle information and comments from other RDX owners, supplement your Owner's Manual and Quick Start Guide. They provide you with relevant information for a safe and enjoyable ownership experience. For additional information, call Acura Client Services directly through the HFL.

## Feature Guide

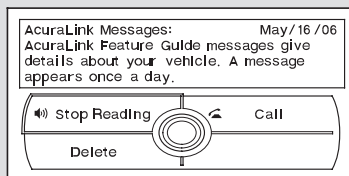

During the first 90 days of ownership, one of 16 different messages appears each day. These messages help you to use and understand the technological features of your vehicle.

## Maintenance Minder

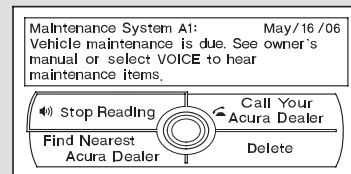

These messages provide detailed information about the service needed for your vehicle. When a maintenance message appears on the multi-information display, a list of needed maintenance items is provided through an AcuraLink message. These messages tell you the exact maintenance needed, helping you to avoid unnecessary maintenance costs.

*CONTINUED*

You can then use the message options to call your dealer for an appointment or to find the nearest dealer.

### Recall/Campaigns

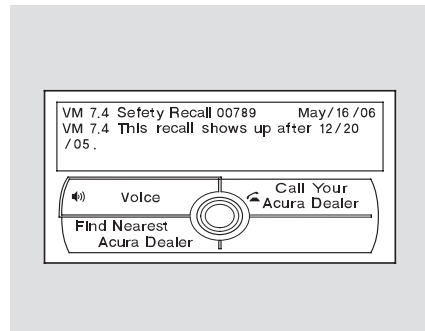

If your vehicle is affected by a recall or other important safety information, a letter will be mailed to you about the issue and how to fix it. If you don't get your vehicle fixed, you will also receive a reminder message through AcuraLink. You can then use the message options to call your dealer for an appointment or to find the nearest dealer.

### Diagnostic Info

If an instrument panel indicator stays on when it should go off, or a message appears on the multi-information display, AcuraLink can identify the problem, send the information to Acura for analysis, and then provide you with the most accurate repair information available all before going to a dealer. This helps you handle the problem as it occurs, preventing or limiting costly repairs.

The AcuraLink system cannot determine some mechanical problems (such as squeaks or rattles) that are not triggered by the diagnostic indicator monitors.

A diagnostic message is generated if any of the instrument panel indicators stay on when they should go off. For more information on the instrument panel indicators, see page [61](#).



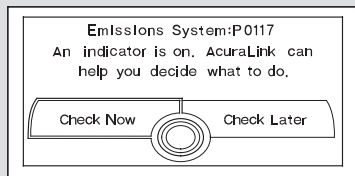

When an instrument panel indicator comes on or a message is displayed on the MID, AcuraLink immediately notifies you with the message, “Check more information.” If you do not want the information right away, select the Check Later option. If you want the information now, select the Check Now option. (If the navigation screen is not active, you must select OK from the navigation disclaimer screen before you can check the information.)

Depending on the severity of the problem, the message will let you know if you should see your dealer immediately or if you can wait a while.

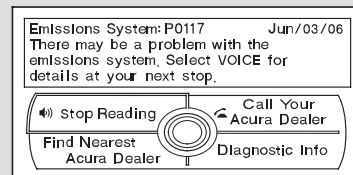

You will see information from the onboard troubleshooting database.

You can then use message options to call your dealer for an appointment, to find the nearest dealer, or to find out more information about the issue.

*CONTINUED*

When you select the Diagnostic Info option, if the HFL is connected to a cellular data service, AcuraLink gathers more information about the problem, and sends it to Acura. There, the information is analyzed and returned to the vehicle with the most accurate repair information.

### Dealer Appointment Reminder

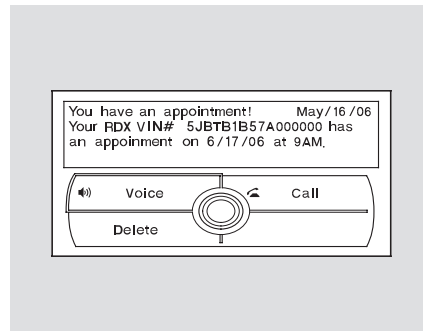

When you make an appointment through the Owner's Link Online Scheduling Service, you can be reminded about that appointment through the AcuraLink system in advance. If you need to reschedule, you can call your dealer directly with the HFL.

The timing of your reminder is based on your reminder preference established on Owner Link.

*As required by the FCC:*

*This device complies with Part 15 of the FCC rules. Operation is subject to the following two conditions: (1) This device may not cause harmful interference, and (2) this device must accept any interference received, including interference that may cause undesired operation.*

*Changes or modifications not expressly approved by the party responsible for compliance could void the user's authority to operate the equipment.*

*This device complies with Industry Canada Standard RSS-210.*

*Operation is subject to the following two conditions: (1) this device may not cause interference, and (2) this device must accept any interference that may cause undesired operation of the device.*

The HomeLink® Universal Transceiver built into your vehicle can be programmed to operate up to three remote controlled devices around your home, such as garage doors, lighting, or home security systems.

## General Safety Information

Before programming your HomeLink to operate a garage door opener, confirm that the opener has an external entrapment protection system, such as an “electronic eye,” or other safety and reverse stop features.

If your garage door was manufactured before April 1, 1982, you may not be able to program HomeLink to operate it. These units do not have safety features that cause the motor to stop and reverse it if an obstacle is detected during closing, increasing the risk of injury. Do not use HomeLink with any

garage door opener that lacks safety stop and reverse features.

Units manufactured between April 1, 1982 and January 1, 1993 may be equipped with safety stop and reverse features. If your unit does not have an external entrapment protection system, an easy test to confirm the function and performance of the safety stop and reverse feature is to lay a 2 × 4 under the closing door. The door should stop and reverse upon contacting the piece of wood. As an additional safety feature, garage door openers manufactured after January 1, 1993 are required to have external entrapment protection systems, such as an electronic eye, which detect an object obstructing the door.

## Important Safety Precautions

Refer to the safety information that came with your garage door opener to test that the safety features are functioning properly. If you do not have this information, contact the manufacturer of the equipment. Before programming HomeLink to a garage door or gate opener, make sure that people and objects are out of the way of the device to prevent potential injury or damage. When programming a garage door opener, park just outside the garage.

# HomeLink® Universal Transceiver

## Training HomeLink

**Before you begin** — If you just received your vehicle and have not trained any of the buttons in HomeLink before, you should erase any previously learned codes before training the first button.

To do this, press and hold the two outside buttons on the HomeLink transceiver for about 20 seconds, until the red indicator flashes. Release the buttons, then proceed to step 1.

If you are training the second or third buttons, go directly to step 1.

1. Hold the end of the garage door opener remote transmitter 1 to 3 inches from HomeLink. Make sure you are not blocking your view of the red indicator in HomeLink.



2. Press and hold the remote transmitter button and one of the HomeLink buttons at the same time.
  - If the red indicator in HomeLink begins to flash slowly at first, then rapidly, release both buttons, and go to step 4.
  - If the red indicator in HomeLink continues to flash slowly (does not flash rapidly), your remote transmitter may stop transmitting after a short time.

Go to step 3.

3. Press and hold the remote transmitter button and one of the HomeLink buttons at the same time. While continuing to hold the HomeLink button, press and release the remote transmitter button every 2 seconds.
  - If the red indicator in HomeLink begins to flash slowly at first, then rapidly, release both buttons, and go to step 4.
  - If the red indicator in HomeLink continues to flash slowly (does not begin to flash rapidly), repeat steps 1 thru 3.
4. Test the HomeLink button by pushing it for about 1 second.
  - If the button works, programming is complete.
  - If the button does not work go to step 5.

5. Push and hold the HomeLink button and watch the red indicator on HomeLink.
  - If the indicator stays on, press the HomeLink button again; the remotely controlled device should operate.
  - If the indicator flashes rapidly for 2 seconds then stays on, you have a rolling code transmitter: go to “Training with a Rolling Code System” (see page 249).
6. Repeat these steps to train the other two HomeLink buttons to operate any other compatible remotely controlled devices around your home (lighting, automatic gate, security system, etc.).

## Training With a Rolling Code System

For security purposes, newer garage door opening systems use a “rolling” or variable code. Information from the remote control and the garage door opener is needed before HomeLink can operate the garage door opener.

The “Training HomeLink” procedure trains HomeLink to the proper garage door opener code. The following procedure synchronizes HomeLink to the garage door opener so it sends and receives the correct codes.

1. Make sure you have properly completed the “Training HomeLink” procedure.

2. Find the “learn” button on your garage door opener unit. The location will vary, depending on the manufacturer.

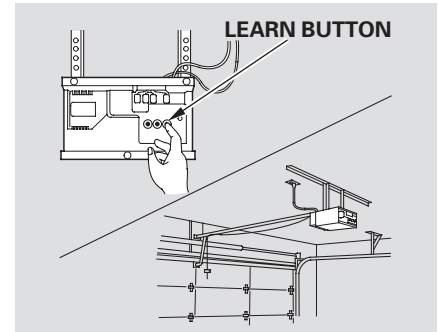

3. Press the learn button on the garage door opener unit until the indicator next to the button comes on. The indicator may blink, or come on and stay on. You then have approximately 30 seconds to complete the following steps.

*CONTINUED*

4. Press and hold the button on HomeLink for 3 to 4 seconds.
5. Press the HomeLink button again for about 1 second. It should operate the garage door.

## **Erasing Codes**

To erase the codes stored in all three buttons, press and hold the two outside buttons until the red indicator begins to flash, then release the buttons.

You should erase all three codes before selling the vehicle.

## **Retraining a Button**

If you want to retrain a programmed button for a new device, you do not have to erase all button memory. You can replace the existing memory code using this procedure:

1. Press and hold the HomeLink button to be trained until the HomeLink indicator begins to flash slowly.
  - If a rolling code transmitter was previously programmed, the indicator will flash rapidly for 2 seconds, and then stay on for about 23 seconds.
  - If a standard transmitter was programmed, the indicator will stay on for about 25 seconds.
2. Once the HomeLink indicator begins to flash slowly, continue to hold the HomeLink button, and follow steps 2 thru 5 under “Training HomeLink” (see page [248](#)).

## Client Assistance

If you have problems with training the HomeLink Universal Transceiver, or would like information on home products that can be operated by HomeLink, call (800) 355-3515. On the Internet, go to [www.homelink.com](http://www.homelink.com).

HomeLink® is a registered trademark of Johnson Controls, Inc.

*As required by the FCC:*

*This device complies with Part 15 of the FCC rules. Operation is subject to the following two conditions: (1) This device may not cause harmful interference, and (2) this device must accept any interference received, including interference that may cause undesired operation.*

*Changes or modifications not expressly approved by the party responsible for compliance could void the user's authority to operate the equipment.*

*This device complies with Industry Canada Standard RSS-210.*

*Operation is subject to the following two conditions: (1) this device may not cause interference, and (2) this device must accept any interference that may cause undesired operation of the device.*

### **Bluetooth® HandsFreeLink®**

Your vehicle is equipped with the Bluetooth® HandsFreeLink® (HFL). HFL uses Bluetooth® technology to link your cell phone to your vehicle. With HFL, you can place and receive calls through your vehicle's audio system, without the distraction of handling your cell phone. To use this feature, you need a Bluetooth-compatible cell phone with the Hands-Free Profile. For more information, and a list of compatible cell phones, visit [www.acura.com/handsfreelink](http://www.acura.com/handsfreelink), or call 1-888-528-7876. In Canada, visit [www.acura.ca](http://www.acura.ca), or call 1-888-9-ACURA-9.

Here are the main features of the HFL. Instructions for using the HFL begin on page [253](#).

### **Voice Control**

HFL recognizes simple voice commands, such as phone numbers and names. It uses these commands to automatically dial, receive, and

store numbers. For more information on voice control, see Using Voice Control on page [255](#).

### **Bluetooth® Wireless Technology**

Bluetooth® is a registered trademark of Bluetooth SIG, Inc. Bluetooth is the wireless technology that links your phone to the HFL. The HFL uses a Class 2 Bluetooth, which means the maximum range between your phone and vehicle is 30 feet (10 meters).

To use the HFL, your phone must have approved Bluetooth capability along with the Hands-Free Profile. This type of phone is available through many phone makers and cellular carriers. You can also find an approved phone by visiting [www.acura.com/handsfreelink](http://www.acura.com/handsfreelink), or by calling the HandsFreeLink consumer support at 1-888-528-7876. In Canada, visit [www.acura.ca](http://www.acura.ca), or call 1888-9-ACURA-9.

### **Incoming/Outgoing Calls**

With a linked phone, the HFL allows you to send and receive calls in your vehicle without holding the phone.

### **Phonebook**

The HFL can store up to 50 names and phone numbers in its phonebook. With a linked phone, you can then automatically dial any name or number in the phonebook.

Here are the main components of the HFL system:

### **Microphone**

The HFL microphone is on the ceiling console. The microphone is shared with the navigation system.



**Audio System**

When the HFL is in use, the sound comes through the vehicle's front audio system speakers. If the audio system is in use while operating either of the HFL buttons or making a call, the HFL over-rides the audio system. To change the volume level, use the audio system volume knob.

**HFL Buttons**

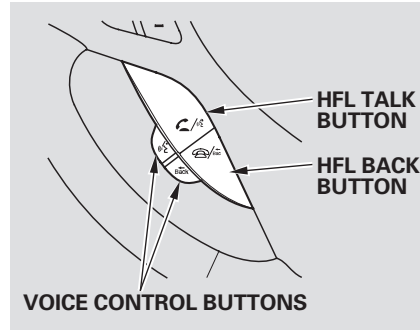

To operate the HFL, use the HFL Talk and Back buttons on the left side of the steering wheel.

*On RDX with Technology Package model*

Below the HFL buttons is another set of voice control buttons for the navigation, climate control, and audio systems. To use the voice control system, refer to the navigation system manual.

Here is the function of each HFL button:

**HFL Talk:** This button is used before you give a command, to answer incoming calls, and to confirm system information.

**HFL Back:** This button is used to end a call, go back to the previous voice control command, and to cancel an operation.

## Multi-Information Display

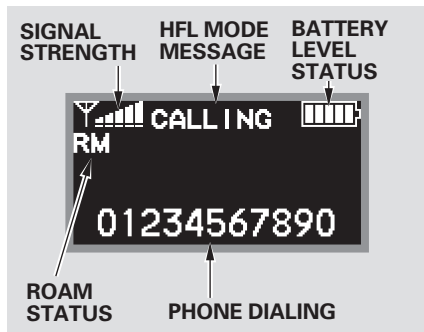

When you are operating the HFL, or when you manually select HFL in the multi-information display, you will see this information in the display:

- Signal Strength\* – Indicates the network signal strength of the current phone. Five bars equals full strength.
- ROAM Status\* – Indicates your phone is roaming.
- Battery Level Status\* – Indicates the power currently remaining in your phone's battery. Five bars equals full battery strength.

- HFL Mode Message – Indicates when you are dialing and receiving calls.
- Phone Dialing – Indicates the number you entered or the number of the incoming call.

\* : Some phones do not send this information to the HFL.

You will also see a “HANDS FREELINK” on the upper display.

### How to Use the HFL

The HFL is operated by the HFL Talk and Back buttons on the left side of the steering wheel. The next few pages provide instructions for all basic features of the HFL.

**NOTE: All phones may not operate identically, and some may cause inconsistent operation of the HFL.**

### Using Voice Control

Here are some guidelines for using voice control:

- To enter a command, press the Talk button. Then, after the beep, say your command in a clear, natural tone.
- For best system operation, set the climate control fan speed to low, and direct the center vents away from the microphone in the ceiling.
- If the HFL does not recognize a command, its response is, "Pardon." If it doesn't recognize the command a second time, its response is, "Please repeat." If it doesn't recognize the command a third time, it plays the Help prompt.

- To hear a list of available options at any time, press the Talk button, wait for the beep, and say, "Hands free link help."
- Many commands can be spoken together. For example, you can say, "Dial 123-456-7891."
- To enter a string of numbers in a Call or Dial command, you can say them all at once, or you can separate them in blocks of 3, 4, 7, 10, or 11.
- To skip a voice prompt, press the Talk button while the HFL is speaking. The HFL will then begin listening for your next command.

CONTINUED

- To go back one step in a command process, say, “Go back,” or press the Back button.

If nothing is said while the HFL is listening for a command, the HFL will time out and stop its voice recognition. The next time you press the Talk button, the HFL begins listening from the point at which it timed out.

- To end a command sequence at any time, press and hold the Back button, or press and release the Talk button, wait for the beep, and say, “Cancel.” The next time you press the Talk button, the HFL begins from its main menu.

- When you finish a command sequence, the HFL goes back to its main menu. For example, when you store the name, “Eric,” the HFL response is, “Eric has been stored.” The next time you press the Talk button, you will be at the main menu.

### Setting Up the System

The voice of the HFL can be set to male or female (U.S. models only). Also, the incoming notification can be set to a ring tone, a prompt, or no notification.

*To set up the system, do this:*

1. Press and release the Talk button. After the beep, say “System.” The HFL response is, “System options are setup and clear.”

2. Press and release the Talk button. After the beep, say “Setup.” The HFL response is “Would you like male or female prompts?”
3. Press and release the Talk button. After the beep, say “Male” or “Female,” depending on the system voice you want. The HFL response is, “Male (Female) prompts have been selected. Would you like an audible notification of an incoming call?”

4. Press and release the Talk button. If you say “Yes” after the beep, the HFL system response is, “Would you like the notification to be a ring tone or a prompt?” If you say “No” after the beep, the HFL system returns to its main menu. Saying “No” will result in no ring tone or prompt playback during an incoming call. The audio system will be mute, and a message will be displayed.
5. Press and release the Talk button. After the beep, say “Ring tone” or “Prompt.” The HFT system response is “A ring tone will be used.” or “An incoming call prompt will be used.”

**Pairing Your Phone**

Your Bluetooth compatible phone with Hands-Free Profile must be paired to the HFL before you can make and receive hands-free calls. To confirm that your phone is

Bluetooth compatible, visit [www.acura.com/handsfreelink](http://www.acura.com/handsfreelink) or call 1-888-528-7876. In Canada, visit [www.acura.ca](http://www.acura.ca), or call 1-888-9-ACURA-9. Your phone retailer should also be able to confirm that your phone is Bluetooth compatible.

**NOTE:**

- HFL does not allow you to pair your phone if the vehicle is moving.
- For pairing, your phone must be in its Discovery mode.
- Up to six phones can be paired to the HFL.
- The following procedure works for most phones. If you cannot pair your phone to the HFL with this procedure, refer to your phone’s operating manual, visit [www.acura.com/handsfreelink](http://www.acura.com/handsfreelink), call at HandsFreeLink® consumer support at (888) 528-7876, or call your retailer. In Canada, visit [www.acura.ca](http://www.acura.ca), or call (888) 9-ACURA-9.

- During the pairing process, turn off any previously paired phones before pairing a new phone.
1. With your phone on and the ignition in the ACCESSORY (I) or ON (II) position, press and release the Talk button. After the beep, say “Phone setup.” The HFL response is “Phone setup options are status, pair, edit, delete, and list.”
  2. Press and release the Talk button. After the beep, say “Pair.” The HFL response is “The pairing process requires operation of your mobile phone. For safety, only perform this function while the vehicle is stopped. State a four-digit code for pairing. Note this code. It will be requested by the phone.”

CONTINUED

3. Press and release the Talk button. After the beep, say the four-digit code you want to use. For example, say “1, 2, 3, 4.” The HFL response is, “1, 2, 3, 4. Is this correct?”
4. Press and release the Talk button. After the beep, say “Yes.” The HFL response is “Searching for a Bluetooth phone. Make sure the phone you are trying to pair is in Discovery mode.”

**NOTE:** Steps 5 and 6 show a common way to get your phone into its Discovery mode. If these steps do not work on your phone, refer to the phone’s operating manual.

5. Follow the prompts on your phone to get it into its Discovery mode. The phone will search for the HFL. When it comes up, select HandsFreeLink from the list of options displayed on your phone.
6. When asked by the phone, enter the four-digit code from step 3 into your phone. The HFL response is “A new phone has been found. What would you like to name this phone?”
7. Press and release the Talk button. After the beep, say the name you want to use. For example, say “Eric’s phone.” The HFL response is “Eric’s phone has been successfully paired. Returning to the main menu.”
8. If you want to pair another phone, repeat steps 1 through 7.

Once the pairing process is completed, AcuraLink may display a connection confirmation screen. This screen is used to create a data connection between your cell phone and the AcuraLink system. You can choose to set up the data connection now, or do it later. If you want to do it now, exit the HFL menu by pressing the HFL Back button one or more times.

*To rename a paired phone, do this:*

1. Press and release the Talk button. After the beep, say “Phone setup.” The HFL response is “Phone setup options are status, pair, edit, delete, and list.”
2. Press and release the Talk button. After the beep, say “Edit.” The HFL response is “Which phone would you like to edit?”
3. Press and release the Talk button. After the beep, say the name of the phone you want to rename. For example, say “Eric’s phone.” The HFL response is “What is the new name for Eric’s phone?”
4. Press and release the Talk button. After the beep, say the new name of the phone. For example, say “Lisa’s phone.” The HFL response is, “The name has been changed. Returning to the main menu.”

*To delete a paired phone, do this:*

1. Press and release the Talk button. After the beep, say “Phone setup.” The HFL response is, “Phone setup options are status, pair, edit, delete, and list.”
2. Press and release the Talk button. After the beep, say “Delete.” The HFL response is, “Which phone would you like to delete?”
3. Press and release the Talk button. After the beep, say the name of the phone you want to delete. For example say “Eric’s phone.” The HFL response is “Would you like to delete Eric’s phone?”

4. Press and release the Talk button. After the beep, say “Yes.” The HFL response is “Preparing to delete Eric’s phone.” Say “OK” to continue. Otherwise, say “Go back,” or “Cancel.”
5. Press and release the Talk button. If you say “OK” after the beep, the HFL response is “The phone has been deleted. Returning to the main menu.” If you say “Go back,” or “Cancel,” the phone will not be deleted.

CONTINUED

*To list all paired phones, do this:*

1. Press and release the Talk button.  
After the beep, say “Phone setup.”  
The HFL response is “Phone setup options are status, pair, edit, delete, and list.”
2. Press and release the Talk button.  
After the beep, say “List.” The HFL responds by listing the name of each paired phone. When all phones paired to the system have been read, the HFL response is “The entire list has been read. Returning to the main menu.”

*To find out the status of the phone being used, do this:*

1. Press and release the Talk button.  
After the beep, say “Phone setup.”  
The HFL response is “Phone setup options are status, pair, edit, delete, and list.”
2. Press and release the Talk button.  
After the beep, say “Status.” An example of the HFL response is, “Eric’s phone is linked. Battery strength is three bars. Signal strength is five bars, and the phone is roaming. Returning to the main menu.”

*To change from the currently linked phone to another paired phone, do this:*

1. Press and release the Talk button.  
After the beep, say “Next phone.”  
The HFL response is “Searching for the next phone.” The HFL then disconnects the linked phone and searches for another paired phone. If no other phones are found, the first phone remains linked.



### Making a Call

You can make calls using any phone number, or by using a name in the HFL phonebook. You can also redial the last number called. During a call, the HFL allows you to talk up to 30 minutes after you remove the key from the ignition switch. Continuing a call without running the engine may discharge and weaken the vehicle's battery.

*To make a call using a phone number, do this:*

1. With your phone on and the ignition in the ACCESSORY (I) or ON (II) position, press and release the Talk button. After the beep, say "Call" or "Dial." The HFL response is, "What name or number would you like to call/dial?"
2. Press and release the Talk button. After the beep, say the number you want to call. For example, say "123 456 7891." The HFL response is "123 456 7891. Say call, dial, or continue to add numbers."
3. Press and release the Talk button. After the beep, say "Call" or "Dial." The HFL response is "Calling" or "Dialing." Once connected, you will hear the person you called through the audio speakers. To change the volume, use the audio system volume knob.
4. To end the call, press the Back button.

CONTINUED

*To make a call using a name in the HFL phonebook, do this:*

1. With your phone on and the ignition in the ACCESSORY (I) or ON (II) position, press and release the Talk button. After the beep, say “Call” or “Dial.” The HFL response is “What name or number would you like to call/dial?”
2. Press and release the Talk button. After the beep, say the name you want to call. For example, say “Eric.” The HFL response is “Would you like to call Eric?”

3. Press and release the Talk button. After the beep, say “Yes.” The HFL response is “Calling” or “Dialing.” Once connected, you will hear the person you called through the audio speakers. To change the volume, use the audio system volume knob.
4. To end the call, press the Back button.

To redial the last number called by the phone, press and release the Talk button. After the beep, say “Redial.” The HFL response is, “Redialing.” Once connected, you will hear the person you called through the audio speakers. To change the volume, use the audio system volume knob.

**Sending Numbers or Names During a Call**

The HFL allows you to send numbers or names during a call. This is useful when you call a menu-driven phone system. You can also program account numbers into the HFL phonebook for easy retrieval during menu-driven calls.

*To send a number during a call, do this:*

1. Press and release the Talk button. After the beep, say "Send." The HFL response is, "What name or number would you like to send?"
2. Press and release the Talk button. After the beep, say the number you want to send. For example, say "1, 2, 3." The HFL response is "1, 2, 3. Say send, or continue to add numbers."

**NOTE:** To send pound (#), say "pound." To send star (\*), say "star."

3. Press and release the Talk button. After the beep, say "Send." The dial tones will be sent, and the call will continue.

*To send a name during a call, do this:*

1. Press and release the Talk button. After the beep, say "Send." The HFL response is "What name or number would you like to send?"
2. Press and release the Talk button. After the beep, say the name you want to send. For example, say "Account number." The HFL response is "Would you like to send account number?"
3. Press and release the Talk button. After the beep, say "Send." The dial tones will be sent, and the call will continue.

## Receiving a Call

If you receive a call when you are not on the phone, the HFL interrupts the audio system (if it is on), and plays the incoming call notification, if activated. To answer the call, press the Talk button and begin speaking. If you don't want to answer the call, press the Back button.

If your phone has Call Waiting, and you receive a call when you are on the phone, press and release the Talk button to answer it. When you do this, the original call is placed on hold. To return to the original call, press the Talk button again. If you don't want to answer the new call, disregard it, and continue with your original call. If you want to hang up the original call and answer the new call, press the Back button.

## Transferring a Call

During a call, you can transfer it from the HFL to your phone, or from your phone to the HFL.

*To transfer a call from the HFL to your phone, do this:*

1. Press and release the Talk button.  
After the beep, say "Transfer."  
The audio switches from the HFL to the phone.

*To transfer a call from your phone to the HFL, do this:*

2. Press and release the Talk button.  
After the beep, say "Transfer."  
The audio switches from your phone to the HFL.

## Muting a Call

During a call, you can mute or unmute your voice to the person you are talking to.

*To mute your voice, do this:*

1. Press and release the Talk button.  
After the beep, say "Mute." The HFL response is, "Mute is active."

*To unmute your voice, do this:*

2. Press and release the Talk button.  
After the beep, say "Mute." The HFL response is, "Mute is canceled."

**Setting up the Phonebook**

The HFL phonebook can store up to 50 names with their associated numbers. These can be any types of numbers. For example, you can store a phone number and use it to make a call, or you can store an account number and use it during a call to a menu-driven phone system.

*To add a name, do this:*

1. Press and release the Talk button. After the beep, say “Phonebook.” The HFL response is “Phonebook options are store, edit, delete, receive contact, and list.”
2. Press and release the Talk button. After the beep, say “Store.” The HFL response is, “What name would you like to store?”
3. Press and release the Talk button. After the beep, say the name you would like to store. For example, say “Eric” or say “account number.” The HFL response is “What is the number for Eric,” or “What is the number for account number?”

4. Press and release the Talk button. After the beep, say the number. For example, say “123 456 7891.” The HFL response is “123 456 7891.”
5. Press and release the Talk button. After the beep, say “Enter.” The HFL response is “Eric (or account number) has been stored. Returning to the main menu.”

Features

CONTINUED

*To edit the number of a name, do this:*

1. Press and release the Talk button.  
After the beep, say "Phonebook."  
The HFL response is "Phonebook options are store, edit, delete, receive contact, and list."
2. Press and release the Talk button.  
After the beep, say "Edit." The HFL response is, "What name would you like to edit?"
3. Press and release the Talk button.  
After the beep, say the name you would like to edit. For example, say "Eric." The HFL response is "What is the new number for Eric?"

4. Press and release the Talk button.  
After the beep, say the new number for Eric. For example, say "987 654 3219." The HFL response is, "987 654 3219."
5. Press and release the Talk button.  
After the beep, say "Enter." The HFL response is "The number has been changed. Returning to the main menu."

*To delete a name, do this:*

1. Press and release the Talk button.  
After the beep, say "Phonebook."  
The HFL response is, "The Phonebook options are store, edit, delete, receive contact, and list."
2. Press and release the Talk button.  
After the beep, say "Delete." The HFL response is, "What name would you like to delete?"

3. Press and release the Talk button.  
After the beep, say the name you would like to delete. For example, say "Eric." The HFL response is "Do you want to delete Eric?"
4. Press and release the Talk button.  
After the beep, say "Yes." The HFL response is, "The name has been deleted. Returning to the main menu."

*To list all names in the phonebook, do this:*

1. Press and release the Talk button.  
After the beep, say "Phonebook."  
The HFL response is, "The Phonebook options are store, edit, delete, and list."

2. Press and release the Talk button. After the beep, say “List.” The HFL responds by listing the names in the phonebook. When the end of the list is reached, the HFL response is, “The entire list has been read. Returning to the main menu.”

*To call a name from the phonebook list, do this:*

1. Press and release the Talk button. After the beep, say “Phonebook.” The HFL response is “Phonebook options are store, edit, delete, and list.”
2. Press and release the Talk button. After the beep, say “List.” The HFL responds by listing the names in the phonebook. When it says the name you want to call, for example, Eric, press the Talk button, and then say “Call.” The HFL response is, “Would you like to call Eric?”

3. Press and release the Talk button. After the beep, say “Yes.” The HFL response is “Calling.” Once connected, you will hear the person you called through the audio speakers. To change the volume, use the audio system volume knob.

### **Clearing the System**

This operation clears the HFL of your passcode, your paired phones, and all names in the HFL phonebook. Clearing is recommended before you sell your vehicle.

*To clear the system, do this:*

1. Press and release the Talk button. After the beep, say “System.” The HFL response is, “System options are setup and clear.”

2. Press and release the Talk button. After the beep, say “Clear.” The HFL response is, “This process will clear all paired phones, clear all entries in the phonebook, clear the passcode, and restore the defaults in the system setup. Is this what you would like to do?”
3. Press and release the Talk button. After the beep, say “Yes.” The HFL response is “Preparing to clear all paired phones, all phonebook entries, the passcode, and restore the defaults in the system setup. This may take up to 2 minutes to complete.” Press and release the Talk button. After the beep, say “OK” to proceed, otherwise say “Go back” or “Cancel.”
4. If you said “OK,” after a short period of time, the HFL response is, “System has been cleared. Returning to the main menu.”

## Changing Language (Canadian Models Only)

*To change from English to French, do this:*

1. Press and release the Talk button. After the beep, say “Change language.” The HFL response is “English or French?”
2. Press and release the Talk button. After the beep, say “Français.” The HFL response is “Vous avez sélectionné le Français. Les noms enregistrés dans une autre langue ne seront pas accessible en mode Français. Voulez-vous continuer?”
3. Press and release the Talk button. After the beep, say “Oui” or “Yes.” If there are no paired phones without French name tags, the HFL response is “Venillez attendre que le système change de langue. Please wait while the language is changed.” “La langue a été changée. Retour au menu

principal.”

If there are paired phones without French name tags, the HFL response is “Pour que le système identifie les téléphones qui ont été jumelés dans une autre langue, les noms des téléphones doivent être ré-enregistrés.”

**NOTE:** If there are paired phones without French name tags, the following prompts will continue.

4. The HFL response is, for example, “Quel est le nom Français pour <Paul’s phone>?” Press and release the Talk button. After the beep, say “Téléphone de Paul.” The HFL response is, “Quel est le nom Français pour <Pat’s phone>?” Press and release the Talk button. Say “Téléphone de Pat.” After all paired phones missing a French name tag are re-recorded, the HFL will prompt, “Retour au menu principal.”

*To change from French to English, do this:*

1. Press and release the Talk button. After the beep, say “Changer Langue.” The HFL response is, “Anglais ou Français?”
2. Press and release the Talk button. After the beep, say “English.” The HFL response is, “You have selected English. Name tags that were stored while in French mode will not be accessible in English mode. Would you like to continue?”, then the system repeats the response in English.



3. Press and release the Talk button. After the beep, say “Yes” or “Oui.” If there are no paired phones without English name tags, the HFL response is “Please wait while the language is changed. Veuillez attendre que le système change de langue.” “The language has been changed. Returning to the main menu.”
4. The HFL says, for example, “What is the English name for <Téléphone de Paul>?” Press and release the Talk button. After the beep, say “Paul’s phone.” The HFL response is “What is the English name for <Téléphone de Pat>?” Press and release the Talk button. After the beep, say “Pat’s phone.” After all paired phones missing an English name tag are re-recorded, the HFL will say “Returning to the main menu.”

If there are paired phones without English name tags, the HFL response is “The language has been changed. For the system to identify phones that were paired while in another language, the phone names need to be re-recorded.”

**NOTE:** If there are paired phones without English name tags, the following prompts will continue.

*As required by the FCC:*

*This device complies with Part 15 of the FCC rules. Operation is subject to the following two conditions: (1) This device may not cause harmful interference, and (2) this device must accept any interference received, including interference that may cause undesired operation.*

*Changes or modifications not expressly approved by the party responsible for compliance could void the user’s authority to operate the equipment.*

*This device complies with Industry Canada Standard RSS-210.*

*Operation is subject to the following two conditions: (1) this device may not cause interference, and (2) this device must accept any interference that may cause undesired operation of the device.*

## Rearview Camera and Monitor

*On RDX with Technology Package model*

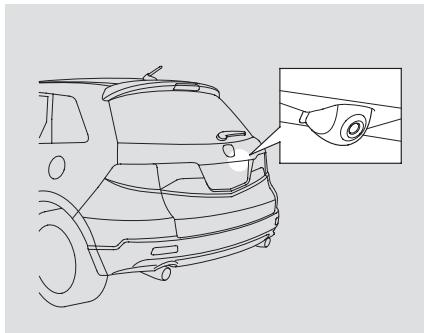

Whenever you shift to reverse (R) with the ignition switch in the ON (II) position, the rear view is shown on the navigation system screen.

For the best picture, always keep the rearview camera clean, and do not cover the camera lens. To avoid scratching the lens when you clean it, use a moist, soft cloth.

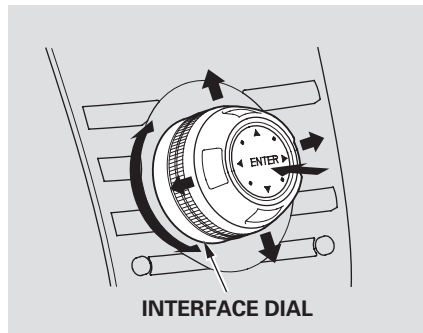

Since the rearview camera display area is limited, you should always back up slowly and carefully, and look behind you for obstacles.

When in reverse, the navigation buttons are locked out, except the interface dial on the dashboard. Turn the dial clockwise to make the camera image brighter, and counter-clockwise to darken the image.

### NOTICE

*The camera brightness cannot be adjusted by voice control.*

Before you begin driving your vehicle, you should know what gasoline to use and how to check the levels of important fluids. You also need to know how to properly store luggage or packages. The information in this section will help you. If you plan to add any accessories to your vehicle, please read the information in this section first.

Break-in Period .....	272
Fuel Recommendation .....	272
Service Station Procedures .....	273
Refueling.....	273
Tighten Fuel Cap Message .....	274
Opening and Closing the Hood .....	275
Oil Check.....	276
Engine Coolant Check .....	277
Fuel Economy .....	278
Accessories and Modifications ....	281
Carrying Cargo .....	283

## Break-in Period, Fuel Recommendation

---

### Break-in Period

Help assure your vehicle's future reliability and performance by paying extra attention to how you drive during the first 600 miles (1,000 km). During this period:

- Avoid full-throttle starts and rapid acceleration.
- Avoid hard braking for the first 200 miles (300 km).
- Do not change the oil until the scheduled maintenance time.
- Do not tow a trailer.

You should also follow these recommendations with an overhauled or exchanged engine, or when the brakes are replaced.

### Fuel Recommendation

Your vehicle is designed to operate on premium unleaded gasoline with a pump octane of 91 or higher. If this octane grade is unavailable, regular unleaded gasoline with a pump octane of 87 or higher may be used temporarily. The use of regular unleaded gasoline can cause metallic knocking noises in the engine and will result in decreased engine performance. The long-term use of regular-grade gasoline can lead to engine damage.

We recommend using quality gasolines containing detergent additives that help prevent fuel system and engine deposits.

In addition, in order to maintain good performance, fuel economy, and emissions control, we strongly recommend, in areas where it is available, the use of gasoline that does NOT contain manganese-based fuel additives such as MMT.

Use of gasoline with these additives may adversely affect performance, and cause the malfunction indicator lamp on your instrument panel to come on. If this happens, contact your authorized dealer for service.

# Fuel Recommendation, Service Station Procedures

Some gasoline today is blended with oxygenates such as ethanol or MTBE. Your vehicle is designed to operate on oxygenated gasoline containing up to 10 % ethanol by volume and up to 15 % MTBE by volume. Do not use gasoline containing methanol.

If you notice any undesirable operating symptoms, try another service station or switch to another brand of gasoline.

For further important fuel-related information, please refer to your **Quick Start Guide**.

## Refueling

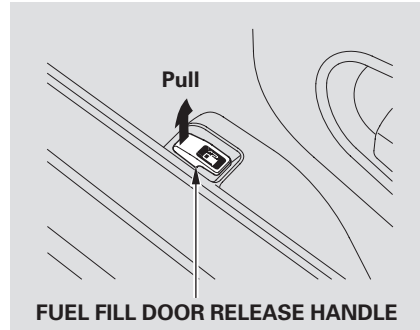

1. Park with the driver's side closest to the service station pump.
2. Open the fuel fill door by pulling on the handle at the outside of the driver's seat.

## **⚠ WARNING**

Gasoline is highly flammable and explosive. You can be burned or seriously injured when handling fuel.

- Stop the engine, and keep heat, sparks, and flame away.
- Handle fuel only outdoors.
- Wipe up spills immediately.

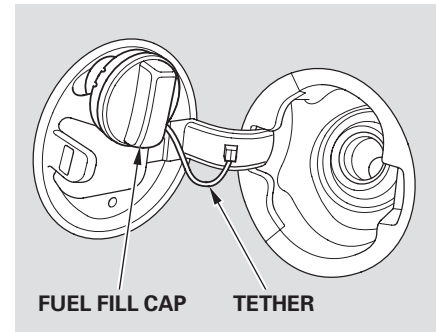

*CONTINUED*

## Service Station Procedures

---

3. Remove the fuel fill cap slowly. You may hear a hissing sound as pressure inside the tank escapes. Place the cap in the holder on the fuel fill door.
4. Stop filling the tank after the fuel nozzle automatically clicks off. Do not try to “top off” the tank. Leave some room for the fuel to expand with temperature changes.

*If the fuel nozzle keeps clicking off even though the tank is not full, there may be a problem with your vehicle’s fuel vapor recovery system. The system helps keep fuel vapor from going into the atmosphere. Try filling at another pump. If this does not fix the problem, consult your dealer.*

5. Screw the fuel fill cap back on until it clicks at least once. If you do not properly tighten the cap, you will see a “TIGHTEN FUEL CAP” message on the multi-information display (see right column on this page), and the malfunction indicator lamp may also come on (see page 382).
6. Push the fuel fill door closed until it latches.

### Tighten Fuel Cap Message



If your fuel fill cap is loose or missing, a “TIGHTEN FUEL CAP” message appears on the multi-information display after you start the engine.

Turn the engine off, and confirm the fuel fill cap is installed. If it is, loosen it, then retighten it until it clicks at least once. When you can restart the engine, the message appears again. The message goes off after several days of normal driving once you tighten or replace the fuel fill cap. To scroll to another message, press the INFO (▲/▼) button.

If the system still detects a leak in your vehicle's evaporative emissions system, the malfunction indicator lamp (MIL) comes on. If the fuel fill cap was not already tightened, turn the engine off, and check or retighten the fuel fill cap until it clicks at least once. The MIL should go off after several days of normal driving once the cap is tightened or replaced. If the MIL does not go off, have your vehicle inspected by a dealer. For more information, see page 382 .

### Opening and Closing the Hood



1. Park the vehicle, and set the parking brake. Pull the hood release handle located under the lower left corner of the dashboard. The hood will pop up slightly.

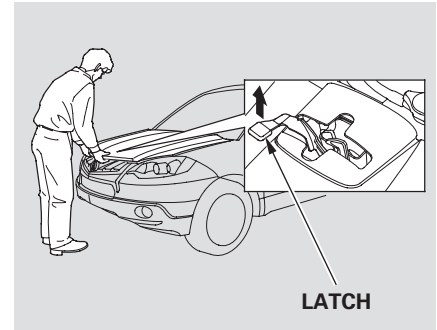

2. Put your fingers under the front edge of the hood near the center. Slide your hand to the left until you feel the hood latch handle. Push this handle up to release it. Lift up the hood.

If the hood latch handle moves stiffly, or if you can open the hood without lifting the handle, the mechanism should be cleaned and lubricated.

*CONTINUED*

## Service Station Procedures

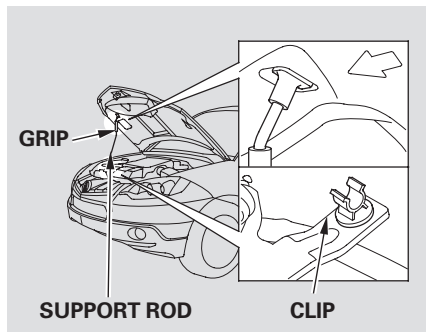

3. Holding the grip, pull the support rod out of its clip. Insert the end into the designated hole in the hood.

To close the hood, lift it up slightly to remove the support rod from the hole. Put the support rod back into its holding clip. Lower the hood to about a foot (30 cm) above the fender, then let it drop. Make sure it is securely latched.

### Oil Check

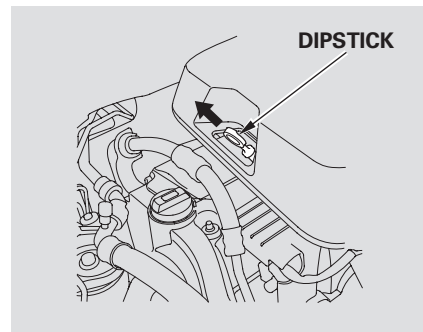

Park the vehicle on a level surface. Wait a few minutes after turning the engine off before you check the oil.

1. Remove the dipstick (orange loop).
2. Wipe off the dipstick with a clean cloth or paper towel.
3. Hold the dipstick with a clean cloth or paper towel, and then insert it all the way back in its hole.



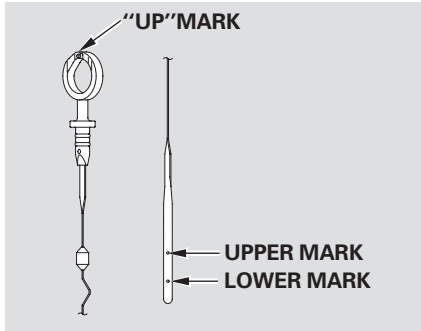

Make sure the "UP" mark on the loop is facing up when you insert the dipstick.

4. Remove the dipstick again, and check the level. It should be between the upper and lower marks.

If it is near or below the lower mark, see **Adding Engine Oil** on page [336](#).

### Engine Coolant Check

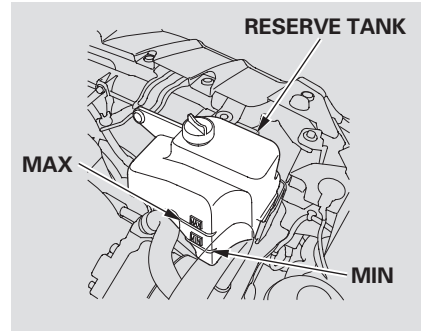

Look at the coolant level in the radiator reserve tank. Make sure it is between the MAX and MIN lines. If it is below the MIN line, see **Adding Engine Coolant** on page [340](#) for information on adding the proper coolant.

Refer to **Owner's Maintenance Checks** on page [333](#) for information about checking other items on your vehicle.

# Fuel Economy

## Actual Mileage and EPA Fuel Economy Estimates Comparison.

Fuel economy is not a fixed number. It varies based on driving conditions, driving habits and vehicle condition. Therefore, it is not possible for one set of estimates to predict fuel economy precisely for all drivers in all environments.

The EPA fuel economy estimates shown in the example to the right are a useful tool for comparison when buying a vehicle. EPA estimates include:

**City MPG** – Represents urban driving in a vehicle in light traffic. A range of miles per gallon achieved is also provided.

**Highway MPG** – Represents a mixture of rural and interstate driving, in a warmed-up vehicle, typical of longer trips in free-flowing traffic. A range of miles per gallon

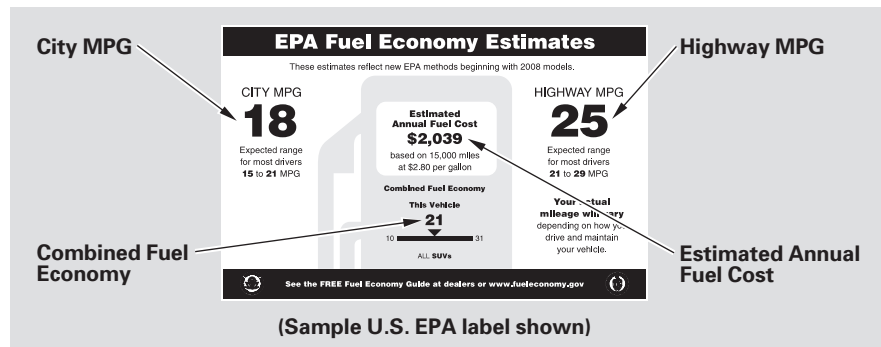

achieved is also provided.

**Combined Fuel Economy** – Represents a combination of city and highway driving. The scale represents the range of combined fuel economy for other vehicles in the class.

**Estimated Annual Fuel Cost** – Provides an estimated annual fuel cost, based on 15,000 miles (20,000 km) per year multiplied by the cost per gallon (based on EPA fuel cost data) divided by the combined fuel economy.

For more information on fuel economy ratings and factors that affect fuel economy, visit [www.fueleconomy.gov](http://www.fueleconomy.gov) (Canada: Visit [www.vehicles.gc.ca](http://www.vehicles.gc.ca))

## Fuel Economy Factors

The following factors can lower your vehicle's fuel economy:

- Aggressive driving (hard acceleration and braking)
- Excessive idling, accelerating and braking in stop-and-go traffic
- Cold engine operation (engines are more efficient when warmed up)
- Driving with a heavy load or the air conditioner running
- Improperly inflated tires

## Improving Fuel Economy

### *Vehicle Maintenance*

A properly maintained vehicle maximizes fuel economy. Poor maintenance can significantly reduce fuel economy. Always maintain your vehicle according to the maintenance messages displayed on the information display (see **Owner's Maintenance Checks** on page 333). For example:

- **Use the required engine oil** (see page 336).
- **Maintain proper tire inflation** — An underinflated tire increases “rolling resistance,” which reduces fuel economy.
- **Avoid carrying excess weight in your vehicle** — It puts a heavier load on the engine, increasing fuel consumption.
- **Keep your vehicle clean** — In particular, a build-up of snow or mud on your vehicle's underside adds weight and rolling resistance. Frequent cleaning helps your fuel economy.

### *Drive Efficiently*

- **Drive moderately** — Rapid acceleration, abrupt cornering, and hard braking increase fuel consumption.
- **Observe the speed limit** — Aerodynamic drag has a big effect on fuel mileage at speeds above 45 mph (75 km/h). Reduce your speed and you reduce the drag. Trailers, car top carriers, roof racks and bike racks are also big contributors to increased drag.
- **Always drive in the highest gear possible** — If your vehicle has a manual transmission, you can boost your fuel economy by up shifting as early as possible.
- **Avoid excessive idling** — Idling results in 0 miles per gallon.

CONTINUED

## Fuel Economy

- **Minimize the use of the air conditioning system** – The A/C puts an extra load on the engine which makes it use more fuel. Use the fresh-air ventilation when possible.
- **Plan and combine trips** – Combine several short trips into one. A warmed-up engine is more fuel efficient than a cold one.

### Calculating Fuel Economy

#### *Measuring Techniques*

Direct calculation is the recommended source of information about your actual fuel economy. Using frequency of fill-ups or taking fuel gauge readings are NOT accurate measures of fuel economy. Fuel economy may improve over the first several thousand miles.

### *Checking Your Fuel Economy*

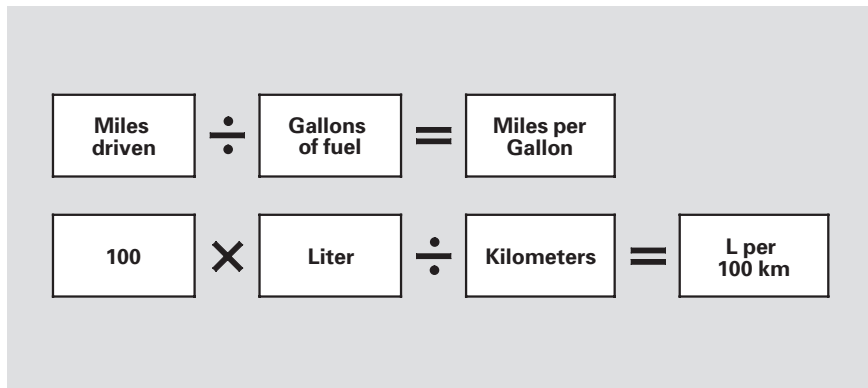

- 1) Fill the fuel tank until the nozzle automatically clicks off.
- 2) Reset trip counter to zero.
- 3) Record the total gallons (liters) needed to refill.
- 4) Follow one of the simple calculations above.

Modifying your vehicle, or installing some non-Acura accessories, can make your vehicle unsafe. Before you make any modifications or add any accessories, be sure to read the following information.

### Accessories

Your dealer has Acura accessories that allow you to personalize your vehicle. These accessories have been designed and approved for your vehicle, and are covered by warranty.

Although non-Acura accessories may fit on your vehicle, they may not meet factory specifications, and could adversely affect your vehicle's handling and stability.

### **WARNING**

Improper accessories or modifications can affect your vehicle's handling, stability, and performance, and cause a crash in which you can be hurt or killed.

Follow all instructions in this owner's manual regarding accessories and modifications.

When properly installed, cellular phones, alarms, two-way radios, and low-powered audio systems should not interfere with your vehicle's computer controlled systems, such as your airbags, anti-lock brakes, and tire pressure monitoring system.

Before installing any accessory:

- Make sure the accessory does not obscure any lights, or interfere with proper vehicle operation or performance.
- Be sure electronic accessories do not overload electrical circuits (see page 386) or interfere with proper operation of your vehicle.
- Before installing any electronic accessory, have the installer contact your dealer for assistance. If possible, have your dealer inspect the final installation.
- Do not install accessories on the side pillars or across the rear windows. Accessories installed in these areas may interfere with proper operation of the side curtain airbags.

## Accessories and Modifications

---

### Modifying Your Vehicle

Removing parts from your vehicle, or replacing components with non-Acura components could seriously affect your vehicle's handling, stability, and reliability.

Here are some examples:

- Lowering the vehicle with a non-Acura suspension kit that significantly reduces ground clearance can allow the undercarriage to hit speed bumps or other raised objects, which could cause the airbags to deploy.
- Raising your vehicle with a non-Acura suspension kit can affect the handling and stability.

- Non-Acura wheels, because they are a universal design, can cause excessive stress on suspension components and will not be compatible with the tire pressure monitoring system (TPMS).
- Larger or smaller wheels and tires can interfere with the operation of your vehicle's anti-lock brakes and other systems.
- Modifying your steering wheel or any other part of your vehicle's safety features can make the systems ineffective.

If you plan to modify your vehicle, consult your dealer.

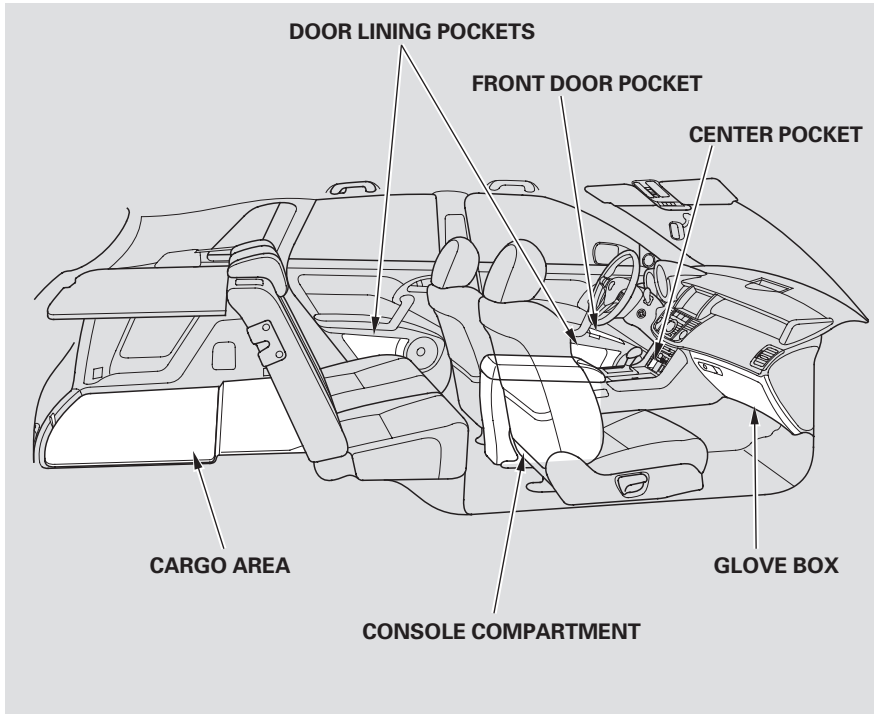

Your vehicle has several convenient storage areas:

- Glove box
- Front door pockets
- Door lining pockets
- Center pocket
- Console compartment
- Cargo area, including the rear seats when folded down.
- Roof-rack (if equipped)

However, carrying too much cargo, or improperly storing it, can affect your vehicle's handling, stability, stopping distance, and tires, and make it unsafe. Before carrying any type of cargo, be sure to read the following pages.

## Carrying Cargo

### Load Limits

The maximum load for your vehicle is 870 lbs for U.S. vehicles, and 395 kg for Canadian vehicles.

See Tire And Loading Information label attached to the driver's doorjamb.

### Label Example

TIRE AND LOADING INFORMATION			
SEATING CAPACITY		TOTAL X	FRONT X REAR X
The combined weight of occupants and cargo should never exceed XXXkg or XXXXlbs			
TIRE	SIZE	COLD TIRE PRESSURE	SEE OWNER'S MANUAL FOR ADDITIONAL INFORMATION
FRONT	XXXX/XXXX XXXX	XXXKPA, XXPSI	
REAR	XXXX/XXXX XXXX	XXXKPA, XXPSI	
SPARE	XXXX/XXXX XXXX	XXXKPA, XXPSI	

This figure includes the total weight of all occupants, cargo, and accessories, and the tongue load if you are towing a trailer.

### **⚠ WARNING**

Overloading or improper loading can affect handling and stability and cause a crash in which you can be hurt or killed.









Follow all load limits and other loading guidelines in this manual.

Steps for Determining Correct Load Limit –

- (1) Locate the statement “The combined weight of occupants and cargo should never exceed XXX kg or XXX lbs.” on your vehicle’s placard.
- (2) Determine the combined weight of the driver and passengers that will be riding in your vehicle.
- (3) Subtract the combined weight of the driver and passengers from XXX kg or XXX lbs.
- (4) The resulting figure equals the available amount of cargo and luggage load capacity. For example, if the “XXX” amount equals 1,400 lbs. and there will be five 150 lb. passengers in your vehicle, the amount of available cargo and luggage load capacity is 650 lbs.  
(1,400 – 750 (5 × 150) = 650 lbs.)

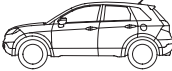

- (5) Determine the combined weight of luggage and cargo being loaded on the vehicle. That weight may not safely exceed the available cargo and luggage load capacity calculated in Step 4.
- (6) If your vehicle will be towing a trailer, load from your trailer will be transferred to your vehicle. Consult this manual to determine how this reduces the available cargo and luggage load capacity of your vehicle.

<p>Example 1</p>	 <b>Max Load (870 lbs)</b>	$\geq$  <b>Passenger Weight</b> (150 lbs x 2 = 300 lbs)	$+$  <b>Cargo Weight</b> (570 lbs)
<p>Example 2</p>	 <b>Max Load (870 lbs)</b>	$\geq$  <b>Passenger Weight</b> (150 lbs x 4 = 600 lbs)	$+$  <b>Cargo Weight</b> (270 lbs)
<p>Example 3</p>	 <b>Max Load (870 lbs)</b>	$\geq$  <b>Passenger Weight</b> (150 lbs x 5 = 750 lbs)	$+$  <b>Cargo Weight</b> (120 lbs)

In addition, the total weight of the vehicle, all occupants, accessories, cargo, and trailer tongue load must not exceed the Gross Vehicle Weight Rating (GVWR) or the Gross Axle Weight Rating (GAWR). Both are on a label on the driver's doorjamb.

## Carrying Cargo

---

### Carrying Cargo in the Passenger Compartment

- Store or secure all items that could be thrown around and hurt someone during a crash.
- Be sure items placed on the floor behind the front seats cannot roll underneath and interfere with the proper operation of the seats, the sensors under the seats, or the driver's ability to operate the pedals.
- Keep the glove box closed while driving. If it is open, a passenger could injure their knees during a crash or sudden stop.
- Do not put any items on top of the cargo area cover. They can block your view and be thrown around the vehicle during a crash.

### Carrying Cargo in the Cargo Area or on a Roof Rack

- Distribute cargo evenly on the floor of the cargo area, placing the heaviest items on the bottom and as far forward as possible. Tie down items that could be thrown about the vehicle during a crash or sudden stop.
- If you fold the rear seats down, tie down items that could be thrown about the vehicle during a crash or sudden stop. Also, keep all cargo below the bottom of the windows. If it is higher, it could interfere with the proper operation of the side curtain airbags.

- If you carry large items that prevent you from closing the tailgate, exhaust gas can enter the passenger area. To avoid the possibility of **carbon monoxide poisoning**, follow the instructions on page [56](#) .
- If you carry any items on a roof rack, be sure the total weight of the rack and the items does not exceed the maximum allowable weight. Please contact your dealer for further information.
- If you carry any items on a roof rack, be sure the total weight of the rack and the items does not exceed 110 lbs (50 kg).

If you use an accessory roof rack, the roof rack weight limit may be lower. Refer to the information that came with your roof rack.

### Cargo Hooks/Hanger Bars

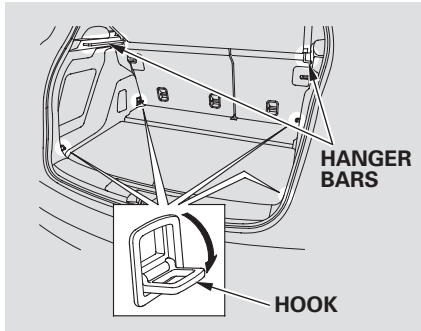

To secure the cargo, you can use the four cargo hooks on the cargo area. The illustration shows the location of each cargo hook.

The cargo hooks on the floor can be used to install the cargo net for securing items.

The hanger bars can be used to hang items. The hanger bar is designed to hang light items (maximum load: 11 lbs or 5 kg on each side). Heavy items may damage the bars.

### Optional Cargo Net

The cargo net can be used to help hold down light items in the cargo area. The cargo net may not prevent heavy items from being thrown forward in a crash or a sudden stop. Heavy items should be secured to the cargo area floor with the hooks or cinch straps attached to the cargo hooks.



This section gives you tips on starting the engine under various conditions, and how to operate the automatic transmission. It also includes important information on parking your vehicle, the braking system, the super handling-all wheel drive (SH-AWD) system, the vehicle stability assist (VSA) system, the tire pressure monitoring system (TPMS), and facts you need if you are planning to tow a trailer or drive off-highway.

Driving Guidelines.....	290
Preparing to Drive .....	291
Starting the Engine.....	292
Automatic Transmission.....	293
Driving with the Paddle Shifters.....	297
Super Handling-All Wheel Drive (SH-AWD) System .....	301
Parking .....	303
Braking System.....	304
Anti-lock Brakes (ABS) .....	305
Tire Pressure Monitoring System (TPMS) .....	307
Vehicle Stability Assist (VSA) System.....	312
Towing a Trailer .....	314
Off-Highway Driving Guidelines.....	321

## Driving Guidelines

---

Your vehicle has higher ground clearance that allows you to travel over bumps, obstacles, and rough terrain. It also provides good visibility so you can anticipate problems earlier.

Because your vehicle rides higher off the ground, it has a high center of gravity that can cause it to roll over if you make abrupt turns. Utility vehicles have a significantly higher roll over rate than other types of vehicles.

To prevent rollovers or loss of control:

- Take corners at slower speeds than you would with a passenger vehicle.
- Avoid sharp turns and abrupt maneuvers whenever possible.
- Do not modify your vehicle in any way that would raise the center of gravity.
- Do not carry heavy cargo on the roof.

Your vehicle is equipped with a super handling-all wheel drive (SH-AWD) system. When the system senses a loss of one or more wheel traction, it automatically transfers some power to the other wheels. This gives you better traction and mobility.

You still need to exercise the same care when accelerating, steering, and braking that you would in a two-wheel drive vehicle.

*See page 321 for off-highway driving guidelines.*

You should do these checks and adjustments before you drive your vehicle:

1. Make sure all windows, mirrors, and outside lights are clean and unobstructed. Remove frost, snow, or ice.
2. Check that the hood is fully closed.
3. Visually check the tires. If a tire looks low, use a gauge to check its pressure.
4. Check that any items you may be carrying are stored properly or fastened down securely.
5. Check the seat adjustment (see page 135).
6. Check the adjustment of the inside and outside mirrors (see page 144).
7. Check the steering wheel adjustment (see page 119).
8. Make sure the doors and the tailgate are securely closed and locked.
9. Fasten your seat belt. Check that your passengers have fastened their seat belts (see page 14).
10. When you start the engine, check the gauges and indicators in the instrument panel, and the messages on the multi-information display (see pages 61, 71 and 77).

## Starting the Engine

---

1. Apply the parking brake.
2. In cold weather, turn off all electrical accessories to reduce the drain on the battery.
3. Make sure the shift lever is in Park. Press on the brake pedal.
4. Without touching the accelerator pedal, turn the ignition key to the START (III) position. Do not hold the key in the START (III) position for more than 15 seconds at a time. If the engine does not start right away, pause for at least 10 seconds before trying again.

### NOTICE

*The immobilizer system protects your vehicle from theft. If an improperly-coded key (or other device) is used, the engine's fuel system is disabled. For more information, see page 121.*

5. If the engine does not start within 15 seconds, or starts but stalls right away, repeat step 4 with the accelerator pedal pressed halfway down. If the engine starts, release pressure on the accelerator pedal so the engine does not race.
6. If the engine fails to start, press the accelerator pedal all the way down, and hold it there while starting to clear flooding. If the engine still does not start, return to step 5.

### NOTICE

*The engine is harder to start in cold weather. Also, the thinner air found at altitudes above 8,000 feet (2,400 meters) adds to this problem.*

Your vehicle has an electric vacuum pump located in the engine compartment. When you drive in cold weather or thinner air at high altitude, the electric vacuum pump operates more frequently after the engine is started.

When the electric vacuum pump is in operation, it makes some mechanical noises come from the engine compartment. This is normal.



## Shift Lever Position Indicators

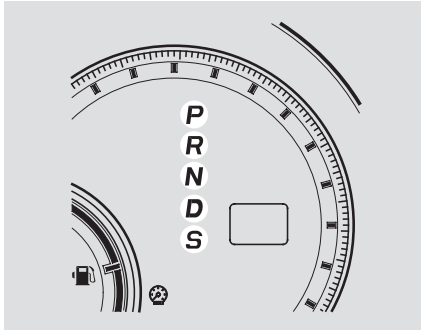

These indicators on the instrument panel show which position the shift lever is in.

The “D” indicator comes on for a few seconds when you turn the ignition switch to the ON (II) position. If it flashes while driving (in any shift position), it indicates a possible problem in the transmission.

If the malfunction indicator lamp comes on along with the “D” indicator, there is a problem with the automatic transmission control system. Avoid rapid acceleration, and have the transmission checked by your dealer as soon as possible.

When the “D” indicator warns of a possible problem with the transmission, you will see a “CHECK TRANSMISSION” message on the multi-information display (see page 78).

## Shifting

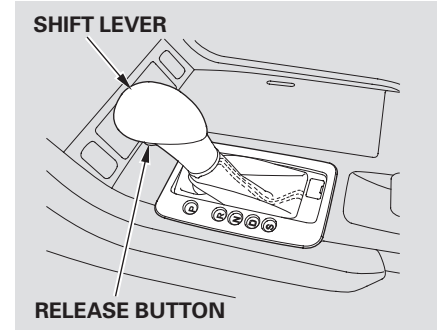

To shift from Park to any position, press firmly on the brake pedal and press the release button on the front of the shift lever, then pull the lever. You cannot shift out of Park when the ignition switch is in the LOCK (0) or the ACCESSORY (I) position.

*CONTINUED*

## Automatic Transmission

---

To shift from:	Do this:
P to R	Press the brake pedal, and press the shift lever release button.
R to P N to R D to S	Press the shift lever release button.
S to D D to N N to D R to N	Move the shift lever.

**Park (P)** – This position mechanically locks the transmission. Use Park whenever you are turning off or starting the engine. To shift out of Park, you must press on the brake pedal and have your foot off the accelerator pedal. Press the release button on the front of the shift lever to move it.

If you have done all of the above and still cannot move the lever out of Park, see **Shift Lock Release** on page [296](#).

To avoid transmission damage, come to a complete stop before shifting into Park. You must also press the release button to shift into Park. The shift lever must be in Park before you can remove the key from the ignition switch.

**Reverse (R)** – Press the brake pedal and press the release button on the front of the shift lever to shift from Park to reverse. To shift from reverse to neutral, come to a complete stop, and then shift. Press the release button before shifting into reverse from neutral.

**Neutral (N)** – Use neutral if you need to restart a stalled engine, or if it is necessary to stop briefly with the engine idling. Shift to the Park position if you need to leave your vehicle for any reason. Press on the brake pedal when you are moving the shift lever from neutral to another gear.

**Drive (D)** — Use this position for your normal driving. The transmission automatically adjusts to keep the engine at the best speed for the driving conditions.

**S position (S)** — To shift into the S position, press the release button on the front of the shift lever, and move the lever to S. This position is similar to D, except only gears from first to fourth are selected. The S position keeps the transmission from cycling between fourth and fifth gears in stop-and-go driving.

With the shift lever in D or S, you can also use the paddle shifters to shift the transmission up or down. Once you begin to use the paddle shifters in S, the transmission will no longer upshift or downshift automatically. For more information of driving with the paddle shifters, see page [297](#).

### Engine Speed Limiter

If you exceed the maximum speed for the gear you are in, the engine speed will enter into the tachometer's red zone. If this occurs, you may feel the engine cut in and out. This is caused by a limiter in the engine's computer controls. The engine will run normally when you reduce the rpm below the red zone.

## Automatic Transmission

### Shift Lock Release

This allows you to move the shift lever out of Park if the normal method of pushing on the brake pedal and pressing the release button does not work.

1. Set the parking brake.
2. Remove the key from the ignition switch.
3. Put a cloth on the notch of the shift lock release slot cover. Using a small flat-tipped screwdriver or a metal fingernail file, carefully pry on the notch of the cover to remove it.

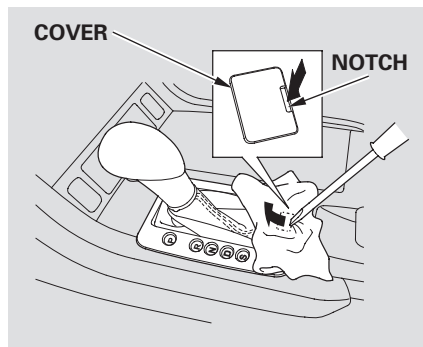

4. Insert the key in the shift lock release slot.
5. Push down on the key while you press the release button on the shift lever and move the shift lever out of Park to neutral.

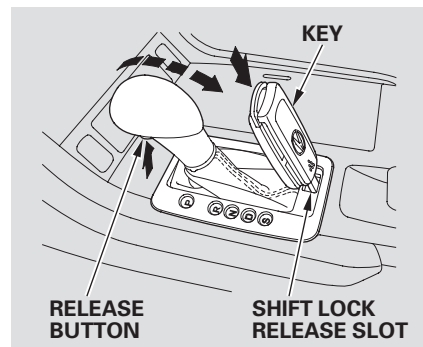

6. Remove the key from the shift lock release slot, then install the cover. Make sure the notch on the cover is on the rear. Return the key to the ignition switch, press the brake pedal, and restart the engine.

If you need to use the shift lock release, it means your vehicle is developing a problem. Have it checked by your dealer.

### Using the Paddle Shifters in D position (D-Paddle Shift Mode)

When you are driving in D position, pulling the either paddle shifter switches from the ordinary automatic transmission [drive mode (D)] to the D-paddle shift mode. You can shift the transmission up or down manually with the paddle shifters.

Downshifting gives you more power when climbing, and provides engine braking when going down a steep hill.

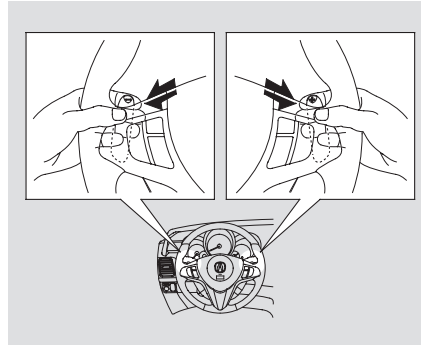

To shift up or down, use the + (right) or - (left) paddle shifter on each side of the steering wheel.

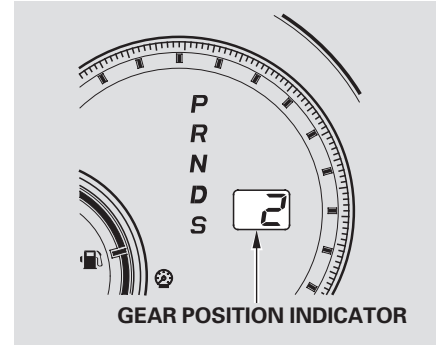

Each time you pull the + (right), the transmission shifts to a higher gear. Pull the - (left) to downshift. You will see the selected gear number on the instrument panel.

When you pull either paddle shifter, the gear position indicator shows you the selected gear number.

*CONTINUED*

## Driving with the Paddle Shifters

---

The transmission control system monitors the accelerator pedal use and your driving conditions. When you press the accelerator pedal as in normal driving, the system judges that you are driving at a constant cruising speed without using the paddle shifters. Under these conditions, D-paddle shift mode is canceled, and the transmission automatically returns to drive mode (D).

When the transmission returns to drive mode (D), the displayed gear number goes out.

The transmission remains in the selected gear if you do not accelerate.

Each time you pull either paddle shifter, the transmission shifts one gear up or down. If you want to shift up or down more than two gears, pull the paddle shifter twice, pause, and then pull it again.

The automatic transmission will not allow you to change shift if:

- You downshift before the engine speed reaches the upper limit of the lower gear.

If you try to do this, the gear position indicator will flash the number of the lower gear several times, then return to a higher gear.

- You upshift before the engine speed reaches the lower limit of the higher gear.
- You press both paddle shifters at the same time.
- You press one of the two paddle shifters with another paddle shifter being pressed.

The transmission downshifts to first gear and returns to drive mode (D) when the vehicle comes to a complete stop and the vehicle speed is about 6 mph (10 km/h).

If there is a problem in the transmission while you are driving with the paddle shifters, the D indicator flashes, the D-paddle shift mode is canceled, and the transmission returns to drive mode (D).

### Using the Paddle Shift in S position (Sequential Shift Mode)

With the shift lever in S position, you can select the sequential shift mode to shift gears; much like a manual transmission using the paddle shifters, but without a clutch pedal.

To enter the sequential shift mode, press the release button on the front of the shift lever, move the lever to the S position, then pull either paddle shifter. To cancel the sequential shift mode and return to the ordinary automatic transmission, move the shift lever from S position. When moving the shift lever, be careful not to operate incorrectly. While you are driving in the sequential shift mode, the transmission will not automatically return to ordinary automatic transmission.

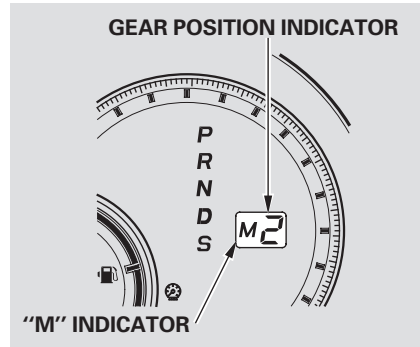

When you move the shift lever from “D” to “S” position and pull either paddle shifter, the gear position indicator displays on “M” along with the selected gear number.

To upshift, pull the + (right) paddle shifter. To downshift, pull the – (left) paddle shifter.

When you accelerate from a stop, the transmission starts in first gear, and you must manually upshift between first and fifth gears. Make sure you upshift before the engine speed reaches the tachometer’s red zone.

The transmission remains in the selected gear (5, 4, 3, 2, or 1). There is no automatic downshift when you push the accelerator pedal to the floor.

When you are driving in 4th or 5th gear, the transmission downshifts to the lower gear under the following conditions:

- The vehicle slows down to a certain speed.
- You press the brake pedal.

*CONTINUED*

## Driving with the Paddle Shifters

Downshifting with the paddle shifter allows you to increase the engine braking when going down steep or long hills, and provides more power when climbing uphill. You can upshift the transmission manually to reduce the rpm. Driving in the higher gear helps fuel economy.

The transmission also shifts automatically as the vehicle comes to a complete stop. It downshifts to first gear when the vehicle speed reaches 6 mph (10 km/h) or less.

The automatic transmission will not allow you to change shift if:

- You downshift before the engine speed reaches the upper limit of the lower gear.

If you try to do this, the gear position indicator will flash the number of the lower gear several times, then return to a higher gear.

- You upshift before the engine speed reaches the lower limit of the higher gear.
- You try to shift to third or a higher gear when the vehicle is stationary.
- You press both paddle shifters at the same time.
- You press one of the two paddle shifters with another paddle shifter being pressed.

Here are the speed ranges for upshifting and downshifting.

To shift from	Speed range
1 → 2	over 0 mph (0 km/h)
2 → 3	over 8 mph (13 km/h)
3 → 4	over 17 mph (27 km/h)
4 → 5	over 47 mph (75 km/h)

To shift from	Speed range
2 → 1	under 29 mph (47 km/h)
3 → 2	under 63 mph (100 km/h)
4 → 3	under 94 mph (150 km/h)
5 → 4	under 114 mph (182 km/h)



## Driving with the Paddle Shifters, Super Handling-All Wheel Drive (SH-AWD) System

### *Starting in Second Gear*

When you are in sequential shift mode, and the vehicle is stopped, pull the + (right) paddle shifter to shift to second gear. You will see “M 2” in the display. Starting in second gear helps to reduce wheelspin in deep snow or on a slippery surface.

### **Super Handling-All Wheel Drive (SH-AWD) system**

The super handling-all wheel drive (SH-AWD) system is a full time all-wheel-drive system that automatically controls and transfers varying amounts of engine torque to all wheels independently, according to the driving conditions.

While the SH-AWD system helps to enhance the vehicle's driving stability in all situations, it is still your responsibility to drive and corner at reasonable speeds and to leave a sufficient margin of safety.

### **SH-AWD Torque Distribution Monitor**

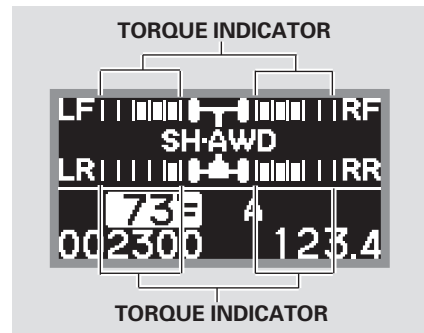

The SH-AWD torque distribution monitor on the multi-information display shows you the amount of torque being sent to the wheels. Each wheel: right front (RF), left front (LF), right rear (RR), and left rear (LR), has its own torque indicator.

*CONTINUED*

## Super Handling-All Wheel Drive (SH-AWD) System

---

Each torque indicator is displayed as a bar graph divided into 5 segments. The number of segments represents the amount of torque distributed to each wheel.

When there is only a slight change in torque distribution while driving, such as cruising on level roads at the same speed, the torque distribution monitor may stop displaying the amount of torque. This is not a system problem. The monitor will show the amount if the system senses any change in torque distribution.

If the SH-AWD indicator blinks while driving, it indicates the differential temperature is too high. You will also see an “SH-AWD DIFF TEMP HIGH” message on the multi-information display. If this happens, pull to the side of the road when it is safe, shift to Park, and let the engine idle until the indicator goes out. If the indicator does not go out, take your vehicle to a dealer to have it checked.

If the SH-AWD indicator on the instrument panel stays on, and the “CHECK SH-AWD SYSTEM” message also appears on the multi-information display, there is problem with the SH-AWD system.

Your vehicle still has normal front-wheel drive with vehicle stability assist (VSA), but does not have the advantages of SH-AWD. Have your vehicle checked by a dealer as soon as possible.

Always use the parking brake when you park your vehicle. Make sure the parking brake is set firmly, or your vehicle may roll if it is parked on an incline.

Set the parking brake before you put the transmission in Park. This keeps the vehicle from moving and putting pressure on the parking mechanism in the transmission.

### **Parking Tips**

- Make sure the moonroof and the windows are closed.
  - Turn off the lights.
  - Place any packages, valuables, etc. in the cargo area or take them with you.
  - Lock the doors and the tailgate.
  - Never park over dry leaves, tall grass, or other flammable materials. The hot three way catalytic converter could cause these materials to catch on fire.
- If the vehicle is facing uphill, turn the front wheels away from the curb.
  - If the vehicle is facing downhill, turn the front wheels toward the curb.
  - Check the indicator on the instrument panel to verify that the security system is set.
  - Make sure the parking brake is fully released before driving away. Driving with the parking brake partially set can overheat or damage the rear brakes.

## Braking System

---

Your vehicle is equipped with disc brakes at all four wheels. A power assist using negative pressure generated by the engine and the electric vacuum pump helps reduce the effort needed on the brake pedal. The anti-lock brake system (ABS) helps you retain steering control when braking very hard.

When the electric vacuum pump is in operation, it makes some mechanical noises come from the engine compartment. This is normal.

When you drive in cold weather or thinner air at high altitude, the electric vacuum pump operates more frequently after the engine is started.

For more information about the electric vacuum pump, see page [384](#).

Resting your foot on the pedal keeps the brakes applied lightly, builds up heat, and reduces their effectiveness and reduces brake pad life. In addition, fuel economy can be reduced. It also keeps your brake lights on all the time, confusing drivers behind you.

Constant application of the brakes when going down a long hill builds up heat and reduces their effectiveness. Use the engine to assist the brakes by taking your foot off the accelerator and downshifting to a lower gear.

Check your brakes after driving through deep water. Apply the brakes moderately to see if they feel normal. If not, apply them gently and frequently until they do. Be extra cautious and alert in your driving.

### **Braking System Design**

The hydraulic system that operates the brakes has two separate circuits. Each circuit works diagonally across the vehicle (the left-front brake is connected with the right-rear brake, etc.). If one circuit should develop a problem, you will still have braking at two wheels.

### **Brake Pad Wear Indicators**

All four brakes have audible brake wear indicators.

If the brake pads need replacing, you will hear a distinctive, metallic screeching sound when you apply the brake pedal. If you do not have the brake pads replaced, they will screech all the time. It is normal for the brakes to occasionally squeal or squeak when you apply them.

The anti-lock brake system (ABS) helps prevent the wheels from locking up, and helps you retain steering control by pumping the brakes rapidly, much faster than a person can do it.

The electronic brake distribution (EBD) system, which is part of the ABS, also balances the front-to-rear braking distribution according to vehicle loading.

*You should never pump the brake pedal.* Let the ABS work for you by always keeping firm, steady pressure on the brake pedal. This is sometimes referred to as “stomp and steer.”

You will feel a pulsation in the brake pedal when the ABS activates, and you may hear some noise. This is normal: it is the ABS rapidly pumping the brakes. On dry pavement, you will need to press on the brake pedal very hard before the ABS activates. However, you may feel the ABS activate immediately if you are trying to stop on snow or ice.



### ABS Indicator

If this indicator comes on, the anti-lock function of the braking system has shut down. The brakes still work like a conventional system, but without anti-lock. You should have your dealer inspect your vehicle as soon as possible.

You will also see a “CHECK ABS SYSTEM” message on the multi-information display (see page [78](#) ).

If the indicator comes on while driving, test the brakes as instructed on page [383](#) .

CONTINUED

## Anti-lock Brakes (ABS)

---

If the ABS indicator and the brake system indicator come on together, and the parking brake is fully released, the EBD system may also be shut down.

Test your brakes as instructed on page 383 . If the brakes feel normal, drive slowly and have your vehicle repaired by your dealer as soon as possible. Avoid sudden hard braking which could cause the rear wheels to lock up and possibly lead to a loss of control.

The VSA indicator will come on along with the ABS indicator.

**Important Safety Reminders**  
**ABS does not reduce the time or distance it takes to stop the vehicle.** It only helps with the steering control during braking.

**ABS will not prevent a skid that results from changing direction abruptly,** such as trying to take a corner too fast or making a sudden lane change. Always drive at a safe speed for the road and weather conditions.

**ABS cannot prevent a loss of stability.** Always steer moderately when you are braking hard. Severe or sharp steering wheel movement can still cause your vehicle to veer into oncoming traffic or off the road.

**A vehicle with ABS may require a longer distance to stop** on loose or uneven surfaces, such as gravel or snow, than a vehicle without anti-lock.

# Tire Pressure Monitoring System (TPMS)

Your vehicle is equipped with a tire pressure monitoring system (TPMS) that turns on every time you start the engine and monitors the pressure in your tires while driving.

Each tire has its own pressure sensor. If the air pressure of a tire becomes significantly low, the sensor in that tire immediately sends a signal that causes the low tire pressure/TPMS indicator in the instrument panel to come on. If this happens, you will see which tire is losing pressure on the multi-information display along with a “CHECK TIRE PRESSURE” message.



## Low Tire Pressure/ TPMS Indicator

When the low tire pressure/TPMS indicator is on, one or more of your tires is significantly underinflated. You should stop and check your tires as soon as possible, and inflate them to the proper pressure as indicated on the vehicle’s tire information placard.

It is possible that the pressures shown on the multi-information display and the pressures you manually measure are slightly different.

If the difference is significant or you cannot make the low tire pressure/TPMS indicator and message on the multi-information display go out after inflating the tires to the specified values, have your dealer check the system as soon as possible.

If you think you can safely drive a short distance to a service station, proceed slowly to the station, then inflate the tire to the recommended pressure.

If the tire is flat, or if the tire pressure is too low to continue driving, replace the tire with the compact spare tire (see page 370 ).

Driving on a significantly underinflated tire causes the tire to overheat and can lead to tire failure. Under-inflation also reduces fuel efficiency and tire tread life, and may affect the vehicle’s handling and stopping ability.

Because tire pressure varies by temperature and other conditions, the low tire pressure/TPMS indicator may come on unexpectedly.

*CONTINUED*

## Tire Pressure Monitoring System (TPMS)

For example, if you check and fill your tires in a warm area, then drive in extremely cold weather, the tire pressure will be lower than measured and could be underinflated and cause the low tire pressure/TPMS indicator to come on. Or, if you check and adjust your tire pressure in cooler conditions, and drive into extremely hot conditions, the tire may become overinflated. However, the low tire pressure/TPMS indicator will not come on if the tires are overinflated.

Refer to page [360](#) for tire inflation guidelines.

If there is a problem with the TPMS, this indicator begins to flash. It stops flashing after approximately 1 minute, then stays on. You will also see a “CHECK TPMS SYSTEM” message on the multi-information display (see page [310](#)).

Although your tire pressure is monitored, you must manually check the tire pressures monthly.

Each tire, including the spare, should be checked monthly when the vehicle is cold, and set to the recommended inflation pressure as specified on the vehicle placard and in the owner’s manual (see page [361](#)).

### Tire Pressure Monitor

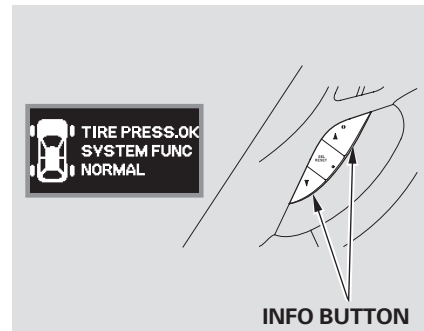

To select the tire pressure monitor, press the INFO button several times with the ignition switch in the ON (II) position.

You will see the above display on the multi-information display when all tire pressures are normal.



# Tire Pressure Monitoring System (TPMS)

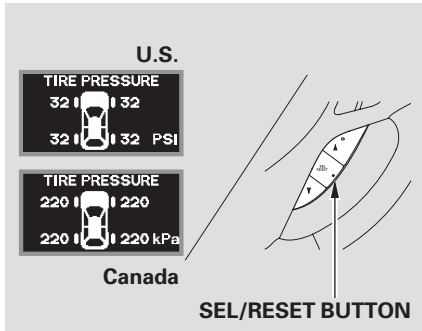

To see the inflation pressures of all four tires, press the SEL/RESET button. The display changes as shown above.

Each tire pressure is shown in PSI (U.S. models) or in kPa (Canadian models).

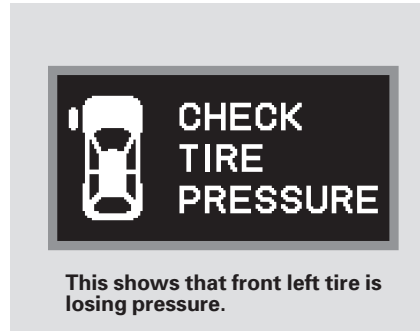

This shows that front left tire is losing pressure.

Each tire has its own pressure sensor. If the air pressure of a tire becomes significantly low, the sensor in that tire immediately sends a signal that causes the low tire pressure/TPMS indicator in the instrument panel to come on. If this happens, you will see which tire is losing pressure on the multi-information display along with a "CHECK TIRE PRESSURE" message.



If any of the tires has low pressure, the tire pressure monitor also shows above message to warn you about the low tire pressure when you select the display by pressing the INFO button several times. Following this display, press the SEL/RESET button to see each tire pressure. When you continue driving after installing the spare tire, you will also see this message on the multi-information display. *CONTINUED*

## Tire Pressure Monitoring System (TPMS)

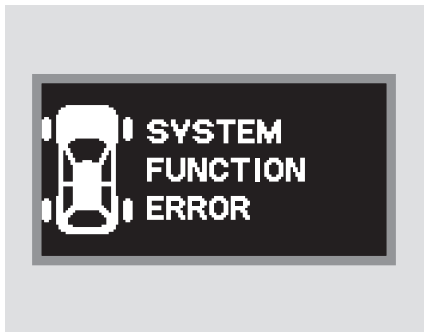

If there is a problem with the TPMS, the tire pressure monitor shows a “SYSTEM FUNCTION ERROR” message and the tire pressure readings are not displayed. If this happens, you will first see a system warning message “CHECK TPMS SYSTEM” on the multi-information display.

### TPMS System Failure

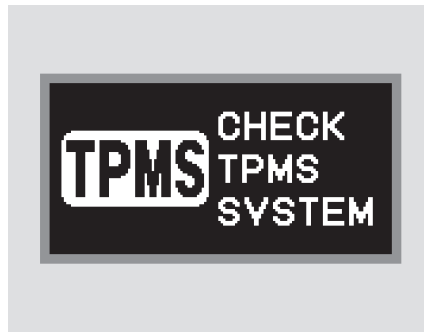

If there is a problem with the TPMS, you will see the above message on the multi-information display.

If you see this message, the system is off and is not monitoring the tire pressures. Have the system checked by your dealer as soon as possible.

Also, the low tire pressure/TPMS indicator begins to flash (see page [69](#) ).

If the low tire pressure/TPMS indicator comes on, or the multi-information display shows a “CHECK TPMS SYSTEM” message, the VSA system automatically turns on even when the VSA system is turned off by pressing the VSA OFF switch (see page [313](#) ). If this happens, you cannot turn the VSA system off by pressing the VSA OFF switch again.

When you restart the vehicle with the compact spare tire, the TPMS system message will also be displayed on the multi-information display after several miles (kilometers) driving.

# Tire Pressure Monitoring System (TPMS)

## Changing a Tire with TPMS

If you have a flat tire, the low tire pressure/TPMS and tire monitor indicators will come on. Replace the indicated flat tire with the compact spare tire (see page 370).

After the flat tire is replaced with the spare tire, the low tire pressure/TPMS indicator stays on while driving. After several miles (kilometers) driving, this indicator begins to flash, then stays on again. You will also see a “CHECK TPMS SYSTEM” message on the multi-information display. This is normal; the system cannot monitor the spare tire pressure. Manually check the spare tire pressure to be sure it is correct.

This indicator and the warning message on the multi-information display will go off, after several miles (kilometers) driving, when the spare tire is replaced with the specified

regular tire equipped with the tire pressure monitor sensor.

Each wheel is equipped with a tire pressure sensor mounted inside the tire behind the valve stem. You must use TPMS specific wheels. It is recommended that you always have your tires serviced by your dealer or a qualified technician.

Never use a puncture-repairing agent in a flat tire. If used, you will have to replace the tire pressure sensor. Have the flat tire repaired by your dealer as soon as possible.

*As required by the FCC:*

*This device complies with Part 15 of the FCC rules. Operation is subject to the following two conditions: (1) This device may not cause harmful interference, and (2) this device must accept any interference received, including interference that may cause undesired operation.*

*Changes or modifications not expressly approved by the party responsible for compliance could void the user's authority to operate the equipment.*

*This device complies with Industry Canada Standard RSS-210. Operation is subject to the following two conditions: (1) this device may not cause interference, and (2) this device must accept any interference that may cause undesired operation of the device.*

## Vehicle Stability Assist (VSA) System

---

The vehicle stability assist (VSA) system helps to stabilize the vehicle during cornering if the vehicle turns more or less than desired. It also assists you in maintaining traction while accelerating on loose or slippery road surfaces. It does this by regulating the engine's output and by selectively applying the brakes.

When VSA activates, you may notice that the engine does not respond to the accelerator in the same way it does at other times. There may also be some noise from the VSA hydraulic system. You will also see the VSA activation indicator blink.

The VSA system cannot enhance the vehicle's driving stability in all situations and does not control your vehicle's entire braking system. It is still your responsibility to drive and corner at reasonable speeds and to leave a sufficient margin of safety.



### VSA Activation Indicator

When VSA activates, you will see the VSA activation indicator blink (see page 67 ).



### Vehicle Stability Assist (VSA) System Indicator

If this indicator comes on while driving, pull to the side of the road when it is safe, and turn off the engine. Reset the system by restarting the engine. If the VSA system indicator stays on or comes back on while driving, have the VSA system inspected by your dealer.

If the indicator does not come on when the ignition switch is turned to the ON (II) position, there may be a problem with the VSA system. Have your dealer inspect your vehicle as soon as possible.

You will also see a “CHECK VSA SYSTEM” message on the multi-information display if there is a problem with the VSA system.

If the low tire pressure/TPMS indicator comes on (see page 307 ), or the multi-information display shows a “CHECK TPMS SYSTEM” message with the indicator flashing (see page 310 ), the VSA system automatically turns on even when the VSA system is turned off with the VSA OFF switch. In this case, you cannot turn the VSA system off by pressing the VSA OFF switch again.

Without VSA, your vehicle will have normal braking and cornering ability, but it will not have VSA traction and stability enhancement.

### VSA Off Switch

In certain unusual conditions when your vehicle gets stuck in shallow mud or fresh snow, it may be easier to free it with the VSA temporarily switched off. When the VSA system is off, the traction control system is also off. You should only attempt to free your vehicle with the VSA off if you are not able to free it when the VSA is on.

Immediately after freeing your vehicle, be sure to switch the VSA on again. We do not recommend driving your vehicle with the VSA and traction control systems switched off.

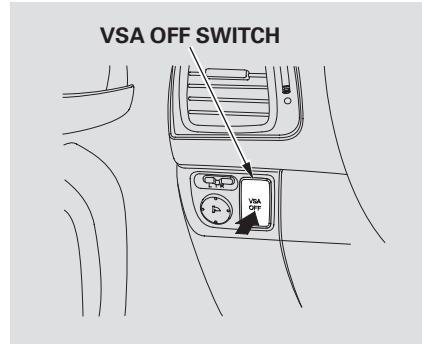

This switch is under the driver's side vent. To turn the VSA system on and off, press and hold it until you hear a beep.

When VSA is off, the VSA activation indicator comes on as a reminder.

VSA is turned on every time you start the engine, even if you turned it off the last time you drove the vehicle.

### VSA and Tire Sizes

Driving with varying tire or wheel sizes may cause the VSA to malfunction. When replacing tires, make sure they are the same size and type as your original tires (see page 364).

If you install winter tires, make sure they are the same size as those that were originally supplied with your vehicle. Exercise the same caution during winter driving as you would if your vehicle was not equipped with VSA.

## Towing a Trailer

Your vehicle has been designed primarily to carry passengers and their cargo. You can also use it to tow a trailer if you carefully observe the load limits, use the proper equipment, and follow the guidelines in this section.

Be sure to read the **Off-Highway Driving Guidelines** section on page [321](#) if you plan to tow off paved surfaces.

### **⚠ WARNING**

Exceeding any load limit or improperly loading your vehicle and trailer can cause a crash in which you can be seriously hurt or killed.

Check the loading of your vehicle and trailer carefully before starting to drive.

### Load Limits

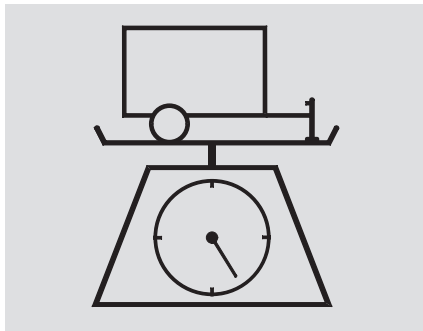

**Total Trailer Weight:** The maximum allowable weight of the trailer and everything in or on it must not exceed 1,500 lbs (680 kg). Towing a load that is too heavy can seriously affect your vehicle's handling and performance. It can also damage the engine and drivetrain.

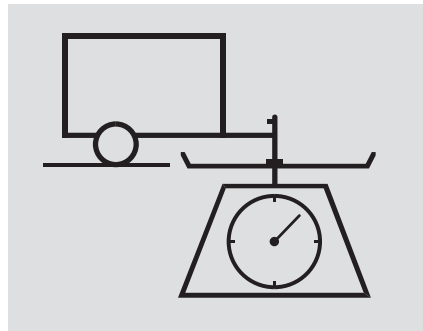

**Tongue Load:** The weight that the tongue of a fully-loaded trailer puts on the hitch should be approximately 10 % of the total trailer weight. Too much tongue load reduces front-tire traction and steering control. Too little tongue load can make the trailer unstable and cause it to sway.

To achieve a proper tongue load, start by loading 60 % of the load toward the front of the trailer and 40 % toward the rear, then re-adjust the load as needed.

**Gross Vehicle Weight Rating (GVWR)** – The maximum allowable weight of the vehicle, all occupants, all accessories, all cargo, and the tongue load is 4,894 lbs (2,220 kg).

**Gross Axle Weight Ratings (GAWR)** – The maximum allowable weight of the vehicle, all occupants, all accessories, all cargo, and the tongue load must not exceed 2,546 lbs (1,155 kg) on the front axle, and 2,381 lbs (1,080 kg) on the rear axle.

**Gross Combined Weight Rating (GCWR)** – The maximum allowable weight of the fully loaded vehicle and trailer is 6,394 lbs (2,900 kg)

### Checking Loads

The best way to confirm that all loads are within limits is to check them at a public scale. For public scales in your area, check your local phone book, or contact your trailer dealer or rental agency for assistance.

If you cannot get to a public scale, you can estimate the total trailer weight by adding the weight of your trailer (as quoted by the manufacturer) with everything in or on the trailer.

If you normally pull the same load each time you tow a trailer, you can use a suitable scale or a special tongue load gauge to check the tongue load the first time you set up a towing combination (a fully loaded vehicle and trailer), then recheck the tongue load whenever the conditions change.

### Towing Equipment and Accessories

Towing can require a variety of equipment, depending on the size of your trailer, how it will be used, how much load you are towing, and where you tow.

Discuss your needs with your trailer sales or rental agency, and follow the guidelines in this section. Also make sure that all equipment is properly installed and maintained, and that it meets federal, state, province, and local regulations.

*CONTINUED*

## Towing a Trailer

---

### ***Hitches***

Any hitch used on your vehicle must be properly bolted to the underbody.

### ***Safety Chains***

Always use safety chains when you tow a trailer. Make sure the chains are secured to the trailer and hitch, and that they cross under the tongue and can catch the trailer if it becomes unhitched. Leave enough slack to allow the trailer to turn corners easily, but do not let the chains drag on the ground.

### ***Trailer Brakes***

Acura requires that any trailer with a total trailer weight of 1,000 lbs (455 kg) or more have its own brakes.

If you choose electric brakes, be sure they are electronically actuated. Do not attempt to tap into your vehicle's hydraulic system. No matter how successful it may seem, any attempt to attach trailer brakes to your vehicle's hydraulic system will lower braking effectiveness and create a potential hazard.

See your trailer dealer or rental agency for more information on installing electric brakes.

### ***Trailer Lights***

Trailer lights and equipment must comply with federal, state/province, and local regulations. Check with your local trailer sales or rental agencies for the requirements in the area where you plan to tow, and use only equipment designed for your vehicle.



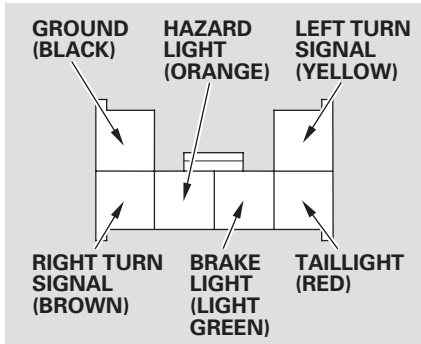

Your vehicle has a trailer lighting connector located under the right side tool case in the cargo area. Refer to the drawing above for the wiring color code and purpose of each pin.

Since lighting and wiring vary by trailer type and brand, you should have a qualified technician install a suitable connector between the vehicle and the trailer. Improper equipment or installation can cause damage to your vehicle's electrical system and affect your vehicle warranty.

### *Additional Towing Equipment*

Many states and Canadian provinces require special outside mirrors when towing a trailer. Even if they don't, you should install special mirrors if you cannot clearly see behind you, or if the trailer creates a blind spot.

Ask your trailer sales or rental agency if any other items are recommended or required for your towing situation.

## Towing a Trailer

---

### Pre-Tow Checklist

When preparing to tow, and before driving away, be sure to check the following:

- The vehicle has been properly serviced, and the suspension, cooling system, and lights are in good operating condition.
- The trailer has been properly serviced and is in good condition.
- All weights and loads are within limits.
- The hitch, safety chains, and any other attachments are secure.
- All items in or on the trailer are properly secured and cannot shift while you drive.
- The lights and brakes on your vehicle and the trailer are working properly.
- Your vehicle tires and spare are properly inflated, and the trailer tires and spare are inflated as recommended by the trailer maker.
- You may want to fill the fuel tank with premium fuel. Premium fuel provides improved performance.

### **Driving Safely With a Trailer**

The added weight, length, and height of a trailer will affect your vehicle's handling and performance, so driving with a trailer requires some special driving skills and techniques.

For your safety and the safety of others, take time to practice driving maneuvers before heading for the open road, and follow the guidelines in this section.

### ***Towing Speeds and Gears***

Drive slower than normal in all driving situations, and obey posted speed limits for vehicles with trailers. Use the D position when towing a trailer on level roads. See “***Driving on Hills***” in the next column for additional gear information. Do not exceed 55 mph (88 km/h). At higher speeds, the trailer may sway or affect vehicle handling.

### ***Making Turns and Braking***

Make turns more slowly and wider than normal. The trailer tracks a smaller arc than your vehicle, and it can hit or run over something the vehicle misses. Allow more time and distance for braking. Do not brake or turn suddenly as this could cause the trailer to jackknife or turn over.

### ***Driving on Hills***

When climbing hills, closely watch your temperature gauge (see page 76 ). If it nears the H (Hot) mark, turn the A/C off, reduce speed and, if necessary, pull to the side of the road to let the engine cool.

When driving down hills, reduce your speed, and shift down to S position, or use the paddle shift to the lower gear (3, 2 or 1) in the S position. When towing a trailer, do not “ride” the brakes, and remember, it will take longer to slow down and stop when towing a trailer.

CONTINUED

## Towing a Trailer

---

If you must stop when facing uphill, use the foot brake or parking brake. Do not try to hold the vehicle in place by pressing on the accelerator, as this can cause the automatic transmission to overheat.

### ***Handling Crosswinds and Buffeting***

Crosswinds and air turbulence caused by passing trucks can disrupt your steering and cause the trailer to sway. When being passed by a large vehicle, keep a constant speed, and steer straight ahead. Do not try to make quick steering or braking corrections.

### ***Backing Up***

Always drive slowly and have someone guide you when backing up. Grip the *bottom* of the steering wheel; then turn the wheel to the left to get the trailer to move to the left, and turn the wheel right to move the trailer to the right.

### ***Parking***

Follow all normal precautions when parking, including putting the transmission in Park and firmly setting the parking brake. Also, place wheel chocks at each of the trailer's tires.

## General Information

Your vehicle has been designed primarily for use on pavement. But its higher ground clearance and super handling-all wheel drive (SH-AWD) system allow you to occasionally travel on unpaved roads, to campgrounds, picnic sites, and similar locations. It is not designed for trailblazing, mountain climbing, or other challenging off-road activities.

If you decide to drive on unpaved roads, you will find that it requires somewhat different driving skills. Your vehicle will also handle somewhat differently than it does on pavement. So be sure to read this owner's manual, pay special attention to the precautions and tips in this section, and get acquainted with your vehicle before you leave the pavement.

## WARNING

Improperly operating this vehicle on or off pavement can cause an accident or rollover in which you and your passengers could be seriously injured or killed.

- Follow all instructions and guidelines in this owner's manual.
- Keep your speed low, and don't drive faster than conditions permit.

## Important Safety Precautions

To avoid loss of control or rollover, be sure to follow all precautions and recommendations.

- Be sure to store cargo properly, and do not exceed your vehicle cargo load limits (see pages [284](#) and [314](#)).
- Wherever you drive, make sure you and your passengers always wear seat belts.
- Keep your speed low, and never go faster than the conditions allow.
- It's up to you to continually assess the situation and drive within the limits.

## Off-Highway Driving Guidelines

---

### Check Out Your Vehicle

Before you leave the pavement, be sure to do all scheduled maintenance and service, and inspect your vehicle for any problems. Pay special attention to the condition of the tires, and check the tire pressures.

After you return to the pavement, carefully inspect your vehicle to make sure there is no damage that could make driving it unsafe. Recheck the condition of the tires and the tire pressures.

### Remember

The route presents limits (too steep or bumpy roads). You have limits (driving skill and comfort). And your vehicle has limits (traction, stability, and power).

Driving off-highway can be hazardous if you fail to recognize limits and take the proper precautions.

### Accelerating and Braking

For better traction on all surfaces, accelerate slowly and gradually build up speed. If you try to start too fast on wet soil, mud, snow, or ice, you might not have enough traction to get underway, and you may dig yourself a hole. Starting with the shift lever in D position will help you have a smoother start on snow or ice.

Keep in mind that you will usually need more time and distance to brake to a stop on unpaved surfaces. Avoid hard braking. Do not “pump” the brakes; let the anti-lock braking system pump them for you.

### Avoiding Obstacles

Debris in the road can damage your suspension or other components. Because your vehicle has a high center of gravity, driving over a large obstacle, or allowing a wheel to drop into a deep hole can cause your vehicle to tip or roll over.

### Driving on Slopes

If you can't clearly see all conditions or obstacles on a slope, walk the slope before you drive on it. If you have any doubt whether or not you can safely drive on the slope, don't do it. Find another route.

If you are driving up a hill and find that you cannot continue, *do not try to turn around*. Your vehicle could roll over. Slowly back down the hill, following the same route you took up the hill.

### Crossing a Stream

Avoid driving through deep water. If you encounter water in your route (a small stream or large puddle, for example), evaluate it carefully before going ahead. Make sure it is shallow, flowing slowly, and has firm ground underneath. If you are not sure of the depth or the ground, turn around and find another route.

Driving through deep water can also damage your vehicle. The water can get into the transmission and differential, diluting the lubricant and causing an eventual failure. It can also wash the grease out of the wheel bearings.

### If You Get Stuck

Avoid driving on soft sand, deep mud, or other surfaces where you could get stuck. If you do happen to get stuck because of inclement weather or other conditions, choose a safe and appropriate course of action.

You should never use a jack to try getting unstuck. A jack only works on firm, level ground. Also, your vehicle could easily slip off the jack and hurt you or someone else.

If you spin the wheels excessively trying to get unstuck, you may overheat the components of the SH-AWD system. The SH-AWD indicator on the instrument panel will blink to indicate the rear differential temperature is too high.

You will also see an “SH-AWD DIFF TEMP HIGH” message on the multi-information display (see page 78 ).

If this happens, stop and allow everything to cool down. The SH-AWD indicator goes off after the rear differential temperature drops.





This section explains why it is important to keep your vehicle well maintained and how to follow basic maintenance safety precautions.

This section also includes instructions on how to read the maintenance minder messages on the multi-information display, and instructions for simple maintenance tasks you may want to take care of yourself.

If you have the skills and tools to perform more complex maintenance tasks on your vehicle, you may want to purchase the service manual. See page 413 for information on how to obtain a copy, or see your dealer.

Maintenance Safety .....	326
Maintenance Minder.....	327
Fluid Locations.....	335
Adding Engine Oil .....	336
Required Engine Oil.....	336
Changing the Engine Oil and Filter .....	338
Engine Coolant.....	340
Windshield Washers .....	342
Automatic Transmission Fluid....	343
Brake Fluid .....	345
Power Steering Fluid.....	346
Lights .....	347
Cleaning the Seat Belts.....	354
Floor Mats .....	354
Audio Antenna .....	355
Intercooler .....	355
Dust and Pollen Filter .....	355
Wiper Blades.....	356
Wheels .....	359
Tires .....	360
Checking the Battery .....	366
Vehicle Storage.....	368

## Maintenance Safety

---

All service items not detailed in this section should be performed by a certified technician or other qualified mechanic.

### Important Safety Precautions

To eliminate potential hazards, read the instructions before you begin, and make sure you have the tools and skills required.

- Make sure your vehicle is parked on level ground, the parking brake is set, and the engine is off.
- To clean parts, use a commercially available degreaser or parts cleaner, not gasoline.
- To reduce the possibility of fire or explosion, keep cigarettes, sparks, and flames away from the battery and all fuel-related parts.
- Wear eye protection and protective clothing when working with the battery or compressed air.

### **WARNING**

Improperly maintaining this vehicle, or failing to correct a problem before driving can cause a crash in which you can be seriously hurt or killed.

Always follow the inspection and maintenance recommendations and schedules in this owner's manual.

### Potential Vehicle Hazards

- **Carbon Monoxide poison from engine exhaust.** Be sure there is adequate ventilation whenever you operate the engine.
- **Burns from hot parts.** Let the engine and exhaust system cool down before touching any parts.

- **Injury from moving parts.** Do not run the engine unless instructed to do so.

### **WARNING**

Failure to properly follow maintenance instructions and precautions can cause you to be seriously hurt or killed.

Always follow the procedures and precautions in this owner's manual.

Some of the most important safety precautions are given here. However, we cannot warn you of every conceivable hazard that can arise in performing maintenance. Only you can decide whether or not you should perform a given task.

One of the most convenient and important features of the multi-information display on your vehicle is the maintenance minder.

Based on engine operating conditions and accumulated engine revolutions, the onboard computer in your vehicle calculates the remaining engine oil life.

The system also displays the code for other scheduled maintenance items needing service.

## Engine Oil Life

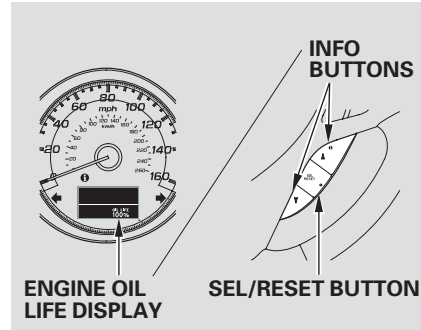

To see the current engine oil life, turn the ignition switch to the ON (II) position, and push and release the INFO (▲/▼) button on the steering wheel repeatedly, until the engine oil life is displayed (see page [73](#) ).

The remaining engine oil life is shown on the display according to this table:

Calculated Engine Oil Life (%)	Displayed Engine Oil Life (%)
100%–91%	100%
90%–81%	90%
80%–71%	80%
70%–61%	70%
60%–51%	60%
50%–41%	50%
40%–31%	40%
30%–21%	30%
20%–16%	20%
15%–11%	15%
10%–6%	10%
5%–1%	5%
0%	0%

CONTINUED

## Maintenance Minder



When the remaining engine oil life is 15 to 6 percent, the multi-information display shows a “SERVICE DUE SOON” message along with the maintenance schedule code indicating the main and sub items required at the time of the oil change. Refer to page [334](#) for a complete list of the maintenance main items and sub items.

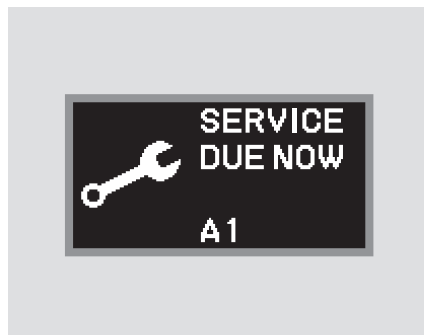

When the remaining oil life is 1 to 5 percent, the multi-information display shows a “SERVICE DUE NOW” message with the same maintenance items “SERVICE DUE SOON” was displayed with. When you see this message have the indicated maintenance performed as soon as possible.

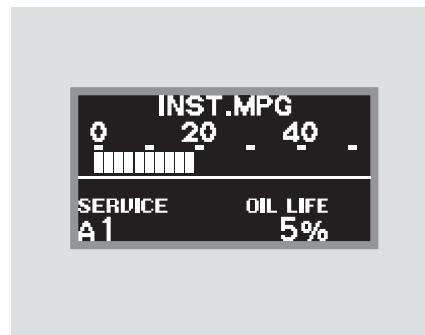

Press the SEL/RESET button on the steering wheel repeatedly to select the engine oil life. The message “SERVICE”, along with “5%”, and the maintenance item code are displayed on the lower part of the multi-information display when the calculated engine oil life is 1–5 percent (see page [327](#)).



If the indicated maintenance service is not done and the remaining engine oil life reaches 0%, the multi-information display will show the message “SERVICE PAST DUE” and the maintenance item code(s). This message is displayed when the total mileage is less than 10 miles (for U.S. models) or 10 km (for Canadian models) after the engine oil life became 0%.

These messages will come on every time you turn the ignition switch to the ON (II) position.

Immediately have the service performed, and make sure to reset the oil life minder as previously described.

The message will be canceled if the ▼ or ▲ button on the steering wheel is pressed. Press the ▼ or ▲ button to see the message again.

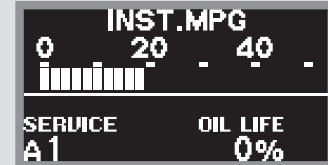

Press the SEL/RESET button on the steering wheel repeatedly to select the engine oil life. The message “SERVICE”, along with “0%”, and the maintenance item code are displayed on the lower part of the multi-information display when the calculated engine oil life is 0–1%.

Maintenance

CONTINUED

## Maintenance Minder

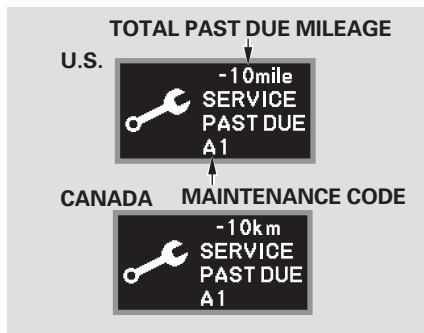

If the indicated required service is not done and the remaining engine oil life becomes 0%, the multi-information display will show a “SERVICE PAST DUE” message, the total mileage after the remaining oil life became 0%, and the maintenance item code(s).

This message is displayed when you drive over 10 miles (for U.S. models) or 10 km (for Canadian models) after seeing the 0% message.

Immediately have the service performed, and make sure to reset the display as previously described.

The message will be canceled if the ▼ or ▲ button on the steering wheel is pressed. Press the ▼ or ▲ button to see the message again.

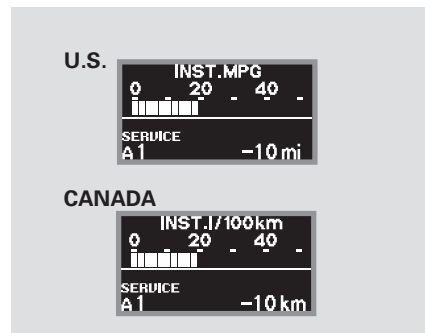

When you press the SEL/RESET button to select the engine oil life, the message “SERVICE”, along with the maintenance item code and the total negative mileage after the oil life became 0 %, will be displayed on the lower part of the multi-information display.

## Maintenance Main Items and Sub Items

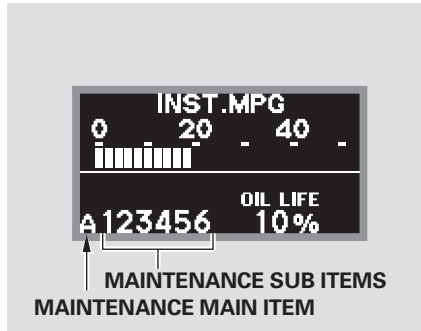

All the maintenance items displayed in the multi-information display are in code.

For an explanation of the maintenance codes, see page [334](#).

## Resetting the Engine Oil Life Display

Your dealer will reset the display after completing the required maintenance service. You will see “OIL LIFE 100%” on the display the next time you turn the ignition switch to the ON (II) position.

If maintenance service is done by someone other than your dealer, reset the maintenance minder as follows:

1. Turn the ignition switch to the ON (II) position.
2. Press the SEL/RESET button on the steering wheel until you see the engine oil life display.

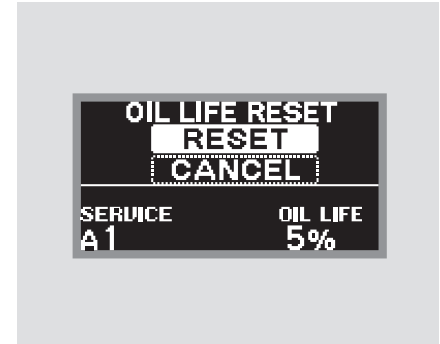

3. Press and hold the SEL/RESET button on the steering wheel for more than 10 seconds. The remaining engine oil life reset mode will be shown on the multi-information display.

*CONTINUED*

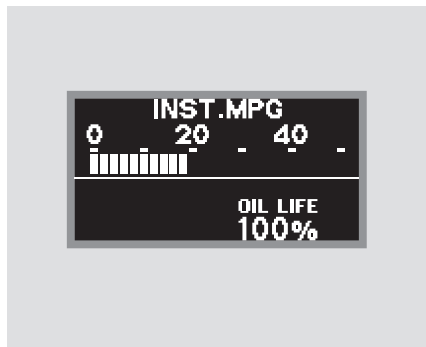

4. Select “RESET” by pressing the INFO (▲/▼) button, then press the SEL/RESET button to reset the engine oil life display. The maintenance item code(s) will disappear, and the engine oil life will reset to “100.” If you want to cancel the oil life reset mode, select “CANCEL.”

### Important Maintenance Precautions

If you have the required service done but do not reset the display, or reset the display without doing the service, the system will not show the proper maintenance intervals. This can lead to serious mechanical problems because you will no longer have an accurate record of when maintenance is needed.

Your authorized dealer knows your vehicle best and can provide competent, efficient service. However, service at a dealer is not mandatory to keep your warranties in effect. Maintenance may be done by any qualified service facility or person who is skilled in this type of automotive service. Keep all receipts as proof of completion, and have the person who does the work fill out your Maintenance Journal or Canadian Maintenance Log. Check your warranty booklet for more information.

We recommend using Acura parts and fluids whenever you have maintenance done. These are manufactured to the same high-quality standards as the original components, so you can be confident of their performance and durability.



U.S. Vehicles: **Maintenance, replacement, or repair of emissions control devices and systems may be done by any automotive repair establishment or individual using parts that are “certified” to EPA standards.**

According to state and federal regulations, failure to perform maintenance on the items marked with # will not void your emissions warranties. However, Acura recommends that all maintenance services be performed in accordance with the intervals indicated by the Multi-Information Display.

### Owner’s Maintenance Checks

You should check the following items at the specified intervals. If you are unsure of how to perform any check, turn to the appropriate page listed.

- Engine oil level — Check every time you fill the fuel tank. See page [276](#).
- Engine coolant level — Check the radiator reserve tank every time you fill the fuel tank. See page [277](#).
- Automatic transmission — Check the fluid level monthly. See page [343](#).

- Brakes — Check the fluid level monthly. See page [345](#).
- Tires — Check the tire pressure monthly. Examine the tread for wear and foreign objects. See page [361](#).
- Lights — Check the operation of the headlights, parking lights, taillights, high-mount brake light, and license plate lights monthly. See page [347](#).

# Maintenance Minder

Symbol	Maintenance Main Items
A	<ul style="list-style-type: none"> <li>● Replace engine oil*<sup>1</sup></li> </ul>
B	<ul style="list-style-type: none"> <li>● Replace engine oil*<sup>1</sup> and oil filter</li> <li>● Inspect front and rear brakes</li> <li>● Check parking brake adjustment</li> <li>● Inspect these items:                             <ul style="list-style-type: none"> <li>● Tie rod ends, steering gear box, and boots</li> <li>● Suspension components</li> <li>● Driveshaft boots</li> <li>● Brake hoses and lines (including ABS)</li> <li>● All fluid levels and condition of fluids</li> <li>● Exhaust system<sup>#</sup></li> <li>● Fuel lines and connections<sup>#</sup></li> </ul> </li> </ul>

\* 1 : If the message "SERVICE DUE NOW" does not appear more than 12 months after the display is reset, change the engine oil every year.

# : See information on maintenance and emissions warranty on page 333.

NOTE: ● Independent of the maintenance items in the information display, replace the brake fluid every 3 years.  
 ● Inspect idle speed every 160,000 miles (256,000 km).  
 ● Adjust the valves during services A, B, 1, 2, or 3 only if they are noisy.

Symbol	Maintenance Sub Items
1	<ul style="list-style-type: none"> <li>● Rotate tires</li> </ul>
2	<ul style="list-style-type: none"> <li>● Replace air cleaner element If you drive in dusty conditions, replace every 15,000 miles (24,000 km).</li> <li>● Replace dust and pollen filter If you drive primarily in urban areas that have high concentrations of soot in the air from industry and from diesel-powered vehicles, replace every 15,000 miles (24,000 km).</li> <li>● Inspect drive belt</li> </ul>
3	<ul style="list-style-type: none"> <li>● Replace transmission and transfer fluid Driving in mountainous areas at very low vehicle speeds or trailer towing results in higher transmission and transfer temperatures. This requires transmission and transfer fluid changes more frequently than recommended by the maintenance minder. If you regularly drive your vehicle under these conditions, have the transmission and transfer fluid changed at 60,000 miles (100,000 km), then every 30,000 miles (48,000 km).</li> </ul>
4	<ul style="list-style-type: none"> <li>● Replace spark plugs</li> <li>● Inspect valve clearance</li> </ul>
5	<ul style="list-style-type: none"> <li>● Replace engine coolant</li> </ul>
6	<ul style="list-style-type: none"> <li>● Replace rear differential fluid Driving in mountainous areas at very low vehicle speeds or trailer towing results in higher level of mechanical (shear) stress to fluid. This requires differential fluid changes more frequently than recommended by the Maintenance Minder. If you regularly drive your vehicle under these conditions, have the differential fluid changed at 7,500 miles (12,000 km), then every 15,000 miles (24,000 km).</li> </ul>

## Fluid Locations

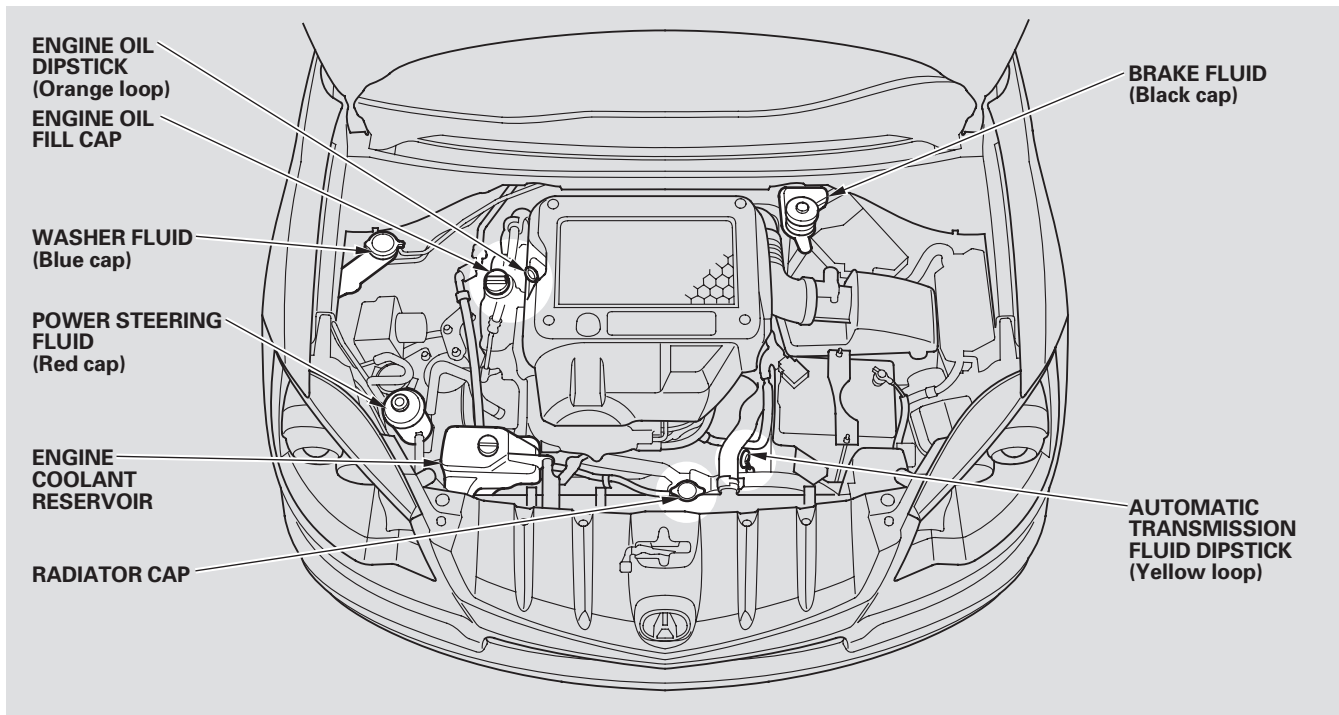

## Adding Engine Oil

---

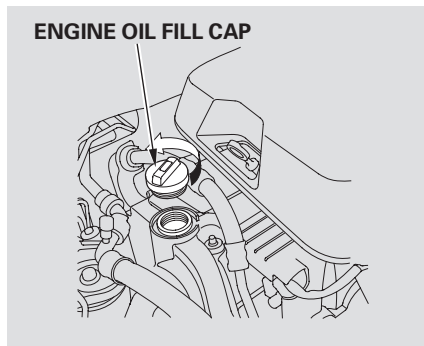

Unscrew and remove the engine oil fill cap on top of the valve cover. Pour in the oil slowly and carefully so you do not spill. Clean up any spills immediately. Spilled oil could damage components in the engine compartment.

Reinstall the engine oil fill cap, and tighten it securely. Wait a few minutes, and recheck the oil level on the engine oil dipstick. Do not fill above the upper mark; you could damage the engine.

### Required Engine Oil

Oil is a major contributor to your engine's performance and longevity. Your vehicle is equipped with a high-performance turbocharged engine that requires the use of synthetic motor oil. Always use Mobil 1<sup>®</sup> 5W-30 or an equivalent oil that meets the Acura HTO-06 standard. Not all synthetic oils will meet this standard. Only use oils that display the HTO-06 standard on the label.

Failure to use Mobil 1<sup>®</sup> or an equivalent oil that meets the HTO-06 standard can lead to a reduction in engine performance or durability, and can cause engine damage not covered by your warranty.

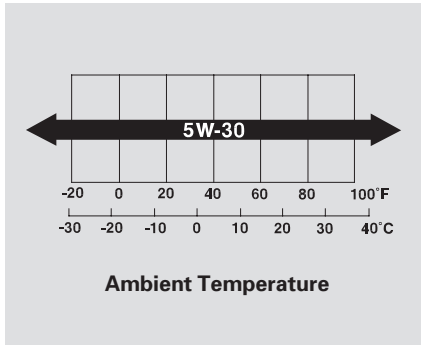

The oil viscosity or weight is provided on the container's label. 5W-30 oil is formulated for year-round protection of your vehicle to improve cold weather starting and fuel economy.

### Engine Oil Additives

Your vehicle does not require any oil additives. Additives may adversely affect the engine or transmission performance and durability.

## Changing the Engine Oil and Filter

Always change the oil and filter according to the maintenance messages shown on the multi-information display. The oil and filter collect contaminants that can damage your engine if they are not removed regularly.

Changing the oil and filter requires special tools and access from underneath the vehicle. The vehicle should be raised on a service station-type hydraulic lift for this service. Unless you have the knowledge and proper equipment, you should have this maintenance done by a skilled technician.

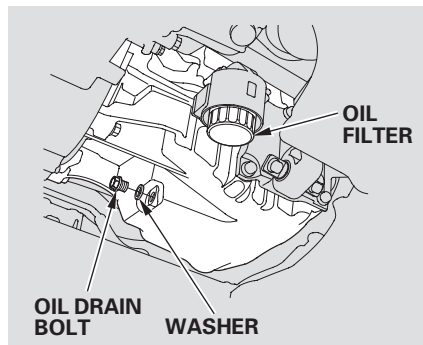

1. Run the engine until it reaches normal operating temperature, then shut it off.
2. Open the hood, and remove the engine oil fill cap. Remove the oil drain bolt and washer from the bottom of the engine. Drain the oil into an appropriate container.

3. Remove the oil filter, and let the remaining oil drain. A special wrench (available from your dealer) is required.
4. Check the oil filter to make sure its gasket did not stick to the filter base. A stuck gasket could cause an oil leak.
5. Install a new oil filter according to the instructions that come with it.

6. Put a new washer on the drain bolt, then reinstall the drain bolt. Tighten the drain bolt to:  
29 lbf-ft (39 N·m , 4.0 kgf·m)
7. Refill the engine with the recommended oil.  
  
Engine oil change capacity (including filter):  
5.0 US qt (4.7 ℓ)
8. Reinstall the engine oil fill cap. Start the engine. The oil pressure indicator should go out within 5 seconds. If it does not, turn off the engine, and check your work.
9. Let the engine run for several minutes, then check the drain bolt and oil filter for leaks.
10. Turn off the engine and let it sit for several minutes, then check the oil level on the dipstick. If necessary, add more oil.

### NOTICE

*Improper disposal of engine oil can be harmful to the environment. If you change your own oil, please dispose of the used oil properly. Put it in a sealed container and take it to a recycling center. Do not discard it in a trash bin or dump it on the ground.*

# Engine Coolant

## Adding Engine Coolant

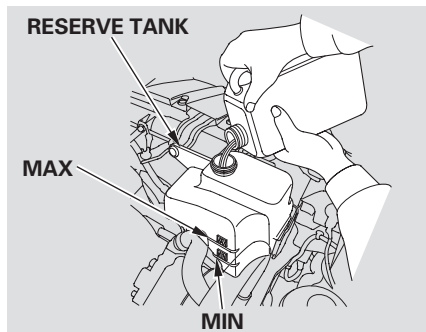

If the coolant level in the reserve tank is at or below the MIN line, add coolant to bring it up to the MAX line. Inspect the cooling system for leaks.

Always use Honda Long-life Antifreeze/Coolant Type 2. This coolant is pre-mixed with 50 percent antifreeze and 50 percent water. Never add straight antifreeze or plain water.

If Honda antifreeze/coolant is not available, you may use another major-brand non-silicate coolant as a temporary replacement. Make sure it is a high-quality coolant recommended for aluminum engines. Continued use of any non-Honda coolant can result in corrosion, causing the cooling system to malfunction or fail. Have the cooling system flushed and refilled with Honda antifreeze/coolant as soon as possible.

If the reserve tank is completely empty, you should also check the coolant level in the radiator.

### **⚠ WARNING**

Removing the radiator cap while the engine is hot can cause the coolant to spray out, seriously scalding you.

Always let the engine and radiator cool down before removing the radiator cap.



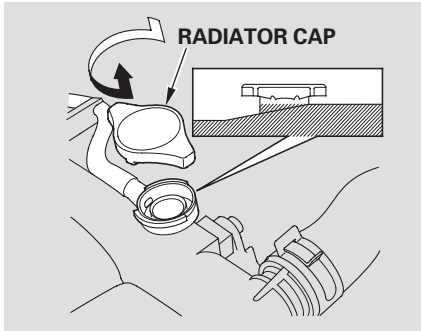

1. Make sure the engine and radiator are cool.
2. Relieve any pressure in the cooling system by turning the radiator cap counterclockwise, without pressing down.
3. Remove the radiator cap by pushing down and turning counterclockwise.

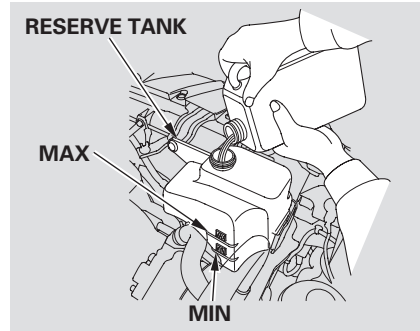

4. The coolant level should be up to the base of the filler neck. Add coolant if it is low.

Pour the coolant slowly and carefully so you do not spill any. Clean up any spills immediately; it could damage components in the engine compartment.

5. Put the radiator cap back on, and tighten it fully.
6. Pour coolant into the reserve tank. Fill it halfway between the MAX and MIN marks. Put the cap back on the reserve tank.

Do not add any rust inhibitors or other additives to your vehicle's cooling system. They may not be compatible with the coolant or engine components.

## Windshield Washers

Check the fluid level in the windshield washer reservoir at least monthly during normal use.

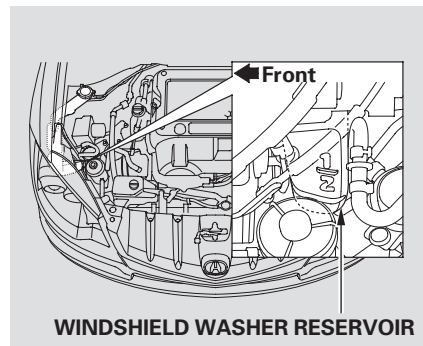

*On U.S. models:* To check the windshield washer fluid level, open the hood and look the windshield washer reservoir located behind the left headlight. You will see a "1/2" mark on the reservoir.

*On Canadian models*  
If the washer fluid is low, a "WASHER FLUID LOW" message appears on the multi-information display.

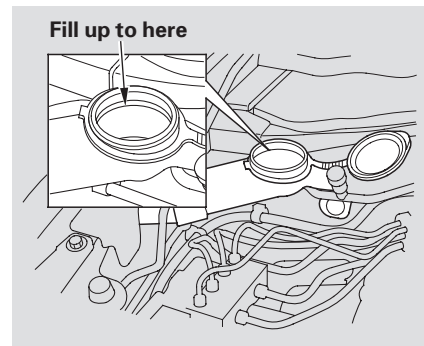

Fill the reservoir with a good-quality windshield washer fluid. This increases the cleaning capability and prevents freezing in cold weather.

When you refill the reservoir, clean the edges of the windshield wiper blades with windshield washer fluid on a clean cloth. This will help to condition the blade edges.

# Windshield Washers, Automatic Transmission Fluid

## NOTICE

*Do not use engine antifreeze or a vinegar/water solution in the windshield washer reservoir. Antifreeze can damage your vehicle's paint, while a vinegar/water solution can damage the windshield washer pump. Use only commercially-available windshield washer fluid.*

## Automatic Transmission Fluid

The transmission should be drained and refilled with new fluid when this service is shown on a maintenance message in the multi-information display.

Check the fluid level with the engine at normal operating temperature.

1. Park the vehicle on level ground. Start the engine, let it run until the radiator fan comes on, then shut off the engine. For accurate results, wait about 60 seconds (but no longer than 90 seconds) before doing step 2.

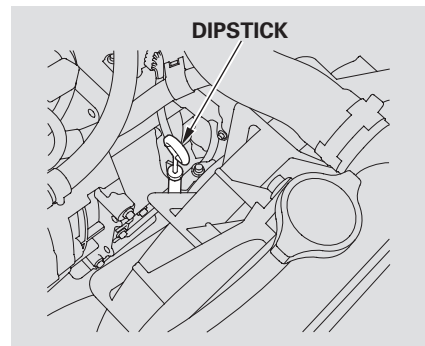

2. Remove the dipstick (yellow loop) from the transmission, and wipe it with a clean cloth.

CONTINUED

## Automatic Transmission Fluid

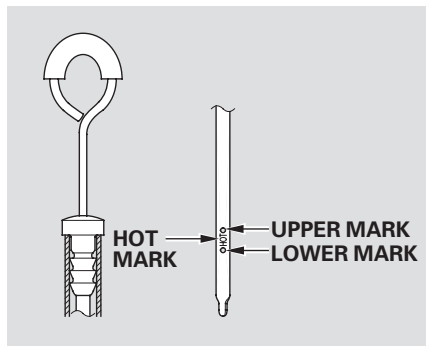

3. Insert the dipstick all the way into the transmission securely as shown in the illustration.
4. Remove the dipstick and check the fluid level. It should be between the upper and lower marks.

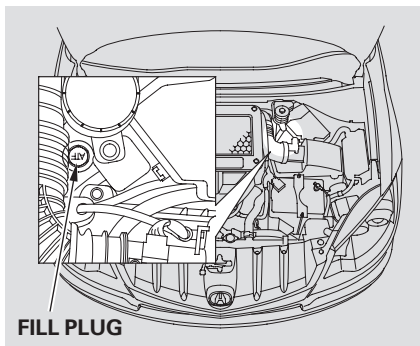

5. If the level is below the lower mark, remove the fill plug, then add the fluid into the fill hole to bring it to the level between the upper and lower marks on the dipstick.

Pour the fluid slowly and carefully so you do not spill any. Clean up any spills immediately; it could damage components in the engine compartment.

Always use Honda ATF-Z1 (automatic transmission fluid).

### NOTICE

*Use only Honda Genuine ATF-Z1 (Automatic Transmission Fluid). Do not mix with other transmission fluids. Using transmission fluid other than Honda Genuine ATF-Z1 may cause deterioration in transmission operation and durability, and could result in damage to the transmission. Damage resulting from the use of transmission fluid other than Honda Genuine ATF-Z1 is not covered by the Honda new vehicle warranty.*

6. Insert the dipstick all the way back into the transmission securely as shown in the illustration.

If you are not sure how to add fluid, contact your dealer.

Check the fluid level in the brake fluid reservoir monthly.

Replace the brake fluid every 3 years, independent of mileage.

Always use Honda Heavy Duty Brake Fluid DOT 3. If it is not available, you should use only DOT 3 or DOT 4 fluid, from a sealed container, as a temporary replacement.

Using any non-Honda brake fluid can cause corrosion and decrease the life of the system. Have the brake system flushed and refilled with Honda Heavy Duty Brake Fluid DOT 3 as soon as possible.

Brake fluid marked DOT 5 is not compatible with your vehicle's braking system and can cause extensive damage.

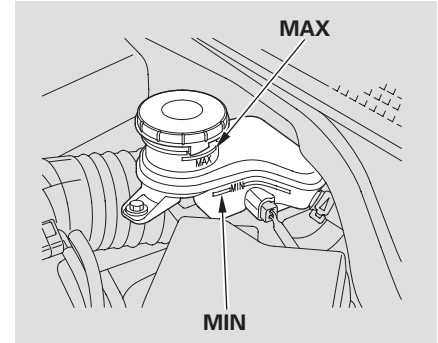

The fluid level should be between the MIN and MAX marks on the side of the reservoir. If the level is at or below the MIN mark, your brake system needs attention. Have the brake system inspected for leaks or worn brake pads.

## Power Steering Fluid

---

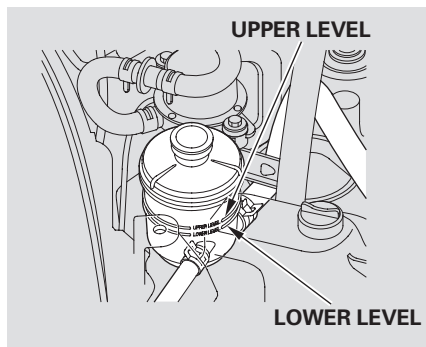

Check the level on the side of the reservoir when the engine is cold. The fluid should be between the UPPER LEVEL and LOWER LEVEL. If not, add power steering fluid to the UPPER LEVEL.

Pour the fluid slowly and carefully so you do not spill any. Clean up any spills immediately; it could damage components in the engine compartment.

Always use Honda Power Steering Fluid. You may use another power steering fluid as an emergency replacement, but have the power steering system flushed and refilled with Honda PSF as soon as possible.

A low power steering fluid level can indicate a leak in the system. Check the fluid level frequently, and have the system inspected as soon as possible.

If you are not sure how to add fluid, contact your dealer.

### NOTICE

*Turning the steering wheel to full left or right lock and holding it there can damage the power steering pump.*

## Headlight Aiming

The headlights were properly aimed when your vehicle was new. If you regularly carry heavy items in the cargo area or pull a trailer, readjustment may be required. Adjustments should be done by your dealer or other qualified technician.

## Low Beam Headlight Bulb Replacement

The low beam headlight bulbs are a type of high voltage discharge tube. High voltage can remain in the circuit even with the light switch off and the key removed. Because of this, you should not attempt to examine or change a low beam headlight bulb yourself. If a low beam headlight bulb fails, take the vehicle to your dealer to have it replaced.

## Replacing a High Beam Headlight Bulb

Your vehicle has halogen headlight bulbs. When replacing a bulb, handle it by its base, and protect the glass from contact with your skin or hard objects. If you touch the glass, clean it with denatured alcohol and a clean cloth.

### NOTICE

*Halogen headlight bulbs get very hot when lit. Oil, perspiration, or a scratch on the glass can cause the bulb to overheat and shatter.*

1. Open the hood.  
Remove the electrical connector from the bulb by pushing on the tab and pulling the connector down.
2. Remove the bulb by turning it about one-quarter turn counterclockwise.

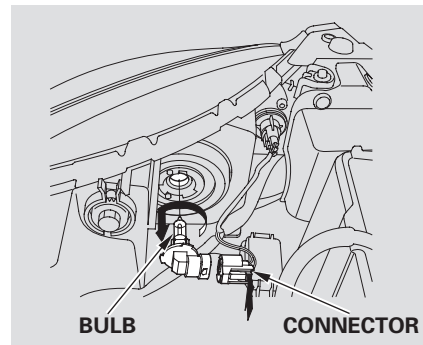

3. Insert the new bulb into the hole, and turn it one-quarter turn clockwise to lock it in place.
4. Push the electrical connector onto the new bulb.
5. Turn on the headlights to test the new bulb.

# Lights

## Replacing a Front Turn Signal/ Parking Light Bulb

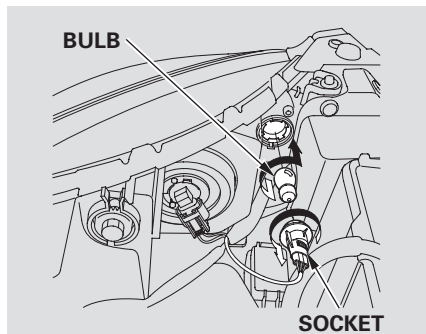

1. Open the hood. Remove the socket from the headlight assembly by turning it one-quarter turn counterclockwise.
2. Remove the bulb from the socket by pushing the bulb in and turning it counterclockwise until it unlocks.
3. Install the new bulb in the socket. Turn it clockwise to lock it in place.

4. Test the lights to make sure the new bulb is working.
5. Insert the socket back into the headlight assembly. Turn it clockwise to lock it in place.

## Replacing a Front Side Marker Light Bulb

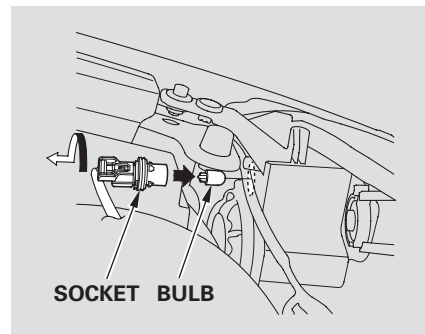

1. Open the hood. Remove the socket from the headlight assembly by turning it one-quarter turn counterclockwise.
2. Pull the bulb straight out of its socket. Push the new bulb straight into the socket until it bottoms.



3. Install the socket back into the headlight assembly. Turn it clockwise to lock it in place.
4. Turn on the lights to make sure the new bulb is working.

## Replacing Rear Bulbs (in Tailgate)

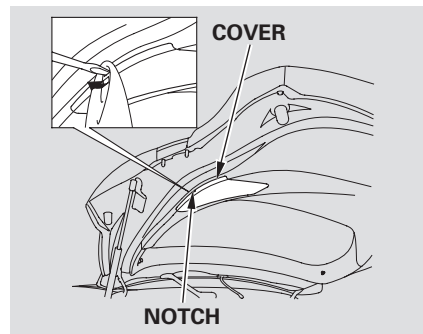

1. Open the tailgate. Place a cloth on the edge of the light assembly cover. Remove the cover by carefully prying in the notch on its middle edge with a flat-tip screwdriver.
2. Determine which of the two bulbs is burned out: taillight or back-up light.

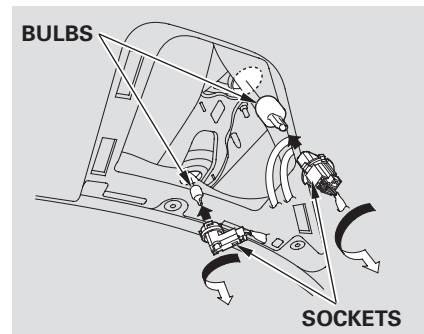

3. Remove the socket by turning it one-quarter turn counterclockwise.
4. Pull the bulb straight out of its socket. Push the new bulb straight into the socket until it bottoms.

*CONTINUED*

# Lights

5. Turn on the lights to make sure the new bulb is working.
6. Reinstall the socket into the light assembly by turning it clockwise until it locks.
7. Reinstall the light assembly cover.

## Replacing Rear Bulbs (in Rear Pillar)

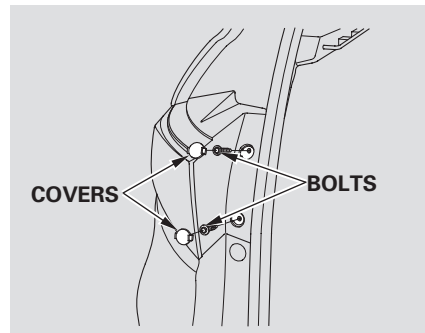

1. Open the tailgate.
2. Remove the two bolt covers on the rear pillar by prying on the bottom edge with a flat-tip screwdriver. Remove the bolts with a Phillips-head screwdriver, and remove the light assembly from the rear pillar.

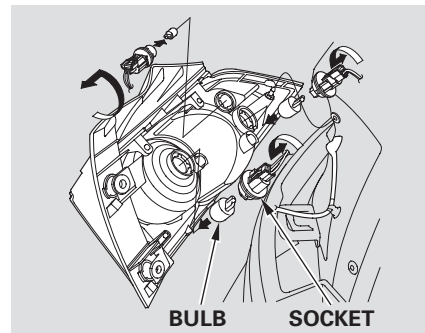

3. Determine which of the three bulbs is burned out: brake/taillight, turn signal or rear side marker.
4. Remove the socket by turning it one-quarter turn counterclockwise.
5. Pull the bulb straight out of its socket. Push the new bulb straight into the socket until it bottoms.

6. Turn on the lights to make sure the new bulb is working.
7. Put the socket back into the light assembly, and turn it clockwise to lock it in place.
8. Install the rear light assembly in the rear pillar. Tighten the two bolts. Snap the bolt covers into position.

## Replacing a Front Fog Light Bulb

Your vehicle uses halogen light bulbs. When replacing a bulb, handle it by its plastic case, and protect the glass from contact with your skin or hard objects. If you touch the glass, clean it with denatured alcohol and a clean cloth.

### NOTICE

*Halogen bulbs get very hot when lit. Oil, perspiration, or a scratch on the glass can cause the bulb to overheat and shatter.*

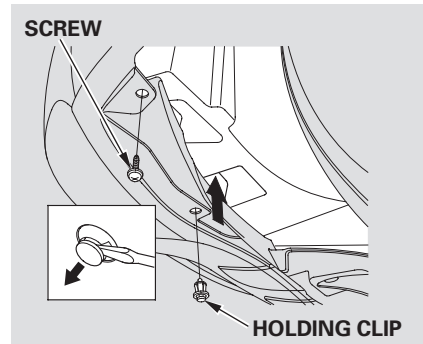

1. Use a Phillips-head screwdriver to remove the screw and use a flat-tipped screwdriver to remove the holding clip located under the front bumper.
2. Push up the undercover.

CONTINUED

## Lights

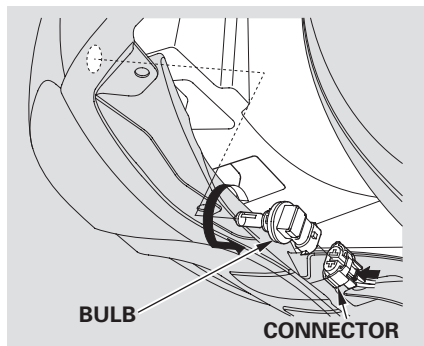

3. Remove the electrical connector from the bulb by pushing on the tab and pulling the connector down.
4. Remove the bulb from the fog light assembly by turning it one-quarter turn counterclockwise.

5. Install the new bulb into the hole and turn it one-quarter turn clockwise to lock it in place.
6. Push the electrical connector back onto the bulb. Make sure it is on all the way.
7. Turn on the fog lights to test the new bulb.
8. Put the undercover in place. Reinstall the clip, and tighten the screw securely.

### Replacing a High-mount Brake Light Bulb

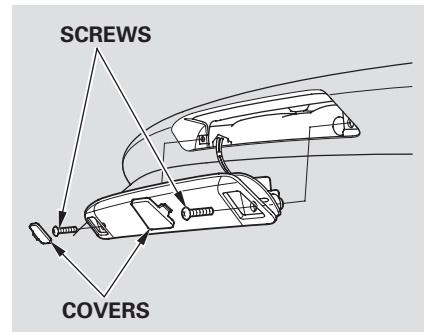

1. Remove the two screw covers on the light assembly by prying on the side edge with a flat-tip screwdriver.
2. Remove the screws with a Phillips-head screwdriver, then remove the light assembly from the tailgate.

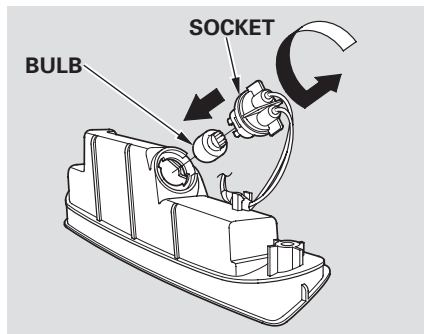

3. Remove the socket from the light assembly by turning it one-quarter turn counterclockwise.
4. Pull the bulb straight out of its socket. Push the new bulb straight into the socket until it bottoms.

5. Press the brake pedal to make sure the new bulb is working.
6. Put the socket back into the light assembly, and turn it clockwise to lock it in place.
7. Reinstall the high-mount brake light assembly into the tailgate. Tighten the two screws and reinstall the covers.

## Side Turn Signal Light

Each outside mirror has side turn signal lights. The lights should be replaced by your dealer.

## Replacing a Rear License Plate Light Bulb

The license plate has two lights above it. The bulbs should be replaced by your dealer.

## Cleaning the Seat Belts, Floor Mats

### Cleaning the Seat Belts

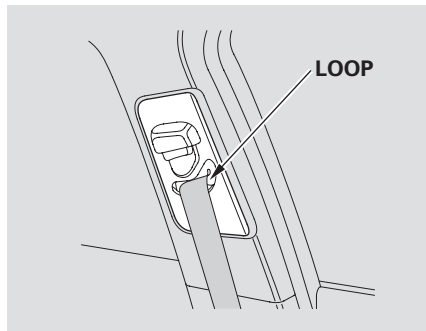

If your seat belts get dirty, use a soft brush with a mixture of mild soap and warm water to clean them. Do not use bleach, dye, or cleaning solvents. Let the belts air-dry before you use the vehicle.

Dirt build-up in the loops of the seat belt anchors can cause the belts to retract slowly. Wipe the insides of the loops with a clean cloth dampened in mild soap and warm water or isopropyl alcohol.

### Floor Mats

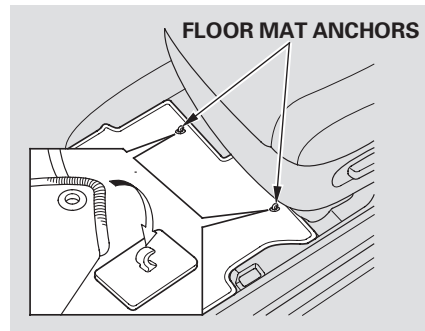

The driver's floor mat that came with your vehicle hooks over the floor mat anchors. This keeps the floor mat from sliding forward and possibly interfering with the pedals.

If you remove the driver's floor mat, make sure to re-anchor it when you put it back in your vehicle.

A non-Acura floor mat may not fit your vehicle properly. This could prevent the proper operation of the folding rear seats and the passenger's seat weight sensors. We recommend using genuine Acura floor mats. Do not put additional floor mats on top of the anchored mat.

# Audio Antenna, Intercooler, Dust and Pollen Filter

## Audio Antenna

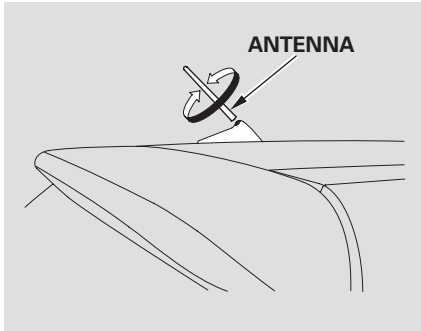

### NOTICE

Your vehicle is equipped with an antenna at the rear of the roof. Before using a “drive-through” car wash, remove the antenna by unscrewing it by hand. This prevents the antenna from being damaged by the car wash brushes.

## Intercooler

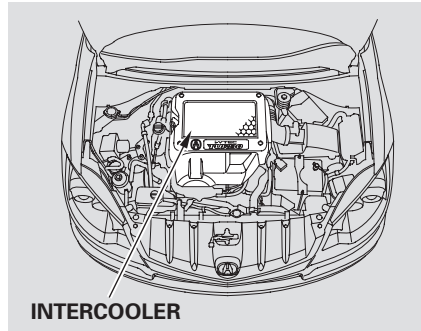

Your vehicle is equipped with a intercooler on the engine to cool the air flow from a turbo charger into the engine. The intercooler fins bend easily. Do not push them with your finger.

### NOTICE

Do not spray water (from such sources as garden hoses, high pressure sprayers) into the engine compartment. It may cause serious damage to your vehicle, and could also damage the intercooler fins.

## Dust and Pollen Filter

This filter removes the dust and pollen that is brought in from the outside through the climate control system.

Have your dealer replace the filter when this service is indicated by a maintenance message on the multi-information display. It should be replaced every 15,000 miles (24,000 km) if you drive primarily in urban areas that have high concentrations of soot in the air, or if the flow from the climate control system becomes less than usual.

## Wiper Blades

Check the condition of the wiper blades at least every six months. Replace them if you find signs of cracking in the rubber, areas that are getting hard, or if they leave streaks and unwiped areas when used.

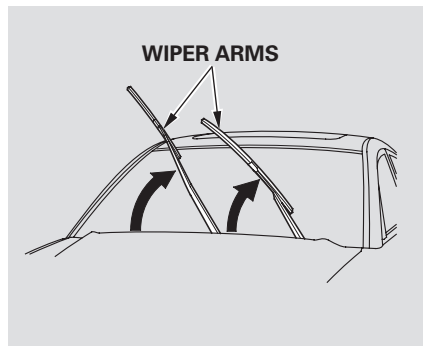

To replace a front wiper blade:

1. Raise each wiper arm off the windshield, lifting the driver's side first, then the passenger's side.

### NOTICE

*Do not open the hood when the wiper arms are raised, or you will damage the hood and the wiper arms.*

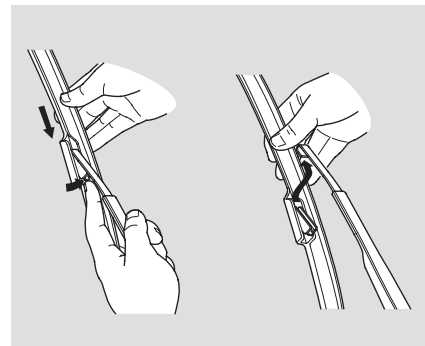

2. Disconnect the blade assembly from the wiper arm:

- Press and hold the lock tab.
- Slide the blade assembly toward the lock tab until it releases from the wiper arm.

When replacing a wiper blade, make sure not to drop the wiper blade or wiper arm down on the windshield.



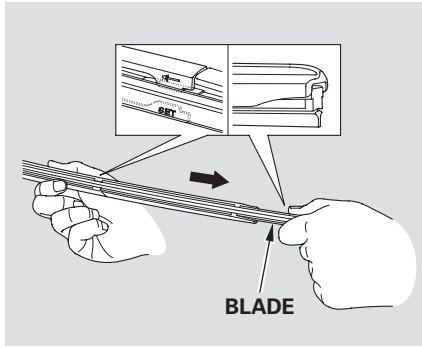

3. Remove the blade from the blade assembly:

- Find two tabs with a “SET” and “←” mark on the wiper blade assembly. The opposite side of the “←” mark is the direction you pull out the wiper blade.
- Pull out the blade by grabbing the end of the blade as shown above illustration.

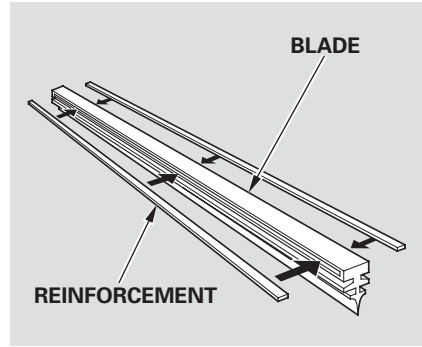

4. Examine the new wiper blades. If they have no plastic or metal reinforcement along the back edge, remove the metal reinforcement strips from the old wiper blade, and install them in the slots along the edge of the new blade.

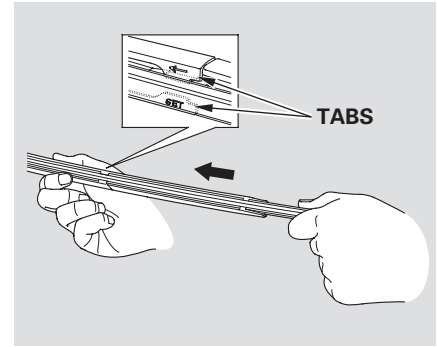

5. Install the new blade onto the blade assembly:

- Find two tabs with a “SET” and “←” mark on the wiper blade assembly. This is the direction you install.
- Slide the blade onto the assembly until it is locked by the tabs.

*CONTINUED*

## Wiper Blades

- Slide the wiper blade assembly onto the wiper arm. Make sure it locks in place.
- Make sure the blade is completely installed and that its edge is not bunched up.
- Lower the wiper arm down against the windshield, the passenger's side first, then the driver's side.

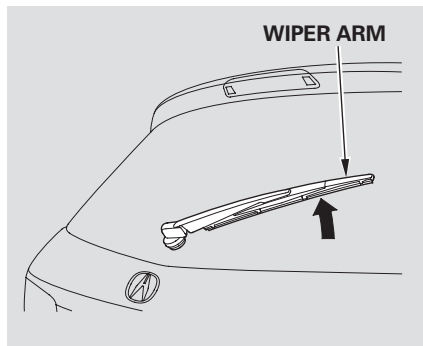

To replace the rear wiper blade:

- Raise the wiper arm off the rear window.

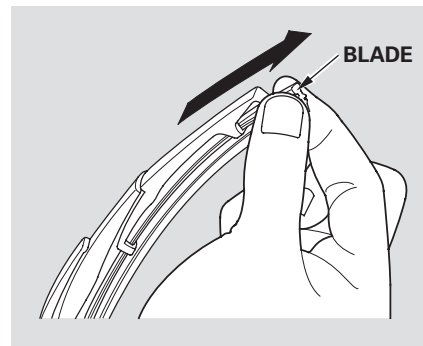

- Slide the blade out of the wiper arm.

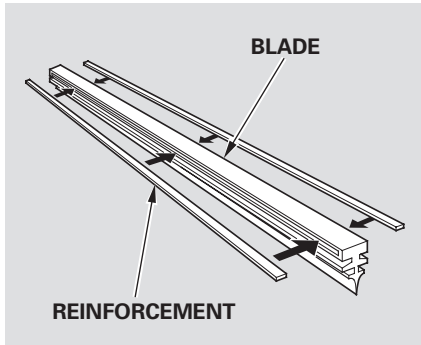

3. Examine the new wiper blades. If they have no plastic or metal reinforcement along the back edge, remove the metal reinforcement strips from the old wiper blade, and install them in the slots along the edge of the new blade.

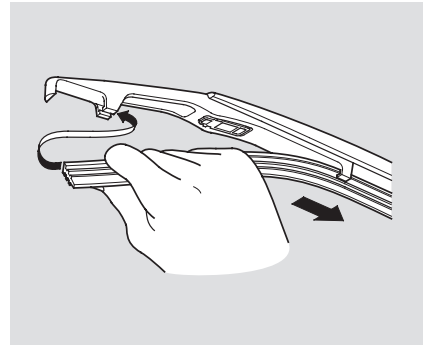

4. Slide the new blade into the wiper arm. Make sure it is engaged in the slot along its full length.
5. Lower the wiper arm.

### Wheels

Clean the wheels as you would the rest of the exterior. Wash them with the same solution, and rinse them thoroughly.

Aluminum alloy wheels have a protective clear-coat that keeps the aluminum from corroding and tarnishing. Cleaning the wheels with harsh chemicals (including some commercial wheel cleaners) or a stiff brush can damage the clear-coat. To clean the wheels, use a mild detergent and a soft brush or sponge.

# Tires

---

To safely operate your vehicle, your tires must be the proper type and size, in good condition with adequate tread, and correctly inflated.

The following pages give more detailed information on how to take care of your tires and what to do when they need to be replaced.

## **WARNING**

Using tires that are excessively worn or improperly inflated can cause a crash in which you can be seriously hurt or killed.

Follow all instructions in this owner's manual regarding tire inflation and maintenance.

## **Inflation Guidelines**

Keeping the tires properly inflated provides the best combination of handling, tread life, and riding comfort.

- Underinflated tires wear unevenly, adversely affect handling and fuel economy, and are more likely to fail from being overheated.
- Overinflated tires can make your vehicle ride more harshly, are more prone to damage from road hazards, and wear unevenly.

The tire pressure monitoring system (TPMS) will warn you when a tire pressure is low. See page [307](#) for information on the TPMS.

Even though your vehicle is equipped with TPMS, we recommend that you visually check your tires every day. If you think a tire might be low, check it immediately with a tire gauge.

Use a gauge to measure the air pressure in each tire at least once a month. Even tires that are in good condition may lose 1 to 2 psi (10 to 20 kPa, 0.1 to 0.2 kgf/cm<sup>2</sup>) per month. Remember to check the spare tire at the same time.

Check the air pressures when the tires are cold. This means the vehicle has been parked for at least 3 hours, or driven less than 1 mile (1.6 km). Add or release air, if needed, to match the recommended cold tire pressures.

If you check air pressures when the tires are hot [driven for several miles (kilometers)], you will see readings 4 to 6 psi (30 to 40 kPa, 0.3 to 0.4 kgf/cm<sup>2</sup>) higher than the cold readings. This is normal. Do not let air out to match the recommended cold air pressure. The tire will be underinflated.

You should get your own tire pressure gauge and use it whenever you check your tire pressures. This will make it easier for you to tell if a pressure loss is due to a tire problem and not due to a variation between gauges.

While tubeless tires have some ability to self-seal if they are punctured, you should look closely for punctures if a tire starts losing pressure.

### Recommended Tire Pressures

The following charts show the recommended cold tire pressures for most normal driving conditions.

Tire Size	Cold Tire Pressure for Normal Driving
P235/55R18 99V	Front/Rear: 32 psi (220 kPa , 2.2 kgf/cm <sup>2</sup> )

The compact spare tire pressure is: **60 psi (420 kPa , 4.2 kgf/cm<sup>2</sup>)**

For convenience, the recommended tire sizes and cold tire pressures are on a label on the driver's doorjamb.

For additional information about your tires, see page [398](#) .

### Tire Inspection

Every time you check inflation, you should also examine the tires for damage, foreign objects, and wear.

You should look for:

- Bumps or bulges in the tread or side of the tire. Replace the tire if you find either of these conditions.
- Cuts, splits, or cracks in the side of the tire. Replace the tire if you can see fabric or cord.
- Excessive tread wear.

CONTINUED

# Tires

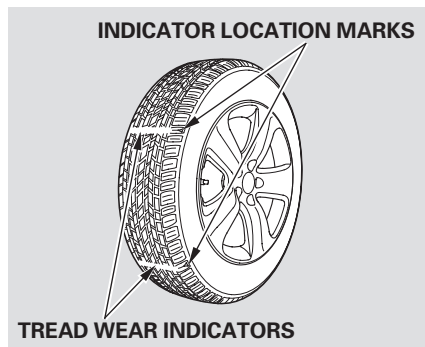

Your tires have wear indicators molded into the tread. When the tread wears down, you will see a 1/2 inch (12.7 mm) wide band across the tread. This shows there is less than 1/16 inch (1.6 mm) of tread left on the tire.

A tire this worn gives very little traction on wet roads. You should replace the tire if you can see three or more tread wear indicators.

## Tire Service Life

The service life of your tires is dependent on many factors, including, but not limited to, driving habits, road conditions, vehicle loading, inflation pressure, maintenance history, speed, and environmental conditions (even when the tires are not in use).

In addition to your regular inspections and inflation pressure maintenance, it is recommended that you have annual inspections performed once the tires reach five years old. It is also recommended that all tires, including the spare, be removed from service after 10 years from the date of manufacture, regardless of their condition or state of wear.

The last four digits of the TIN (tire identification number) are found on the sidewall of the tire and indicate the date of manufacture (See **Tire Labeling** on page [400](#)).

## Tire Maintenance

In addition to proper inflation, correct wheel alignment helps to decrease tire wear. If you find a tire is worn unevenly, have your dealer check the wheel alignment.

Have your dealer check the tires if you feel a consistent vibration while driving. A tire should always be rebalanced if it is removed from the wheel. When you have new tires installed, make sure they are balanced. This increases riding comfort and tire life. For best results, have the installer perform a dynamic balance.

### NOTICE

*Improper wheel weights can damage your vehicle's aluminum wheels. Use only Acura wheel weights for balancing.*

## Tire Rotation

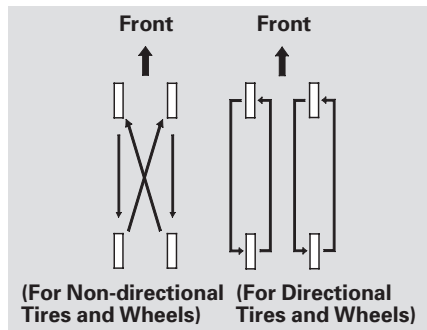

To help increase tire life and distribute wear more evenly, rotate the tires according to the maintenance messages displayed on the multi-information display. Move the tires to the positions shown in the illustration each time they are rotated. If you purchase directional tires, rotate only front-to-back.

## Replacing Tires and Wheels

Replace your tires with radial tires of the same size, load range, speed rating, and maximum cold tire pressure rating (as shown on the tire's sidewall).

Mixing radial and bias-ply tires on your vehicle can reduce braking ability, traction, and steering accuracy. Using tires of a different size or construction can cause the ABS and vehicle stability assist system (VSA) to work inconsistently.

The ABS and VSA system work by comparing the speed of the wheels. When replacing tires, use the same size originally supplied with the vehicle. Tire size and construction can affect wheel speed and may cause the ABS or VSA system to activate.

It is best to replace all four tires at the same time. If that is not possible or necessary, replace the two front tires or two rear tires as a pair. Replacing just one tire can seriously affect your vehicle's handling.

If you ever replace a wheel, make sure that the wheel's specifications match those of the original wheels.

Also be sure you use only TPMS specific wheels. If you do not, the tire pressure monitoring system will not work.

Replacement wheels are available at your dealer.

## **⚠ WARNING**

Installing improper tires on your vehicle can affect handling and stability. This can cause a crash in which you can be seriously hurt or killed.

Always use the size and type of tires recommended in this owner's manual.

## **Wheel and Tire Specifications**

Wheels:  
18 x 7 1/2J (TPMS)

Tires:  
P235/55R18 99V

See page [398](#) for information about DOT Tire Quality Grading, and page [400](#) for tire size and labeling information.

## **Winter Driving**

Tires marked “M + S” or “All Season” on the sidewall have an all-weather tread design suitable for most winter driving conditions.

For the best performance in snowy or icy conditions, you should install snow tires or tire chains. They may be required by local laws under certain conditions.

## **Snow Tires**

If you mount snow tires on your vehicle, make sure they are radial tires of the same size and load range as the original tires. Mount snow tires on all four wheels. The traction provided by snow tires on dry roads may be lower than your original tires. Check with the tire dealer for maximum speed recommendations.



### Tire Chains

Mount tire chains on your tires when required by driving conditions or local laws. Install them only on the front tires.

Because your vehicle has limited tire clearance, Acura strongly recommends using the chains listed below, made by Security Chain Company (SCC).

Cable type: Shur Grip Z  
SZ343

When installing cables, follow the manufacturer's instructions, and mount them as tight as you can. Make sure they are not contacting the brake lines or suspension. Drive slowly with them installed. If you hear them coming into contact with the body or chassis, stop and investigate. Remove them as soon as you begin driving on cleared roads.

#### NOTICE

*Traction devices that are the wrong size or improperly installed can damage your vehicle's brake lines, suspension, body, and wheels. Stop driving if they are hitting any part of the vehicle.*

#### ⚠ WARNING

Using the wrong chains, or not properly installing chains, can damage the brake lines and cause a crash in which you can be seriously injured or killed.

Follow all instructions in this owner's manual regarding the selection and use of tire chains.

## Checking the Battery

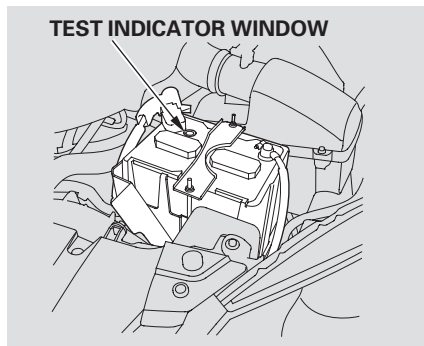

Check the condition of the battery monthly by looking at the test indicator window. The label on the battery explains the test indicator's colors.

Check the terminals for corrosion (a white or yellowish powder). To remove it, cover the terminals with a solution of baking soda and water. It will bubble up and turn brown. When this stops, wash it off with plain water. Dry off the battery with a cloth or paper towel. Coat the terminals with grease to help prevent future corrosion.

If additional battery maintenance is needed, see your dealer or a qualified technician.

**WARNING:** Battery posts, terminals, and related accessories contain lead and lead compounds.  
**Wash your hands after handling.**

If you need to connect the battery to a charger, disconnect both cables to prevent damaging your vehicle's electrical system. Always disconnect the negative (–) cable first, and reconnect it last.

### **⚠ WARNING**

The battery gives off explosive hydrogen gas during normal operation.

A spark or flame can cause the battery to explode with enough force to kill or seriously hurt you.

Wear protective clothing and a face shield, or have a skilled technician do the battery maintenance.

### *On RDX models*

If your vehicle's battery is disconnected, or goes dead, the time setting will be reset to 1:00. To set the time again, follow the setting procedure (see page [188](#)).

If your vehicle's battery is disconnected or goes dead, the audio system will disable itself. The next time you turn on the radio you will see "ENTER CODE" in the frequency display. Use the preset bars or preset buttons (depending on models) to enter the five-digit code (see page [232](#)).

### *On RDX with Technology Package model*

The navigation system will also disable itself. The next time you turn on the ignition switch, the system will require you to enter a PIN before it can be used. Refer to the navigation system manual.

## Vehicle Storage

---

If you need to park your vehicle for an extended period (more than 1 month), there are several things you should do to prepare it for storage. Proper preparation helps prevent deterioration and makes it easier to get your vehicle back on the road. If possible, store your vehicle indoors.

- Fill the fuel tank.
- Wash and dry the exterior completely.
- Clean the interior. Make sure the carpeting, floor mats, etc., are completely dry.
- Leave the parking brake off. Put the transmission in Park.

- Block the rear wheels.
- If the vehicle is to be stored for a longer period, it should be supported on jackstands so the tires are off the ground.
- Leave one window open slightly (if the vehicle is being stored indoors).
- Disconnect the battery.
- Support the front and rear wiper blade arms with a folded towel or rag so they do not touch the windshield.
- To minimize sticking, apply a silicone spray lubricant to all door and tailgate seals. Also, apply a vehicle body wax to the painted surfaces that mate with the door and tailgate seals.
- Cover the vehicle with a “breathable” cover, one made from a porous material such as cotton. Non-porous materials, such as plastic sheeting, trap moisture, which can damage the paint.
- If possible, periodically run the engine until it reaches full operating temperature (the cooling fans cycle on and off twice). Preferably, do this once a month.

This section covers the more common problems that motorists experience with their vehicles. It gives you information about how to safely evaluate the problem and what to do to correct it. If the problem has stranded you on the side of the road, you may be able to get going again. If not, you will also find instructions on getting your vehicle towed.

Compact Spare Tire.....	370
Changing a Flat Tire .....	371
If the Engine Won't Start.....	375
Jump Starting .....	377
If the Engine Overheats .....	379
Low Oil Pressure Indicator .....	381
Charging System Indicator.....	381
Malfunction Indicator Lamp .....	382
Brake System Indicator (Red) .....	383
Brake System Indicator (Amber) .....	384
Fuses .....	385
Fuse Locations.....	389
Emergency Towing .....	391

## Compact Spare Tire

Use the compact spare tire as a temporary replacement only. Get your regular tire repaired or replaced, and put it back on your vehicle as soon as you can.

Check the inflation pressure of the compact spare tire every time you check the other tires. It should be inflated to:

60 psi (420 kPa , 4.2 kgf/cm<sup>2</sup>)

Follow these precautions:

- Never exceed 50 mph (80 km/h).
- This tire gives a harsher ride and less traction on some road surfaces. Use greater caution while driving.
- Do not mount snow chains on the compact spare tire.
- Do not use your compact spare tire on another vehicle unless it is the same make and model.
- After the flat tire is replaced with the spare tire, the low tire pressure/TPMS indicator stays on. After several miles (kilometers) driving with the spare, this indicator begins to flash, then stays on again. You will also see a “CHECK TPMS SYSTEM” message on the multi-information display (see page 310).

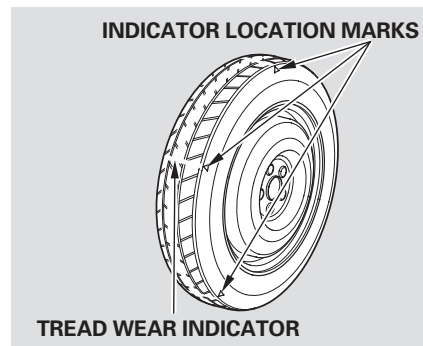

Replace the tire when you can see the tread wear indicator bars. The replacement should be the same size and design tire, mounted on the same wheel. The spare tire is not designed to be mounted on a regular wheel, and the spare wheel is not designed for mounting a regular tire.

If you have a flat tire while driving, stop in a safe place to change it. Drive slowly along the shoulder until you get to an exit or an area that is far away from the traffic lanes.

### **WARNING**

The vehicle can easily roll off the jack, seriously injuring anyone underneath.

Follow the directions for changing a tire exactly, and never get under the vehicle when it is supported only by the jack.

1. Park the vehicle on firm, level, and non-slippery ground. Put the transmission in Park. Apply the parking brake. If you are towing a trailer, unhitch it.
2. Turn on the hazard warning lights, and turn the ignition switch to the LOCK (0) position. Have all passengers get out of the vehicle while you change the tire.

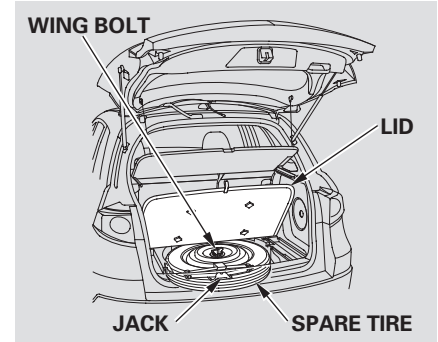

3. Open the tailgate. Raise the cargo area floor lid by lifting it up with the strap, then remove the lid. The spare tire, jack, and tools are under the cargo area floor.
4. Unscrew the wing bolt. Use the hooked end of the wheel nut wrench extension as a wrench if the wing bolt is hard to loosen. Then take the spare tire out of the cargo area.

*CONTINUED*

## Changing a Flat Tire

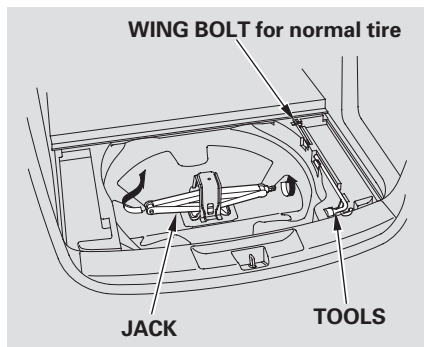

5. Remove the tools, wing bolt and the jack. To remove the jack, turn the jack's end bracket counterclockwise to loosen it.

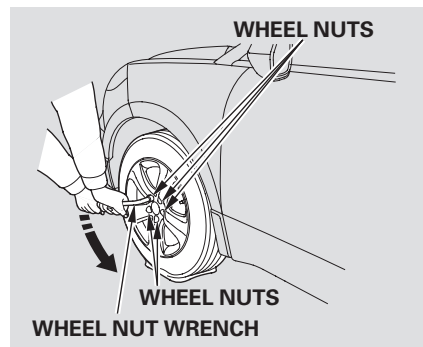

6. Loosen the five wheel nuts 1/2 turn with the wheel nut wrench.

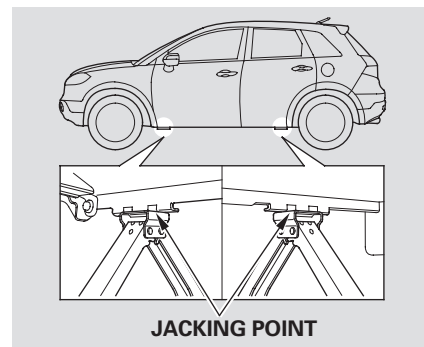

7. Place the jack under the jacking point nearest the tire you need to change. Turn the end bracket clockwise until the top of the jack contacts the jacking point. Make sure the jacking point tab is resting in the jack notch.



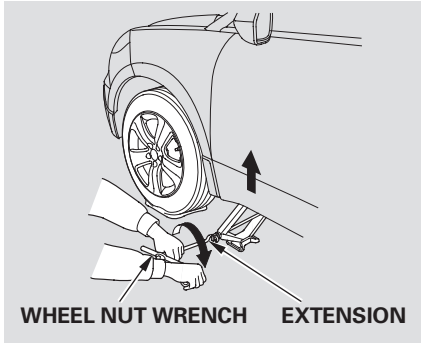

8. Use the extension and the wheel nut wrench as shown to raise the vehicle until the flat tire is off the ground.
9. Remove the wheel nuts, then remove the flat tire. Handle the wheel nuts carefully; they may be hot from driving. Place the flat tire on the ground with the outside surface facing up.

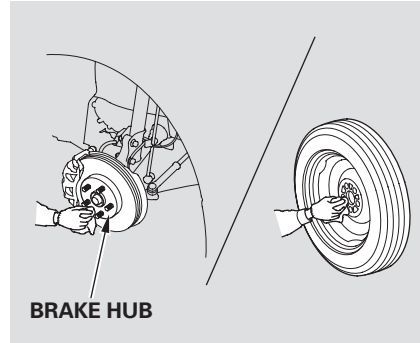

10. Before mounting the spare tire, wipe any dirt off the mounting surface of the wheel and hub with a clean cloth. Wipe the hub carefully; it may be hot from driving.

11. Put on the spare tire. Put the wheel nuts back on finger-tight, then tighten them in a crisscross pattern with the wheel nut wrench until the wheel is firmly against the hub. Do not try to tighten the wheel nuts fully.
12. Lower the vehicle to the ground, and remove the jack.

CONTINUED

## Changing a Flat Tire

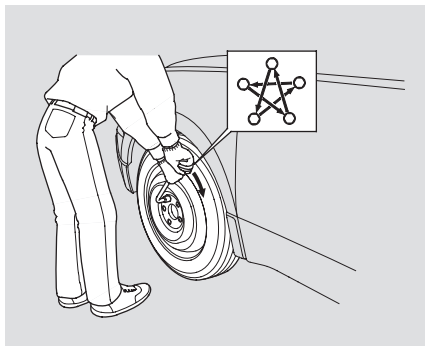

13. Tighten the wheel nuts securely in the same crisscross pattern. Have the wheel nut torque checked at the nearest automotive service facility.

Tighten the wheel nuts to:  
80 lbf·ft (108 N·m , 11 kgf·m)

14. Store the jack in its holder. Turn the jack's end bracket to lock it in place. Store the tools.

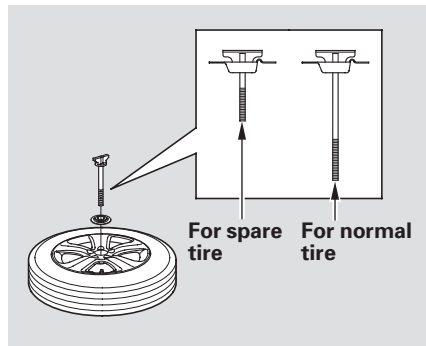

15. Remove the center cap from the flat tire, and store it in the cargo area.

16. Place the flat tire face up in the cargo area.

17. Secure the flat tire by screwing the wing bolt back into its hole.

### ⚠ WARNING

Loose items can fly around the interior in a crash and could seriously injure the occupants.

Store the wheel, jack, and tools securely before driving.

18. Reinstall the cargo area floor, and close the tailgate.

19. Your vehicle's original tire has a tire pressure monitoring system sensor. To replace a tire, refer to **Changing a Tire with TPMS** (see page 311).

Diagnosing why the engine won't start falls into two areas, depending on what you hear when you turn the ignition switch to the START (III) position:

- You hear nothing, or almost nothing. The engine's starter motor does not operate at all, or operates very slowly.
- You can hear the starter motor operating normally, or the starter motor sounds like it is spinning faster than normal, but the engine does not start up and run.

### **Nothing Happens or the Starter Motor Operates Very Slowly**

When you turn the ignition switch to the START (III) position, you do not hear the normal noise of the engine trying to start. You may hear a clicking sound, a series of clicks, or nothing at all.

Check these things:

- Check the transmission interlock. The transmission must be in Park or neutral or the starter will not operate.
- Turn the ignition switch to the ON (II) position. Turn on the headlights, and check their brightness. If the headlights are very dim or do not come on at all, the battery is discharged. See **Jump Starting** on page [377](#).

- Turn the ignition switch to the START (III) position. If the headlights do not dim, check the condition of the fuses. If the fuses are OK, there is probably something wrong with the electrical circuit for the ignition switch or starter motor. You will need a qualified mechanic to determine the problem (see **Emergency Towing** on page [391](#)).

If the headlights dim noticeably or go out when you try to start the engine, either the battery is discharged or the connections are corroded. Check the condition of the battery and terminal connections (see page [366](#)). You can then try jump starting the vehicle from a booster battery (see page [377](#)).

## If the Engine Won't Start

---

### The Starter Operates Normally

In this case, the starter motor's speed sounds normal, or even faster than normal, when you turn the ignition switch to the START (III) position, but the engine does not run.

- Are you using a properly coded key? An improperly coded key will cause the immobilizer system indicator in the instrument panel to blink rapidly (see page [121](#)).
- Are you using the proper starting procedure? Refer to **Starting the Engine** on page [292](#).

- Do you have fuel? Check the fuel gauge; the low fuel indicator may not be working.
- There may be an electrical problem, such as no power to the fuel pump. Check all the fuses (see page [386](#)).

If you find nothing wrong, you will need a qualified technician to find the problem. See **Emergency Towing** on page [391](#).

Although this seems like a simple procedure, you should take several precautions.

## **⚠ WARNING**

A battery can explode if you do not follow the correct procedure, seriously injuring anyone nearby.

Keep all sparks, open flames, and smoking materials away from the battery.

You cannot start your vehicle by pushing or pulling it.

### ***To Jump Start Your Vehicle:***

1. Open the hood, and check the physical condition of the battery. In very cold weather, check the condition of the electrolyte. If it seems slushy or frozen, do not try jump starting until it thaws.

### **NOTICE**

*If a battery sits in extreme cold, the electrolyte inside can freeze. Attempting to jump start with a frozen battery can cause it to rupture.*

2. Turn off all electrical accessories: heater, A/C, climate control, audio system, lights, etc. Put the transmission in Park, and set the parking brake.

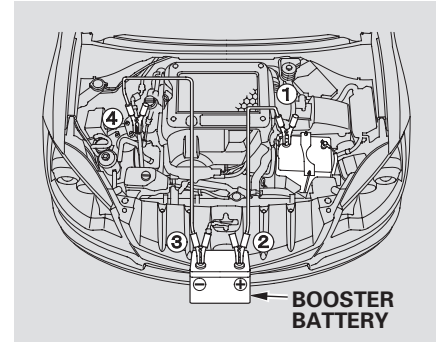

The numbers in the illustration show you the order to connect the jumper cables.

CONTINUED

## Jump Starting

---

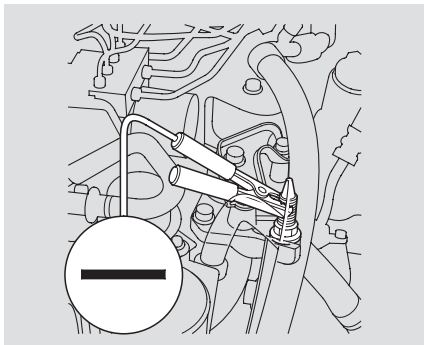

3. Connect one jumper cable to the positive (+) terminal on your battery. Connect the other end to the positive (+) terminal on the booster battery.
4. Connect the second jumper cable to the negative (-) terminal on the booster battery. Connect the other end to the grounding point as shown. Do not connect this jumper cable to any other part of the engine.

5. If the booster battery is in another vehicle, have an assistant start that vehicle and run it at a fast idle.
6. Start your vehicle. If the starter motor still operates slowly, check that the jumper cables have good metal-to-metal contact.
7. Once your vehicle is running, disconnect the negative cable from your vehicle, then from the booster battery. Disconnect the positive cable from your vehicle, then from the booster battery.

Keep the ends of the jumper cables away from each other and any metal on the vehicle until everything is disconnected. Otherwise, you may cause an electrical short.

The reading of the vehicle's temperature gauge on the multi-information display should stay in the midrange. If it climbs to the H (Hot) mark, you should determine the reason (hot day, driving up a steep hill, etc.).

If the coolant temperature rises to 224°F (118°C) or more, the temperature gauge will appear on the display and blink for several times. At the same time, the beeper will sound once.

If your vehicle overheats, you should take immediate action. The only indication may be the temperature gauge climbing to the H (Hot) mark. Or you may see steam or spray coming from under the hood.

### NOTICE

*Driving with the temperature gauge reading at the H (Hot) mark can cause serious damage to the engine.*

### ⚠ WARNING

Steam and spray from an overheated engine can seriously scald you.

Do not open the hood if steam is coming out.

1. Safely pull to the side of the road. Put the transmission in Park, and set the parking brake. Turn off all accessories, and turn on the hazard warning lights.

2. If you see steam and/or spray coming from under the hood, turn off the engine. Wait until you see no more signs of steam or spray, then open the hood.
3. If you do not see steam or spray, leave the engine running and watch the temperature gauge. If the high heat is due to overloading, the engine should start to cool down almost immediately. If it does, wait until the temperature gauge comes down to the midpoint, then continue driving.
4. If the temperature gauge reading stays at the H (Hot) mark, turn off the engine.

CONTINUED

## If the Engine Overheats

---

5. Look for any obvious coolant leaks, such as a split radiator hose. Everything is still extremely hot, so use caution. If you find a leak, it must be repaired before you continue driving (see **Emergency Towing** on page 391 ).
6. If you do not find an obvious leak, check the coolant level in the radiator reserve tank. Add coolant if the level is below the MIN mark.
7. If there was no coolant in the reserve tank, you may need to add coolant to the radiator. Let the engine cool down until the reading reaches the middle of the temperature gauge or lower before checking the radiator.

### **WARNING**

Removing the radiator cap while the engine is hot can cause the coolant to spray out, seriously scalding you.

Always let the engine and radiator cool down before removing the radiator cap.

8. Using gloves or a large heavy cloth, turn the radiator cap counterclockwise, without pushing down, to the first stop. After the pressure releases, push down on the cap, and turn it until it comes off.
9. Start the engine, and set the temperature to maximum heat (climate control to AUTO at “**H**”). Add coolant to the radiator up to the base of the filler neck. If you do not have the proper coolant mixture available, you can add plain water. Remember to have the cooling system drained and refilled with the proper mixture as soon as you can.
10. Put the radiator cap back on tightly. Run the engine, and watch the temperature gauge. If it goes back to the H mark, the engine needs repair (see **Emergency Towing** on page 391 ).
11. If the temperature stays normal, check the coolant level in the radiator reserve tank. If it has gone down, add coolant to the MAX mark. Put the cap back on tightly.



## Low Oil Pressure Indicator, Charging System Indicator

### Low Oil Pressure Indicator



This indicator should never come on when the engine is running. If it starts flashing or stays on, the oil pressure has dropped very low or lost pressure. Serious engine damage is possible, and you should take immediate action.

You will also see an “OIL PRESSURE LOW” message on the multi-information display (see page 77 ).

#### NOTICE

*Running the engine with low oil pressure can cause serious mechanical damage almost immediately. Turn off the engine as soon as you can safely get the vehicle stopped.*

1. Safely pull off the road, and shut off the engine. Turn on the hazard warning lights.
2. Let the vehicle sit for a minute. Open the hood, and check the oil level (see page 276 ). An engine very low on oil can lose pressure during cornering and other driving maneuvers.
3. If necessary, add oil to bring the level back to the full mark on the dipstick (see page 336 ).
4. Start the engine, and watch the oil pressure indicator. If it does not go out within 10 seconds, turn off the engine. There is a mechanical problem that needs to be repaired before you can continue driving (see **Emergency Towing** on page 391 ).

### Charging System Indicator



If the charging system indicator comes on brightly when the engine is running, the battery is not being charged.

You will also see a “CHECK CHARGING SYSTEM” message on the multi-information display (see page 77 ).

Immediately turn off all electrical accessories. Try not to use other electrically operated controls such as the power windows. Keep the engine running; starting the engine will discharge the battery rapidly.

Go to a service station or garage where you can get technical assistance.

## Malfunction Indicator Lamp

---



If the indicator comes on while driving, it means one of the engine's emissions control systems may have a problem. Even though you may feel no difference in your vehicle's performance, it can reduce your fuel economy and cause increased emissions. Continued operation may cause serious damage.

If you have recently refueled your vehicle, the indicator coming on could be due to a loose or missing fuel fill cap. Tighten the cap until it clicks at least once. Tightening the cap will not turn the indicator off immediately; it can take several days of normal driving.

If the indicator comes on repeatedly, even though it may turn off as you continue driving, have your vehicle checked by your dealer as soon as possible.

### NOTICE

*If you keep driving with the malfunction indicator lamp on, you can damage your vehicle's emissions controls and engine. Those repairs may not be covered by your vehicle's warranties.*

The indicator may also come on with the "D" indicator.

You will also see a "CHECK EMISSION SYSTEM" message on the multi-information display (see page 77 ).

### Readiness Codes

Your vehicle has certain "readiness codes" that are part of the on-board diagnostics for the emissions systems. In some states, part of the emissions testing is to make sure these codes are set. If they are not set, the test cannot be completed.

If the battery in your vehicle has been disconnected or gone dead, these codes are erased. It takes at least three days of driving under various conditions to set the codes again.

To check if they are set, turn the ignition switch to the ON (II) position, without starting the engine. The malfunction indicator lamp will come on for 20 seconds. If it then goes off, the readiness codes are set. If it blinks five times, the readiness codes are not set. If possible, do not take your vehicle for an emissions test until the readiness codes are set. Refer to **Emissions Testing** for more information (see page 406 ).

U. S.

Canada

**BRAKE**



### Brake System Indicator (Red)

The brake system indicator (red) normally comes on when you turn the ignition switch to the ON (II) position, and as a reminder to check the parking brake. It will stay on if you do not fully release the parking brake.

If the brake system indicator (red) comes on while driving, the brake fluid level is probably low. Press lightly on the brake pedal to see if it feels normal. If it does, check the brake fluid level the next time you stop at a service station (see page [345](#)).

You will also see a “BRAKE FLUID LOW” message on the multi-information display (see page [77](#) ).

If the fluid level is low, take your vehicle to a dealer, and have the brake system inspected for leaks or worn brake pads.

However, if the brake pedal does not feel normal, you should take immediate action. A problem in one part of the system’s dual circuit design will still give you braking at two wheels. You will feel the brake pedal go down much farther before the vehicle begins to slow down, and you will have to press harder on the pedal.

You will also see a “CHECK BRAKE SYSTEM” message on the multi-information display (see page [77](#) ).

Slow down by shifting to a lower gear, and pull to the side of the road when it is safe. Because of the long distance needed to stop, it is hazardous to drive the vehicle. You should have it towed, and repaired as soon as possible (see **Emergency Towing** on page [391](#) ).

If you must drive the vehicle a short distance in this condition, drive slowly and carefully.

If the ABS indicator and the VSA system indicator come on with the brake system indicator, have your vehicle inspected by your dealer immediately.

## Brake System Indicator

---

U. S.



Canada



### Brake System Indicator (Amber)

Your vehicle has an electric vacuum pump located in the engine compartment. It enhances the effectiveness of your vehicle's brake system more frequently when you drive in cold weather or thinner air at high altitude after the engine is started.

When the electric vacuum pump is in operation, it makes some mechanical noises come from the engine compartment. This is normal.

The brake system indicator (amber) on the instrument panel normally comes on for a few seconds when you turn the ignition switch to the ON (II) position. If it stays on after the engine starts, press on the brake pedal with your foot several times until the indicator turns off. If the indicator is still on or comes on again after this procedure, there is a problem in the brake system including the electric vacuum pump. If this happens, the brake pedal might feel heavy when you press it. Have your vehicle checked by your dealer.

You will also see a "CHECK BRAKE SYSTEM" message on the multi-information display (see page [77](#) ).

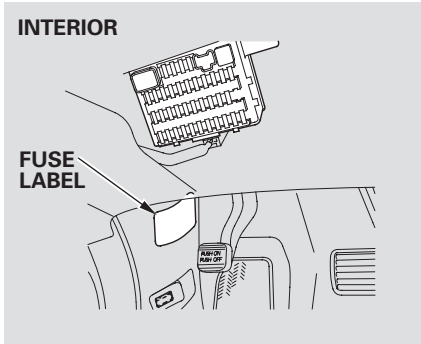

The vehicle's fuses are contained in three fuse boxes.

The interior fuse box is on the driver's lower left side.

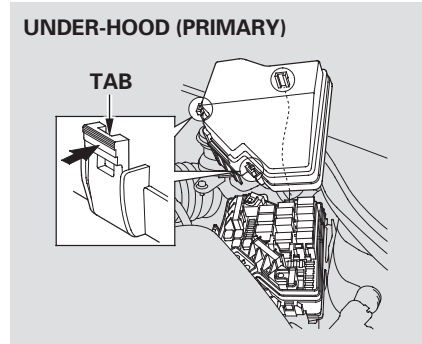

The primary under-hood fuse box is in the engine compartment on the driver's side. To open it, push the tabs as shown.

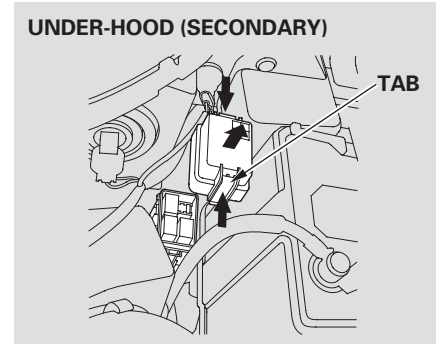

The secondary under-hood fuse box is next to the battery. To open it, push the tabs as shown.

# Fuses

## Checking and Replacing Fuses

If something electrical in your vehicle stops working, the first thing you should check for is a blown fuse. Determine from the chart on pages 389 and 390, or the diagram on the fuse box lid, which fuse or fuses control that device. Check those fuses first, but check all the fuses before deciding that a blown fuse is the cause. Replace any blown fuses, and check if the device works.

1. Turn the ignition switch to the LOCK (0) position. Make sure the headlights and all other accessories are off.
2. (Under-hood fuse boxes)  
Remove the cover from the fuse box.

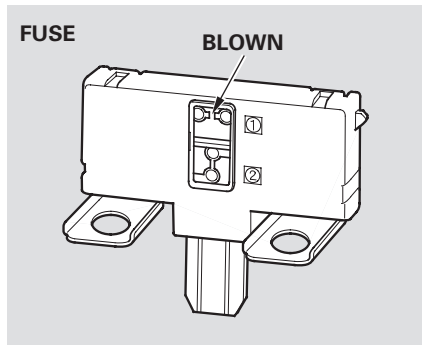

3. Check each of the large fuses in the under-hood fuse box by looking through the side window at the wire inside. Remove the screws with a Phillips-head screwdriver.

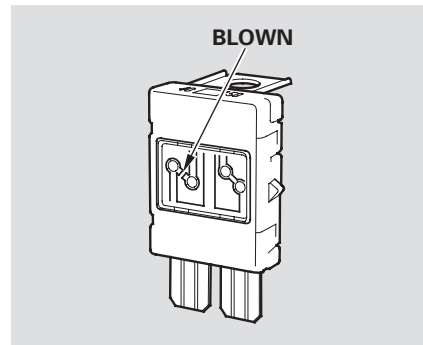

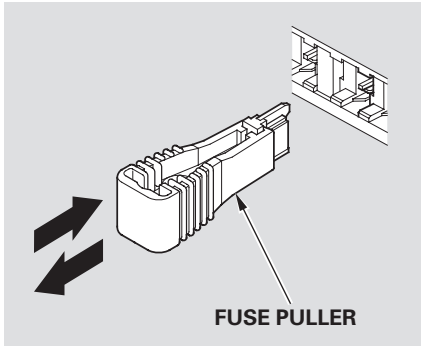

4. Check the smaller fuses in the under-hood fuse box and all the fuses in the interior fuse boxes by pulling out each one with the fuse puller provided on the back of the under-hood fuse box cover.

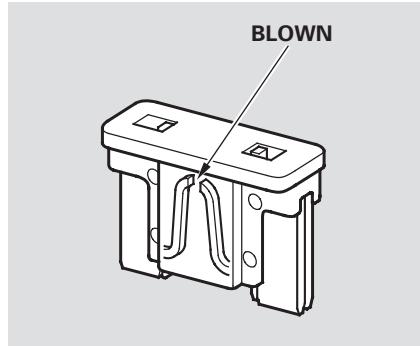

5. Look for a blown wire inside the fuse. If it is blown, replace it with one of the spare fuses of the same rating or lower. The spare fuses are provided back of the under-hood fuse cover.

If you cannot drive the vehicle without fixing the problem, and you do not have a spare fuse, take a fuse of the same rating or a lower rating from one of the other circuits. Make sure you can do without that circuit temporarily (such as the accessory power socket or radio). If you replace the blown fuse with a spare fuse that has a lower rating, it might blow out again. This does not indicate anything wrong. Replace the fuse with one of the correct rating as soon as you can.

*CONTINUED*

## NOTICE

*Replacing a fuse with one that has a higher rating greatly increases the chances of damaging the electrical system. If you do not have a replacement fuse with the proper rating for the circuit, install one with a lower rating.*

6. If the replacement fuse of the same rating blows in a short time, there is probably a serious electrical problem in your vehicle. Leave the blown fuse in that circuit and have your vehicle checked by a qualified technician.

If the audio fuse is removed, the audio system will disable itself. The next time you turn on the audio you will see “ENTER CODE” on the display. Use the preset bars or buttons (depending on models) to enter the five-digit code (see page [232](#)).

### *On RDX model*

When the audio system is disabled, the clock setting in the audio system will be canceled. You will need to reset the clock (see page [188](#)).

### *On RDX with technology Package model*

If the navigation system fuse is removed, the navigation system will disable itself. The next time you turn on the ignition switch, the system will require you to enter a PIN before it can be used. Refer to the Navigation System Owner’s Manual.



## INTERIOR FUSE BOX

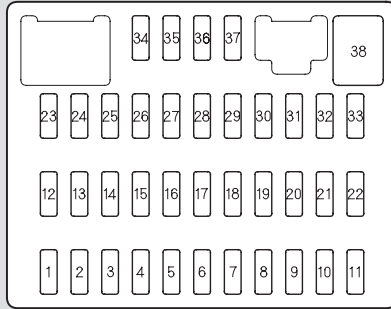

No.	Amps.	Circuits Protected
1	7.5 A	SH-AWD
2	20 A	Fuel Pump
3	15 A	ACG
4	7.5 A	ABS/VSA
5	15 A	Heated Seat
6	20 A	FR Fog Lights
7	7.5 A	Driver's Power Seat Lumbar Support

No.	Amps.	Circuits Protected
8	10 A	RR Wiper
9	7.5 A	OPDS
10	7.5 A	Meter
11	10 A	SRS
12	10 A	Right Headlight High
13	10 A	Left Headlight High
14	7.5 A	Small Lights (Interior)
15	15 A	Small Lights (Exterior)

No.	Amps.	Circuits Protected
16	15 A	Right Headlight Low
17	15 A	Left Headlight Low
18	20 A	Headlight High Main
19	20 A	Small Lights Main
20	7.5 A	TPMS
21	30 A	Headlight Low Main
22	–	Not Used
23	–	Not Used
24	20 A	Moonroof
25	20 A	Door Lock
26	20 A	Driver's Power Window
27	–	Not Used
28	15 A	Accessory Socket (Console Compartment)
29	15 A	+ B ACC
30	20 A	Passenger's Power Window
31	20 A	Radio Amplifier
32	20 A	Right Rear Power Window
33	20 A	Left Rear Power Window
34	–	Not Used
35	7.5 A	Radio
36	10 A	HAC
37	7.5 A	Daytime Running Light
38	30 A	FR Wiper

# Fuse Locations

## UNDER-HOOD FUSE BOXES

### PRIMARY

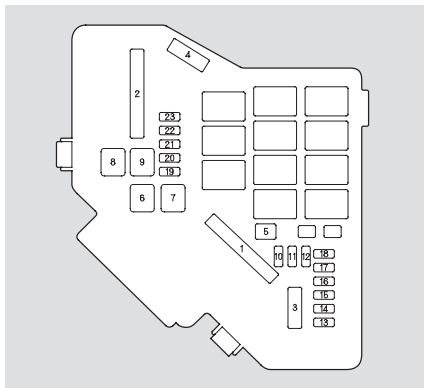

### SECONDARY

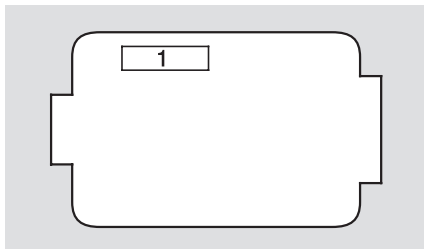

### Primary Fuse Box

No.	Amps.	Circuits Protected
1	100 A	Main Fuse
	30 A	SH-AWD
2	80 A	Option Main
	50 A	Ignition Switch Main
3	20 A	ABS/VSA Fail Safe
	40 A	ABS/VSA Motor
4	50 A	Headlight Main
	40 A	Power Window Main
5	—	Not Used
6	30 A	Main Fan Motor
7	30 A	Sub Fan Motor
8	30 A	Rear Defogger
9	40 A	Blower
10	15 A	Hazard

No.	Amps.	Circuits Protected
11	15 A	LAF
12	15 A	Stop & Horn
13	20 A	Power Seat (Recline)
14	20 A	Power Seat (Slide)
15	7.5 A	IGPS Oil Level
16	—	Not Used
17	15 A	Electric Vacuum Pump
18	15 A	IG Coil
19	15 A	FI Main
20	7.5 A	MG Clutch
21	15 A	DBW
22	7.5 A	Interior Light
23	10 A	Back Up

### Secondary Fuse Box

No.	Amps.	Circuits Protected
1	7.5 A	Electric Vacuum Pump

If your vehicle needs to be towed, call a professional towing service or organization. Never tow your vehicle with just a rope or chain. It is very dangerous.

**The only way you can safely tow your vehicle is with flat-bed equipment.** The operator will load your vehicle on the back of a truck. Any other method of towing will damage the drive system. When you contact the towing agency, inform them a flat-bed is required.

### NOTICE

*Towing with only two tires on the ground will damage parts of the all-wheel-drive system. Your vehicle should be transported on a flat-bed truck or trailer.*



The diagrams in this section give you the dimensions and capacities of your vehicle and the locations of the identification numbers. It also includes information you should know about your vehicle's tires and emissions control systems.

Identification Numbers .....	394	Emissions Controls.....	403
Specifications .....	396	The Clean Air Act.....	403
DOT Tire Quality Grading (U.S. Vehicles) .....	398	Crankcase Emissions Control System.....	403
Uniform Tire Quality Grading .....	398	Evaporative Emissions Control System.....	403
Treadwear .....	398	Onboard Refueling Vapor Recovery .....	403
Traction.....	398	Exhaust Emissions Controls ...	404
Temperature .....	399	PGM-FI System .....	404
Tire Labeling.....	400	Ignition Timing Control System.....	404
Tire Pressure Monitoring System (TPMS) – Required Federal Explanation.....	401	Three Way Catalytic Converter.....	404
		Replacement Parts.....	404
		Three Way Catalytic Converter...	405
		Emissions Testing .....	406

## Identification Numbers

Your vehicle has several identifying numbers located in various places.

The vehicle identification number (VIN) is the 17-digit number your dealer uses to register your vehicle for warranty purposes. It is also necessary for licensing and insuring your vehicle. The easiest place to find the VIN is on a plate fastened to the top of the dashboard. You can see it by looking through the windshield on the driver's side. It is also on the certification label attached to the driver's doorjamb, and is stamped on the engine compartment bulkhead. The VIN is also provided in bar code on the certification label.

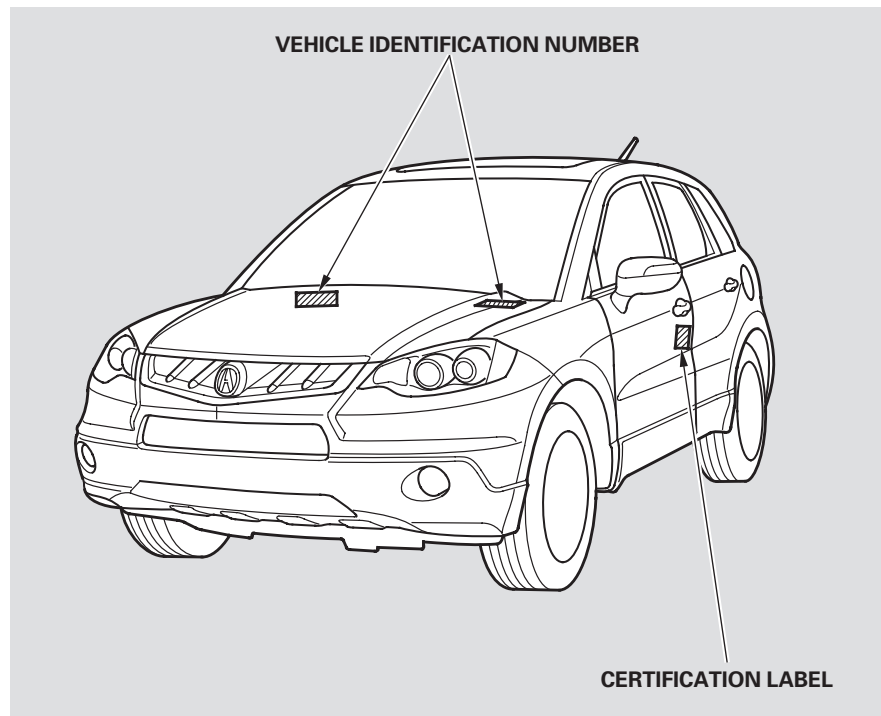

The engine number is stamped into the front of the engine block.

The transmission number is on a label on top of the transmission.

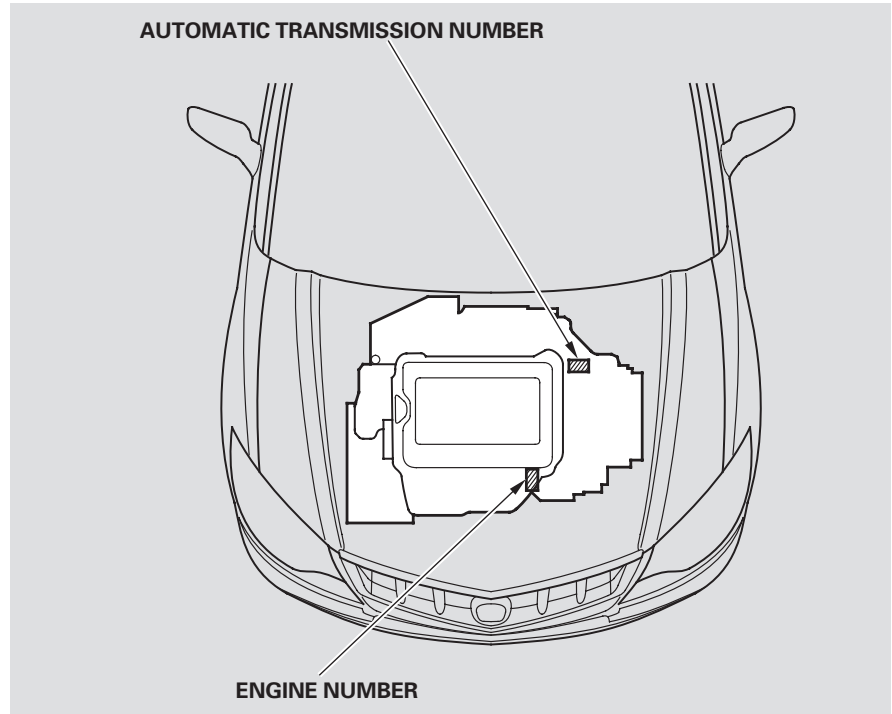

# Specifications

## Dimensions

Length		180.7 in (4,590 mm)
Width		73.6 in (1,870 mm)
Height		65.2 in (1,655 mm)
Wheelbase		104.3 in (2,650 mm)
Track	Front	61.9 in (1,572 mm)
	Rear	62.6 in (1,590 mm)

## Weights

Gross vehicle weight rating	See the certification label attached to the driver's doorjamb.
-----------------------------	----------------------------------------------------------------

## Engine

Type	Water cooled 4-stroke DOHC i-VTEC 4-cylinder gasoline engine with turbo charger, intercooler
Bore x Stroke	3.39 x 3.90 in (86.0 x 99.0 mm)
Displacement	140.4 cu-in (2,300 cm <sup>3</sup> )
Compression ratio	8.8 : 1
Spark plugs	SILKR8A-S (NGK)

## Seating Capacities

Total	5
Front	2
Rear	3

## Capacities

Fuel tank		Approx. 18.0 US gal (68 ℓ)
Engine oil	Change* <sup>1</sup>	
	Including filter	5.0 US qt (4.7 ℓ)
	Without filter	4.8 US qt (4.5 ℓ)
	Total	6.1 US qt (5.8 ℓ)
Engine coolant	Change* <sup>2</sup>	1.85 US gal (7.0 ℓ)
	Total	2.22 US gal (8.4 ℓ)
Automatic transmission fluid	Change	3.5 US qt (3.3 ℓ)
	Total	8.2 US qt (7.8 ℓ)
Rear differential fluid	Change	2.6 US qt (2.5 ℓ)
	Total	2.9 US qt (2.7 ℓ)
Transfer assembly fluid	Change	0.45 US qt (0.43 ℓ)
	Total	0.48 US qt (0.45 ℓ)
Windshield washer reservoir	U.S. Vehicles	2.6 US qt (2.5 ℓ)
	Canada Vehicles	4.8 US qt (4.5 ℓ)

\* 1 : Excluding the oil remaining in the engine

\* 2 : Including the coolant in the reserve tank and that remaining in the engine  
Reserve tank capacity:  
0.18 US gal (0.7 ℓ)



## Air Conditioning

Refrigerant type	HFC-134a (R-134a)
Charge quantity	15.8–17.6 oz (450–500 g)
Lubricant type	SP-10

## Lights

Headlights	High	12 V – 60 W (HB3)
	Low*	12 V – 35 W (D2S)
Front turn signal/parking lights		12 V – 24/2.2 CP (Amber)
Front fog lights		12 V – 55 W (H11)
Front side marker lights		12 V – 3 CP
Rear turn signal lights		12 V – 21 W
Brake/Taillights (in fenders)		12 V – 21/5 W
Taillights (in tailgate)		12 V – 3 CP
Back-up lights		12 V – 21 W
Rear side marker lights		12 V – 2 CP
License plate lights		12 V – 3 CP
High-mount brake light		12 V – 16 W
Rear ceiling light		12 V – 8 W
Front ceiling lights/Spotlights		12 V – 4 CP
Door courtesy lights		12 V – 2 CP
Cargo area light		12 V – 5 W

\* : The low beam headlights are high voltage discharged type.

Replacement of a low beam headlight bulb should be performed by your dealer.

## Battery

Capacity	12 V – 52 AH/5 HR
	12 V – 65 AH/20 HR

## Fuses

Interior	See page 389 or the fuse label attached to the dashboard.
Under-hood	See page 390 or the fuse box covers.

## Alignment

Toe-in	Front	0.0 in (0 mm)
	Rear	0.10 in (2.5 mm)
Camber	Front	0°10'
	Rear	– 1°
Caster	Front	2°57'

## Tires

Size	Front/Rear	P235/55R18 99V
	Spare	T165/80D17 104M
Pressure	Front/Rear	32 psi (220 kPa, 2.2 kgf/cm <sup>2</sup> )
	Spare	60 psi (420 kPa, 4.2 kgf/cm <sup>2</sup> )

## DOT Tire Quality Grading (U.S. Vehicles)

---

The tires on your vehicle meet all U.S. Federal Safety Requirements. All tires are also graded for treadwear, traction, and temperature performance according to Department of Transportation (DOT) standards. The following explains these gradings.

### **Uniform Tire Quality Grading**

Quality grades can be found where applicable on the tire sidewall between tread shoulder and maximum section width. For example:

**Treadwear 200**

**Traction AA**

**Temperature A**

All passenger car tires must conform to Federal Safety Requirements in addition to these grades.

### **Treadwear**

The treadwear grade is a comparative rating based on the wear rate of the tire when tested under controlled conditions on a specified government test course. For example, a tire graded 150 would wear one and one-half (1 1/2) times as well on the government course as a tire graded 100. The relative performance of tires depends upon the actual conditions of their use, however, and may depart significantly from the norm due to variations in driving habits, service practices and differences in road characteristics and climate.

### **Traction**

The traction grades, from highest to lowest, are AA, A, B, and C. Those grades represent the tire's ability to stop on wet pavement as measured under controlled conditions on specified government test surfaces of asphalt and concrete. A tire marked C may have poor traction performance.

**Warning:** The traction grade assigned to this tire is based on straight-ahead braking traction tests, and does not include acceleration, cornering, hydroplaning, or peak traction characteristics.

### Temperature

The temperature grades are A (the highest), B, and C, representing the tire's resistance to the generation of heat and its ability to dissipate heat when tested under controlled conditions on a specified indoor laboratory test wheel. Sustained high temperature can cause the material of the tire to degenerate and reduce tire life, and excessive temperature can lead to sudden tire failure. The grade C corresponds to a level of performance which all passenger car tires must meet under the Federal Motor Vehicle Safety Standard No. 109. Grades B and A represent higher levels of performance on the laboratory test wheel than the minimum required by law.

Warning: The temperature grade for this tire is established for a tire that is properly inflated and not overloaded. Excessive speed, underinflation, or excessive loading, either separately or in combination, can cause heat buildup and possible tire failure.

# Tire Labeling

The tires that came on your vehicle have a number of markings. Those you should be aware of are described below.

## TIRE LABELING EXAMPLE

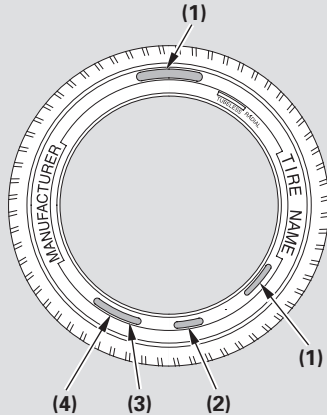

- (1) Tire Size
- (2) Tire Identification Number (TIN)
- (3) Maximum Tire Pressure
- (4) Maximum Tire Load

### *Tire Size*

Whenever tires are replaced, they should be replaced with tires of the same size. Below is an example of tire size with an explanation of what each component means.

P235/55R18 99V

- P – Vehicle type (P indicates passenger vehicle).
- 235 – Tire width in millimeters.
- 55 – Aspect ratio (the tire's section height as a percentage of its width).
- R – Tire construction code (R indicates radial).
- 18 – Rim diameter in inches.
- 99 – Load index (a numerical code associated with the maximum load the tire can carry).
- V – Speed symbol (an alphabetical code indicating the maximum speed rating).

### *Tire Identification Number (TIN)*

The tire identification number (TIN) is a group of numbers and letters that look like the following example. TIN is located on the sidewall of the tire.

DOT B97R FW6X 2202

- DOT – This indicates that the tire meets all requirements of the U.S. Department of Transportation.
- B97R – Manufacturer's identification mark.
- FW6X – Tire type code.
- 2202 – Date of manufacture.
  - 22 – year
  - 02 – week

## Tire Labeling, Tire Pressure Monitoring System (TPMS) – Required Federal Explanation

### **Maximum Tire Pressure**

Max Press — The maximum air pressure the tire can hold.

### **Maximum Tire Load**

Max Load — The maximum load the tire can carry at maximum air pressure.

### **Tire Pressure Monitoring System (TPMS)**

Each tire, including the spare (if provided), should be checked monthly when cold and inflated to the inflation pressure recommended by the vehicle manufacturer on the vehicle placard or tire inflation pressure label.

(If your vehicle has tires of a different size than the size indicated on the vehicle placard or tire inflation pressure label, you should determine the proper tire inflation pressure for those tires.)

As an added safety feature, your vehicle has been equipped with a tire pressure monitoring system (TPMS) that illuminates a low tire pressure telltale



when one or more of your tires is significantly underinflated.

Accordingly, when the low tire pressure telltale illuminates, you should stop and check your tires as soon as possible, and inflate them to the proper pressure.

CONTINUED

## Tire Pressure Monitoring System (TPMS) – Required Federal Explanation

---

Driving on a significantly under-inflated tire causes the tire to overheat and can lead to tire failure. Under-inflation also reduces fuel efficiency and tire tread life, and may affect the vehicle's handling and stopping ability.

Please note that the TPMS is not a substitute for proper tire maintenance, and it is the driver's responsibility to maintain correct tire pressure, even if under-inflation has not reached the level to trigger illumination of the TPMS low tire pressure telltale.

Your vehicle has also been equipped with a TPMS malfunction indicator to indicate when the system is not operating properly. The TPMS malfunction indicator is combined with the low tire pressure telltale. When the system detects a malfunction, the telltale will flash for approximately one minute and then remain continuously illuminated. This sequence will continue upon subsequent vehicle start-ups as long as the malfunction exists.

When the malfunction indicator is illuminated, the system may not be able to detect or signal low tire pressure as intended.

TPMS malfunctions may occur for a variety of reasons, including the installation of replacement or alternate tires or wheels on the vehicle that prevent the TPMS from functioning properly.

Always check the TPMS malfunction telltale after replacing one or more tires or wheels on your vehicle to ensure that the replacement or alternate tires and wheels allow the TPMS to continue to function properly.

The burning of gasoline in your vehicle's engine produces several by-products. Some of these are carbon monoxide (CO), oxides of nitrogen (NO<sub>x</sub>), and hydrocarbons (HC). Gasoline evaporating from the tank also produces hydrocarbons. Controlling the production of NO<sub>x</sub>, CO, and HC is important to the environment. Under certain conditions of sunlight and climate, NO<sub>x</sub> and HC react to form photochemical "smog." Carbon monoxide does not contribute to smog creation, but it is a poisonous gas.

### **The Clean Air Act**

The United States Clean Air Act\* sets standards for automobile emissions. It also requires that automobile manufacturers explain to owners how their emissions controls work and what to do to maintain them. This section summarizes how the emissions controls work. Scheduled maintenance is on page [334](#).

\* In Canada, Acura vehicles comply with the Canadian emission requirements, as specified in an agreement with Environment Canada, at the time they are manufactured.

### **Crankcase Emissions Control System**

Your vehicle has a positive crankcase ventilation system. This keeps gasses that build up in the engine's crankcase from going into the atmosphere. The positive

crankcase ventilation valve routes them from the crankcase back to the intake manifold. They are then drawn into the engine and burned.

### **Evaporative Emissions Control System**

As gasoline evaporates in the fuel tank, an evaporative emissions control canister filled with charcoal adsorbs the vapor. It is stored in this canister while the engine is off. After the engine is started and warmed up, the vapor is drawn into the engine and burned during driving.

### **Onboard Refueling Vapor Recovery**

The onboard refueling vapor recovery (ORVR) system captures the fuel vapors during refueling. The vapors are adsorbed in a canister filled with activated carbon. While driving, the fuel vapors are drawn into the engine and burned off.

## Emissions Controls

---

### **Exhaust Emissions Controls**

The exhaust emissions controls include three systems: PGM-FI, ignition timing control, and three way catalytic converter. These three systems work together to control the engine's combustion and minimize the amount of HC, CO, and NO<sub>x</sub> that come out the tailpipe. The exhaust emissions control systems are separate from the crankcase and evaporative emissions control systems.

### ***PGM-FI System***

The PGM-FI system uses sequential multiport fuel injection. It has three subsystems: air intake, engine control, and fuel control. The powertrain control module (PCM) uses various sensors to determine how much air is going into the engine. It then controls how much fuel to inject under all operating conditions.

### ***Ignition Timing Control System***

This system constantly adjusts the ignition timing, reducing the amount of HC, CO, and NO<sub>x</sub> produced.

### ***Three Way Catalytic Converter***

The three way catalytic converter is in the exhaust system. Through chemical reactions, it converts HC, CO, and NO<sub>x</sub> in the engine's exhaust to carbon dioxide (CO<sub>2</sub>), nitrogen (N<sub>2</sub>), and water vapor.

### **Replacement Parts**

The emissions control systems are designed and certified to work together in reducing emissions to levels that comply with the Clean Air Act. To make sure the emissions remain low, you should use only new Acura replacement parts or their equivalent for repairs. Using lower quality parts may increase the emissions from your vehicle.

The emissions control systems are covered by warranties separate from the rest of your vehicle. Read your warranty manual for more information.



## Three Way Catalytic Converter

The three way catalytic converters contain precious metals that serve as catalysts, promoting chemical reactions to convert the exhaust gasses without affecting the metals. The catalytic converters are referred to as three-way catalysts, since they act on HC, CO, and NOx. Replacement units must be original Acura parts or their equivalent.

The three way catalytic converter must operate at a high temperature for the chemical reactions to take place. It can set on fire any combustible materials that come near it. Park your vehicle away from high grass, dry leaves, or other flammables.

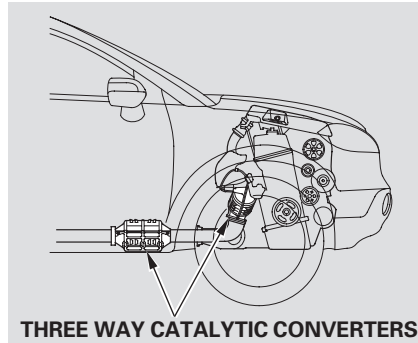

A defective three way catalytic converter contributes to air pollution, and can impair your engine's performance. Follow these guidelines to protect your vehicle's three way catalytic converter.

- Always use unleaded gasoline. Even a small amount of leaded gasoline can contaminate the catalyst metals, making the three way catalytic converter ineffective.

- Keep the engine well maintained.
- Have your vehicle diagnosed and repaired if it is misfiring, back-firing, stalling, or otherwise not running properly.

## Emissions Testing

---

### Testing of Readiness Codes

If you take your vehicle for an emissions test shortly after the battery has been disconnected or gone dead, it may not pass the test. This is because of certain “readiness codes” that must be set in the on-board diagnostics for the emissions systems. These codes are erased when the battery is disconnected, and set again only after several days of driving under a variety of conditions.

If the testing facility determines that the readiness codes are not set, you will be requested to return at a later date to complete the test. If you must get the vehicle retested within the next two or three days, you can condition the vehicle for retesting by doing the following.

1. Make sure the gas tank is nearly, but not completely, full (around 3/4).
2. Make sure the vehicle has been parked with the engine off for 6 hours or more.
3. Make sure the ambient temperature is between 40° and 95° F.
4. Without touching the accelerator pedal, start the engine, and let it idle for 20 seconds.
5. Keep the vehicle in Park. Increase the engine speed to 2,000 rpm, and hold it there until the temperature gauge rises to at least 1/4 of the scale (about 3 minutes).
6. Without touching the accelerator pedal and let the engine idle for 20 seconds.
7. Drive your vehicle for 30 seconds while accelerating.

8. Select a nearby lightly traveled major highway where you can maintain a speed of 50 to 60 mph for at least 20 minutes. Drive on the highway in D. Do not use the cruise control. When traffic allows, drive for 90 seconds without moving the accelerator pedal. (Vehicle speed may vary slightly; this is okay.) If you cannot do this for a continuous 90 seconds because of traffic conditions, drive for at least 30 seconds, then repeat it two more times (for a total of 90 seconds).
9. Then drive in city/suburban traffic for at least 10 minutes. When traffic conditions allow, let the vehicle coast for several seconds without using the accelerator pedal or the brake pedal.
10. Make sure the vehicle has been parked with the engine off for 30 minutes.

If the testing facility determines the readiness codes are still not set, see your dealer.



Client Service Information ..... 410  
Warranty Coverages ..... 411  
Reporting Safety Defects  
    (U.S. Vehicles) ..... 412  
Authorized Manuals ..... 413

## Client Service Information

---

Acura dealership personnel are trained professionals. They should be able to answer all your questions. If you encounter a problem that your dealership does not solve to your satisfaction, please discuss it with the dealership's management. The service manager or general manager can help. Almost all problems are solved in this way.

If you are dissatisfied with the decision made by the dealership's management, contact the Acura Client Services Office.

**U.S. Owners:**  
American Honda Motor Co., Inc.  
Acura Client Services  
Mail Stop 500-2N-7E  
1919 Torrance Blvd.  
Torrance, CA 90501-2746

Tel: (800) 382-2238

**Canadian Owners:**  
Acura Client Services  
Honda Canada Inc.  
715 Milner Avenue  
Toronto, ON  
M1B 2K8

Tel: 1-888-9-ACURA-9  
Fax: Toll-free 1-877-939-0909  
Toronto (416) 287-4776

**In Puerto Rico and the U.S. Virgin Islands:**  
Vortex Motor Corp.  
Bella International  
P.O. Box 190816  
San Juan, PR 00919-0816

Tel: (787) 620-7546

When you call or write, please give us this information:

- Vehicle Identification Number (see page [394](#))
- Name and address of the dealer who services your vehicle
- Date of purchase
- Mileage on your vehicle
- Your name, address, and telephone number
- A detailed description of the problem
- Name of the dealer who sold the vehicle to you

### U.S. Owners

Your new vehicle is covered by these warranties:

***New Vehicle Limited Warranty*** — covers your new vehicle, except for the battery, emissions control systems, and accessories against defects in materials and workmanship.

***Emissions Control Systems Defects Warranty and Emissions Performance Warranty*** — these two warranties cover your vehicle's emissions control systems. Time, mileage, and coverage are conditional. Please read your warranty booklet for exact information.

***Original Equipment Battery Limited Warranty*** — this warranty gives up to 100 % credit toward a replacement battery.

***Seat Belt Limited Warranty*** — a seat belt that fails to function properly is covered by a limited warranty. Please read your warranty booklet for details.

***Rust Perforation Limited Warranty*** — all exterior body panels are covered for rust-through from the inside for the specified time period with no mileage limit.

***Accessory Limited Warranty*** — Acura accessories are covered under this warranty. Time and mileage limits depend on the type of accessory and other factors. Please read your warranty manual for details.

***Replacement Parts Limited Warranty*** — covers all Acura replacement parts against defects in materials and workmanship.

***Replacement Battery Limited Warranty*** — provides prorated coverage for a replacement battery purchased from your dealer.

***Replacement Muffler Lifetime Limited Warranty*** — provides coverage for as long as the purchaser of the muffler owns the vehicle.

Restrictions and exclusions apply to all these warranties. Please read the 2008 Acura warranty information booklet that came with your vehicle for precise information on warranty coverages. Your vehicle's original tires are covered by their manufacturer. Tire warranty information is in a separate booklet.

### Canadian Owners

Please refer to the 2008 warranty manual that came with your vehicle.

## Reporting Safety Defects (U.S. Vehicles)

---

If you believe that your vehicle has a defect which could cause a crash or could cause injury or death, you should immediately inform the National Highway Traffic Safety Administration (NHTSA) in addition to notifying American Honda Motor Co., Inc.

If NHTSA receives similar complaints, it may open an investigation, and if it finds that a safety defect exists in a group of vehicles, it may order a recall and remedy campaign. However, NHTSA cannot become involved in individual problems between you, your dealer, or American Honda Motor Co., Inc.

To contact NHTSA, you may call the Vehicle Safety Hotline toll-free at 1-888-327-4236 (TTY: 1-800-424-9153); go to <http://www.safercar.gov>; or write to: Administrator, NHTSA, 1200 New Jersey Avenue, SE., Washington, DC 20590. You can also obtain other information about motor vehicle safety from <http://www.safercar.gov>.



## Purchasing Factory Authorized Manuals (U.S. only)

The publications shown below can be purchased from Helm Incorporated. You can order by phone or online:

- Call Helm Inc. at 1-800-782-4356 (credit card orders only)
- Go online at [www.helminc.com](http://www.helminc.com)

If you are interested in other years or models, contact Helm Inc. at 1-800-782-4356.

Publication Form Number	Form Description
61STK01	2007-2008 Acura RDX Service Manual
61STK01EL	2008 Acura RDX Electrical Troubleshooting Manual
61STK30	2007 Model series Acura RDX Body Repair Manual
31STK610	2008 Acura RDX Owner's Manual
31STK810	2008 Acura RDX Navigation System Manual
31STKM10	2008 Acura RDX Honda Service History
31STKQ10	2008 Acura RDX Quick Start Guide
ACU-R	Order Form for Previous Years- Indicate Year and Model Desired

## Service Manual:

Covers maintenance and recommended procedures for repair to engine and chassis components. It is written for the journeyman mechanic, but it is simple enough for most mechanically inclined owners to understand.

## Electrical Troubleshooting Manual:

Complements the Service Manual by providing in-depth troubleshooting information for each electrical circuit in your vehicle.

## Body Repair Manual:

Describes the procedures involved in the replacement of damaged body parts.



<b>A</b>	
Accessories.....	281
ACCESSORY (Ignition Key Position).....	122
Accessory Power Sockets.....	155
Active Head Restraints .....	135
AcuraLink.....	237
Additives, Engine Oil.....	337
Additives, Gasoline.....	272
Adjusting the Sound.....	186, 217
Adjusting the Steering Wheel.....	119
Adjust Outside Temperature .....	74
Adjust Outside Temp. Display .....	89
Advanced Airbags.....	27
Airbag (SRS) .....	9, 23
Air Conditioning System.....	160
Usage .....	161
Air Pressure, Tires .....	361
Antifreeze .....	340
Anti-lock Brakes (ABS)	
Indicator.....	64, 305
Operation.....	305
Anti-theft, Audio System.....	232
Anti-theft Steering Column	
Lock.....	122

Armrests.....	136
Audio Antenna .....	355
Audio System .....	168
Auto Door Lock .....	101
Auto Door Unlock.....	109
Automatic Lighting Off Feature..	115
Automatic Seat Belt Tensioners....	21
Automatic Transmission.....	293
Capacity, Fluid .....	396
Checking Fluid Level.....	343
Driving with the Paddle Shifters.....	297
Shifting.....	293
Shift Lever Position Indicators.....	293
Shift Lever Positions .....	294
Shift Lock Release.....	296
Auxiliary Input Jack.....	220

<b>B</b>	
Battery	
Charging System Indicator.....	63, 381
Jump Starting .....	377
Maintenance.....	366

Specifications .....	397
Before Driving .....	271
Belts, Seat .....	8, 19
Beverage Holders.....	154
Bluetooth® HandsFreeLink®.....	252
Booster Seats .....	53
Brakes	
Anti-lock System (ABS).....	305
Break-in, New Linings .....	272
Bulb Replacement .....	350
Fluid .....	345
Parking.....	148
System Indicator (Red).....	65, 383
System Indicator (Amber).....	65, 384
System Design .....	304
Wear Indicators .....	304
Braking System.....	304
Break-in, New Vehicle .....	272
Brightness Control, Instruments.....	117
Brights, Headlights .....	114

CONTINUED

# Index

---

Bulb Replacement		CAUTION, Explanation of .....	iii	Child Seats.....	35, 43
Back-up Lights .....	349	CD Care .....	223	LATCH.....	45
Brake Lights.....	350	CD Changer .....	173, 196	Tether Anchorage Points .....	50
Fog Lights .....	351	CD Changer Error		Childproof Door Locks .....	124
Front Parking Lights.....	348	Messages.....	226	Cleaning Seat Belts.....	354
Front Side Marker Lights.....	348	Ceiling Lights .....	149	Client Service Office .....	410
Headlights .....	347	Certification Label.....	394	Climate Control Sensors .....	167
High-mount Brake Light .....	352	Chains, Tires .....	365	Climate Control System.....	160
Rear Side Marker Lights .....	350	Changing a Flat Tire .....	371	Clock .....	188
Specifications .....	397	Changing Oil .....	338	Coin Holder .....	157
Taillights.....	349, 350	How to.....	338	CO in the Exhaust .....	403
Turn Signal Lights.....	348, 350	When to.....	327	Cold Weather, Starting in .....	292
Bulbs, Halogen.....	347, 351	Charging System Indicator ...	63, 381	Compact Spare Tire.....	370
Bulbs, High Voltage Discharged		Checklist, Before Driving.....	291	Console Compartment .....	156
Type.....	347	Child Safety .....	35	Consumer Information.....	410
		Booster Seats .....	53	Controls, Instruments and.....	59
		Child Seats.....	35, 43	Coolant	
		Important Safety Reminders.....	39	Adding.....	340
		Infants .....	40	Checking.....	277
		Large Children .....	52	Proper Solution .....	340
		LATCH .....	45	Temperature Gauge.....	73, 76
		Risks with Airbags.....	36	Courtesy Lights .....	151
		Small Children.....	41	Crankcase Emissions Control	
		Tethers.....	50	System.....	403
		Warning Labels.....	37	Cruise Control Indicator .....	67
		Where Should a Child Sit?.....	36	Cruise Control Operation .....	234

## C

Capacities Chart.....	396
Carbon Monoxide Hazard .....	56
Cargo .....	283
Cargo Area Cover .....	158
Cargo Area Light .....	151
Cargo Hooks .....	287
Cargo Net .....	287
Carrying Cargo .....	283

Cruise Main Indicator ..... 67  
 Cup Holders..... 154  
 Customized Settings..... 80  
     Default All..... 83  
     Door Setup..... 100  
     Lighting Setup..... 95  
     Meter Setup..... 86

**D**

DANGER, Explanation of ..... iii  
 Dashboard ..... 3, 60  
 Daytime Running Lights..... 116  
 Dead Battery ..... 377  
 Default All..... 83  
 Defects, Reporting Safety\* ..... 412  
 Defogger, Rear Window ..... 118  
 Defrosting the Windows..... 163  
 Dimensions..... 396  
 Dimming the Headlights ..... 114  
 Dipstick  
     Automatic Transmission..... 344  
     Engine Oil..... 277  
 Directional Signals..... 114  
 Disc Brake Wear Indicators..... 304  
 Disc Care ..... 223

Disc Changer ..... 173, 196  
 Disc Changer Error  
     Message..... 226  
 Disposal of Used Oil..... 339  
 Door Setup..... 100  
     Auto Door Lock ..... 101  
     Auto Door Unlock..... 109  
     Door Lock Mode..... 103  
     Keyless Lock  
         Acknowledgement..... 105  
         Security Relock Timer ..... 107  
 Doors  
     Childproof Door Locks ..... 124  
     Locking and Unlocking..... 123  
     Power Door Locks..... 123  
 DOT Tire Quality Grading\* ..... 398  
 Drive (D) ..... 295  
 Driver and Passenger Safety..... 5  
 Driving ..... 289  
     Economy ..... 278  
     Driving Guidelines..... 290  
     Driving Position Memory ..... 146  
     Driving with Paddle Shifters ..... 297  
         D-Paddle Shift Mode ..... 297  
         In S Position..... 299  
 Dual Temperature Control..... 165

Dust and Pollen Filter ..... 355

**E**

Economy, Fuel ..... 278  
 Elapsed Time ..... 73, 75  
     Reset Condition..... 93  
 Electric Vacuum Pump ..... 304, 384  
 Emergencies..... 369  
     Battery, Jump Starting ..... 377  
     Brake System Indicator  
         (Red) ..... 383  
     Brake System Indicator  
         (Amber) ..... 384  
     Changing a Flat Tire ..... 371  
     Charging System Indicator ..... 381  
     Checking the Fuses..... 386  
     Hazard Warning Flashers ..... 118  
     Jump Starting ..... 377  
     Low Oil Pressure Indicator ..... 381  
     Malfunction Indicator Lamp .... 382  
     Overheated Engine ..... 379  
     Tailgate Open..... 126  
     Emergency Towing ..... 391

CONTINUED

# Index

Emergency Brake.....	148
Emergency Flashers .....	118
Emissions Controls.....	403
Emissions Testing .....	406
Engine	
Adding Engine Coolant.....	340
Coolant Temperature	
Gauge.....	73, 76
If It Won't Start .....	375
Malfunction Indicator	
Lamp .....	63, 382
Oil Life Display .....	327
Oil Pressure Indicator .....	63, 381
Oil, What Kind to Use .....	336
Overheating.....	379
Specifications .....	396
Speed Limiter .....	295
Starting.....	292
Evaporative Emissions Controls..	403
Exhaust Emissions Controls .....	404
Exhaust Fumes .....	56
Expectant Mothers, Use of Seat	
Belts by .....	17

## F

Fan, Interior.....	162
Features .....	159
Filling the Fuel Tank.....	273
Filters	
Dust and Pollen.....	355
Oil .....	338
Flashers, Hazard Warning.....	118
Flat Tire, Changing a .....	371
Floor Mats .....	354
Fluids	
Automatic Transmission.....	343
Brake .....	345
Power Steering.....	346
Windshield Washer.....	342
Folding Rear Seat Down .....	136
Four-way Flashers .....	118
Front Airbags	
Driver's Side .....	9, 25
Passenger's Side .....	9, 32
Front Door Pockets.....	153
Front Seat	
Adjusting (Driver's Side) .....	131
Adjusting (Passenger's Side) ...	132
Heaters.....	139

Fuel.....	272
AVG. Fuel A/B .....	73, 75
Fill Door and Cap.....	273
Low Fuel Indicator .....	66
Gauge .....	71
INST. Fuel .....	73, 75
Octane Requirement .....	272
Oxygenated .....	273
Tank, Refueling .....	273
Tighten Fuel Cap Message .....	274
Fuel Economy .....	278
Fuse Locations.....	389
Fuses, Checking the.....	386

## G

Gas Mileage, Improving.....	278
Gasoline .....	272
AVG. Fuel A/B .....	73, 75
Low Fuel Indicator .....	66
Gauge .....	71
INST. Fuel .....	73, 75
Octane Requirement .....	272
Tank, Refueling .....	273
Gas Station Procedures.....	273

Gauges  
 Engine Coolant  
 Temperature ..... 73, 76  
 Fuel..... 71  
 Tachometer ..... 71  
 Turbo Boost Meter..... 71  
 Speedometer ..... 71  
 Gearshift Lever Positions ..... 293  
 Glove Box ..... 153  
 Gross Vehicle Weight Rating  
 (GVWR) ..... 315

**H**

Halogen Headlight Bulbs..... 347  
 Hanger Bars ..... 287  
 HandsFreeLink®, Bluetooth® ..... 252  
 Hazard Warning Flashers..... 118  
 Headlights  
 Aiming..... 347  
 Daytime Running Lights ..... 116  
 High Beam Indicator..... 67  
 High-Intensity Discharge  
 Lamp ..... 347  
 Reminder Tone ..... 114  
 Replacing Halogen Bulbs ..... 347

Turning on..... 114  
 Headlight Auto Off Timer ..... 98  
 Head Restraints ..... 133  
 Heated Mirrors ..... 145  
 Heaters, Seat ..... 139  
 High Beam Lever..... 114  
 HomeLink® Universal  
 Transceiver..... 247  
 Hood, Opening the ..... 275  
 Horn ..... 4, 111

**I**

Identification Number, Vehicle.... 394  
 Ignition  
 Keys..... 119  
 Switch..... 122  
 Timing Control System..... 404  
 Immobilizer System..... 121  
 Important Safety Precautions ..... 6  
 Indicators  
 ABS (Anti-Lock Brake)..... 64, 305  
 A/T Temperature..... 63  
 Brake (Amber) ..... 65, 385  
 Brake (Red)..... 65, 383  
 Charging System ..... 63, 381

Cruise Control..... 67  
 Cruise Main ..... 67  
 Fog Light ..... 68  
 High Beam..... 67  
 Key (Immobilizer System) ..... 64  
 Low Fuel ..... 66  
 Low Oil Pressure ..... 63, 381  
 Lights On..... 68  
 Low Tire Pressure/  
 TPMS ..... 69, 307  
 Maintenance Minder..... 70  
 Malfunction Indicator Lamp ..... 63  
 Passenger Airbag Off..... 32  
 Security System ..... 68, 233  
 SH-AWD ..... 68  
 Side Airbag Off ..... 31, 64  
 SRS ..... 31, 63  
 System Message ..... 70  
 TPMS, Low Tire Pressure.. 69, 307  
 Turn Signal and Hazard  
 Warning ..... 67  
 VSA (Vehicle Stability  
 Assist) ..... 66, 312  
 VSA Activation ..... 67, 312

*CONTINUED*

# Index

Individual Map Lights .....	150
Infant Restraint .....	40
Infant Seats .....	40
Tether Anchorage Points .....	50
Inflation, Proper Tire .....	360
Recommended Pressures .....	361
INFO Button .....	72
Inside Mirror .....	144
Inspection, Tire .....	361
Installing a Child Seat .....	44
Instrument Panel .....	61
Instrument Panel Brightness .....	117
Instruments and Controls .....	59
Intercooler .....	355
Interface Dial .....	189
Interior Lights .....	149
Interior Light Dimming Time .....	96
Introduction .....	i

## J

Jacking up the Vehicle .....	372
Jack, Tire .....	372
Jump Starting .....	377

## K

Keyless Lock	
Acknowledgement .....	105
Keyless Memory Settings .....	130
Keys .....	119

## L

Label, Certification .....	394
Lane Change, Signaling .....	114
Language Selection .....	87
Lap/Shoulder Belts .....	14, 20
LATCH Anchorage System .....	45
Lighting Setup .....	95
Interior Light Dimming	
Time .....	96
Headlight Auto Off Timer .....	98
Lights	
Bulb Replacement .....	347
Indicator .....	62
Parking .....	114
Turn Signal .....	114
Load Limits .....	284
LOCK (Ignition Key Position) .....	122
Lockout Prevention .....	124

## Locks

Anti-theft Steering Column .....	122
Childproof Door .....	124
Console Compartment .....	156
Fuel Fill Door .....	273
Glove Box .....	153
Power Door .....	123
Tailgate .....	125
Low Coolant Level .....	277
Lower Anchors .....	45
Low Fuel Indicator .....	66
Low Oil Pressure Indicator ....	63, 381
Low Tire Pressure/TPMS	
Indicator .....	69, 307
Lubricant Specifications Chart ....	369
Luggage Hooks (Cargo Hooks) ..	287
Luggage, Storing (Cargo) .....	283
Luggage Net (Cargo Net) .....	287

## M

Maintenance .....	325
Main Items and Sub Items .....	331
Minder .....	327



Minder Indicator ..... 73, 75  
 Owner's Maintenance  
     Checks ..... 333  
     Safety ..... 326  
 Malfunction Indicator Lamp .. 63, 382  
 Meters, Gauges ..... 71  
 Meter Setup ..... 86  
     Adjust Outside Temp. Display ... 89  
     Elap. Time Reset Condition ..... 93  
     Language Selection ..... 87  
     Trip A&Avg. Fuel Reset with  
         Refuel ..... 91  
 Mirrors, Adjusting ..... 144  
 Modifying Your Vehicle ..... 282  
 Moonroof ..... 142  
 Multi-Information Display ..... 72

**N**

Neutral Gear Position ..... 294  
 New Vehicle Break-in ..... 272  
 Normal Shift Speeds ..... 300  
 NOTICE, Explanation of ..... i  
 Numbers, Identification ..... 394

**O**

Octane Requirement, Gasoline .... 272  
 Odometer ..... 71  
 Off-Highway Driving ..... 321  
 Oil  
     Change, How to ..... 338  
     Change, When to ..... 327  
     Checking Engine ..... 276  
     Pressure Indicator ..... 63, 381  
     Selecting Proper Viscosity  
         Chart ..... 336  
 ON (Ignition Key Position) ..... 122  
 Onboard Refueling Vapor  
     Recovery ..... 403  
 Optional Cargo Net ..... 287  
 Outside Mirrors ..... 144  
 Outside Temperature ..... 73, 74  
 Overheating, Engine ..... 379  
 Owner's Maintenance Checks .... 333

**P**

Panel Brightness Control ..... 117  
 Park Gear Position ..... 294  
 Parking ..... 303

Parking Brake ..... 148  
 Parking Brake and Brake  
     System Indicator (Red) ..... 65, 383  
 Parking Lights ..... 114  
 Parking Over Things that Burn ... 303  
 Passenger Airbag Off Indicator .... 32  
 PGM-FI System ..... 404  
 Playing the XM® Satellite  
     Radio ..... 228  
 Pollen Filter ..... 355  
 Power Door Locks ..... 123  
 Power Sockets ..... 155  
 Power Steering Fluid ..... 346  
 Power Windows ..... 140  
 Pregnancy, Using Seat Belts ..... 17  
 Preparing to Drive ..... 291  
 Protecting Adults and Teens ..... 11  
     Additional Safety Precautions .... 18  
     Advice for Pregnant Women ..... 17

*CONTINUED*

# Index

---

Protecting Children .....	35
Protecting Infants .....	40
Protecting Larger Children .....	52
Protecting Small Children .....	41
Using Child Seats with Tethers.....	50
Using LATCH .....	45

## R

Radiator Overheating.....	379
Radio Theft Protection.....	232
Readiness Codes.....	382
Rear Pillar Lights, Bulb Replacement.....	350
Rear Seat, Folding Down.....	136
Rear View Camera and Monitor ..	270
Rear View Mirror.....	144
Rear Window Defogger .....	118
Rear Window Wiper and Washer.....	113
Reception, XM® Satellite Radio .....	228
Reclining the Seat Backs .....	131, 132
Recommended Shift Speeds .....	300
Refueling.....	273

Remote Audio Controls.....	230
Remote Transmitter .....	127
Replacement Information Dust and Pollen Filter .....	355
Engine Oil and Filter .....	338
Fuses .....	386
Light Bulbs .....	347
Tires .....	363
Transmitter Battery .....	128
Wiper Blades.....	356
Replacing Seat Belts After a Crash .....	22
Reporting Safety Defects* .....	412
Required Engine Oil.....	336
Reserve Tank, Engine Coolant.....	277, 340
Restraint, Child .....	35
Retractable Master Key.....	120
Reverse Gear Position.....	294
Reverse Mirror Tilt .....	145
Roof Rack .....	286
Rotation, Tire .....	363

## S

Safety Belts.....	8, 19
-------------------	-------

Safety Defects, Reporting* .....	412
Safety Features .....	7
Airbags.....	9
Seat Belts.....	8
Safety Labels, Location of .....	57
Safety Messages.....	iii
Satellite Radio, XM® .....	183, 211
Seat Belts .....	8, 19
Additional Information.....	19
Advice for Pregnant Women.....	17
Automatic Seat Belt Tensioners.....	21
Cleaning .....	354
Lap/Shoulder Belt.....	14, 20
Maintenance.....	22
Reminder Indicator and Beeper.....	19, 62
System Components.....	19
Use During Pregnancy.....	17
Wearing a Lap/Shoulder Belt....	14
Seat Heaters .....	139
Seats, Adjusting the.....	131, 132
Security Relock Timer .....	107
Security System .....	233
SEL/RESET Button .....	72
Serial Number .....	394

Service Station Procedures ..... 273  
 Setting the Clock ..... 188  
 SH-AWD (Super Handling-All  
 Wheel Drive) ..... 301  
     Indicator ..... 68  
     System Message ..... 78  
     Torque Distribution  
         Monitor ..... 76, 301  
 Shift Lever Position Indicators .... 293  
 Shift Lock Release ..... 296  
 Side Airbags ..... 9  
     How the Side Airbag Off  
         Indicator Works ..... 31  
     How Your Side Airbags Work... 29  
 Side Curtain Airbags ..... 9  
     How Your Side Curtain Airbags  
         Work ..... 30  
 Side Marker Lights, Bulb  
     Replacement ..... 348, 350  
 Signaling Turns ..... 114  
 Snow Tires ..... 364  
 Sound System ..... 168  
 Spare Tire ..... 370  
 Specifications ..... 396  
 Speed Limiter ..... 295

SRS, Additional Information ..... 23  
     Additional Safety Precautions... 34  
     Advanced Airbags ..... 27  
     Airbag Service ..... 33  
     Airbag System Components ..... 23  
     Dual-Stage Airbags ..... 26  
     Dual-Threshold Airbags ..... 27  
     How the Side Airbag Off  
         Indicator Works ..... 31  
     How the SRS Indicator Works... 31  
     How Your Front Airbags  
         Work ..... 25  
     How Your Side Airbags Work... 29  
     How Your Side Curtain Airbags  
         Work ..... 30  
 SRS Indicator ..... 31, 63  
 START (Ignition Key Position) ... 122  
 Starting the Engine ..... 292  
     In Cold Weather at High  
         Altitude ..... 292  
     With a Dead Battery ..... 377  
 Steam Coming from Engine ..... 379  
 Steering Wheel  
     Adjustment ..... 119  
     Anti-theft Column Lock ..... 122

Steering Wheel  
     Buttons ..... 72, 230, 234, 253  
 Storing Your Vehicle ..... 368  
 Sun Visor ..... 155  
 Supplemental Restraint  
     System ..... 9, 23  
     Servicing ..... 33  
     SRS Indicator ..... 31, 63  
     System Components ..... 23  
 Synthetic Oil ..... 336

**T**

Tailgate  
     Open Indicator ..... 11  
     Opening the ..... 125  
     Unlocking the Tailgate ..... 126  
 Taillights, Changing Bulbs... 349, 350  
 Taking Care of the Unexpected .. 369

# Index

---

Technical Descriptions		
DOT Tire Quality Grading* .....	398	
Emissions Control Systems .....	403	
Emissions Testing .....	406	
Three Way Catalytic Converter .....	405	
Tire Labeling .....	400	
Tire Pressure Monitoring System (TPMS) – Required Federal Explanation .....	401	
Temperature Gauge .....	73, 76	
Temperature, Outside .....	73, 74	
Tether Anchorage Points .....	50	
Theft Protection, Radio .....	232	
Three Way Catalytic Converter .....	417	
Tighten Fuel Cap Message .....	274	
Tilt the Steering Wheel .....	119	
Time, Setting the .....	188	
Tire Chains .....	365	
Tire, How to Change a Flat .....	371	
Tire Information* .....	398	
Tires .....	360	
Air Pressure .....	361	
Chains .....	365	
Checking Wear .....	362	
DOT Tire Quality Grading* .....	398	
Inflation .....	360	
Inspection .....	361	
Labeling .....	400	
Low Tire Pressure/TPMS Indicator .....	69, 307	
Maintenance .....	362	
Pressure Monitor .....	308	
Pressure Monitoring System .....	307	
Replacing .....	363	
Rotating .....	363	
Service Life .....	362	
Snow .....	364	
Specifications .....	364, 397	
Tools, Tire Changing .....	372	
Towing		
A Trailer .....	314	
Emergency Wrecker .....	391	
Equipment and Accessories .....	315	
Pre-Tow Checklist .....	318	
Weight Limit .....	314	
TPMS (Tire Pressure Monitoring System) .....	307	
Indicator .....	69, 307	
Required Federal Explanation .....	401	
Trailer Loading .....	314, 315	
Trailer Towing Tips .....	319	
Transmission		
Checking Fluid Level, Automatic .....	343	
Fluid Selection .....	344	
Identification Number .....	395	
Shifting the Automatic .....	293	
Treadwear .....	362	
Trip Meter .....	73, 74	
Turbo Boost Meter .....	71	
Turn Signals .....	114	
<b>U</b>		
Unexpected, Taking Care of the .....	369	
Uniform Tire Quality Grading* .....	398	
Unleaded Gasoline .....	272	
Used Oil, How to Dispose of .....	339	
<b>V</b>		
Vehicle Capacity Load .....	284	
Vehicle Dimensions .....	396	
Vehicle Identification Number .....	394	

Vehicle Stability Assist (VSA)	
System.....	312
Indicators.....	66, 67, 312
Vehicle Storage.....	368
Ventilation .....	163, 164
VIN .....	394
Viscosity, Oil.....	337
Defroster .....	163
Washers .....	342
Wipers, Windshield	
Changing Blades.....	356
Operation.....	112
Worn Tires .....	361
Wrecker, Emergency Towing.....	391

**W**

WARNING, Explanation of .....	iii
Warning Labels, Location of .....	57
Warranty Coverages* .....	411
Washers, Windshield	
Checking the Fluid Level .....	342
Operation.....	112
Wheels .....	359
Adjusting the Steering .....	119
Alignment and Balance.....	362
Wrench, Nut.....	372
Windows	
Auto Reverse.....	141
Operating the Power .....	140
Rear, Defogger .....	118
Windshield	
Cleaning .....	112

\* : U.S. only





## Service Information Summary

---

**Gasoline:**

Premium unleaded gasoline, pump octane number of 91 or higher.

**Fuel Tank Capacity:**

18.0 US gal (68 ℓ)

**Required Engine Oil:**

Always use Mobil 1® 5W-30 or an equivalent oil that meets the Acura HTO-06 standard.

Oil change capacity (including filter):

5.0 US qt (4.7 ℓ)

**Automatic Transmission Fluid:**

Honda ATF-Z1 (Automatic Transmission Fluid) (see page [343](#)).

**Rear Differential Fluid:**

Use Honda ATF-Z1 (Automatic Transmission Fluid) only.

Capacity:

SH-AWD differential case  
2.8 US qt (2.7 ℓ)

**Transfer Assembly Fluid:**

SAE 90 or SAE 80W-90 viscosity hypoid gear oil, API service classified GL4 or GL5 only.

**Power Steering Fluid:**

Honda Power Steering Fluid preferred, or another brand of power steering fluid as a temporary replacement. Do not use ATF (see page [346](#)).

**Brake Fluid:**

Honda Heavy Duty Brake Fluid DOT 3 preferred, or a DOT 3 or DOT 4 brake fluid as a temporary replacement (see page [345](#)).

**Tire Pressure (measured cold):**

Front/Rear:

32 psi (220 kPa , 2.2 kgf/cm<sup>2</sup>)

**Spare Tire Pressure:**

60 psi (420 kPa , 4.2 kgf/cm<sup>2</sup>)



## Owner's Identification

---

OWNER \_\_\_\_\_  
\_\_\_\_\_

ADDRESS \_\_\_\_\_

STREET

\_\_\_\_\_ CITY

\_\_\_\_\_ STATE/PROVINCE

\_\_\_\_\_ ZIP CODE/  
POSTAL CODE

V. I. N. \_\_\_\_\_

DELIVERY DATE \_\_\_\_\_

(Date sold to original retail purchaser)

DEALER NAME \_\_\_\_\_ DEALER NO. \_\_\_\_\_

ADDRESS \_\_\_\_\_

STREET

\_\_\_\_\_ CITY

\_\_\_\_\_ STATE/PROVINCE

\_\_\_\_\_ ZIP CODE/  
POSTAL CODE

OWNER'S SIGNATURE \_\_\_\_\_

DEALER'S SIGNATURE \_\_\_\_\_

This owner's manual should be considered a permanent part of the vehicle and should remain with the vehicle when it is sold.

This owner's manual covers all models of the Acura RDX. You may find descriptions of equipment and features that are not on your particular vehicle.

The information and specifications included in this publication were in effect at the time of approval for printing. Honda Motor Co., Ltd. reserves the right, however, to discontinue or change specifications or design at any time without notice and without incurring any obligation whatsoever.

**POUR CLIENTS CANADIEN  
AVIS IMPORTANT: Si vous avez  
besoin d'un Manuel du Conducteur  
en français, veuillez demander à  
votre concessionnaire de  
commander le numéro de pièce  
33STKC10**