

CLARITY

HONDA
The Power of Dreams

**2018 ELECTRIC
OWNER'S GUIDE**

DISCLOSURES

■ Devices That Emit Radio Waves

The following products and systems on your vehicle emit radio waves when in operation:

- Adaptive Cruise Control (ACC) with Low Speed Follow (LSF)
- Audio system
- Bluetooth® Audio
- Bluetooth HandsFreeLink®
- Charging cable
- Collision Mitigation Braking System™
- HomeLink® Universal Transceiver
- Immobilizer system
- Smart Entry System
- Wi-Fi

Each of the above complies with the appropriate requirements or the required standards of the FCC (Federal Communications Commission), described below:

As required by the FCC:

This device complies with Part 15 of the FCC rules. Operation is subject to the following two conditions: (1) This device may not cause harmful interference, and (2) this device must accept any interference received, including interference that may cause undesired operation.

Changes or modifications not expressly approved by the party responsible for compliance could void the user's authority to operate the equipment.

■ Disclaimer

The information and data contained herein are believed to be accurate and reliable. American Honda Motor Co., Inc. makes no warranty of any kind and accepts no responsibility for the results obtained through application of this information.

■ Service Diagnostic Recorders

This vehicle is equipped with service-related devices that record information about powertrain performance. The data can be used to verify emissions law requirements and/or help technicians diagnose and solve service problems. It may also be combined with data from other sources for research purposes, but it remains confidential. Some diagnostic and maintenance information is uploaded to Honda upon vehicle start up.

■ End User License Agreement

Your vehicle comes equipped with software, which is governed by the End User License Agreement in this vehicle's Owner's Manual, and which contains a binding arbitration clause. Please refer to the End User License Agreement for the terms and conditions governing your use of the installed software, as well as the applications, services, functions, and content provided through the software. Your use of the installed software will serve as your consent to the terms and conditions of the End User License Agreement.

You may opt out of the arbitration provisions within 30 days of your initial use of the Software by sending a signed, written notice to HONDA at American Honda Motor Co., Inc. Honda Automobile Customer Services Mail Stop 100-5E-8A, 1919 Torrance Blvd. Torrance, CA 90501-2746

■ Event Data Recorders

This vehicle is equipped with an event data recorder (EDR). The main purpose of an EDR is to record, in certain crash or near crash-like situations, such as an air bag deployment or hitting a road obstacle, data that will assist in understanding how a vehicle's systems performed.

The EDR is designed to record data related to vehicle dynamics and safety systems for a short period of time, typically 30 seconds or less. The EDR in this vehicle is designed to record such data as:

- **How various systems in your vehicle were operating;**
- **Whether or not the driver and passenger safety belts were buckled/fastened;**
- **How far (if at all) the driver was depressing the accelerator and/or brake pedal; and,**
- **How fast the vehicle was traveling.**

These data can help provide a better understanding of the circumstances in which crashes and injuries occur. NOTE: EDR data are recorded by your vehicle only if a non-trivial crash situation occurs; no data are recorded by the EDR under normal driving conditions and no personal data (e.g., name, gender, age, and crash location) are recorded. However, other parties, such as law enforcement, could combine the EDR data with the type of personally identifying data routinely acquired during a crash investigation.

To read data recorded by an EDR, special equipment is required, and access to the vehicle or the EDR is needed. In addition to the vehicle manufacturer, other parties such as law enforcement that have the special equipment can read the information if they have access to the vehicle or the EDR.

The data belong to the vehicle owner and may not be accessed by anyone else except as legally required or with the permission of the vehicle owner.

continued on inside back cover

INTRODUCTION

This Owner's Guide is intended to help you quickly get acquainted with your **2018 Honda Clarity Electric**. It provides basic information and instructions on technology and convenience features, as well as emergency procedures and how to get assistance.

This guide is for vehicles sold in the United States. It covers all Clarity Electric models, so you may find descriptions of features and equipment that are not in your vehicle. Images throughout this guide are from U.S. vehicles and represent features and equipment that are available on some, but not all, models.

This guide is not intended to be a substitute for the Owner's Manual at ev.owners.honda.com (U.S.). The Warranty Information CD enclosed in your glove box kit includes the vehicle and tire warranties in electronic format. This information can be viewed on a computer (PC or Mac platform) and saved or printed for your reference. You can also visit ev.owners.honda.com (U.S.) to view the complete and most current information.

If you are the first registered owner of your vehicle, you may request a complimentary printed copy of the Owner's Manual, Navigation Manual, or Vehicle Warranty within the first six months of vehicle purchase. To request a copy, visit ev.owners.honda.com and create or log in to your account.

American Honda Motor Co., Inc. strives to be proactive in protecting our environment and natural resources. By using electronic delivery for a considerable portion of the information typically found in a vehicle owner's manual, we are further reducing our impact on the environment.

Honda Automobile Customer Service

Your authorized Honda Clarity Electric dealer should be able to answer any questions you have about your vehicle. However, if you are dissatisfied with the information you receive, you can call Honda Automobile Customer Service at:

Call (800) 999-1009

Honda Roadside Assistance

24-hour emergency road service is available to you in the United States throughout your 3-year/36,000-mile warranty term. Services include jump starting, flat tire and lockout assistance, towing, and more (limitations apply).

Call (866) 372-5139

TABLE OF CONTENTS

VISUAL INDEX	1	AUDIO AND CONNECTIVITY	56
Steering Wheel and Nearby Controls.....	1	Basic Audio Operation.....	56
Steering Wheel and Nearby Controls (continued).....	2	Touchscreen Operation.....	59
Dashboard and Other Controls.....	3	HondaLink®.....	60
ABOUT BATTERY ELECTRIC VEHICLES	4	Wi-Fi Connection.....	62
SAFETY INFORMATION	7	Apple CarPlay™.....	62
Important Safety Information.....	7	Android Auto™.....	64
Seat Belts.....	8	iPod®.....	68
Airbags.....	12	USB Flash Drive.....	69
Child Safety.....	19	Bluetooth® Audio.....	70
Safety Label Locations.....	29	Pandora®.....	71
Reporting Safety Defects.....	29	BLUETOOTH® HANDSFREELINK® (HFL)	72
INSTRUMENT PANEL	30	Basic HFL Operation.....	72
Malfunction Indicators.....	30	Pairing a Phone.....	74
Condition Indicators.....	32	Making a Call.....	75
On/Off Indicators.....	33	HondaLink® Service.....	77
Driver Information Interface (DII).....	34	SMS Text Messaging and E-Mail.....	78
VEHICLE CONTROLS	36	Siri® Eyes Free.....	79
Using the Remote Transmitter.....	36	NAVIGATION	80
Smart Entry System.....	37	Basic Navigation Operation.....	80
Door Operation.....	39	Entering a Destination.....	83
Power Window Operation.....	41	Routing.....	87
Interior and Exterior Lights.....	42		
Wiper Operation.....	43		
One-Touch Turn Signal.....	44		
Adjusting the Seats.....	45		
Rear Seats.....	49		
Adjusting the Steering Wheel.....	50		
Driving Position Memory System.....	50		
Adjusting the Mirrors.....	51		
HomeLink® Universal Transceiver..	52		
Climate Control System.....	53		
Seat Heaters.....	54		
Customized Features.....	55		

**if equipped*

VISUAL INDEX

Quickly locate items in the vehicle's interior.

Steering Wheel and Nearby Controls

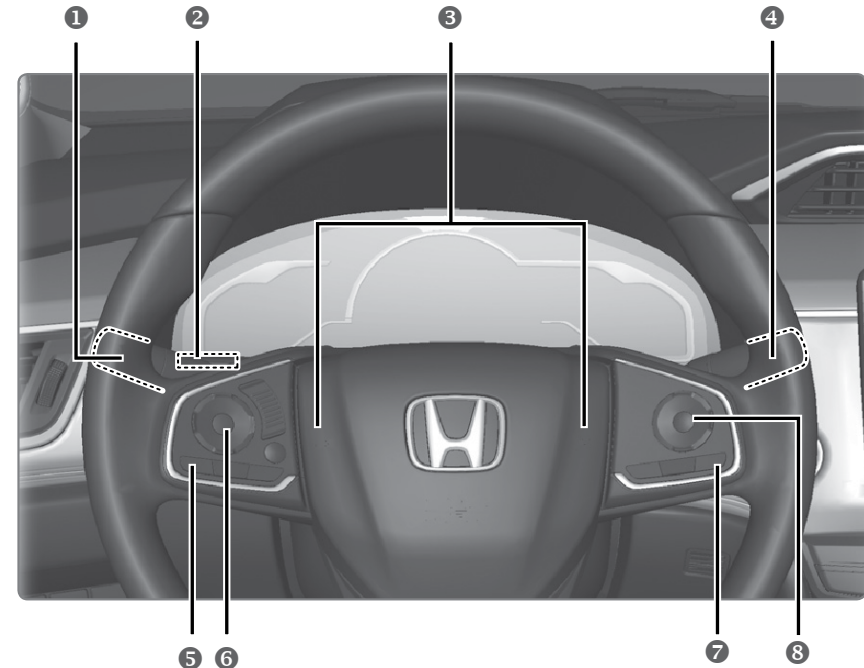

- ① Lights/turn signals/
LaneWatch™ button p. 42, p.
44, p. 110
- ② Brightness control p. 42
TRIP button p. 35
- ③ Horn
- ④ Wipers/washers p. 43
- ⑤ Voice control/*Bluetooth*®
HandsFreeLink® buttons p.
72
- ⑥ Display/Information button
Audio controls p. 57
- ⑦ Lane Keep Assist System
(LKAS) button p. 106
- ⑧ Adaptive Cruise Control (ACC)
with Low Speed Follow (LSF)
buttons/Interval button p. 103

DRIVING	89	MAINTENANCE	127
Before Driving	89	Safety Precautions	127
Maximum Load Limit	91	Maintenance Minder™	128
Towing a Trailer	92	Under the Hood	130
Remote Climate Control	93	Coolant Levels	132
Starting to Drive	94	Brake Fluid	133
Shifting.....	95	Checking the 12-volt Battery.....	134
Acoustic Vehicle Alerting System	96	Window Washer Fluid.....	134
Braking.....	97	Changing Wiper Blades	135
Eco Assist® System.....	100	Tire Information.....	136
Eco Drive Display.....	100	Tire Labeling.....	140
Deceleration Paddle Selector	101	DOT Tire Quality Grading	141
SPORT Mode	102	Air Conditioning.....	142
Vehicle Stability Assist® (VSA®) ...	102	SPECIFICATIONS	143
Adaptive Cruise Control (ACC) with Low Speed Follow (LSF).....	103	CUSTOMER INFORMATION	144
Lane Keeping Assist System (LKAS).....	106	Frequently Asked Questions/ Troubleshooting.....	144
Road Departure Mitigation (RDM)	107	Contact Us.....	145
Collision Mitigation Braking System™ (CMBS™).....	109	Honda Roadside Assistance	145
LaneWatch™	110	Warranty Coverages	146
Multi-View Rear Camera	112	EPA Contact Information	146
Charging	113	VOICE COMMAND INDEX	147
Improving Energy Efficiency	116	INDEX	149
HANDLING THE UNEXPECTED	117		
Smart Entry Remote Battery Strength.....	117		
Overheating	117		
Emergency Power System Off.....	118		
Emergency Towing	118		
Tire Pressure Monitoring System (TPMS).....	119		
Tire Repair Kit.....	121		
Fuse Locations	122		

Steering Wheel and Nearby Controls (continued)

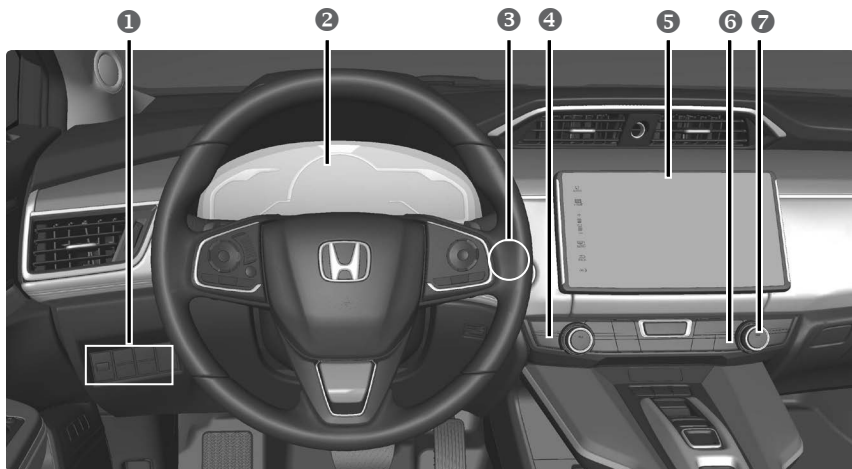

- ① Vehicle Stability Assist® (VSA®) OFF button p. 102
Road Departure Mitigation (RDM) button p. 107
Collision Mitigation Braking System™ (CMBS™) OFF button p. 109
Charge lid release button p. 115
- ② Instrument panel p. 30
Driver information interface p. 34
- ③ POWER button p. 94
- ④ Seat Heater Buttons p. 54
- ⑤ Navigation system p. 80
Audio system p. 59
Hazard Warning Button
- ⑥ Heated door mirror button
- ⑦ Climate control system p. 53

Dashboard and Other Controls

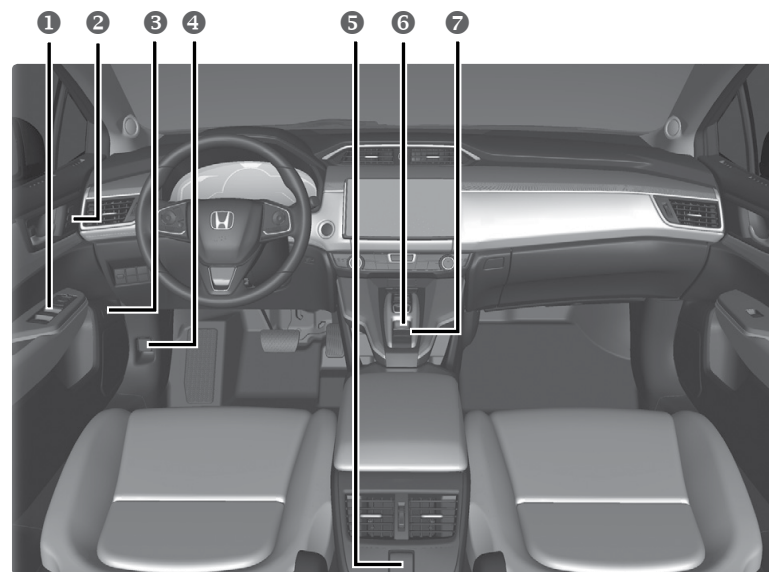

- ① Power window switches p. 41
Door lock switches p. 39
Door mirror controls p. 51
- ② Memory buttons p. 50
- ③ Trunk opener p. 40
- ④ Hood release handle p. 131
- ⑤ Accessory power socket p. 56
- ⑥ SPORT button p. 102
- ⑦ Electric Parking Brake Switch p. 98
Automatic brake hold button p. 98
Shift button/
Electronic gear selector p. 95

ABOUT BATTERY ELECTRIC VEHICLES

■ Battery Characteristics

Instead of using gasoline to power an internal combustion engine, your vehicle uses stored electricity to power an electric propulsion motor. Your driving style heavily impacts vehicle efficiency and driving range. Heavy use of the climate control system can also reduce the vehicle's range.

There are two types of batteries in this vehicle. A standard 12-volt battery powers the airbags, interior and exterior lights, and other standard 12-volt systems; a high-voltage lithium-ion battery powers the propulsion motor and recharges the 12-volt battery.

Battery electric vehicles have high-voltage components (about 350 V maximum) such as the EV PCU, High Voltage battery, power control unit, high-voltage cables (identified by their orange covers), electric motor, and high-temperature parts such as the radiator. Labels with handling warnings are attached to these components.

The High Voltage battery gradually discharges when the vehicle is not in use. If allowed to discharge too much, the battery may become damaged. If your vehicle is parked for an extended period of time (as when being stored), periodically recharge the battery to maintain sufficient charge levels. At least once every three months, turn on the power system and keep it on for more than 30 minutes to allow the battery to recharge. Excessive heat can also damage the battery. On hot, sunny days, try to avoid parking your vehicle under direct sunlight. If the High Voltage battery becomes fully discharged or damaged and you are unable to start the power system, consult an authorized Honda Clarity Electric dealer.

■ Temperature

When storing the vehicle, make sure not to expose it to extremely low temperatures: If the temperature of the High Voltage battery drops to -22°F (-30°C) or below, the power system may not start. Wait for the High Voltage battery to warm up, or warm it up by plugging in the vehicle. If the temperature of the High Voltage battery drops to -31°F (-35°C) or below, the power system will not start. Wait for the High Voltage battery to warm up or move the vehicle to a warmer location. Note plugging the vehicle in will not help in this case.

■ Battery Warming System

Designed to prevent the temperature of the battery from dropping when outside temperatures drop, thereby maintaining starting and running efficiency. If the vehicle is plugged in when outside temperatures are low, the battery warming system will use the power from the charging equipment to maintain the temperature of the battery until the next time the vehicle is driven.

NOTICE

If the vehicle is left unplugged in cold temperatures, the temperature of the battery will drop, possibly resulting in a loss of running efficiency. If left for an extended period of time in extremely cold temperatures, the vehicle may not start. We recommend that you plug in your vehicle when you are parking or storing your vehicle in cold temperatures.

■ Emergency Shutdown System

The emergency-shutdown system may activate when the vehicle is impacted by some incident such as a crash or collision. When this system activates, the High Voltage system automatically shuts down and your vehicle no longer moves. To place the High Voltage system back in operation, consult an authorized Honda Clarity Electric dealer.

SAFETY INFORMATION

Your safety—and the safety of others—is very important, and operating this vehicle safely is an important responsibility. While we strive to help you make informed decisions about safety, it is not practical or possible to warn you about all the hazards associated with operating or maintaining your vehicle. Therefore, you must use your own good judgment.

Important Safety Information

This guide explains many of your vehicle's safety features and how to use them. Please read this information carefully. Following the instructions below will also help to keep you and your passengers safe.

■ Important Safety Precautions

- Always wear your seat belt.
- Secure all children in the proper restraint system.
- Be aware of airbag hazards.
- Don't drink and drive.
- Pay appropriate attention to the task of driving safely.
- Do not leave children unattended in the vehicle.
- Control your speed.
- Keep your vehicle in safe condition.
- Handle high-voltage with care.

Engaging in cell phone conversation or other activities that keep you from paying close attention to the road, other vehicles, and pedestrians could lead to a crash. Remember, situations can change quickly and only you can decide when it is safe to divert some attention away from driving.

■ Safety Messages

When you see the following messages throughout this guide, pay close attention.

⚠ DANGER

You **WILL** be **KILLED** or **SERIOUSLY HURT** if you don't follow instructions.

⚠ WARNING

You **CAN** be **KILLED** or **SERIOUSLY HURT** if you don't follow instructions.

⚠ CAUTION

You **CAN** be **HURT** if you don't follow instructions.

NOTICE

This information is intended to help you avoid damage to your vehicle, other property, or the environment.

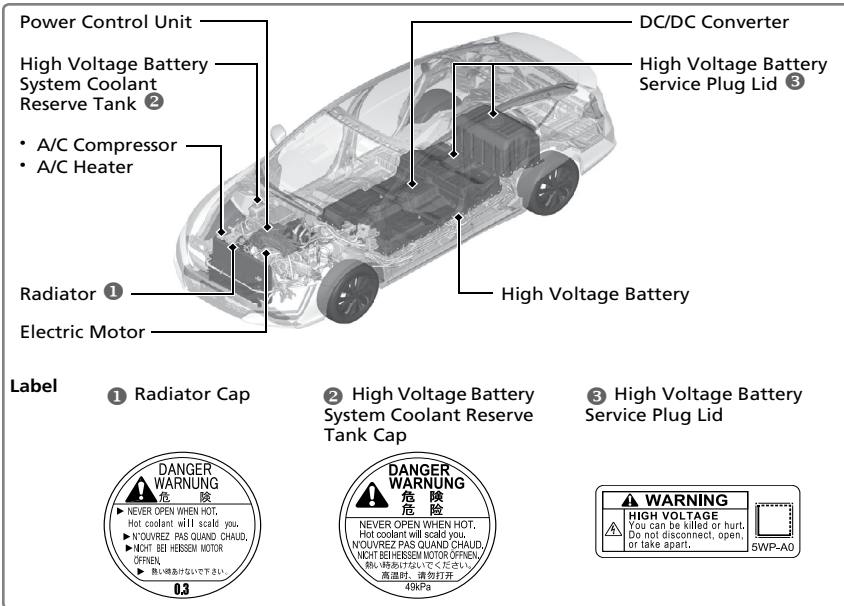

⚠ WARNING

This vehicle has high voltage circuits and parts. Failure to observe the following precautions can result in burns or electric shock.

- Do not remove, disassemble, or replace the high voltage parts, cables (orange) or their connectors.
- Never touch the High Voltage battery service plugs.

In an emergency or during maintenance or repair, the service plugs are removed to cut off the electric flow from the battery. These plugs are in contact with the battery and can cause severe electric shock if not handled properly.

Only a qualified technician should handle any electrical equipment. For inspection and repair, consult an authorized Honda Clarity Electric dealer.

⚠ WARNING

High voltage parts and/or the cables (orange) connecting them may be exposed as a result of a crash. Stay clear of these parts as you may be electrocuted.

If High Voltage battery fluid leaks, be careful not to touch the fluid. It can harm your eyes and skin. If it comes in contact with your eyes and skin; flush the affected area with clean water immediately for a few minutes, and seek immediate medical attention.

Seat Belts

A seat belt is your best protection in all types of collisions. Airbags are designed to supplement seat belts, not replace them. So even though your vehicle is equipped with airbags, make sure you and your passengers always wear your seat belts and wear them properly.

■ Lap/Shoulder Seat Belts

All five seating positions are equipped with lap/shoulder seat belts with emergency locking retractors. In normal driving, the retractor lets you move freely while keeping some tension on the belt. During a collision or sudden stop, the retractor locks to restrain your body. The rear seat belts also have a lockable retractor for use with child seats.

The front seats are equipped with automatic seat belt tensioners to enhance safety. The tensioners automatically tighten the front seat belts during a moderate-to-severe frontal collision, sometimes even if the collision is not severe enough to inflate the front airbags or the driver's knee airbag.

■ Proper Use of Seat Belts

Follow these guidelines for proper use:

- All occupants should sit upright, well back in the seat, and remain in that position for the duration of the trip. Slouching and leaning reduce the effectiveness of the belt and can increase the chance of serious injury in a crash.
- Never place the shoulder part of a lap/shoulder seat belt under your arm or behind your back. This could cause very serious injuries in a crash.
- Two people should never use the same seat belt. If they do, they could be very seriously injured in a crash.
- Do not put any accessories on the seat belts. Devices intended to improve comfort or reposition the shoulder part of a seat belt can reduce the protective capability and increase the chance of serious injury in a crash.
- No one should sit in a seat with an inoperative seat belt or one that does not appear to be working correctly. Using a seat belt that is not working properly may not protect the occupant in a crash. Have an authorized Honda Clarity Electric dealer check the belt as soon as possible.

⚠ WARNING

Not wearing a seat belt properly increases the chance of a serious injury or death in a crash, even though your vehicle has airbags.

Be sure you and your passengers always wear seat belts and wear them properly.

■ Seat Belt Inspection

Regularly check the condition of your seat belts as follows:

- Pull each belt out fully and look for frays, cuts, burns, and wear.
- Check that the latch plates and buckles work smoothly and the belts retract easily. If a belt does not retract easily, cleaning the belt may correct the problem. Use only mild soap and warm water. Do not use bleach or cleaning solvents. Make sure the belt is completely dry before allowing it to retract.

Any belt that is not in good condition or working properly will not provide proper protection and should be replaced as soon as possible.

A belt that has been worn during a crash may not provide the same level of protection in a subsequent crash. Have your seat belts inspected by an authorized Honda Clarity Electric dealer after any collision.

⚠ WARNING

Not checking or maintaining seat belts can result in serious injury or death if the seat belts do not work properly when needed.

Check your seat belts regularly and have any problem corrected as soon as possible.

■ Fastening a Seat Belt

Adjust your seat to the proper position (see page 45) and then follow the below steps:

1. Pull the seat belt out slowly.
2. Insert the latch plate into the buckle, then tug on the belt to make sure the buckle is secure. Make sure that the belt is not twisted or caught on anything.
3. Position the lap part of the belt as low as possible across your hips, then pull up on the shoulder part of the belt so the lap part fits snugly. This lets your strong pelvic bones take the force of a crash and reduces the chance of internal injuries.
4. If necessary, pull up on the belt again to remove any slack, then make sure that the belt rests across the center of your chest and over your shoulder. This spreads the forces of a crash over the strongest bones in your upper body.

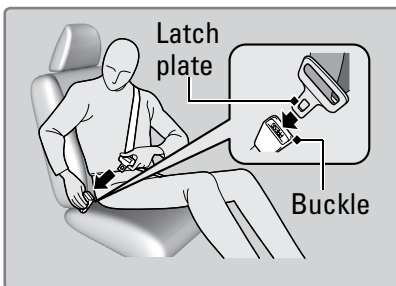

To release the belt, push the red PRESS button then guide the belt by hand until it has retracted completely.

⚠️ WARNING

Improperly positioning the seat belts can cause serious injury or death in a crash.

Make sure all seat belts are properly positioned before driving.

■ Adjusting the Shoulder Anchor

The front seats have adjustable shoulder anchors to accommodate taller and shorter occupants.

1. Move the anchor up and down while holding the release button.
2. Position the anchor so that the belt rests across the center of your chest and over your shoulder.

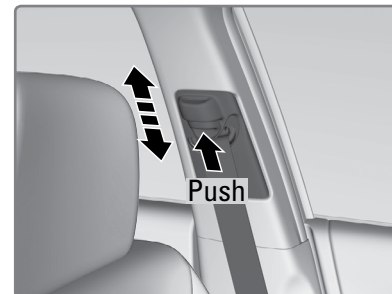

Airbags

Your vehicle is equipped with four types of airbags: front airbags, side airbags, side curtain airbags, and a driver's knee airbag.

■ Front Airbags (SRS)

The front SRS airbags inflate in a moderate-to-severe frontal collision to help protect the head and chest of the driver and/or front passenger. They are housed in the center of the steering wheel for the driver and in the dashboard for the front passenger. Both airbags are marked **SRS AIRBAG**.

SRS (Supplemental Restraint System) indicates that the airbags are designed to supplement seat belts, not replace them. Seat belts are the occupant's primary restraint system.

■ Advanced Airbags

The airbags have advanced features to help reduce the likelihood of airbag-related injuries to smaller occupants.

The driver's advanced airbag system includes a seat position sensor. Based on information from this sensor and the severity of the impact, the advanced airbag system determines the optimal deployment of the driver's airbag.

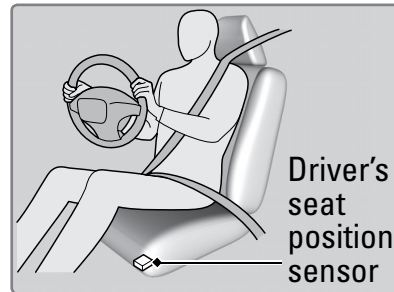

The front passenger's advanced airbag system has weight sensors.

We advise against allowing a child age 12 or under to ride in the front passenger's seat. However, if you do allow a child age 12 or under to ride in the front passenger's seat, note that the system will automatically turn off the front passenger's airbag if the sensors detect that the child is approximately 65 lbs (29 kg) or less.

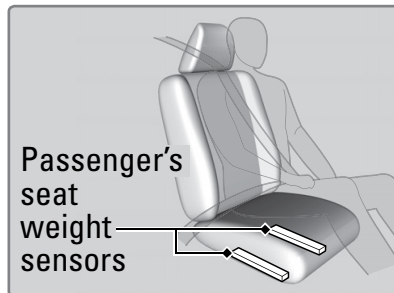

For the advanced airbags to work properly:

- Do not spill any liquid on or under the seats.
- Do not put any object under the passenger's seat.
- Make sure any objects are positioned properly on the floor. Improperly positioned objects can interfere with the advanced airbag sensors.
- All occupants should sit upright and wear their seat belts properly.
- Do not cover the passenger's side dashboard with a cloth, towel, cover, etc.
- Make sure the floor mat behind the front passenger's seat is hooked to the floor mat anchor. An improperly placed mat can interfere with the advanced airbag sensors.

■ Side Airbags

The side airbags help protect the upper torso and pelvis of the driver or a front passenger during a moderate-to-severe side impact. They are housed in the outside edge of the driver's and front passenger's seat-backs. Both are marked **SIDE AIRBAG**.

■ Side Curtain Airbags

Side curtain airbags help protect the heads of the driver and passengers in the outer seating positions during a moderate-to-severe side impact. The side curtain airbags equipped in this vehicle are also designed to help reduce the likelihood of partial and complete ejection of vehicle occupants through side windows in crashes, particularly rollover crashes.

The side curtain airbags are located in the ceiling above the side windows on both sides of the vehicle.

The side curtain airbags are designed to deploy in a rollover or moderate-to-severe side impact. If the SRS control unit senses that your vehicle is about to roll over, it immediately deploys both side curtain airbags and activates both front seat belt tensioners. If the impact is on the passenger's side, the passenger's side curtain airbag deploys even if there are no occupants on that side of the vehicle.

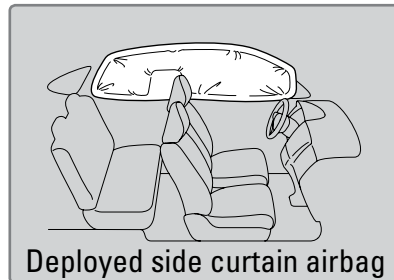
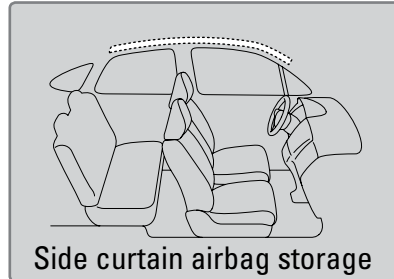

To get the best protection from the side curtain airbags, occupants should wear their seat belts properly and sit upright and well back in their seats.

Do not attach any objects to the side windows or roof pillars, as they can interfere with the proper operation of the side curtain airbags.

When side curtain airbags deploy in a frontal collision

One or both side curtain airbags may inflate in a moderate-to-severe angled frontal collision.

■ Driver's Knee Airbag

The driver's knee SRS airbag inflates with the driver's front airbag in a moderate-to-severe frontal collision to help keep the driver in the proper position and to help maximize the benefit provided by the vehicle's other safety features.

■ Important Facts About Your Airbags

Always wear your seat belt properly, and sit upright and as far back from the steering wheel as possible while allowing full control of the vehicle. A front passenger should move their seat as far back from the dashboard as possible.

Do not place hard or sharp objects between yourself and a front airbag.

Carrying hard or sharp objects on your lap or driving with a pipe or other sharp object in your mouth, can result in injuries if your front airbag inflates.

Do not attach or place objects on the front airbag covers. Objects on the covers marked **SRS AIRBAG** could interfere with the proper operation of the airbags or be propelled inside the vehicle and hurt someone if the airbags inflate.

Do not attach accessories on or near the side airbags. They can interfere with the proper operation of the airbags, or hurt someone if an airbag inflates.

Do not attach any objects to the side windows or roof pillars. They can interfere with the proper operation of the side curtain airbags.

Do not cover or replace the front seat-back covers. This can prevent your side airbags from properly deploying during a side impact.

⚠ WARNING

An open glove box can cause serious injury to your passenger in a crash, even if the passenger is wearing the seat belt.

Always keep the glove box closed while driving.

■ Airbag System Indicators

If a problem occurs in the airbag system, the SRS indicator comes on and a message appears on the driver information interface.

SRS (Supplemental Restraint System) indicator

If the indicator comes on at any other time besides vehicle start-up or does not come on at all, have the system checked by an authorized Honda Clarity Electric dealer as soon as possible. If you don't, your airbags and seat belt tensioners may not work properly when they are needed.



WARNING

Ignoring the SRS indicator can result in serious injury or death if the airbag systems or tensioners do not work properly.

Have your vehicle checked by a dealer as soon as possible if the SRS indicator alerts you to a possible problem.

Passenger airbag off indicator

The indicator comes on to alert you that the front passenger's front airbag has been turned off. This occurs when the front passenger's weight sensors detect about 65 lbs (29 kg) or less, the weight of an infant or small child, on the seat.

Infants and small children should always ride properly restrained in a back seat.

If the front passenger's seat is empty, the passenger's front airbag will not deploy and the indicator will come on.

To ensure the passenger is detected properly, check that:

- There is no child seat or other object pressing against the rear of the seat-back.
- There is no rear passenger pushing or pulling on the back of the front passenger's seat.
- The front seat or seat-back is not forced back against an object on the seat or floor behind it.
- There is no object placed under or beside the front passenger's seat.
- The occupant is sitting in an upright position and the seat back is not excessively reclined.
- The occupant is not leaning against the door or center console.
- The occupant's feet are placed on the floor in front of them.
- There are no objects hanging from the front passenger's seat.
- Only small, lightweight objects are in the seat-back pocket.

The passenger airbag off indicator may come on and go off repeatedly if the total weight on the seat is near the airbag cutoff threshold.

Have your vehicle checked by an authorized Honda Clarity Electric dealer as soon as possible if:

- All of the above conditions exist and the indicator comes on with an adult riding there.
- The seat is empty and the indicator is off.

Do not allow an adult passenger to ride in the front seat when the indicator is on.

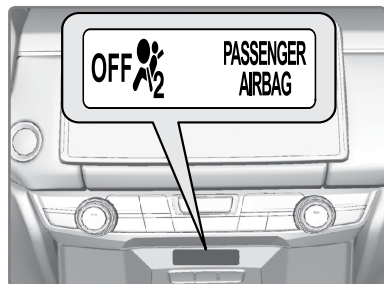
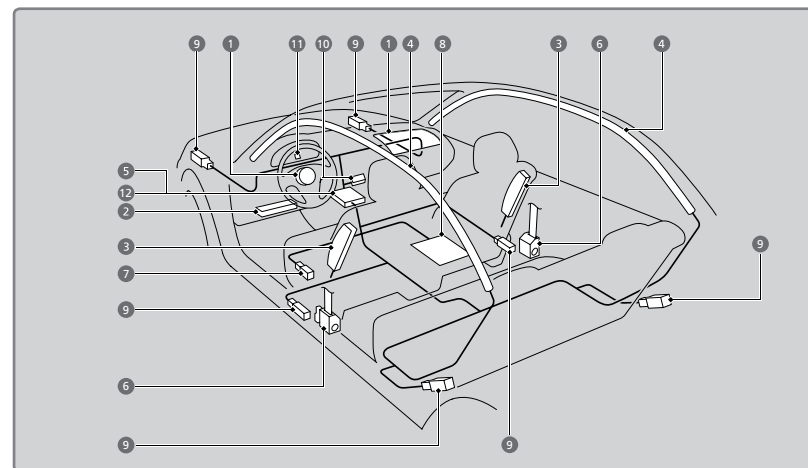
**Airbag System Components**

1. Two SRS (Supplemental Restraint System) front airbags. The driver's airbag is stored in the center of the steering wheel; the front passenger's airbag is stored in the dashboard. Both are marked **SRS AIRBAG**.
2. Driver's knee airbag. The knee airbag is stored under the steering column. It is marked **SRS AIRBAG**.
3. Two side airbags, one for the driver and one for a front passenger. The airbags are stored in the outer edges of the seatbacks. Both are marked **SIDE AIRBAG**.
4. Two side curtain airbags, one for each side of the vehicle. The airbags are stored in the ceiling, above the side windows. The front and rear pillars are marked **SIDE CURTAIN AIRBAG**.
5. An electronic control unit that, when the vehicle is on, continually monitors information about the various impact sensors, seat and buckle sensors, rollover sensor, airbag activators, seat belt tensioners, passenger airbag OFF indicator, and other vehicle information. During a crash event, the unit can record such information.
6. Automatic front seat belt tensioners. In addition, the driver's and front passenger's seat belt buckles incorporate sensors that detect whether or not the belts are fastened.
7. This sensor determines the optimal force at which the airbag will deploy in a crash.
8. Weight sensors in the front passenger's seat. The front passenger's airbag will be turned off if the weight on the seat is approximately 65 lbs (29 kg) or less (the weight of an infant or small child).

9. Impact sensors that can detect a moderate-to-severe front or side impact.
10. An indicator on the dashboard that alerts you that the front passenger's front airbag has been turned off.
11. An indicator on the instrument panel that alerts you to a possible problem with your airbag system or seat belt tensioners.
12. A rollover sensor that can detect if your vehicle is about to roll over and signal the control unit to deploy both side curtain airbags.

■ Airbag Care

You do not need to, and should not, perform any maintenance on or replace any airbag system components yourself. However, you should have your vehicle inspected by a Clarity Electric in the following situations:

When the airbags have deployed

If an airbag has inflated, the control unit and other related parts must be replaced. Similarly, once an automatic seat belt tensioner has been activated, it must be replaced.

When the vehicle has been in a moderate-to-severe collision

Even if the airbags did not inflate, have your authorized Honda Clarity Electric dealer inspect the following: the driver's seat position sensor, weight sensors in the passenger's seat, front seat belt tensioners, and each seat belt that was worn during the crash.

Do not remove or modify a front seat without first consulting a dealer

This would likely disable the driver's seat position sensor or the weight sensors in the passenger's seat. If it is necessary to remove or modify a front seat to accommodate a person with disabilities, contact a Honda Clarity Electric dealer or call Honda Automobile Customer Service at (800) 999-1009.

Child Safety

Each year, many children are injured or killed in vehicle crashes because they are either unrestrained or not properly restrained. In fact, vehicle collisions are the number-one cause of death of children ages 12 and under.

The National Highway Traffic Safety Administration recommends that all children ages 12 and under be properly restrained in a rear seat. Some states have laws restricting where children may ride.

To reduce the number of child deaths and injuries, every state requires that infants and children be properly restrained when they ride in a vehicle.

■ Protecting Child Passengers

- An inflating front or side airbag can injure or kill a child sitting in the front seat.
- A child in the front seat is more likely to interfere with the driver's ability to safely control the vehicle.
- Statistics show that children of all sizes and ages are safer when they are properly restrained in a rear seat.
- Any child who is too small to wear a seat belt correctly must be restrained in an approved child seat that is properly secured to the vehicle using either the lap belt portion of the lap/shoulder belt or the lower anchors of the LATCH system.
- Never put a seat belt over yourself and a child. During a crash, the belt would likely press deep into the child and cause serious or fatal injuries.
- Never let two children use the same seat belt. Both children could be very seriously injured in a crash.
- Do not allow children to operate the doors, windows, or seat adjusters.
- Do not leave children in the vehicle unattended, especially in hot weather when the inside of the vehicle can get hot enough to kill them. They could also activate vehicle controls, causing it to move unexpectedly.

WARNING

Children who are unrestrained or improperly restrained can be seriously injured or killed in a crash.

Any child too small for a seat belt should be properly restrained in a child seat. A larger child should be properly restrained with a seat belt, using a booster seat if necessary.

⚠️ WARNING

Allowing a child to play with a seat belt or wrap one around their neck can result in serious injury or death.

Instruct children not to play with any seat belt and make sure any unused seat belt a child can reach is buckled, fully retracted, and locked.

■ Protecting Infants

An infant must be properly restrained in a rear-facing, reclining child seat until the infant reaches the seat manufacturer's weight or height limit for the seat, and the infant is at least one year old. Many experts recommend use of a rear-facing seat for a child up to two years old if the child's height and weight are appropriate for a rear-facing seat.

Child seats must be placed and secured in a rear seating position. Rear-facing child seats should never be installed in a forward-facing position.

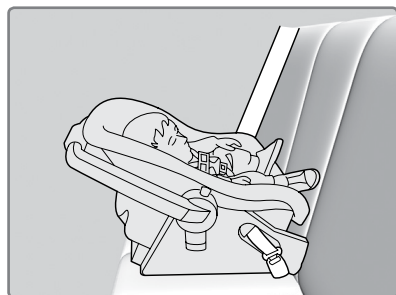

When properly installed, a rear-facing child seat may prevent the driver or a front passenger from moving their seat all the way back, or from locking their seat-back in the desired position. Make sure that there is no contact between the child seat and the seat in front of it. It can also interfere with proper operation of the front passenger's advanced front airbag system. If this occurs, we recommend that you install the child seat directly behind the front passenger's seat, move the seat as far forward as needed, and leave it unoccupied. Or, you may wish to get a smaller rear-facing child seat.

⚠️ WARNING

Placing a rear-facing child seat in the front seat can result in serious injury or death during a crash.

Always place a rear-facing child seat in the rear seat, not the front.

■ Protecting Smaller Children

If a child is at least one year old and within the weight range indicated by the child seat manufacturer, the child should be properly restrained in a firmly secured forward-facing child seat.

We strongly recommend placing a forward-facing child seat in a rear seating position.

Placing a forward-facing child seat in the front seat can be hazardous, even with advanced front airbags that automatically turn the passenger's front airbag off. A rear seat is the safest place for a child.

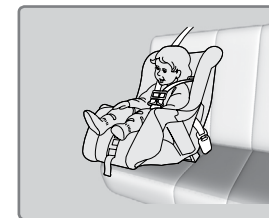
**⚠️ WARNING**

Placing a forward-facing child seat in the front seat can result in serious injury or death if the front airbag inflates.

If you must place a forward-facing child seat in front, move the vehicle seat as far back as possible, and properly restrain the child.

■ Selecting a Child Seat

Most child seats are LATCH-compatible (Lower Anchors and Tethers for CHildren). Some have a rigid-type connector, while others have a flexible-type connector. Both are equally easy to use. Some existing and previously owned child seats can only be installed using the seat belt. Whichever type you choose, follow the child seat manufacturer's use and care instructions as well as the instructions in this manual. Proper installation is key to maximizing your child's safety.

In seating positions and vehicles not equipped with LATCH, a LATCH-compatible child seat can be installed using the seat belt and a top tether for added security. This is because all child seats are required to be designed so that they can be secured with a lap belt or the lap part of a lap/shoulder belt. In addition, the child seat manufacturer may advise that a seat belt be used to attach a LATCH-compatible seat once a child reaches a specified weight. Please read the child seat owner's manual for proper installation instructions.

Important considerations when selecting a child seat

Make sure the child seat meets the following three requirements:

- The child seat is the correct type and size for the child.
- The child seat is the correct type for the seating position.
- The child seat is compliant with Federal Motor Vehicle Safety Standard 213.

⚠ WARNING

Children who are unrestrained or improperly restrained can be seriously injured or killed in a crash.

Any child too small for a seat belt should be properly restrained in a child seat. A larger child should be properly restrained with a seat belt, using a booster seat if necessary.

■ Installing a LATCH-Compatible Child Seat

A LATCH-compatible child seat can be installed in either of the two outer rear seats. A child seat is attached to the lower anchors with either the rigid or flexible type of connectors.

1. Locate the lower anchors under the marks.
2. Place the child seat on the vehicle seat, then attach the child seat to the lower anchors according to the instructions that came with the child seat. Make sure that the lower anchors are not obstructed by the seat belt or any other object.

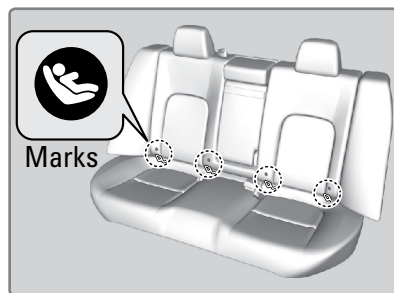

3. Open the tether anchor cover behind the head restraint.
4. **For straight top tethers:** Route the tether over the top of the head restraint.

For other top tethers: Route the tether around the head restraint.

For all types: Secure the tether hook to the anchor.

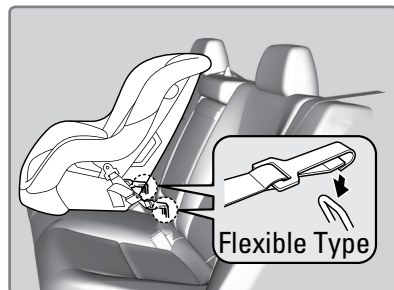
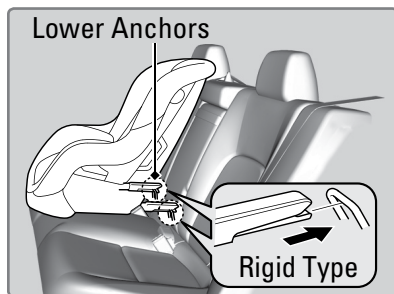

5. Tighten the tether strap according to the seat manufacturer's instructions.
6. Make sure the child seat is firmly secured by rocking it forward and back and side to side; little movement should be felt.
7. Make sure any unused seat belt that a child can reach is buckled, the lockable retractor is activated, and the belt is fully retracted and locked.

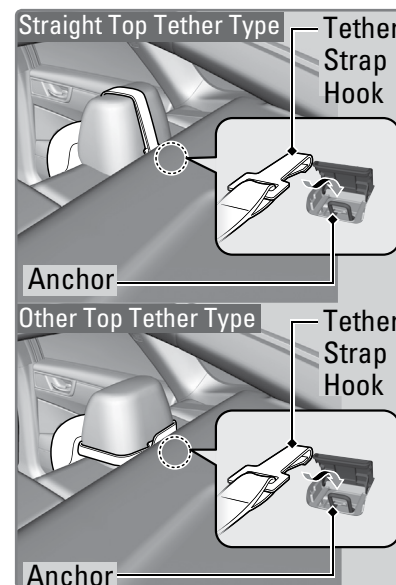

■ Installing a Child Seat with a Lap/Shoulder Seat Belt

A child seat can be installed with a lap/shoulder belt in any rear seat or, if absolutely necessary, the front passenger seat.

1. Place the child seat on the vehicle seat.
2. Route the seat belt through the child seat according to the seat manufacturer's instructions, and insert the latch plate into the buckle. Insert the latch plate fully until it clicks.
3. Slowly pull the shoulder part of the belt all the way out until it stops. This activates the lockable retractor.
4. Let the seat belt retract a few inches and check that the retractor has switched modes by pulling on the webbing. It should not pull out again until it is reset by removing the latch plate from the buckle. If you are able to pull the shoulder belt out, the lockable retractor is not activated. Slowly pull the seat belt all the way out, and repeat steps 3 – 4.

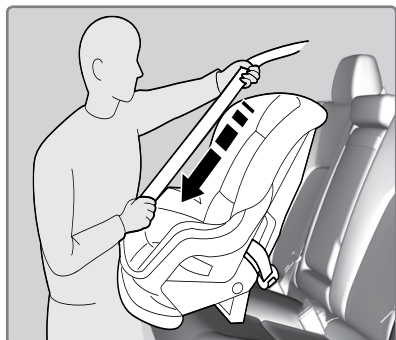
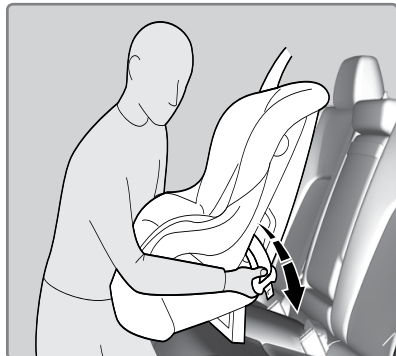

5. Grab the shoulder part of the seat belt near the buckle, and pull up to remove any slack from the lap part of the belt. When doing this, place your weight on the child seat and push it into the vehicle seat.
6. Make sure the child seat is firmly secured by rocking it forward and back and side to side; less than one inch of movement should occur near the seat belt.
7. Make sure any unused seat belt that a child can reach is buckled, the lockable retractor is activated, and the belt is fully retracted and locked.

To deactivate a lockable retractor, release the buckle and allow the seat belt to wind up all the way.

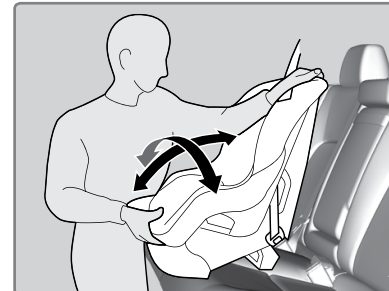
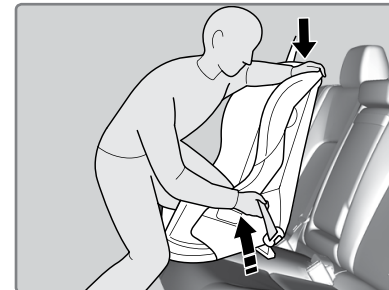

■ Adding Security with a Tether

A tether anchorage point is provided behind each rear seating position. A child seat that is installed with a seat belt and comes with a tether can use the tether for additional security.

1. Locate the appropriate tether anchorage point and lift the cover.

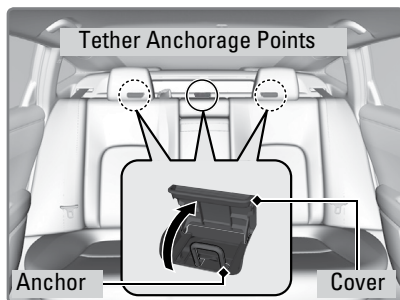

2. **Straight top tether:** Route the tether strap over the head restraint. Make sure the strap is not twisted.

Other top tether: Route the tether strap around the head restraint. Make sure the strap is not twisted.

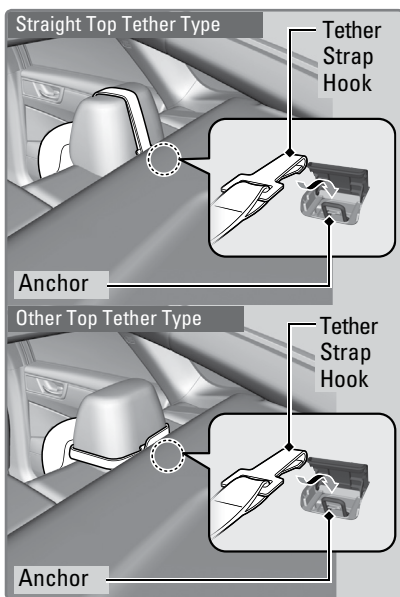

3. Secure the tether strap hook onto the anchor.
4. Tighten the tether strap according to the child seat manufacturer's instructions.

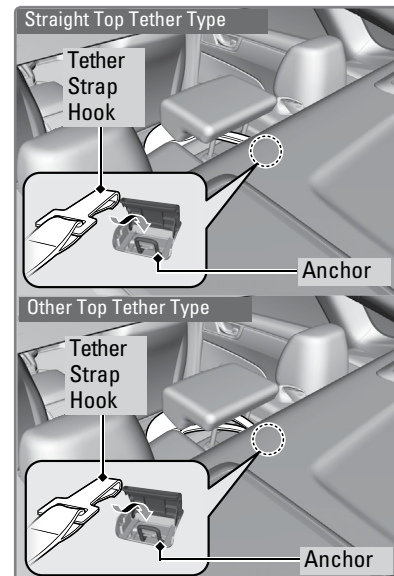

■ Using an Outer Anchor

1. Locate the appropriate tether anchorage point and lift the cover.
2. Raise the head restraint to its highest position, then route the tether strap through the head restraint legs. Make sure the strap is not twisted.
3. Secure the tether strap hook to the anchor.
4. Tighten the tether strap according to the seat manufacturer's instructions.

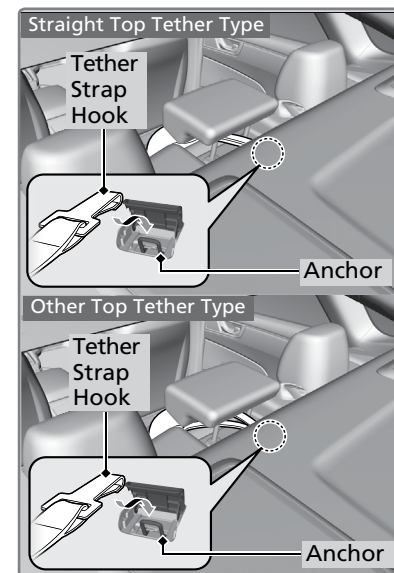

■ Protecting Larger Children

When a child is too big for a child seat, secure the child in a rear seat using the lap/shoulder seat belt.

Have the child sit upright and all the way back, then ensure the following:

- The child's knees bend comfortably over the edge of the seat.
- The shoulder belt crosses between the child's neck and arm.
- The lap part of the seat belt is as low as possible, touching the child's thighs.
- The child can stay seated for the whole trip.



If a lap/shoulder belt cannot be used properly, position the child in a booster seat in a rear seating position. For the child's safety, check that the child meets the booster seat manufacturer's recommendations.

Some U.S. states require children to use a booster seat until they reach a given age or weight (e.g., 6 years or 60 lbs). Be sure to check current laws in the state where you intend to drive.

⚠️ WARNING

Allowing a child age 12 or under to sit in the front can result in injury or death if the passenger's front airbag inflates.

If a larger child must ride in front, move the vehicle seat as far to the rear as possible, then have the child sit up properly and wear the seat belt properly, using a booster seat if needed.

Safety Label Locations

Safety labels are in the locations shown. They warn you of potential hazards that can cause serious injury or death. Read these labels carefully.

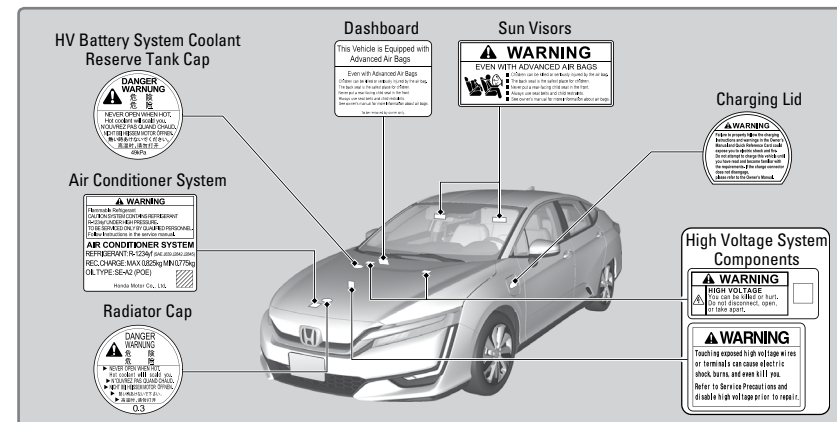

Reporting Safety Defects

If you believe that your vehicle has a defect which could cause a crash or could cause injury or death, you should immediately inform the National Highway Traffic Safety Administration (NHTSA) in addition to notifying American Honda Motor Co., Inc.

If NHTSA receives similar complaints, it may open an investigation, and if it finds that a safety defect exists in a group of vehicles, it may order a recall and remedy campaign. However, NHTSA cannot become involved in individual problems between you, your dealer, or American Honda Motor Co., Inc.

To contact NHTSA, you may call the Vehicle Safety Hotline toll-free at 1-888-327-4236 (TTY: 1-800-424-9153); go to <http://www.safercar.gov>; or write to: Administrator, NHTSA, 1200 New Jersey Avenue, SE., Washington, DC 20590. You can also obtain other information about motor vehicle safety from <http://www.safercar.gov>.

INSTRUMENT PANEL

Learn about the indicators, gauges, and displays related to driving the vehicle.



Indicators briefly appear with each power system start and then go out. Red and amber indicators are most critical. Blue and green indicators are used for general information.

Malfunction Indicators

These are the most critical indicators. If they come on and stay lit while driving or at any other time, there may be a problem. See your authorized Honda Clarity Electric dealer if necessary.

BRAKE Brake System

- Brake fluid is low.
- There is a malfunction in the brake system.

Press the brake pedal lightly to check pedal pressure. If normal, check the brake fluid level when you stop. If abnormal, take immediate action. Have your vehicle repaired immediately.

12-Volt Battery Charging System

The 12-volt battery is not charging. Turn off all electrical items, but do not turn off the vehicle to prevent further battery discharge. Have your vehicle repaired immediately.

Supplemental Restraint System (SRS)

There is a problem with one of the airbag systems or seat belt tensioners.



Anti-lock Brake System (ABS)

There is a problem with the anti-lock brake system. Your vehicle still has normal braking ability, but no anti-lock function.



Tire Pressure Monitoring System (TPMS)

(Blinks and stays on) There is a problem with the tire pressure monitoring system or a tire has low pressure.



Collision Mitigation Braking System (CMBS)

There is a problem with the system, the temperature is too high, or the camera is blocked.



Vehicle Stability Assist® (VSA®)

There is a problem with the VSA system.



Brake System

There is a problem with the brake system, not related to the conventional brake system.



Electric Power Steering (EPS)

There is a problem with the EPS system.



Adaptive Cruise Control (ACC) with Low Speed Follow (LSF)

There is a problem with the system, the temperature is too high, or the radar sensor is blocked.



Lane Keeping Assist System (LKAS)

There is a problem with the system.



Road Departure Mitigation (RDM)

There is a problem with the system.



Transmission Malfunction Indicator

The indicated current gear selection or all the gear positions blink if there is a problem with the transmission system.



Immobilizer

Your key or remote transmitter cannot be recognized by the vehicle. If the indicator blinks, you may not be able to start the power system. Turn the vehicle off, and then on again. If it continues to blink, there may be a problem with the system. See your authorized Honda Clarity Electric dealer.







Keyless Access System

There is a problem with the keyless access system.









Condition Indicators

These indicators may require you to perform an action.

- BRAKE** **Parking brake**
The brake fluid is low, the parking brake is applied, or there is a problem with the brake system.
-  **Seat belt reminder**
Make sure seat belts are fastened for you and all passengers. The indicator blinks and beeps sound continuously if you and/or your front passenger have not fastened your seat belts when you begin driving. If the indicator remains on after seat belts are fastened, see your authorized Honda Clarity Electric dealer.
-  **Low charge**
Recharge as soon as possible. Acceleration capability reduced to conserve power.
-  **Low tire pressure**
Stop in a safe place, check tire pressures, and inflate tire(s) if necessary. Have your tire repaired or replaced as soon as possible.
-  **System message**
When a condition or malfunction indicator comes on, a message also appears on the driver information interface. Check the display for more information.
- READY**
The vehicle is ready to drive.
- POWER SYSTEM** **Power System**
There is a problem with the power system or plug-in charging system. Have your vehicle checked by an authorized Honda Clarity Electric dealer immediately.

On/Off Indicators

These indicators remind you when an item is on or off.

- | | | | |
|---|-------------------------|---|-----------------------------|
|  | VSA off |  | ECON mode on |
|  | VSA engaged (blinks) | LKAS | LKAS on |
|  | CMBS off | ACC | ACC on |
|  | Turn signals/hazards on |  | Brake hold system on |
|  | High beams on |  | Brake hold system activated |
|  | Exterior lights on | | |
| SPORT | SPORT mode on | | |

Driver Information Interface (DII)

Consists of several displays that provide you with useful information.

Press the Display/Information button see the current display.

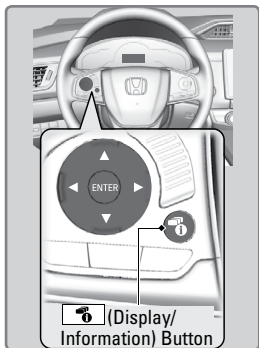

Main Displays

Press ◀ or ▶ button to cycle through the displays shown below. Press ENTER to see detailed information.

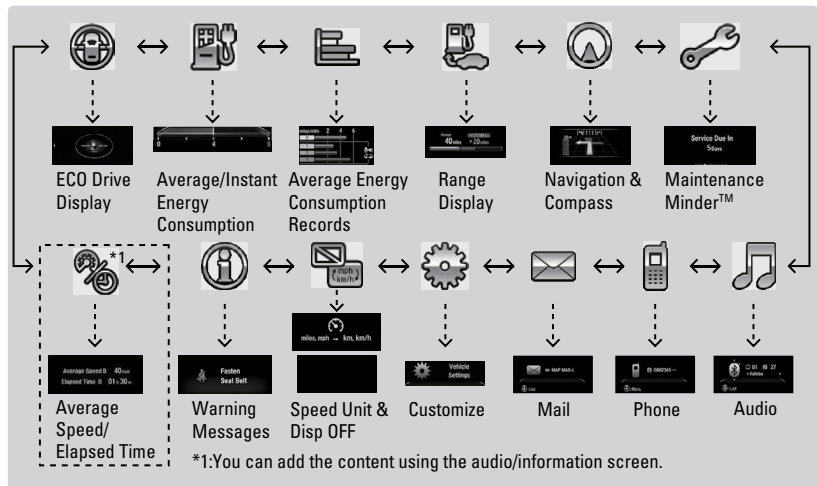

Lower Displays

Press the TRIP button to cycle through the displays shown below:

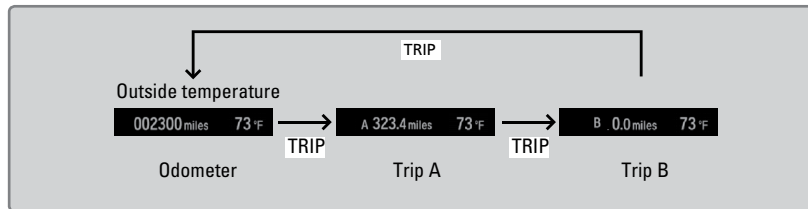

Energy Usage Meter

Shows the amount of energy being consumed by the drive system and the climate system.

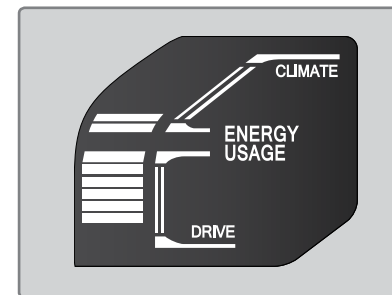

VEHICLE CONTROLS

Learn about the various controls necessary for operating and driving the vehicle.

Using the Remote Transmitter

Lock or unlock the doors, charge lid, and trunk.

Unlock button: Press once to unlock the driver's door. Press again to unlock all doors.

Trunk button: Press and hold to unlock and open the trunk.

Panic button: Press to sound the alarm for 30 seconds. Press any button to cancel.

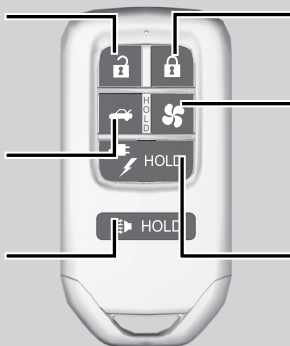

Lock button: Press to lock the doors. Press again for audible verification.

CLIMATE button: Press and hold to remotely start the climate control system (see page 93).

Charge lid button: Press and hold to unlock the charge lid.

Built-in key: Slide the release knob on the back of the transmitter to pull out the built-in key.

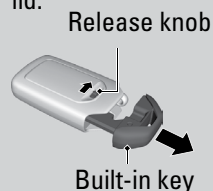

NOTICE

Leaving the keyless access remote in the vehicle can result in theft or accidental movement of the vehicle. Always take it with you whenever you leave the vehicle unattended.

Smart Entry System

When you carry the remote transmitter (for example, in a pocket or purse) and it is outside the vehicle and within range (about 32 inches or 80 cm), you can lock or unlock the doors and trunk without handling the transmitter.

■ Unlocking/Locking the Doors

To unlock: Grab the driver's door handle when the vehicle is off to unlock the driver's door. Grab the front passenger's door handle to unlock all doors.

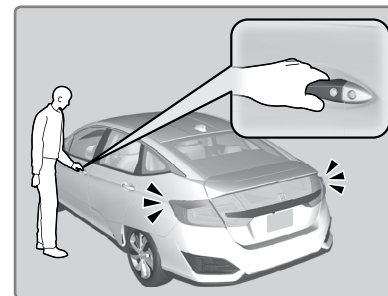

To lock: Press the door lock button on the front door handle when the vehicle is off. If the remote transmitter is inside the vehicle, the doors will not lock.

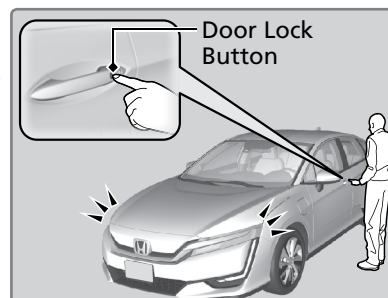

■ Unlocking the Trunk

Press the trunk release button to unlock and open the trunk.

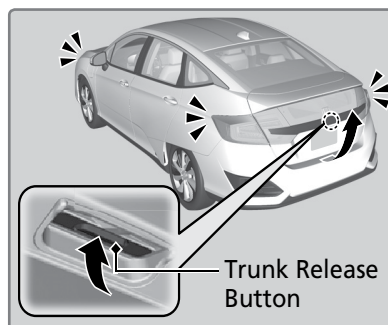

TABLE OF CONTENTS
VISUAL INDEX
SAFETY INFORMATION
INSTRUMENT PANEL
VEHICLE CONTROLS
AUDIO AND CONNECTIVITY
BLUETOOTH® HANDSFREELINK®
HONDALINK®

NAVIGATION
DRIVING
HANDLING THE UNEXPECTED
MAINTENANCE
SPECIFICATIONS
CUSTOMER INFORMATION
VOICE COMMAND INDEX
INDEX

■ Walk Away Auto Lock

When you walk away from the vehicle while carrying the remote transmitter, the doors can automatically lock if the following conditions are met:

- The remote transmitter is within a range of 5 feet (1.5 m).
- All doors are closed.
- There is not an additional remote transmitter inside the vehicle.

Follow these steps (see diagram):

1. Carry the remote transmitter while you exit the vehicle. Close all the doors and stay near the vehicle. Listen for a beep. The system is activated.
2. Walk at least 5 feet (1.5 m) away.
3. Listen for a beep and look for the lights to flash. The doors lock.

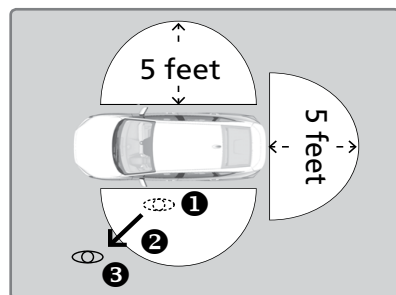

To turn on this feature, follow these steps with vehicle stopped and the power mode set to ON:

1. From the HOME screen, select Settings.
2. Select Vehicle.
3. Select Door/Window Setup.
4. Select Walk Away Auto Lock.
5. Select On.

Door Operation

Use several methods to lock or unlock the doors.

■ Using the Lock Tab

To unlock: Pull the lock tab rearward. When you unlock the door using the lock tab on the driver's door, only the driver's door unlocks.

To lock: Push the lock tab forward. When you lock the door using the lock tab on the driver's door, all the other doors lock at the same time.

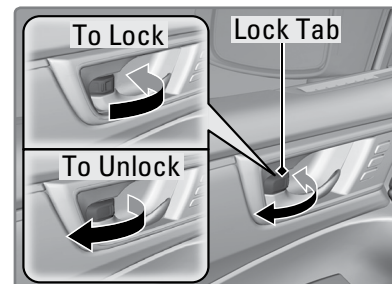

■ Using the Front Door Inner Handle

When you pull either front door inner handle, the door unlocks and opens. Pulling the driver's door inner handle unlocks all other doors.

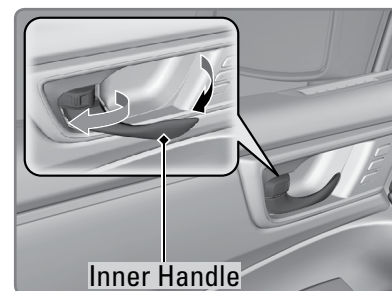

■ Using the Master Door Lock Switch

To unlock: Press the unlock side of the switch to unlock all doors.

To lock: Press the lock side of the switch to lock all doors.

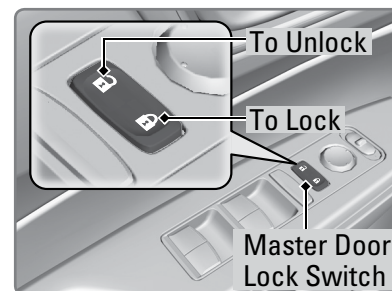

■ Childproof Door Locks

The childproof door locks prevent the rear doors from being opened from the inside regardless of the position of the lock tab.

Slide the lever in the rear door to the lock position and close the door.

Open the door using the outer door handle.

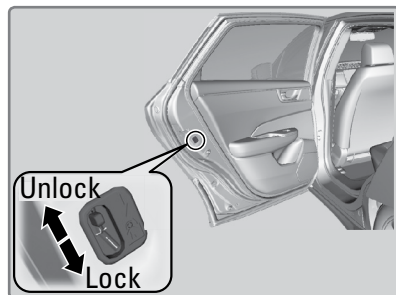

■ Using the Trunk Opener

Press the trunk opener on the driver's door to unlock and open the trunk.

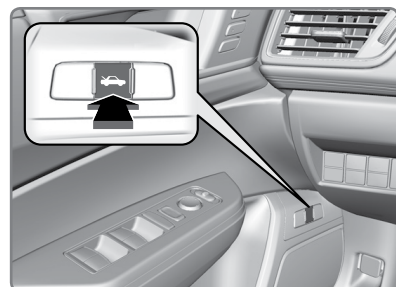

Power Window Operation

The power windows can be opened and closed when the power mode is on by using the switches on the doors. The switches on the driver's side can be used to open and close all the windows.

■ Automatic Operation

To open: Push the switch down firmly.

To close: Pull the switch up firmly.

The window opens or closes completely. To stop the window at any time, push or pull the switch again briefly.

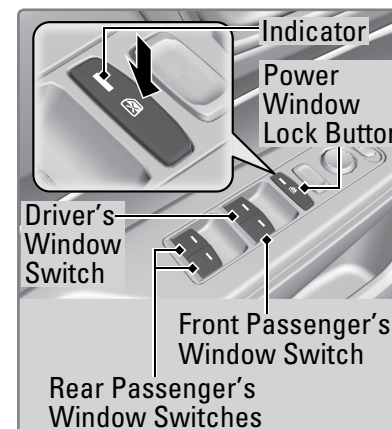

■ Manual Operation

To open: Push the switch down lightly.

To close: Pull the switch up lightly.

Release the switch when the window reaches the desired position.

■ Power Window Lock

Push in the power window lock button so only the driver's window can be operated.

⚠ WARNING

Closing a power window on someone's hands or fingers can cause serious injury.

Make sure your passengers are away from the windows before closing them.

Interior and Exterior Lights

Operate interior and exterior lights when the power mode is on or off.

Brightness Control

Adjust instrument panel brightness when the power mode is on.

To brighten: Press the (+) button.

To dim: Press the (-) button.

A beep sounds when the brightness reaches its minimum or maximum.

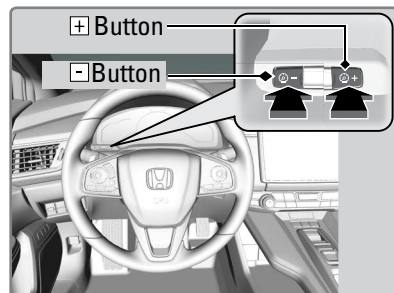

Interior Lights

Change the interior light settings using the switch on the ceiling.

ON position: Interior lights remain on.

Door-activated position: Interior lights come on when any of the doors are opened, the driver's door is unlocked, or the power mode is turned off.

OFF position: Interior lights remain off.

Map lights: Press the map lights to turn on or off.

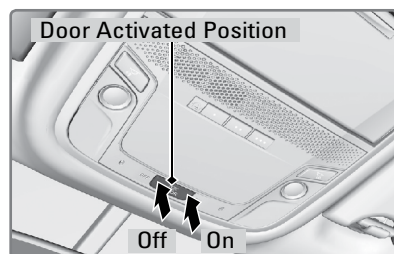

Exterior Lights

Rotate the switch on the headlight lever to operate the exterior lights.

OFF: All exterior lights are off.

☞☞: Turn on exterior lights except headlights.

AUTO: Turn on the automatic lighting feature. Headlights turn on or off depending on ambient brightness when the power mode is on. Headlights automatically come on after the wipers are engaged for a certain time.

☰☉: Turn on all exterior lights including headlights.

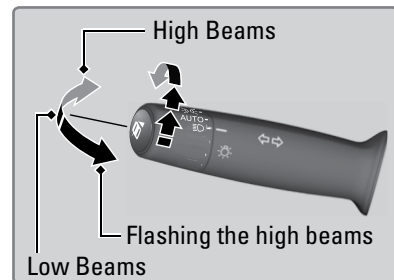

Wiper Operation

The windshield wipers and washers can be used when the power mode is on.

Move the wiper lever up or down to the desired position.

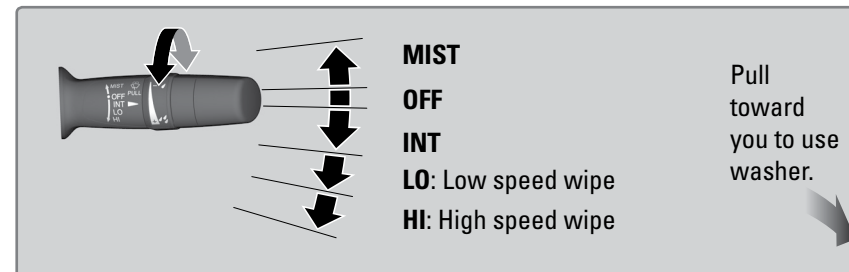

Headlight-Wiper Integration

When the headlights are in the AUTO position, they automatically turn on when the front wipers operate several times within a certain interval. The headlights turn off shortly after the wipers are turned off or if there is enough ambient light.

NOTICE

Always ensure the wiper lever is in the OFF position before entering a car wash to prevent severe damage to the windshield wiper system.

NOTICE

Do not use the wipers when the windshield is dry. The windshield will get scratched, or the rubber blades will get damaged.

In cold weather, the blades may freeze to the windshield, becoming stuck. Operating the wipers in this condition may damage the wipers. Use the defroster to warm the windshield or manually clear the windshield of ice and snow before turning on the wipers.

One-Touch Turn Signal

Use this quick and convenient method to signal a lane change.

Lightly push and release the turn signal lever up or down for a three-blink sequence.

For a continuous signal, push the lever up or down until it locks into place.

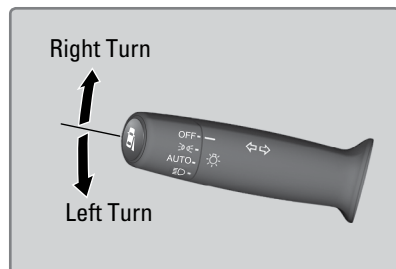
**Adjusting the Seats**

Make seat adjustments before driving to ensure the best comfort and safety.

- **Adjusting the Front Seats**

Adjust the driver's seat as far back as possible while allowing you to maintain full control of the vehicle. You should be able to sit upright and well back in the seat, adequately press the pedals without leaning forward, and grip the steering wheel comfortably. The passenger's seat should be adjusted so that it is as far back from the front airbag in the dashboard as possible.

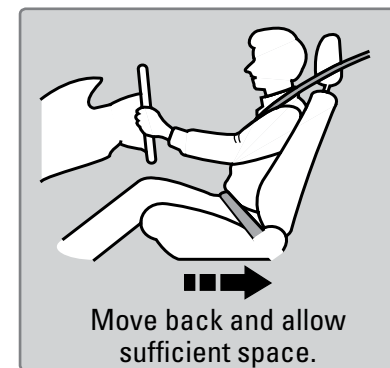

The National Highway Traffic Safety Administration recommends that drivers allow at least 10 inches (25 cm) between the center of the steering wheel and the chest.

■ **Driver's Seat**

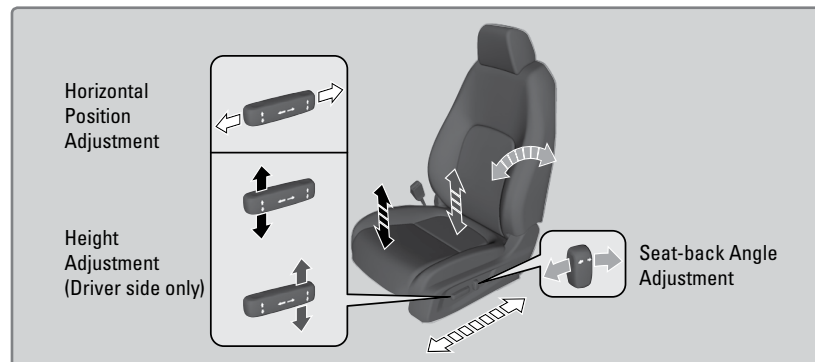

⚠ WARNING

Reclining the seat-back too far can result in serious injury or death in a crash. Adjust the seat-back to an upright position and sit well back in the seat.

⚠ WARNING

Sitting too close to a front airbag can result in serious injury or death if the front airbags inflate. Always sit as far back from the front airbags as possible while maintaining control of the vehicle.

■ **Floor Mats**

Position the front seat floor mats properly and anchor them. If they are not properly positioned, the floor mats can interfere with the front seat functions.

Do not put additional floor mats on top of the anchored mats.

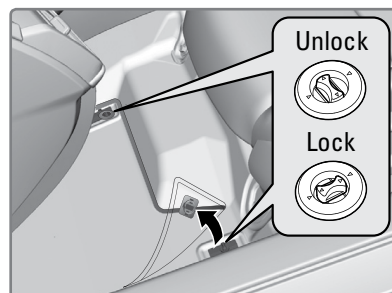

■ **Adjusting the Head Restraints**

Your vehicle is equipped with head restraints in all seating positions. Head restraints are most effective for protection against whiplash and other rear-impact crash injuries.

The center of the back of the occupant's head should rest against the center of the restraint. The tops of the occupant's ears should be level with the center height of the restraint.

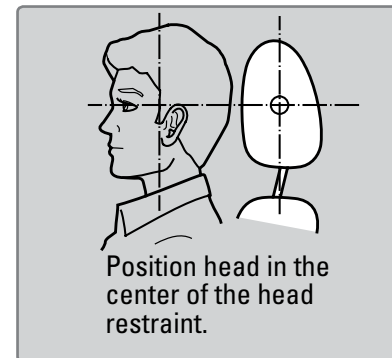

To raise the head restraint: Pull it upward.

To lower the head restraint: Push it down while pressing the release button.

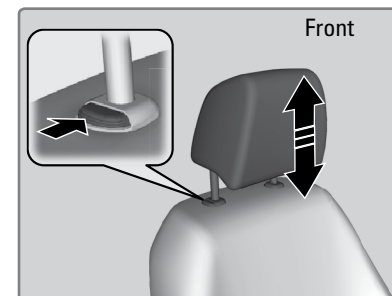

To remove the head restraint: Pull the restraint up as far as it will go. Then push the release button and pull the restraint up and out.

To reinstall a head restraint: Insert the legs back in place, then adjust the head restraint to an appropriate height while pressing the release button. Pull up on the restraint to make sure it is locked in position.

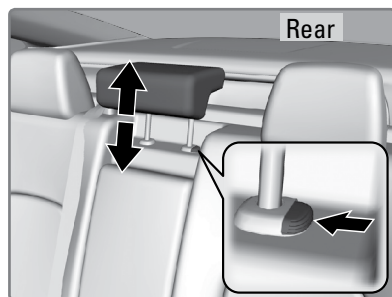

For the head restraint system to work properly:

- Do not hang any items on the head restraints or from the restraint legs.
- Do not place any object between an occupant and the seat-back.
- Install each restraint in its proper location.

⚠ WARNING

Improperly positioning head restraints reduces their effectiveness and increases the likelihood of serious injury in a crash.

Make sure head restraints are in place and positioned properly before driving.

⚠ WARNING

Failure to reinstall or correctly reinstall the head restraints can result in severe injury during a crash.

Always replace the head restraints before driving.

Rear Seats

Separately raise or lower the left and right 60/40 rear seat backs to make room for luggage.

■ Fold the Rear Seat Backs

1. Remove the center shoulder belt from the guide.

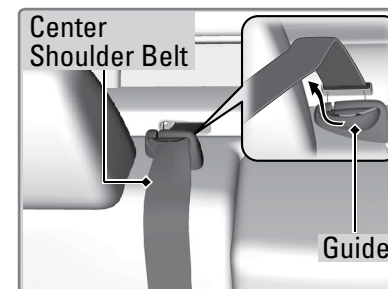

2. Pull the release lever in the trunk to release the lock.

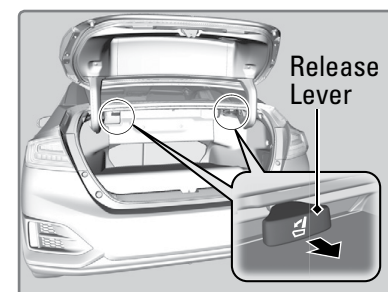

3. Fold the seat-back down.

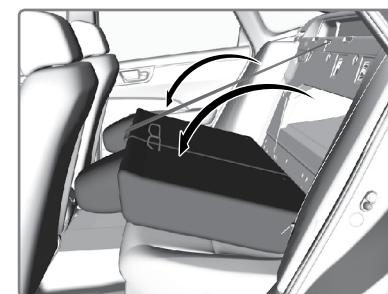

Adjusting the Steering Wheel

The steering wheel height and distance from your body can be adjusted so that you can comfortably grip the steering wheel in an appropriate driving posture.

1. Push the steering wheel adjustment lever down. The steering wheel adjustment lever is under the steering column.
2. Move the steering wheel up or down and in or out.
3. Pull up the steering wheel adjustment lever to lock the steering wheel in position.

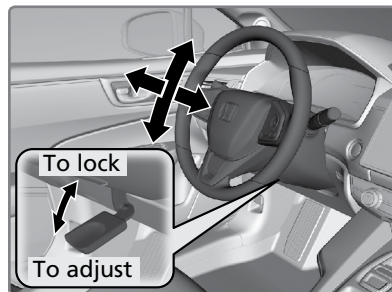

⚠ WARNING

Adjusting the steering wheel position while driving may cause you to lose control of the vehicle and be seriously injured in a crash.

Adjust the steering wheel only when the vehicle is stopped.

Driving Position Memory System

You can store two driver's seat positions with the driving position memory system.

When you unlock and open the driver's door with a remote transmitter, or smart entry system, the seat adjusts automatically to one of the two preset positions.

- DRIVER 1 transmitter is linked to memory button 1.
- DRIVER 2 transmitter is linked to memory button 2.

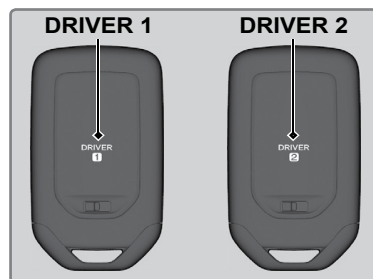

You can use the buttons on the driver's door to store two driver's seat positions into memory when the vehicle is on.

1. Adjust the seat to your preferred position.
2. Press SET.
3. Press and hold memory button 1 or 2. The indicator will illuminate for the button pressed once the seat position has been memorized.
4. Press one of the memory buttons to recall previously stored positions.

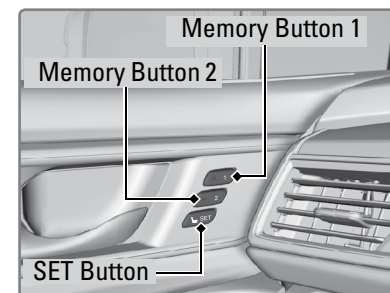

When you unlock and open the driver's door with a remote transmitter, the seat adjusts automatically to one of the two preset positions, depending on which keyless remote is present.

Adjusting the Mirrors

Adjust the angle of the mirrors for the best visibility when you are sitting in the correct driving position.

■ Automatic Dimming Rearview Mirror

When driving after dark, the automatic dimming function reduces the glare from headlights behind you.

The function cancels when the transmission is in Reverse (R).

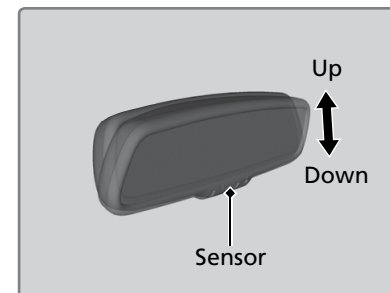

■ Power Door Mirrors

Adjust the power door mirrors when the power mode is on.

L/R selector switch: Select the left or right mirror. After adjusting the mirror, return the switch to the center position.

Mirror position adjustment switch: Press the switch left, right, up, or down to move the mirror.

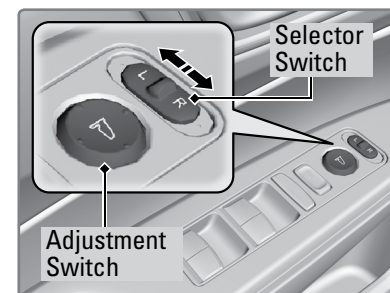

HomeLink® Universal Transceiver

Program your vehicle to operate up to three remote-controlled devices around your home—such as garage doors, lighting, or home security systems—using the buttons on the ceiling.

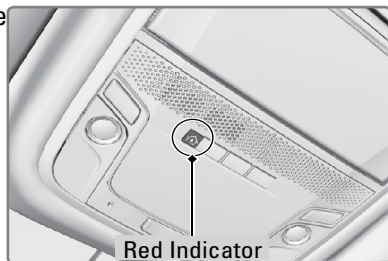

■ Training a Button

Park near the system you want to program and follow the instructions in the flowchart below:

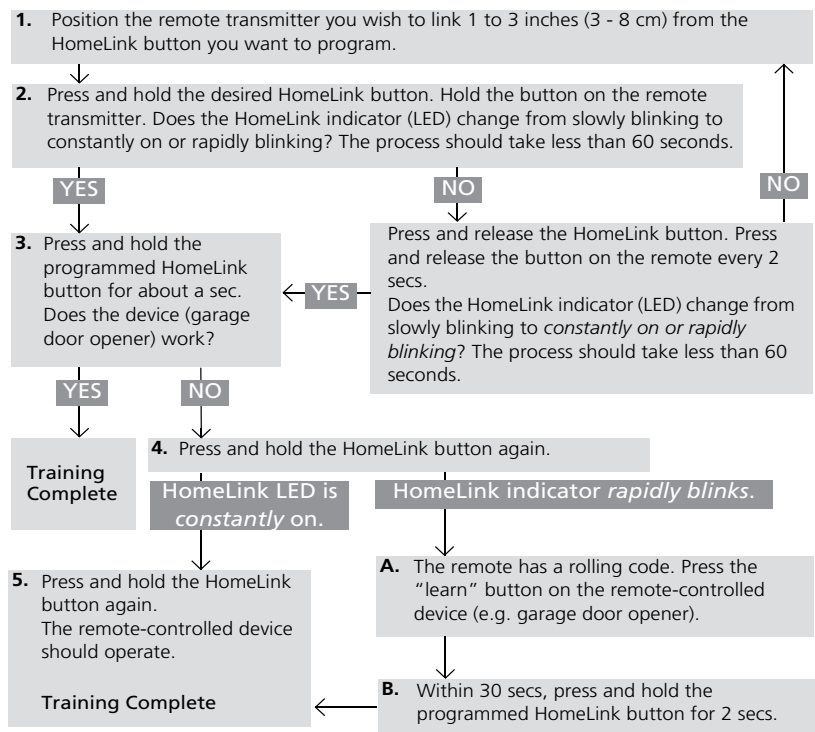

To retrain a button or erase codes, see the Owner's Manual at ev.owners.honda.com.

If you need help, visit www.homelink.com or call (800) 355-3515.

Climate Control System

Maintains your preferred interior temperature by selecting the proper mix of heated or cooled air and fan speed. Use the buttons on the dashboard to control the system.

Selected temperature display

A/C: Turn air conditioning on or off.

MODE: Select airflow location.

CLIMATE button: Select climate options on the touchscreen.

Driver's temperature control dial

Fan control buttons

Passenger's temperature control dial

AUTO button: Press, then use the temperature control dial to set your preferred temperature.

ON/OFF button

Defroster buttons

SYNC button: Set the passenger's side temperature to the same as the driver's side.

Recirculation buttons:

- Recirculation mode (indicator on):* Recirculates air from the vehicle's interior.
- Auto mode (indicator on):* Automatically switch between the recirculation and fresh air modes most suitable to environmental conditions.
- Fresh air mode (both indicators off):* Maintains outside ventilation. Keep the system in fresh air mode in normal situations.

Seat Heaters

Quickly warm the seats when the power mode is on.

Press the seat heater switch to cycle through the heat settings. An indicator appears for the selected setting.

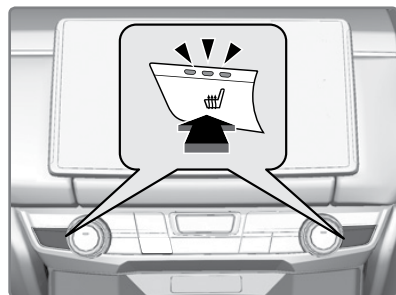

⚠ WARNING

Heat-induced burns are possible when using seat heaters.

Persons with a diminished ability to sense temperature (e.g., persons with diabetes, lower-limb nerve damage, or paralysis) or with sensitive skin should not use the seat heaters.

Customized Features

Use the Settings menu to customize certain features when the vehicle is stopped.

Select items on the touchscreen to make selections.

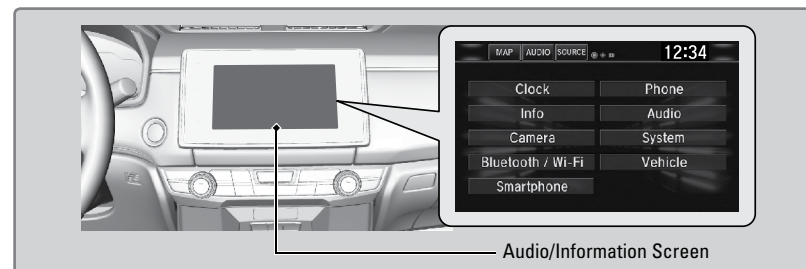

1. From the HOME screen, select Settings.
2. Select an option and make your preferred changes.
3. Press BACK or Home to exit the menus.

■ Customization Example: Door Lock/Unlock Settings

To customize the door lock/unlock settings, follow the steps below when the vehicle is stopped and the power mode is ON. Use the audio/information screen.

1. Press HOME.
2. Press Settings.
3. Press Vehicle.
4. Press Door/Window Setup.
 - To customize door lock settings, press Auto Door Lock
 - To customize door unlock settings, press Auto Door Unlock
5. Choose a setting.
 - The default lock setting is Shift from Park
 - The default unlock setting is All Doors when Driver's Door Opens
 - Press the BACK or HOME button when you are done

AUDIO AND CONNECTIVITY

Learn how to operate the vehicle's audio system.

Basic Audio Operation

Connect audio devices and operate buttons and displays for the audio system.

■ USB Port

1. Open either USB cover in the front console.
2. Connect a USB flash drive or iPod/iPhone cable connector to the USB port.

The USB port (1.5A) is for charging devices, playing audio files and connecting for Apple CarPlay or Android Auto.

The USB port (1.0A) is for playing audio files, connecting a phone, and charging devices.

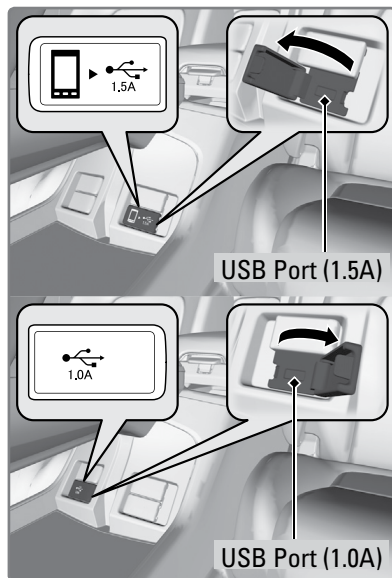

iPod and iPhone are trademarks of Apple, Inc.

■ Accessory Power Socket

Open the socket cover in the front console to use power when the power mode is on.

There is an additional power socket on the rear of the center console.

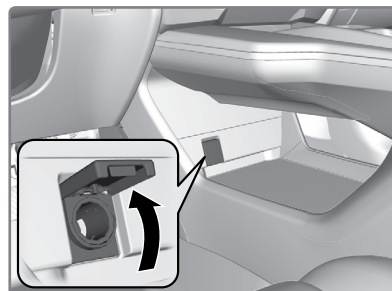

NOTICE

Do not insert an automotive type cigarette lighter element. This can overheat the power socket.

■ Audio Remote Controls

You can operate certain functions of the audio system using the steering wheel controls.

ENTER button: Press until the audio screen is displayed in the Driver Information Interface.

+ / - bar: Press the ends of the bar to adjust audio volume.

ENTER button: Make audio selections in the Driver Information Interface.

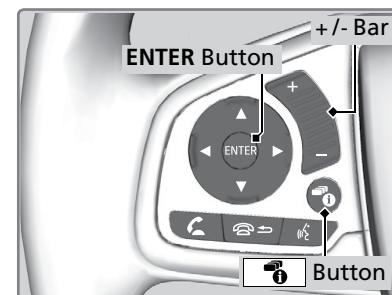

◀ / ▶ buttons: Change presets, tracks, albums, or folders.

From the audio screen in the Driver Information Interface:

FM/AM/SiriusXM® Radio

Press **◀** or **▶** for the next or previous preset station.

Press and hold **◀** or **▶** to seek the next or previous strong station.

iPod/USB/Bluetooth® Audio

Press **◀** or **▶** for the next or previous track.

Press and hold **◀** or **▶** for the next or previous folder (USB).

Pandora®

Press **▶** for the next song.

Press and hold **◀** or **▶** for the previous or next station.

▲ / ▼ buttons: Cycle through available audio modes or scroll through audio options in the Driver Information Interface

From the audio screen in the Driver Information Interface:

FM/AM/SiriusXM® Radio

Press the ENTER button to display a preset list. Press ▲ or ▼ to scroll through the list and press the ENTER button to select a preset.

USB Flash Drive

Press the ENTER button to display the folder list. Press ▲ or ▼ to scroll through the list and press the ENTER button to select a folder. Repeat to select a track.

iPod

Press the ENTER button to display the iPod list. Press ▲ or ▼ to scroll through the category and press the ENTER button to select an item. Repeat to select a track.

Bluetooth® Audio

Press the ENTER button to display the track list. Press ▲ or ▼ to scroll through the list and press the ENTER button to select a track.

Pandora®

Press the ENTER button to display the station list. Press ▲ or ▼ to scroll through the list and press the ENTER button to select a station.

■ Adjusting the Sound

Adjust various sound settings.

Using the touchscreen

1. Touch items on the screen to make and enter selections.
2. From the HOME screen, select Audio.
3. Select Menu.
4. Select Sound.
5. Select the tabs to change the sound mode and adjust the setting.
6. Select OK when complete.

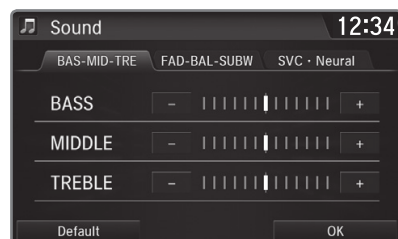

Touchscreen Operation

Use simple gestures—including touching, swiping, and scrolling—to operate certain audio functions.

Some items may be grayed out during driving to reduce the potential for distraction. You can select them when the vehicle is stopped or use voice commands.

Wearing gloves may limit or prevent touchscreen response.

You can use a microfiber cleaning cloth to remove dust or fingerprints from the touchscreen.

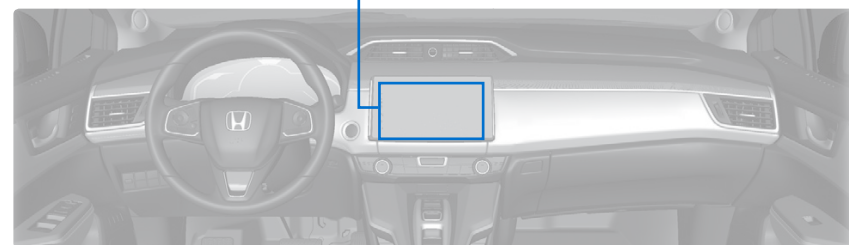
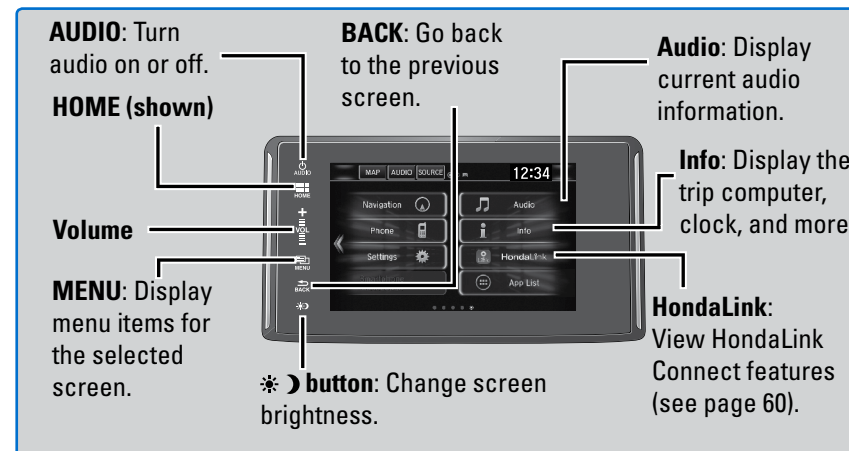

■ Setting Touchscreen Sensitivity

You can adjust the touchscreen's sensitivity to your fingertip.

1. From the HOME screen, select Settings, then System.
2. Select Display, then Touch Panel Sensitivity.
3. Make your selection.

HondaLink®

Provides you with useful information about your vehicle directly from Honda.

Visit automobiles.honda.com/handsfreelink or call (888) 528-7876 to check phone compatibility. Standard data rates may apply with your phone service provider.

To get more information on HondaLink, visit www.hondalink.com.

■ HondaLink Connection

Follow the steps below to connect to HondaLink and use its features.

1. Download the HondaLink Connect app to your compatible smartphone.
2. Pair your phone to *Bluetooth HandsFreeLink* (see page 74).
3. From the HOME screen, select HondaLink.
4. Certain features require you to send vehicle information to Honda. Select *Enable Once*, *Always Enable*, or *Cancel*.

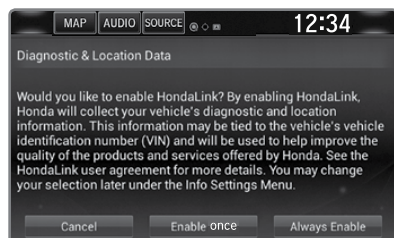

■ HondaLink Menu

Select a menu option.

Places: Display restaurants, gas stations, and other locations. You can send a location to the navigation system and set a route.

Vehicle: Get instructional messages when your vehicle needs service.

Help & Support: Display tips for vehicle usage, get roadside assistance, or contact customer service.

Messages from Honda: Display helpful and important information from Honda.

If you have a new message, a yellow envelope icon appears at the top of the screen and a beep sounds. You can swipe down to view the message from any screen.

Weather: Display a weekly five-day weather forecast for any location.

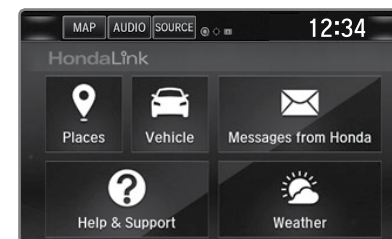

Wi-Fi Connection

You can connect the audio system to the internet using Wi-Fi and use online services through the touchscreen. If your compatible phone has hotspot capabilities, the system can be tethered to the phone. Follow the steps below to set up Wi-Fi when the vehicle is stopped. Standard data rates apply with your phone service provider.

1. From the HOME screen, select Settings.
2. Select Bluetooth/Wi-Fi. Select the Wi-Fi tab.
3. Select Wi-Fi On/Off Status and select On.
4. Select Wi-Fi Device List. Make sure your phone's Wi-Fi setting is in access point (tethering) mode.
5. Select the phone you want to connect to the system. If the phone you want to connect does not appear, select Scan.
6. Select Connect.
7. Enter a password for your phone, if necessary. Select OK. The Wi-Fi symbol is displayed on the list when the connection is successful.

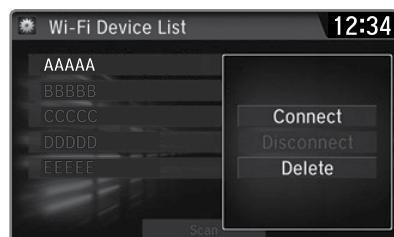
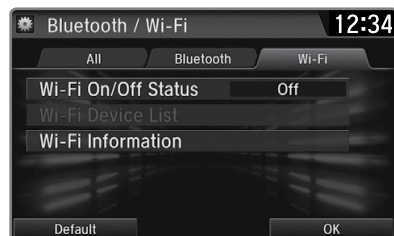

Apple CarPlay™

Connect an Apple CarPlay-compatible iPhone to the system. You can use the touchscreen to make a phone call, listen to music, and more. Visit the Apple CarPlay website for more information.

Park in a safe place before connecting your iPhone and launching any compatible apps.

1. Connect the iPhone to the 1.5A USB port (see page 56).
2. Apple CarPlay requires you to send vehicle information to Honda. Select Enable Once, Always Enable, or Cancel. Your phone may prompt you to allow access for CarPlay to be launched.
3. From the HOME screen, select Apple CarPlay.
4. Select a menu option.

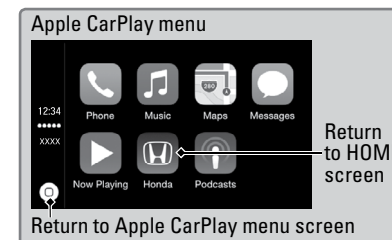
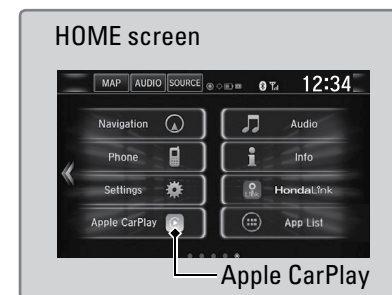

Phone: Access your contacts, make phone calls, or listen to voicemail. While connected to Apple CarPlay, calls can only be made through Apple CarPlay, not through *Bluetooth®* HandsFreeLink®.

Music: Play music stored on your iPhone.

Maps: View a map and operate navigation. You can only use Apple Maps or the pre-installed navigation system to set a destination with routing guidance.

Messages: View and reply to text messages or have messages read to you aloud by the system.

Once connected, press and hold the Talk button on the steering wheel (see page 57) to operate the system using voice commands with Siri Eyes Free.

Depending on use, Apple CarPlay can share certain vehicle information (e.g., vehicle location, speed, and other operating conditions) with the connected iPhone. See Apple's privacy policy for details regarding Apple's use and handling of data uploaded by CarPlay. Use of CarPlay is at user's own risk and is subject to agreement to the CarPlay terms of use, which are included as part of the Apple iOS terms of use. CarPlay vehicle integration is provided "as is," and Honda cannot guarantee CarPlay operability or functionality now or in the future due to, among other conditions, changes in CarPlay software/Apple iOS, service interruptions, or incompatibility or obsolescence of vehicle-integrated hardware or software. See dealer for details. Only use CarPlay when conditions allow you to do so safely. See your Owner's Manual at ev.owners.honda.com for further license and warranty terms.

Android Auto™

Connect a compatible Android phone to the system. You can use the touchscreen to make a phone call, listen to music, and more. Visit the Android Auto website for more information.

Park in a safe place before connecting your Android smartphone and launching any compatible apps.

1. Download the Android Auto app to your phone.
2. Connect the phone to the 1.5A USB port (see page 56). The phone is automatically paired. A tutorial also appears.
3. From the HOME screen, select Android Auto.
4. Android Auto requires you to send vehicle information to Honda. Select Enable Once, Always Enable, or Cancel.
5. Select a menu option.

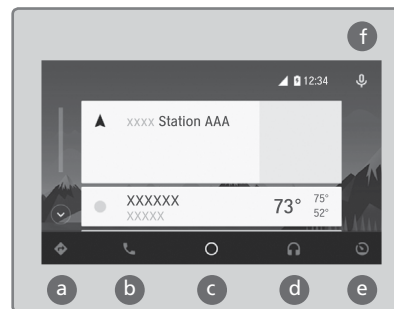
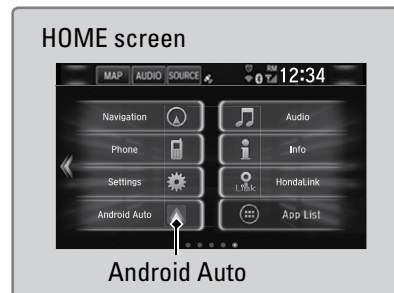

- Maps (Navigation):** View Google Maps and operate navigation. You can only use this system or the pre-installed navigation system to set a destination with routing guidance. You cannot enter destinations using the keyboard while the vehicle is moving.
- Phone (Communication):** Make phone calls or listen to voicemail. While connected to Android Auto, calls can only be made through Android Auto, not through Bluetooth HandsFreeLink.
- Google Now (Home screen):** Display useful information organized by Android Auto into simple cards that appear only when needed.
- Music and Audio:** Play Google Play Music from compatible apps. Select this icon to switch between music apps.
- Go back to the Home screen:** Go back to the vehicle system HOME screen.
- Voice:** Use voice commands via Google Voice Search to operate Android Auto. You can also press and hold the Talk button on the steering wheel (see page 57) to say voice commands.

Depending on use, Android Auto can share certain vehicle information (e.g., vehicle location, speed, and other operating conditions) with Google and its service providers. See Google privacy policy for details regarding Google's use and handling of data uploaded by Android Auto. Use of Android Auto is at user's own risk and is subject to agreement to the Android Auto terms of use, which are presented to the user when the Android Auto application is downloaded to the user's Android phone. Android Auto vehicle integration is provided "as is," and Honda cannot guarantee Android Auto operability or functionality now or in the future due to, among other conditions, changes in Android Auto software/Android operating system, service interruptions, or incompatibility or obsolescence of vehicle-integrated hardware or software. See dealer for details. Only use Android Auto when conditions allow you to do so safely. See your Owner's Manual at ev.owners.honda.com for further license and warranty terms.

FM/AM Radio

Play FM or AM radio stations.

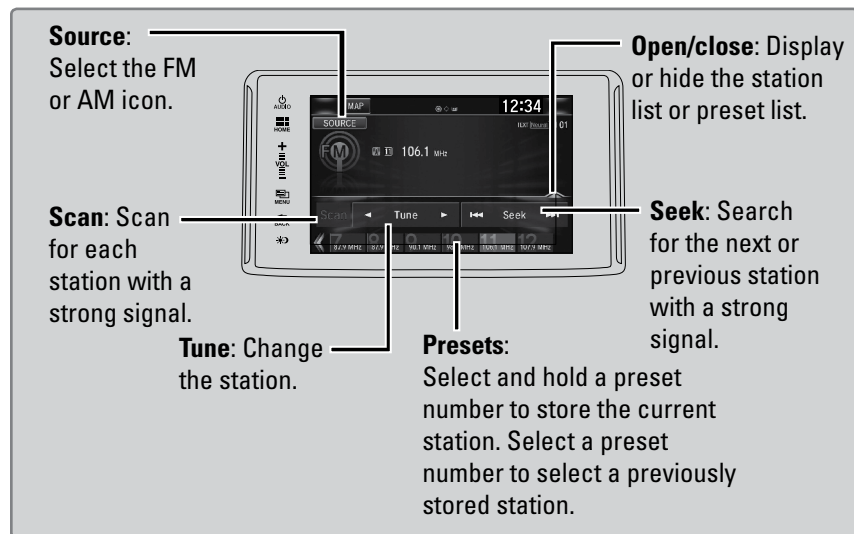

SiriusXM® Radio

Available on a subscription basis only. For more information or to subscribe, contact your dealer or visit www.siriusxm.com/subscribeNOW.

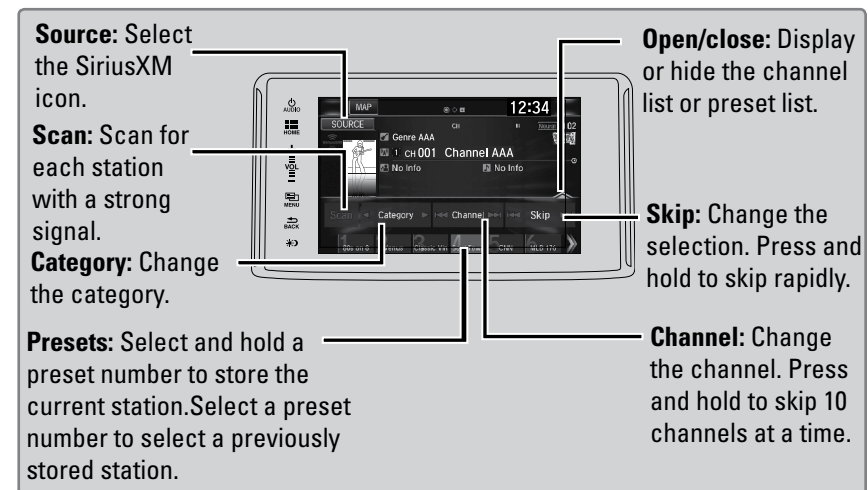

To learn about additional features—such as multi-channel preset, replay, or SportsFlash—see your Owner's Manual at ev.owners.honda.com.

iPod®

Play and operate an iPod through the vehicle's audio system. Connect your device to the USB port (see page 56).

If an iPhone is connected via Apple CarPlay (see page 62), the iPod source is unavailable and audio files on the phone can only be played within Apple CarPlay.

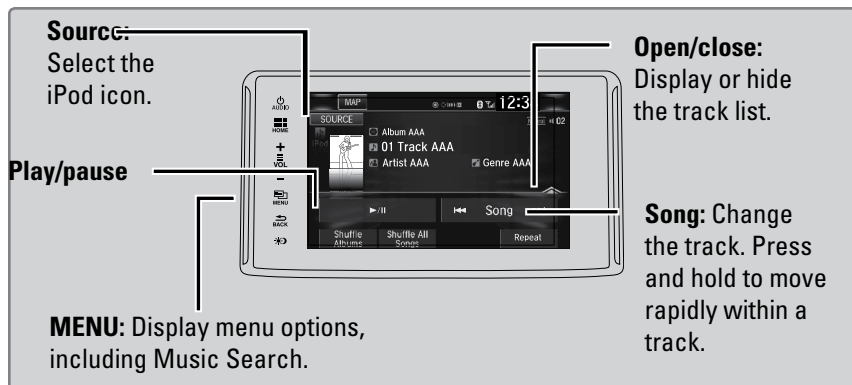

■ Searching for Music

Use the touchscreen to search for tracks stored on the iPod.

1. From the audio screen, press MENU.
2. Select Music Search.
3. Select a search option.
4. Select the track you want to play.
5. You can also search for and play iPod music using Song By Voice (see page 148).

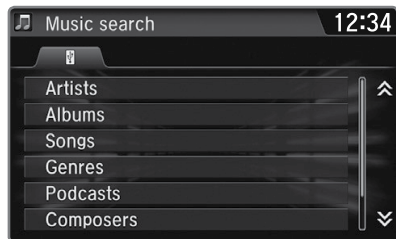

iPod is a trademark of Apple, Inc.

USB Flash Drive

Play and operate a USB flash drive through the vehicle's audio system. Connect your device to the USB port (see page 56).



■ Searching for Music

Use the touchscreen to search for tracks stored on the USB flash drive.

1. From the audio screen, press MENU.
2. Select Music Search.
3. Select Music.
4. Select a folder.
5. Select the track.

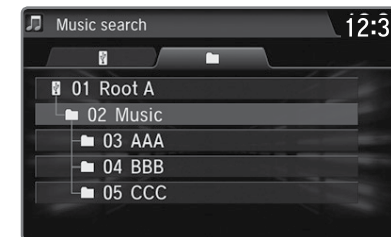

On vehicles with navigation, you can also search for and play music from the flash drive using Song By Voice (see page 148).

Bluetooth® Audio

Play streaming or stored audio from your compatible phone through the vehicle's audio system. Visit automobiles.honda.com/handsfreelink/ or call (888) 528-7876 to check phone compatibility. Standard data rates apply with your phone service provider. Connect your phone to *Bluetooth* HandsFreeLink (see page 74).

If a phone is currently connected via Apple CarPlay (see page 62) or Android Auto (see page 64), *Bluetooth* Audio from that phone is unavailable.

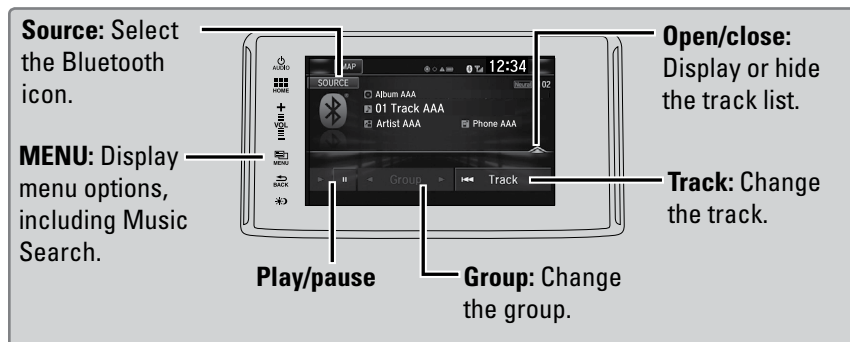

■ Searching for Music

Use the touchscreen to search for tracks stored on the device.

1. From the audio screen, press MENU.
2. Select Music Search.
3. Select a search category.
4. Select the track you want to play.

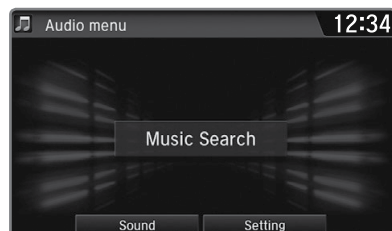

Notes:

- Make sure the volume on your phone is properly adjusted.
- You may need to enable additional settings on your phone for playback.
- Certain audio controls are not supported on all phones.

Applicable laws may prohibit the operation of handheld electronic devices while operating a vehicle. Launch streaming audio on your phone only when it is safe to do so.

Pandora®

Play and operate Pandora from your compatible phone through the vehicle's audio system. Visit automobiles.honda.com/handsfreelink/ or call (888) 528-7876 to check phone compatibility. Standard data rates apply with your phone service provider. **Connect your phone when the vehicle is stopped.**

For iPhone:

- Connect via *Bluetooth* HandsFreeLink (see page 74) or USB port (see page 56).
- A pop-up may appear on your phone requesting you to allow access for Pandora to be launched.
- If you cannot operate Pandora through the audio system, it may be streaming through *Bluetooth* Audio. Make sure Pandora is selected on the audio system.
- If Pandora still does not operate, try rebooting the phone and reconnecting the cable if necessary.

For other compatible smartphones:

- Connect via *Bluetooth* HandsFreeLink (see page 74).
- If your phone is connected to Android Auto (see page 64), Pandora is only available through the Android Auto interface. Visit the Android Auto website to check compatibility.



Applicable laws may prohibit the operation of handheld electronic devices while operating a vehicle. Launch streaming audio on your phone only when it is safe to do so.

BLUETOOTH® HANDSFREELINK® (HFL)

Basic HFL Operation

Make and receive phone calls using the vehicle's audio system, without handling your phone. Visit automobiles.honda.com/handsfreelink/ or call (888) 528-7876 to check phone compatibility.

To reduce the potential for driver distraction, certain manual functions may be inoperable or grayed out while the vehicle is moving. Stop or pull over to perform the function. Voice commands are also available.

■ HFL Controls

Use the controls to enter information and make selections.

Hang-Up/Back button: End or decline a call or cancel an operation.

Pick-Up button: Answer an incoming call.

Talk button: Make a call using a stored voice tag or say voice commands.

Info button: Press until the phone screen is displayed in the Driver Information Interface.

▲ / ▼ buttons: Press to scroll through the contact list in the Driver Information Interface.

ENTER button: From the phone screen in the Driver Information Interface, select from Speed Dial, Call History, or Phonebook.

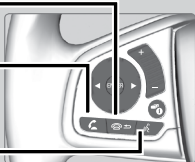

MENU: From the phone screen, select various call options.

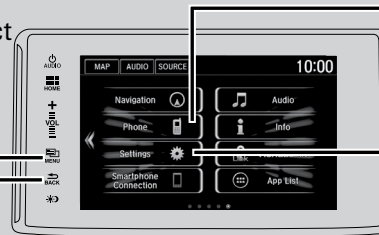

Phone: From the HOME screen, display the phone screen.

Settings: Select Phone from the Settings screen for phone pairing and more.

BACK: Go back to the previous display.

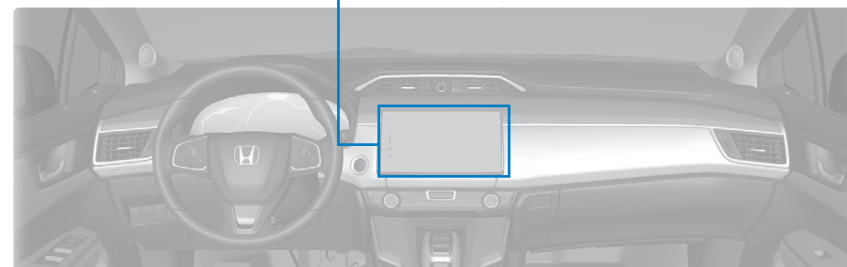

■ Talk Button Tips

- The system recognizes only the commands listed in the Voice Command Index (see page 147)
- When using the Talk button, wait until you hear a beep before speaking.
- To bypass the system prompts, simply press the Talk button again to say your command.
- When the Talk button is pressed, all available voice commands appear on the screen.
- Speak in a clear, natural voice.
- Reduce all background noise.
- Adjust the dashboard vents away from the microphone on the ceiling.
- Close the windows.

TABLE OF CONTENTS

VISUAL INDEX

SAFETY INFORMATION

INSTRUMENT PANEL

VEHICLE CONTROLS

AUDIO AND CONNECTIVITY

BLUETOOTH® HANDSFREELINK®

HONDALINK®

NAVIGATION

DRIVING

HANDLING THE UNEXPECTED

MAINTENANCE

SPECIFICATIONS

CUSTOMER INFORMATION

VOICE COMMAND INDEX

INDEX

Pairing a Phone

To use hands-free phone and streaming audio functions, you must first pair your phone to the system. This can only be done when the vehicle is stopped. Use the touchscreen to make and enter selections.

If there is an active connection to Apple CarPlay (see page 62) or Android Auto (see page 64), pairing of additional *Bluetooth*-compatible devices is unavailable and Add Bluetooth Device is grayed out from the Bluetooth Device List screen.

1. Select Phone
2. Select Yes.
3. Make sure your phone is in search or discoverable mode, then select Continue.
4. Select your phone when it appears on the list.

If your phone does not appear: Select Phone Not Found and search for HandsFreeLink from your phone. Connect to HFL.

5. The system gives you a pairing code on the audio/information screen. Compare it to the code that appears on your phone.

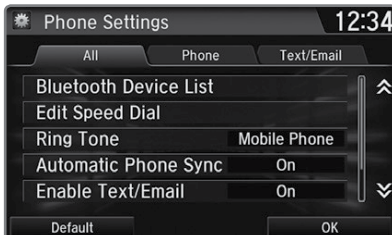
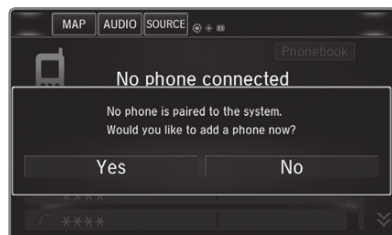

Making a Call

You can make a call using several methods.

■ Dialing a Number

Enter a 10-digit phone number to call.

Using voice commands

1. Press the Talk button before you say each command.
2. Say "Dial by number."
3. Say the phone number: For example, "3-1-0-5-5-1-2-3-4."
4. The system begins to dial.

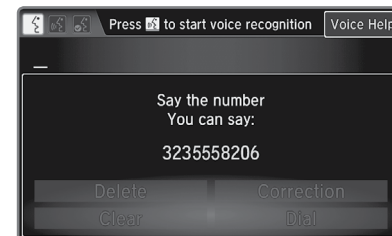

Using the touchscreen

1. Manual operation is limited while the vehicle is moving. Voice commands are always available.
2. From the HOME screen, select Phone.
3. Select MENU.
4. Select Dial.
5. Enter the phone number. Select the green phone icon to call.



■ Using the Phonebook

When your phone is paired, its entire phonebook can be automatically imported to the system. Phone synchronization must be turned on.

Using voice commands

1. Press the Talk button before you say each command.
2. Say "Dial by name."
3. Say the phonebook name and phone type. For example, "John Smith mobile."

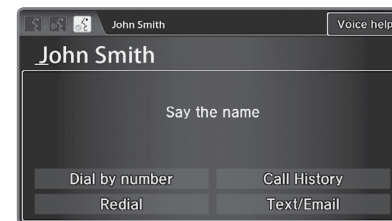

Using the touchscreen

1. Manual operation is limited while the vehicle is moving. Voice commands are always available.
2. From the HOME screen, select Phone.
3. Select MENU.
4. Select Phonebook.
5. Scroll through the list to find the name and number you want to call and select it to call.

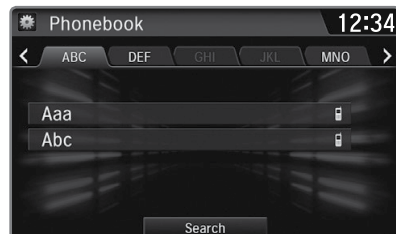

Storing Speed Dial Entries

Store up to 20 numbers for quick dialing.

1. From the HOME screen, select Phone.
2. Select MENU.
3. Select Speed Dial, then select New Entry.
4. Select an entry method.
5. If desired, you can create a voice tag for the number. Follow the prompts.

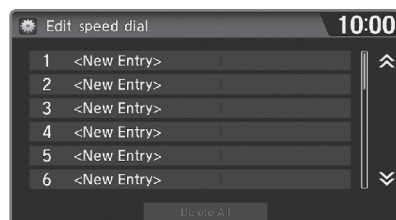

Using Speed Dial

Make calls quickly using stored speed dial entries.

Using voice commands

1. Press the Talk button before you say each command.
2. Say "Dial by name."
3. Say the stored voice tag name. For example, "John Smith."

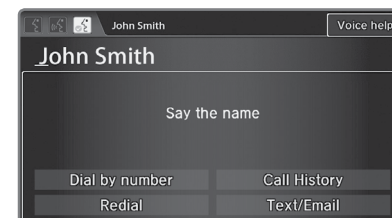

Using the touchscreen

1. From the HOME screen, select Phone.
2. Scroll through the list to find the entry you want to call and select it to call.



HondaLink® Service

If your vehicle's airbags deploy or if the unit detects that the vehicle is severely impacted, your vehicle automatically attempts to connect to an operator. Your phone must be paired to the system and have good cellular connection. Visit www.hondalink.com for more information.

6. Make sure your phone is on and paired to Bluetooth HandsFreeLink (see page 74).
7. Select Call Now, or the system automatically connects after 10 seconds. The vehicle information and its position may be sent to the operator.*
8. Select Talk Now to immediately talk to the operator.
9. When the call is complete, select Hang Up or press the Hang-Up/Back button on the steering wheel.

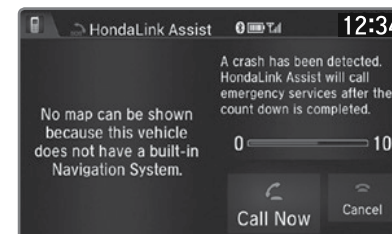

*Depending on your phone and cellular signal capability, your vehicle's location may not be sent to the operator.

SMS Text Messaging and E-Mail

Certain phones can receive and send messages from your paired and connected phone.

Visit automobiles.honda.com/handsfreelink or call (888) 528-7876 to check phone compatibility. Standard message rates apply with your phone service provider. This feature is limited while the vehicle is moving.

Receiving and Responding to Messages

When you receive a new message, a pop-up appears on the touchscreen. You can view the message when the vehicle is stopped. You can also reply to it using fixed phrases or call the sender.

1. When the prompt appears, select Read.
2. The message is displayed, and the system reads it aloud.

To reply: With the message open, select Reply and choose one of the six available responses. Select Send to send the message. You cannot create a new text message.

To call the sender: With the message open, select Dial.

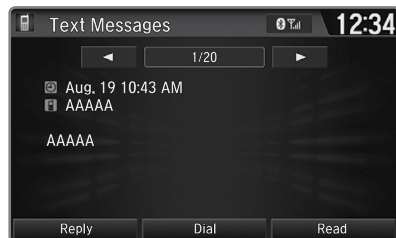

Selecting an Account

If your phone has both text message and e-mail accounts, you can select only one of them at a time to be active and receive notifications.

1. From the HOME screen, select Settings.
2. Select Phone.
3. Select the Text/Email tab then Select Account.
4. Select Text Message or an e-mail account.

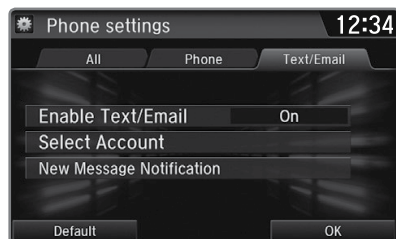

Siri® Eyes Free

Activate Siri through your vehicle when an iPhone is paired to the system. Visit automobiles.honda.com/handsfreelink/ or call (888) 528-7876 to check phone compatibility.

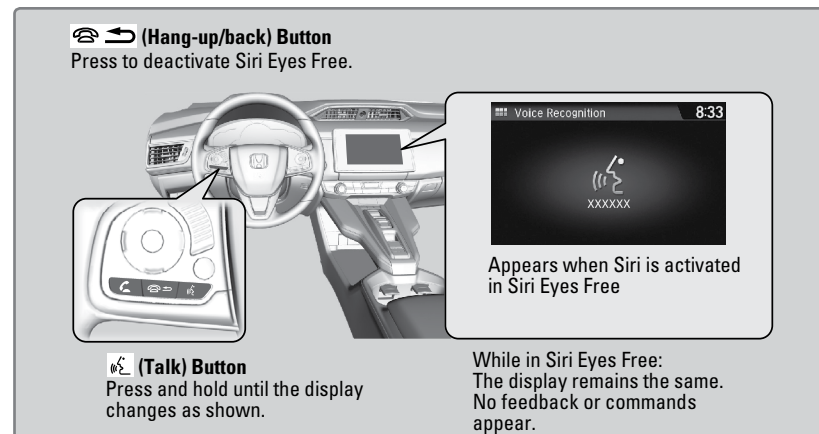

Here are some examples of Siri commands:

- “Call John Smith”
- “Read my new text message”
- “Find a nearby sushi restaurant”
- “Remind me to pick up dinner”
- “Set up a meeting today at 3 p.m.”
- “Play song XYZ”

Notes:

- Any requests that include visual feedback from Siri on your phone are not displayed in the vehicle.
- Certain commands rely on the iPhone’s features and existing apps.
- To hear turn-by-turn directions or songs through the vehicle, set the audio source to Bluetooth Audio.
- If using Siri Eyes Free through Apple CarPlay (see page 62), use the Talk button to activate and deactivate Siri Eyes Free mode.

Siri and iPhone are trademarks of Apple, Inc.

NAVIGATION

Learn how to enter a destination and operate the navigation system.

Basic Navigation Operation

A real-time navigation system uses GPS and a map database to show your current location and help guide you to a desired destination. You can operate the system using voice commands or the system controls.

To reduce the potential for driver distraction, certain manual functions may be inoperable or grayed out while the vehicle is moving. Voice commands are always available.

Steering Wheel Controls

Use the steering wheel controls to say voice commands.

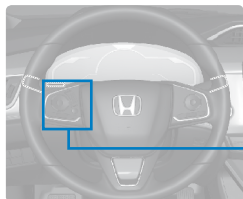

Back button: Press to cancel a command or operation.

Talk button: Press to say navigation commands.

Talk Button Tips

- The system recognizes only the commands listed in the Voice Command Index (see page 147)
- When using the Talk button, wait until you hear a beep before speaking.
- To bypass the system prompts, simply press the Talk button again to say your command.
- When the Talk button is pressed, all available voice commands are highlighted in yellow.
- Speak in a clear, natural voice.
- Reduce all background noise.
- Adjust the dashboard vents away from the microphone on the ceiling.
- Close the windows.

System Guidance Volume

Adjust the navigation system volume.

1. From the HOME screen, select Settings.
2. Select System.
3. Select the Sound/Beep tab.
4. Select Guidance Volume and adjust the level. Select OK when complete.
5. Press BACK to exit the menus.



Navigation Display and Controls

Touch icons on the screen to enter information and make selections.

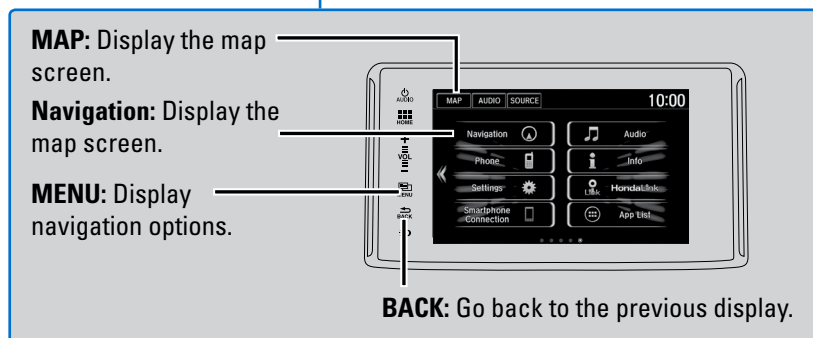
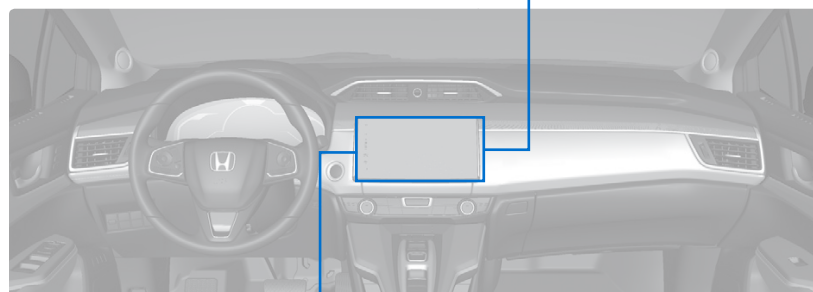
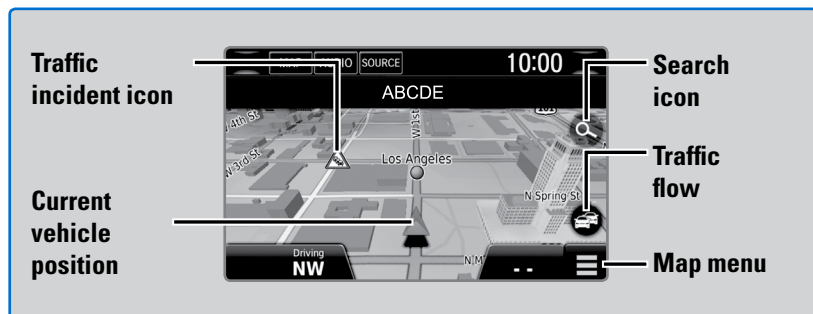

Entering a Destination

Use several methods to enter a destination.

Home Address

Store your home address in the system so you can easily route to it.

1. From the map screen, select the Search icon.
2. Select MENU.
3. Select Set Home Location.
4. Select Enter My Address.
5. Enter the street number and select Done.
6. Enter the street name and select Done. Select the street from the list.
7. Select the address from the list. A map of the address is shown. Select Select.

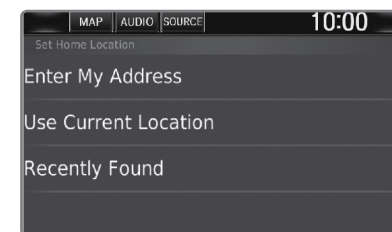

When your home address is stored, you can press the Talk button and say "Navigation" and then "Go home" at any time. You can also select Go Home from the Where To? menu.

■ **Street Address**

Enter a street address.

1. From the map screen, select the Search icon.
2. Select Address.
3. Enter the street number and select Done.
4. Enter the street name and select Done. Select the street from the list.
5. Select the address from the list.
6. Select Go!

You can also enter a street address using voice commands. Press the Talk button and say "Navigation" and then "Find Address." Follow the prompts.

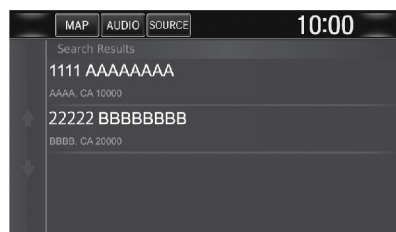
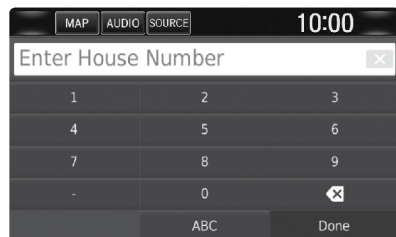

■ **Place Category**

Enter a destination using a point of interest or landmark.

1. From the map screen, select the Search icon.
2. Select Categories.
3. Select a category (and a subcategory if necessary).
4. Select a place from the list.
5. Select Go!

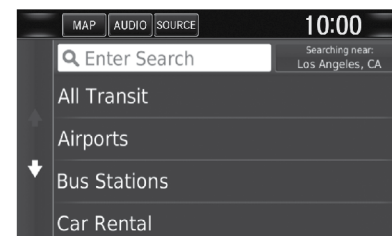
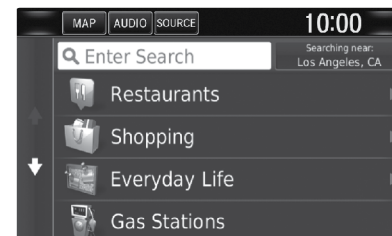

You can also enter a street address using voice commands. Press the Talk button and say "Navigation" and then "Find Place." Follow the prompts.

■ **Recent Places**

Select an address from a list of your 50 most recent destinations.

1. From the map screen, select the Search icon.
2. Select Recent.
3. Select a place from the list.
4. Select Go!

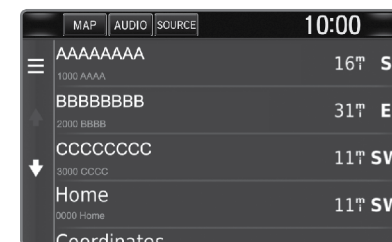

■ Saved Places

Save locations so you can quickly route to them.

Saving a location

1. From the map screen, select the Search icon.
2. Select Enter Search.
3. Enter the address or place name.
4. Select the destination name when it appears.
5. Select the info icon.
6. Select the menu icon.
7. Select Save.
8. Select OK.

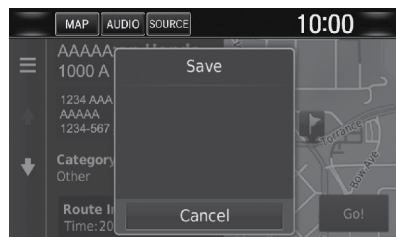
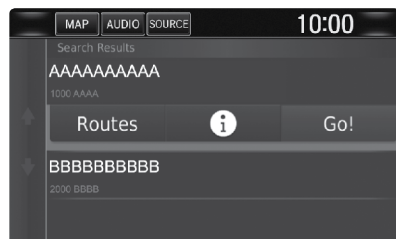

You can also save your current location. From the map screen, select the vehicle icon. Select Save. Enter a name for the location. Select Done. Select OK.

Routing to a saved location

1. From the map screen, select the Search icon.
2. Select Saved.
3. Select the destination from the list.
4. Select Go!

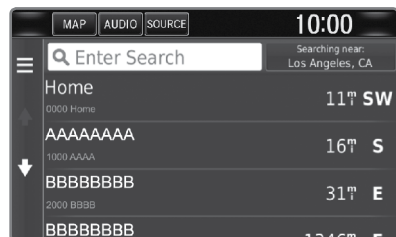

Routing

After a destination is set, you can alter or cancel your route.

■ Map Legend

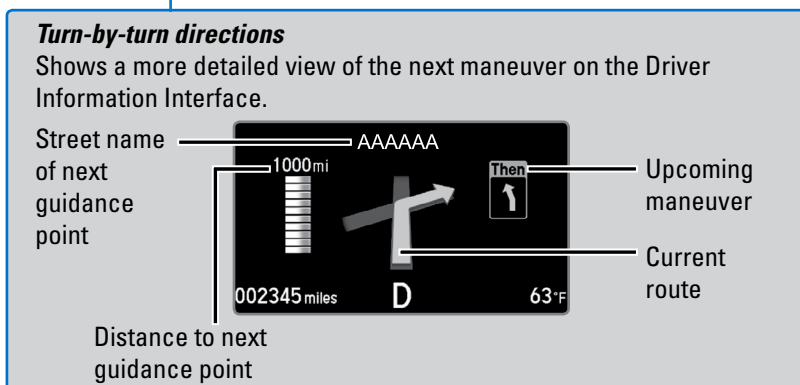
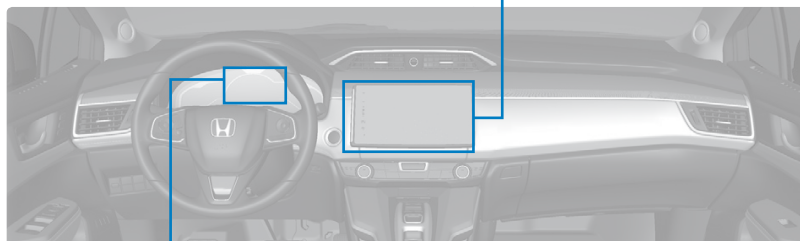
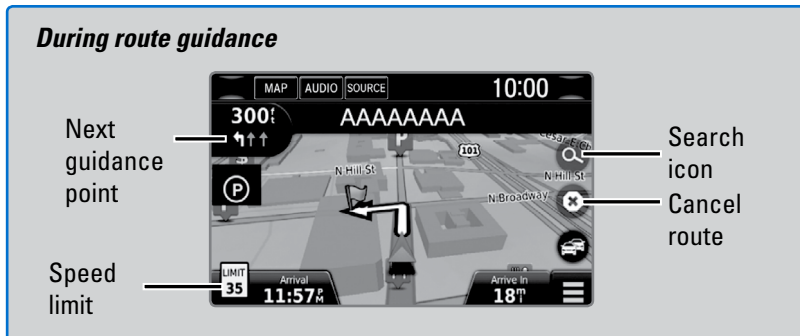

⚠ WARNING
 Using the navigation system while driving can take your attention away from the road, causing a crash in which you could be seriously injured or killed.
 Operate system controls only when the conditions permit you to safely do so.

DRIVING

Learn about preparation for driving, as well as other features.

Before Driving

Check the following items before you begin driving.

■ Exterior Checks

- Make sure there are no obstructions on the windows, door mirrors, exterior lights, or other parts of the vehicle.
- Remove any frost, snow, or ice.
- Make sure the hood is securely closed.
- Heat from the power system can ignite flammable materials left under the hood, causing a fire. If you've parked your vehicle for an extended period, inspect and remove any debris that may have collected, such as dried grass and leaves that have fallen or have been carried in for use as a nest by a small animal. Also check under the hood for leftover flammable materials after you or someone else has performed maintenance on your vehicle.
- Make sure the tires are in good condition.
- Make sure there are no people or objects behind or around the vehicle.
- Make sure to disconnect the charging cable.

NOTICE

If the doors are frozen shut, use warm water around the door edges to melt any ice. Do not try to force them open, as this can damage the rubber trim around the doors. When done, wipe dry to avoid further freezing.

■ Traffic

View traffic flow and incidents in major metro areas. Traffic alerts are accompanied by an audible beep. Pop-up messages and traffic information can be viewed when you are on the map screen. You can also select traffic to avoid. Traffic coverage is limited in Canada.

Viewing traffic

1. From the map screen, select the traffic icon.
2. Select Traffic Conditions.
3. Traffic icons are shown on the map. Select the magnifying glass icon to display a full list of traffic delays.



To mute traffic alerts and voice guidance: From the map screen, press MENU. Select Mute. To lower voice guidance volume, see page 81.

Avoiding traffic on your route

1. From the map screen, select the traffic icon.
2. Select Traffic on Route.
3. Select an incident to avoid from the list.
4. Select the menu icon.
5. Select Avoid.

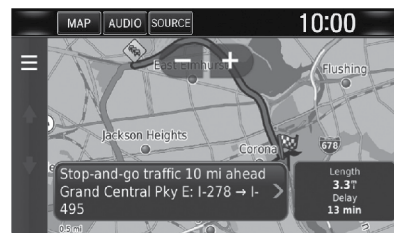
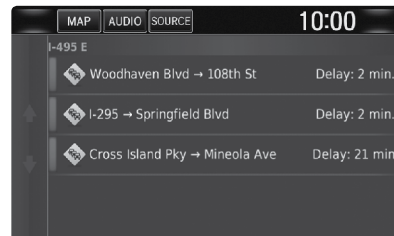

Interior Checks

- Store or secure all items on board properly.
- Do not pile items higher in the cargo area than the seat-back height.
- Do not place anything in the front seat footwells. Make sure to secure the floor mats.
- If you have any animals on board, do not let them move freely around in the vehicle.
- Securely close and lock all doors and the trunk.
- Adjust your seating position, mirrors, and steering wheel properly.
- Make sure items placed on the floor behind the front seats cannot roll under the seats.
- Everyone in the vehicle must fasten their seat belt.
- Make sure that the indicators in the instrument panel come on when you start the power mode and go off soon after.

In addition

- During the first 600 miles (1,000 km) of operation, avoid sudden acceleration or full throttle operation so as to not damage the power system.
- Avoid hard braking for the first 200 miles (300 km). You should also follow this when the brake pads are replaced.

WARNING

Improper accessories or modifications can affect your vehicle's handling, stability, and performance and cause a crash in which you can be seriously hurt or killed.

Follow all instructions in the vehicle owner's manual regarding accessories and modifications.

Maximum Load Limit

Carrying too much cargo or improperly storing it can affect your vehicle's handling, stability, stopping distance, and tires, and make it unsafe.

The maximum load for your vehicle is 850 lbs (385 kg). See the Tire and Loading Information label on the driver's doorjamb.

Label example

TIRE AND LOADING INFORMATION			
SEATING CAPACITY		TOTAL X	FRONT X REAR X
The combined weight of occupants and cargo should never exceed XXXkg or XXXlbs.			
TIRE	SIZE	COLD TIRE PRESSURE	
FRONT	XXXX/XXXXX XXX	XXXKPA, XXPSI	SEE OWNER'S MANUAL FOR ADDITIONAL INFORMATION
REAR	XXXX/XXXXX XXX	XXXKPA, XXPSI	
SPARE	XXXX/XXXXX XXX	XXXKPA, XXPSI	

This figure includes the total weight of all occupants, cargo, and accessories, and the tongue load if you are towing a trailer. Below are the steps for determining the correct load limit:

1. Locate the statement "The combined weight of occupants and cargo should never exceed XXX kg or XXX lbs." on your vehicle's placard.
2. Determine the combined weight of the driver and passengers that will be riding in your vehicle.
3. Subtract the combined weight of the driver and passengers from XXX kg or XXX lbs.
4. The resulting figure equals the available amount of cargo and luggage load capacity. For example, if the "XXX" amount equals 1,400 lbs. and there will be five 150 lb. passengers in your vehicle, the amount of available cargo and luggage load capacity is 650 lbs. (1,400 - 750 (5 x 150) = 650 lbs.)
5. Determine the combined weight of luggage and cargo being loaded on the vehicle. That weight may not safely exceed the available cargo and luggage load capacity calculated in step 4.
6. If your vehicle will be towing a trailer, load from your trailer will be transferred to your vehicle. Consult the Owner's Manual to determine how this reduces the available cargo and luggage load capacity of your vehicle.

In addition, the total weight of the vehicle, all occupants, accessories, cargo, and trailer tongue load must not exceed the Gross Vehicle Weight Rating (GVWR) or the Gross Axle Weight Rating (GAWR). Both are on a label on the driver's doorjamb.

Load Limits Example

Example1



Max Load
850 lbs
(385 kg)

≧



Passenger Weight
150 lbs x 2 = 300 lbs
(68 kg x 2 = 136 kg)

+



Cargo Weight
550 lbs
(249 kg)

Example2



Max Load
850 lbs
(385 kg)

≧



Passenger Weight
150 lbs x 5 = 750 lbs
(68 kg x 5 = 340 kg)

+



Cargo Weight
100 lbs
(45 kg)

⚠ WARNING

Overloading or improper loading can affect handling and stability and cause a crash in which you can be hurt or killed.

Follow all load limits and other loading guidelines in this guide.

The headlight aim on your vehicle was set by the factory and does not need to be adjusted. However, if you regularly carry heavy items in the trunk or pull a trailer, have the aiming readjusted at your authorized Honda Clarity Electric dealer or by a qualified technician.

Towing a Trailer

Your vehicle is not designed to tow a trailer. Attempting to do so can void your warranties.

Towing Your Vehicle

This vehicle is not designed to be towed behind a motorhome. Doing so may damage the transmission.

Remote Climate Control

Start the climate control system using the remote transmitter before you enter the vehicle.

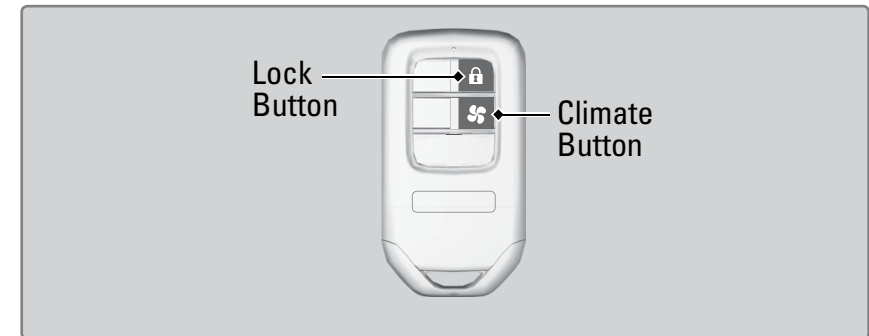

■ Turn On the Climate Control System

Press the Lock button, then press and hold the climate button within 5 seconds.

■ Turn Off the Climate Control System

Press and hold the climate button.

Starting to Drive

Turn on the power mode and start the power system to begin driving.

■ Before Starting the Power System

Make sure the parking brake is applied. Keep your foot firmly on the brake pedal when starting the power system.

The power system is harder to start in cold weather. When starting the power system in cold weather, turn off all electrical accessories, such as the lights, climate control system, and rear defogger in order to reduce 12-volt battery drain.

If the temperature of the High Voltage battery drops to -22°F (-30°C) or below, the power system may not start. Wait for the High Voltage battery to warm up, or warm it up by plugging in the vehicle.

If the temperature of the High Voltage battery drops to -31°F (-35°C) or below, the power system will not start. Wait for the High Voltage battery to warm up or move the vehicle to a warmer location. Note plugging the vehicle in will not help in this case. Store the vehicle in a garage or take another measure.

■ Changing the Power Mode

Use the POWER button to cycle through power modes or start the power system.

Accessory or On mode: Press the POWER button once without pressing the brake pedal for Accessory mode. Press it again for On mode.

Starting the power system: Press and hold the brake pedal, then press the POWER button. Keep your foot firmly on the brake pedal until the Ready to Drive indicator comes on.

Turning the power mode off: Put the transmission into Park (P), then press the POWER button. If you press the POWER button and the shift button is not in (P), the vehicle goes into Accessory Mode..

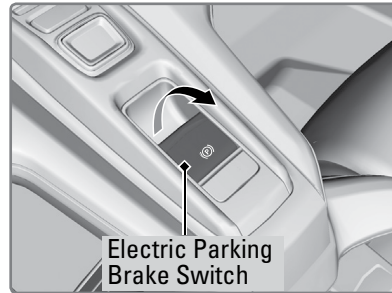

Electric Parking Brake Switch

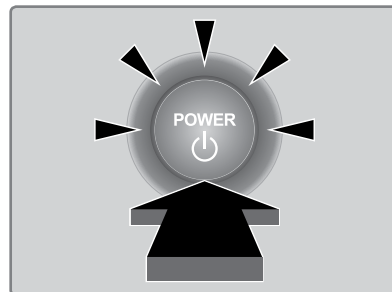

Shifting

Select the vehicle's gear using a simple button interface. Apply the brake pedal and select a gear.

Park (P): Press to put the vehicle in Park. A red indicator appears.

Reverse (R): Pull back to put the vehicle in Reverse. A green indicator appears.

Neutral (N): Press to put the vehicle in Neutral. A red indicator appears.

Drive (D): Press to put the vehicle in Drive. A green indicator appears. Release the electric parking brake to begin driving (see page 98).

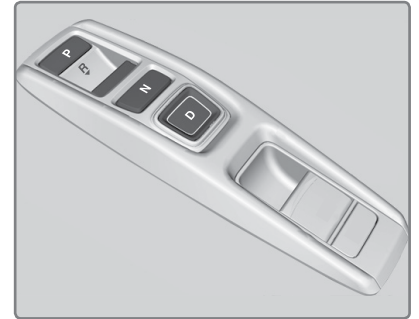

In freezing or sub-freezing conditions, the electronic gear selector response may be slow. Always apply the brake pedal before shifting into Park (P) and confirm that (P) is shown on the gear position indicator before releasing the brake.

Auto park mode

For your convenience, Park (P) is automatically selected when all of the following conditions are met:

- The vehicle is stopped.
- The driver's seatbelt is unbuckled.
- The driver's door is opened.

Car wash mode

If you are driving through a conveyor-style car wash where you or the attendant do not remain in the vehicle, follow these steps while the power system is on:

1. Press and hold the brake pedal. Make sure the READY indicator is on.
2. Press and release Neutral (N).
3. Press and hold Neutral (N) again for two seconds. The power system remains on and the transmission remains in Neutral (N). To turn off the power system, but keep the transmission in Neutral, press the POWER button.

The transmission remains in Neutral (N) for 15 minutes. After 15 minutes, the gear position changes to Park (P) and the power system turns off.

⚠ WARNING

The vehicle can roll away if left unattended without confirming that Park (P) is engaged. Always keep your foot on the brake pedal until you have confirmed that P is shown on the gear position indicator.

NOTICE

When you change from D to R and vice versa or want to change to Park (P), come to a complete stop and keep the brake pedal applied. Operating the gear buttons before the vehicle has come to a complete standstill can damage the transmission.

Acoustic Vehicle Alerting System

When the vehicle speed is approximately 12 mph (20 km/h) or less, the system alerts pedestrians that a vehicle is approaching.

Braking

Slow down or stop your vehicle and keep it from moving when parked.

- **Foot Brake**

Press the brake pedal to slow down or stop your vehicle from moving.

- **Brake Assist System**

During hard or emergency braking, the system increases braking force. The brake pedal may move slightly or make a noise; this is normal. Continue to hold the brake pedal firmly down.

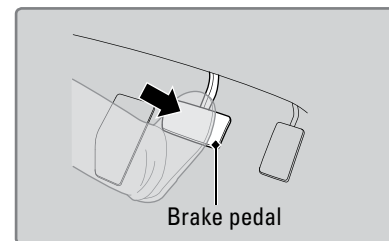

- **Anti-Lock Brake System (ABS)**

During hard or emergency braking, the system rapidly pumps the brakes to prevent wheel lockup and help you maintain steering control. Do not pump the brake pedal, rather continue to hold it firmly down.

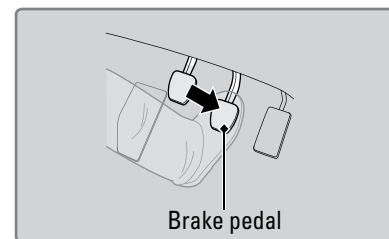

When ABS activates, you may notice vibrations through the brake pedal or the vehicle body, the brake pedal depressing further than usual, or hear a noise from the motor compartment. These are all normal.

In normal use, the ABS system will occasionally cause a sound from the motor compartment, especially when the power system is first started or after repeated use of the brakes.

NOTICE

The ABS may not function correctly if you use an incorrect tire type and size.

■ Parking Brake

To apply: Pull up the switch. The BRAKE indicator appears in the instrument panel. Hold the switch up for emergency braking while moving.

To release: Press the brake pedal and make sure your seat belt is fastened. Press the switch down to release.

You can also lightly press the accelerator pedal provided your seat belt is fastened, the power mode is on, and the transmission is in Drive (D) or Reverse (R).



■ Automatic Brake Hold

Maintains rear brake hold even after the brake pedal is released. Make sure the power mode is on and your seat belt is fastened when operating this feature.

1. Press the BRAKE HOLD button. The BRAKE HOLD indicator appears in the instrument panel.
2. With the transmission in Drive (D) or Neutral (N), press the brake pedal and come to a complete stop. The HOLD indicator appears and brake hold is applied. Release the brake pedal.

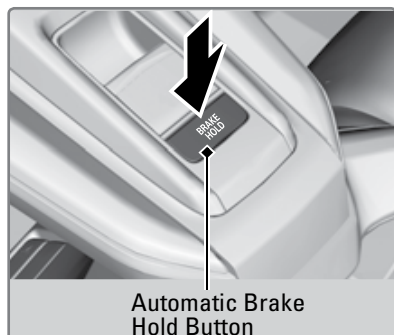

3. Press the accelerator pedal to cancel brake hold and start moving.

To turn off brake hold: Press the brake pedal and press the BRAKE HOLD button again.

Automatic brake hold cancels when:

- Braking is applied for more than 10 minutes.
- The electric parking brake is engaged.
- The foot brake is pressed and the transmission is moved to Park (P) or Reverse (R).
- The driver's seat belt is unfastened.
- The power mode is turned off.
- There is a problem with the automatic brake hold system.

⚠ WARNING

Activating the automatic brake hold system on steep hills or slippery roads may still allow the vehicle to move if you remove your foot from the brake pedal.

If a vehicle unexpectedly moves, it may cause a crash resulting in serious injury or death.

Never use the automatic brake hold system or rely on it to keep a vehicle from moving when stopped on a steep hill or slippery roads.

⚠ WARNING

Using the automatic brake hold system to park the vehicle may result in the vehicle unexpectedly moving.

If a vehicle moves unexpectedly, it may cause a crash, resulting in serious injury or death.

Never leave the vehicle when braking is temporarily kept by automatic brake hold and always park the vehicle by putting the transmission in Park (P) and applying the parking brake.

Eco Assist® System

Can help improve your efficiency by adjusting the performance of the power system, transmission, climate control system, and cruise control.

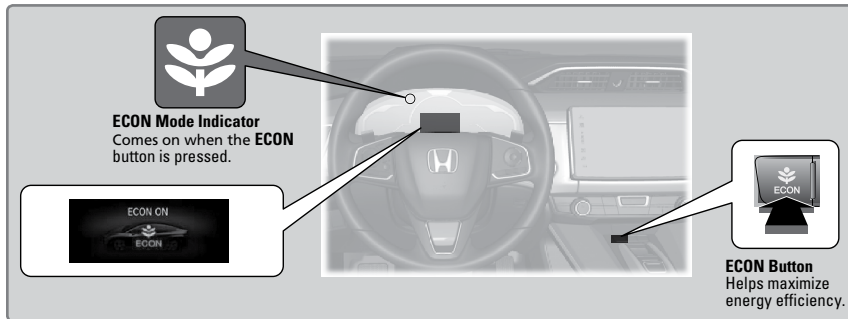

■ Ambient Meter

Color-coded bars change based on your driving style and brake or accelerator pedal operation.

Green: Energy-efficient driving

White-green: Moderate acceleration/ deceleration

White: Aggressive acceleration/ deceleration

Red: SPORT mode is on (see page 102)

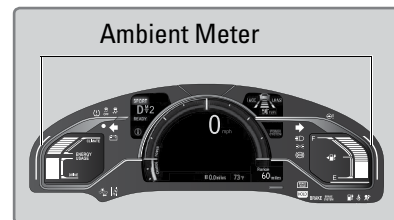

Eco Drive Display

Keep the vehicle in the center of the display to maximize your driving efficiency.

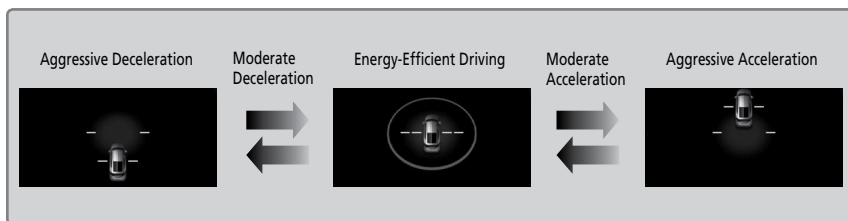

Deceleration Paddle Selector

Use the deceleration paddle selector to control the rate of deceleration. This simulates engine braking as it recovers energy via regenerative braking and helps you keep a distance between your vehicle and a vehicle ahead.

To select the different stages of deceleration, do this:

1. Pull back the + selector (right side) to decrease the deceleration stage.
2. Pull back the - selector (left side) to increase the deceleration stage.

Pull the (+) selector for a few seconds when you want to cancel the deceleration paddle selector.

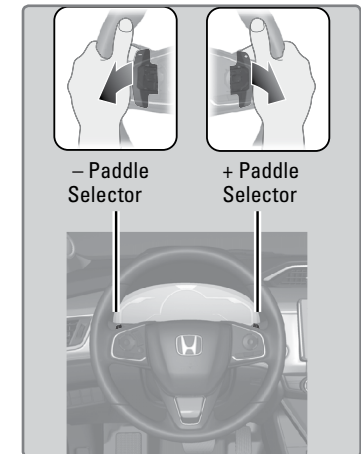
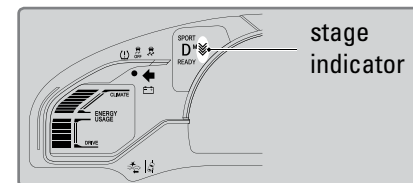

⚠ CAUTION

Be careful not to decelerate too quickly. Rapid deceleration can cause the tires to skid, resulting in loss of control of the vehicle.

In the following situations, the deceleration stage may decrease or cancel automatically:

- The high voltage battery is fully charged or its temperature is too cold or too hot.
- The speed of the vehicle is beyond the deceleration range.
- Power system protection is needed.
- The paddle selector is operated while your vehicle is stopped automatically by ACC with LSF.

■ SPORT mode OFF

The deceleration stage will self-cancel when you drive at a constant speed or approach a complete stop.

■ SPORT mode ON

The deceleration stage will not self-cancel. To cancel, turn the SPORT mode OFF or pull the + selector (right side) for a few seconds.

SPORT Mode

Enhances the vehicle's agility and responsiveness. SPORT mode is set to off every time the power system is started.

■ SPORT Button

Press the SPORT button to turn the mode on or off. A SPORT Mode indicator and a message in the driver information interface appear when the system is on.

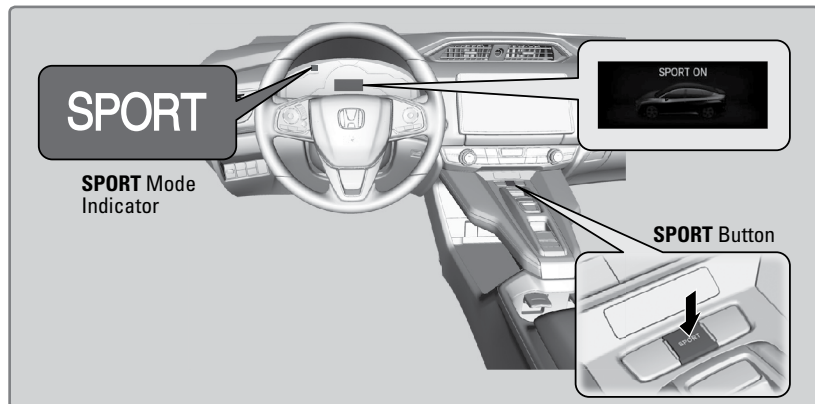

Vehicle Stability Assist® (VSA®)

Also known as Electronic Stability Control (ESC), VSA helps to stabilize the vehicle during cornering if the vehicle turns more or less than what was intended. It assists in maintaining traction on slippery surfaces by regulating power system output and selectively applying the brakes.

■ Turning VSA On or Off

VSA is turned on every time you start the power system, even if you previously turned it off. If you turn VSA off, your vehicle has normal braking and cornering ability, but VSA traction and stability enhancement become less effective.

Press and hold the VSA OFF button until you hear a beep to turn VSA on or off. The VSA OFF indicator appears when the system is off.

Traction control becomes less effective, which may make it easier when trying to free your vehicle if it is stuck in mud or snow.

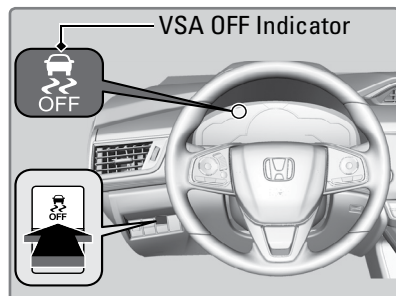

Adaptive Cruise Control (ACC) with Low Speed Follow (LSF)

Helps maintain a constant vehicle speed and a set following interval behind a vehicle detected ahead of yours.

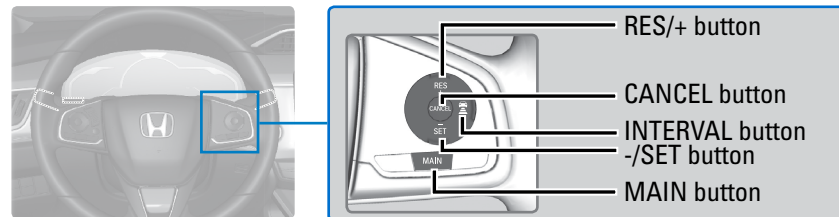

■ Activating and Setting the Vehicle Speed

1. Press the MAIN button. The ACC indicator appears.
2. Accelerate to the desired speed.
Above 25 mph (40 km/h): Take your foot off the pedal and press the -/SET button to set the speed

Below 25 mph (40 km/h) (Low Speed Follow):
Press the -/SET button to set the speed at 25 mph (40 km/h) if a vehicle is detected in front of you.

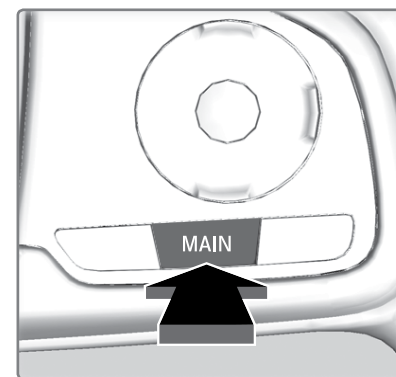

■ Adjusting the Vehicle Speed

Press the RES/+ button to increase speed or the -/SET button to decrease speed.

Each time you press the switch up or down, the vehicle speed is increased or decreased by about 1 mph or 1 km/h. If you keep the switch pressed up or down, the vehicle speed increases or decreases by 5 mph or 5 km/h until you release it.

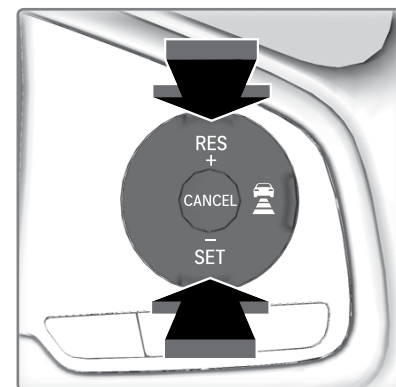

■ Adjusting the Following Interval

Press the Interval button to change the following interval. Each time you press the button, the following-interval setting cycles through short, middle, long, and extra long.

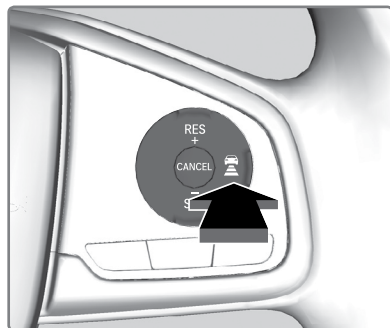

Interval	Short	Middle	Long	Extra Long
Approx. Gap (seconds)	1.1	1.5	2.1	2.8

■ Switching to Standard Cruise Control

- Press and hold the Interval button.
- Cruise mode appears in the Driver Information Interface. Press and hold the Interval button again to switch back to ACC.

■ When in Operation

If a vehicle is detected ahead of you when ACC is turned on, the system maintains, accelerates, or decelerates your vehicle's set speed to keep the vehicle's set following interval from the vehicle ahead.

If a vehicle detected ahead of you slows down abruptly or if another vehicle cuts in front of you, a beep sounds and BRAKE appears on the Driver Information Interface to alert you.

When a vehicle detected ahead is within range and stops, your vehicle also stops. The Stopped message appears on the Driver Information Interface.

When the vehicle ahead of you starts again, the vehicle icon on the Driver Information Interface blinks. Press the RES/+ button or the -/SET button or press the accelerator pedal to resume the prior set speed.

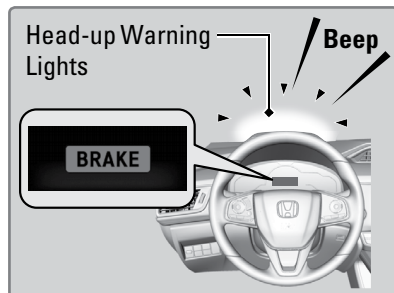

■ Cancelling ACC

Press the CANCEL or MAIN buttons or press the brake pedal.

Certain conditions may cause ACC to cancel automatically. When this happens, a message appears on Driver Information Interface.

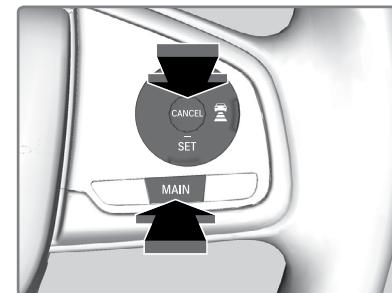

After adaptive cruise control has been cancelled, you can still resume the prior set speed by pressing the RES/+ button.

Press the MAIN button to turn the system off.

⚠ WARNING

Exiting a vehicle that has been stopped while the ACC with LSF system is operating can result in the vehicle moving without operator control.

A vehicle that moves without operator control can cause a crash, resulting in serious injury or death.

Never exit a vehicle when the vehicle is stopped by ACC with LSF.

⚠ WARNING

ACC with LSF has limited braking capability and may not stop your vehicle in time to avoid a collision with a vehicle that quickly stops in front of you.

Always be prepared to apply the brake pedal when conditions require.

⚠ WARNING

Improper use of ACC with LSF can lead to a crash.

Use ACC with LSF only when driving on expressways or freeways and in good weather conditions.

Lane Keeping Assist System (LKAS)

Provides steering input to help keep the vehicle in the middle of a detected lane and visual and tactile alerts if the vehicle is detected drifting out of its lane while driving between 45–90 mph (72–145 km/h).

If your vehicle is getting too close to detected left or right side lane markings without a turn signal activated, a message appears on the Driver Information Interface and the steering wheel vibrates. Steering torque is also applied to help keep your vehicle within your driving lane.



Turning the System On or Off

1. Press the MAIN button. LKAS appears in the Driver Information Interface.
2. Press the LKAS button. Lane outlines appear in the Driver Information Interface. Dotted lane lines turn solid when the system starts operating.
3. Press the MAIN button or the LKAS button to turn the system off.

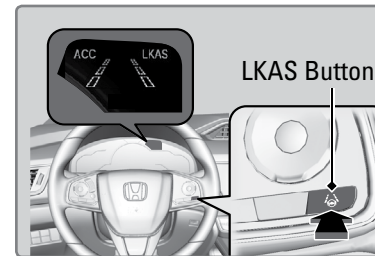
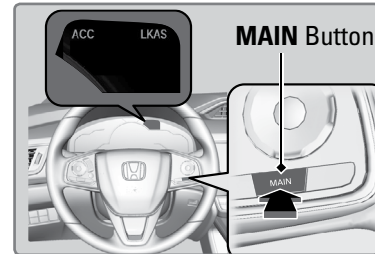

Important Safety Reminder

LKAS is for your convenience only. It is not a substitute for your vehicle control. The system does not work if you take your hands off the steering wheel or fail to steer the vehicle.

Do not place an object on the top of the instrument panel. It may reflect onto the windshield and prevent the system from detecting lane lines properly.

Road Departure Mitigation (RDM)

Alerts and helps to assist you if the system determines a possibility of your vehicle unintentionally crossing over detected lane markings while driving between 45–90 mph (72–145 km/h).

If your vehicle is getting too close to detected lane markings without a turn signal activated, a message appears in the Driver Information Interface and the steering wheel vibrates. Steering wheel torque is applied to help your vehicle stay in the lane.

Braking may also be applied if the lane lines are solid and continuous.

If the system operates several times without detecting driver response, the system beeps to alert you.

Turning the System On or Off

Press the RDM button to turn the system on or off. A green indicator appears on the button when the system is on and a message briefly appears.

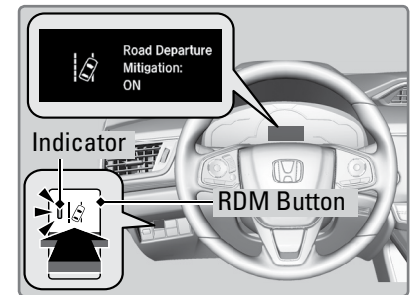

■ Changing Settings

Determine the warning type.

1. From the HOME screen, select Settings.
2. Select Vehicle. The vehicle must be in Park (P).
3. Select Driver Assist System Setup.
4. Select Road Departure Mitigation Setting.
5. Select from the options.
Normal (default): Steering control starts from inside the lane edge.
Wide: Steering control starts from outside the lane edge.
Warning Only: The system only provides a BRAKE message and steering wheel vibrations, but does not apply steering torque or braking.
6. Press BACK to exit the menu.

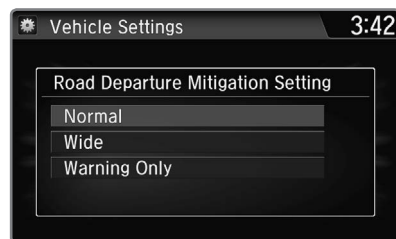

Important Safety Reminder

The RDM system has limitations. Over-reliance on it may result in a collision. It is always your responsibility to keep your vehicle within the driving lane.

Collision Mitigation Braking System™ (CMBS™)

Can assist you when there is a possibility of your vehicle colliding with a vehicle or a pedestrian detected in front of yours.

The system can give you visual, audible, and tactile alerts when a potential collision is determined and reduce your vehicle speed to help minimize collision severity when a collision is deemed unavoidable.

When a potential collision with a detected oncoming vehicle is determined, the system also alerts you with rapid vibrations on the steering wheel.

The system activates when:

- The speed difference between your vehicle and a vehicle or pedestrian detected in front of you is about 3 mph (5 km/h) and over with a chance of a collision.
- Your vehicle speed is about 62 mph (100 km/h) or less and there is a chance of a collision with an oncoming detected vehicle or a pedestrian in front of you.

■ Alert Stages

The system has three alert stages for a possible collision. Depending on the circumstances or CMBS settings, CMBS may not go through all of the stages before initiating the last stage.

Stage 1: Visual and audible warning. The steering wheel may also vibrate.

Stage 2: Visual and audible warning and light brake application.

Stage 3: Visual and audible warning and strong brake application.

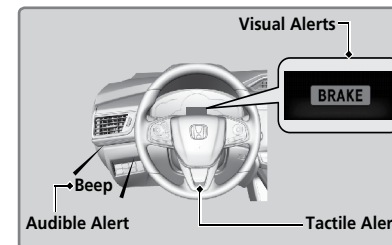

■ Changing Settings

Determine the warning timing.

1. From the HOME screen, select Settings.
2. Select Vehicle. The vehicle must be in Park (P).
3. Select Driver Assist System Setup.
4. Select Forward Collision Warning Distance.
5. Select Long, Normal, or Short.
6. Press BACK to exit the menu.

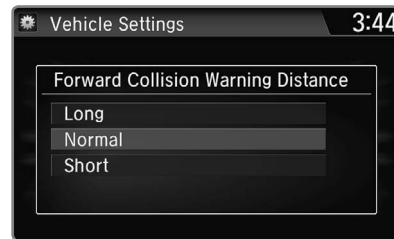

■ Turning CMBS On or Off

Press and hold the CMBS OFF button. A beep sounds and a message appears in the MID. The CMBS indicator appears when the system is off.

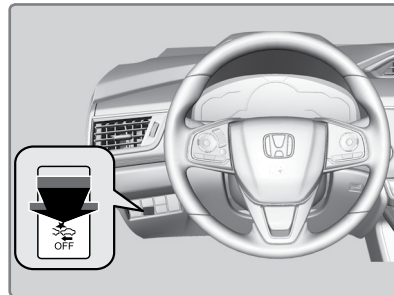

Important Safety Reminder

CMBS is designed to reduce the severity of an unavoidable collision. It does not prevent collisions nor stop the vehicle automatically. It is still your responsibility to operate the brake pedal and steering wheel appropriately according to the driving conditions.

LaneWatch™

Check the passenger-side rear areas in the upper display when the right turn signal is activated.

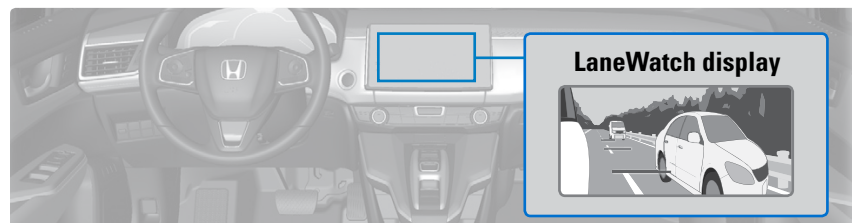

■ Activating LaneWatch

Activate the right turn signal. The LaneWatch display appears. Check the display for blind spots and visually confirm that it is safe to change lanes.

You can also press the LaneWatch button on the end of the turn signal switch to view a constant real-time display. Press it again to turn the display off.

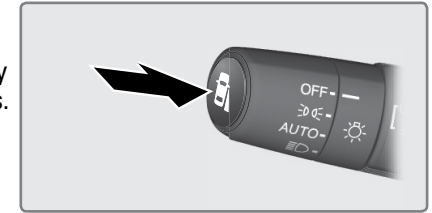

■ Changing Settings

Customize the display and how and when the display appears.

1. From the HOME screen, select Settings.
2. Select Camera.
3. Select LaneWatch.
4. Select an option and make the preferred changes.
5. Press BACK to exit the menu.

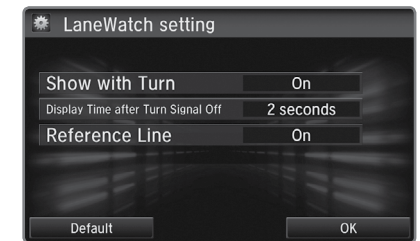

Important Safety Reminder

Like all assistance systems, LaneWatch has limitations. Over-reliance on the system may result in a collision.

⚠ WARNING

Failure to visually confirm that it is safe to change lanes before doing so may result in a crash and serious injury or death.

Do not rely only on LaneWatch while driving. Always look in your mirrors, to either side of your vehicle, and behind you for other vehicles before changing lanes.

Multi-View Rear Camera

When you shift into Reverse (R), a real-time image of the area behind your vehicle is shown in the upper display, along with helpful parking guidelines.

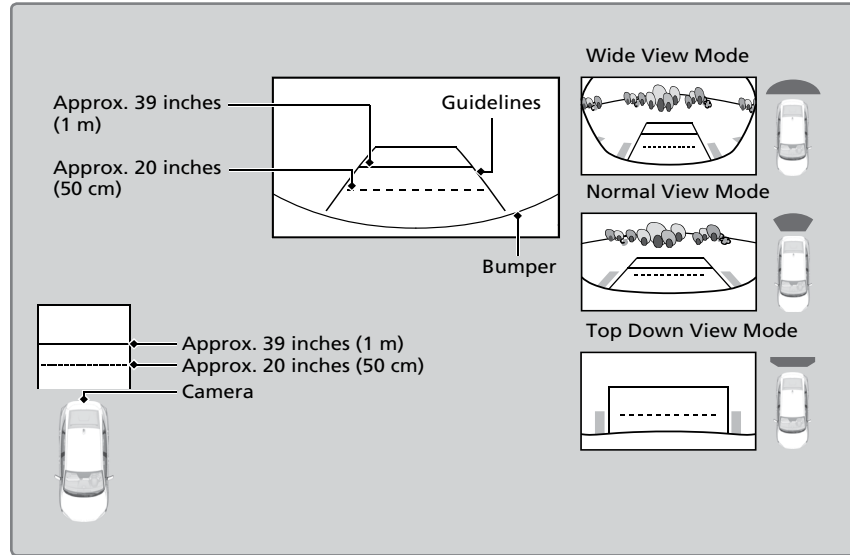

■ Changing Camera Settings

Turn the guidelines on or off.

1. From the HOME screen, select Settings.
2. Select Camera.
3. Select Rear Camera.
4. Select an option.
 - Fixed Guideline:* Guidelines appear when you shift into Reverse.
 - Dynamic Guideline:* Guidelines move as you turn the steering wheel.
5. Select On or Off.
6. Press BACK to exit the menu.

The rear camera view is restricted. You cannot see the corner ends of the bumper or what is underneath the bumper. Its unique lens also makes objects appear closer or farther than they actually are.

Visually confirm that it is safe to drive before backing up. Certain conditions (such as weather, lighting, and high temperatures) may also restrict the rear view. Do not rely on the rearview display which does not give you all information about conditions at the back of your vehicle.

If the camera lens is covered with dirt or moisture, use a soft, moist cloth to keep the lens clean and free of debris.

Charging

The 120-volt charger draws approximately 12 amps. Make sure to use a dedicated and properly grounded circuit that can supply 12 amps continuously. Have an electrician inspect the outlet you are using to see if it meets these criteria.

■ Charger Levels

Charging time varies based on the “level” of the charger. A level-1 charger uses household current (110 volts). A level-2 charger, sometimes call a quick charger, uses a special high-capacity circuit of 220 volts or more. Level-2 charging is faster than level-1 charging.

■ Safety Checklist

Check these items before charging your vehicle:

- Make sure you plug the charging cable directly into the wall outlet dedicated to vehicle charging. Do not use extension cords, adaptors, or multi-outlet plugs between the charging cable and the outlet.
- Make sure the charging cable is fully uncoiled before use.
- Make sure the control box, charge connector, and charging cable are free from any damage, including cracks or frays. If you find any damage to the devices, contact an authorized Honda Clarity Electric dealer.
- Make sure the charge connector and inlet are clean. If you find any contamination or foreign object in the connector or inlet, contact an authorized Honda Clarity Electric dealer.
- Make sure the charging cable is dry. Check that there is no water in the immediate area and that your hands are dry.

⚠ WARNING

Using a 120 volt wall outlet that is rated less than 12 amps or one that is powering other devices can cause a fire, seriously injuring you or others.

When using the 120-volt charger, use a dedicated and properly grounded circuit rated 12 amps or more. Consult an electrician if you are not sure.

■ How to Charge (Level 1)

1. Put the transmission into Park (P) and set the power mode to OFF.
2. Press and hold the charge lid release button.

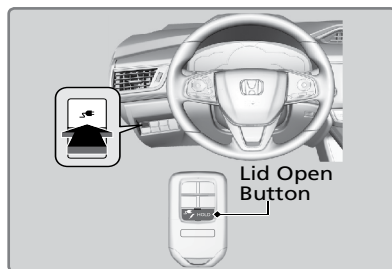

1. The charging cable is stored in a bag in the trunk. Prepare the charging cable and open the vehicle's charge lid. When in use, do not tie or coil the cable.

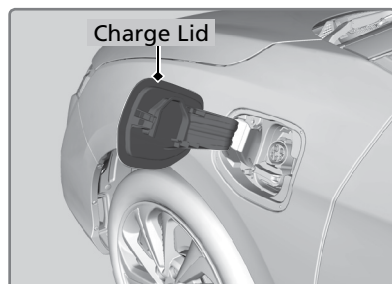

2. Insert the plug into a 120-volt wall outlet completely until it stops. Check that the READY indicator on the control box comes on.

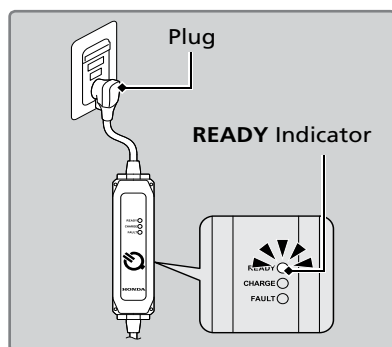

3. Remove the cover from the charge connector. Align and insert the charge connector into the vehicle's inlet until you hear a click. The charge indicator stops blinking and stays on when charging starts.

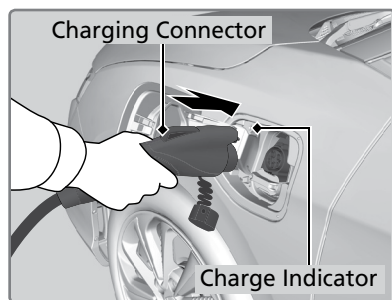

⚠ WARNING

Improper usage and handling of the 120-volt charger can cause a fire, seriously injuring you or others.

Always insert the plug fully into a properly rated and grounded the wall outlet.

Plug the charging cable directly to the wall outlet. Do not use extension cords or multi-plug adapters.

Prevent the vehicle charge connector from becoming contaminated. Clean if necessary.

■ How to Charge (Level 2 or Combo)

1. Stop your vehicle at a station specific for electric vehicles. Park with the charge lid closest to the charge plug, just in front of the driver's door.
2. Put the transmission into Park (P) and turn off the power system.
3. Press and hold the charge lid release button.

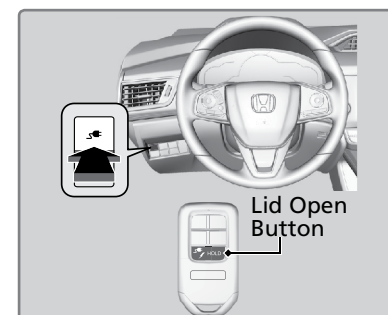

4. Open the charge lid. In case of using with COMBO charge connector, open the charge lid and remove the inlet cover.

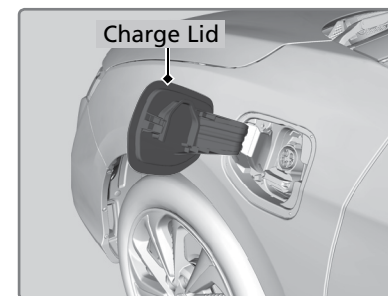

5. To connect the cable to the vehicle, push the cable's charge connector until it clicks to the charge lid. The charge indicator on the charge lid stays on.

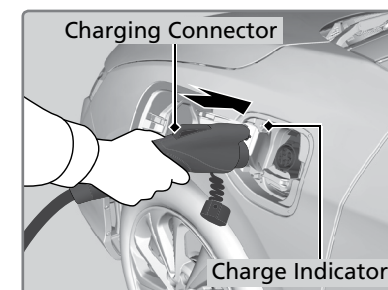

HANDLING THE UNEXPECTED

Learn about what to do in critical or emergency situations.

Smart Entry Remote Battery Strength

If the battery life in your remote transmitter is weak, a beep sounds and the POWER button indicator flashes. A message appears in the driver information interface, with information on how to start the power system.

1. Touch the back of the remote transmitter to the POWER button while the indicator is flashing.
2. With the brake pedal or clutch pedal pressed, press the POWER button within 10 seconds.

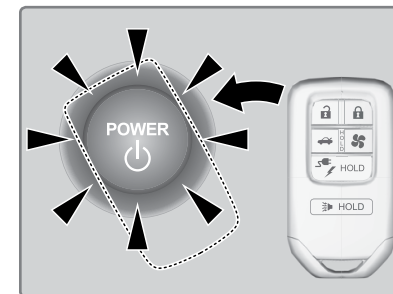

Overheating

If the power system overheats, you will see the message, “High Temperature. Power Reduced” appear on the driver information interface.

Immediately park the vehicle in a safe place. Put the vehicle in Park (P) and set the parking brake. Turn off all accessories and turn on the hazard warning lights. Keep the power mode on and resume driving if the message disappears. If the message does not disappear or reappears, contact an authorized Honda Clarity Electric dealer for repairs.

NOTICE

Keep the hood closed while waiting for the power system to cool down. Opening the hood will cause the radiator fan to stop, making it take longer for the power system to cool down.

■ When Charging is Complete

Press the release button on the charge connector to release it from the inlet. If you removed the inlet cover, make sure to put the cover back on the inlet before you close the lid. The charge indicator goes off once charging is complete.

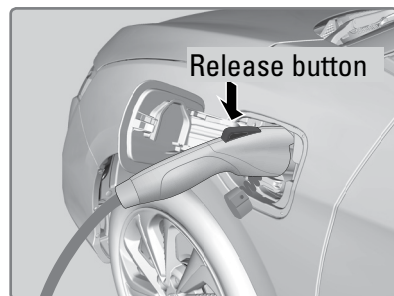

Note: The charging equipment provided with this vehicle has been tested and found to comply with the limits for a Class B digital device, pursuant to part 15 of the FCC Rules.

These limits are designed to provide reasonable protection against harmful interference in a residential installation.

This equipment generates, uses and can radiate radio frequency energy and, if not installed and used in accordance with the instructions, may cause harmful interference to radio communications.

However, there is no guarantee that interference will not occur in a particular installation.

If this equipment does cause harmful interference to radio or television reception, which can be determined by turning the equipment off and on, the user is encouraged to try to correct the interference by one or more of the following measures:

- Reorient or relocate the receiving antenna.
- Increase the separation between the equipment and receiver.
- Connect the equipment into an outlet on a circuit different from that to which the receiver is connected.
- Consult the dealer or an experienced radio/TV technician for help.

Improving Energy Efficiency

Achieving energy efficiency is dependent on several factors, including driving conditions, load weight, standby time, driving habits, and vehicle condition. Depending on these and other factors, you may not achieve the rated driving range of this vehicle.

Emergency Power System Off

The POWER button may be used to stop the power system due to an emergency situation even while driving. If you must stop the power system, choose one of the following operations:

- Press and hold the POWER button for two seconds, or
- Firmly press the POWER button three times.

The steering wheel will not lock. However, because turning off the engine disables the power assist the engine provides to the steering and braking systems, it will require significantly more physical effort and time to steer and slow the vehicle. Use both feet on the brake pedal to slow down the vehicle and stop immediately in a safe place.

The gear position automatically changes to Park (P) after the vehicle comes to a complete stop. Then the power mode changes to VEHICLE OFF.

NOTICE

Do not press the button while driving unless it is absolutely necessary for the power system to be switched off.

Emergency Towing

Call a professional towing service if you need to tow your vehicle.

This vehicle requires a flat-bed tow vehicle: The operator loads your vehicle on the back of a truck.

NOTICE

Trying to lift or tow your vehicle by the bumpers will cause serious damage. The bumpers are not designed to support the vehicle's weight.

Improper towing such as towing behind a motorhome or other motor vehicle can damage the transmission.

Any other towing method will damage the vehicle's drive system.

Tire Pressure Monitoring System (TPMS)

Monitors the tire pressure while you are driving.

If your vehicle's tire pressure becomes significantly low, the low tire pressure indicator comes on and a message appears.

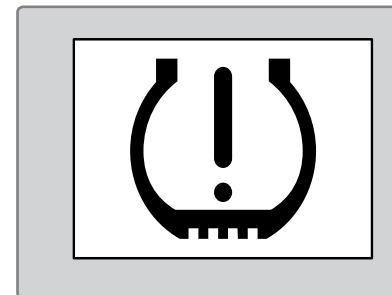

■ What to Do

Stop your vehicle in a safe place. Check the tire pressure and adjust the pressure to the specified level on the label on the driver's doorjamb.

■ TPMS Calibration

Any time you inflate, change, or rotate one or more of the tires, you need to recalibrate the system. The calibration process requires approximately 30 minutes of cumulative driving at speeds between 30–65 mph (48–105 km/h). The vehicle must be stopped to begin calibration, and the process finishes automatically.

Use the touchscreen to make and enter selections.

1. From the HOME screen, select Settings.
2. Select Vehicle.
3. Select TPMS Calibration.
4. Select Calibrate.

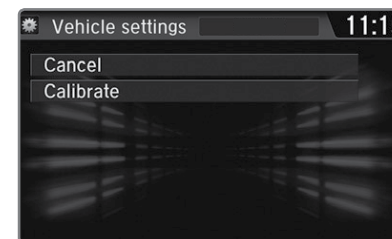

NOTICE

Driving on an extremely underinflated tire can cause it to overheat. An overheated tire can fail. Always inflate your tires to the specified pressure.

■ Tire Pressure Monitoring System (TPMS) - Required Federal Explanation

Each tire, including the spare (if provided), should be checked monthly when cold and inflated to the inflation pressure recommended by the vehicle manufacturer on the vehicle placard or tire inflation pressure label.

(If your vehicle has tires of a different size than the size indicated on the vehicle placard or tire inflation pressure label, you should determine the proper tire inflation pressure for those tires.)

As an added safety feature, your vehicle has been equipped with a tire pressure monitoring system (TPMS) that illuminates a low tire pressure telltale when one or more of your tires is significantly underinflated.



Accordingly, when the low tire pressure telltale illuminates, you should stop and check your tires as soon as possible, and inflate them to the proper pressure.

Driving on a significantly underinflated tire causes the tire to overheat and can lead to tire failure. Underinflation also reduces energy efficiency and tire tread life, and may affect the vehicle's handling and stopping ability.

Please note that the TPMS is not a substitute for proper tire maintenance, and it is the driver's responsibility to maintain correct tire pressure, even if underinflation has not reached the level to trigger illumination of the TPMS low tire pressure telltale.

Your vehicle has also been equipped with a TPMS malfunction indicator to indicate when the system is not operating properly. The TPMS malfunction indicator is combined with the low tire pressure telltale. When the system detects a malfunction, the telltale will flash for approximately one minute and then remain continuously illuminated. This sequence will continue upon subsequent vehicle start-ups as long as the malfunction exists.

When the malfunction indicator is illuminated, the system may not be able to detect or signal low tire pressure as intended.

TPMS malfunctions may occur for a variety of reasons, including the installation of replacement or alternate tires or wheels on the vehicle that prevent the TPMS from functioning properly.

Always check the TPMS malfunction telltale after replacing one or more tires or wheels on your vehicle to ensure that the replacement or alternate tires and wheels allow the TPMS to continue to function properly.

Tire Repair Kit

If a tire goes flat while driving, grasp the steering wheel firmly, and brake gradually to reduce speed. Stop in a safe place. Follow the steps below. Go to an authorized Honda Clarity Electric dealer as soon as possible to have the full-size tire repaired or replaced.

If a tire has a small puncture, you can use the tire repair kit to temporarily repair it. The puncture must be smaller than 3/16-inch (4 mm) and not in the tire sidewall. This vehicle is not equipped with a spare tire.

■ Before Repairing the Tire

1. Park the vehicle on a firm, level, and non-slippery surface.
2. Change the gear to Park (P) and apply the parking brake.
3. Turn on the hazard warning lights and set the power mode to VEHICLE OFF (LOCK).

■ Getting Ready to Repair the Tire

1. Remove the charging cable by releasing the belt. Pull the strap on the right side of the trunk and open the lid.
2. Place the kit upright on flat ground near the punctured tire and away from traffic. Do not place the kit on its side.
3. Follow the instructions in the kit to repair the tire.

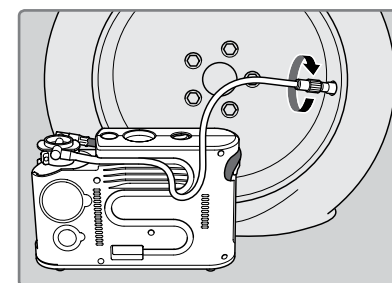
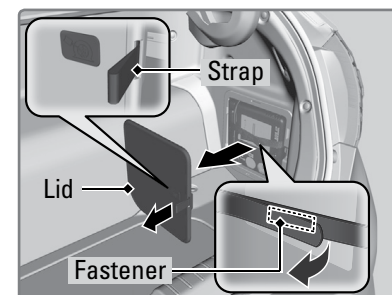

NOTICE

If the required air pressure is not reached within 10 minutes, the tire may be too severely damaged for the kit to provide the necessary seal and your vehicle will need to be towed.

Do not operate the temporary tire repair kit compressor for more than 15 minutes. The compressor can overheat and become permanently damaged.

Fuse Locations

If any electrical devices are not working, set the power mode to VEHICLE OFF (LOCK), and check to see if any applicable fuse is blown. Fuse locations are shown on the fuse box cover. Locate the fuse in question by the fuse number and box cover number.

Motor Compartment Fuse Box

Fuse Box A

Located under the hood near the windshield washer reservoir. Push the tabs to open the box.

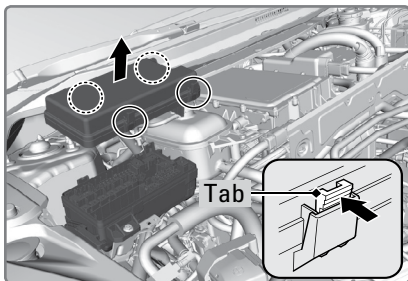

	Circuit Protected	Amps
1	BATTERY	175 A
	EPS	70 A
	ESB	40 A
2	IG MAIN SMART	30 A
	ABS/VSA MOTOR	40 A
	WIPER MOTOR 1	30 A
	ABS/VSA FSR	40 A
3	-	30 A
	-	30 A
	SUB FUSE BOX 2-1	30 A
	SUB FUSE BOX 3-2	30 A
4	IG MAIN 2	30 A
	-	-
5	H/L LO MAIN	15 A
6	HP VLV	10 A
7	DTWP	10 A
8	-	-
9	VBU	10 A
10	STOP LIGHT	7.5 A
11	-	-

	Circuit Protected	Amps
12	FUSE BOX MAIN 1	60 A
	FUSE BOX MAIN 2	40 A
	FUSE BOX MAIN 3	50 A
	H/L HI MAIN	30 A
	SMALL MAIN	20 A
	SUB FUSE BOX 4	30 A
	-	30 A
	WIPER MOTOR 2	30 A
	-	30 A
	-	30 A
13	HEATER MOTOR	40 A
14	REAR DEFROSTER	40 A
15	-	-
16	BATT SNSR	7.5 A
17	ES EWP	15 A
18	A/C MAIN/DRL	10 A
19	ES VLV	7.5 A
20	HORN	10 A
21	BACK UP	10 A
22	AUDIO	15 A
23	-	-
24	R H/L LO	7.5 A
25	L H/L LO	7.5 A
26	-	-

Fuse Box B

Attached to the 12-volt battery (+) terminal. Replacement of these fuses should be done by an authorized Honda Clarity Electric dealer.

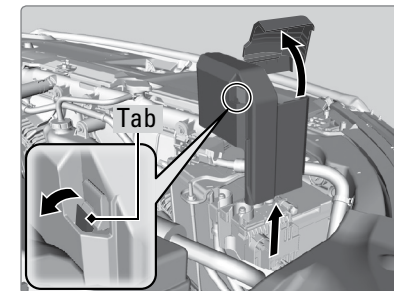

Driver's Side Interior Fuse Boxes

Fuse boxes A–D are all behind the same panel, under the driver's side dashboard.

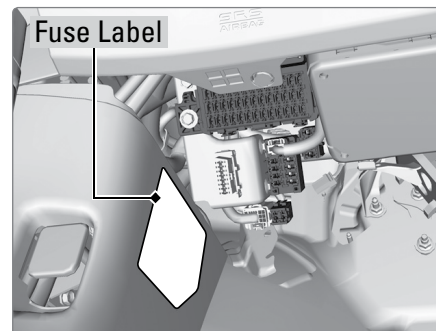

Fuse Box A

	Circuit Protected	Amps		Circuit Protected	Amps
1	ACC	7.5 A	21	ACG	10 A
2	–	–	22	DRL	7.5 A
3	–	–	23	–	–
4	SHIFTER	7.5 A	24	FR SENSOR CAMERA	5 A
5	OPTION MAIN	15 A	25	DR DOOR LOCK	10 A
6	SRS OPTION	10 A	26	R SIDE DOOR UNLOCK	10 A
7	METER	10 A	27	RR R P/W	20 A
8	FUEL PUMP	7.5 A	28	DR P/W	20 A
9	OPTION	7.5 A	29	FR ACC SOCKET	20 A
10	CTR ACC SOCKET	20 A	30	INTERIOR LIGHT	7.5 A
11	–	–	31	DR P/SEAT REC	20 A
12	R SIDE DOOR LOCK	10 A	32	FR SEAT HEATER	20 A
13	L SIDE DOOR UNLOCK	10 A	33	DR P/SEAT SLI	20 A
14	RR L P/W	20 A	34	ABS/VSA	7.5 A
15	AS P/W	20 A	35	SRS	10 A
16	DOOR LOCK	20 A	36	–	–
17	P-DRV	7.5 A	37	LID ACT	10 A
18	–	–	38	L SIDE DOOR LOCK	10 A
19	WASHER	15 A	39	DR DOOR UNLOCK	10 A
20	–	–			

Fuse Box B

Located under fuse box A.

	Circuit Protected	Amps
c	QC CNT	(10 A)
d	R H/L HI	7.5 A
e	L H/L HI	7.5 A
f	IGC	10 A
g	HAZARD	10 A
h	IGB	15 A
i	SMART	10 A
j	IGA	10 A

Fuse Box C

Located on the right side of fuse box B

	Circuit Protected	Amps
k	AS P/SEAT REC	(20 A)
l	AS P/SEAT SLIDE	(20 A)
m	ILLUMI	7.5 A
n	SMALL	7.5 A

Fuse Box D

Located behind the lower-left corner of the dashboard.

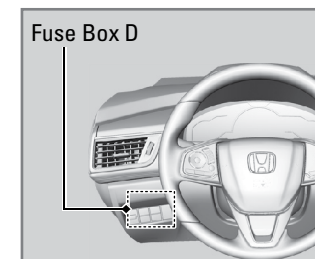

	Circuit Protected	Amps
p	COMBO	(10 A)
q	IGMG	(7.5 A)
r	SHIFTER	7.5 A
s	P-ACT DRV	7.5 A
t	–	–
u	EPP	(7.5 A)
v	OPTION	7.5 A
w	ESB	7.5 A

Replacement of box-D fuses should be done by an authorized Honda Clarity Electric dealer.

■ Inspecting and Changing Fuses

1. Set the power mode to VEHICLE OFF (LOCK). Turn headlights and all accessories off.
2. Check fuse box B in the motor compartment (see page 122).
3. If the fuse is blown, have it replaced by an authorized Honda Clarity Electric dealer.
4. Inspect the small fuses in motor compartment (fuse box A) and the vehicle interior.
If there is a blown fuse, remove it with the fuse puller and replace it with a new one.

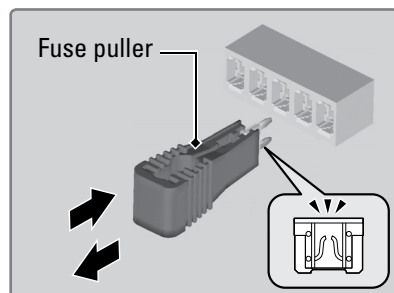
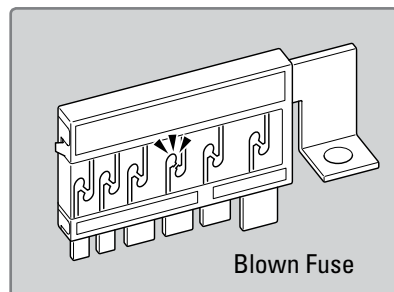

NOTICE

Replacing a fuse with one that has a higher rating greatly increases the chances of damaging the electrical system.

MAINTENANCE

Learn about basic maintenance that you can perform on the vehicle yourself, as well as information about how to best maintain the vehicle.

Safety Precautions

Some of the most important safety precautions are listed below; however, we cannot warn you of every conceivable hazard that can arise in performing maintenance. Only you can decide whether or not you should perform a given task.

■ Maintenance Safety

- To reduce the possibility of fire or explosion, keep cigarettes, sparks, and flames away from the 12-volt battery, and all High Voltage system related parts.
- To clean parts, use a commercially available degreaser or parts cleaner, not gasoline.
- Wear eye protection and protective clothing when working with the 12-volt battery or compressed air.
- Never leave rags, towels, or other flammable objects under the hood. Heat from the motor or the surrounding parts can ignite them, causing a fire.

■ Vehicle Safety

- The vehicle must be stationary and parked on level ground with the parking brake set and the power system off.
- Be aware that hot parts can burn you.
- Be aware that moving parts can injure you.

⚠ WARNING

Improperly maintaining this vehicle or failing to correct a problem before driving can cause a crash in which you can be seriously hurt or killed.

Always follow the inspection and maintenance recommendations according to the schedules in this guide.

⚠ WARNING

Failure to properly follow maintenance instructions and precautions can cause you to be seriously hurt or killed.

Always follow the procedures and precautions in this guide.

Maintenance Minder™

Reminds you when indicated maintenance service is due.

When maintenance is due, the system message indicator comes on and a message appears on the driver information interface every time you turn the vehicle on. Press either Info button (◀/▶) on the steering wheel to change displays.

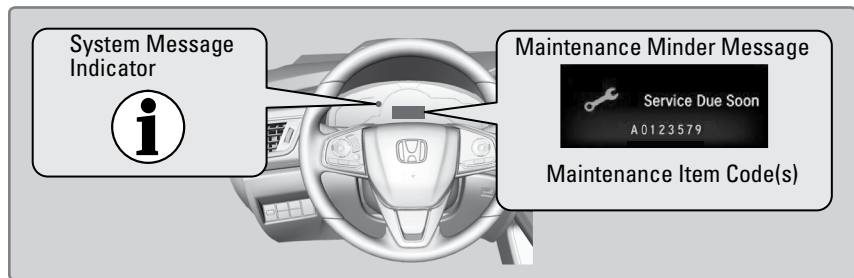

All maintenance services should be performed in accordance with the intervals indicated by the driver information interface.

■ Maintenance Minder Service Codes

These codes indicate what services are due on your vehicle.

CODE	Maintenance Items
0	<ul style="list-style-type: none"> • Inspect front and rear brakes • Check expiration date for Temporary Tire Repair Kit • Inspect these items: <ul style="list-style-type: none"> • Tie rod ends, steering gear box, and boots • Suspension components • Driveshaft boots • Brake hoses and lines (including ABS/VSA) • All fluid levels and condition of fluids • Stay RR, RR Subframe • Under body battery cover
1	<ul style="list-style-type: none"> • Rotate tires
2	<ul style="list-style-type: none"> • Replace dust and pollen filter*¹
3	<ul style="list-style-type: none"> • Replace transmission fluid*²
7	<ul style="list-style-type: none"> • Replace brake fluid*³

*1: If you drive primarily in urban areas that have high concentrations of soot in the air from industry and from diesel-powered vehicles, replace the dust and pollen filter every 15,000 miles.

*2: Driving in mountainous areas at very low vehicle speeds results in higher transmission temperatures. This requires transmission fluid changes more frequently than recommended by the Maintenance Minder. If you regularly drive your vehicle under these conditions, have the transmission fluid changed every 31,250 miles.

*3: If a Maintenance Minder message does not appear more than 3 years after the display for item 7 is reset, change the brake fluid and replace air cleaner element every 3 years.

Under the Hood

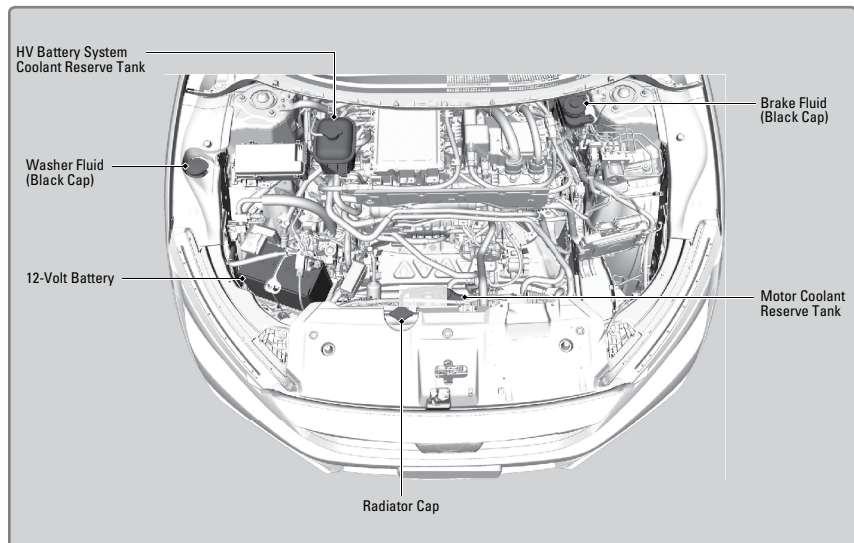

Opening the Hood

1. Park the vehicle on a level surface and set the parking brake.
2. Pull the hood release handle under the lower left corner of the dashboard.
3. Push the hood latch lever (located under the front edge of the hood to the center) to the side and raise the hood slightly, you can release the lever.
4. Remove the support rod from the clamp using the grip. Mount the support rod in the hood.

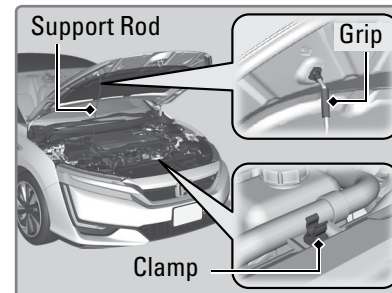
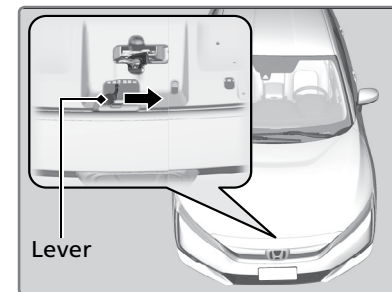
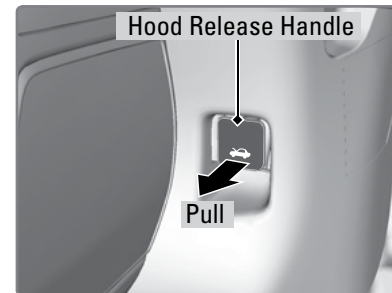

NOTICE

Do not open the hood when the wiper arms are raised. The hood will strike the wipers and may damage either the hood or the wipers.

Coolant Levels

Park the vehicle on level ground. Check the reserve tanks. **We recommend Honda Long Life Antifreeze/Coolant Type 2.**

■ Checking the Coolant Level for the Motor and Related Parts

If the coolant level is below the MIN mark, have your vehicle inspected by an authorized Honda Clarity Electric dealer.

1. Check the amount of coolant in the reserve tank.
2. If the coolant level is below the MIN mark, inspect the cooling system for leaks. Only a properly trained technician can refill the coolant and check the system for leaks.

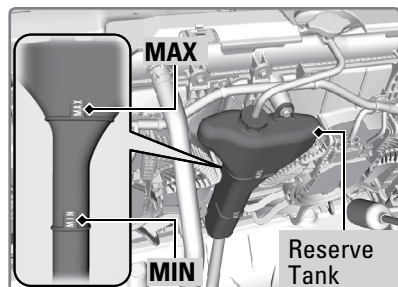

NOTICE

If temperatures consistently below -31°F (-35°C) are expected, the coolant mixture should be changed to a higher concentration. Consult an authorized Honda Clarity Electric dealer for details for more information.

■ Checking the High Voltage Battery Coolant Reserve Tank

Make sure the motor is cool.

1. Check the amount of coolant in the reserve tank.
2. If the coolant level is below the MIN mark, inspect the cooling system for leaks. Only a properly trained technician can refill the coolant and check the system for leaks.

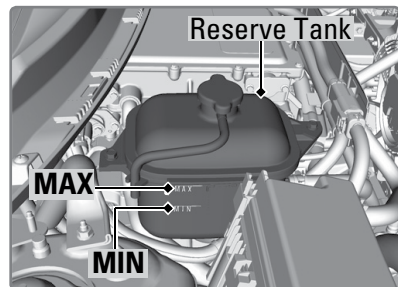

⚠ WARNING

Removing the reserve tank cap while the motor is hot can cause the coolant to spray out, seriously scalding you.

NOTICE

Pour the fluid slowly and carefully so you do not spill any. Immediately clean any spills—they can damage components in the motor compartment.

Brake Fluid

The fluid level should be between the MIN and MAX marks on the side of the reserve tank. **We recommend Honda Heavy Duty Brake Fluid DOT 3.**

Pour the fluid carefully.

If the fluid level is at or below the MIN mark, have an authorized Honda Clarity Electric dealer inspect for leaks or worn brake pads as soon as possible.

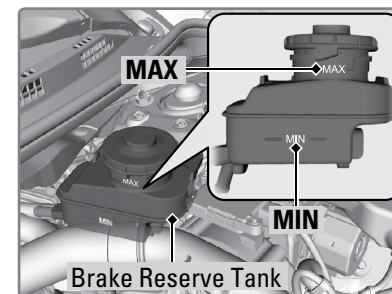

NOTICE

Brake fluid marked DOT 5 is not compatible with your vehicle's braking system and can cause extensive damage.

Changing Wiper Blades

If the wiper blades leave streaks across the windshield, try cleaning them first with a paper towel or soft cloth and wiper fluid. If the wiper blade rubber has deteriorated, it will leave streaks and can scratch the window glass. You should change the wiper blades.

1. Set the power mode to VEHICLE OFF (LOCK).
2. While holding the wiper switch in the MIST position, set the power mode to ON, then to VEHICLE OFF (LOCK). The wipers move to their maintenance position.
3. Lift both wiper arms.
4. For each wiper arm, press and hold the tab, then slide the holder from the wiper arm.
5. Pull the wiper blade (as shown) until it clears the end cap, then slide it out of the holder by pulling the blade up and out in the other direction.

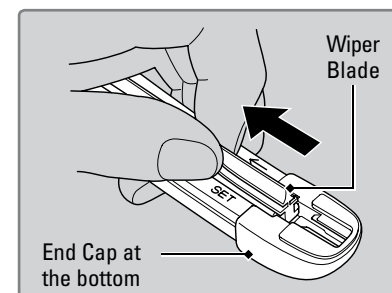
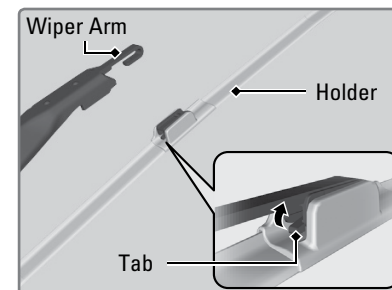
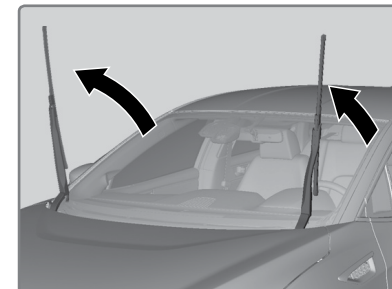

Checking the 12-volt Battery

Check the battery condition monthly. Look at the test indicator window and check the terminals for corrosion.

The battery condition is monitored by a sensor on the negative terminal. If there is a problem with the sensor, a message on the information driver information interface appears. Have your vehicle checked by an authorized Honda Clarity Electric dealer.

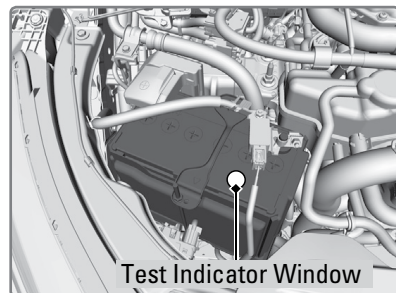

WARNING

The battery gives off explosive hydrogen gas during normal operation. A spark or flame can cause the battery to explode with enough force to kill or seriously hurt you. When conducting any battery maintenance, wear protective clothing and a face shield, or have a skilled technician do it.

WARNING: Battery posts, terminals, and related accessories contain lead and lead compounds. **Wash your hands after handling.**

Window Washer Fluid

If the washer fluid level is low, fill the washer reservoir. Pour the washer fluid carefully. Do not overflow the reservoir.

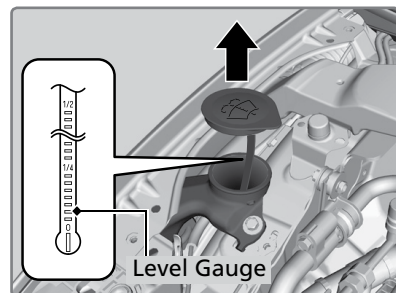

NOTICE

Do not use engine antifreeze or a vinegar/water solution in the windshield washer reservoir. Antifreeze can damage your vehicle's paint. A vinegar/water solution can damage the windshield washer pump.

6. Insert the flat end of a new blade into the holder. Secure the end of the blade into the cap.
7. Slide the holder onto the wiper arm until it locks. Lower the wiper arms when done.
8. Set the power mode to ON. Hold the wiper switch in the MIST position until the wiper arms return to their normal position.

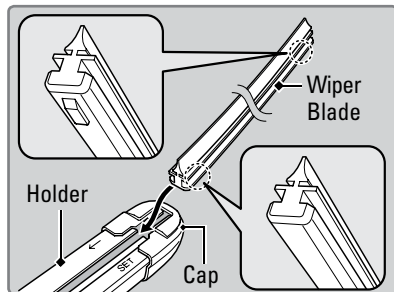

NOTICE

Avoid dropping the wiper arm, as it may damage the arm or the windshield.

Tire Information

To safely operate your vehicle, your tires must be of the proper type and size, in good condition with adequate tread, and properly inflated.

■ **Inflation Guidelines**

- Properly inflated tires provide the best combination of handling, tread life, and comfort. Refer to the driver's doorjamb label or the specifications (see page 143) for the specified pressure.
- Underinflated tires wear unevenly, adversely affect handling and energy consumption, and are more likely to fail from overheating.
- Overinflated tires make your vehicle ride harshly, are more prone to road hazards, and wear unevenly.
- Every day before you drive, look at each of the tires. If one looks lower than the others, check the pressure with a tire gauge.
- Measure the air pressure when tires are cold. This means the vehicle has been parked for at least 3 hours, or driven less than 1 mile (1.6 km). If necessary, add or release air until the specified pressure is reached, and then calibrate the system (see page 119). If checked when hot, tire pressure can be as much as 4–6 psi (30–40 kPa, 0.3–0.5 kgf/cm²) higher than checked when cold.
- At least once a month or before long trips, use a gauge to measure the pressure in all tires. Even tires in good condition can lose 1–2 psi (10–20 kPa, 0.1–0.2 kgf/cm²) per month.

■ **Inspection Guidelines**

Every time you inflate the tires, check for the following:

- Any damage to tires, including bumps, bulges, cuts, splits, or cracks in the side or tread. Remove any foreign objects and inspect for air leaks. Replace tires if you see fabric or cord.
- Uneven or excessive tread wear. Have an authorized Honda Clarity Electric dealer check the wheel alignment.
- Cracks or other damage around the valve stems.

■ **Wear Indicators**

The groove where the wear indicator is located is 1/16 inch (1.6 mm) shallower than elsewhere on the tire. If the tread has worn so low that the indicator is exposed, replace the tire.

Worn out tires have poor traction on wet roads.

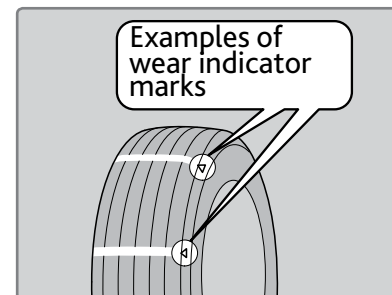

⚠ WARNING

Using tires that are excessively worn or improperly inflated can cause a crash in which you can be seriously hurt or killed.

Follow all instructions in this owner's manual regarding tire inflation and maintenance.

TABLE OF CONTENTS

VISUAL INDEX

SAFETY INFORMATION

INSTRUMENT PANEL

VEHICLE CONTROLS

AUDIO AND CONNECTIVITY

BLUETOOTH® HANDSFREELINK®

HONDALINK®

NAVIGATION

DRIVING

HANDLING THE UNEXPECTED

MAINTENANCE

SPECIFICATIONS

CUSTOMER INFORMATION

VOICE COMMAND INDEX

INDEX

Tire and Loading Information Label

The label attached to the driver's doorjamb provides necessary tire and loading information.

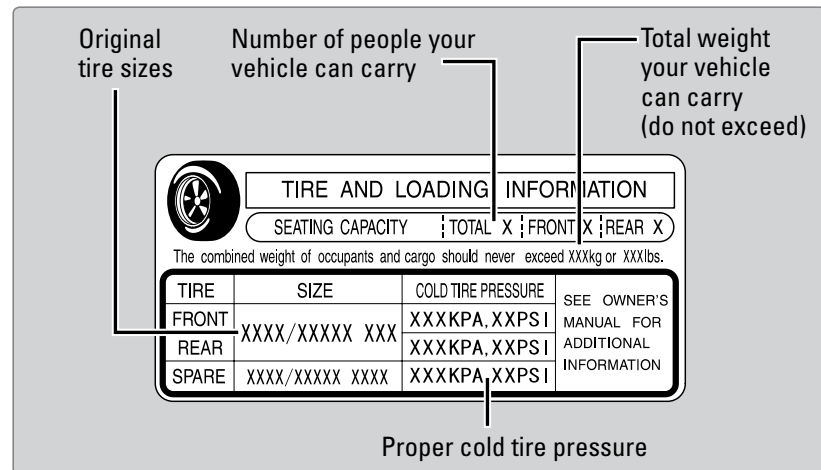

Tire and Wheel Replacement

Replace your tires with radials of the same size, load range, speed rating, and maximum cold tire pressure rating (as shown on the tire's sidewall). Using tires of a different size or construction can cause certain vehicle systems to work incorrectly, including ABS and Vehicle Stability Assist (VSA). It is best to replace all four tires at the same time. If that isn't possible, replace the front or rear tires in pairs.

If you change or replace a wheel, make sure that the wheel's specifications match those of the original wheels.

⚠ WARNING

Installing improper tires on your vehicle can affect handling and stability. This can cause a crash in which you can be seriously hurt or killed. Always use the size and type of tires recommended in the Owner's Manual.

Tire Service Life

The life of your tires is dependent on many factors, including driving habits, road conditions, vehicle loading, inflation pressure, maintenance history, speed, and environmental conditions (even when the tires are not in use).

In addition to regular inspections and inflation pressure maintenance, it is recommended that you have annual inspections performed once the tires reach five years old. All tires, including the spare, should be removed from service after 10 years from the date of manufacture, regardless of their condition or state of wear.

Winter Tires

If driving on snowy or frozen roads, mount all season tires marked "M+S", snow tires, or tire chains; reduce speed and maintain sufficient distance between vehicles when driving. For winter tires, select the size and load ranges that are the same as the original tires and mount them to all four wheels.

Tire Chains

Install tire chains on the front tires only. Because your vehicle has limited tire clearance, we strongly recommend using the following chains:

Cable-type: SCC Radial Chain SC1040

Mount chains as tightly as you can and make sure that they do not touch the brake lines or suspension.

⚠ WARNING

Using the wrong chains, or not properly installing chains, can damage the brake lines and cause a crash in which you can be seriously injured or killed. Follow all instructions in this guide regarding the selection and use of tire chains.

NOTICE

Traction devices that are the wrong size or improperly installed can damage your vehicle's brake lines, suspension, body, and wheels. Stop driving if they are hitting any part of the vehicle.

TABLE OF CONTENTS
VISUAL INDEX
SAFETY INFORMATION
INSTRUMENT PANEL
VEHICLE CONTROLS
AUDIO AND CONNECTIVITY
BLUETOOTH® HANDSFREELINK®
HONDALINK®

NAVIGATION
DRIVING
HANDLING THE UNEXPECTED
MAINTENANCE
SPECIFICATIONS
CUSTOMER INFORMATION
VOICE COMMAND INDEX
INDEX

Tire Labeling

The tires that came on your vehicle have a number of markings. Those you should be aware of are described below.

Here is an example of what each marking means:

215/50R17 94V

215: tire width in millimeters

50: aspect ratio (tire section height as a percentage of its width)

R: tire construction code (radial)

17: rim diameter in inches

94: load index (code indicating maximum load tire can carry)

V: speed symbol (code indicating maximum speed rating)

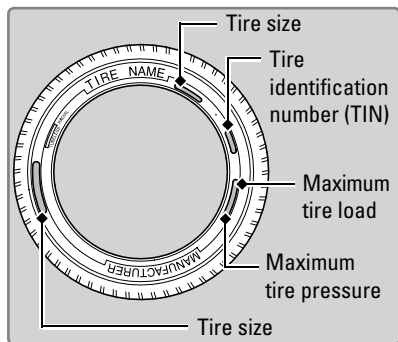

■ Tire Identification Number (TIN)

The tire identification number (TIN) is a group of numbers and letters that look like the example shown. TIN is located on the sidewall of the tire.

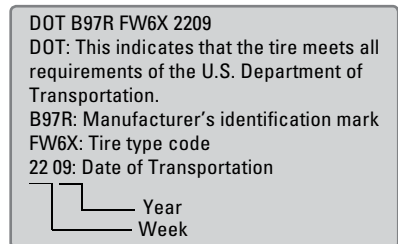

■ Glossary of Tire Terminology

Cold Tire Pressure – The tire air pressure when the vehicle has been parked for at least three hours or driven less than 1 mile (1.6 km).

Load Rating – The maximum load that a tire is rated to carry for a given inflation pressure.

Maximum Inflation Pressure – The maximum tire air pressure that the tire can hold.

Maximum Load Rating – The load rating for a tire at the maximum permissible inflation pressure for that tire.

Recommended Inflation Pressure – The cold tire inflation pressure recommended by the manufacturer.

Treadwear Indicators (TWI) – The projections within the principal grooves designed to give a visual indication of the degrees of wear of the tread.

DOT Tire Quality Grading

The tires on your vehicle meet all U.S. Federal Safety Requirements. All tires are also graded for treadwear, traction, and temperature performance according to Department of Transportation (DOT) standards. The following explains these gradings.

■ Uniform Tire Quality Grading

Quality grades can be found where applicable on the tire sidewall between tread shoulder and maximum section width.

For example:

Treadwear 200

Traction AA

Temperature A

All passenger car tires must conform to Federal Safety Requirements in addition to these grades.

■ Treadwear

The treadwear grade is a comparative rating based on the wear rate of the tire when tested under controlled conditions on a specified government test course.

For example, a tire graded 150 would wear one and one-half (1 1/2) times as well on the government course as a tire graded 100. The relative performance of tires depends upon the actual conditions of their use, however, and may depart significantly from the norm due to variations in driving habits, service practices, and differences in road characteristics and climate.

■ Traction

The traction grades, from highest to lowest, are AA, A, B, and C. Those grades represent the tire's ability to stop on wet pavement as measured under controlled conditions on specified government test surfaces of asphalt and concrete. A tire marked C may have poor traction performance.

WARNING: The traction grade assigned to this tire is based on straight-ahead braking traction tests and does not include acceleration, cornering, hydroplaning, or peak traction characteristics.

■ **Temperature**

The temperature grades are A (the highest), B, and C, representing the tire’s resistance to the generation of heat and its ability to dissipate heat when tested under controlled conditions on a specified indoor laboratory test wheel. Sustained high temperature can cause the material of the tire to degenerate and reduce tire life, and excessive temperature can lead to sudden tire failure. The grade C corresponds to a level of performance which all passenger car tires must meet under the Federal Motor Vehicle Safety Standard No. 109. Grades B and A represent higher levels of performance on the laboratory test wheel than the minimum required by law.

WARNING: The temperature grade for this tire is established for a tire that is properly inflated and not overloaded. Excessive speed, underinflation, or excessive loading, either separately or in combination, can cause heat buildup and possible tire failure.

Air Conditioning

To ensure proper and safe operation, the Society of Automotive Engineers (SAE J2845) recommends that the refrigerant system only be serviced by trained and certified technicians.

Never repair or replace the air conditioning evaporator (cooling coil) with one removed from a used or salvaged vehicle.

New replacement mobile air conditioning evaporators must be certified (and labeled) as meeting SAE Standard J2842.

NOTICE

Vented refrigerant is harmful to the environment. To avoid refrigerant from venting, never replace the evaporator with one removed from a used or salvaged vehicle.

Refrigerant in your vehicle’s air conditioning system is flammable and can be ignited during servicing if proper procedures are not followed.

SPECIFICATIONS

■ **Vehicle**

Model	CLARITY ELECTRIC
No. of Passengers:	
Front	2
Rear	3
Total	5
Weights:	
Gross Vehicle Weight Rating	4,921 lbs (2,232 kg)
Gross Axle Weight Rating (Front)	2,383 lbs (1,081 kg)
Gross Axle Weight Rating (Rear)	2,610 lbs (1,184 kg)

■ **Washer Fluid**

Tank Capacity	1.43 US qt (1.35 L)
---------------	---------------------

■ **Brake Fluid**

Specified	Honda Heavy Duty Brake Fluid DOT 3
-----------	------------------------------------

■ **Transmission Fluid**

Specified	Honda Automatic Transmission Fluid ATF DW-1	
Capacity	Change	1.85 US qt (1.75 L)

■ **Coolant**

Specified	Honda Long Life Antifreeze/Coolant Type2
-----------	--

■ **Light Bulbs**

Headlights (Low Beam)	LED
Headlights (High Beam)	LED
Front Turn Signal Lights	LED
Front Side Marker Lights	LED
Parking/Daytime Running Lights	LED
Taillights/Rear Side Marker Lights	LED
Brake Lights	LED
Taillights	LED
Back-Up Lights	LED
Rear Turn Signal Lights	LED
High-Mount Brake Light	LED
Rear License Plate Light	LED
Interior Lights	
Front and Rear Map Lights	LED
Front and Rear Ambient Lights	LED
Vanity Mirror Lights	1.4 W
Center Console Light	LED
Glove Box Light	LED
Front Foot Lights	LED
Trunk Light	LED
Charge Indicator Light	LED

■ **Tires**

	Size	235/45R18 94V	
Regular	Pressure	Front	36 (250 [2.5])
		Rear	38 (260 [2.7])
Wheel Size	Regular	18 x 8J	

■ **Air Conditioning**

Refrigerant Type	HFO-1234yf (R-1234yf)
Charge Quantity	27.3 – 29.1 oz (775 – 825g)
Lubricant Type	SE-A2 (POE)
Quantity	7.63 – 9.46 cu-in (125 – 155 cc)

TABLE OF CONTENTS

VISUAL INDEX

SAFETY INFORMATION

INSTRUMENT PANEL

VEHICLE CONTROLS

AUDIO AND CONNECTIVITY

BLUETOOTH® HANDSFREELINK®

HONDALINK®

NAVIGATION

DRIVING

HANDLING THE UNEXPECTED

MAINTENANCE

SPECIFICATIONS

CUSTOMER INFORMATION

VOICE COMMAND INDEX

INDEX

CUSTOMER INFORMATION

Learn about information specific to you as a Honda customer and how to get help.

Frequently Asked Questions/Troubleshooting

Below are some frequently asked questions and troubleshooting items that you may have about the vehicle.

Q: *How do I set the vehicle clock?*

A: The time is automatically set using GPS signals.

Q: *Why doesn't the vehicle start when I press the POWER button?*

A: The brake pedal must be pressed to start the power system.

Q: *What is the AUTO setting on my headlight lever?*

A: When in the AUTO position, the vehicle's exterior lights will automatically turn on or off, depending on the ambient lighting.

Q: *Why won't the driver's door unlock when I grab the door handle, even though the keyless access remote is within range?*

A: If you pull the handle too quickly, the system may not have time to confirm the door is unlocked. Wait to hear a beep to confirm the door is unlocked. If you are wearing gloves, the system may be slow to respond.

Q: *After my battery was disconnected or went dead, the audio system is asking for a code. Where do I find this?*

A: In most cases, you do not need to enter a code. Turn on the vehicle and the audio system, and press and hold the POWER button until the system reactivates.

Q: *Why can't I operate Pandora through the audio system?*

A: Audio may be streaming through *Bluetooth* Audio. Make sure Pandora mode is selected and the phone cable is properly connected to the USB adapter cable (if using). Some phones may prompt you to "Allow" a connection.

Q: *Is my phone compatible with Bluetooth features?*

A: Visit automobiles.honda.com/handsfreelink to check phone compatibility for *Bluetooth* Audio, *Bluetooth* HandsFreeLink, and SMS text messaging.

Q: *Every time I press the Talk button, the system gives me voice prompts. Can I turn these off?**

A: From the HOME screen, select SETTINGS. Select System, then select Voice Prompt. Select Off.

Q: *The amber indicator with a tire and an exclamation mark is on. What does it mean?*

A: Either your tire pressure is low or you recently filled a tire. See page 119.

Contact Us

Personnel at your authorized Honda Clarity Electric dealer are trained professionals. They should be able to answer all your questions. If you encounter a problem that your dealership does not solve to your satisfaction, please discuss it with the dealership's service manager or general manager. If you are dissatisfied with the decision made by the dealership's management, contact Honda Automobile Customer Service.

American Honda Motor Co., Inc.
Honda Automobile Customer Service
1919 Torrance Blvd.
Mail Stop 100-5E-8A
Torrance, CA 90501-2746
Tel: (800) 999-1009

When you call or write, please give us the following information:

- Vehicle Identification Number
- Date of purchase
- Odometer reading of your vehicle
- Your name, address, and telephone number
- A detailed description of the problem
- Name of the authorized Honda Clarity Electric dealer who sold the vehicle to you

Honda Roadside Assistance

24-hour emergency road service is available to you throughout your 3-year/36,000-mile warranty term. Services include jump starting, flat tire and lockout assistance, towing, and more (limitations apply). Call (866) 372-5139.

Warranty Coverages

Below is a brief summary of the warranties covering your new vehicle.

New Vehicle Limited Warranty: Covers your new vehicle against defects in materials and workmanship.

Powertrain Limited Warranty: The powertrain in your new Honda is covered by a limited warranty. The duration of warranty coverage may vary.

High Voltage Battery Capacity Warranty: Gradual capacity loss of the high voltage battery is expected and not covered under warranty. Greater than normal degradation is covered and can be determined by an authorized Honda Clarity Electric dealer.

Seat Belt Limited Warranty: Covers seat belts that fail to function properly.

Rust Perforation Limited Warranty: Covers all exterior body panels that rust through from the inside.

Accessory Limited Warranty: Covers Honda accessories.

Replacement Parts Limited Warranty: Covers all Honda replacement parts against defects in materials and workmanship.

Replacement 12-Volt Battery Limited Warranty: Provides prorated coverage for a replacement battery purchased from an authorized Honda Clarity Electric dealer.

Restrictions and exclusions apply to all these warranties. See the Warranty Booklet on the Warranty CD or at ev.owners.honda.com for complete descriptions of each warranty, including time, mileage, and other conditional limitations.

Your vehicle's original tires are covered by their manufacturer. Tire warranty information can be found on the Warranty CD or at ev.owners.honda.com.

EPA Contact Information

An owner may obtain further information concerning emission warranties or report violations of the terms of the emission warranties by contacting:

U.S. Environmental Protection Agency
Office of Transportation and Air
Quality
Compliance Division,
Light-Duty Vehicles Group
Attn: Warranty Complaints
2000 Traverwood Drive
Ann Arbor, MI 48105
Email: complianceinfo@epa.gov

VOICE COMMAND INDEX

Learn about all available voice commands to help you operate the vehicle. The system recognizes only the commands listed here.

Press the Talk button before you say a command.

■ Voice Portal Commands

When you press the Talk button, the Voice Portal screen appears. Say one of the options and follow the system prompts.

- Phone call
- Music search
- Audio
- Climate control
- Navigation
- Voice setting
- Voice help
- What is today's date?
- What time is it?

■ Navigation Commands

The system accepts these commands on most screens. You only need to press the Talk button once for navigation commands.

- View map
- Find place
- Find category
- Find intersection
- Recently found
- Go home
- Find address
- Find city
- Find saved places

■ Climate Control Commands

The system accepts these commands on most screens.

- Climate control on**
- Climate control off**
- Air conditioner on**
- Air conditioner off**
- Defrost on**
- Defrost off**
- Fan speed # (#: 1 to 7)
- Temperature # degrees (#: 57 to 87°F)
- Temperature max heat
- Temperature max cool

■ Phone Commands

The system accepts these commands on most screens. Not available during use of Apple Car Play or Android Auto.

- Call by number
- Call by name
- Call (number)
- Call (name)

***These commands toggle the function on and off, so the command may not match your intended action.*

Audio Commands

The system accepts these commands on most screens. Audio volume levels cannot be controlled using voice commands.

FM/AM Radio Commands

- Audio on**
- Audio off**
- Radio FM
- Radio AM
- Radio tune to # FM (#: frequency, e.g., 95.5)
- Radio tune to # AM (#: frequency, e.g., 1020)
- Radio FM preset # (#: 1 to 12)
- Radio AM preset # (#: 1 to 6)

SiriusXM Radio Commands

- Radio SXM
- SXM channel # (#: 0 to 999)
- SXM channel (channel name)
- Radio SXM preset # (#: 1 to 12)

Pandora Commands***

- Pandora
- Pandora play

Song By Voice™ Commands***

Available for tracks stored on an iPod or USB device.

- Music search
- List album (specify album)
- List artist (specify artist)
- List composer (specify composer)
- List genre (specify genre)
- List playlist (specify playlist)
- Play album (specify album)
- Play artist (specify artist)
- Play composer (specify

Disc (CD) Commands

- Disc
- Disc play
- Disc play track # (#: 1 to 30)

USB Commands***

- USB
- USB play
- USB play track # (#: 1 to 30)

iPod Commands***

- iPod
- iPod play
- iPod play track # (#: 1-30)

Bluetooth Audio Commands

- Bluetooth audio play (may not work on all phones)

AUX Commands

- Aux audio play

- composer)
- Play genre (specify genre)
- Play playlist (specify playlist)
- Play song (specify song)
- What/Who am I listening to?
- Who is this?
- What's playing?
- Who's playing?
- What album is this?

**These commands toggle the function on and off, so the command may not match your intended action.

***Not available during use of Apple CarPlay.

INDEX

About Battery Electric Vehicles	4	Bluetooth Handsfreelink (HFL).....	72
ABS.....	31	E-Mail.....	78
ACC.....	31	HFL Controls.....	72
Accessory Power Socket.....	56	HondaLink Assist	77
Acoustic Vehicle Alerting.....	96	Making a Call	75
Adaptive Cruise Control (ACC) with Low Speed Follow (LSF) ...	31, 103	Phonebook	75
Address.....	83	SMS Text Messaging	78
Advanced Airbags	12	Speed Dial	76
Airbags.....	12	Talk Button Tips	73
Airbag Care	18	Brake Assist System.....	97
Airbag System Components.....	17	Brake Fluid	133
Airbag System Indicators.....	15	Brake system.....	31
Ambient Meter.....	100	Braking	
Android Auto.....	64	Automatic Brake Hold.....	98
Anti-lock Brake System (ABS)....	31, 97	Foot brake.....	97
Apple CarPlay	62	Brightness Control	42
Audio Commands.....	148	CarPlay.....	62
Audio Operation	56	Car wash mode.....	95
Android Auto.....	64	Charging system.....	30
Apple CarPlay.....	62	Childproof Door Locks.....	40
Bluetooth Audio	70	Child Safety	19
FM/AM Radio.....	66	Child Seat	21
HondaLink.....	60	Adding Security with a Tether	26
iPod.....	68	LATCH-Compatible Child Seat.....	22
Pandora	71	Climate Control Commands.....	147
SiriusXM Radio.....	67	Climate Control System.....	53
Sound	58	CMBS	33
Steering Wheel Controls	57	Collision Mitigation Braking System (CMBS)	31, 109
USB Flash Drive	69	Compact Disc (CD) Commands.....	148
USB Port.....	56	Condition Indicators	32
Automatic Brake Hold.....	98	Power System	32
Automatic Dimming		Contact Us.....	145
Rearview Mirror	51	Customer Information.....	144
Auto park mode	95	Customized Features	55
AUX Commands.....	148	Dashboard and Other Controls	3
Battery	134	Destination	83
Bluetooth Audio.....	70	Dialing a Number	75
Bluetooth Audio Commands	148	Door Mirrors	51

Door Operation39
 Doors.....37
 DOT Tire Quality Grading141
 Driver Information Interface (DII) ...34
 Driver's Seat.....46
 Driving.....89
 Accessory Mode.....94
 Acoustic Vehicle Alerting.....96
 Adaptive Cruise Control (ACC) with Low Speed Follow (LSF)103
 Collision Mitigation Braking System (CMBS)109
 Lane Keeping Assist System (LKAS)106
 LaneWatch™110
 Maximum Load Limit91
 Multi-View Rear Camera112
 Power Mode94
 Remote Power System Start.....93
 Road Departure Mitigation (RDM) ...107
 Shifting.....95
 SPORT Mode102
 START/STOP button.....94
 Towing a Trailer92
 Vehicle Stability Assist (VSA®)....102
 Wiper Blades135
 Driving Position Memory System.....50
 Eco Assist System.....100
 Ambient Meter100
 Electric Power Steering (EPS)31
 E-Mail.....78
 Emergency Power System Stop118
 Emergency Towing118
 Exterior lights.....33, 42
 Fastening a Seat Belt10
 Floor mats.....46
 FM/AM Radio.....66
 FM/AM Radio Commands.....148
 Foot Brake97
 Frequently Asked Questions144
 Front Airbags (SRS)12
 Front Door Inner Handle39
 Fuse Locations.....122
 Garage Opener52
 Hang-Up/Back button.....72
 Hazards.....33
 Headlight-Wiper Integration.....43
 Head Restraints.....47
 HFL Controls.....72
 High beams33
 Home Address.....83
 HomeLink Universal Transceiver.....52
 HondaLink.....60
 HondaLink Assist.....77
 Honda Roadside Assistance145
 Hood130
 Immobilizer31
 Instrument Panel.....30
 Interior Lights.....42
 iPod.....68
 iPod Commands.....148
 Key.....36
 Keyless Access System.....38
 Lane Keeping Assist System (LKAS)31, 106
 LaneWatch110
 Lap/Shoulder Seat Belts8
 LATCH-Compatible Child Seat.....22
 Lights.....33, 42
 Exterior lights.....42
 LKAS.....31
 Lock Tab.....39
 Low tire pressure32
 Maintenance.....127
 Battery134
 Brake Fluid133
 Maintenance Minder128
 Service Codes129
 Under the Hood130
 Window Washer Fluid.....134
 Making a Call.....75
 Malfunction Indicators.....30
 Brake system.....30
 Road Departure Mitigation (RDM) ...31
 Vehicle Stability Assist (VSA)31
 Map Legend.....87

Master Door Lock Switch.....39
 Maximum Load Limit.....91
 Mirrors51
 Multi-View Rear Camera112
 Music search.....148
 Navigation80
 Display and Controls82
 Entering a Destination.....83
 Home Address.....83
 Map Legend87
 Place Category85
 Recent Places85
 Routing.....87
 Saved Places.....86
 Steering Wheel Controls80
 Street Address84
 System Guidance Volume.....81
 Talk Button Tips80
 Traffic88
 Turn-by-turn directions87
 Navigation Commands147
 One-Touch Turn Signal.....44
 Opening the Hood131
 Overheating.....117
 Pandora71
 Pandora Commands148
 Parking brake.....32, 98
 Passenger Airbag Off Indicator.....16
 Phone74
 Phonebook75
 Pick-Up button.....72
 Place Category85
 Power Door Mirrors.....51
 Power Mode94
 Power Window Lock41
 Power Window Operation41
 Radio66
 Ready indicator32
 Rear Camera112
 Recent Places.....85
 Remote Battery Strength.....117
 Remote Power System Start.....93
 Reporting Safety Defects29
 Road Departure Mitigation (RDM) ...107
 Roadside Assistance.....145
 Routing.....87
 Safety Information7
 Airbags.....12
 Child Safety.....19
 Reporting Safety Defects29
 Safety Label Locations.....29
 Safety Messages7
 Seat Belts8
 Saved Places.....86
 Seat belt reminder32
 Seat Belts8
 Fastening a Seat Belt10
 Seat Belt Inspection.....9
 Shoulder Anchor.....11
 Seat Heaters54
 Seating
 Rear seats49
 Seats45
 SEL/RESET button35
 Service Codes.....129
 Shifting.....95
 Electronic Gear Selector95
 Shoulder Anchor11
 Side Airbags.....13
 Side Curtain Airbags.....14
 Siri Eyes Free79
 SiriusXM Radio.....67
 SiriusXM Radio Commands.....148
 Smart Entry system.....37
 SMS Text Messaging78
 Song By Voice Commands148
 Sound58
 Specifications.....143
 Speed Dial76
 SPORT mode.....33, 102
 SRS (Supplemental Restraint) Indicator15
 START/STOP button.....94
 Steering Wheel.....50

TABLE OF CONTENTS

VISUAL INDEX

SAFETY INFORMATION

INSTRUMENT PANEL

VEHICLE CONTROLS

AUDIO AND CONNECTIVITY

BLUETOOTH® HANDS-FREE LINK®

HONDA LINK®

NAVIGATION

DRIVING

HANDLING THE UNEXPECTED

MAINTENANCE

SPECIFICATIONS

CUSTOMER INFORMATION

VOICE COMMAND INDEX

INDEX

Steering Wheel and Nearby Controls	1, 2	TPMS.....	31, 119, 120
Steering Wheel Controls.....	57, 80	Traffic	88
Street Address.....	84	Trip Computer	35
Supplemental Restraint System (SRS)	30	Troubleshooting.....	144
System Guidance Volume.....	81	Trunk.....	37
System message	32	Trunk Opener	40
Talk button	72	Turn-by-turn directions	87
Talk Button Tips	73, 80	Turn signals.....	33, 44
Text Messaging	78	Under the Hood	130
Tire Information	136	USB Commands.....	148
DOT Tire Quality Grading	141	USB Flash Drive.....	69
Inflation Guidelines.....	136	USB Port.....	56
Tire and Wheel Replacement	138	Vehicle	143
Tire Chains.....	139	Vehicle Controls	36
Tire Identification Number (TIN) ...	140	Vehicle Stability Assist (VSA)	102
Tire Labeling.....	140	Visual Index.....	1
Tire Service Life.....	139	Voice Command Index	147
Tire Terminology.....	140	Voice Portal Commands.....	147
Tire Pressure Monitoring System (TPMS).....	31, 119	VSA.....	31, 33
Tire Repair Kit	121	Walk Away Auto Lock	38
Tires	143	Warranty Coverages	146
Towing.....	118	Wi-Fi Connection.....	62
Towing a Trailer	92	Window.....	41
		Window Washer Fluid	134
		Wiper Blades	135
		Wiper Operation.....	43

DISCLOSURES

■ California Proposition 65 Warning

⚠️WARNING: Operating, servicing and maintaining a passenger vehicle or offroad vehicle can expose you to chemicals including engine exhaust, carbon monoxide, phthalates, and lead, which are known to the State of California to cause cancer and birth defects or other reproductive harm. To minimize exposure, avoid breathing exhaust, do not idle the engine except as necessary, service your vehicle in a well-ventilated area and wear gloves or wash your hands frequently when servicing your vehicle. For more information go to www.P65Warnings.ca.gov/passenger-vehicle.

■ California Perchlorate Contamination Prevention Act

The airbags, seat belt tensioners, and CR-type batteries in this vehicle may contain perchlorate materials—special handling may apply. See www.dtsc.ca.gov/hazardouswaste/perchlorate/ for more information.

■ Privacy Notice

This vehicle may share location and usage information. To manage this setting, visit www.hondalink.com/vehicle-data-choices.



ev.owners.honda.com (U.S.)

31TRVG11
OG-08999
00X31-TRV-G111

2018 Honda Clarity Electric Owner's Guide
©2018 Honda Motor Co., Ltd. — All Rights Reserved

Printed in Japan