



ACCORD

31TVAG10
OG10276
00X31-TVA-G101

owners.honda.com (U.S.)
myhonda.ca (Canada)
2019 Honda ACCORD Owner's Guide
© 2018 Honda Motor Co., Ltd. — All Rights Reserved

Printed in U.S.A.



2019
OWNER'S GUIDE

DISCLOSURES

Devices That Emit Radio Waves

Each radio frequency device installed in the vehicle conforms to the requirements and standards of the regulation listed below:

As required by the FCC:

This device complies with Part 15 of the FCC rules. Operation is subject to the following two conditions: (1) This device may not cause harmful interference, and (2) this device must accept any interference received, including interference that may cause undesired operation.

Changes or modifications not expressly approved by the party responsible for compliance could void the user's authority to operate the equipment.

As required by Industry Canada:

This device complies with Industry Canada licence-exempt RSS standard(s). Operation is subject to the following two conditions: (1) this device may not cause interference, and (2) this device must accept any interference, including interference that may cause undesired operation of the device.

Disclaimer

The information and data contained herein are believed to be accurate and reliable. American Honda Motor Co., Inc. makes no warranty of any kind and accepts no responsibility for the results obtained through application of this information.

Privacy Notice

This vehicle may share location and usage information. To manage this setting, visit www.hondalink.com/vehicle-data-choices.

Event Data Recorders

This vehicle is equipped with an event data recorder (EDR). The main purpose of an EDR is to record, in certain crash or near crash-like situations, such as an airbag deployment or hitting a road obstacle, data that will assist in understanding how a vehicle's systems performed. **The EDR is designed to record data related to vehicle dynamics and safety systems for a short period of time, typically 30 seconds or less. The EDR in this vehicle is designed to record such data as:**

- **How various systems in your vehicle were operating;**
- **Whether or not the driver and passenger safety belts were buckled/fastened;**

- **How far (if at all) the driver was depressing the accelerator and/or brake pedal; and,**
- **How fast the vehicle was traveling.**

These data can help provide a better understanding of the circumstances in which crashes and injuries occur. NOTE: EDR data are recorded by your vehicle only if a non-trivial crash situation occurs; no data are recorded by the EDR under normal driving conditions and no personal data (e.g., name, gender, age, and crash location) are recorded. However, other parties, such as law enforcement, could combine the EDR data with the type of personally identifying data routinely acquired during a crash investigation.

To read data recorded by an EDR, special equipment is required, and access to the vehicle or the EDR is needed. In addition to the vehicle manufacturer, other parties such as law enforcement that have the special equipment can read the information if they have access to the vehicle or the EDR.

The data belong to the vehicle owner and may not be accessed by anyone else except as legally required or with the permission of the vehicle owner.

Service Diagnostic Recorders

This vehicle is equipped with service-related devices that record information about powertrain performance. The data can be used to verify emissions law requirements and/or help technicians diagnose and solve service problems. It may also be combined with data from other sources for research purposes, but it remains confidential. Some diagnostic and maintenance information is uploaded to Honda upon vehicle start up.

INTRODUCTION

This Owner's Guide is intended to help you quickly get acquainted with your **2019 ACCORD SEDAN**. It provides basic information and instructions on technology and convenience features, as well as emergency procedures and how to get assistance.

This guide is for vehicles sold in the United States and Canada. It covers all models, so you may find descriptions of features and equipment that are not in your vehicle. Images throughout this guide represent features and equipment that are available on some, but not all, models.

This guide is not intended to be a substitute for the Owner's Manual. Visit owners.honda.com (U.S.) or myhonda.ca (Canada) to view the most current Owner's Manual, Navigation Manual, Vehicle Warranty, and the tire manufactures' warranties.

If you are the first registered owner of your vehicle, you may request a complimentary printed copy of the Owner's Manual, Navigation Manual, or Vehicle Warranty within the first six months of vehicle purchase. To request a copy, visit owners.honda.com and create or log in to your account. In Canada, please request a copy from your Honda dealer.

American Honda Motor Co., Inc. strives to be proactive in protecting our environment and natural resources. By using electronic delivery for a considerable portion of the information typically found in a vehicle Owner's Manual, we are further reducing our impact on the environment.

Honda Automobile Customer Service

Your authorized Honda dealer should be able to answer any questions you have about your vehicle. However, if you are dissatisfied with the information you receive, you can call Honda Automobile Customer Service.

Call (800) 999-1009 (U.S.) or (888) 946-6329 (Canada)

Honda Roadside Assistance

24-hour emergency road service is available to you in the United States and Canada throughout your 3-year/36,000-mile warranty term. Services include jump starting, flat tire and lockout assistance, towing, and more (limitations apply).

Call (866) 864-5211 (U.S.) or (800) 465-7587 (Canada)

TABLE OF CONTENTS

VISUAL INDEX	1	Front Seat Heaters- If equipped and Ventilation- If equipped	51
Steering Wheel and Nearby Controls.....	1	Customized Features.....	51
Dashboard and Nearby Controls.....	2	Setting the Clock.....	53
SAFETY INFORMATION	3	AUDIO AND CONNECTIVITY	54
Important Safety Information.....	3	Basic Audio Operation.....	54
Seat Belts.....	4	Color Audio System.....	57
Airbags.....	7	Display Audio System.....	57
Child Safety.....	13	HondaLink®	58
Safety Label Locations.....	22	HondaLink® Assist- If equipped.....	58
Reporting Safety Defects.....	22	Near Field Communication (NFC)- If equipped - Models with Display Audio.....	59
INSTRUMENT PANEL	24	Apple CarPlay™	61
Malfunction Indicators.....	24	Android Auto™	62
Condition Indicators.....	25	Wi-Fi Connection- If equipped.....	63
On/Off Indicators.....	26	System Updates.....	63
Driver Information Interface.....	28	FM/AM Radio.....	65
Head-Up Display- If equipped.....	28	SiriusXM® - If equipped.....	66
VEHICLE CONTROLS	30	iPod®	67
Using the Remote Transmitter.....	30	USB Flash Drive.....	69
Smart Entry System- If equipped....	30	Bluetooth® Audio.....	71
Door Operation.....	32	BLUETOOTH® HANDSFREELINK® (HFL)	75
Power Window Operation.....	34	Basic HFL Operation.....	75
Power Moonroof- If equipped Operation.....	35	Pairing a Phone.....	77
Interior and Exterior Lights.....	35	Making a Call.....	78
One-Touch Turn Signal.....	37	SMS Text Messaging and E-Mail- If equipped.....	83
Auto High Beam.....	37	Siri Eyes Free™	83
Wiper Operation.....	39	NAVIGATION	86
Adjusting the Front Seats.....	41	Basic Navigation Operation.....	86
Driving Position Memory System- If equipped.....	43	Entering Your Destination.....	87
Adjusting the Head Restraints.....	44	Routing.....	88
Adjusting the Rear Seats.....	45	DRIVING	90
Floor Mats.....	46	Before Driving.....	90
Adjusting the Steering Wheel.....	47	Maximum Load Limit.....	91
Adjusting the Mirrors.....	47	Towing a Trailer.....	93
Homelink® Universal Transceiver- If equipped.....	49	Towing Behind A Motorhome.....	95
Climate Control System.....	50		

Remote Engine Start with Vehicle Feedback- If equipped.....95

Starting to Drive.....97

Shifting.....100

Braking.....104

Ambient Meter.....107

Vehicle Stability Assist® (VSA®) System.....108

Honda Sensing®.....109

Adaptive Cruise Control (ACC)- If equipped with Low Speed Follow- If equipped.....110

Lane Keeping Assist System (LKAS).....113

Road Departure Mitigation (RDM).....115

Traffic Sign Recognition System...116

Collision Mitigation Braking System™ (CMBS™).....117

Blind Spot Information System- If equipped.....118

LaneWatch™ - If equipped,.....119

Parking Sensor System- If equipped.....120

Cross Traffic Monitor- If equipped.....121

Multi-View Rear Camera.....122

Improving Fuel Economy and Reducing CO₂ Emissions.....123

Refueling.....123

HANDLING THE UNEXPECTED.....126

Shift Lever- If equipped Does Not Move.....126

Smart Entry System Battery Strength.....126

Jump Starting.....127

Overheating.....128

Emergency Engine Stop129

Emergency Towing.....130

Tire Pressure Monitoring System (TPMS).....130

Changing a Tire.....131

Fuse Locations.....136

MAINTENANCE.....138

Safety Precautions.....138

Maintenance Minder™.....139

Under the Hood.....143

Engine Oil.....144

Engine Coolant.....147

Checking the Battery.....148

Window Washer Fluid.....149

Brake/Clutch- If equipped Fluid...149

Changing Wiper Blades.....150

Tire Information.....151

Tire Labeling.....154

DOT Tire Quality Grading.....155

Air Conditioning.....156

Testing of Readiness Codes.....156

SPECIFICATIONS.....158

CUSTOMER INFORMATION.....162

Frequently Asked Questions/ Troubleshooting.....162

Contact Us.....163

Warranty Coverages.....163

EPA Contact Information.....164

VOICE COMMAND INDEX.....165

Voice Portal Commands.....165

Phone Commands.....165

Audio Commands- If equipped.....165

Navigation Commands- Models with navigation only.....165

INDEX.....166

VISUAL INDEX

Quickly locate items in the vehicle's interior.

Steering Wheel and Nearby Controls

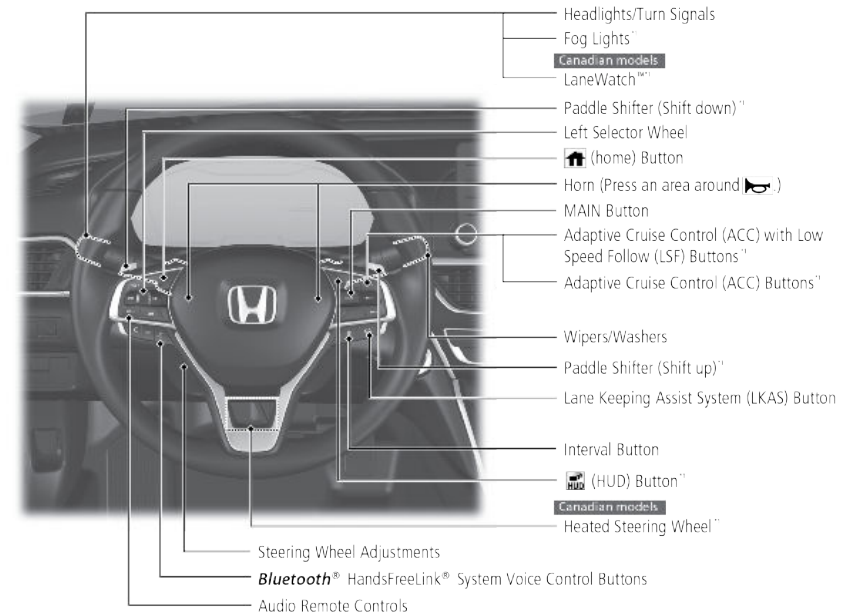

*1 - If equipped

Dashboard and Nearby Controls

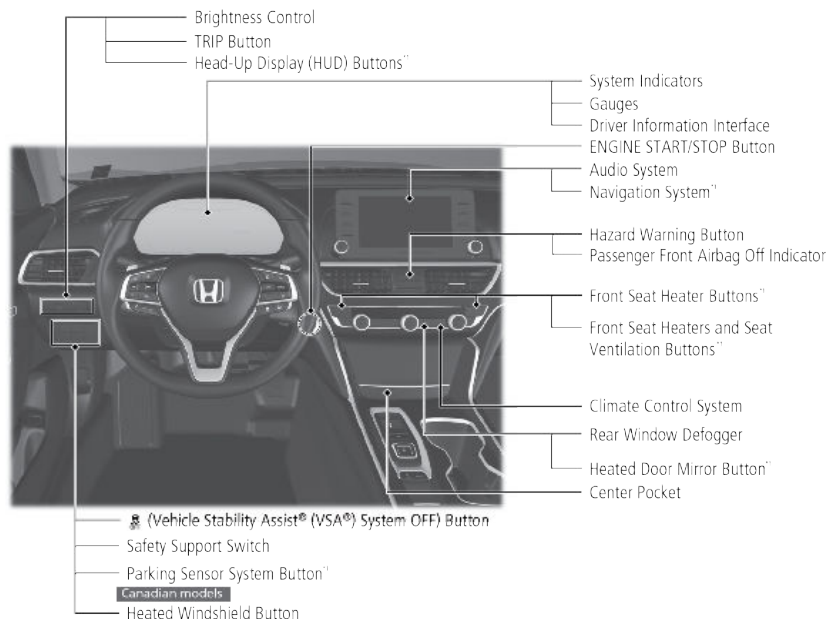

SAFETY INFORMATION

Your safety--and the safety of others--is very important and operating this vehicle safely is an important responsibility. While we strive to help you make informed decisions about safety, it is not practical or possible to warn you about all the hazards associated with operating or maintaining your vehicle. Therefore, you must use your own good judgment.

Important Safety Information

This guide explains many of your vehicle's safety features and how to use them. Please read this information carefully. Following the instructions below will also help to keep you and your passengers safe.

■ Important Safety Precautions

- Always wear your seat belt.
- Secure all children in the proper restraint system.
- Be aware of airbag hazards.
- Don't drink and drive.
- Pay appropriate attention to the task of driving safely.
- Control your speed.
- Keep your vehicle in safe condition.

Engaging in cell phone conversation or other activities that keep you from paying close attention to the road, other vehicles, and pedestrians could lead to a crash. Remember, situations can change quickly, and only you can decide when it is safe to divert some attention away from driving.

■ Safety Messages

When you see the following messages throughout this guide, pay close attention.

- ▲ DANGER** You WILL be KILLED or SERIOUSLY HURT if you don't follow instructions.
- ▲ WARNING** You CAN be KILLED or SERIOUSLY HURT if you don't follow instructions.
- ▲ CAUTION** You CAN be HURT if you don't follow instructions.
- NOTICE** This information is intended to help you avoid damage to your vehicle, other property, or the environment.

■ Carbon Monoxide Gas

The engine exhaust from this vehicle contains carbon monoxide, a colorless, odorless, and highly toxic gas. As long as you properly maintain your vehicle and follow the instructions set forth below, you will not accumulate dangerous levels of carbon monoxide gas in the vehicle interior.

Have the exhaust system inspected for leaks whenever:

- The exhaust system is making an unusual noise.
- The exhaust system may have been damaged.
- The vehicle is raised for an oil change.

When you operate a vehicle with the trunk open, airflow can pull exhaust gas into the interior and create a hazardous condition. If you must drive with the trunk open, open all the windows and set the climate control system as shown below:

1. Select the fresh air mode.
2. Select the  mode.
3. Set the fan speed to high.
4. Set the temperature control to a comfortable setting.

Adjust the climate control system in the same manner if you sit in your parked vehicle with the engine running.

WARNING

Carbon monoxide gas is toxic. Breathing it can cause unconsciousness and even kill you. Avoid any enclosed areas or activities that expose you to carbon monoxide.

An enclosed area such as a garage can quickly fill up with carbon monoxide gas. Do not run the engine with the garage door closed. Even when the garage door is open, drive out of the garage immediately after starting the engine.

Seat Belts

A seat belt is your best protection in all types of collisions. Airbags are designed to supplement seat belts, not replace them. So even though your vehicle is equipped with airbags, make sure you and your passengers always wear your seat belts and wear them properly.

■ Lap/Shoulder Seat Belts

All five seating positions are equipped with lap/shoulder seat belts with emergency locking retractors. In normal driving, the retractor lets you move freely while keeping some tension on the belt. During a collision or sudden

stop, the retractor locks to restrain your body. The front passenger's and rear seat belts also have a lockable retractor for use with child seats.

■ Proper Use of Seat Belts

Follow these guidelines for proper use:

- All occupants should sit upright, well back in the seat, and remain in the position for the duration of the trip. Slouching and leaning reduces the effectiveness of the belt and can increase the chance of serious injury in a crash.
- Never place the shoulder part of a lap/shoulder seat belt under your arm or behind your back. This could cause very serious injuries in a crash.
- Two people should never use the same seat belt. If they do, they could be very seriously injured in a crash.
- Do not put any accessories on the seat belts. Devices intended to improve comfort or reposition the shoulder part of a seat belt can reduce the protective capability and increase the chance of serious injury in a crash.
- No one should sit in a seat with an inoperative seat belt or one that does not appear to be working correctly. Using a seat belt that is not working properly may not protect the occupant in a crash. Have a dealer check the belt as soon as possible.

WARNING

Not wearing a seat belt properly increases the chance of a serious injury or death in a crash, even though your vehicle has airbags.

Be sure you and your passengers always wear seat belts and wear them properly.

■ Seat Belt Inspection

Regularly check the condition of your seat belts as follows:

- Pull each belt out fully and look for frays, cuts, burns, and wear.
- Check that the latch plates and buckles work smoothly and the belts retract easily. If a belt does not retract easily, cleaning the belt may correct the problem. Only use mild soap and warm water. Do not use bleach or cleaning solvents. Make sure the belt is completely dry before allowing it to retract.

Any belt that is not in good condition or working properly will not provide proper protection and should be replaced as soon as possible.

A belt that has been worn during a crash may not provide the same level of protection in a subsequent crash. Have your seat belts inspected by a dealer after any collision.

⚠ WARNING

Not checking or maintaining seat belts can result in serious injury or death if the seat belts do not work properly when needed.

Check your seat belts regularly and have any problem corrected as soon as possible.

■ Fastening a Seat Belt

Adjust your seat to the proper position and then follow the steps below:

1. Pull the seat belt out slowly.
2. Insert the latch plate into the buckle, then tug on the belt to make sure the buckle is secure. Make sure that the belt is not twisted or caught on anything.
3. Position the lap part of the belt as low as possible across your hips, then pull up on the shoulder part of the belt so the lap part fits snugly. This lets your strong pelvic bones take the force of a crash and reduces the chance of internal injuries.
4. If necessary, pull up on the belt again to remove any slack, then make sure that the belt rests across the center of your chest and over your shoulder. This spreads the forces of a crash over the strongest bones in your upper body.

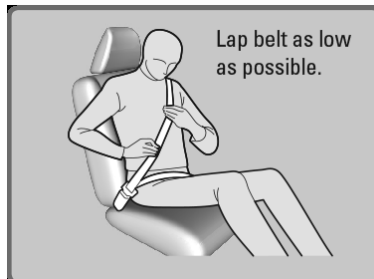
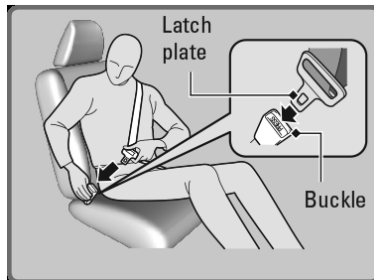
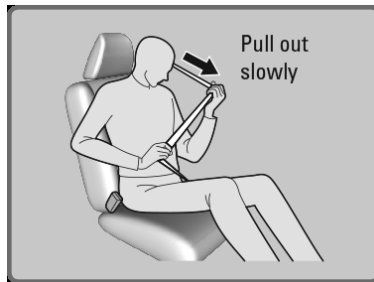

To release the belt, push the red PRESS button then guide the belt by hand until it has retracted completely.

⚠ WARNING

Improperly positioning the seat belt can cause serious injury or death in a crash.

Make sure all seat belts are properly positioned before driving.

■ Adjusting the Shoulder Anchor

The front seats have adjustable shoulder anchors to accommodate taller and shorter occupants.

1. Move the anchor up and down while holding the release button.
2. Position the anchor so that the belt rests across the center of your chest and over your shoulder.



Airbags

Your vehicle is equipped with several types of airbags: front airbags, side airbags, and side curtain airbags.

■ Front Airbags (SRS)

The front SRS airbags inflate in a moderate-to-severe frontal collision to help protect the head and chest of the driver and/or front passenger. They are housed in the center of the steering wheel for the driver and in the dashboard for the front passenger. Both airbags are marked **SRS AIRBAG**. SRS (Supplemental Restraint System) indicates that the airbags are designed to supplement seat belts, not replace them. Seat belts are the occupant's primary restraint system.

Front Knee Airbags

The knee SRS airbags inflate in a moderate-to-severe front collision to help keep the driver and/or front passenger in the proper position and to help maximize the benefit provided by the vehicle's other safety features.

■ Advanced Airbags

The airbags have advanced features to help reduce the likelihood of airbag related injuries to smaller occupants.

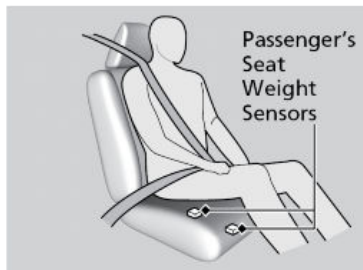
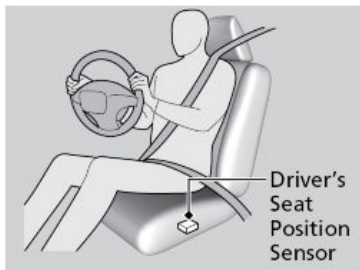

The driver's advanced airbag system includes a seat position sensor. Based on information from this sensor and the severity of the impact, the advanced airbag system determines the optimal deployment of the driver's airbag.

The front passenger's advanced airbag system has weight sensors.

We advise against allowing a child age 12 or under to ride in the front passenger's seat. However, **if you do allow a child age 12 or under to ride in the front passenger's seat**, note that the system will automatically turn off the front passenger's airbag if the sensors detect that the child is approximately 65 lbs (29 kg) or less.

For the advanced airbags to work properly:

- Do not spill any liquid on or under the seats.
- Do not put any object under the passenger's seat.
- Make sure any objects are positioned properly on the floor. Improperly positioned objects can interfere with the advanced airbag sensors.
- All occupants should sit upright and wear their seat belts properly.
- Do not cover the passenger's side dashboard with a cloth, towel, cover, etc.

■ Side Airbags

The side airbags help protect the upper torso and pelvis of the driver or a front passenger during a moderate-to-severe side impact. They are housed in the outside edge of the driver's and front passenger's seat-backs. Both are marked **SIDE AIRBAG**.

■ Side Curtain Airbags

Side curtain airbags help protect the heads of the driver and passengers in outer seating positions during a moderate-to-severe side impact. The side curtain airbags equipped in this vehicle are also designed to help reduce the likelihood of partial and complete ejection of vehicle occupants through side windows in crashes, particularly rollover crashes.

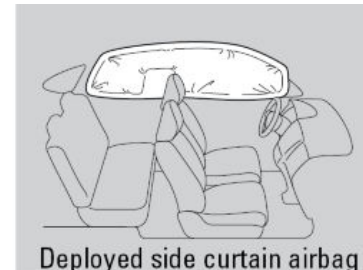
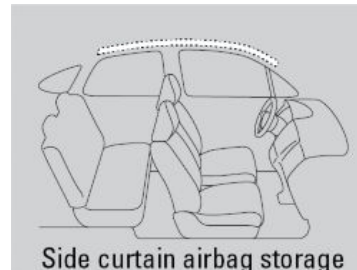

The side curtain airbags are located in the ceiling above the side windows on both sides of the vehicle.

The side curtain airbags are designed to deploy in a rollover or moderate-to-severe side impact. If the SRS control unit senses that your vehicle is about to roll over, it immediately deploys both side curtain airbags and activates both front seat belt tensioners. If the impact is on the passenger's side, the passenger's side curtain airbag will inflate even if there are no occupants on that side of the vehicle.

To get the best protection from the side curtain airbags, occupants should wear their seat belts properly and sit upright and well back in their seats.

Do not attach any objects to the side windows or roof pillars, as they can interfere with the proper operation of the side curtain airbags.

When side curtain airbags deploy in a frontal collision

One or both side curtain airbags may inflate in a moderate-to-severe angled frontal collision.

■ Important Facts About Your Airbags

Always wear your seat belt properly, sit upright, and as far back from the steering wheel as possible while allowing full control of the vehicle. A front passenger should move their seat as far back from the dashboard as possible.

Do not place hard or sharp objects between yourself and a front airbag.

Carrying hard or sharp objects on your lap, or driving with a pipe or other sharp object in your mouth, can result in injuries if your front airbag inflates.

Do not attach or place objects on the front airbag covers. Objects on the covers marked **SRS AIRBAG** could interfere with the proper operation of the airbags or be propelled inside the vehicle and hurt someone if the airbags inflate.

Do not attach accessories on or near the side airbags. They can interfere with the proper operation of the airbags or hurt someone if an airbag inflates.

Do not attach any objects to the side windows or roof pillars. They can interfere with the proper operation of the side curtain airbags.

Do not cover or replace the front seat-back covers. This can prevent your side airbags from properly deploying during a side impact.

⚠ WARNING

An open glove box can cause serious injury to your passenger in a crash, even if the passenger is wearing the seat belt.

Always keep the glove box closed while driving.

■ Airbag System Indicators

If a problem occurs in the airbag system, the SRS indicator comes on and a message appears on the Driver Information Interface .

Supplemental Restraint System (SRS) Indicator

If the indicator comes on at any other time besides vehicle start-up or does not come on at all, have the system checked by a dealer as soon as possible. If you don't, your airbags and seat belt tensioners may not work properly when they are needed.



⚠ WARNING

Ignoring the SRS indicator can result in serious injury or death if the airbag systems or tensioners do not work properly.

Have your vehicle checked by a dealer as soon as possible if the SRS indicator alerts you to a possible problem.

Passenger Airbag Off Indicator

The indicator comes on to alert you that the front passenger's front airbag has been turned off. This occurs when the front passenger's weight sensors detect 65 lbs (29 kg) or less, the weight of an infant or small child, on the seat.

Children age 12 or under should always ride properly restrained in a back seat.

If the front passenger's seat is empty, the indicator will come on and, in the event of a crash, the front passenger's airbag will not deploy. The front passenger's knee airbag will not deploy either.

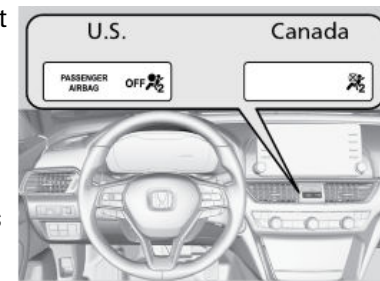

To ensure the passenger is detected properly, confirm that:

- There is no child seat or other object pressing against the rear of the seat-back.
- There is no rear passenger pushing or pulling on the back of the front passenger's seat.
- The front seat or seat-back is not forced back against an object on the seat or floor behind it.
- There is no object placed under or beside the front passenger's seat.
- The occupant is sitting in an upright position and the seat-back is not excessively reclined.
- The occupant is not leaning against the door or center console.
- The occupant's feet are placed on the floor in front of them.
- There are no objects hanging from the front passenger's seat.
- Only small, lightweight objects are in the seat-back pocket.

If none of these conditions exist, have your vehicle checked by a dealer as soon as possible.

The passenger airbag off indicator may come on and go off repeatedly if the total weight on the seat is near the airbag cutoff threshold.

■ Airbag System Components

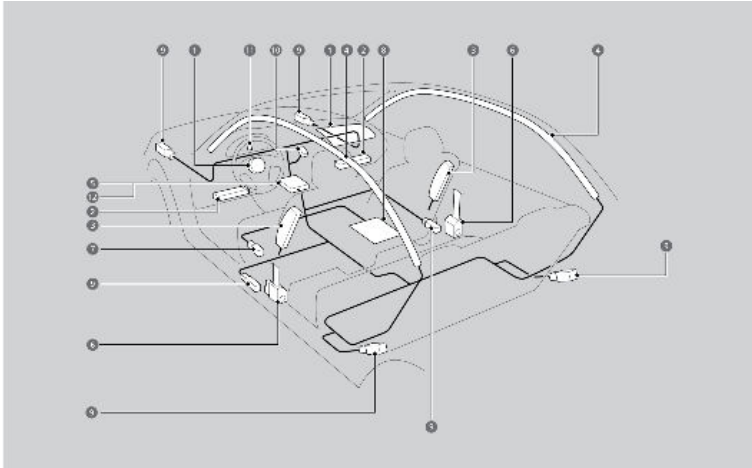

1. Two SRS (Supplemental Restraint System) front airbags. The driver's airbag is stored in the center of the steering wheel; the front passenger's airbag is stored in the dashboard. Both are marked **SRS AIRBAG**.
2. Two front knee airbags. The driver's knee airbag is stored under the steering column; the front passenger's knee airbag is stored under the glove box. Both are marked **SRS AIRBAG**.
3. Two side airbags, one for the driver and one for a front passenger. The airbags are stored in the outer edges of the seat-backs. Both are marked **SIDE AIRBAG**.
4. Two side curtain airbags, one for each side of the vehicle. The airbags are stored in the ceiling, above the side windows. The front and rear pillars are marked **SIDE CURTAIN AIRBAG**.
5. An electronic control unit that, when the vehicle is on, continually monitors information about the various impact sensors, seat and buckle sensors, rollover sensor, airbag activators, seat belt tensioners, and other vehicle information. During a crash event the unit can record such information.
6. Automatic front seat belt tensioners. The driver's and front passenger's seat belt buckles incorporate sensors that detect whether or not the belts are fastened.
7. A driver's seat position sensor. This sensor determines the optimal force at which the airbag will deploy in a crash.
8. Weight sensors in the front passenger's seat. The front passenger's airbag will be turned off if the weight on the seat is about 65 lbs (29 kg) or less (the weight of an infant or small child).

9. Impact sensors that can detect a moderate-to-severe front or side impact.
10. An indicator on the instrument panel that alerts you to a possible problem with the airbag system or seat belt tensioners.
11. A rollover sensor that can detect if your vehicle is about to roll over and signal the control unit to deploy both side curtain airbags.

■ Airbag Care

You do not need to, and should not, perform any maintenance on or replace any airbag system components yourself. However, you should have your vehicle inspected by a dealer in the following situations:

When the airbags have deployed

If an airbag has inflated, the control unit and other related parts must be replaced. Similarly, once an automatic seat belt tensioner has been activated, it must be replaced.

When the vehicle has been in a moderate-to-severe collision

Even if the airbags did not inflate, have your dealer inspect the following: the driver's seat position sensor, weight sensors in the passenger's seat, front seat belt tensioners, and each seat belt that was worn during the crash.

Do not remove or modify a front seat without first consulting a dealer

This would likely disable or affect the driver's seat position sensor or the weight sensors in the passenger's seat. If it is necessary to remove or modify a front seat to accommodate a person with disabilities, contact a Honda dealer. For U.S. vehicles, call Honda Automobile Customer Service at (800) 999-1009. For Canadian vehicles, call Honda Canada Customer Relations at (888) 946-6329.

Child Safety

Each year, many children are injured or killed in vehicle crashes because they are either unrestrained or not properly restrained. In fact, vehicle collisions are the number one cause of death of children ages 12 and under.

The National Highway Traffic Safety Administration and Transport Canada recommend that all children ages 12 and under be properly restrained in a rear seat. Some states or provinces/territories have laws restricting where children may ride.

To reduce the number of child deaths and injuries, every state, Canadian province, and territory requires that infants and children be properly restrained when they ride in a vehicle.

■ Protecting Child Passengers – Important Considerations

- An inflating front or side airbag can injure or kill a child sitting in the front seat.
- A child in the front seat is more likely to interfere with the driver's ability to safely control the vehicle.
- Statistics show that children of all sizes and ages are safer when they are properly restrained in a rear seat.
- Any child who is too small to wear a seat belt correctly must be restrained in an approved child seat that is properly secured to the vehicle using either the lap belt portion of the lap/shoulder belt or the lower anchors of the LATCH system.
- Never hold a child on your lap because it is impossible to protect them in the event of a collision.
- Never put a seat belt over yourself and a child. During a crash, the belt would likely press deep into the child and cause serious or fatal injuries.
- Never let two children use the same seat belt. Both children could be very seriously injured in a crash.
- Do not allow children to operate the doors, windows, or seat adjustments.
- Do not leave children, pets or people needing assistance in the vehicle unattended, especially in hot weather when the inside of the vehicle can get hot enough to kill them. They could also activate vehicle controls, causing it to move unexpectedly.

⚠ WARNING

Children who are unrestrained or improperly restrained can be seriously injured or killed in a crash.

Any child too small for a seat belt should be properly restrained in a child seat. A larger child should be properly restrained with a seat belt, using a booster seat if necessary.

⚠ WARNING

Allowing a child to play with a seat belt or wrap one around their neck can result in serious injury or death.

Instruct children not to play with any seat belt and make sure any unused seat belt a child can reach is buckled, fully retracted, and locked.

■ Protecting Infants

An infant must be properly restrained in a rear-facing, reclining child seat until the infant reaches the seat maker's weight or height limit for the seat, and the infant is at least one year old. Many experts recommend use of a rear-facing seat for a child up to two years old if the child's height and weight are appropriate for a rear-facing seat.

Child seats must be placed and secured in a rear seating position. Rear-facing child seats should never be installed in a forward-facing position. When properly installed, a rear-facing child seat may prevent the driver or a front passenger from moving their seat all the way back, or from locking their seat-back in the desired position.

Make sure that there is no contact between the child seat and the seat in front of it. It can also interfere with proper operation of the front passenger's advanced front airbag system. If this occurs, we recommend that you install the child seat directly behind the front passenger's seat, move the seat as far forward as needed, and leave it unoccupied. Or, you may wish to get a smaller rear-facing child seat.



⚠ WARNING

Placing a rear-facing child seat in the front seat can result in serious injury or death during a crash. Always place a rear-facing child seat in the rear seat, not the front.

■ Protecting Smaller Children

If a child is at least one year old and within the weight range indicated by the child seat manufacturer, the child should be properly restrained in a firmly secured forward-facing child seat.

We strongly recommend placing a forward-facing child seat in a rear seating position. Placing a forward-facing child seat in the front seat can be hazardous, even with advanced front airbags that automatically turn the

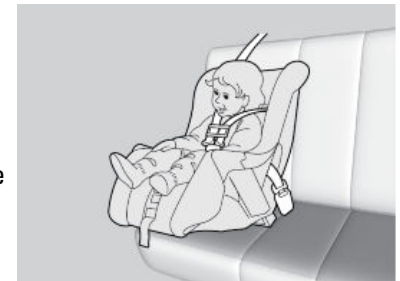

passenger's front airbag off. A rear seat is the safest place for a child.

⚠ WARNING

Placing a forward-facing child seat in the front seat can result in serious injury or death if the front airbag inflates.

If you must place a forward-facing child seat in front, move the vehicle seat as far back as possible, and properly restrain the child.

■ Selecting a Child Seat

Most child seats are LATCH-compatible (Lower Anchors and Tethers for CHildren). Some have a rigid-type connector, while others have a flexible-type connector. Both are equally easy to use. Some existing and previously owned child seats can only be installed using the seat belt. Whichever type you choose, follow the child seat manufacturer's use and care instructions as well as the instructions in this guide. Proper installation is key to maximizing your child's safety.

In seating positions and vehicles not equipped with LATCH, a LATCH-compatible child seat can be installed using the seat belt and a top tether for added security. This is because all child seats are required to be designed so that they can be secured with a lap belt or the lap part of a lap/shoulder belt. In addition, the child seat manufacturer may advise that a seat belt be used to attach a LATCH-compatible seat once a child reaches a specified weight. Please read the child seat owner's manual for proper installation instructions.

Important considerations when selecting a child seat

Make sure the child seat meets the following three requirements:

- The child seat is the correct type and size for the child.
- The child seat is the correct type for the seating position.
- The child seat is compliant with Federal Motor Vehicle Safety Standard 213 or Canadian Motor Vehicle Safety Standard 213.

■ Installing a LATCH-Compatible Child Seat

A LATCH-compatible child seat can be installed in any of the rear seats. A child seat is attached to the lower anchors with either the rigid or flexible type of connectors.

1. Locate the anchor marks affixed to the base of the seat cushion.
2. Pull out the anchor covers under the marks to expose the lower anchors.
3. Place the child seat on the vehicle seat, then attach the child seat to the lower anchors according to the instructions that came with the child seat. Make sure that the lower anchors are not obstructed by the seat belt or any other object.

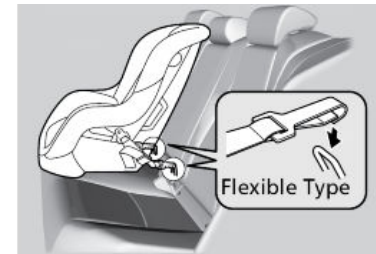
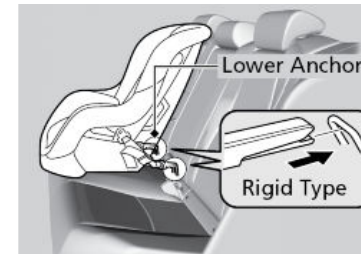
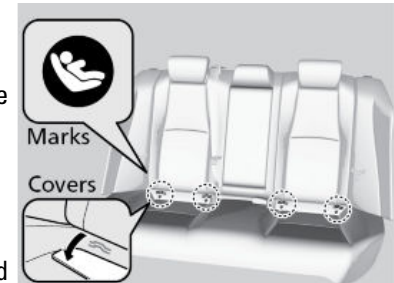

4. Open the tether anchor cover behind the head restraint.
5. **Seats in the outer positions with adjustable headrest:** Put the outer head restraint to its highest position, then route the tether strap between the head restraint legs, and secure the tether strap hook to the anchor. Make sure the strap is not twisted.

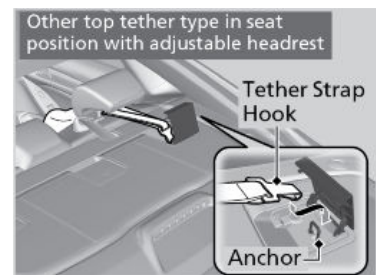
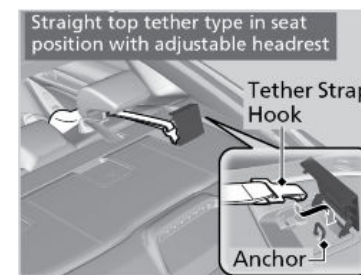

6. **Seats in the outer positions with straight top tether type and fixed headrest:** Route the tether strap over the top of the head restraint and secure the tether strap hook to the anchor. Make sure the strap is not twisted.

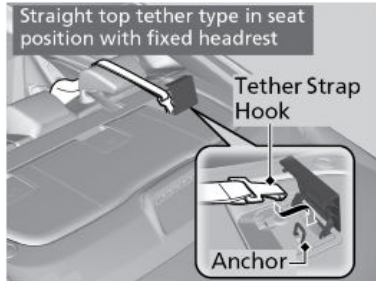

- Seats in the outer positions with other top tether type and fixed headrest:** Route the tether strap over the side of the head restraint and secure the tether strap hook to the anchor. Make sure the strap is not twisted.

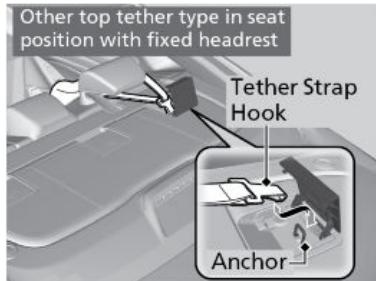

7. Tighten the tether strap as instructed by the child seat manufacturer.
8. Make sure the child seat is firmly secured by rocking it forward and back and side to side; little movement should be felt.
9. Make sure any unused seat belt that a child can reach is buckled, the lockable retractor is activated, and the belt is fully retracted and locked.

⚠ WARNING

Never attach two child seats to the same anchor. In a collision, one anchor may not be strong enough to hold two child seats attachments and may break, causing serious injury or death.

⚠ WARNING

Do not use the lower inner anchors of the outer rear seats to secure a LATCH-compatible child seat to the rear center seat, unless the child seat manufacturer's instructions for that system permit the use of inner anchors with the stated spacing.

Installing a LATCH-compatible child seat in the rear center seat

Each outer rear seat is equipped with a pair of lower anchors which are used to secure a LATCH-compatible child seat. The rear center seat, however, is not equipped with anchors of any kind.

The inner and outer anchors are spaced apart at a standard distance of 11 inches (280 mm).

The distance between the two inner anchors is:

- 15.4 inches (390 mm).

LATCH-compatible restraint systems that are fitted with rigid-type attachments cannot be installed in the rear center seat. However, a system fitted with flexible-type attachments can be installed in the center seat, provided that the child seat manufacturer's instructions for that system permit the use of the inner anchors with the stated spacing.

Before seating a child, make sure that the system is properly attached to both the lower anchors and tether anchors.

■ Installing a Child Seat with a Lap/Shoulder Seat Belt

A child seat can be installed with a lap/shoulder belt in any rear seat or, if absolutely necessary, the front passenger seat.

1. Place the child seat on the vehicle seat.
2. Route the seat belt through the child seat according to the seat manufacturer's instructions, and insert the latch plate into the buckle. Insert the latch plate fully until it clicks.
3. Slowly pull the shoulder part of the belt all the way out until it stops. This activates the lockable retractor.
4. Let the seat belt retract a few inches and check that the retractor has switched modes by pulling on the webbing. It should not pull out again until it is reset by removing the latch plate from the buckle. If you are able to pull the shoulder belt out, the lockable retractor is not activated. Pull the seat belt all the way out, and repeat steps 3 – 4.

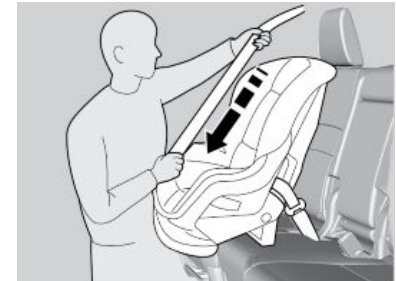

- Grab the shoulder part of the seat belt near the buckle, and pull up to remove any slack from the lap part of the belt. When doing this, place your weight on the child restraint system and push it into the vehicle seat.
- Make sure the child restraint system is firmly secured by rocking it forward and back, and side to side; little movement should be felt.

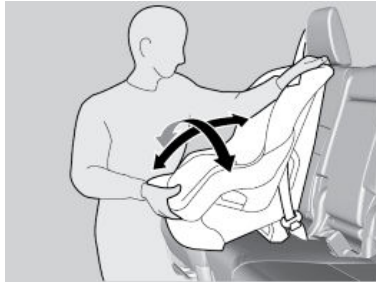
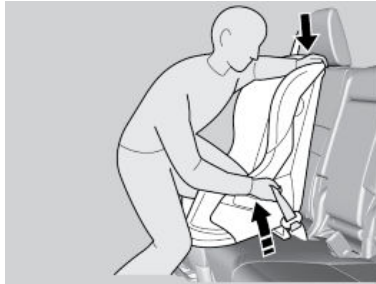

■ Adding Security with a Tether

A tether anchorage point is provided behind each rear seating positions. If you have a child restraint system that comes with a tether but can be installed with a seat belt, the tether may be used for additional security.

- Locate the appropriate tether anchorage point and lift the cover.
- Route the tether strap over the head restraint. Make sure the strap is not twisted.

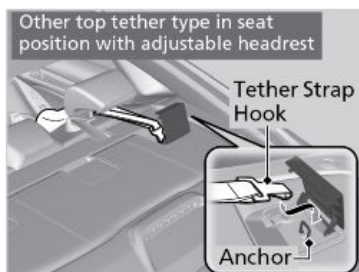
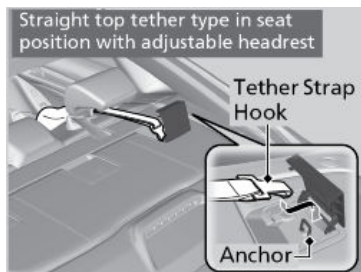
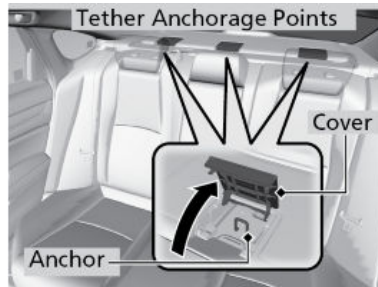

- Secure the tether strap hook onto the anchor. Make sure the strap is not twisted.

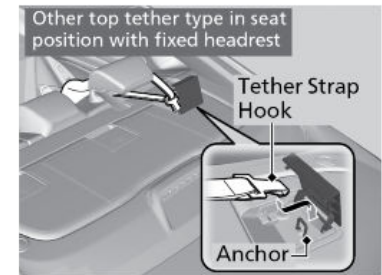
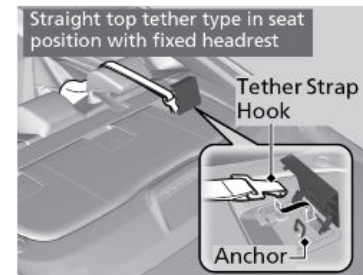

- Tighten the tether strap as instructed by the child seat manufacturer.

Note: Always use a tether for forward facing child seats when using the seat belt or lower anchors.

■ Protecting Larger Children

When a child is too big for a child seat, secure the child in a rear seat using the lap/shoulder seat belt.

Have the child sit upright and all the way back, then ensure the following:

- The child's knees bend comfortably over the edge of the seat.
- The shoulder belt crosses between the child's neck and arm.
- The lap part of the seat belt is as low as possible, touching the child's thighs.
- The child can stay seated for the whole trip.



If a lap/shoulder belt cannot be used properly, position the child in a booster seat in a rear seating position. For the child's safety, check that the child meets the booster seat manufacturer's recommendations.

Some U.S. states and Canadian provinces/territories require children to use a booster seat until they reach a given age or weight (e.g., 6 years or 60 lbs).

Be sure to check current laws in the state or province/territory where you intend to drive.

⚠ WARNING

Allowing a child age 12 or under to sit in the front can result in injury or death if the passenger's front airbag inflates.

If a larger child must ride in front, move the vehicle seat as far to the rear as possible, have the child sit up properly and wear the seat belt properly, using a booster seat if needed.

Safety Label Locations

Safety labels are in the locations shown. They warn you of potential hazards that can cause serious injury or death. Read these labels carefully.

If a label comes off or becomes hard to read (except for the U.S. dashboard label which may be removed by the owner), contact a dealer for a replacement.

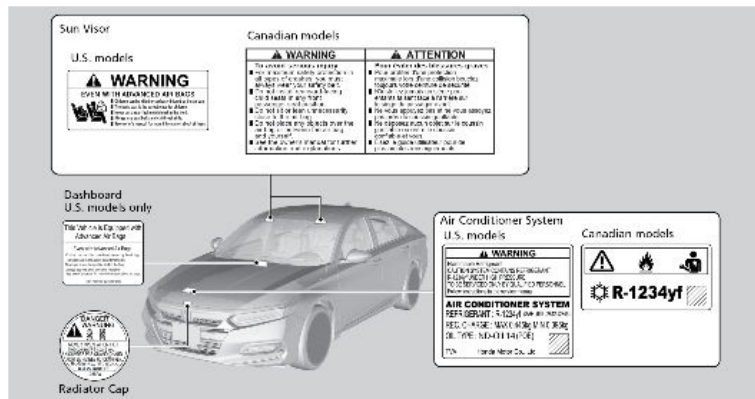

Reporting Safety Defects

In the U.S.

If you believe that your vehicle has a defect which could cause a crash or could cause injury or death, you should immediately inform the National Highway Traffic Safety Administration (NHTSA) in addition to notifying American Honda Motor Co., Inc.

If NHTSA receives similar complaints, it may open an investigation, and if it finds that a safety defect exists in a group of vehicles, it may order a recall and remedy campaign. However, NHTSA cannot become involved in individual problems between you, your dealer, or American Honda Motor Co., Inc.

To contact NHTSA, you may call the Vehicle Safety Hotline toll-free at 1-888-327-4236 (TTY: 1-800-424-9153); go to safercar.gov, or write to: Administrator, NHTSA, 1200 New Jersey Avenue, SE., Washington, DC 20590. You can also obtain other information about motor vehicle safety from safercar.gov.

In Canada

If you believe that your vehicle has a defect which could cause a crash or could cause injury or death, you should immediately inform Honda Canada, Inc., and you may also inform Transport Canada.

If Transport Canada receives similar complaints, it may open an investigation, and if it finds that a safety defect exists in a group of vehicles, it may lead to a recall and remedy campaign. However, Transport Canada cannot become involved in individual problems between you, your dealer, or Honda Canada, Inc.

To contact Transport Canada's Defect Investigations and Recalls Division, you may call 1-800-333-0510. For more information on reporting safety defects or about motor vehicle safety, go to tc.gc.ca/roadsafety.

INSTRUMENT PANEL

Learn about the indicators, gauges, and displays related to driving the vehicle.



Indicators briefly appear with each engine start and then go out. Red and amber indicators are most critical. Blue and green indicators are used for general information.

Malfunction Indicators

These are the most critical indicators. If they come on and stay lit while driving or at any other time, there may be a problem. See your dealer if necessary.

BRAKE
u.s.



Canada

Brake system

- Brake fluid is low.
 - There is a malfunction in the brake system.
- Press the brake pedal lightly to check pedal pressure. If normal, check the brake fluid level when you stop. If abnormal, take immediate action. If necessary, downshift the transmission to slow the vehicle using engine braking. Have your vehicle repaired immediately.



Low oil pressure

Engine oil pressure is low. Stop in a safe place. Open the hood, check the oil level and add oil if necessary. If the indicator does not turn off, have your vehicle repaired immediately.



12-Volt Battery Charging system

The 12-volt battery is not charging. Turn all electrical items off, but do not turn the vehicle off to prevent further battery discharge. Have your vehicle repaired immediately.



Supplemental Restraint System (SRS)

There is a problem with one of the airbag systems or seat belt tensioners.



Smart Entry System*¹

There is a problem with the system.

LKAS

Lane Keeping Assist System (LKAS)

There is a problem with the system.



Malfunction Indication Lamp (check engine light)

The emissions control system may have a problem, or the fuel cap is missing or loose. If the indicator blinks, a misfire in the engine's cylinders is detected. Stop in a safe place and wait for the engine to cool down.



Anti-lock Brake System (ABS)

There is a problem with the anti-lock brake system. Your vehicle still has normal braking ability, but no anti-lock function.



Low Tire Pressure / Tire Pressure Monitoring System (TPMS)

- Blinks and remains on:
Have your vehicle checked by a dealer. If the vehicle is fitted with a compact spare, get your regular tire repaired or replaced and put back on your vehicle as soon as you can.



Vehicle Stability Assist[®] (VSA[®]) System

There is a problem with the VSA[®] or hill start assist system.



Blind Spot Information*¹

There is a problem with the system, or the sensor is blocked.



Electric Power Steering (EPS)

There is a problem with the system. Stop the vehicle in a safe place, and restart the engine.

ACC

Adaptive Cruise Control (ACC)*¹ with Low Speed Follow*¹

There is a problem with the system.

Condition Indicators

These indicators may require you to perform an action.



Parking Brake

Release the parking brake before driving. You will hear a beep if you drive with it not fully released.



Seat Belt Reminder

Make sure seat belts are fastened for you and all passengers. The indicator blinks and beeps sound continuously if you or your front passenger has not fastened your seat belts when you begin driving. If the indicator remains on after seat belts are fastened, see your dealer.



Low Fuel

Refuel as soon as possible. If the indicator blinks, there is a problem with the fuel gauge. See your dealer.



Low Tire Pressure / Tire Pressure Monitoring System (TPMS)

- Comes on while driving:

Stop in a safe place, check tire pressures, and inflate tire(s) if necessary.



System Message

When a condition or malfunction indicator comes on, a message also appears on the driver information interface (DII). Check the display for more information.



Immobilizer

Your key or remote transmitter cannot be recognized by the vehicle. If the indicator blinks, you may not be able to start the engine. Turn the vehicle off, and then on again. If it continues to blink, there may be a problem with the system. See your dealer.

On/Off Indicators

These indicators remind you when an item is on or off.



VSA® off



LKAS on



VSA® engaged (blinks)



ACC*1 on



Turn signals/hazards on



Fog lights*1 on



High beams on



Exterior lights on



Auto High Beam System on



ECON mode on

*1 - If equipped

*1 - If equipped

Driver Information Interface

Consists of several displays that provide you with useful information.

Main Display

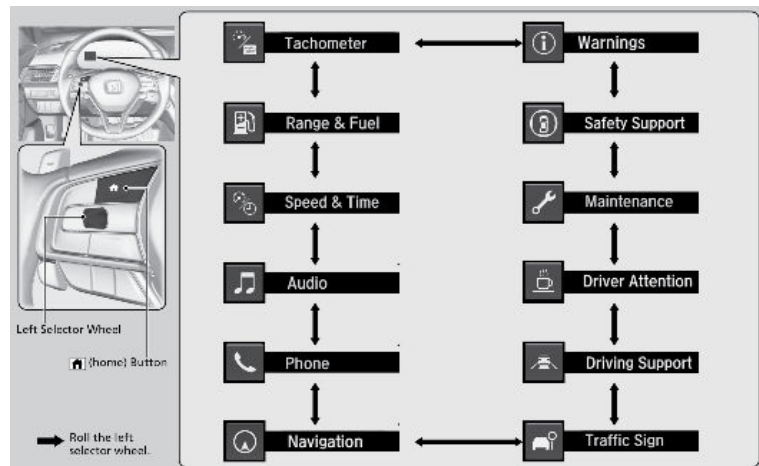

* Not available on all models

Sub Display

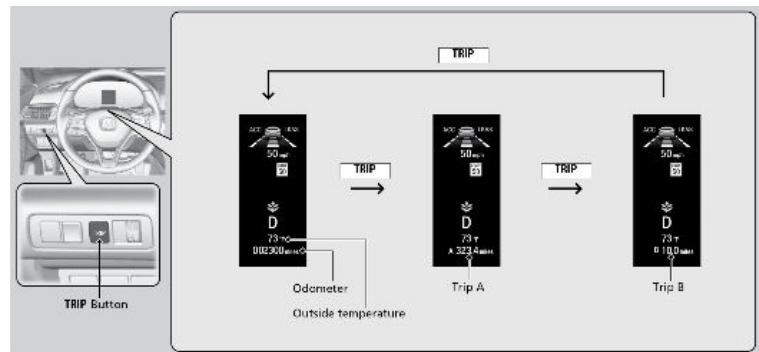

Head-Up Display*1

Shows the current mode for ACC with LSF, tachometer, traffic sign recognition system, gear position indicator, or turn-by-turn directions along with the vehicle

speed. You can choose which item to be displayed using the HUD button on the steering wheel. They are displayed when the power mode is in ON.



To turn the head-up display on and off: Press the HUD button on the driver side control panel.

The display can be moved up and down to come level with your eyes.

To raise or lower the head-up display: Press and hold the up or down button until the desired position is reached.

*1 - If equipped

VEHICLE CONTROLS

Learn about the various controls necessary for operating and driving the vehicle.

Using the Remote Transmitter

Lock or unlock the doors or trunk.

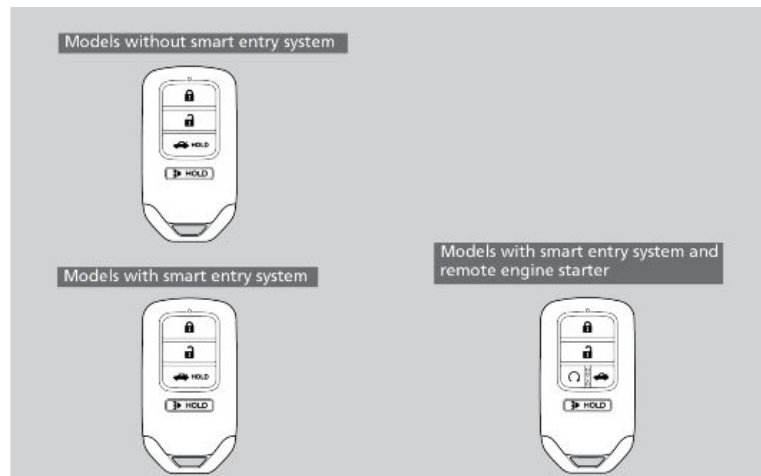

Note: Leaving the remote transmitter in the vehicle can result in theft or accidental movement of the vehicle. Always take it with you whenever you leave the vehicle unattended.

Smart Entry System*1

When you carry the remote transmitter (for example, in a pocket or purse) and it is outside the vehicle and within range (about 32 inches or 80 cm), you can lock or unlock the doors, and open the trunk without handling the transmitter.

■ Unlocking/Locking the Doors

To unlock: Grab the driver's door handle to unlock the driver's door and fuel fill door. Grab the front passenger's door handle to unlock all the doors, fuel fill door, and the trunk. You can customize this feature's behavior.

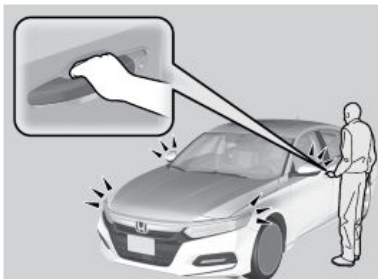

*1 - If equipped

To lock: Press the door lock sensor on the front door.

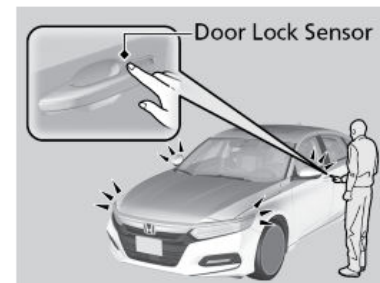

■ Walk Away Auto Lock®

When you walk away from the vehicle while carrying the remote transmitter, the doors and trunk can automatically lock if the following conditions are met:

- The remote transmitter is within a range of 5 feet (1.5 m).
- All doors and the trunk are closed.
- There is not an additional remote transmitter inside the vehicle.

Follow these steps:

1. Exit the vehicle, close the door and stay near it. Listen for a beep. The system is activated.
2. Walk at least 5 feet (1.5 m) away.
3. Listen for a beep and look for the lights to flash. The doors lock.

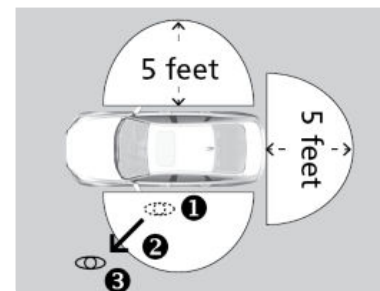

The auto lock function is set to OFF as the factory default setting. The auto lock function can be set to ON using the audio/information screen. If you set the auto lock function to ON using the audio/information screen, only the remote transmitter that was used to unlock the driver's door prior to the setting change can activate auto lock. To turn on this feature, follow the steps below:

1. From the HOME screen, select Settings.
2. Select System.
3. Select Vehicle.
4. Select Door/Window Setup.
5. Select Walk Away Auto Lock®.

■ **Customizing Door Lock and Unlock Settings**

Customize the auto door lock and door unlock settings to your preference. Begin with the vehicle off.

Models with Color Audio

1. Press the **MENU/CLOCK** button, then select **Settings**.
2. Select **Vehicle Settings**.
3. Select **Door/Window Setup**.
4. Select **Auto Door Lock** or **Auto Door Unlock** then select an option.

Models with Display Audio

1. Select **Home**.
2. Select **Settings**.
3. Select **Vehicle**.
4. Select **Door/Window Setup**.
5. Select **Auto Door Lock** or **Auto Door Unlock** then select an option.

Door Operation

Use several methods to lock or unlock the doors.

■ **Using the Lock Tab**

To unlock: When you unlock either front door using the lock tab, the specific door (driver's or passenger's) unlocks.

To lock: When you lock the door using the lock tab on the driver's door, all the other doors and the trunk lock at the same time. When you lock the door using the lock tab on the front passenger's door, only that door locks.

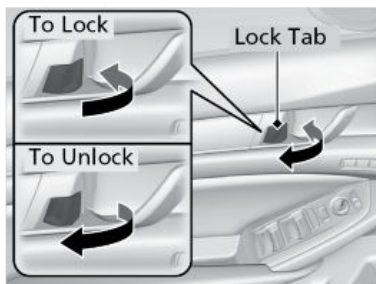

■ **Using the Front Door Inner Handle**

Pull the front door inner handle. The door unlocks and opens in one motion. Unlocking and opening the driver's door from the inner handle unlocks all other doors and trunk.

Do not pull a front door inner handle while the vehicle is moving.

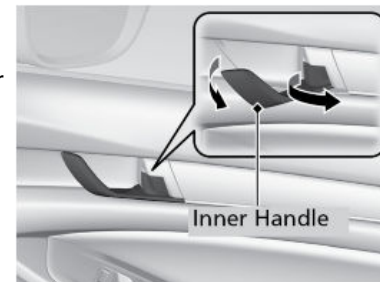

■ **Using the Master Door Lock Switch**

To unlock: Press the unlock side of the switch to unlock all doors and the trunk.

To lock: Press the lock side of the switch to lock all doors and the trunk.

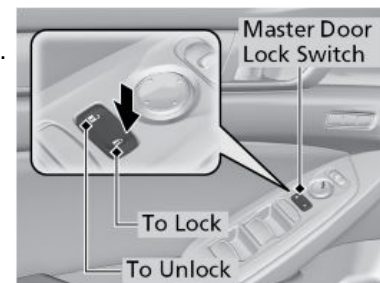

■ **Childproof Door Locks**

The childproof door locks prevent the rear doors from being opened from the inside regardless of the position of the lock tab.

Slide the lever in the rear door to the lock position, and close the door.

Open the door using the outer door handle.

Note: To open the door from the inside when the childproof door lock is on, put the lock tab in the unlock position, lower the rear window, put your hand out of the window, and pull the outside door handle.

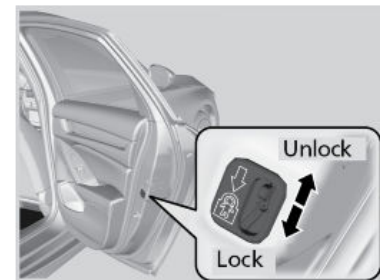

■ **Using the Trunk Opener**

Press and hold the trunk opener button on the driver's door to unlock and open the trunk.

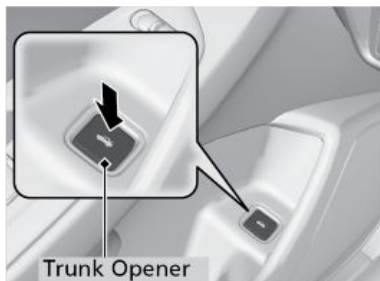

Power Window Operation

The power windows can be opened and closed by using the switches on the doors when the vehicle is on. The switches on the driver's side can be used to open and close all the windows.

■ **Automatic Operation**

To open: Push the switch down firmly.

To close: Pull the switch up firmly.

The window opens or closes completely. To stop the window at any time, push or pull the switch again briefly.

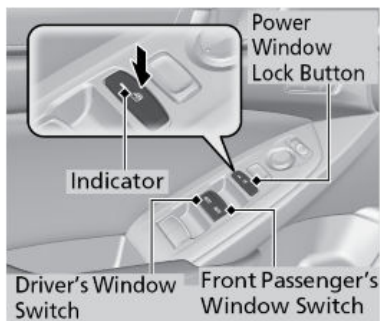

■ **Manual Operation**

To open: Push the switch down lightly.

To close: Pull the switch up lightly.

Release the switch when the windows reach the desired position.

■ **Power Window Lock**

Push in the power window lock button so only the driver's window can be operated.

⚠ WARNING

Closing a power window on someone's hands or fingers can cause serious injury.
Make sure your passengers are away from the windows before closing them.

Power Moonroof*¹ Operation

The moonroof can be opened and closed when the vehicle is on by using the switch on the ceiling.

■ **Automatic Operation**

To open: Firmly push the switch back, then release.

To close: Firmly push the switch forward, then release.

The moonroof opens or closes completely. To stop the moonroof at any time, push the switch briefly.

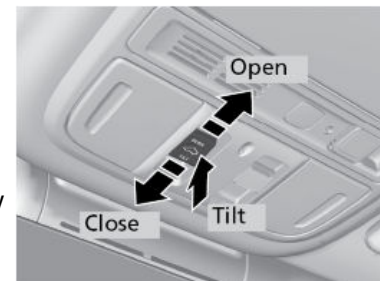

■ **Manual Operation**

To open: Pull the switch back lightly.

To close: Push the switch forward lightly.

Release the switch when the window reaches the desired position.

■ **Moonroof Tilt**

To tilt: Push the center of the switch.

To close: Push the switch forward firmly, then release.

⚠ WARNING

Closing the moonroof on someone's hands or fingers can cause serious injury.
Make sure your passengers are away from the moonroof before closing it.

Interior and Exterior Lights

Operate interior and exterior lights when the vehicle is on or off.

*1 - If equipped

Brightness Control

Adjust instrument panel brightness when the vehicle is on.

To brighten: Turn the dial up.

To dim: Turn the dial down.

A beep sounds when the brightness reaches its minimum or maximum.

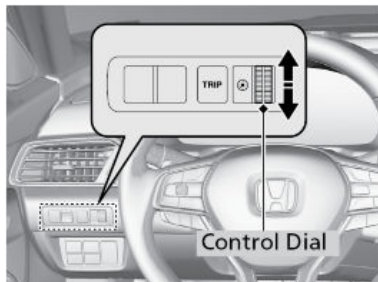

Interior Lights

Change the interior light settings using the switches on the ceiling.

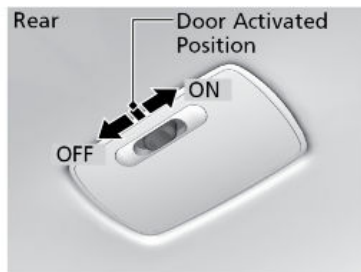
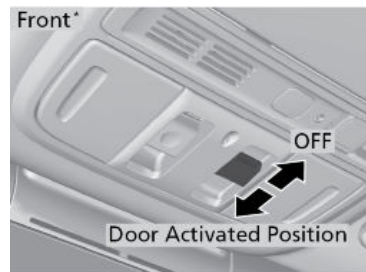

*** Not available on all models**

ON position: Interior lights remain on.

Door-activated position: Interior lights come on when any of the doors are opened, the driver's door is unlocked, or the vehicle is turned off.

OFF position: Interior lights remain off.

Map Lights

Press the map lights to turn on or off.



Exterior Lights

Rotate the switches on the lever to operate the exterior lights. Push the lever forward to turn on the high beams. Return the lever to its original position for low beams.

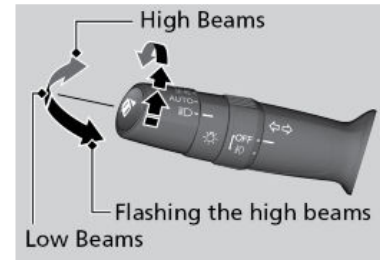

OFF: All exterior lights are off.

 Turn on exterior lights except headlights.

AUTO: Turn on the automatic lighting feature. Headlights turn on or off depending on ambient brightness when the vehicle is on. Headlights automatically come on after the wipers are engaged for a certain time. The headlights come on when you unlock a door in dark areas with the headlight switch in AUTO.

 Turn on all exterior lights including headlights.

 Turn fog lights*1 on or off.

One-Touch Turn Signal

Use this quick and convenient method to signal a lane change.

Lightly push the turn signal lever up or down for a three-blink sequence.

For a continuous signal, push the lever up or down until it locks into place.

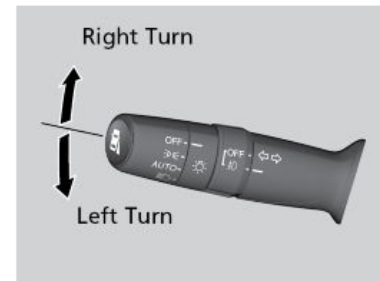

Auto High Beam

The front sensor camera detects the light sources ahead of the vehicle such as the lights of a preceding or oncoming vehicle, or street lights. When you are driving at night, the system automatically switches the headlights between low beam and high beam depending on the situation.

*1 - If equipped

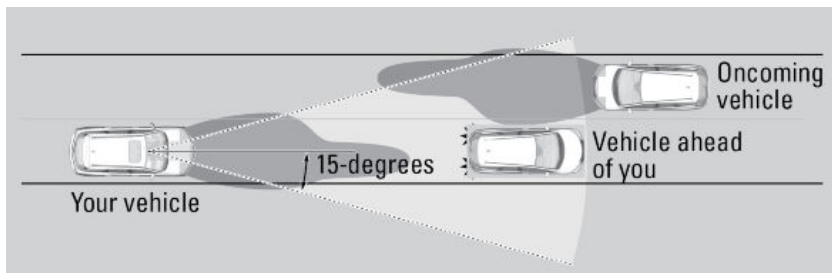

For the system to work properly:

- Do not place an object that reflects light on the dashboard.
- Keep the windshield around the camera clean. When cleaning the windshield, be careful not to apply windshield cleanser to the camera lens.
- Do not attach an object, sticker or film in the area around the camera.
- Do not touch the camera lens.

If the camera receives a strong impact or requires repair, consult a dealer.

If you see the message **"Some Driver Assist Systems Cannot Operate: Clean Front Windshield"**, park your vehicle in a safe place. Wipe away debris blocking the windshield, then start driving again. If the message remains even after driving for a while with the clean windshield, have your vehicle checked by a dealer.

If you see a message that the camera is too hot, use the climate control system to cool the interior. Defroster mode will direct airflow toward the camera.

■ Automatically switching between high beam and low beam

When auto high beam is active, the headlights switch between high beam and low beam based on the following conditions.

If you find the timing of beam changes inconvenient for driving, change the beams manually.

Switching to high beam

All of the following conditions must be met before the high beams turn on.

- Your vehicle speed is 25 mph (40 km/h) or more.
- There are no preceding or oncoming vehicle with headlights or taillights turned on.
- There are few street lights on the road ahead.

Switching to low beam

One of the following conditions must be met before the low beams turn on.

- Your vehicle speed is 15 mph (24 km/h) or less.
- There is a preceding or oncoming vehicle with headlights or taillights turned on.
- There are many street lights on the road ahead.

■ Manually switching between high beam and low beam

If you want to manually switch the headlights between high beam and low beam, follow either of the procedures below. Note that when you do this, the auto high beam indicator will turn off and the auto high beam will be deactivated.

Using the lever: Pull the lever toward you for flashing the high beams then release it within about one second while driving. To reactivate the auto high beam, pull the lever toward you for flashing the high beams then release it while driving. The auto high beam indicator will come on.

Using the light switch: Turn the light switch to . To reactivate the auto high beam, turn the light switch to **AUTO** when the lever is in the low beam position, the auto high beam indicator will come on.

■ Turning the System On or Off

Make sure the headlight lever is in the low beam position with the switch rotated to the AUTO position. The auto high beam system indicator comes on.

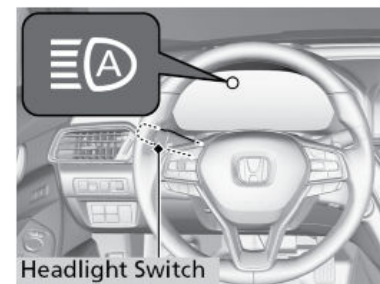

To turn the system on: Pull and hold the headlight lever toward you for about 30 seconds, until the indicator flashes once.

To turn the system off: Pull and hold the headlight lever toward you for about 40 seconds, until the indicator flashes twice.

Wiper Operation

The windshield wipers and washers can be used when the vehicle is on.

■ Front Wipers

Move the wiper lever up or down to the desired position.

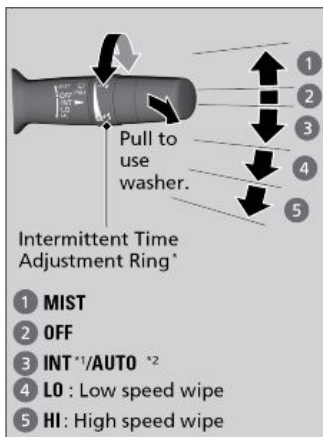

*1: Models with manual intermittent operation
 *2: Models with automatic intermittent operation
 * Not available on all models

■ **Headlight Integration with Wipers**

When the headlights are in the **AUTO** position, they automatically turn on when the front wipers operate several times within a certain interval. The headlights turn off shortly after the wipers are turned off or if there is enough ambient light.

■ **Intermittent (INT) Wipers*1**

When you move the lever to the INT position, the wipers operate based on the delay adjustment.

Rotate the adjustment ring to adjust the wiper delay.



■ **Automatic Intermittent Wipers*1**

When you move the lever to the AUTO position while driving in rainy weather, the wipers operate based on the amount of detected rainfall.



Rotate the adjustment ring to adjust the rainfall sensor sensitivity. Set the wipers to OFF when the rain stops.

NOTICE

Ensure the wiper lever is in the OFF position before entering a car wash or cleaning the windshield. Wiper-system damage may happen otherwise.

NOTICE

Do not use the wipers when the windshield is dry. The windshield will get scratched, or the rubber blades will get damaged.

In cold weather, the blades may freeze to the windshield, becoming stuck. Operating the wipers in this condition may damage the wipers. Use the defroster to warm the windshield, or manually clear the windshield of ice and snow before turning on the wipers.

Adjusting the Front Seats

Adjust the driver's seat as far back as possible while allowing you to maintain full control of the vehicle. You should be able to sit upright and well back in the seat, adequately press the pedals without leaning forward, and grip the steering wheel comfortably. The passenger's seat should be adjusted so that it is as far back from the front airbag in the dashboard as possible.

The National Highway Traffic Safety Administration and Transport Canada recommends that drivers allow at least 10 inches (25 cm) between the center of the steering wheel and the chest.

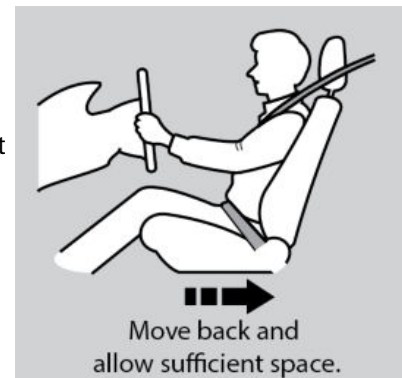

Front Power Seat(s)*1

*1 - If equipped

*1 - If equipped

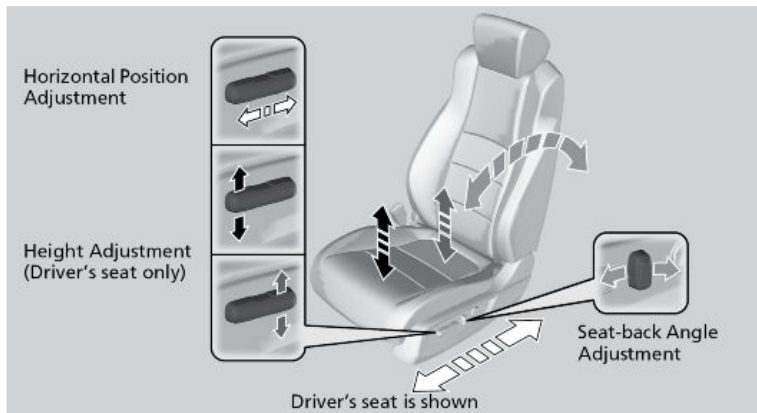

Front Manual Seat(s)*1

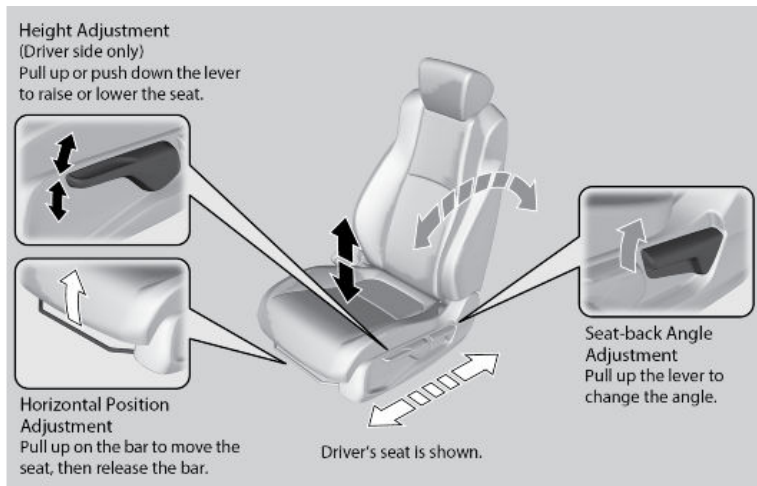

Lumbar Support Adjustment Switch*1

Press the top: To move the lumbar support up.

Press the bottom: To move the lumbar support down.

Press the front: To increase the entire lumbar support.

Press the rear: To decrease the entire lumbar support.



⚠ WARNING

Sitting too close to a front airbag can result in serious injury or death if the front airbags inflate.

Always sit as far back from the front airbags as possible while maintaining control of the vehicle.

Driving Position Memory System*1

You can store two driver's seat (except for power lumbar), positions with the driving position memory system.

When you unlock and open the driver's door with a remote transmitter, the seat adjusts to retracted positions of one of the two preset positions automatically.

The seat will move to the stored position when you set the power mode to ACCESSORY.



*1 - If equipped

Storing a Position in Memory

1. Adjust the seat, to your preferred positions.
2. Press SET.
3. Press and hold memory button 1 or 2 within 5 seconds of pressing the SET button.

You will hear two beeps when the memory is set.

4. Press one of the memory buttons to recall previously stored positions.

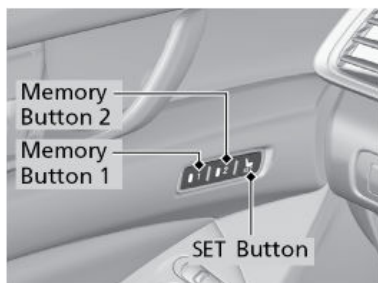

Adjusting the Head Restraints

Your vehicle is equipped with head restraints in all seating positions. Head restraints are most effective for protection against whiplash and other rear-impact crash injuries.

The center of the back of the occupant's head should rest against the center of the restraint. The tops of the occupant's ears should be level with the center height of the restraint.

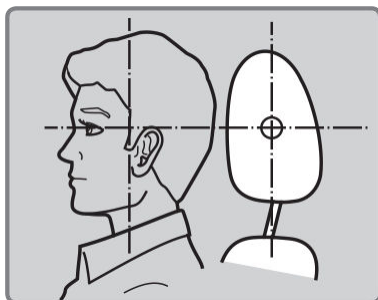

For a head restraint system to work properly:

- Do not hang any items on the head restraints or from the restraint legs.
- Do not place any objects between an occupant and the seat-back.
- Install each restraint in its proper location.

⚠ WARNING

Improperly positioning head restraints reduces their effectiveness and increases the likelihood of serious injury in a crash. Make sure head restraints are in place and positioned properly before driving.

Adjusting the Front Head Restraints

To raise the head restraint: Pull it upward.

To lower the head restraint: Push it down while pressing the release button.

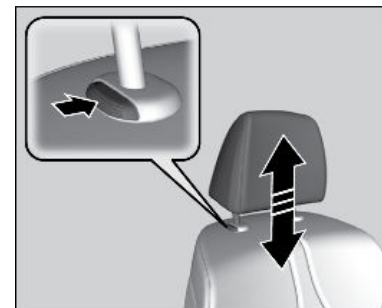

Adjusting the Rear Outer *1 Head Restraints

To raise the head restraint: Pull it upward.

To lower the head restraint: Push it down while pressing the release button.

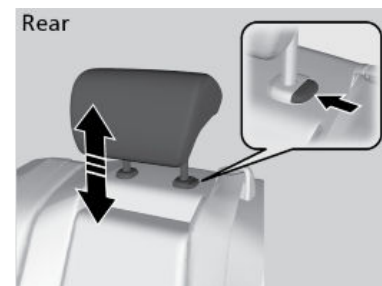

Removing and Reinstalling the Head Restraints

Head restraints can be removed for cleaning or repair.

To remove the head restraint: Pull the restraint up as far as it will go. Then push the release button(s), and pull the restraint up and out.

To reinstall a head restraint: Insert the legs back in place, then adjust the head restraint to an appropriate height while pressing the release button(s). Pull up on the restraint to make sure it is locked in position.

⚠ WARNING

Failure to reinstall, or correctly reinstall, the head restraints can result in severe injury during a crash. Always replace the head restraints before driving.

Adjusting the Rear Seats

The rear seat-back(s)*1 can be folded down to make room for large items in the trunk.

*1 - If equipped

Folding Down the Rear Seats

The rear seat back(s)^{*1} can be folded down to accommodate bulkier items in the trunk .

To fold down the seat:

1. Remove the center shoulder belt from the guide.

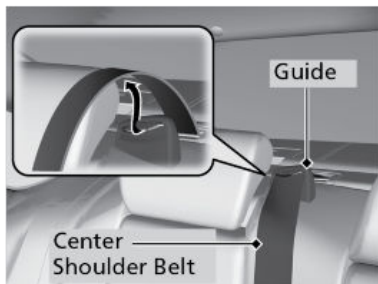

2. Pull the release lever in the trunk to release the lock.

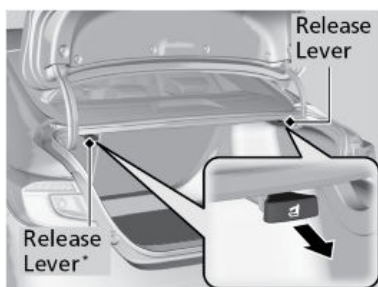

*** Not available on all models**

3. Fold down the seat back.

To lock a seat-back upright, push it backwards until it locks, so that the red tabs in the release lever go down.

When returning the seat-back to its original position, push it firmly back.

Make sure that the folded seat-back does not press against the front passenger seat, as this can cause the weight sensors in the front passenger seat to work improperly.

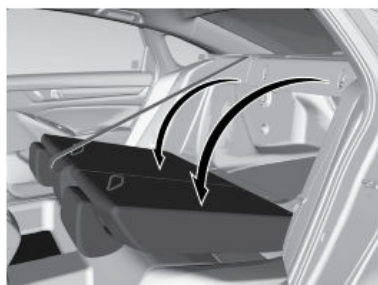

Floor Mats

The driver's floor mat hooks over the floor anchors, which keep the mat from sliding forward. To remove a mat for cleaning, turn the anchor knobs to the unlock position. When reinstalling, turn the knobs to the lock position.

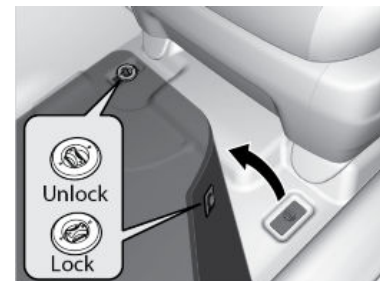

Do not put additional floor mats on top of the anchored mats.

Adjusting the Steering Wheel

The steering wheel height and distance from your body can be adjusted so that you can comfortably grip the steering wheel in an appropriate driving posture.

1. Push down the steering wheel adjustment lever.
2. Move the steering wheel up, down, in, or out.
3. Pull up on the steering wheel adjustment lever to lock the steering wheel in position.

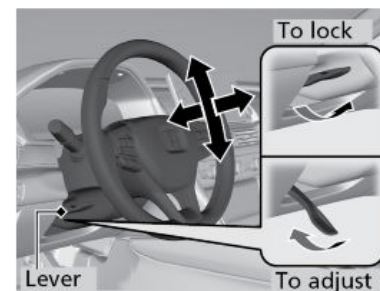

⚠ WARNING

Adjusting the steering wheel position while driving may cause you to lose control of the vehicle and be seriously injured in a crash.

Adjust the steering wheel only when the vehicle is stopped.

Adjusting the Mirrors

Adjust the angle of the mirrors for the best visibility when you are sitting in the correct driving position.

Rearview Mirror with Day/Night Positions^{*1}

Manually adjust the position to reduce headlight glare from vehicles behind you. Flip the tab to switch between day and night positions.

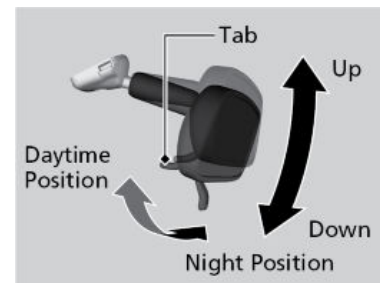

**1 - If equipped*

■ **Automatic Dimming Rearview Mirror*1**

When driving after dark, the automatic dimming function reduces glare in the rearview mirror from headlights behind you. This cannot be turned off. This function cancels when the shift lever is in Reverse (R).

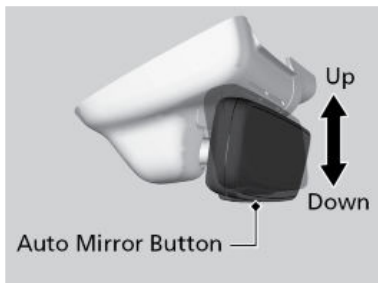

■ **Power Door Mirrors**

Adjust the power door mirrors when the vehicle is on.

L/R selector switch: Select the left or right mirror.

After adjusting the mirror, return the switch to the center position.

Mirror position adjustment switch: Press the switch left, right, up, or down to move the mirror.

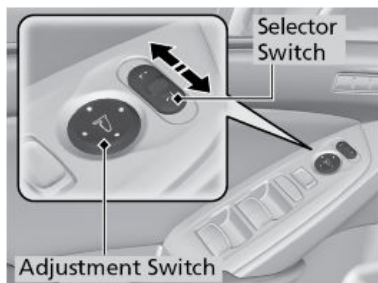

■ **Reverse Tilt Door Mirrors*1**

To activate this feature, set the power mode to ON and slide the selector switch to the left or right side. If activated, either side door mirror can tilt downward when you shift to Reverse (R) to improve visibility on the selected side of the vehicle when reversing. The mirror returns to its original position when you shift out of Reverse.

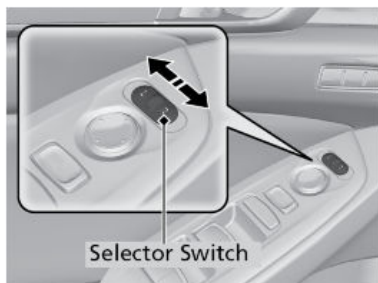

Homelink® Universal Transceiver*1

Program your vehicle to operate up to three remote-controlled devices around your home—such as garage doors, lighting, or home security systems—using the buttons on the bottom of the rearview mirror.

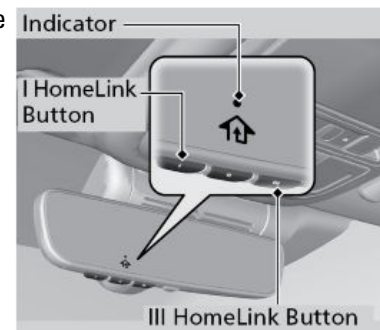

■ **Training a Button**

Park near the system you want to program, and follow the instructions in the flowchart that follows.

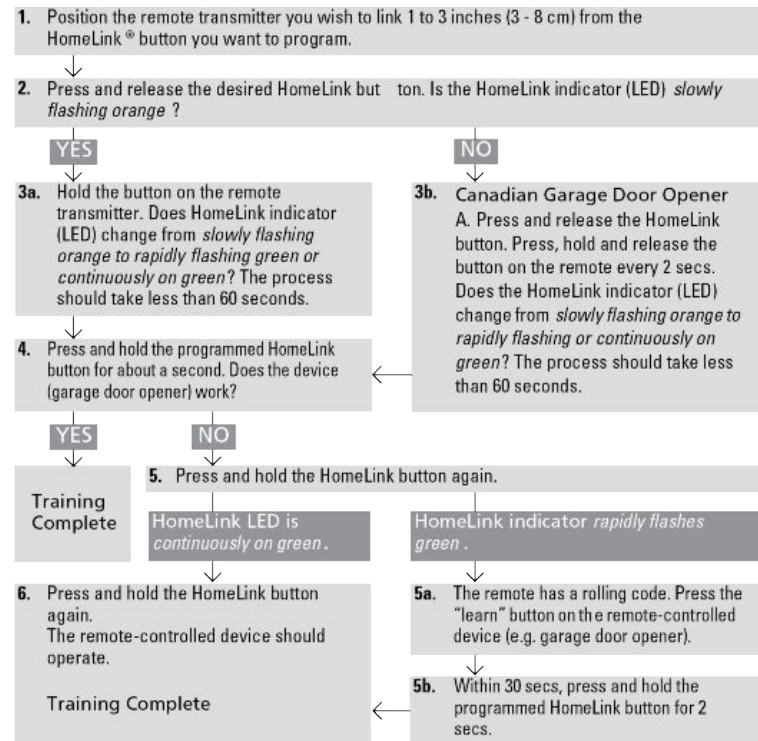

*1 - If equipped

*1 - If equipped

To retrain a button or erase codes, see the Owner's Manual at owners.honda.com (U.S.) or www.myhonda.ca (Canada). If you need help, call HomeLink at (800) 355-3515 or visit www.homelink.com.

Climate Control System

The automatic climate control system maintains the interior temperature you select. The system also selects the proper mix of heated or cooled air that raises or lowers the interior temperature to your preference as quickly as possible.

■ Front Operation - Climate Control System

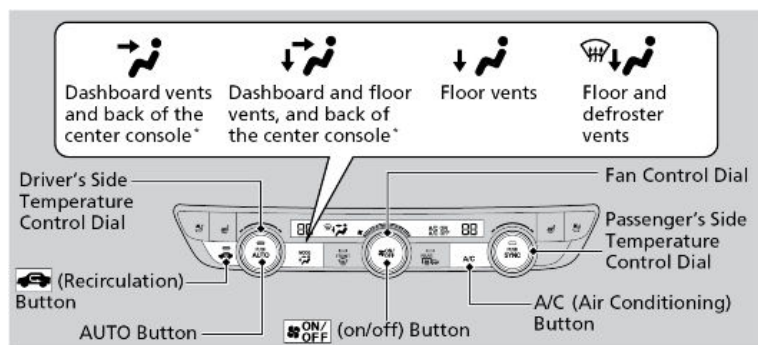

* Not available on all models

■ Heated Windshield Button*⁴

Turn the vehicle on. Press the heated windshield button to de-ice the windshield.

The heated windshield may automatically activate when the outside temperature is below 4°C, and deactivate when the temperature reaches 6°C.

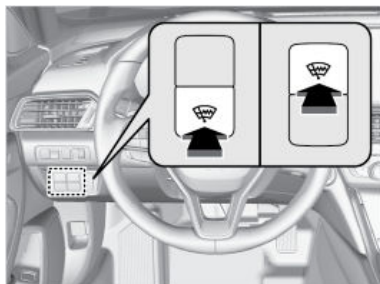

*⁴ - Canadian models only, if equipped

■ Heated Steering Wheel*⁴

Press the button to heat the steering wheel when the vehicle is on. Press the button again to turn off the heating.



Front Seat Heaters*¹ and Ventilation*¹

Press the seat heater*¹ or the seat ventilation*¹ button to cycle through settings. The appropriate indicator (red for heat, blue for ventilation) appears for each setting.

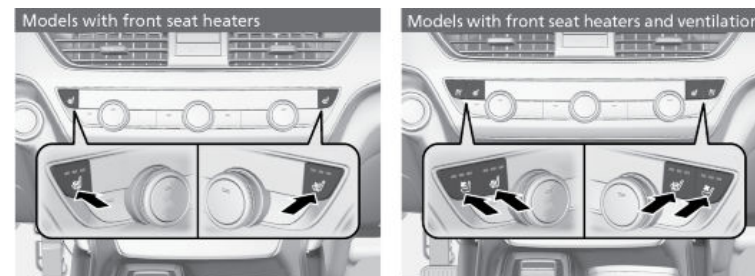

- Once - The HI setting (three indicators on)
- Twice - The MID setting (two indicators on)
- Three times - The LO setting (one indicator on)
- Four times - The OFF setting (no indicators on)

⚠ WARNING

Heat-induced burns are possible when using seat heaters. Persons with a diminished ability to sense temperature (e.g., persons with diabetes, lower-limb nerve damage, or paralysis) or with sensitive skin should not use the seat heaters.

Customized Features

When you customize settings, make sure that the vehicle is at a complete stop and shift to Park (P).

*⁴ - Canadian models only, if equipped

*¹ - If equipped

Models with Color Audio

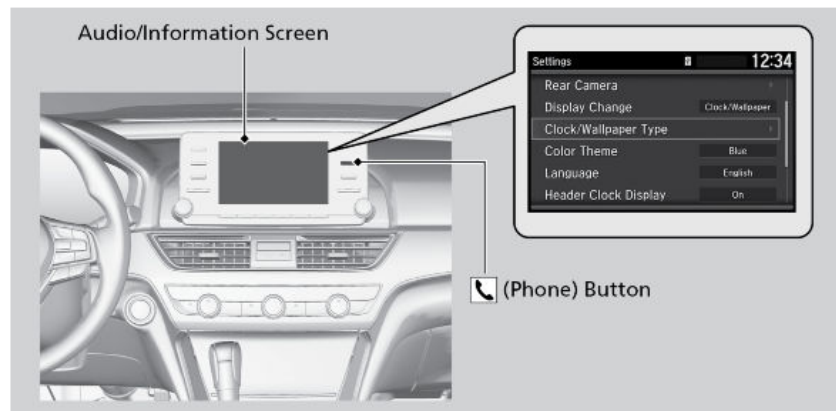

Models with Display Audio



■ How to Change a Setting

Models with Color Audio

Use the selector knob to make and enter selections.

1. Press the MENU/CLOCK button.
2. Select Settings.
3. Select a setting option and make your preferred changes.
4. Press the Back button to exit the menus.

Models with Display Audio

1. Press the SETTINGS button.

2. Select a category.
3. Select a setting option, and make your preferred changes.
4. Press the BACK button to exit out of the menus.

Setting the Clock

On vehicles with navigation, the time is automatically set using GPS signals. On vehicles without navigation and if the Automatic Date & Time feature has been turned off, use the following steps to adjust the time in the clock display.

Models with Color Audio

1. Press and hold the **MENU/CLOCK** button.
2. Select **Adjust Clock**, then press the selector knob.
3. Rotate knob to change the hour, then press the selector knob.
4. Rotate knob to change the minute, then press the selector knob.
5. To enter the selection, rotate knob, select **Set**, then press the selector knob.

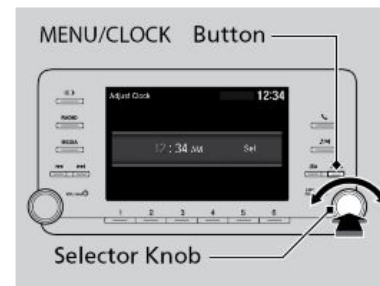

Models with Display Audio

Using the **Settings** menu on the audio/information screen.

1. Press the **HOME** icon, then select **Settings**.
2. Select **System**.
3. Select **Date & Time**.
4. Select **Set Date & Time**.
5. Use the **Up or Down arrow** to set the time.
6. Select **Save**.



AUDIO AND CONNECTIVITY

Learn how to operate the vehicle's audio system.

Basic Audio Operation

Connect audio devices and operate buttons and displays for the audio system.

■ USB Port

Install the iPod® USB connector or the USB flash drive to the USB port.

In the Center Pocket

Models with Color Audio

The USB port (1.0A) is for playing audio files on a USB flash drive, connecting a cellular phone and charging devices.

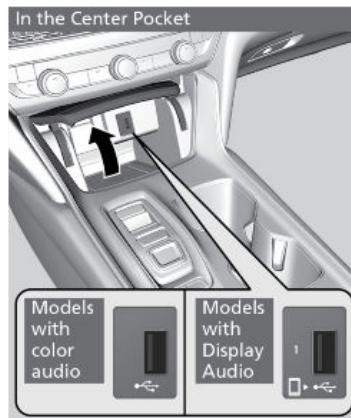

Models with Display Audio

The USB port (2.5A) is for charging devices, playing audio files and connecting compatible phones with Apple CarPlay™ or Android Auto™.

In the console compartment*1

The USB port (2.5A) is for charging devices, playing audio files and connecting compatible phones with Apple CarPlay™ or Android Auto™.

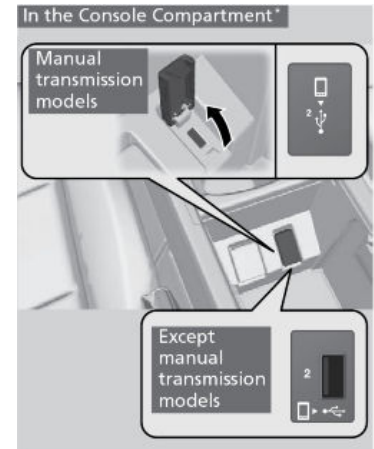

* Not available on all models

Rear of the center console*1

The USB ports (2.5A) are only for charging devices.

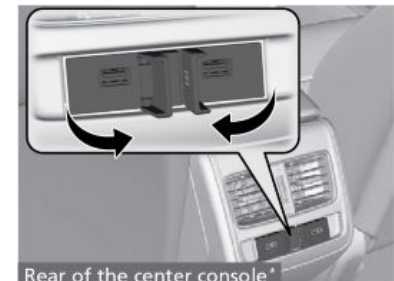

* Not available on all models

Tip: To prevent any potential issues, be sure to use an Apple MFi Certified Lightning Connector for Apple CarPlay™ or a USB cable certified by USB-IF to be compliant with USB 2.0 Standard for Android Auto™.

■ Accessory Power Socket

The accessory power sockets can be used when the power mode is in ACCESSORY or ON.

Accessory power socket (center pocket)

Open the center pocket and the cover to use it.



Accessory power socket (console compartment)

Open the console lid and the cover to use it.

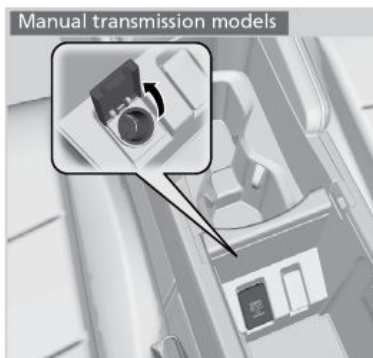
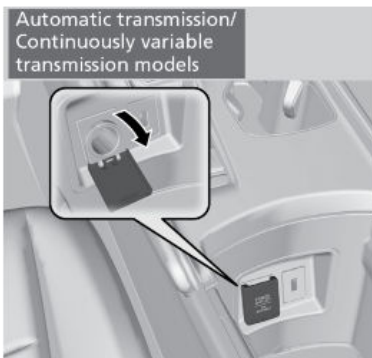

NOTICE

Do not insert an automotive type cigarette lighter element. This can overheat the power socket.

Adjusting the Sound

Models with Color Audio

Press the sound button, and rotate to scroll through the following choices:

- Bass
- Middle
- Treble
- Fader
- Balance
- Speed-sensitive Volume Compensation



Models with Display Audio

1. Press the Home button.
2. Select an audio source icon.
3. Select Sound.
4. Select the setting you want.
5. Select Save.

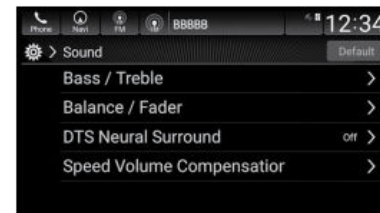

Select an item from the following choices:

- Bass / Treble: Treble, Midrange, Bass
- Balance / Fader: Balance, Fader
- DTS Neural Surround*1: DTS Neural Surround™
- Speed Volume Compensation: Speed Volume Compensation (SVC)

Color Audio System

Use the buttons to control the color audio system.



Display Audio System

Use simple gestures-including touching, swiping and scrolling-to operate certain audio functions.



*1 - If equipped

Note: Some items may be grayed out during driving to reduce the potential for distraction. You can select them when the vehicle is stopped or use voice commands.

Wearing gloves may limit or prevent touchscreen response.

HondaLink®

Models with Display Audio

A subscription-based service that provides convenient features such as voice communication in case of emergency, online security, and one-on-one operator assistance*1.

To check phone compatibility and get more information, visit handsfreelink.com (US). Canada customers can phone (855)-490-7351 for any HandsFreeLink® related inquiry. Standard data rates may apply with your phone service provider.

■ HondaLink® Connection

Follow the steps below to connect to HondaLink® Connection and use its features.

1. Open the cover attached to the ceiling console.
2. Press the ASSIST button.

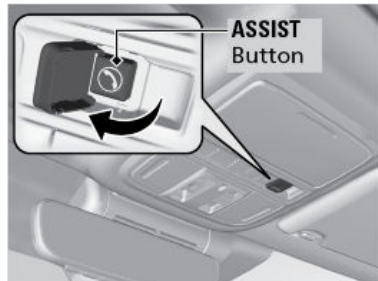

HondaLink® Assist*1

If your vehicle's airbags deploy or if the unit detects that the vehicle is severely impacted, your vehicle automatically attempts to connect to an operator. Your phone must be paired to the system and have good cellular connection. Visit www.hondalink.com (U.S.) or honda.ca/hondalinkassist (Canada) for more information.

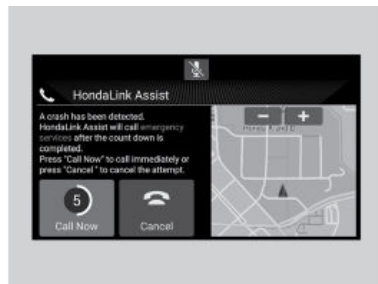

*1 - If equipped

Near Field Communication (NFC)*1 - Models with Display Audio

Near Field Communication (NFC) allows you to connect select Android phones to the audio system via *Bluetooth*®.

1. Press the Home button.
2. Select Settings.
3. Select Connections.
4. Select NFC, then ON.
5. Select Android Beam, then ON.

Note: Depending on your phone and cellular signal capability, your vehicle's location may not be sent to the operator.

■ *Bluetooth*® Setup

1. From the Home screen, select NFC Manager. Or touch the NFC logo near the glove box with the NFC tag of your phone. The NFC Manager screen is displayed.
2. Select Connect Device to Vehicle *Bluetooth*®.
3. Touch the NFC logo near the glove box with the NFC tag of your phone.

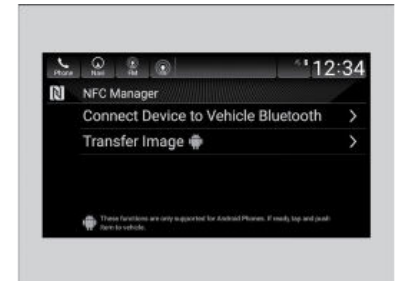
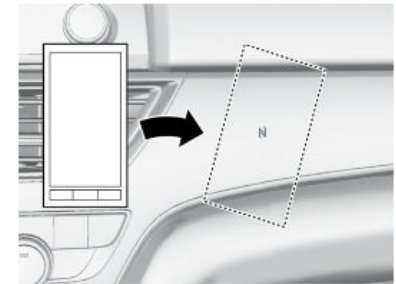
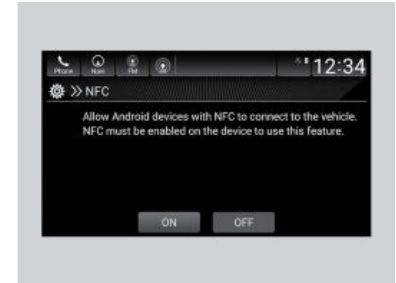

*1 - If equipped

- A notification appears on the screen if pairing is successful. Confirm if the pairing code on the screen and your phone match.

This may vary by phone.



■ Wallpaper Image Transfer

- From the Home screen, select NFC Manager or touch the NFC logo near the glove box with the NFC tag of your phone.
- Select Transfer Image.
- Open the photo you want to transfer on your phone, then select Next.
- Touch the NFC logo near the glove box with the NFC tag of your phone.
- Select the photo on your phone.
- A confirmation message appears on the screen. Select Wallpaper.

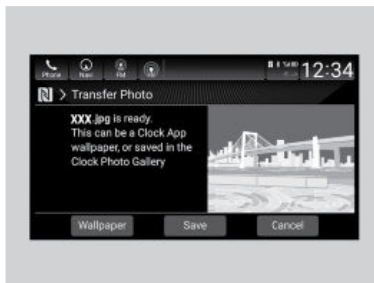
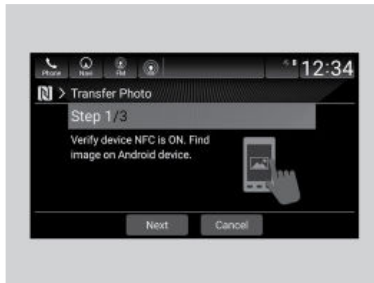
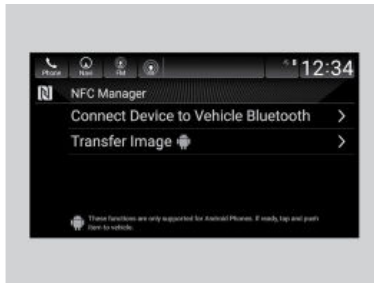

Apple CarPlay™

Models with Display Audio

Connect an Apple CarPlay™-compatible iPhone® to the system via the USB port in the center pocket or console compartment*1, you can use the audio/information screen, instead of the iPhone® display, to make a phone call, listen to music, view maps (navigation), and access messages.

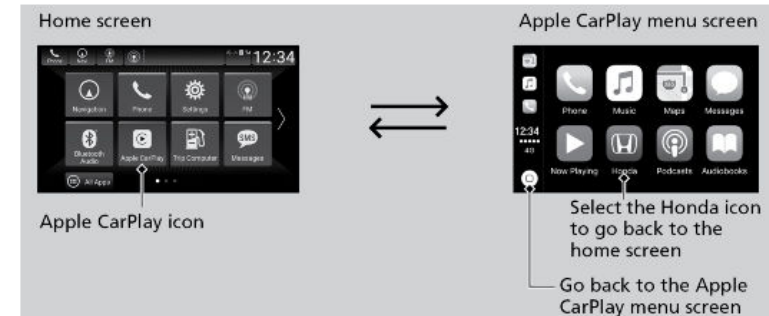

Phone: Access the contact list, make phone calls, or listen to voice mail.

Messages: Check and reply to text messages, or have messages read to you.

Music: Play music stored on your iPhone®.

Maps: Display Apple Maps and use the navigation function just as you would on your iPhone®.

Models with navigation system

Only one navigation system (pre-installed navigation or Apple CarPlay™) can give directions at a time. When you are using one system, directions to any prior destination set on the other system will be canceled, and the system you are currently using will direct you to your destination.

*1 - If equipped
Depending on use, Apple CarPlay™ can share certain vehicle information (e.g., vehicle location, speed, and other operating conditions) with the connected iPhone®. See Apple's privacy policy for details regarding Apple's use and handling of data uploaded by Apple CarPlay™. Use of Apple CarPlay™ is at user's own risk, and is subject to agreement to the Apple CarPlay™ terms of use, which are included as part of the Apple iOS terms of use. Apple CarPlay™ vehicle integration is provided "as is," and Honda cannot guarantee Apple CarPlay™ operability or functionality now or in the future due to, among other conditions, changes in Apple CarPlay™ software/Apple iOS, service interruptions, or incompatibility or obsolescence of vehicle-integrated hardware or software. See dealer for details. Only use Apple CarPlay™ when conditions allow you to do so safely. See your Owner's Manual at owners.honda.com (U.S.) or myhonda.ca (Canada) for further license and warranty terms.

Android Auto™

Models with Display Audio

When you connect an Android phone to the audio system via the USB, Android Auto™ is automatically initiated. When connected via Android Auto™, you can use the audio/information screen to access the Phone, Google Maps (Navigation), Google Play Music, and Google Now functions. When you first use Android Auto™, a tutorial will appear on the screen. We recommend that you complete this tutorial while safely parked before using Android Auto™.



1. **Maps (Navigation):** Display Google Maps and use the navigation function just as you would with your Android phone. When the vehicle is in motion, it is not possible to make keyboard entries. Stop the vehicle in a safe location to undertake a search or provide other inputs.

Models with navigation system

Only one navigation system (pre-installed navigation or Android Auto™) can give directions at a time. When you are using one system, directions to any prior destination set on the other system will be canceled, and the system you are currently using will direct you to your destination. The audio/Information screen shows you turn-by-turn driving directions to your destination.

2. **Phone (Communication):** Make and receive phone calls as well as listen to voicemail.
3. **Google Now (Home screen):** Display useful information organized by Android Auto™ into simple cards that appear just when they're needed.
4. **Music and audio:** Play Google Play Music and music apps that are compatible with Android Auto™. To switch between music apps, press this icon.
5. **Go back to the Home Screen**
6. **Voice:** Operate Android Auto™ with your voice.

Park in a safe place before connecting your Android smartphone and launching any compatible apps.

Wi-Fi Connection*1

1. Press the Home button.
2. Select Settings.
3. Select Connections.
4. Select Wi-Fi.
5. Select Change Mode.
6. Select Network or Hotspot, then Confirm.

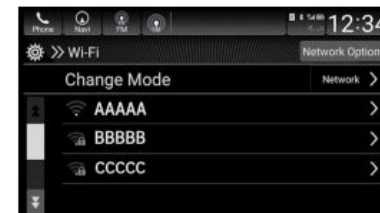

To change the Wi-Fi settings, select Network Options or HotSpot Options. Select the access point you want to connect to the system.

7. Select Connect.
Enter a password for the access point, and select Done.
When the connection is successful, the Wi-Fi icon is displayed on the list.
8. Press the Home button to go back to the Home screen.

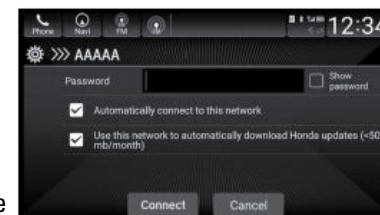

System Updates

■ Wireless Connection Setup

Depending on use, Android Auto can share certain vehicle information (e.g., vehicle location, speed, and other operating conditions) with Google and its service providers. See Google privacy policy for details regarding Google's use and handling of data uploaded by Android Auto. Use of Android Auto is at user's own risk, and is subject to agreement to the Android Auto terms of use, which are presented to the user when the Android Auto application is downloaded to the user's Android phone. Android Auto vehicle integration is provided "as is," and Honda cannot guarantee Android Auto operability or functionality now or in the future due to, among other conditions, changes in Android Auto software/Android operating system, service interruptions, or incompatibility or obsolescence of vehicle-integrated hardware or software. See dealer for details. Only use Android Auto when conditions allow you to do so safely. See your Owner's Manual at owners.honda.com (U.S.) or myhonda.ca (Canada) for further license and warranty terms.

*1 - If equipped

1. Press the Home button.
2. Select System Updates.
3. Select Settings.
4. Select Connection Setup.
5. Select Wi-Fi.
6. Select Change Mode.
7. Select Network, then Confirm.
The display returns to the network list.
8. Select an access point from the network list, then Save.
If the audio system requires a password, enter a password.

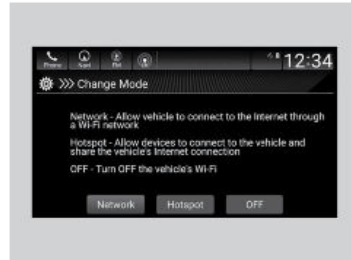
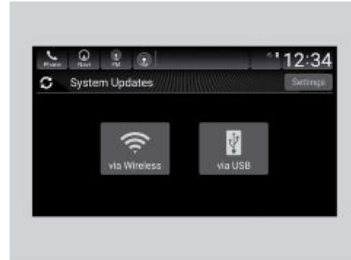

■ **Wireless Updating**

1. Press the Home button.
2. Select System Updates.
3. Select via Wireless. If a notification is displayed on the screen, the screen of step 5 will be displayed.
4. Select Download Now.
A notification appears on the screen.

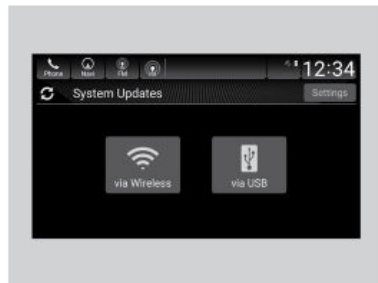
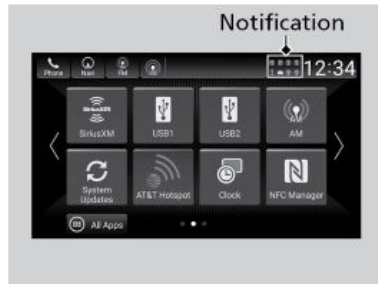

5. Select Install Now or Install while Vehicle OFF.
A notification appears on the screen if the update is successful.

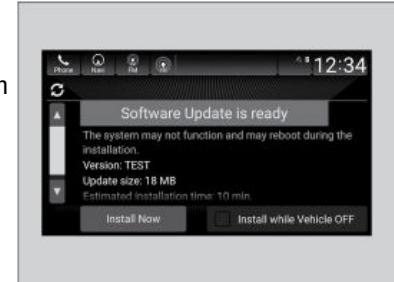

■ **USB Updating**

1. Press the Home button.
2. Select System Updates.
3. Select via USB.
A notification appears on the screen.
4. Connect a USB device into the USB port in the center pocket or console compartment*1.
The inventory data is copied into the USB device.
5. Remove the USB device from the USB port.
6. Connect the USB device into your computer, and then download the update files.
Follow the link to download the required software update files. Refer to <https://usb.honda.com> for instructions.

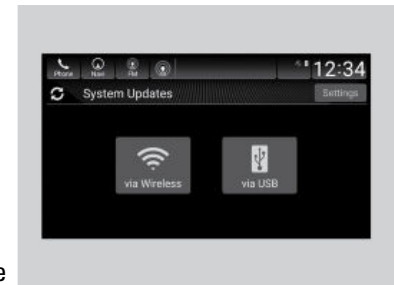

FM/AM Radio

Play FM or AM radio.

Models with Color Audio

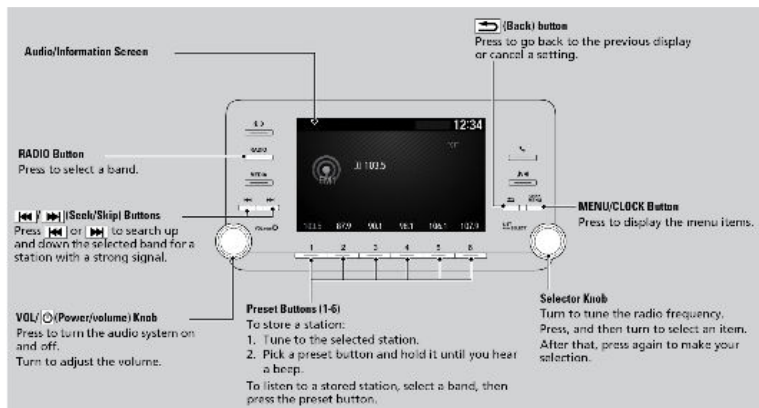

Models with Display Audio

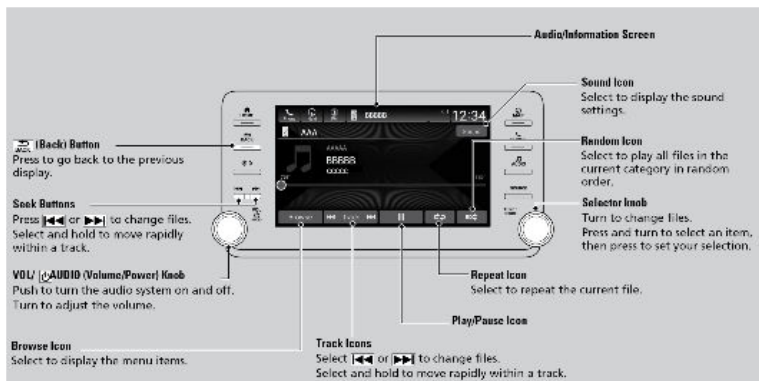

SiriusXM® *1

Models with Display Audio

Available on a subscription basis only. For more information or to subscribe, contact your dealer, or visit www.sirius.com/subscribenow (U.S.) or www.sirius.ca/subscribe-now (Canada).

To learn about additional features—such as multi-channel preset, replay, or SportsFlash—see your Owner's Manual at owners.honda.com (U.S.) or myhonda.ca (Canada).

*1 - If equipped

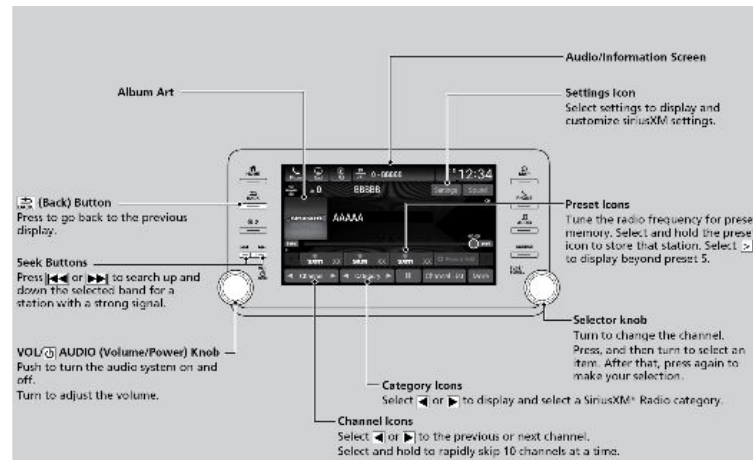

iPod®

Play and operate an iPod®*14 through the vehicle's audio system. Connect your device to the USB port (see USB Port).

Models with Color Audio

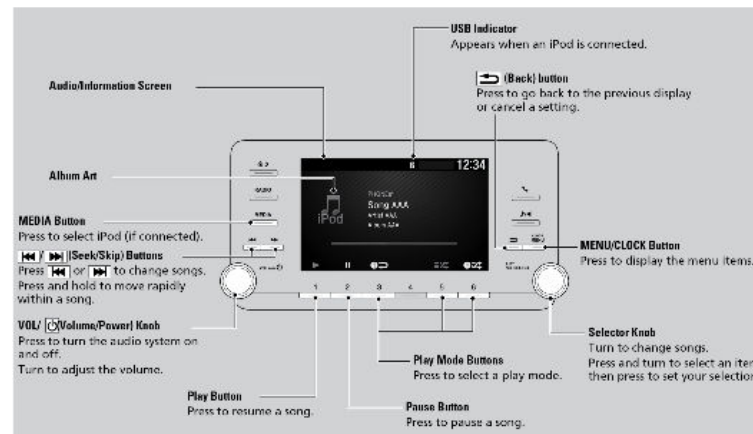

*14 - iPod and iPhone are trademarks of Apple, Inc.

Models with Display Audio

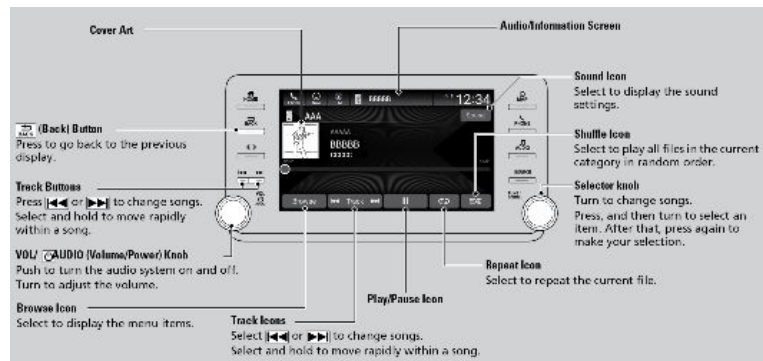

■ Searching for Music

Models with Color Audio

Use the selector knob to search for tracks stored on the iPod.

1. Press the selector knob to display the iPod® music list.
2. Rotate the selector knob to select a category.
3. Press the selector knob to display a list of items in the category.
4. Rotate the selector knob to select an item, then press the selector knob.
5. Press the selector knob and rotate it repeatedly until a desired item you want to listen to is displayed.

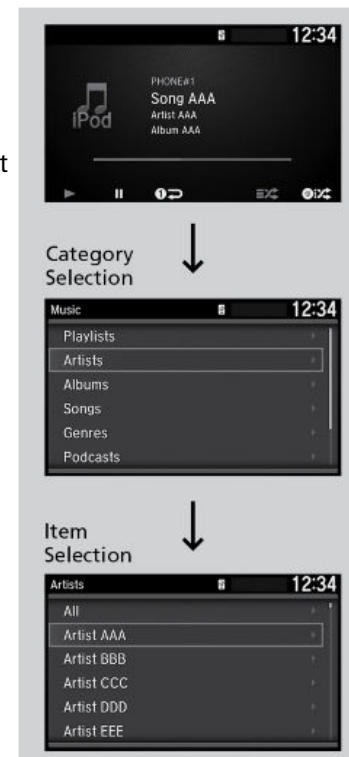

Models with Display Audio

Use the touchscreen to search for tracks stored on the iPod.

1. Select Browse.
2. Select a search category (e.g., Artists, Albums, etc.).
3. Continue making selections until you find the song of your choice.

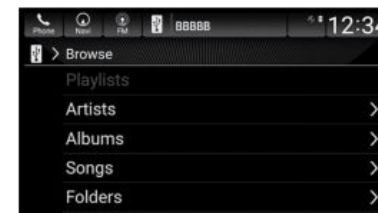

USB Flash Drive

Your audio system reads and plays sound files on a USB flash drive in either MP3, WMA, or AAC*1 format. Connect your USB flash drive to the USB port, then press the **MEDIA** button.

*1 - If equipped

Models with Color Audio

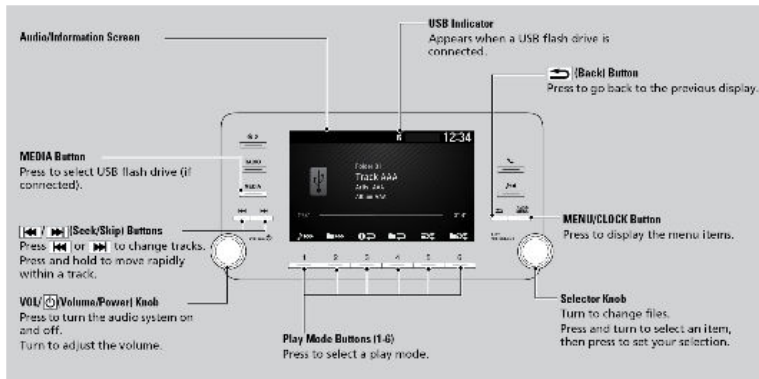

Models with Display Audio

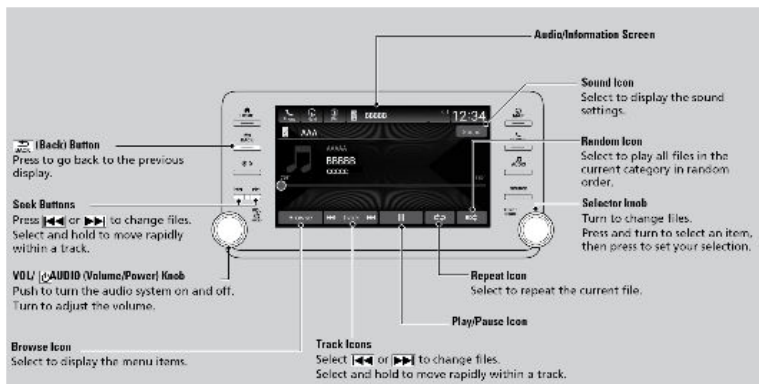

■ Searching for Music

Models with Color Audio

1. Press the selector knob to display a folder list.
2. Rotate the selector knob to select a folder.
3. Press the selector knob to display a list of files in that folder.
4. Rotate the selector knob to select a file, then press the selector knob.



Models with Display Audio

Use the touchscreen to search for tracks.

1. Select Browse.
2. Select a search category (e.g., Artists, Albums, etc.).
3. Continue making selections until you find the file of your choice.

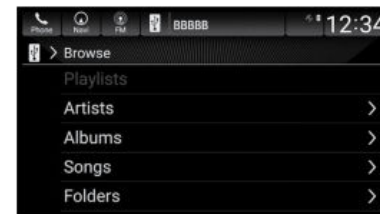

Bluetooth® Audio

Play streaming or stored audio from your compatible phone when it is paired to Bluetooth® HandsFreeLink® (see Pairing a Phone). Visit handsfreelink.com (US) to check phone compatibility. Canada customers can phone (855)-490-7351 for

any HandsFreeLink® related inquiry. Standard data rates apply with your phone service provider.

Models with Color Audio

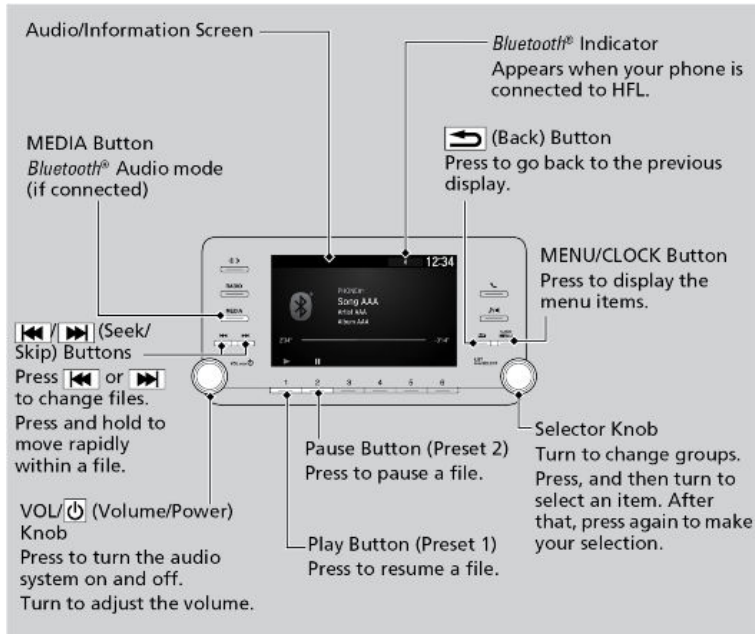

Models with Display Audio

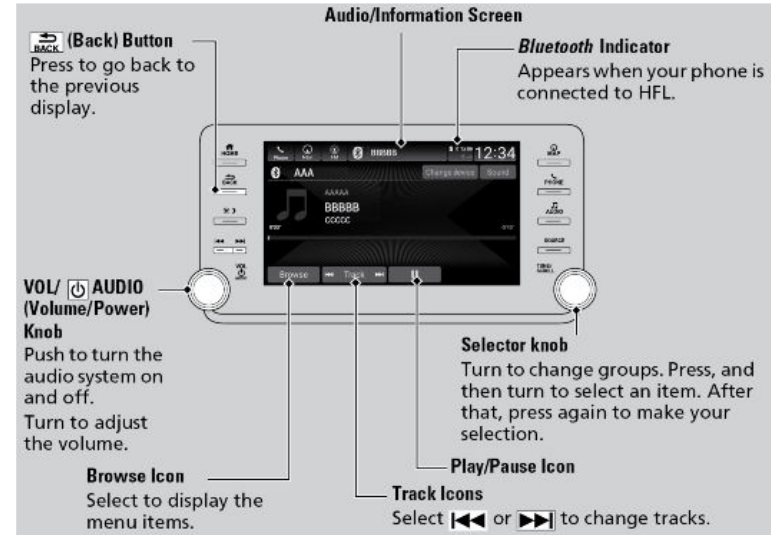

Applicable laws may prohibit the operation of handheld electronic devices while operating a vehicle. Launch streaming audio on your phone only when safe to do so.

■ Searching for Music

Models with Color Audio

1. Press the selector knob to display the music search list.
2. Rotate the selector knob to select a category.
3. Press the selector knob to display a list of items in the category.
4. Rotate the selector knob to select an item, then press the selector knob. Press and rotate the selector knob repeatedly until the desired item is displayed

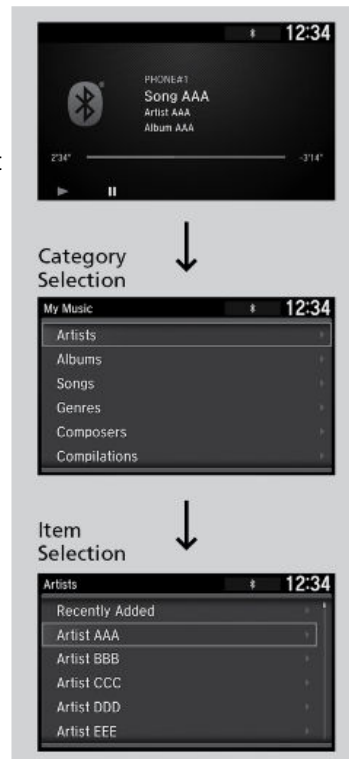

Models with Display Audio

1. Select Browse.
2. Select a search category (e.g., Albums).
3. Select an item. The selection begins playing.

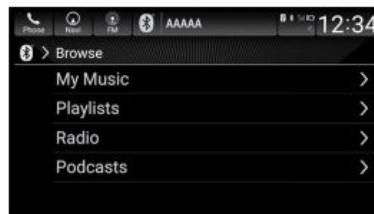

Note:

- Make sure the volume on your phone is properly adjusted.
- You may need to enable additional settings on your phone for playback.
- The resume/pause function and remote audio controls are not supported on all phones.

BLUETOOTH® HANDSFREELINK® (HFL)

Learn how to operate the vehicle's hands-free calling system.

Basic HFL Operation

Make and receive phone calls using the vehicle's audio system, without handling your phone. Visit handsfreelink.com (US) to check phone compatibility. Canada customers can phone (855)-490-7351 for any HandsFreeLink® related inquiry.

To reduce the potential for driver distraction, certain manual functions may be inoperable or grayed out while the vehicle is moving. Voice commands are always available.

■ HFL Displays and Controls

Use the controls to enter information and make selections.

Models with Color Audio

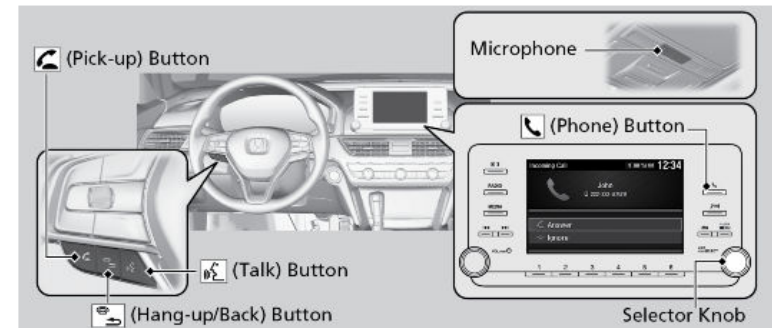

- (Pick-Up) button:** Press to go directly to the Phone screen or to answer an incoming call.
- (Hang-up/Back) button:** Press to end a call or to cancel a command.
- (Talk) button:** Press to call a number with a stored voice tag.
- (Phone) button:** Press to go directly to the Phone screen.
- Selector knob:** Rotate the selector knob to select an item on the screen, then press to select.

Models with Display Audio

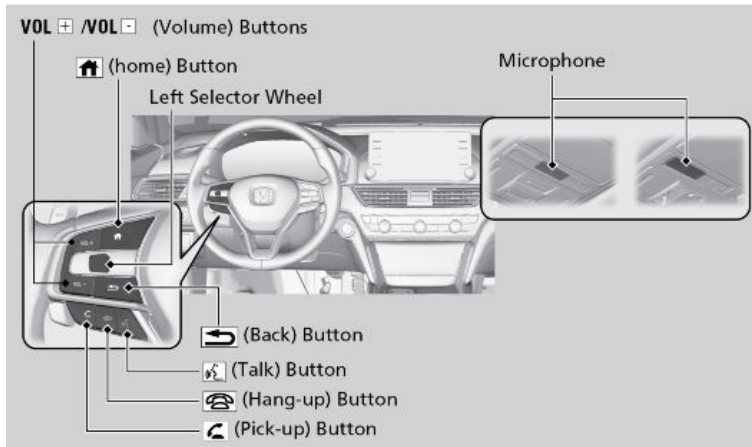

(Pick-Up) button: Press to go directly to the phone menu on the driver information interface, or to answer an incoming call.

(Hang-up) button: Press to end a call or to cancel a command.

(Back) button: Press to go back to the previous screen, or cancel a command.

(Talk) button: Press to access Voice Portal.

Left Selector Wheel: Press home button, then roll up or down to select Phone on the driver information interface, and then press the left selector wheel.

Home button: Press to go back to the home screen of the driver information interface.

■ **Talk Button Tips**

When using the Talk button, wait for the beep before saying a command. The system recognizes commands listed in the Voice Command Index.

- When using the Talk button, wait until you hear a beep before speaking.
- To bypass the system prompts, simply press the Talk button again to say your command.
- Speak in a clear, natural voice.
- Reduce all background noise.
- Adjust the dashboard vents away from the microphone on the ceiling.
- Close the windows and moonroof*1.

Pairing a Phone

To use hands-free phone and streaming audio functions, you must first pair your phone to the system. This can only be done when the vehicle is stopped. If there is an active connection to Apple CarPlay™ (see Apple CarPlay) or Android Auto™ (see Android Auto), pairing of additional Bluetooth-compatible devices is unavailable and Add Bluetooth Device is grayed out from the Bluetooth Device List screen.

■ **Pairing the First Phone**

Models with Color Audio

Use the selector knob to make and enter selections.

1. Press the Phone button.
2. Rotate the selector knob to select Yes, then press the selector knob.
3. Make sure your phone is in search or discoverable mode, then press the selector knob.
4. When your phone appears on the list, select it by pressing the selector knob.

If your phone does not appear, select Phone Not Found? and search for Bluetooth® devices using your phone. From your phone, select HandsFreeLink®.

Search for Bluetooth® devices using your phone. From your phone, select HandsFreeLink®.

5. The system gives you a pairing code on the audio/information screen. Confirm if the pairing code on the screen and your phone match. This may vary by phone.
6. A notification appears on the screen if pairing is successful.



Models with Display Audio

Use the touchscreen to make and enter selections.

*1 - If equipped

1. Press the Home button.
2. Select Phone.
3. Select Connect Phone.
4. Make sure your phone is in search or discoverable mode, then select + Connect New Device.

HFL automatically searches for a *Bluetooth*® device.

5. Select your phone when it appears on the list.

If your phone still does not appear, search for *Bluetooth*® devices using your phone.

From your phone, search for HandsFreeLink®.

6. The system gives you a pairing code on the audio/information screen.

Confirm if the pairing code on the screen and your phone match.

This may vary by phone.

7. Select desired functions and then select Save.

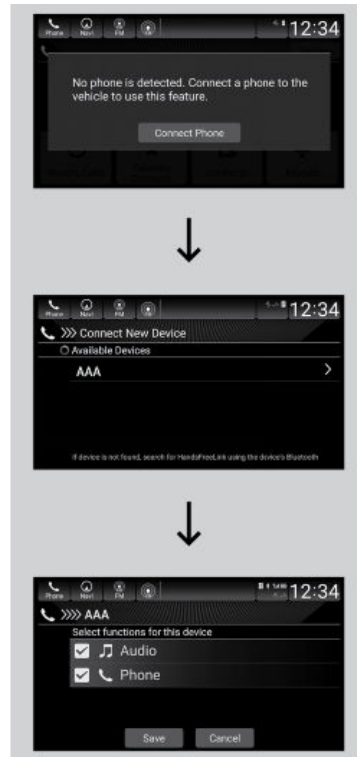

Making a Call

You can make calls by inputting any phone number, or by using the imported phonebook, call history, speed dial entries, or redial.

■ Dialing a Number

Models with Color Audio

1. Press the Phone button.
2. Select Dial.
3. Select a number.
4. Select the Phone button.

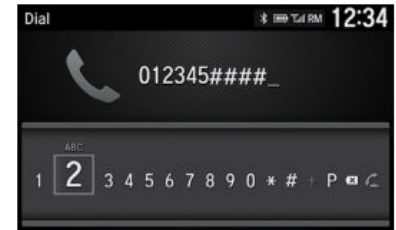

Models with Display Audio

1. Go to the phone menu screen.
2. Select Keypad.
3. Select a number.
Use the keyboard on the touch screen for entering numbers.
4. Select Call.
Dialing starts automatically.

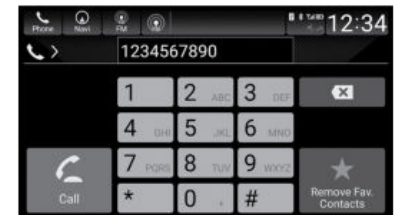

■ Using the Phonebook

When your phone is paired, its phonebook is automatically imported to the system.

This method is inoperable while the vehicle is moving.

Models with Color Audio

1. Press the Phone button.
2. Select Phonebook.
3. The phonebook is stored alphabetically.
4. Select a name.
5. Select a number.



Models with Display Audio

1. Go to the phone screen.
2. Select Contacts.
3. Select a name.
You can sort by First Name or Last Name. Select the icon on the upper right of the screen.
4. Select a number.
Dialing starts automatically.

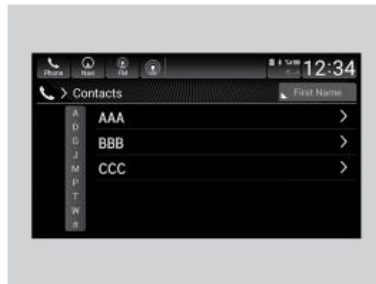

■ **Storing Speed Dial Entries**

Store up to 20 numbers for quick dialing. To store a speed dial number:

Models with Color Audio

1. Press the Phone button.
2. Select Speed Dial.
3. Select Add New.
4. Select a place to choose a number from.
From Call History:
Select a number from the call history.
From Phonebook:
Select a number from the connected cell phone's imported phonebook.
From Phone Number:
Input the number manually.
5. When the speed dial is successfully stored, you are asked to create a voice tag for the number. Select Yes or No.
6. Using the Talk button, follow the prompts to say the name for the speed dial entry.

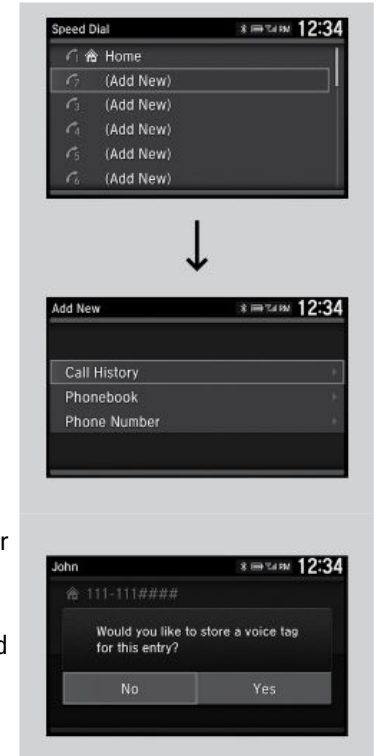

Models with Display Audio

1. Go to the phone menu screen.
2. Select the Recent Calls, Contacts, or Keypad screen.

3. Select the star icon.
A notification appears on the screen if the speed dial is successfully stored.
To remove the speed dial, select the star icon again.

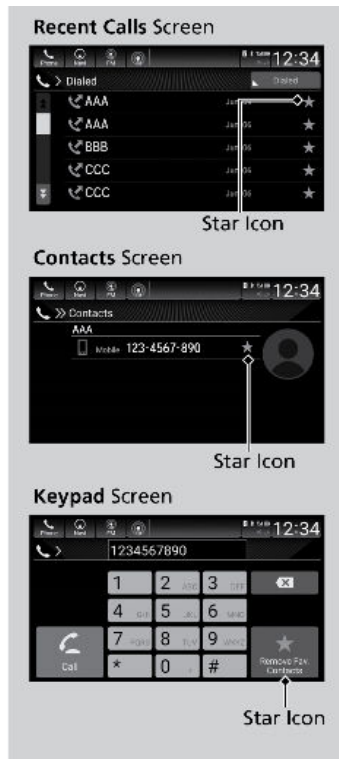

■ Using Speed Dial

Make calls quickly using stored speed dial entries or call history numbers.

Models with Color Audio

1. Press the Phone button.
2. Select Speed Dial.
3. Select a number.
Dialing starts automatically.



Models with Display Audio

1. Go to the phone menu screen.
2. Select Favorite Contacts.
You can change the order of speed dial entries by selecting Reorder.
3. Select a number.

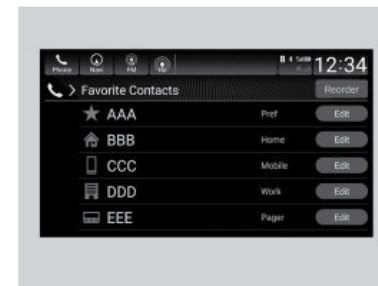

SMS Text Messaging and E-Mail*1

Certain phones can receive and send text messages and e-mails while paired and linked. Standard message rates apply. This feature is limited while the vehicle is moving. Visit handsfreelink.com (US) (U.S.) to check phone compatibility. Canada customers can phone (855)-490-7351 for any HandsFreeLink® related inquiry.

1. Press the Home button.
2. Select Messages.
3. Select Settings.
4. Select Pop-up Notification.
5. Select ON or OFF.

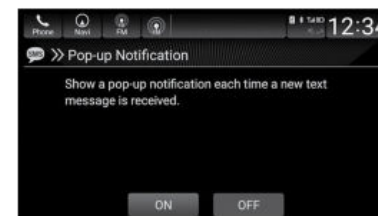

Siri Eyes Free™

Activate Siri through your vehicle when an iPhone® is paired to the system. Visit handsfreelink.com (US) to check phone compatibility. Canada customers can phone (855)-490-7351 for any HandsFreeLink® related inquiry.

*1 - If equipped

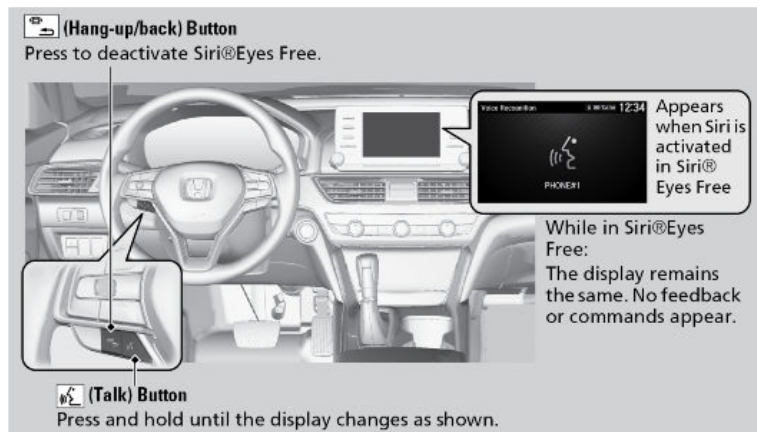

Models with Display Audio

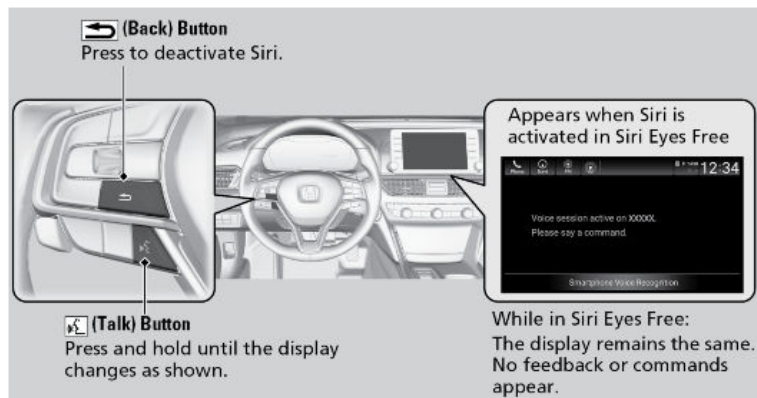

Here are some examples of Siri Commands:

- "Call John Smith"
- "Read my new text message"
- "Find a nearby sushi restaurant"
- "Remind me to pick up dinner"
- "Set up a meeting at 3 p.m."
- "Play song XYZ"

Note:

- Any requests that include visual feedback from Siri on your phone are not displayed in the vehicle.

- Certain commands rely on the iPhone's features and existing apps.
- To hear turn-by-turn directions or songs through the vehicle, set the audio source to *Bluetooth*® Audio.

You can talk to Siri using the Talk button on the steering wheel when your iPhone® is paired to the *Bluetooth*® HandsFreeLink®.

NAVIGATION

Learn how to enter a destination and operate the navigation system*1.

Basic Navigation Operation

A real-time navigation uses GPS and a map database to show your current location and help guide you to a desired destination. You can operate the system using voice commands or the system controls.

To reduce the potential of driver distraction, certain manual functions may be inoperable or grayed out while the vehicle is moving. Voice commands are always available.

Steering Wheel Controls

Use the steering wheel controls to give voice commands.



Left Selector Wheel  Button

Talk Button Tips

The system recognizes commands in the Voice Command Index, see Voice Portal Commands.

- When using the Talk button, wait for a beep before saying a command.
- To bypass the system prompts, simply press the Talk button again to say your command.
- Speak in a clear, natural voice.
- Reduce all background noise.
- Adjust the dashboard vents away from the microphone in the ceiling.
- Close the windows and moonroof*1.

System Guidance Volume

1. Press the Home button.
2. Select Settings.
3. Select System.
4. Select System Volumes.
5. Select System Volumes.



Navigation Display and Controls

Touch icons on the screen to enter information and make selections.



Entering Your Destination

There are several methods to enter a destination.

Home Address

Store your home address in the system so you can easily route to it.

*1 - If equipped

1. Select Set Home Location.

2. Select an option.

Select Use Current Location to set home location.

If selecting Enter My Address, Recently Found or Saved Place, proceed to steps 3 and 4.

3. Select the home location.

4. Select Select.



■ Street Address

1. Select the Map icon.

2. Select the Search icon.

3. Select Search Tools.

4. Select Address.

5. Enter the house number and street name. Select Done or a suggestion.

6. Select your destination from the list. Select Go!.

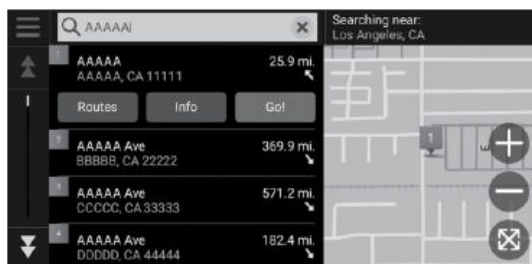
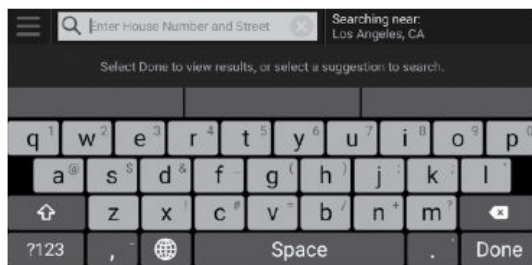

Routing

After a destination is set, you can alter or cancel your route.

■ Map Legend

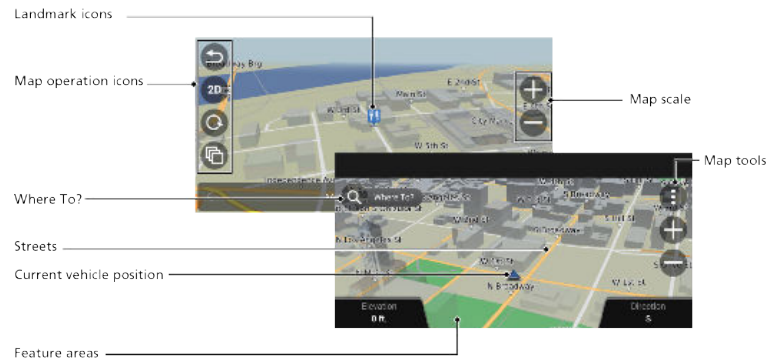

⚠ WARNING

Using the navigation system while driving can take your attention away from the road, causing a crash in which you could be seriously injured or killed.

Operate system controls only when the conditions permit you to safely do so.

DRIVING

Learn about preparation for driving, as well as other features.

Before Driving

Check the following items before you begin driving.

■ Exterior Checks

- Make sure there are no obstructions on the windows, door mirrors, exterior lights, or other parts of the vehicle.
- Remove any frost, snow, or ice.
- Make sure the hood is securely closed.
- Make sure the trunk is closed and locked.
- Heat from the engine and exhaust can ignite flammable materials left under the hood, causing a fire. If you've parked your vehicle for an extended period, inspect and remove any debris that may have collected, such as dried grass and leaves that have fallen or have been carried in for use as a nest by a small animal. Also check under the hood for leftover flammable materials after you or someone else has performed maintenance on your vehicle.
- Make sure the tires are in good condition.
- Make sure there are no people or objects behind or around the vehicle.

NOTICE

If the doors are frozen shut, use warm water around the door edges to melt any ice. Do not try to force them open, as this can damage the rubber trim around the doors. When done, wipe dry to avoid further freezing.

■ Interior Checks

- Store or secure all items on board properly.
- Do not pile items higher than the seat height.
- Do not place anything in the front seat footwells. Make sure to secure the floor mats.
- If you have any animals on board, do not let them move freely in the vehicle.
- Securely close and lock all doors and the trunk.
- Adjust your seating position, mirrors, and steering wheel properly.

- Make sure items placed on the floor behind the front seats cannot roll under the seats.
- Everyone in the vehicle must fasten their seat belt.
- Make sure that the indicators in the instrument panel come on when you start the vehicle, and go off soon after.

In addition:

- During the first 600 miles (1,000 km) of operation, avoid sudden acceleration or full throttle operation so as to not damage the engine or powertrain.
- Avoid hard braking for the first 200 miles (300 km). You should also follow this when the brake pads are replaced.

⚠ WARNING

Improper accessories or modifications can affect your vehicle's handling, and stability, and performance, and cause a crash in which you can be seriously hurt or killed.

Follow all instructions in the vehicle owner's manual regarding accessories and modifications.

Maximum Load Limit

Carrying too much cargo or improperly storing it can affect your vehicle's handling, stability, stopping distance, and tires, and make it unsafe. See the Tire and Loading Information label on the driver's doorjamb.

■ Maximum Load For Your Vehicle

The maximum load for your vehicle type is:

- 850 lbs (385 kg)

Label Example

TIRE AND LOADING INFORMATION			
SEATING CAPACITY		TOTAL X	FRONT X REAR X
The combined weight of occupants and cargo should never exceed XXXkg or XXXlbs.			
TIRE	SIZE	COLD TIRE PRESSURE	SEE OWNER'S MANUAL FOR ADDITIONAL INFORMATION
FRONT	XXXX/XXXXX XXX	XXXKPA, XXPSI	
REAR	XXXX/XXXXX XXX	XXXKPA, XXPSI	
SPARE	XXXX/XXXXX XXX	XXXKPA, XXPSI	

This figure includes the total weight of all occupants, cargo, and accessories, and the tongue load if you are towing a trailer. Below are the steps for determining the correct load limit:

1. Locate the statement "The combined weight of occupants and cargo should never exceed XXX kg or XXX lbs." on your vehicle's placard.
2. Determine the combined weight of the driver and passengers that will be riding in your vehicle.
3. Subtract the combined weight of the driver and passengers from XXX kg or XXX lbs.
4. The resulting figure equals the available amount of cargo and luggage load capacity. For example, if the "XXX" amount equals 1,400 lbs. (635 kg) and there will be five 150 lbs. passengers in your vehicle, the amount of available cargo and luggage load capacity is 650 lbs. (1,400 - 750 (5 x 150) = 650 lbs.).
5. Determine the combined weight of luggage and cargo being loaded on the vehicle. That weight may not safely exceed the available cargo and luggage load capacity calculated in step 4.
6. If your vehicle will be towing a trailer, load from your trailer will be transferred to your vehicle. Consult the Owner's Manual to determine how this reduces the available cargo and luggage load capacity of your vehicle.

⚠ WARNING

Overloading or improper loading can affect handling and stability and cause a crash in which you can be hurt or killed.

Follow all load limits and other loading guidelines in this guide.

In addition, the total weight of the vehicle, all occupants, accessories, cargo, and trailer tongue load must not exceed the Gross Vehicle Weight Rating (GVWR) or the Gross Axle Weight Rating (GAWR). Both are on a label on the driver's doorjamb.

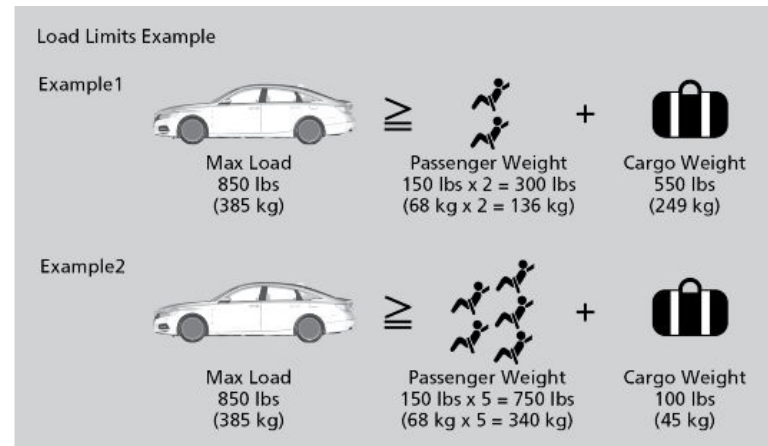

The headlight aim on your vehicle was set by the factory, and does not need to be adjusted. However, if you regularly carry heavy items in the cargo area or tow a trailer, have the aiming readjusted at your dealer or by a qualified technician.

Towing a Trailer

1.5 L engine models

Your vehicle is not designed to tow a trailer. Attempting to do so can void your vehicle warranties.

2.0 L engine models

Your vehicle can tow a trailer if you carefully observe the load limits, use the proper equipment, and follow the towing guidelines. See the Owner's Manual at www.owners.honda.com (U.S.) or myhonda.ca (Canada) for more information.

■ Towing Load Limits

Total trailer weight

Maximum allowable weight of the trailer, cargo, and everything in or on it must not exceed 1,000 lbs (450 kg). Towing loads in excess of this can seriously affect vehicle handling and performance and can damage the engine and drivetrain.

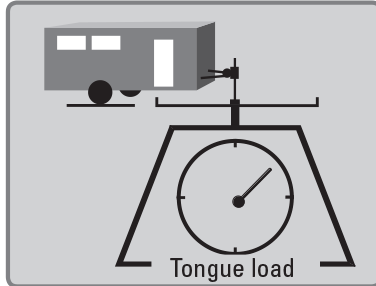

Tongue Load

The weight of the tongue with a fully loaded trailer on the hitch should be approximately 10% of the total trailer weight.

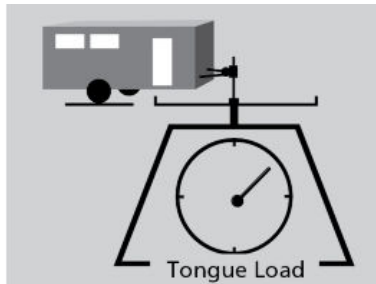

- Excessive tongue load reduces front tire traction and steering control. Too little tongue load can make the trailer unstable and cause it to sway.
- To achieve a proper tongue load, start by loading 60% of the load toward the front of the trailer and 40% toward the rear. Readjust the load as needed.

⚠ WARNING

Exceeding any load limit or improperly loading your vehicle and trailer can cause a crash in which you can be seriously hurt or killed. Check the loading of your vehicle and trailer carefully before starting to drive.

Pre-tow Checklist

When preparing to tow, and before driving away, ensure the following:

- The vehicle has been properly serviced, and the suspension and the cooling system are in good operating condition.
- Avoid towing a trailer during your vehicle's first 600 miles (1,000 km).

- The trailer has been properly serviced and is in good condition.
- All weights and loads are within limits. Never exceed the gross weight ratings.
- Check if all loads are within limits at a public scale.
- The hitch, safety chains, and any other attachments are secure.
- All items in or on the trailer are properly secured and cannot shift while you drive.

⚠ WARNING

Exceeding any load limit or improperly loading your vehicle and trailer can cause a crash in which you can be seriously hurt or killed. Check the loading of your vehicle and trailer carefully before starting to drive.

Towing Behind A Motorhome

Models with continuously variable transmission or Models with automatic transmission

Your vehicle is not designed to be towed behind a motorhome. If your vehicle needs to be towed in an emergency, refer to Emergency Towing.

Improper towing such as towing behind a motorhome or other motor vehicle can damage the transmission.

Models with manual transmission

Your vehicle can be towed behind a motorhome. Perform the following procedure before towing your vehicle:

1. Shift to Neutral.
2. Release the parking brake.
3. Turn the ignition switch (or power mode) to ACCESSORY. Make sure the steering wheel does not lock.
4. Turn off all electrical devices. Do not use any accessory power sockets. This can prevent the battery from running down.

Remote Engine Start with Vehicle Feedback*¹

Start your vehicle's engine using the remote transmitter before you enter the vehicle.

When started remotely, the engine automatically shuts off after 10 minutes of idling and/or the brake pedal and ENGINE START/STOP button have not been pressed simultaneously.

*1 - If equipped

Note: Make sure the vehicle is in a safe location when using remote engine start (i.e., a well-ventilated area, away from any flammable materials).

■ Starting the Engine

Press the Lock button, then press and hold the Engine button within 5 seconds to remotely start the engine.

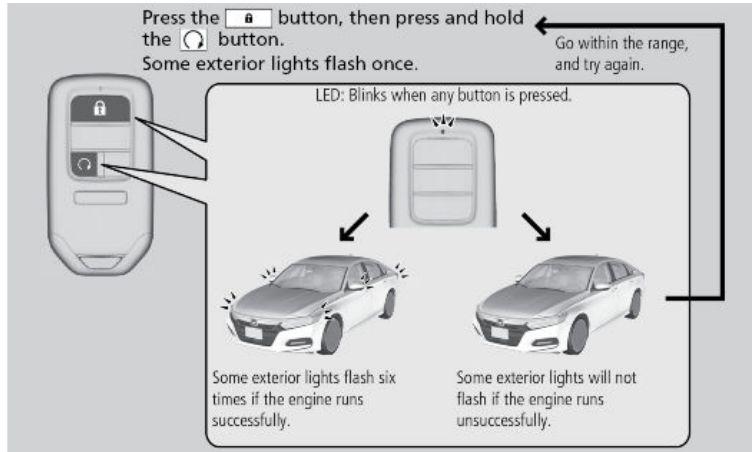

- The engine runs for up to 10 minutes. To extend the run time for another 10 minutes, repeat the procedure during the initial 10 minutes.
- The amber LED blinks, then the green LED comes back on if a 10-minute extension request was transmitted successfully.
- After pressing the (lock) button, wait for the green LED to blink. This indicates that the all the doors and the trunk are locked.

■ Stopping the Engine

When started remotely, the engine shuts off after 10 minutes of idling. It will also stop if the ENGINE START/STOP button and the brake are pressed individually.

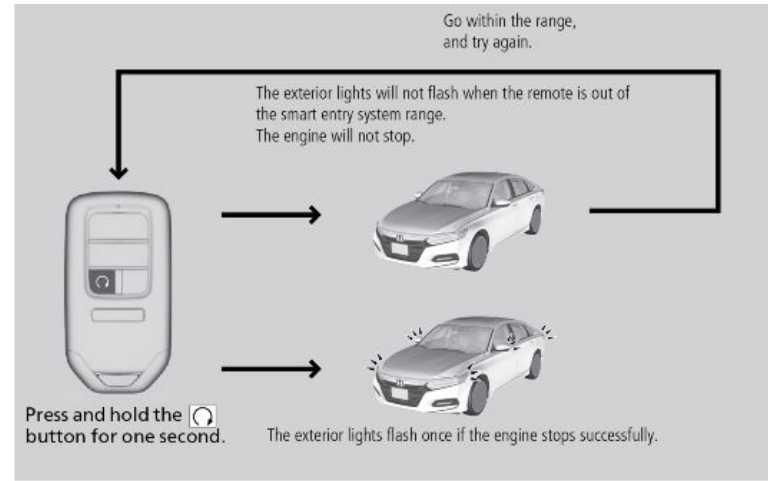

⚠ WARNING

Carbon monoxide gas is toxic and can rapidly accumulate in closed or even partly enclosed areas.

Breathing it can cause unconsciousness and even kill you.

Never use the remote engine starter with the vehicle parked in a garage or other areas with limited ventilation.

Starting to Drive

Turn on the vehicle and start the engine to begin driving.

■ Before Starting the Engine - Continuously Variable Transmission Models

1. Make sure the parking brake is applied.

The parking brake indicator (red) comes on for 30 seconds when you pull up the electric parking brake switch.

The parking brake must be applied to start the engine.



- Check that the transmission is in Park, then depress the brake pedal. Although it is possible to start the vehicle in Neutral with the parking brake applied, it is safer to start it in Park.

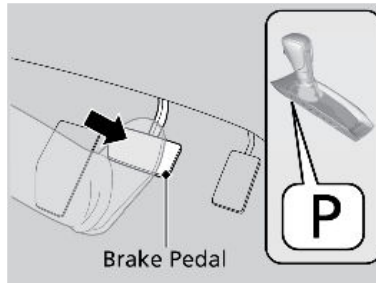

- Press the ENGINE START/STOP button without depressing the accelerator pedal.

Note: The engine is harder to start in cold weather and in thinner air found at altitudes above 8,000 feet (2,400 m). When starting the engine in cold weather, turn off all electrical accessories such as the lights, climate control system, and rear defogger in order to reduce battery drain.

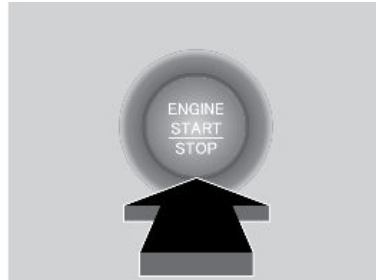

■ Before Starting the Engine - Automatic Transmission

- Make sure the parking brake is applied.

The parking brake indicator (red) comes on for 30 seconds when you pull up the electric parking brake switch.

The parking brake must be applied to start the engine.



- Depress the brake pedal.

Although it is possible to start the vehicle in Neutral with the parking brake applied, it is safer to start it in Park.

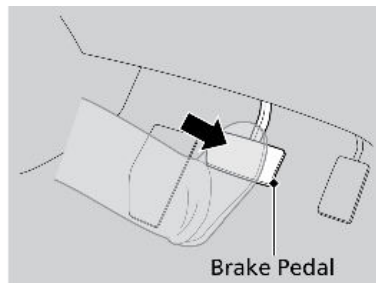

- Press the ENGINE START/STOP button without depressing the accelerator pedal.

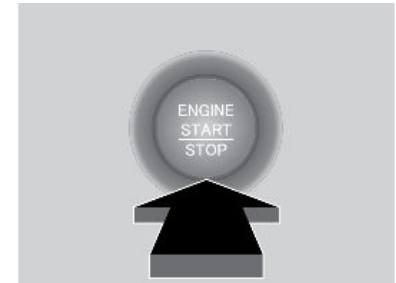

■ Before Starting the Engine - Manual Transmission Models

- Make sure the parking brake is applied.

The parking brake must be applied to start the engine.



- Check that the shift lever is in Neutral. Then depress the brake pedal with your right foot, and the clutch pedal with your left foot.

- Press the **ENGINE START/STOP***1 button / turn the ignition switch*1 to START without depressing the accelerator pedal.

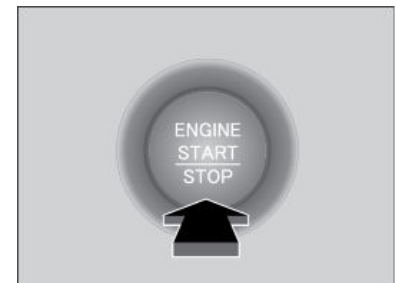
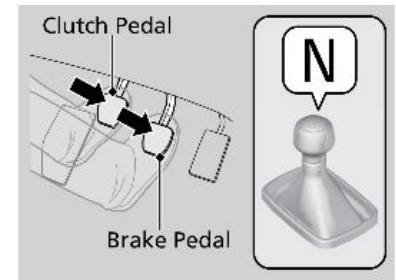

Note: The engine is harder to start in cold weather and in thinner air found at altitudes above 8,000 feet (2,400 m). When starting the engine in cold

weather, turn off all electrical accessories such as the lights, climate control system, and rear defogger in order to reduce battery drain.

■ **Changing the Power Mode*1**

Use the ENGINE START/STOP button to cycle through power modes or start the engine.

Accessory or On mode: Press the **ENGINE START/STOP** button once without pressing the brake pedal for Accessory mode. Press it again for On mode.

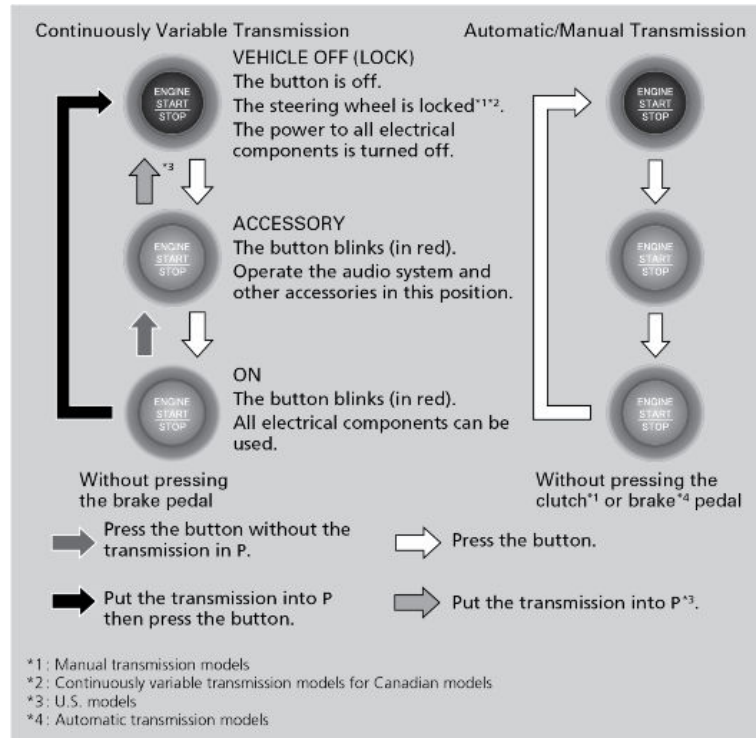

Shifting

Change the shift position based on your driving needs.

■ **Shift Lever*1**

Change the shift position in accordance with your driving needs.

Continuously Variable Transmission models*1



Park (P): Used for parking or starting/ stopping the engine. Press the brake pedal, then press the release button to shift.

Reverse (R): Used for reversing.

Neutral (N): Used for idling.

Drive (D): Used for normal driving.

Drive (S): Used for better acceleration, increased engine braking, driving in hilly terrain, or paddle shifting*1.

Low (L)*1: Used for increased engine braking.

NOTICE

When you change the shift lever from D to R and vice versa, come to a complete stop and keep the brake pedal depressed. Operating the shift lever before the vehicle has come to a complete standstill can damage the transmission.

*1 - If equipped

*1 - If equipped

Manual Transmission models*1

Fully press the clutch pedal to operate the shift lever and change gears, then slowly release the pedal.

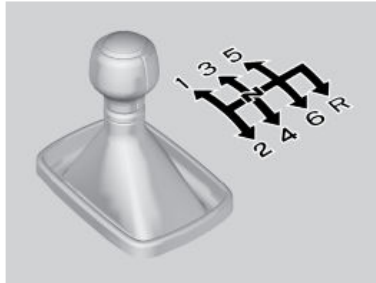
**NOTICE**

Do not shift to Reverse (R) before the vehicle comes to a complete stop. This can damage the transmission.

NOTICE

Before downshifting, make sure the engine will not go into the tachometer's red zone. This can severely damage your engine.

NOTICE

When you change the shift lever from D to R and vice versa, come to a complete stop and keep the brake pedal depressed. Operating the shift lever before the vehicle has come to a complete standstill can damage the transmission.

- **Paddle Shifters*1**

Use the paddle shifters to change gears without removing your hands from the steering wheel.

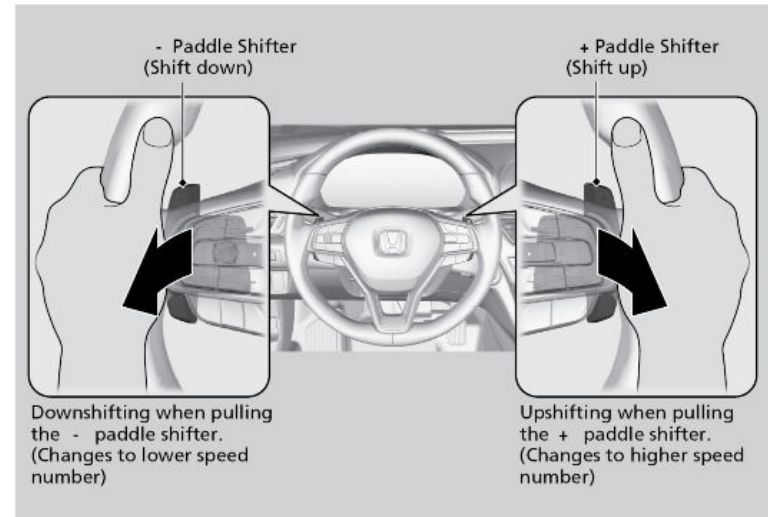

- **Electronic Gear Selector*1**

Select the vehicle's gear using a simple button interface. Apply the brake pedal and select a gear.

Park (P): Press the (P) button to put the vehicle in Park.

Reverse (R): Pull back the (R) button to put the vehicle in Reverse.

Neutral (N): Press the (N) button to put the vehicle in Neutral. Transmission is not locked.



*1 - If equipped

Drive: Press the **(D)** button to put the vehicle in Drive. Release the electric parking brake to begin driving.

⚠ WARNING

The vehicle can roll away if left unattended without confirming that Park **(P)** is engaged. Always keep your foot on the brake pedal until you have confirmed that **(P)** is shown on the gear position indicator.

NOTICE

When you change from **D** to **R** and vice versa, or want to change to Park **(P)**, come to a complete stop and keep the brake pedal applied. Operating the gear buttons before the vehicle has come to a complete standstill can damage the transmission.

Car wash mode

Follow the procedure below to use a conveyor-style car wash where you or an attendant do not remain in the vehicle. Make sure the wiper lever is in the OFF position. You should inform the car wash attendant of this procedure.

If the **ENGINE START/STOP** button is pressed while the vehicle is in car wash mode, the power mode will change to **ACCESSORY**.

Braking

Slow down or stop your vehicle, and keep it from moving when parked.

■ Foot Brake

Press the brake pedal to slow down or stop your vehicle from moving.

Your vehicle is equipped with disc brakes at all four wheels. A vacuum power assist helps reduce the effort needed on the brake pedal. The brake assist system increases the stopping force when you depress the brake pedal hard in an emergency situation. The anti-lock brake system (ABS) helps you retain steering control when braking very hard.

■ Electric Parking Brake

Keep the vehicle from moving when it is parked.

Use the parking brake to keep the vehicle stationary when parked. When the parking brake is applied, you can manually or automatically release it.

To apply

The electric parking brake can be applied any time the vehicle has battery, no matter which position the power mode is in. Pull the electric parking brake switch up gently and securely.

- The indicator in the switch comes on.
- The parking brake indicator (red) comes on.

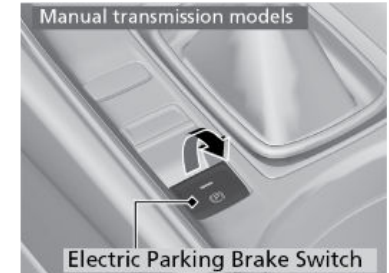

To release

The power mode must be in ON in order to release the electric parking brake.

1. Depress the brake pedal.
2. Press the electric parking brake switch.
 - The indicator in the switch goes off.
 - The parking brake indicator (red) goes off.

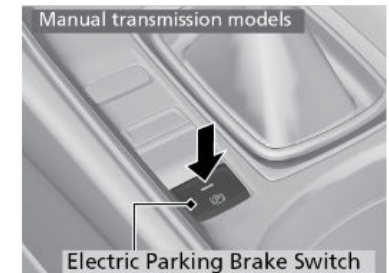
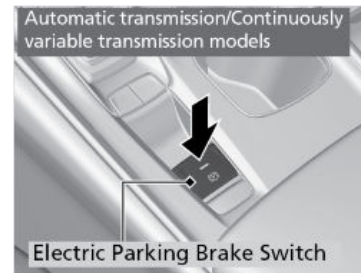

Manually releasing the parking brake using the switch helps your vehicle start slowly and smoothly when facing down hill on steep hills.



■ Automatic Brake Hold

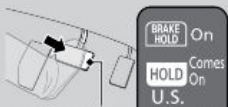

Automatic transmission/Continuously variable transmission models

Keeps the brake applied after releasing the brake pedal until the accelerator pedal is pressed. You can use this system while the vehicle is temporarily stopped, like at traffic lights and in heavy traffic.

<p>■ Turning on the system</p>  <p>Automatic Brake Hold Button</p> <p>Fasten your seat belt properly, then start the engine. Press the automatic brake hold button.</p> <ul style="list-style-type: none"> The automatic brake hold system indicator comes on. The system is turned on. 	<p>■ Activating the system</p>  <p>Brake Pedal</p> <p>Depress the brake pedal to come to a complete stop. The transmission must be in D, N, S* or L*.</p> <ul style="list-style-type: none"> The automatic brake hold indicator comes on. Braking is kept for up to 10 minutes. Release the brake pedal after the automatic brake hold indicator comes on. 	<p>■ Canceling the system</p>  <p>Accelerator Pedal</p> <p>Depress the accelerator pedal while the transmission must be in D, R, S* or L*. The system is canceled and the vehicle starts to move.</p> <ul style="list-style-type: none"> The automatic brake hold indicator goes off. The system continues to be on.
-----------------------------------------------------------------------------------------------------------------------------------------------------------------------------------------------------------------------------------------------------------------------------------------------------------------------------------------------------------------------------------------	---------------------------------------------------------------------------------------------------------------------------------------------------------------------------------------------------------------------------------------------------------------------------------------------------------------------------------------------------------------------------------------------------------------------------------------------------------------------	----------------------------------------------------------------------------------------------------------------------------------------------------------------------------------------------------------------------------------------------------------------------------------------------------------------------------------------------------------------------------------------------------------------------

* Not available on all models

Manual Transmission models

<p>■ Turning on the system</p>  <p>Automatic Brake Hold Button</p> <p>Fasten your seat belt properly, then start the engine. Press the automatic brake hold button.</p> <ul style="list-style-type: none"> The automatic brake hold system indicator comes on. The system is turned on. 	<p>■ Activating the system</p>  <p>Brake Pedal</p> <p>Depress the brake pedal to come to a complete stop.</p> <ul style="list-style-type: none"> The automatic brake hold indicator comes on. Braking is kept for up to 10 minutes. Release the brake pedal after the automatic brake hold indicator comes on. 	<p>■ Canceling the system</p>  <p>Clutch Pedal Accelerator Pedal</p> <p>Shift into one of the gears other than neutral and:</p> <ul style="list-style-type: none"> Release the clutch pedal on a level road or when facing downhill. Release the clutch pedal and depress the accelerator pedal when facing uphill. <p>The system is canceled and the vehicle starts to move.</p> <ul style="list-style-type: none"> The automatic brake hold indicator goes off. The system releases the brake automatically.
-----------------------------------------------------------------------------------------------------------------------------------------------------------------------------------------------------------------------------------------------------------------------------------------------------------------------------------------------------------------------------------------	-------------------------------------------------------------------------------------------------------------------------------------------------------------------------------------------------------------------------------------------------------------------------------------------------------------------------------------------------------------------------------------------------------------------------	--------------------------------------------------------------------------------------------------------------------------------------------------------------------------------------------------------------------------------------------------------------------------------------------------------------------------------------------------------------------------------------------------------------------------------------------------------------------------------------------------------------------------------------------------------------------------------------------------------------------------------------------

■ Brake Assist System

During hard or emergency braking, the system increases braking force. The brake pedal may move slightly or make a noise; this is normal. Continue to hold the brake pedal firmly down.

■ Anti-Lock Brake System (ABS)

During hard or emergency braking, the system rapidly pumps the brakes to prevent wheel lockup and help you maintain steering control. Do not pump the brake pedal, rather continue to hold it firmly down.

The electronic brake distribution (EBD) system, which is part of the ABS, also balances the front-to-rear braking distribution according to vehicle loading.

When ABS activates, you may notice vibrations through the brake pedal or the vehicle body, the brake pedal depressing further than usual, or hear a motor noise from the engine compartment. These are all normal.

NOTICE

The ABS may not function correctly if you use an incorrect tire type and size.

Ambient Meter

Color-coded bars around the speedometer change based on your driving style and brake or accelerator pedal operation.

Green: Fuel efficient driving

Light green: Moderate acceleration/deceleration

White: Aggressive acceleration/deceleration

With SPORT mode*¹ off, the color of the ambient meter changes to green to indicate that the vehicle is being driven in a fuel efficient manner.

Ambient Meter



*1 - If equipped

Vehicle Stability Assist® (VSA®) System

Helps to stabilize the vehicle during cornering if the vehicle turns more or less than what was intended. It assists in maintaining traction on slippery surfaces by regulating engine output and selectively applying the brakes. VSA is also known as Electronic Stability Control (ESC).

■ Turning VSA On or Off

This button is on the driver side control panel. To partially disable VSA® functionality/features, press and hold it until you hear a beep.

To restore VSA® functionality/features, press the (VSA® OFF) button until you hear a beep.

VSA® is turned on every time you turn the power system on, even if you turned it off the last time you drove the vehicle.

VSA® is turned on every time you start the engine, even if you previously turned it off. If you turn VSA® off, your vehicle has normal braking and cornering ability, but VSA® traction and stability enhancement become less effective.

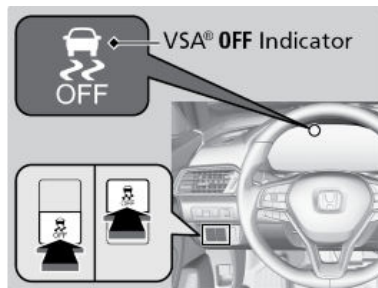
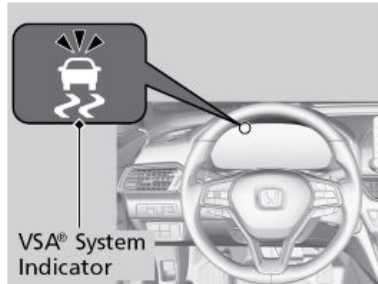

Honda Sensing®

A driver support system which employs the use of two distinctly different kinds of sensors, a radar sensor located in the front grille and a front sensor camera mounted to the interior side of the windshield, behind the rearview mirror.

These are the components of Honda Sensing®:

Adaptive Cruise Control with Low Speed Follow (ACC with Low Speed Follow)*1:

Helps maintain a constant vehicle speed and a set following-interval behind a vehicle detected ahead of yours and, if the detected vehicle comes to a stop, can decelerate and stop your vehicle, without you having to keep your foot on the brake or the accelerator.

Adaptive Cruise Control (ACC)*1: Helps maintain a constant vehicle speed and a set following interval behind a vehicle detected ahead of yours, without you having to keep your foot on the brake or the accelerator.

Lane Keeping Assist System (LKAS): Provides steering input to help keep the vehicle in the middle of a detected lane and provides tactile and visual alerts if the vehicle is detected drifting out of its lane.

Road Departure Mitigation (RDM) System: Alerts and helps to assist you when the system detects a possibility of your vehicle unintentionally crossing over detected lane markings and/or leaving the roadway altogether.

Traffic Sign Recognition System: Reminds you of road sign information, such as the current speed limit your vehicle has just passed through, showing it on the driver information interface.

Collision Mitigation Braking System™ (CMBS™): Can assist you when there is a possibility of your vehicle colliding with a vehicle or a pedestrian detected in front of yours. The CMBS™ is designed to alert you when a potential collision is determined, as well as to reduce your vehicle speed to help minimize collision severity when a collision is deemed unavoidable.

■ "Some Driver Systems Cannot Operate" Information Message

Honda Sensing® is deactivated and this message appears when:

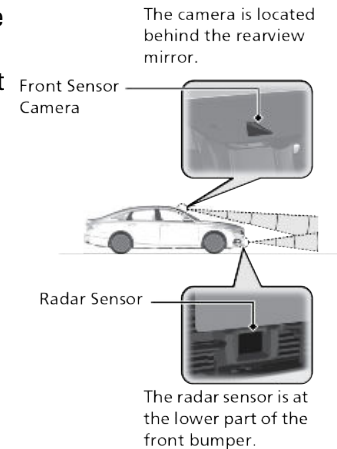

Anything covers the radar sensor cover or the area around the front sensor camera preventing detection of a vehicle in front. May appear when driving in bad weather (rain, snow, fog, etc.).

- Stop your vehicle in a safe place and clear the area using a soft cloth.
- Have your vehicle checked by a dealer if the message does not disappear even after you clean the area.

Adaptive Cruise Control (ACC)*¹ with Low Speed Follow*¹

Helps maintain a constant vehicle speed and a set following interval behind a vehicle detected ahead of yours. When the vehicle ahead changes speed, ACC senses the change and accelerates or decelerates to maintain a set interval. and, if the detected vehicle comes to a stop, can decelerate and stop your vehicle, without you having to keep your foot on the brake or the accelerator. When ACC with Low Speed Follow slows your vehicle by applying the brakes, your vehicle's brake lights will illuminate.

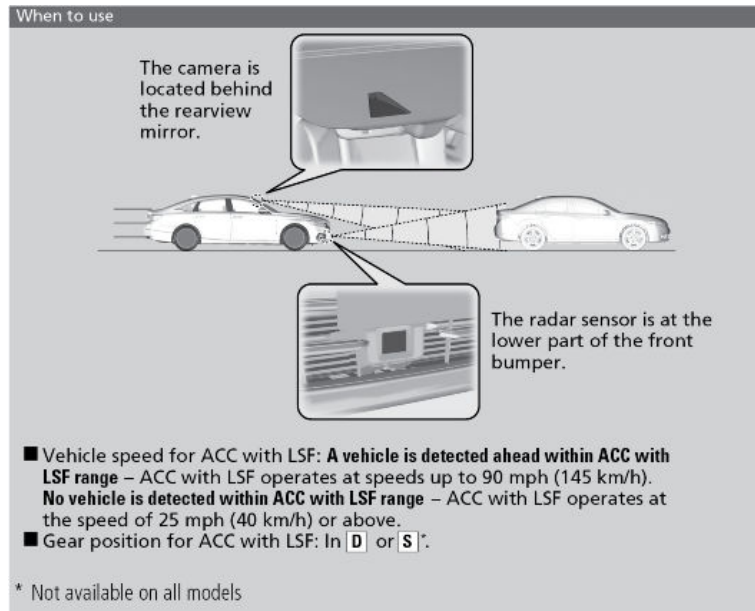

■ Activating and Setting the Vehicle Speed

1. Press the MAIN button. The ACC indicator appears in the multi-information display.

- Press the **MAIN** button on the steering wheel.



2. Accelerate to the desired speed (above 25 mph/40 km/h). Take your foot off the pedal and press the DECEL/SET button to set the speed.

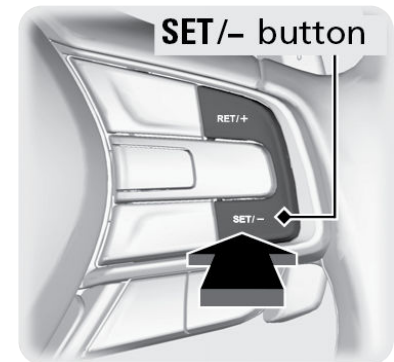

Press and release

*¹ - If equipped

■ **Adjusting the Vehicle Speed**

Press the RES/+ button to increase speed or the SET/- button to decrease speed. Each time you press the button, the vehicle speed is increased or decreased by about 1 mph (1.6 km/h). If you keep the button pressed, the vehicle speed increases or decreases by 5 mph or 5 km/h until you release it.

To increase speed

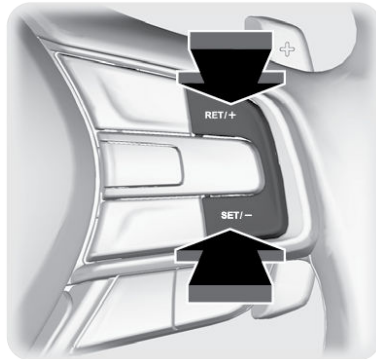

To decrease speed

■ **Adjusting the Vehicle Distance**

Press the Interval button to change the following interval. Each time you press the button, the setting cycles through extra long, long, middle, and short.

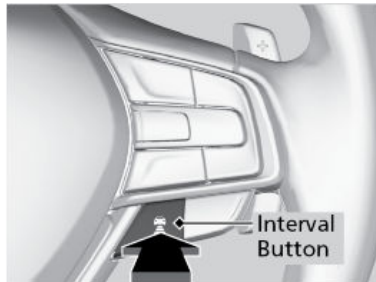

■ **During Operation**

If a vehicle is detected ahead of you when ACC is turned on, the system maintains, accelerates, or decelerates your vehicle's set speed to keep the vehicle's set following interval from the vehicle ahead.

If a vehicle detected ahead of you slows down abruptly, or if another



vehicle cuts in front of you, a beep sounds and BRAKE appears on the driver information interface to alert you .

⚠ WARNING

ACC has limited braking capability. When your vehicle speed drops below 22 mph (35 km/h), ACC will automatically cancel and no longer will apply your vehicle's brakes. Always be prepared to apply the brake pedal when conditions require.

■ **Canceling ACC**

You can press the CANCEL button, MAIN button or the brake pedal. The ACC with Low Speed Follow indicator goes off.

Certain conditions may cause ACC to cancel automatically. When this happens, appears on the driver information interface.

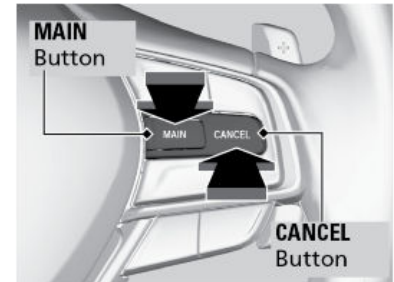

⚠ WARNING

Improper use of ACC can lead to a crash. Use ACC only when traveling on open highways in good weather.

■ **Switching to Standard Cruise Control**

Press and hold the Interval button for one second.

Cruise Mode Selected appears in the driver information interface for two seconds, and then the mode switches to Cruise. Press and hold the interval button again to switch back to ACC .

ACC Mode Selected appears on the driver information interface display for two seconds.

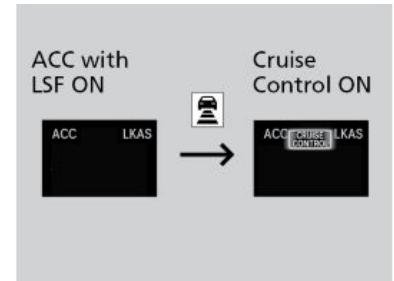

Lane Keeping Assist System (LKAS)

Provides steering input to help keep the vehicle in the middle of a detected lane and provides audible and visual alerts if the vehicle is detected drifting out of its lane while driving between 45–90 mph (72–145 km/h).

■ **Steering input assist**

The system applies torque to the steering to keep the vehicle between the left and right lane lines. The applied torque becomes stronger as the vehicle gets closer to either of the lane lines.

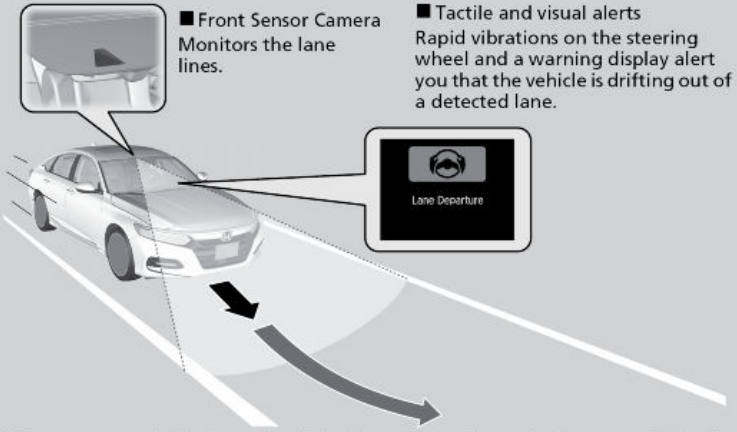

When you operate the turn signals to change lanes, the system is suspended, and resumes after the signals are off.
If you make a lane change without operating the turn signals, the LKAS alerts activate, and torque is applied to the steering.

■ **Turning the System On or Off**

1. Press the MAIN button. LKAS appears in the driver information interface.
2. Press the LKAS button. Lane outlines appear in the driver information interface. Dotted lane lines turn solid when the system activates.
3. Press the MAIN button or the LKAS button to turn the system off.

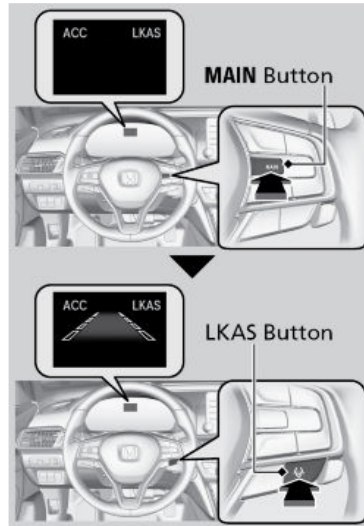

■ **Important Safety Reminder**

LKAS is for your convenience only. It is not a substitute for your vehicle control. The system does not work if you take your hands off the steering wheel or fail to steer the vehicle.

Do not place an object on the top of the instrument panel. It may reflect onto the windshield and prevent the system from detecting lane lines properly.

Road Departure Mitigation (RDM)

Alerts and helps to assist you if the system determines a possibility of your vehicle unintentionally crossing over detected lane markings and/or leaving the roadway altogether while driving between 45-90 mph (72-145km/h).

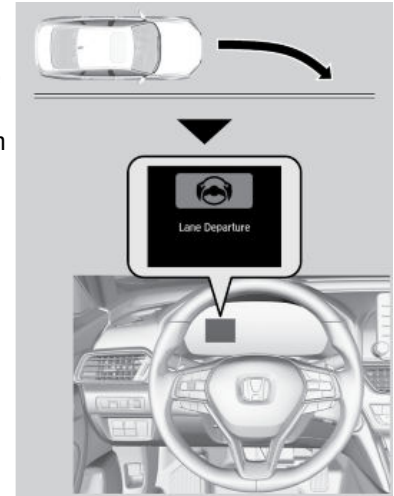

■ **Turning the System On or Off**

Press the RDM button to turn the system on or off. A green indicator appears on the button when the system is on.

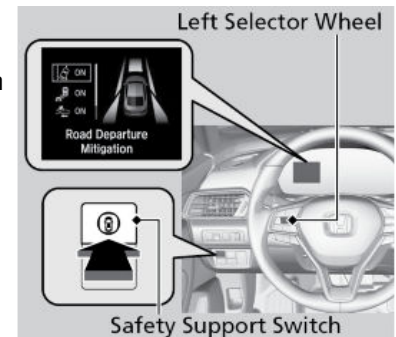

■ **Changing Settings**

1. From the HOME screen, select Settings.
2. Select Vehicle.
3. Select Driver Assist System Setup.

4. Select Road Departure Mitigation Setting.
5. Select from the options.

■ Important Safety Reminder

The RDM system has limitations. Over-reliance on it may result in a collision. It is always your responsibility to keep your vehicle within the driving lane.

Traffic Sign Recognition System

Reminds you of road sign information, such as the current speed limit your vehicle has just passed through, showing it on the driver information interface and the head-up display.

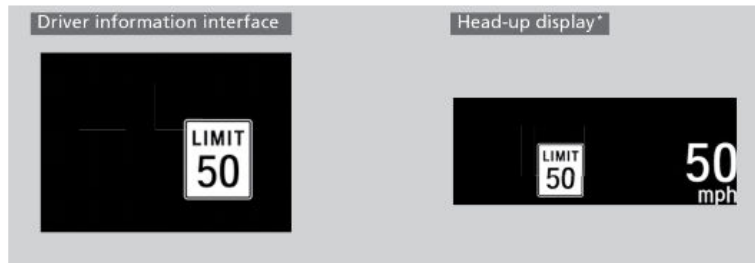

* Not available on all models

How the System Works:

When the camera located behind the rearview mirror captures traffic signs while driving, the system displays the ones that are recognized as designated for your vehicle. The sign icon will be displayed until the vehicle reaches a predetermined time and distance.

Limitations:

- Headlight lenses are dirty or the headlights are not properly adjusted.
- The outside of the windshield is blocked by dirt, mud, leaves, wet snow, etc.
- The inside of the windshield is fogged.
- There are portions remaining to be wiped.

Collision Mitigation Braking System™ (CMBS™)

Can assist you when there is a possibility of your vehicle colliding with a vehicle or a pedestrian detected in front of yours. The CMBS™ is designed to alert you when a potential collision is determined, as well as to reduce your vehicle speed to help minimize collision severity when a collision is deemed unavoidable.

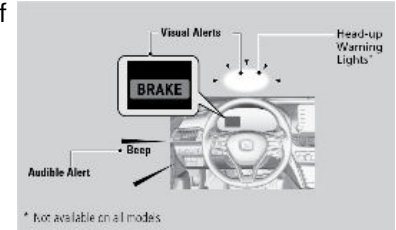

When a potential collision with a detected oncoming vehicle is determined, a BRAKE message appears, the head-up warning lights flash, a beep sounds, and the steering wheel vibrates.

■ Alert Stages

The system has three alert stages for a possible collision. Depending on the circumstances or CMBS™ settings, CMBS™ may not go through all of the stages before initiating the last stage.

Stage 1: Visual and audible warning.

Stage 2: Visual and audible warning, light brake application.

Stage 3: Visual and audible warning, strong brake application.

■ Changing Settings

1. From the HOME screen, select Settings.
2. Select Vehicle Settings. Then select Driver Assist.
3. Select Forward Collision Warning Distance.

■ Turning the System On or Off

When you turn the CMBS™ on and off, do the following.

1. Press the safety support switch.
2. Roll the left selector wheel to the CMBS™ symbol and select it.

A beep sounds and a message appears in the Driver Information Interface.

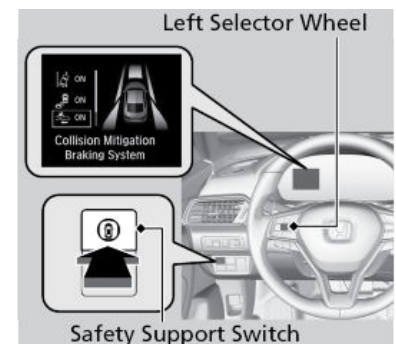

■ Important Safety Reminder

CMBS is designed to reduce the severity of an unavoidable collision. It does not prevent collisions nor stop the vehicle automatically. It is still your responsibility to operate the brake pedal and steering wheel appropriately according to the driving conditions.

Blind Spot Information System*¹

Alerts you to a detected vehicle in your left or right blind spot while driving between 20 mph (32 km/h) and 100 mph (160 km/h). When the system detects vehicles approaching from behind in adjacent lanes, the appropriate indicator comes on for a few seconds, providing assistance when you change lanes.

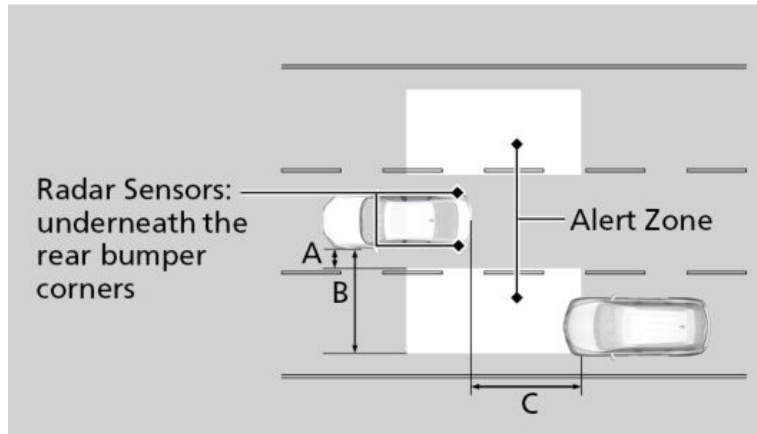

Blind Spot Information System Alert Indicator comes on when:

- A vehicle enters the alert zone from behind to overtake you with a speed difference of no more than 31 mph (50 km/h) from your vehicle.
- You pass a vehicle with a speed difference of no more than 12 mph (20 km/h).

When your turn signal is on and a vehicle is detected, the blind spot indicator blinks and a beep sounds until the area is clear or the turn signal is off.

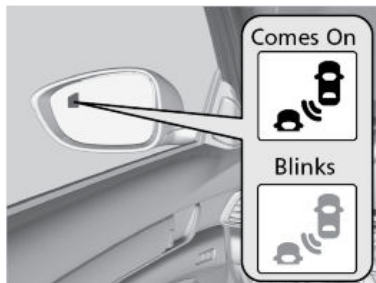

■ Changing Settings

1. From the Home screen, select Settings.
2. Select Vehicle Settings. The vehicle must be in Park (P).
3. Select Driver Assist System Setup.
4. Select Blind Spot Info.

■ Important Safety Reminder

Like all assistance systems, the Blind Spot Information System has limitations. Over-reliance on the system may result in a collision. The system is for your convenience only.

⚠ WARNING

Failure to visually confirm that it is safe to change lanes before doing so may result in a crash and serious injury or death. Do not rely only on the blind spot information system when changing lanes.

Always look in your mirrors, to either side of your vehicle, and behind you for other vehicles before changing lanes.

LaneWatch™*¹

Allows you to check the passenger side rear areas displayed on the audio/information screen when the turn signal is activated to the passenger's side.

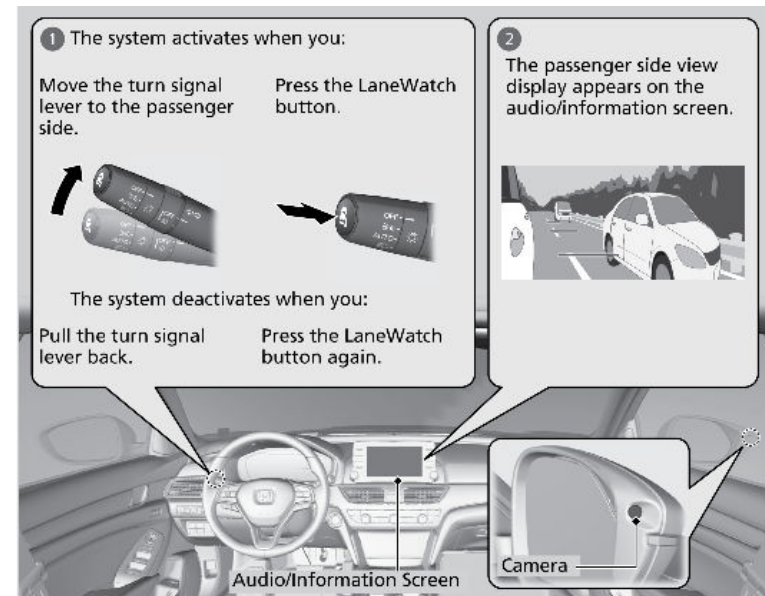

*¹ - If equipped

*¹ - If equipped,

■ **Activating LaneWatch**

Activate the right turn signal. The LaneWatch display appears. Check the display for blind spots, and visually confirm that it is safe to change lanes.

You can also press the LaneWatch button on the end of the turn signal switch to view a constant real-time display. Press it again to turn the display off.

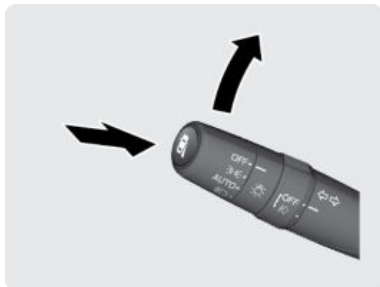

■ **Changing Settings**

Customize the display and how and when the display appears.

1. From the Home screen, select Settings.
2. Select Camera.
3. Select LaneWatch.
4. Select an option and make the preferred changes.
5. Press BACK to exit the menu.

■ **Important Safety Reminder**

Like all assistance systems, LaneWatch has limitations. Over-reliance on the system may result in a collision.

Parking Sensor System*1

The corner and center sensors monitor obstacles near your vehicle. The beeper and audio/information screen let you know the approximate distance between your vehicle and the obstacle.

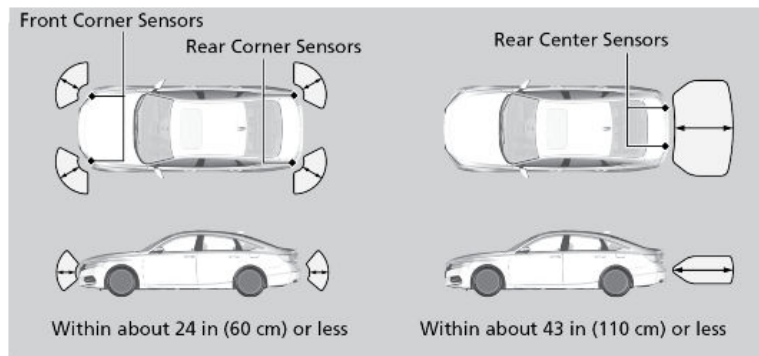

*1 - If equipped

■ **Turning the System On or Off**

Press the parking sensor button to turn the system on or off. The indicator light appears on the button when the system is on.



Cross Traffic Monitor*1

Alerts you if a detected vehicle is approaching from a rear corner when your vehicle is in Reverse (R) at speeds of 3 mph (5 km/h) or lower.

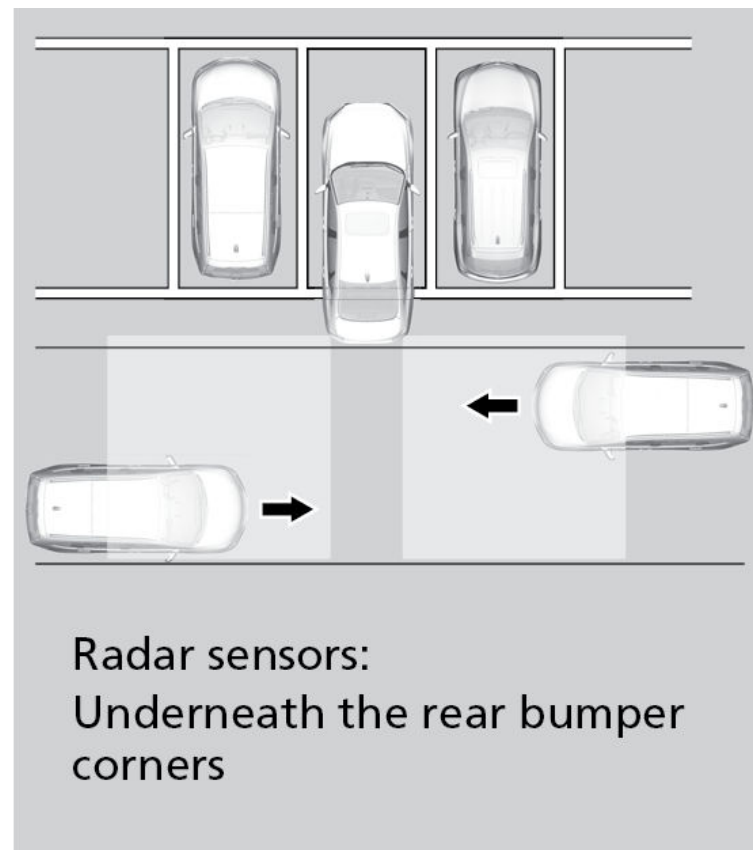

*1 - If equipped

The system does not provide alerts for a vehicle that is moving away from your vehicle, and it may not detect pedestrians, bicycles, or stationary objects.

■ Turning the System On or Off

You can switch on and off the system using the audio/information screen.

1. From the HOME screen, select Settings.
2. Select Camera.
3. Select Cross Traffic Monitor.
4. Select On or Off, then select Save.

The system can also be turned on and off on the audio/information screen by pressing the CTM icon.

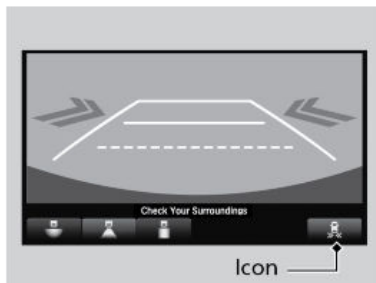

Multi-View Rear Camera

When you shift into Reverse (R), a real-time image of the area behind your vehicle is shown in the upper display, along with helpful parking guidelines.

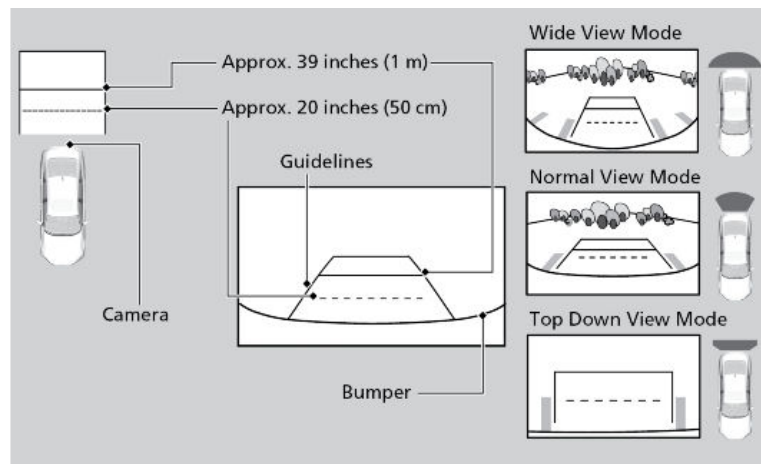

■ Changing Settings

Turn the guidelines on or off.

Models with Color Audio

1. Press the MENU/CLOCK button.
2. Select Settings.

3. Select Rear Camera.
4. Select an option.

Models with Display Audio

1. Select Home.
2. Select Settings.
3. Select Camera.
4. Select Rear Camera.
5. Select an option.

The rear camera view is restricted. You cannot see the corner ends of the bumper or what is underneath the bumper. Its unique lens also makes objects appear closer or farther than they actually are.

Visually confirm that it is safe to drive before backing up. Certain conditions (such as weather, lightning, and high temperatures) may also restrict the rear view. Do not rely on the rearview display, which does not give you all the information about conditions at the rear of your vehicle.

Improving Fuel Economy and Reducing CO₂ Emissions

Achieving fuel economy and reducing CO₂ emissions is dependent on several factors, including driving conditions, load weight, idling time, driving habits, and vehicle condition. Depending on these and other factors, you may not achieve the rated fuel economy of this vehicle.

Refueling

Use the proper fuel and refueling procedure to ensure the best performance and safety of your vehicle.

■ Fuel Information

Use of unleaded gasoline of 87 octane or higher is recommended.

- Honda recommends TOP TIER Detergent Gasoline where available.
- Do NOT use gasoline containing more than 15% ethanol.
- Do NOT use gasoline containing methanol.
- Do NOT use gasoline containing MMT.

NOTICE

We recommend quality gasoline containing detergent additives that help prevent fuel system and engine deposits. In addition, in order to maintain good performance, fuel economy, and emissions control, we strongly

recommend the use of gasoline that does NOT contain harmful manganese-based fuel additives such as MMT, if such gasoline is available.

■ How to Refuel

1. Stop your vehicle with the service station pump on the left side of the vehicle in the rear.
2. Turn off the engine.
3. Unlock the driver's door using the master door lock switch.

The fuel fill door on the outer side of the vehicle will unlock.

4. Press the area indicated by the arrow to release the fuel fill door. You will hear a click.
5. Place the end of the filler nozzle on the lower part of filler opening, then insert it slowly and fully.

Make sure that the end of the filler nozzle goes down along with the filler pipe.

Keep the filler nozzle level.

When the tank is full, the filler nozzle will click off automatically.

After filling, wait about five seconds before removing the filler nozzle.

6. Shut the fuel fill door by hand.

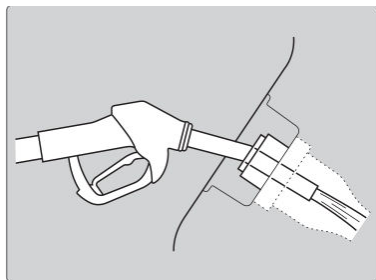
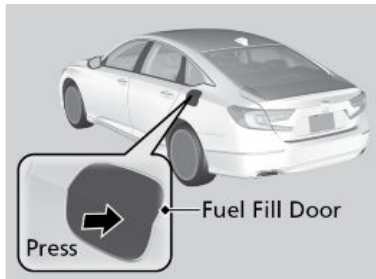
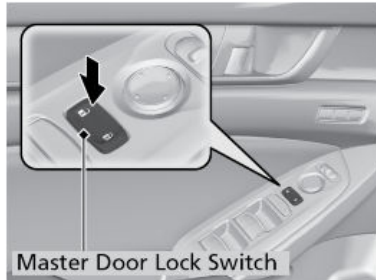

⚠ WARNING

Gasoline is highly flammable and explosive. You can be burned or seriously injured when handling fuel.

- Stop the engine, and keep heat, sparks, and flame away.
- Handle fuel only outdoors.
- Wipe up spills immediately.

Refueling from a Portable Fuel Container

If you need to refuel your vehicle from a portable fuel container, use the funnel provided with your vehicle.

1. Turn off the engine.
2. Press the fuel fill door release button. The fuel fill door opens.
3. Place the end of the funnel on the lower part of filler opening, then insert it slowly and fully. Remove the funnel
4. Place the end of the funnel on the lower part of the filler opening, then insert it slowly and fully. Make sure that the end of the funnel goes down along with the filler pipe.
5. Fill the tank with fuel from the portable fuel container. Pour fuel carefully so you do not spill any.
6. Remove the funnel from the filler neck. Wipe up any fuel from the funnel before storing it.
7. Shut the fuel fill door by hand.

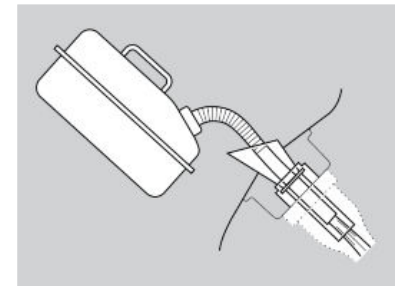

NOTICE

Do not insert the nozzle of a portable fuel container or any funnel other than the one provided with your vehicle. Doing so can damage the fuel system. Do not try to pry open or push open the sealed fuel tank with foreign objects. This can damage the fuel system and its seal.

HANDLING THE UNEXPECTED

Learn about what to do in critical or emergency situations.

Shift Lever*¹ Does Not Move

For Continuously Variable Transmission (CVT) models: Follow the procedure below if you cannot move the shift lever out of Park (P).

1. Set the parking brake.
2. Remove the built-in key from the remote transmitter.
Remove the built-in key from the smart entry remote.
3. Open the center pocket.
4. **Models without Wireless Charger:** Remove the cover in the center pocket.
5. Wrap a cloth around the tip of a small flat-tip screwdriver. Put it into the shift lock release slot as shown in the image, and remove the cover.
6. Insert the key into the shift lock release slot.
7. While pushing the key down, press the shift lever release button and place the shift lever into Neutral (N). The lock is now released. Have the shift lever checked by a dealer as soon as possible.

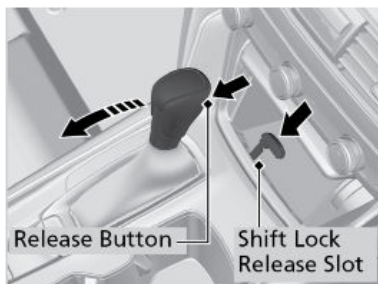
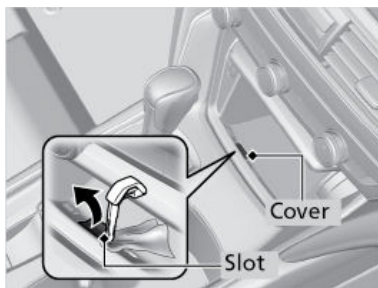
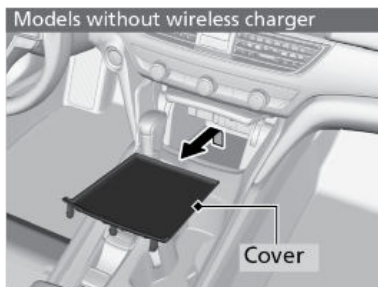

Smart Entry System Battery Strength

If the battery life in your remote transmitter is weak, a message appears in the driver information interface with information on how to start the engine.

*1 - If equipped

1. Touch the back of the remote transmitter to the ENGINE START/STOP button while the indicator is flashing.
2. With the brake pedal or clutch pedal pressed, press the ENGINE START/STOP button within 10 seconds after the beeper sounds and the ENGINE START/STOP button changes from flashing to on.

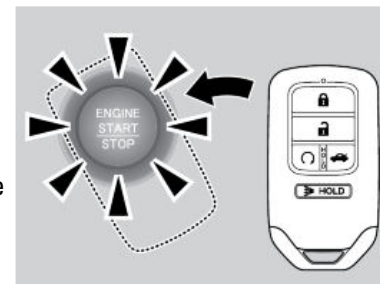

Jump Starting

Turn off the power to electric devices, such as audio and lights. Turn off the engine, then open the hood.

1. Open the terminal cover on the positive (+) terminal.
2. Connect the first jumper cable to your vehicle's battery (+) terminal.

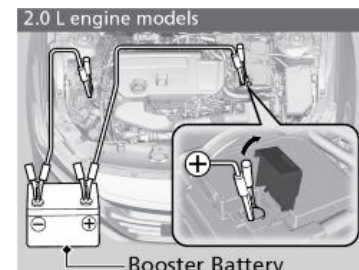
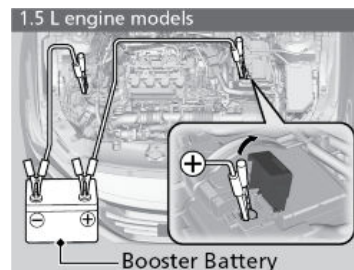

3. Connect the other end of the first jumper cable to the booster battery (+) terminal. Use a 12-volt booster battery only.

When using an automotive battery charger, select a charging voltage lower than 15 volts. Check the charger manual for the proper setting.

4. Connect the second jumper cable to the booster battery (-) terminal.
5. Connect the other end of the second jumper cable to the as shown. Do not connect this jumper cable to any other part.

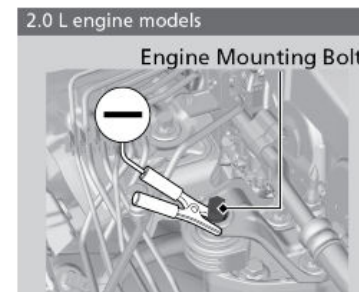
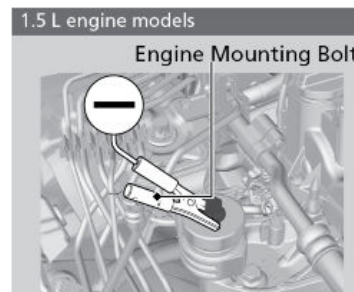

6. If your vehicle is connected to another vehicle, start the assisting vehicle's engine and increase its rpm slightly.
7. Attempt to start your vehicle's engine. If it turns over slowly, make sure that the jumper cables have good metal-to-metal contact.

⚠ WARNING

A battery can explode if you do not follow the correct procedure, seriously injuring anyone nearby.

Keep all sparks, open flames, and smoking materials away from the battery.

Overheating

Signs your engine is overheating:

- The temperature gauge needle is at the H mark
- The engine suddenly loses power.
- Steam or spray comes out from under the hood.
- The message Engine Temperature Too Hot. Do Not Drive. Allow Engine To Cool appears on the display.

First thing to do:

1. Immediately park the vehicle in a safe place. Turn off all accessories and turn on the hazard warning lights.
2. If no steam or spray is present: Keep the vehicle running and open the hood (See Under the Hood).

If steam or spray is present: Turn off the engine and wait until it subsides. Then, open the hood (See Under the Hood).

3. Check that the cooling fan is operating and stop the engine once the temperature gauge needle goes down. If the cooling fan is not operating, immediately stop the engine.
4. Once the engine has cooled down, inspect the coolant level and check the cooling system components for leaks. If the coolant level in the reserve tank is low, add coolant until it reaches the MAX mark. If there is no coolant in the reserve tank, make sure the radiator is cool, then cover the radiator cap with a heavy cloth and open the cap. If necessary, add coolant up to the base of the filler neck, and put the cap back on.

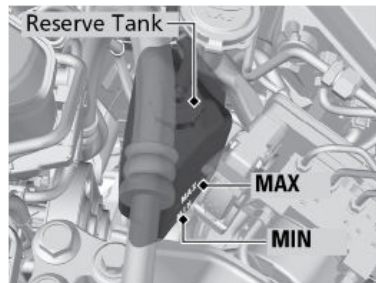

Once the engine has cooled sufficiently, restart it and check the temperature gauge. If the temperature needle has gone down, resume driving. If it has not gone down, contact a dealer for repairs.

⚠ WARNING

Steam and spray from an overheated engine can seriously scald you.

Do not open the hood if steam is coming out.

⚠ WARNING

Removing the radiator cap while the engine is hot can cause the coolant to spray out, seriously scalding you.

Always let the engine and radiator cool down before removing the radiator cap.

NOTICE

Continuing to drive with the temperature gauge needle at the H mark may damage the engine.

Emergency Engine Stop

The ENGINE START/STOP button may be used to stop the engine due to an emergency situation even while driving. If you must stop the engine, choose one of the following operations:

- Press and hold the ENGINE START/STOP button for two seconds, **or**
- Firmly press the ENGINE START/STOP button three times.

The steering wheel will not lock. However, because turning off the engine disables the power assist the engine provides to the steering and braking systems, it will require significantly more physical effort and time to steer and slow the vehicle. Use both feet on the brake pedal to slow down the vehicle and stop immediately in a safe place. With manual transmission models you can also downshift the transmission to utilize engine braking.

Automatic transmission models : The transmission automatically changes to P after the vehicle comes to a complete stop. Then, the power mode changes to VEHICLE OFF.

Continuously Variable Transmission Models: The power mode is in ACCESSORY when the engine is stopped. To change the mode to VEHICLE OFF, put the transmission into P after the vehicle comes to a complete stop.

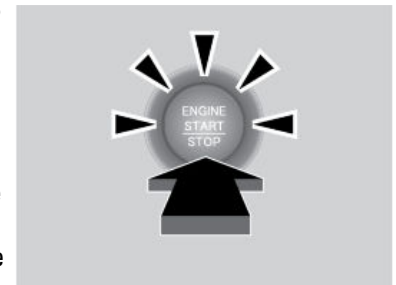

Canadian Continuously Variable Transmission Models: Then press the ENGINE START/STOP button twice without depressing the brake pedal.

Manual transmission models: The power mode changes to VEHICLE OFF.

NOTICE

Do not press the button while driving unless it is absolutely necessary for the engine to be switched off.

Emergency Towing

Call a professional towing service if you need to tow your vehicle.

Flat bed equipment: The operator loads your vehicle on the back of a truck. **This is the best way to transport your vehicle.**

Wheel lift equipment: The tow truck uses two pivoting arms that go under the front tires and lift them off the ground. The rear tires remain on the ground. **This is an acceptable way to tow your vehicle.**

NOTICE

Trying to lift or tow your vehicle by the bumpers will cause serious damage. The bumpers are not designed to support the vehicle's weight.

Improper towing such as towing behind a motorhome or other motor vehicle can damage the transmission.

Tire Pressure Monitoring System (TPMS)

Instead of directly measuring the pressure in each tire, the TPMS on this vehicle monitors and compares the rolling radius and rotational characteristics of each wheel and tire while you are driving to determine if one or more tires are significantly under-inflated. This will cause the low tire pressure/TPMS indicator to come on and a message to appear on the driver information interface.

Reasons for the indicator to come on or blink

If your vehicle's tire pressure becomes significantly low, or the TPMS has not been calibrated. If there is a problem with the TPMS or the compact spare tire is installed, the indicator blinks for about one minute, and then stays on.

■ What to Do

Stop your vehicle in safe place. Check the tire pressure and adjust the pressure to the specified level. The specified tire pressure is on a label on the driver's doorjamb.

■ Tire Pressure Monitoring System (TPMS) - Required Federal Explanation

U.S. models

Each tire, including the spare (if provided), should be checked monthly when cold and inflated to the inflation pressure recommended by the vehicle manufacturer on the vehicle placard or tire inflation pressure label. (If your vehicle has tires of a different size than the size indicated on the vehicle placard or tire inflation pressure label, you should determine the proper tire inflation pressure for those tires.)

As an added safety feature, your vehicle has been equipped with a tire pressure monitoring system (TPMS) that illuminates a low tire pressure telltale  when one or more of your tires is significantly under-inflated.

Accordingly, when the low tire pressure telltale illuminates, you should stop and check your tires as soon as possible, and inflate them to the proper pressure.

Driving on a significantly under-inflated tire causes the tire to overheat and can lead to tire failure. Under-inflation also reduces fuel efficiency and tire tread life, and may affect the vehicle's handling and stopping ability.

Please note that the TPMS is not a substitute for proper tire maintenance, and it is the driver's responsibility to maintain correct tire pressure, even if under-inflation has not reached the level to trigger illumination of the TPMS low tire pressure telltale.

Your vehicle has also been equipped with a TPMS malfunction indicator to indicate when the system is not operating properly. The TPMS malfunction indicator is combined with the low tire pressure telltale. When the system detects a malfunction, the telltale will flash for approximately one minute and then remain continuously illuminated. This sequence will continue upon subsequent vehicle start-ups as long as the malfunction exists.

When the malfunction indicator is illuminated, the system may not be able to detect or signal low tire pressure as intended.

TPMS malfunctions may occur for a variety of reasons, including the installation of replacement or alternate tires or wheels on the vehicle that prevent the TPMS from functioning properly.

Always check the TPMS malfunction telltale after replacing one or more tires or wheels on your vehicle to ensure that the replacement or alternate tires and wheels allow the TPMS to continue to function properly.

Changing a Tire

If a tire goes flat while driving, grasp the steering wheel firmly and brake gradually to reduce speed. Then stop in a safe place. Replace the flat tire with

the compact spare tire. Go to a dealer as soon as possible to have the full-size tire repaired or replaced.

Vehicles with a compact spare tire:

1. Park the vehicle on firm, level, non-slippery surface and set the parking brake.
2. **Automatic transmission/Continuously variable transmission models:** Shift to Park (P).

Manual transmission models: Shift to Reverse (R).

3. Turn on the hazard warning lights and set the power mode to VEHICLE OFF.

■ **Getting Ready to Change the Tire**

Getting Ready to Replace the Flat Tire

1. Open the trunk floor lid.

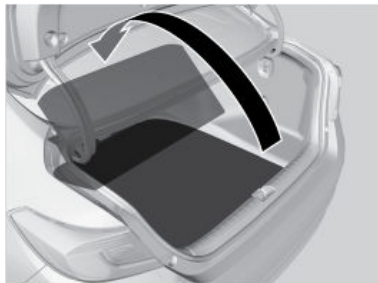

2. Take the tool case out. Take the jack, jack handle bar, and wheel nut wrench out of the tool case.

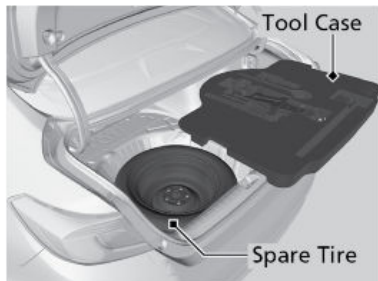

3. Unscrew the wing bolt, then remove the spacer cone. Then, remove the spare tire.

4. Place the spare tire (wheel side up) under the vehicle body, near the tire that needs to be replaced.

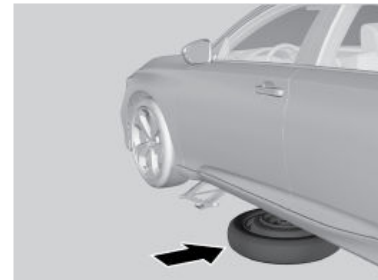

5. Loosen each wheel nut about one turn using the wheel nut wrench.



■ **Setting Up the Jack**

1. Place the jack under the jacking point closest to the tire to be changed.

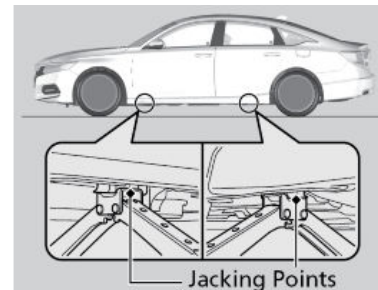

2. Turn the end bracket clockwise (as shown in the image) until the top of the jack contacts the jacking point. Make sure that the jacking point tab is resting in the jack notch.

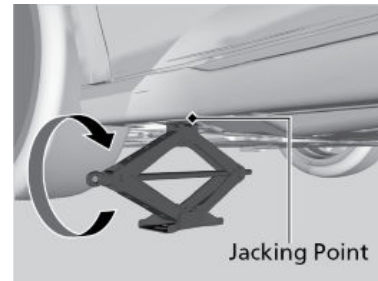

- Raise the vehicle, using the jack handle bar and the jack handle, until the tire is off the ground.

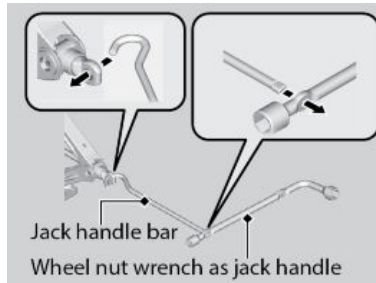

⚠ WARNING

The vehicle can easily roll off the jack, seriously injuring anyone underneath.

Follow the directions for changing a tire exactly, and no person should place any portion of their body under a vehicle that is supported by a jack.

Attention: The jack shall be placed on a flat and stable surface on the same level as the vehicle is parked.

The following instructions must be followed to use the jack safely:

- Do not use the jack with people or luggage in the vehicle.
- Use the jack provided in your vehicle. Other jacks may not support the weight (load) or fit the jacking point.
- Do not use while the engine is running.
- Use only where the ground is firm and level.
- Use only at the jacking points.
- Do not get in the vehicle while using the jack.
- Do not put anything on top of or underneath the jack.

■ Replacing the Flat Tire

- Remove the wheel nuts and flat tire.



- Mount the compact spare tire. Replace the wheel nuts and lightly tighten them.

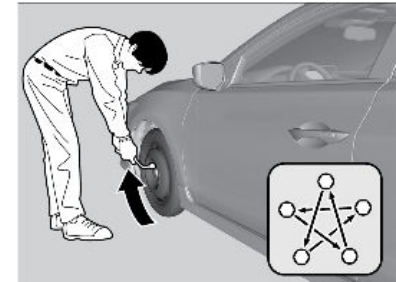

- Lower the vehicle and remove the jack. Tighten the wheel nuts in the order indicated in the image. Go around, tightening the nuts, two to three times in this order. Do not overtighten the wheel nuts.

■ Storing the Flat Tire

- Remove the center cap.

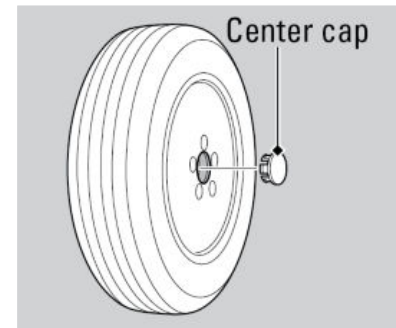

- Place the flat tire face down in the spare tire well.
- Remove the spacer cone from the wing bolt, flip it over, and insert it back on the bolt. Secure the flat tire with the wing bolt.

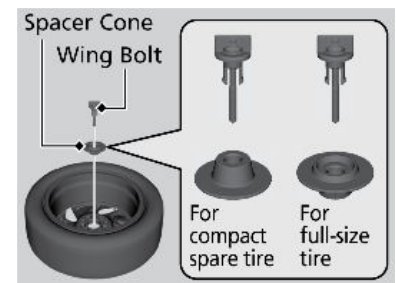

- Securely store the jack and wheel nut wrench back into the tool case. Store the case in the trunk.

⚠ WARNING

Loose items can fly around the interior in a crash and can seriously injure the occupants.

Store the wheel, jack, and tools securely before driving.

Fuse Locations

If any electrical devices are not working, turn the vehicle off and check to see if any applicable fuse is blown. Fuse locations are shown on the fuse box cover. Locate the fuse in question by the fuse number and box cover number. Refer to the Owner's Manual at www.owners.honda.com for a complete fuse chart.

■ Engine Compartment Fuse Box

Located near the battery. Push the tabs to open the box.

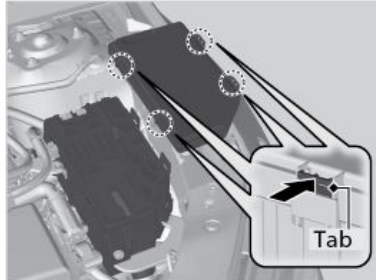

■ Interior Fuse Box

Located under the dashboard (behind the instrument panel). Fuse locations are shown on the label on the side panel (under the steering column). Locate the fuse in question by the fuse number and label number.

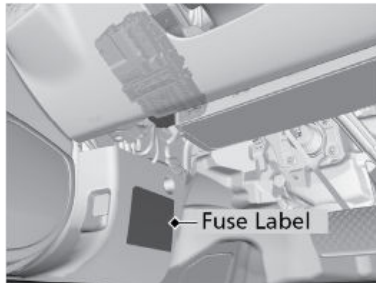

■ Inspecting and Changing Fuses

1. Turn off the vehicle, including all lights and accessories.
2. Remove the fuse box cover.
3. Check the large fuse in the engine compartment.
If the fuse is blown, use a Phillips-head screwdriver to remove the screws and replace the fuse with a new one. Reinstall the screws.
4. Inspect the small fuses in the engine compartment and the vehicle interior.
If there is a burned out fuse, remove it with the fuse puller and replace it with a new one.

Replacing a fuse with one that has a higher rating greatly increases the chances of damaging the electrical system.

NOTICE

MAINTENANCE

Learn about basic maintenance that you can perform on the vehicle yourself, as well as information about how to best maintain the vehicle.

Safety Precautions

Some of the most important safety precautions are listed below however, we cannot warn you of every conceivable hazard that can arise in performing maintenance. Only you can decide whether or not you should perform a given task.

■ Maintenance Safety

- To reduce the possibility of fire or explosion, keep cigarettes, sparks, and flames away from the battery and all fuel-related parts.
- Never leave rags, towels, or other flammable objects under the hood. Heat from the engine and exhaust can ignite them, causing a fire.
- To clean parts, use a commercially available degreaser or parts cleaner, not gasoline.
- Wear eye protection and protective clothing when working with the battery or compressed air.
- Do not run the engine in confined spaces where carbon monoxide gas can accumulate.

■ Vehicle Safety

- The vehicle must be stationary and parked on level ground with the parking brake set and the engine off.
- Be aware that hot parts can burn you.
- Be aware that moving parts can injure you.

⚠ WARNING

Improperly maintaining this vehicle or failing to correct a problem before driving can cause a crash in which you can be seriously hurt or killed.

Always follow the inspection and maintenance recommendations according to the schedules in this guide.

⚠ WARNING

Failure to properly follow maintenance instructions and precautions can cause you to be seriously hurt or killed.

Always follow the procedures and precautions in this guide.

Maintenance Minder™

When maintenance is due, the system message indicator comes on and a message appears on the display every time you turn the vehicle on. The messages notify you when to change the engine oil, or when to bring your vehicle to a dealer for indicated maintenance services.

You can view them on the engine oil life screen at any time.

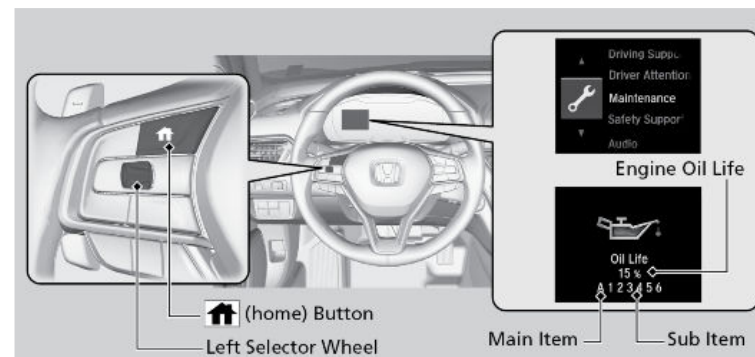

1. Set the power mode to ON.
2. Press the Home button.
3. Roll the left selector wheel until the wrench symbol is displayed.
4. Press the left selector wheel to go to the Maintenance Minder screen. The engine oil life appears on the driver information interface along with maintenance items due soon.

- Independent of the Maintenance Minder information, replace the brake fluid every 3 years.

U.S. Models

- Independent of the Maintenance Minder information, adjust the valves during services A, B, 1, 2, or 3 if they are noisy.

Canadian Models

- Independent of the Maintenance Minder information, adjust the valves during services A, 0, 9, 1, 2, or 3 if they are noisy.

Maintenance, replacement, or repair of emissions control devices and systems may be done by any automotive repair establishment or individuals using parts that are certified to EPA standards.

According to state and federal regulations, failure to perform maintenance on the maintenance main items marked with # will not void your emissions warranties. However, all maintenance services should be performed in accordance with the intervals indicated by the driver information interface.

■ **Maintenance Minder Service Codes**

These codes indicate what services are due on your vehicle.

U.S. Models

CODE	Maintenance Main Items
A	<ul style="list-style-type: none"> • Replace engine oil*¹
B	<ul style="list-style-type: none"> • Replace engine oil*¹ and oil filter • Inspect front and rear brakes • Inspect tie rod ends, steering gearbox, and boots • Inspect suspension components • Inspect driveshaft boots • Inspect brake hoses and lines (Including ABS/VSA®) • Inspect all fluid levels and condition of fluids • Inspect exhaust system# • Inspect fuel lines and connections#

*1: If a Maintenance Minder message does not appear more than 12 months after the display is reset, change the engine oil every year.

#: See information on maintenance and emissions warranty.

*2: If you drive in dusty conditions, replace the air cleaner element every 15,000 miles (24,000 km).

*3: If you drive primarily in urban areas that have high concentrations of soot in the air from industry and from diesel-powered vehicles, replace the dust and pollen filter every 15,000 miles (24,000 km).

CODE	Maintenance Sub Items
1	<ul style="list-style-type: none"> • Rotate tires
2	<ul style="list-style-type: none"> • Replace air cleaner element*² • Replace dust and pollen filter*³ • Inspect drive belt
3	<ul style="list-style-type: none"> • Replace transmission fluid*⁴
4	<ul style="list-style-type: none"> • Replace spark plugs • Inspect valve clearance
5	<ul style="list-style-type: none"> • Replace engine coolant
7	<ul style="list-style-type: none"> • Replace brake fluid*⁵

*4: **Continuously variable transmission models**

Driving in mountainous areas at very low vehicle speeds results in higher transmission temperatures. This requires transmission fluid changes more frequently than recommended by the Maintenance Minder. If you regularly drive your vehicle under these conditions, have the transmission fluid changed every 25,000 miles (40,000 km).

*5: If a Maintenance Minder message does not appear more than 36 months after the display for item 7 is reset, change the brake fluid every 3 years.

Canadian Models

CODE	Maintenance Main Items
A	<ul style="list-style-type: none"> • Replace engine oil*¹
0	<ul style="list-style-type: none"> • Replace engine oil*¹ and oil filter

*1: If a Maintenance Minder Message does not appear more than 12 months after the display is reset, change the engine oil every year.

*2: If you drive in dusty conditions, replace the air cleaner element every 15,000 miles (24,000 km).

*3: If you drive primarily in urban areas that have high concentrations of soot in the air from industry and from diesel-powered vehicles, replace the dust and pollen filter every 15,000 miles (24,000 km).

*4: **Continuously variable transmission models**

Driving in mountainous areas at very low vehicle speeds results in higher transmission temperatures. This requires transmission fluid changes more frequently than recommended by the Maintenance Minder. If you regularly drive your vehicle under these conditions, have the transmission fluid changed every 25,000 miles (40,000 km).

*5: If a Maintenance Minder Message does not appear more than 36 months after the display for item 7 is reset, change the brake fluid every 3 years.

#: See information on maintenance and emissions warranty.

CODE	Maintenance Sub Items
1	<ul style="list-style-type: none"> • Rotate tires
2	<ul style="list-style-type: none"> • Replace air cleaner element*² • Replace dust and pollen filter*³ • Inspect drive belt
3	<ul style="list-style-type: none"> • Replace transmission fluid*⁴
4	<ul style="list-style-type: none"> • Replace spark plugs • Inspect valve clearance
5	<ul style="list-style-type: none"> • Replace engine coolant
7	<ul style="list-style-type: none"> • Replace brake fluid*⁵
9	<ul style="list-style-type: none"> • Service front and rear brakes • Inspect tie rod ends, steering gear box, and boots • Inspect suspension components • Inspect driveshaft boots • Inspect brake hoses and lines (including ABS/VSA®) • Inspect all fluid levels and condition of fluids • Inspect exhaust system[#] • Inspect fuel lines and connections[#]

Under the Hood

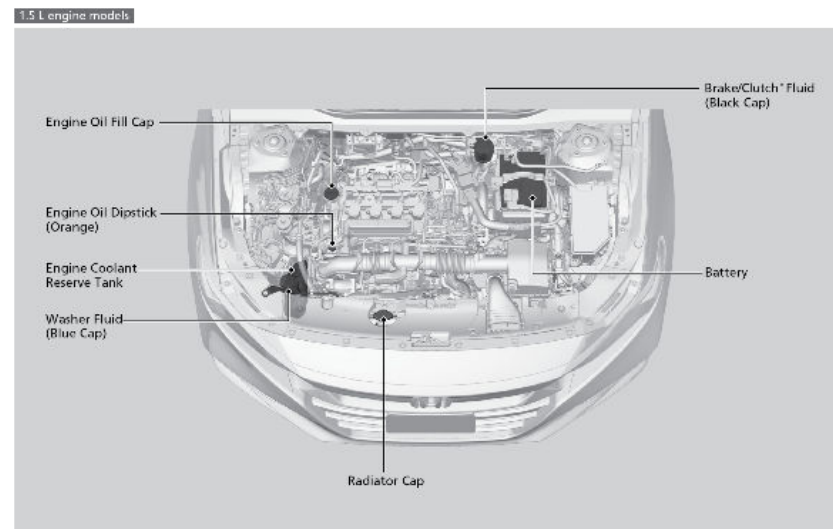

* Not available on all models

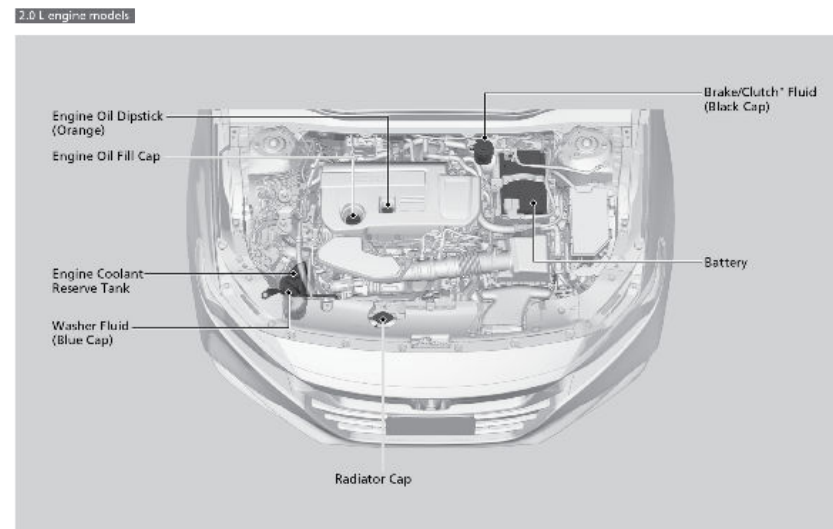

* Not available on all models

■ Opening the Hood

1. Park the vehicle on a level surface and set the parking brake.

2. Pull the hood release handle under the lower left corner of the dashboard.
3. Pull the hood latch lever in the center of the hood to release the lock mechanism, and open the hood.

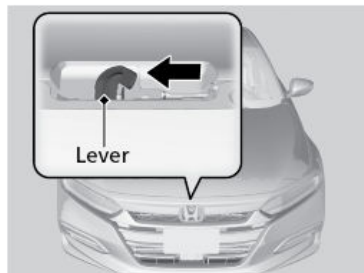
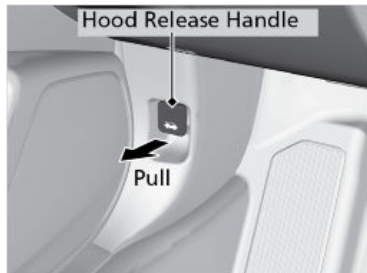

4. Remove the support rod from the clamp using the grip. Mount the support rod in the hood.

When closing, remove the support rod, and stow it in the clamp, then gently lower the hood.

Lower the hood, to approximately 12 inches (30 cm) and press firmly down with your hands.

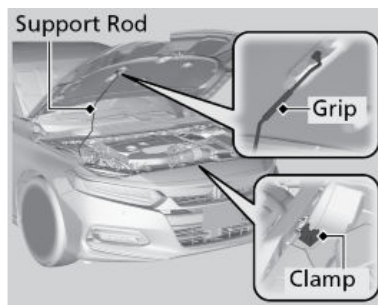

NOTICE

Do not open the hood when the wiper arms are raised. The hood will strike the wipers, and may damage either the hood or the wipers.

Engine Oil

Park the vehicle on level ground. Wait approximately three minutes after turning the engine off before you check the oil.

■ **Checking the Oil**

1. Open the hood. (See Opening the Hood) Remove the dipstick (orange).

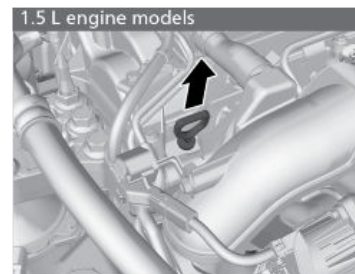

2. Wipe the dipstick with a clean cloth or paper towel.
3. Insert the dipstick all the way back into its hole.
4. Remove the dipstick again, and check the level. It should be between the upper and lower marks.

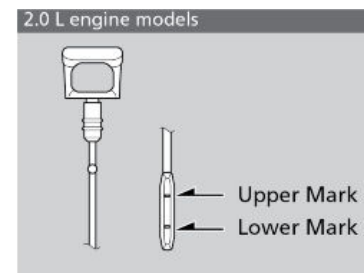
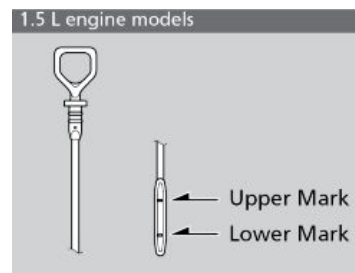

Add oil if necessary.

Note: Under certain driving conditions, it is normal for the engine oil level to rise above the upper mark. If you have a concern, consult a dealer for details.

■ **Recommended Engine Oil**

- **Genuine Honda Motor Oil**
- **Premium-grade 0W-20 detergent oil with an API Certification Seal on the container**

This seal indicates the oil is energy conserving and that it meets the American Petroleum Institute's latest requirements. Use **Genuine Honda Motor Oil** or another commercial engine oil of suitable viscosity for the ambient temperature.

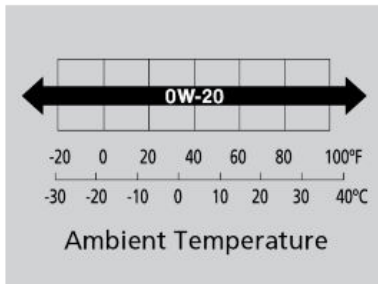

■ **Adding Oil**

1. Unscrew and remove the engine oil fill cap.
2. Add oil slowly.
3. Reinstall the engine oil fill cap and tighten it securely.
4. Wait for three minutes and recheck the engine oil dipstick.

NOTICE

Do not fill the engine oil above the upper mark. Overfilling the engine oil may result in leaks and engine damage.

■ **Resetting the Engine Oil Life**

If you change or replace the vehicle's engine oil yourself, you must reset the engine oil life.

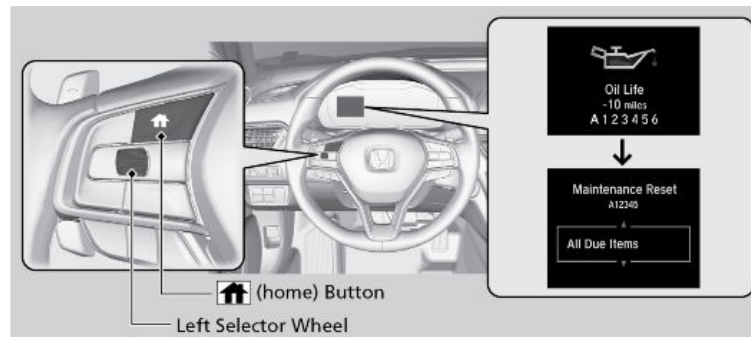

1. Set the power mode to ON.
2. Press the **Home** button.
3. Roll the left selector wheel until the wrench symbol is displayed.
4. Press the left selector wheel to go to the **Maintenance Minder** screen.
5. Press the left selector wheel to enter the reset mode.
6. Roll the left selector wheel to select the maintenance item to reset, or to select **All Due Items**. You can also select **Cancel** to end the process.
7. Press the left selector wheel to reset the selected item.
8. Repeat from step 5 for other items you wish to reset.

NOTICE

Failure to reset the engine oil life after a maintenance service results in the system showing incorrect maintenance intervals, which can lead to serious mechanical problems.

Engine Coolant

Park the vehicle on level ground. Check the reserve tank and the coolant level in the radiator. **Use Honda Long Life Antifreeze/Coolant Type 2.**

■ **Checking the Reserve Tank**

1. Open the hood. (See Opening the Hood) Check the amount of coolant in the reserve tank.
2. If the coolant level is below the MIN mark, add the specified coolant until it reaches the MAX mark.

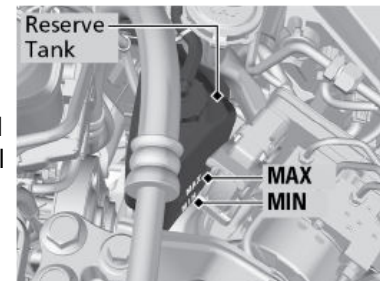

3. Inspect the cooling system for leaks.

NOTICE

For vehicles used in temperatures below -31°F (-35°C), change the coolant from the standard 50:50 antifreeze:water mix to one with added antifreeze. Consult a dealer for more information.

■ **Adding Coolant**

1. Make sure the engine and radiator are cool.
2. Turn the radiator cap 1/8 turn counterclockwise and relieve any pressure in the coolant system.
3. Push down and turn the radiator cap counterclockwise to remove it.
4. The coolant level should be up to the base of the filler neck. Add coolant if it is low.
5. Put the radiator cap back on, and tighten it fully.

⚠ WARNING

Removing the radiator cap while the engine is hot can cause the coolant to spray out, seriously scalding you.

Always let the engine and radiator cool down before removing the radiator cap.

NOTICE

Pour the fluid slowly and carefully so you do not spill any. Clean up any spills immediately; they can damage components in the engine compartment.

Checking the Battery

The battery condition is monitored by the sensor on the negative terminal. If there is a problem with the sensor, a warning message appears on the Driver Information Interface. Have your vehicle checked by a dealer.

⚠ WARNING

The battery gives off explosive hydrogen gas during normal operation.

A spark or flame can cause the battery to explode with enough force to kill or seriously hurt you.

When conducting any battery maintenance, wear protective clothing and a face shield, or have a skilled technician do it.

WARNING: Battery posts, terminals, and related accessories contain lead and lead compounds. **Wash your hands after handling.**

Window Washer Fluid

Check the amount of window washer fluid by looking at the reservoir. Fill the reservoir if it is low. Pour the washer fluid carefully. Do not overflow the reservoir.

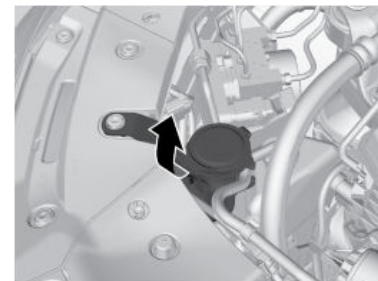

Canadian Models Only

If the washer fluid is low, a message appears on the Driver Information Interface.

Brake/Clutch*1 Fluid

The fluid level should be between the MIN and MAX marks on the side of the tank. We recommend using **Honda Heavy Duty Brake Fluid DOT 3**.

Use the same fluid for both the brakes and clutch*1.

Pour the fluid carefully.

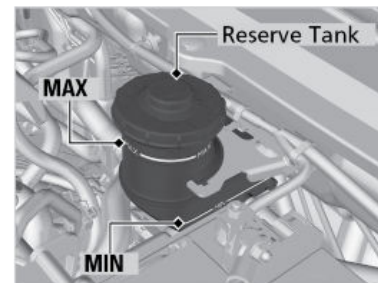

Manual Transmission Models

The brake fluid reserve tank is also used for your vehicle's clutch fluid. As long as you keep the brake fluid level as instructed above, there is no need for checking the clutch fluid level.

If the fluid level is at or below the MIN mark, have a dealer inspect for leaks or worn brake pads as soon as possible.

NOTICE

Brake fluid marked DOT 5 is not compatible with your vehicle's braking system and can cause extensive damage.

*1 - If equipped

Changing Wiper Blades

If the wiper blades leave streaks across the windshield, try cleaning them first with a paper towel or soft cloth and wiper fluid. If the wiper blade rubber has deteriorated, you should change the wiper blades.

1. Set the power mode to VEHICLE OFF(LOCK).
2. While holding the wiper switch in the MIST position, Both wiper arms are now set to the maintenance position.

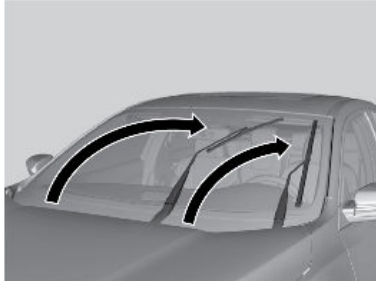

3. Lift the driver side wiper arm first, then the passenger side.

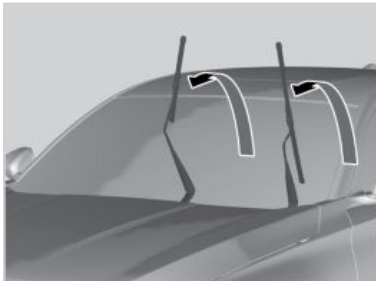

4. Press and hold the tab, then slide the holder off the wiper arm.

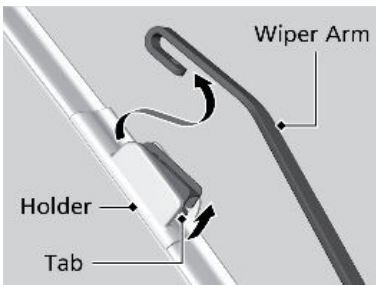

5. Pull the end of the wiper blade in the direction of the arrow in the image until it unfastens from the holder's end cap. Pull the wiper blade to the opposite direction to slide it out from its holder.

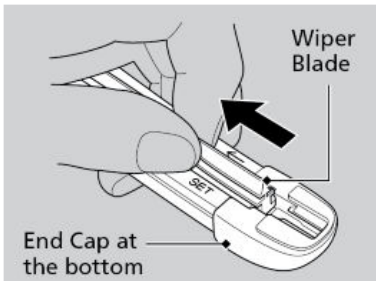

6. Insert the flat side of the new wiper blade onto the bottom part of the holder. Insert the blade all the way.
7. Install the end of the wiper blade into the end cap.
8. Slide the wiper holder onto the wiper arm securely.
9. Lower the passenger side wiper arm first, then the driver side.
10. Set the power mode to ON and hold the wiper switch in the MIST positions until both wiper arms return to the standard position.

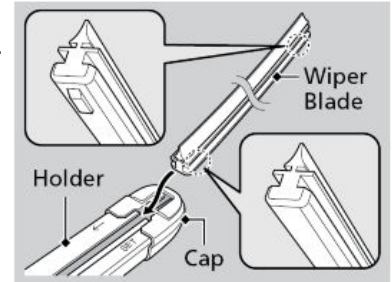

NOTICE

Avoid dropping the wiper arm, as it may damage the windshield.

Tire Information

To safely operate your vehicle, your tires must be of the proper type and size, in good condition with adequate tread, and properly inflated.

■ Inflation Guidelines

- Properly inflated tires provide the best combination of handling, tread life, and comfort. Refer to the driver's doorjamb label or the specifications see SPECIFICATIONS for the specified pressure.
- Underinflated tires wear unevenly, adversely affect handling and fuel economy, and are more likely to fail from overheating.
- Overinflated tires make your vehicle ride harshly, are more prone to road hazards, and wear unevenly.
- Every day before you drive, look at each of the tires. If one looks lower than the others, check the pressure with a tire gauge.
- Measure the air pressure when tires are cold. This means the vehicle has been parked for at least 3 hours, or driven less than 1 mile (1.6 km). If necessary, add or release air until the specified pressure is reached. If checked when hot, tire pressure can be as much as 4-6 psi (30-40 kPa, 0.3-0.4 kgf/cm²) higher than checked when cold.
- At least once a month or before long trips, use a gauge to measure the pressure in all tires, including the spare*1. Even tires in good condition can lose 1-2 psi (10-20 kPa, 0.1-0.2 kgf/cm²) per month.

■ Inspection Guidelines

Every time you inflate the tires, check for the following:

*1 - If equipped

- Any damage to tires, including bumps, bulges, cuts, splits, or cracks in the side or tread. Remove any foreign objects and inspect for air leaks. Replace tires if you see fabric or cord.
- Uneven or excessive tread wear. Have a dealer check the wheel alignment.
- Cracks or other damage around the valve stems.

Wear Indicators

The groove where the wear indicator is located is 1/16 inch (1.6 mm) shallower than elsewhere on the tire. If the tread has worn so low that the indicator is exposed, replace the tire. Worn out tires have poor traction on wet roads.

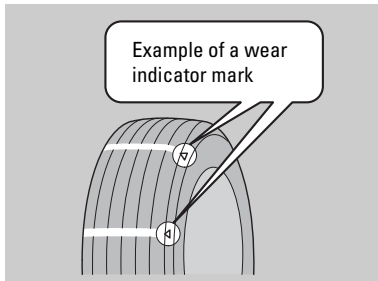

WARNING

Using tires that are excessively worn or improperly inflated can cause a crash in which you can be seriously hurt or killed. Follow all instructions in the owner's manual regarding tire inflation and maintenance.

Tire and Loading Information Label

The label attached to the driver's doorjamb provides necessary tire and loading information.

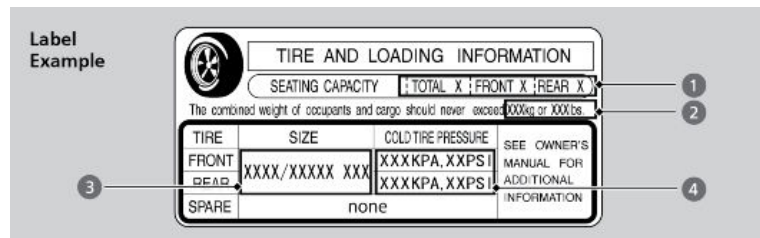

1. The number of people your vehicle can carry.
2. The total weight your vehicle can carry. Do not exceed this weight.
3. The original tire sizes for front, rear, and spare.
4. The proper cold tire pressure for front, rear, and spare.

Tire and Wheel Replacement

Replace your tires with radials of the same size, load range, speed rating, and maximum cold tires pressure rating (as shown on the tires' sidewall). Using tires of a different size or construction can cause certain vehicle systems to work incorrectly. It is best to replace all four tires at the same time. If that isn't possible, replace the front or rear tires in pairs.

If you change or replace a wheel, make sure that the wheel's specifications match those of the original wheels. Only use TPMS-specified wheels approved for your vehicle.

WARNING

Installing improper tires on your vehicle can affect handling and stability. This can cause a crash in which you can be seriously hurt or killed. Always use the size and type of tires recommended in the Owner's Manual.

Tire Service Life

The life of your tires is dependent on many factors, including driving habits, road conditions, vehicle loading, inflation pressure, maintenance history, speed, and environmental conditions (even when the tires are not in use).

In addition to regular inspections and inflation pressure maintenance, it is recommended that you have annual inspections performed once the tires reach five years old. All tires, including the spare, should be removed from service after 10 years from the date of manufacture, regardless of their condition or state of wear.

Winter Tires

If driving on snowy or frozen roads, mount all season tires marked "M+S", snow tires, or tire chains; reduce speed and maintain sufficient distance between vehicles when driving. For winter tires, select the size and load ranges that are the same as the original tires, and mount them to all four wheels.

Tire Chains

Install tire chains on the front tires only. Because your vehicle has limited tire clearance, we strongly recommend using the following chains:

Models with 225/50R17 tires:

Cable type: SCC Radial Chain SC1036

Models with 235/40R19 tires:

Not recommended to use any type of chains

Mount chains as tightly as you can and make sure that they do not touch the brake lines or suspension.

NOTICE

Traction devices that are the wrong size or improperly installed can damage your vehicle's brake lines, suspension, body, and wheels. Stop driving if they are hitting any part of the vehicle.

⚠ WARNING

Using the wrong chains, or not properly installing chains, can damage the brake lines and cause a crash in which you can be seriously injured or killed.

Follow all instructions in this guide regarding the selection and use of tire chains.

Tire Labeling

The tires that came on your vehicle have a number of markings. Those you should be aware of are described below.

Here is an example of what each marking means:

P235/60R18 102T

- P: tire type (passenger vehicle)
- 235: tire width in millimeters
- 60: aspect ratio (tire section height as a percentage of its width)
- R: tire construction code (radial)
- 18: rim diameter in inches
- 102: load index (code indicating maximum load tire can carry)
- T: speed symbol (code indicating maximum speed rating)

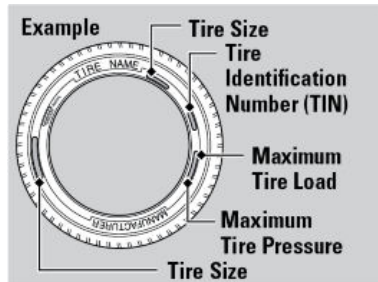

■ Tire Identification Number (TIN)

The tire identification number (TIN) is a group of numbers and letters that look like the following example. The TIN is located on the sidewall of the tire.

DOT B97R FW6X 2209

DOT: This indicates that the tire meets all requirements of the U.S. Department of Transportation.
 B97R: Manufacturer's identification mark.
 FW6X: Tire type code.
 22 09: Date of manufacture.

Year
Week

■ Glossary of Tire Terminology

Cold Tire Pressure – The tire air pressure when the vehicle has been parked for at least three hours or driven less than 1 mile (1.6 km).

Load Rating – The maximum load that a tire is rated to carry for a given inflation pressure.

Maximum Inflation Pressure – The maximum tire air pressure that the tire can hold.

Maximum Load Rating – The load rating for a tire at the maximum permissible inflation pressure for that tire.

Recommended Inflation Pressure – The cold tire inflation pressure recommended by the manufacturer.

Treadwear Indicators (TWI) – The projections within the principal grooves designed to give a visual indication of the degrees of wear of the tread.

DOT Tire Quality Grading

The tires on your vehicle meet all U.S. Federal Safety Requirements. All tires are also graded for treadwear, traction, and temperature performance according to Department of Transportation (DOT) standards. These gradings are explained below.

■ Uniform Tire Quality Grading

Quality grades can be found where applicable on the tire sidewall between tread shoulder and maximum section width.

For example:

Treadwear 200

Traction AA

Temperature A

All passenger car tires must conform to Federal Safety Requirements in addition to these grades.

■ Treadwear

The treadwear grade is a comparative rating based on the wear rate of the tire when tested under controlled conditions on a specified government test course. For example, a tire graded 150 would wear one and one-half (1 1/2) times as well on the government course as a tire graded 100. The relative performance of tires depends upon the actual conditions of their use, however, and may depart significantly from the norm due to variations in driving habits, service practices, and differences in road characteristics and climate.

■ Traction

The traction grades, from highest to lowest, are AA, A, B, and C. Those grades represent the tire's ability to stop on wet pavement as measured under controlled conditions on specified government test surfaces of asphalt and concrete. A tire marked C may have poor traction performance.

WARNING: The traction grade assigned to this tire is based on straight-ahead braking traction tests, and does not include acceleration, cornering, hydroplaning, or peak traction characteristics.

■ Temperature

The temperature grades are A (the highest), B, and C, representing the tire's resistance to the generation of heat and its ability to dissipate heat when tested under controlled conditions on a specified indoor laboratory test wheel. Sustained high temperature can cause the material of the tire to degenerate and reduce tire life, and excessive temperature can lead to sudden tire failure. The grade C corresponds to a level of performance which all passenger car tire must meet under the Federal Motor Vehicle Safety Standard No. 109. Grades B and A represent higher levels of performance on the laboratory test wheel than the minimum required by law.

WARNING: The temperature grade for this tire is established for a tire that is properly inflated and not overloaded. Excessive speed, underinflation, or excessive loading, either separately or in combination, can cause heat buildup and possible tire failure.

Air Conditioning

To ensure proper and safe operation, the Society of Automotive Engineers (SAEJ2845) recommends that the refrigerant system only be serviced by trained and certified technicians.

Never repair or replace the air conditioning evaporator (cooling coil) with one removed from a used or salvaged vehicle.

New replacement mobile air conditioning evaporators must be certified (and labeled) as meeting SAE Standard J2842.

Testing of Readiness Codes

Your vehicle has readiness codes as part of the onboard self-diagnostic system. Some states use these codes for testing to verify whether your vehicle's emissions components are working properly. The codes may not be read if you go through the testing just after the battery has gone dead or been disconnected.

To check if they are set, set the power mode to ON without starting the engine. The malfunction indicator lamp will come on for several seconds. If it goes off, the readiness codes are set. If it blinks five times, the readiness codes are not set.

If you are required to have your vehicle tested before the readiness codes are set, prepare the vehicle for retesting by doing the following:

1. Fill the gas tank to approximately 3/4 full.
2. Park the vehicle and leave the engine off for 6 hours or more.
3. Make sure the ambient temperature is between 40°F and 95°F (4°C and 35°C).
4. Start the engine without touching the accelerator pedal, and let it idle for 20 seconds.
5. Keep the vehicle in PARK (P) (continuously variable transmission) or NEUTRAL (N) (manual transmission). Increase the engine speed to 2,000 rpm, and hold it there for about 3 minutes.
6. Let the engine idle with your foot off the accelerator for 20 seconds.
7. Select a nearby, lightly traveled major highway where you can maintain a speed of 50 to 60 mph (80 to 97 km/h) for at least 20 minutes. Drive on the highway in DRIVE (D) (continuously variable transmission) or 5th (manual). Do not use cruise control. When traffic allows, drive for 90 seconds without moving the accelerator pedal. (Vehicle speed may vary slightly; this is okay.) If you cannot do this for a continuous 90 seconds because of traffic conditions, drive for at least 30 seconds, then repeat it two more times (for a total of 90 seconds).
8. Drive in city or suburban traffic for at least 10 minutes. When traffic conditions allow, let the vehicle coast for several seconds without using the accelerator pedal or the brake pedal.
9. Park the vehicle and leave the engine off for 30 minutes.

The readiness codes are erased when the battery is disconnected. The codes are set again only after several days of driving under a variety of conditions.

If a testing facility determines that the readiness codes are not set, you may be requested to return at a later date to complete the test or see your dealer.

SPECIFICATIONS

2.0 L engine models

Vehicle Specifications

Model	Honda Accord Sedan	
No. of Passengers:		
Front	2	
Rear	3	
Total	5	
Weights:		
Gross Vehicle Weight Rating	U.S.: 4,475 lbs (2,030 kg) Canada: 2,030 kg	
Gross Axle Weight Rating (Front)	U.S.: 2,403 lbs (1,090 kg) Canada: 1,090 kg	
Gross Axle Weight Rating (Rear)	U.S.: 2,094 lbs (950 kg) Canada: 950 kg	

Air Conditioning

Refrigerant Type	HFO-1234yf (R-1234yf)	
Charge Quantity	13.9 – 15.7 oz (395 – 445 g)	
Lubricant Type	ND-OIL 14	
Quantity	5.6 – 6.5 cu-in (92 – 107 cm ³)	

Engine Specifications

Displacement	121.76 cu-in (1,996 cm ³)	
Spark Plugs	NGK	DILKAR8P85Y

Fuel

Type	Unleaded gasoline, Pump octane number of 87 or higher	
Fuel Tank Capacity	14.8 US gal (56 L)	

Washer Fluid

Tank Capacity	U.S.: 2.6 US qt (2.5 L) Canada: 4.8 US qt (4.5 L)	
---------------	------------------------------------------------------	--

Brake/Clutch* Fluid

Specified	Honda Heavy Duty Brake Fluid DOT 3	
-----------	------------------------------------	--

Automatic Transmission Fluid*

Specified	Honda Automatic Transmission Fluid ATF-type 2.0	
Capacity	Change	4.5 US qt (4.3 L)

Manual Transmission Fluid*

Specified	Honda Manual Transmission Fluid (MTF)	
Capacity	Change	2.27 US qt (2.15 L)

Engine Oil

Recommended	-Genuine Honda Motor Oil 0W-20 -API Premium-grade 0W-20 detergent oil	
Capacity	Change including filter	4.6 US qt (4.4 L) 5.0 US qt (4.8 L)

Engine Coolant

Specified	Honda Long-Life Antifreeze/Coolant Type2	
Ratio	50/50 with distilled water	
Capacity	1.34 US gal (5.06 L) (change including the remaining 0.17 US gal (0.66 L) in the reserve tank)	

Tire

Regular	Size	225/50R17 94V ^{*1} 235/40R19 96V ^{*2}
	Pressure	psi (kPa [kgf/cm ²])
	Front	32 (220 [2.2]) ^{*1} 33 (225 [2.25]) ^{*2}
	Rear	32 (220 [2.2]) ^{*1} 33 (225 [2.25]) ^{*2}
Compact Spare	Size	T135/80D17 103M
	Pressure	psi (kPa [kgf/cm ²])
Wheel Size	Regular	17 x 7 1/2 ^{*1} 19 x 8 1/2 ^{*2}
	Compact Spare	17 x 4T

*1: U.S. EX-L, EX-LN models

*2: U.S. Sport, Touring models and Canadian Sport, Touring models

* Not available on all models

Light Bulbs

Headlights (Low Beam)	LED
Headlights (High Beam)	60W (HB3) ^{*1} LED ^{*2}
Fog Lights*	LED
Parking/Daytime Running Lights	LED
Front Turn Signal Lights	LED
Front Side Marker Lights	LED
Side Turn Signal Lights (on Door Mirrors)*	LED
Brake Lights	LED
Rear Turn Signal Lights	21W (Amber)
Rear Side Marker Lights	LED
Taillights	LED
Back-Up Lights	16W
High-Mount Brake Light	LED
Rear License Plate Light	LED
Interior Lights	
Map Lights	8W
Ceiling Light	8W
Ambient Lights	LED
Vanity Mirror Lights	1.4W
Center Pocket Light	LED
Door Courtesy Lights*	2CP
Door Inner Handle Lights*	LED
Trunk Light	5W
Console Compartment Light* LED	

*1: Models with halogen high beam headlights

*2: Models with LED high beam headlights

* Not available on all models

1.5 L engine models

Vehicle Specifications

Model	Honda Accord Sedan	
No. of Passengers:		
Front	2	
Rear	3	
Total	5	
Weights:		
Gross Vehicle Weight Rating	U.S.:	4,299 lbs (1,950 kg) ^{*1} 4,475 lbs (2,030 kg) ^{*2}
	Canada:	1,950 kg ^{*1} 2,030 kg ^{*2}
Gross Axle Weight Rating (Front)	U.S.:	2,359 lbs (1,070 kg) ^{*3} 2,403 lbs (1,090 kg) ^{*4}
	Canada:	1,070 kg ^{*3} 1,090 kg ^{*4}
Gross Axle Weight Rating (Rear)	U.S.:	2,116 lbs (960 kg) ^{*3} 2,094 lbs (950 kg) ^{*4}
	Canada:	960 kg ^{*3} 950 kg ^{*4}

*1: Models with 225/50R17
 *2: Models with 235/40R19
 *3: Continuously variable transmission models
 *4: Manual transmission models

Air Conditioning

Refrigerant Type	HFO-1234yf (R-1234yf)
Charge Quantity	13.9 – 15.7 oz (395 – 445 g)
Lubricant Type	ND-Oil 14
Quantity	5.6 – 6.5 cu-in (92 – 107 cm ³)

Engine Specifications

Displacement	91.38 cu-in (1,498 cm ³)
Spark Plugs	NGK DILKAR8P85Y

Fuel

Type	Unleaded gasoline, Pump octane number of 87 or higher
Fuel Tank Capacity	14.8 US gal (56 L)

Washer Fluid

Tank Capacity	U.S.: 2.6 US qt (2.5 L) Canada: 4.8 US qt (4.5 L)
---------------	------------------------------------------------------

Brake/Clutch* Fluid

Specified	Honda Heavy Duty Brake Fluid DOT 3
-----------	------------------------------------

Continuously Variable Transmission Fluid *

Specified	Honda HCF-2 Transmission Fluid	
Capacity	Change	3.9 US qt (3.7 L)

Manual Transmission Fluid *

Specified	Honda Manual Transmission Fluid (MTF)	
Capacity	Change	2.0 US qt (1.9 L)

Engine Oil

Recommended	-Genuine Honda Motor Oil 0W-20 -API Premium-grade 0W-20 detergent oil	
	Change	3.4 US qt (3.2 L)
Capacity	Change including filter	3.7 US qt (3.5 L)

Engine Coolant

Specified	Honda Long Life Antifreeze/Coolant Type2	
Ratio	50/50 with distilled water	
	1.59 US gal (6.03 L) ^{*1}	
Capacity	1.56 US gal (5.90 L) ^{*2}	
	(change including the remaining 0.17 US gal (0.66 L) in the reserve tank)	

*1: Continuously variable transmission models
 *2: Manual transmission models

Tire

	Size	225/50R17 94V ^{*1} 235/40R19 96V ^{*2}
Regular	Pressure	
	psi (kPa (kgf/cm ²))	
	Front	32 (220 [2.2]) ^{*1} 33 (225 [2.25]) ^{*2}
	Rear	32 (220 [2.2]) ^{*1} 33 (225 [2.25]) ^{*2}
Compact Spare	Size	T135/90D16 102M ^{*1} T135/80D17 103M ^{*2}
	Pressure	
	psi (kPa (kgf/cm ²))	60 (420 [4.2])
Wheel Size	Regular	17 x 7 1/2 ^{*1} 19 x 8 1/2 ^{*2}
		16 x 4 ^{*1}
	Compact Spare	17 x 4 ^{*2}

*1: U.S. LX, EX, EX-L, EX-LN models and Canadian LX, SE, EX-L models
 *2: U.S. Sport, Touring models and Canadian Sport, Touring models

* Not available on all models

Light Bulbs

Headlights (Low Beam)	LED	
Headlights (High Beam)	60W (HB3) ^{*1} LED ^{*2}	
Fog Lights*	LED	
Parking/Daytime Running Lights	LED	
Front Turn Signal Lights	LED	
Front Side Marker Lights	LED	
Side Turn Signal Lights (on Door Mirrors)*	LED	
Brake Lights	LED	
Rear Turn Signal Lights	21W (Amber)	
Rear Side Marker Lights	LED	
Taillights	LED	
Back-Up Lights	16W	
High-Mount Brake Light	LED	
Rear License Plate Light	LED	
Interior Lights		
	Map Lights	8W
	Ceiling Light	8W
	Ambient Lights	LED
	Vanity Mirror Lights	1.4W
	Center Pocket Light	LED
	Door Courtesy Lights*	2CP
	Door Inner Handle Lights*	LED
	Trunk Light	5W
	Console Compartment Light* LED	

*1: Models with halogen high beam headlights
 *2: Models with LED high beam headlights

* Not available on all models

CUSTOMER INFORMATION

Learn about information specific to you as a Honda customer and how to get help.

Frequently Asked Questions/Troubleshooting

Below are some frequently asked questions and troubleshooting items that you may have about the vehicle.

Q: How do I set the vehicle clock?

A: For vehicles without navigation, see Setting the Clock. For vehicles with navigation, the time is automatically set using GPS signals.

Q: Why doesn't the vehicle start when I press the ENGINE START/STOP button?

A: The brake pedal must be pressed to start the vehicle.

Q: What is the AUTO setting on my headlight lever?

A: When in the AUTO position, the vehicle's exterior lights will automatically turn on or off depending on the ambient lighting.

Q: Why won't the driver's door unlock when I grab the door handle, even though the smart entry remote*1 is within range?

A: If you pull the handle too quickly, the system may not have time to confirm the door is unlocked. Wait to hear a beep to confirm the door is unlocked. If you are wearing gloves, the system may be slow to respond.

Q: After my battery was disconnected or went dead, the audio system is asking for a code. Where do I find this?

A: In most cases, you do not need to enter a code. Turn on the vehicle, then press and hold the audio power button until the system reactivates.

Q: Is my phone compatible with *Bluetooth*[®] features? How do I pair my phone?

A: U.S. customers can check phone compatibility and get more information by visiting handsfreelink.com. Canada customers can phone (855)-490-7351 for any HandsFreeLink[®] related inquiry. For pairing instructions, see Pairing a Phone .

Q: Every time I press the Talk button, the system gives me voice prompts *1. Can I turn these off?

A: You can press the Talk button a second time to interrupt the guidance. Or, you can turn guidance on or off permanently via System settings. See Voice Portal Commands.

*1 - If equipped

Q: The amber indicator with a tire and an exclamation mark is on. What do I do?

A: Either your tire pressure is low or you recently filled a tire. See Tire Pressure Monitoring System (TPMS).

Contact Us

Honda dealer personnel are trained professionals. They should be able to answer all your questions. If you encounter a problem that your dealership does not solve to your satisfaction, please discuss it with the dealership's Service Manager or General Manager. If you are dissatisfied with the decision made by the dealership's management, contact Honda Automobile Customer Service.

U.S. owners

American Honda Motor Co., Inc. Torrance, CA 90501-2746
 Honda Automobile Customer Service Tel: (800) 999-1009
 Mail Stop 100-5E-8A Fax: (310) 783-3023
 1919 Torrance Blvd. Twitter:@HondaCustSvc

Canadian owners

Honda Canada, Inc. Markham, ON L6C 0H9
 Customer Relations Tel: (888) 946-6329
 180 Honda Blvd. E-mail: honda_cr@ch.honda.com

In Puerto Rico and the U.S. Virgin Islands

Bella International
 P.O. Box 190816
 San Juan, PR 00919-0816
 Tel: (787) 620-7546

When you call or write, please provide the following information:

- Vehicle Identification Number
- Date of purchase
- Odometer reading of your vehicle
- Your name, address, and telephone number
- A detailed description of the problem
- Name of the dealer who sold the vehicle to you

Warranty Coverages

Below is a brief summary of the warranties covering your new vehicle.

New Vehicle Limited Warranty: Covers your new vehicle, except for the emissions control system and accessories, against defects in materials and workmanship.

Emissions Control Systems Defects Warranty and Emissions Performance

Warranty: Covers your vehicle's emissions control systems. Time, mileage, and coverage are conditional.

Seat Belt Limited Warranty: Covers seat belts that fail to function properly.

Rust Perforation Limited Warranty: Covers all exterior body panels that rust through from the inside.

Accessory Limited Warranty: Covers Honda accessories.

Replacement Parts Limited Warranty: Covers all Honda replacement parts against defects in materials and workmanship.

Replacement Battery Limited Warranty: Provides prorated coverage for a replacement battery purchased from a Honda dealer.

Replacement Muffler Lifetime Limited Warranty: Covers a replacement muffler for the duration of the ownership.

Restrictions and exclusions apply to all these warranties. See the Warranty Information booklet or visit www.owners.honda.com (U.S.) or www.myhonda.ca (Canada) for complete descriptions of each warranty, including time, mileage, and other conditional limitations.

Your vehicle's original tires are covered by their manufacturer. Tire warranty information can be found at owners.honda.com (U.S.) or www.myhonda.ca (Canada).

EPA Contact Information

An owner may obtain further information concerning emission warranties or report violations of the term of the emission warranties by contacting:

U.S. Environmental Protection Agency

Office of Transportation and Air Quality

Compliance Division, Light-Duty Vehicles Group

Attn: Warranty Complaints

2000 Traverwood Drive

Ann Arbor, MI 48105

Email: complianceinfo@epa.gov

VOICE COMMAND INDEX

Learn about the available voice commands to help you operate the vehicle. The system recognizes only those commands shown here. Press the TALK button before you say a command.

Voice Portal Commands

When you press the TALK button, the Voice Portal screen appears. Say one of the options, and follow the system prompts.

- Phone
- Audio
- Navigation*²

Phone Commands

The system accepts these commands on most screens.

- Call (name)
- Call (phone number)
- Call (category)

Audio Commands*¹

The system accepts these commands on the dedicated screen for the voice recognition of the audio.

- Tune to <87.7-107.9> FM
- Tune to <530-1710> AM
- SiriusXM*¹ channel (1-999)
- SiriusXM*¹ channel (station name)
- USB play album
- USB play genre
- USB play playlist
- USB play music
- USB play artist
- USB play song

Navigation Commands*²

When you press the Talk button and say "Navigation," you can say one of the options below. Follow the system prompts.

- Show/View map
- Go home
- Find address
- Stop route
- Detour
- Find city
- Recent Places
- Find intersection

*² - Models with navigation only

*¹ - If equipped

INDEX

Airbags.....7, 8, 10, 11, 13	Climate Control System..... 50, 51
Advanced Airbags.....7	Heated Seats.....51
Airbag Care.....13	Heated Steering Wheel..... 51
Airbag System Components..... 11	Heated Windshield.....50
Airbag System Indicators.....10	Clock.....53
Front Airbags.....7	Contact Us..... 163
Side Airbags.....8	Cruise Control..... 110
Side Curtain Airbags.....8	Adaptive Cruise Control (ACC)..... 110
Audio and Connectivity..... 54–74	Customized Features..... 51
Adjusting the Sound.....56	Doors..... 32, 33
Android Auto.....62	Front Door Inner Handle.....32
Apple CarPlay.....61	Lock Tab.....32
Bluetooth Audio.....71	Master Door Lock Switch..... 33
FM/AM Radio.....65	Engine..... 100, 129
iPod.....67	Emergency Engine Stop..... 129
SiriusXM Radio.....66	ENGINE START/STOP Button..... 100
USB Flash Drive.....69	Floor Mats..... 46
USB Port.....54	Frequently Asked Questions/ Troubleshooting..... 162
Bluetooth HandsfreeLink (HFL)..... 77–79, 82, 83	Fuel..... 123
Dialing a Number.....78	Fuel Information.....123
Making a Call.....78	Refueling.....123
Pairing a Phone.....77	Fuses.....136
SMS Text Messaging and E-Mail... 83	Changing.....136
Using Speed Dial.....82	Location.....136
Using the Phonebook.....79	Gear Selection.....100
Braking..... 104, 107, 117	Shifting.....100
Anti-Lock Brake System (ABS).... 107	Head-Up Display..... 28
Brake Assist System..... 107	Headlights..... 37, 40
CMBS.....117	Headlight-Wiper Integration.....40
Foot Brake.....104	HFL..... 75–85
Parking Brake.....104	HomeLink Universal Transceiver..... 49
Brightness Control..... 36	HondaLink.....58
Carbon Monoxide Gas..... 4	HondaLink Assist.....58
Child Safety..... 13, 16, 19, 20, 33	Immobilizer.....25
Child Seat with lap/shoulder belt... 19	Instrument Panel Indicators..... 24–29
Child seat with Tether.....20	Jump Starting..... 127
Childproof Door Locks.....33	Lane Keeping Assist System (LKAS)..... 113
LATCH-Compatible Child Seat.....16	LaneWatch..... 119
Selecting a Child Seat.....16	

Lights..... 35, 36	Head Restraints..... 44
Interior Lights..... 35, 36	Rear Seats..... 45
Maintenance..... 138–157	Smart Entry System..... 30, 126
Battery..... 148	Specifications..... 158–161
Brake Fluid..... 149	Light Bulbs..... 158–161
Engine Oil..... 145	Steering Wheel Adjusting.....47
Maintenance Minder..... 139	Tires..... 130, 131, 134, 151–155
Opening the Hood..... 143	Flat Tire..... 131
Under the Hood..... 143	Replacing Flat Tire..... 134
Window Washer Fluid..... 149	Tire and Loading Information Label..... 152
Wiper Blades..... 150	Tire and Wheel Replacement..... 153
Mirrors..... 47, 48	Tire Chains..... 153
Door Mirrors..... 48	Tire Identification Number (TIN)... 154
Rearview Mirror.....47	Tire Information.....151
Reverse Tilt Down Mirrors..... 48	Tire Labeling.....154
Moonroof.....35	Tire Pressure Monitoring System (TPMS)..... 130
Multi-View Rear Camera..... 122	Tire Quality Grading.....155
Navigation..... 86–89	Tire Service Life.....153
Home Address.....87	Tire Terminology.....155
Map Legend.....88	Wear Indicators.....152
Routing.....88	Winter Tires.....153
Steering Wheel Controls.....86	Towing..... 93, 94, 130
Street Address.....88	Emergency Towing.....130
Overheating.....128	Load Limits.....94
Parking Sensor System.....120	Trailer Weight.....94
Power Outlets 12-Volt.....55	Towing a Trailer.....93
Readiness Codes.....156	Turn Signals.....37
Remote Engine Start.....95	Vehicle Stability Assist System (VSA)..... 108
Road Departure Mitigation (RDM).. 115	Voice Command Index.....165
Safety..... 3–23	Walk Away Auto Lock..... 31
Reporting Safety Defects.....22	Warranty.....163
Safety Label Locations.....22	Warranty Coverages.....163
Seat Belts..... 4–7	Window.....34
Fastening a Seat Belt.....6	Power Windows.....34
Inspection.....5	Wipers.....39, 40
Lap/Shoulder Belts.....4	Automatic Intermittent Wipers.....40
Proper Use.....5	Intermittent Wipers.....40
Shoulder Anchor.....7	
Seating..... 41, 43–45	
Driver Seat.....41	
Driving Position Memory System...43	

DISCLOSURES

California Proposition 65 Warning

⚠️WARNING: Operating, servicing and maintaining a passenger vehicle or off-highway motor vehicle can expose you to chemicals including engine exhaust, carbon monoxide, phthalates, and lead, which are known to the State of California to cause cancer and birth defects or other reproductive harm. To minimize exposure, avoid breathing exhaust, do not idle the engine except as necessary, service your vehicle in a well-ventilated area and wear gloves or wash your hands frequently when servicing your vehicle. For more information go to www.p65Warnings.ca.gov/passenger-vehicle.

California Perchlorate Contamination Prevention Act

The airbags, seat belt tensioners, and CR-type batteries in this vehicle may contain perchlorate materials-special handling may apply. See www.dtsc.ca.gov/hazardouswaste/perchlorate/ for more information.

End User License Agreement

Your vehicle comes equipped with software, which is governed by the End User License Agreement in this vehicle's Owner's Manual, and which contains a binding arbitration clause. Please refer to the End User License Agreement for the terms and conditions governing your use of the installed software, as well as the applications, services, functions, and content provided through the software. Your use of the installed software will serve as your consent to the terms and conditions of the End User License Agreement.

You may opt out of the arbitration provisions within 30 days of your initial use of the Software by sending a signed, written notice to HONDA at American Honda Motor Co., Inc. Honda Automobile Customer Services Mail Stop 100-5E-8A , 1919 Torrance Blvd. Torrance, CA 90501-2746.